

**P7H55-M LE**  
**P7H55-M LX**  
**P7H55-M LX2**



# Motherboard

E5956

First Edition V1

July 2010

**Copyright © 2010 ASUSTeK Computer Inc. All Rights Reserved.**

No part of this manual, including the products and software described in it, may be reproduced, transmitted, transcribed, stored in a retrieval system, or translated into any language in any form or by any means, except documentation kept by the purchaser for backup purposes, without the express written permission of ASUSTeK Computer Inc. ("ASUS").

Product warranty or service will not be extended if: (1) the product is repaired, modified or altered, unless such repair, modification or alteration is authorized in writing by ASUS; or (2) the serial number of the product is defaced or missing.

ASUS PROVIDES THIS MANUAL "AS IS" WITHOUT WARRANTY OF ANY KIND, EITHER EXPRESS OR IMPLIED, INCLUDING BUT NOT LIMITED TO THE IMPLIED WARRANTIES OR CONDITIONS OF MERCHANTABILITY OR FITNESS FOR A PARTICULAR PURPOSE. IN NO EVENT SHALL ASUS, ITS DIRECTORS, OFFICERS, EMPLOYEES OR AGENTS BE LIABLE FOR ANY INDIRECT, SPECIAL, INCIDENTAL, OR CONSEQUENTIAL DAMAGES (INCLUDING DAMAGES FOR LOSS OF PROFITS, LOSS OF BUSINESS, LOSS OF USE OR DATA, INTERRUPTION OF BUSINESS AND THE LIKE), EVEN IF ASUS HAS BEEN ADVISED OF THE POSSIBILITY OF SUCH DAMAGES ARISING FROM ANY DEFECT OR ERROR IN THIS MANUAL OR PRODUCT.

SPECIFICATIONS AND INFORMATION CONTAINED IN THIS MANUAL ARE FURNISHED FOR INFORMATIONAL USE ONLY, AND ARE SUBJECT TO CHANGE AT ANY TIME WITHOUT NOTICE, AND SHOULD NOT BE CONSTRUED AS A COMMITMENT BY ASUS. ASUS ASSUMES NO RESPONSIBILITY OR LIABILITY FOR ANY ERRORS OR INACCURACIES THAT MAY APPEAR IN THIS MANUAL, INCLUDING THE PRODUCTS AND SOFTWARE DESCRIBED IN IT.

Products and corporate names appearing in this manual may or may not be registered trademarks or copyrights of their respective companies, and are used only for identification or explanation and to the owners' benefit, without intent to infringe.

**Offer to Provide Source Code of Certain Software**

This product may contain copyrighted software that is licensed under the General Public License ("GPL") and under the Lesser General Public License Version ("LGPL"). The GPL and LGPL licensed code in this product is distributed without any warranty. Copies of these licenses are included in this product.

You may obtain the complete corresponding source code (as defined in the GPL) for the GPL Software, and/or the complete corresponding source code of the LGPL Software (with the complete machine-readable "work that uses the Library") for a period of three years after our last shipment of the product including the GPL Software and/or LGPL Software, which will be no earlier than December 1, 2011, either

(1) for free by downloading it from <http://support.asus.com/download>;

or

(2) for the cost of reproduction and shipment, which is dependent on the preferred carrier and the location where you want to have it shipped to, by sending a request to:

ASUSTeK Computer Inc.  
Legal Compliance Dept.  
15 Li Te Rd.,  
Beitou, Taipei 112  
Taiwan

In your request please provide the name, model number and version, as stated in the About Box of the product for which you wish to obtain the corresponding source code and your contact details so that we can coordinate the terms and cost of shipment with you.

The source code will be distributed WITHOUT ANY WARRANTY and licensed under the same license as the corresponding binary/object code.

This offer is valid to anyone in receipt of this information.

ASUSTeK is eager to duly provide complete source code as required under various Free Open Source Software licenses. If however you encounter any problems in obtaining the full corresponding source code we would be much obliged if you give us a notification to the email address [gpl@asus.com](mailto:gpl@asus.com), stating the product and describing the problem (please do NOT send large attachments such as source code archives etc to this email address).

# Contents

Notices.....	v
Safety information .....	vi
About this guide .....	vi
P7H55-M LE Series specifications summary .....	viii

## Chapter 1: Product introduction

<b>1.1</b>	<b>Before you proceed .....</b>	<b>1-1</b>
<b>1.2</b>	<b>Motherboard overview .....</b>	<b>1-2</b>
	1.2.1 Motherboard layout .....	1-2
	1.2.2 Layout contents.....	1-2
<b>1.3</b>	<b>Central Processing Unit (CPU) .....</b>	<b>1-3</b>
<b>1.4</b>	<b>System memory .....</b>	<b>1-3</b>
	1.4.1 Overview .....	1-3
	1.4.2 Memory configurations.....	1-4
<b>1.5</b>	<b>Expansion slots.....</b>	<b>1-7</b>
	1.5.1 Installing an expansion card .....	1-7
	1.5.2 Configuring an expansion card .....	1-7
	1.5.3 PCI slots.....	1-7
	1.5.4 PCI Express x4 slot.....	1-7
	1.5.5 PCI Express x16 slot.....	1-7
<b>1.6</b>	<b>Jumpers .....</b>	<b>1-8</b>
<b>1.7</b>	<b>Connectors .....</b>	<b>1-9</b>
	1.7.1 Rear panel ports .....	1-9
	1.7.2 Internal connectors .....	1-10
<b>1.8</b>	<b>Software support.....</b>	<b>1-17</b>
	1.8.1 Installing an operating system .....	1-17
	1.8.2 Support DVD information .....	1-17

## Chapter 2: BIOS information

<b>2.1</b>	<b>Managing and updating your BIOS .....</b>	<b>2-1</b>
	2.1.1 ASUS Update.....	2-1
	2.1.2 ASUS EZ Flash 2.....	2-2
	2.1.3 ASUS BIOS Updater.....	2-3
	2.1.4 ASUS CrashFree BIOS 3.....	2-6

# Contents

- 2.2 BIOS setup program ..... 2-7**
- 2.3 Main menu ..... 2-8**
  - 2.3.1 System Time [xx:xx:xx] ..... 2-8
  - 2.3.2 System Date [Day xx/xx/xxxx]..... 2-8
  - 2.3.3 Legacy Diskette A [1.44M, 3.5 in.]..... 2-8
  - 2.3.4 Language [English] ..... 2-8
  - 2.3.5 SATA 1-6.....2-8
  - 2.3.6 Storage Configuration ..... 2-9
  - 2.3.7 System Information ..... 2-10
- 2.4 Advanced menu ..... 2-10**
  - 2.4.1 CPU Configuration ..... 2-10
  - 2.4.2 Chipset..... 2-12
  - 2.4.3 Onboard Devices Configuration..... 2-12
  - 2.4.4 USB Configuration ..... 2-14
  - 2.4.5 PCI PnP ..... 2-14
  - 2.4.6 Intel VT-d Configuration ..... 2-15
- 2.5 Power menu..... 2-15**
  - 2.5.1 Suspend Mode [Auto] ..... 2-15
  - 2.5.2 ACPI 2.0 Support [Enabled]..... 2-15
  - 2.5.3 ACPI APIC Support [Enabled]..... 2-15
  - 2.5.4 Anti Surge Support [Disabled]..... 2-15
  - 2.5.5 APM Configuration..... 2-16
  - 2.5.6 Hardware Monitor ..... 2-16
- 2.6 Boot menu ..... 2-17**
  - 2.6.1 Boot Device Priority ..... 2-17
  - 2.6.2 Boot Settings Configuration ..... 2-17
  - 2.6.3 Security ..... 2-18
- 2.7 Tools menu ..... 2-19**
- 2.8 Exit menu ..... 2-20**
- P7P55/P7H57/P7H55 series motherboards installation notices..... 2-21**
  - Intel® LGA1156 processor and chipset combination instruction.. 2-21
  - Memory configuration..... 2-21
  - Configurations for the PCI Express x16 slots..... 2-21

# Notices

## Federal Communications Commission Statement

This device complies with Part 15 of the FCC Rules. Operation is subject to the following two conditions:

- This device may not cause harmful interference, and
- This device must accept any interference received including interference that may cause undesired operation.

This equipment has been tested and found to comply with the limits for a Class B digital device, pursuant to Part 15 of the FCC Rules. These limits are designed to provide reasonable protection against harmful interference in a residential installation. This equipment generates, uses and can radiate radio frequency energy and, if not installed and used in accordance with manufacturer's instructions, may cause harmful interference to radio communications. However, there is no guarantee that interference will not occur in a particular installation. If this equipment does cause harmful interference to radio or television reception, which can be determined by turning the equipment off and on, the user is encouraged to try to correct the interference by one or more of the following measures:

- Reorient or relocate the receiving antenna.
- Increase the separation between the equipment and receiver.
- Connect the equipment to an outlet on a circuit different from that to which the receiver is connected.
- Consult the dealer or an experienced radio/TV technician for help.



---

The use of shielded cables for connection of the monitor to the graphics card is required to assure compliance with FCC regulations. Changes or modifications to this unit not expressly approved by the party responsible for compliance could void the user's authority to operate this equipment.

---

## Canadian Department of Communications Statement

This digital apparatus does not exceed the Class B limits for radio noise emissions from digital apparatus set out in the Radio Interference Regulations of the Canadian Department of Communications.

This class B digital apparatus complies with Canadian ICES-003.

## REACH

Complying with the REACH (Registration, Evaluation, Authorisation, and Restriction of Chemicals) regulatory framework, we published the chemical substances in our products at ASUS REACH website at <http://csr.asus.com/english/REACH.htm>.



---

**DO NOT** throw the motherboard in municipal waste. This product has been designed to enable proper reuse of parts and recycling. This symbol of the crossed out wheeled bin indicates that the product (electrical and electronic equipment) should not be placed in municipal waste. Check local regulations for disposal of electronic products.

---



---

**DO NOT** throw the mercury-containing button cell battery in municipal waste. This symbol of the crossed out wheeled bin indicates that the battery should not be placed in municipal waste.

---

# Safety information

## Electrical safety

- To prevent electric shock hazard, disconnect the power cable from the electric outlet before relocating the system.
- When adding or removing devices to or from the system, ensure that the power cables for the devices are unplugged before the signal cables are connected. If possible, disconnect all power cables from the existing system before you add a device.
- Before connecting or removing signal cables from the motherboard, ensure that all power cables are unplugged.
- Seek professional assistance before using an adapter or extension cord. These devices could interrupt the grounding circuit.
- Ensure that your power supply is set to the correct voltage in your area. If you are not sure about the voltage of the electrical outlet you are using, contact your local power company.
- If the power supply is broken, do not try to fix it by yourself. Contact a qualified service technician or your retailer.

## Operation safety

- Before installing the motherboard and adding devices on it, carefully read all the manuals that came with the package.
- Before using the product, ensure that all cables are correctly connected and the power cables are not damaged. If you detect any damage, contact your dealer immediately.
- To avoid short circuits, keep paper clips, screws, and staples away from connectors, slots, sockets and circuitry.
- Avoid dust, humidity, and temperature extremes. Do not place the product in any area where it may become wet.
- Place the product on a stable surface.
- If you encounter technical problems with the product, contact a qualified service technician or your retailer.

## About this guide

This user guide contains the information you need when installing and configuring the motherboard.

### How this guide is organized

This guide contains the following parts:

- **Chapter 1: Product introduction**  
This chapter describes the features of the motherboard and the new technology it supports.
- **Chapter 2: BIOS information**  
This chapter tells how to change system settings through the BIOS Setup menus. Detailed descriptions of the BIOS parameters are also provided.

## Conventions used in this guide

To ensure that you perform certain tasks properly, take note of the following symbols used throughout this manual.



**DANGER/WARNING:** Information to prevent injury to yourself when trying to complete a task.



**CAUTION:** Information to prevent damage to the components when trying to complete a task.



**IMPORTANT:** Instructions that you **MUST** follow to complete a task.



**NOTE:** Tips and additional information to help you complete a task.

## Where to find more information

Refer to the following sources for additional information and for product and software updates.

### 1. ASUS websites

The ASUS website provides updated information on ASUS hardware and software products. Refer to the ASUS contact information.

### 2. Optional documentation

Your product package may include optional documentation, such as warranty flyers, that may have been added by your dealer. These documents are not part of the standard package.

## Typography

### **Bold text**

Indicates a menu or an item to select.

### *Italics*

Used to emphasize a word or a phrase.

### <Key>

Keys enclosed in the less-than and greater-than sign means that you must press the enclosed key.

Example: <Enter> means that you must press the Enter or Return key.

### <Key1>+<Key2>+<Key3>

If you must press two or more keys simultaneously, the key names are linked with a plus sign (+).

Example: <Ctrl>+<Alt>+<D>

## P7H55-M LE Series specifications summary

<b>CPU</b>	LGA1156 socket for Intel® Core™ i7/ Core™ i5/ Core™ i3/ Pentium® processors Supports Intel® next generation 32nm multi-core CPU * Refer to <a href="http://www.asus.com">www.asus.com</a> for Intel® CPU support list.
<b>Chipset</b>	Intel® H55 Express Chipset
<b>Memory</b>	Dual-channel memory architecture 2 x DIMM, max. 8GB, DDR3 1333/1066 MHz, non-ECC, un-buffered memory  * When you install a total memory of 4GB capacity or more, Windows® 32-bit operating system may only recognize less than 3GB. We recommend a maximum of 3GB system memory if you are using a Windows® 32-bit operating system.
<b>Expansion slots</b>	1 x PCIe 2.0 x16 slot 1 x PCIe 2.0 x4 slot 2 x PCI slots
<b>VGA output</b>	<b>P7H55-M LE:</b> Multi-VGA output support: HDMI, DVI-D, and RGB ports <ul style="list-style-type: none"> <li>- HDMI with Max. resolution: 1920 x 1200 @60Hz</li> <li>- DVI-D with Max. resolution: 1920 x 1200 @60Hz</li> <li>- D-Sub with Max. resolution: 2048 x 1536 @75Hz</li> </ul> <b>P7H55-M LX:</b> Multi-VGA output support: DVI-D, and RGB ports <ul style="list-style-type: none"> <li>- DVI-D with Max. resolution: 1920 x 1200 @60Hz</li> <li>- D-Sub with Max. resolution: 2048 x 1536 @75Hz</li> </ul> <b>P7H55-M LX2:</b> Multi-VGA output support: RGB port <ul style="list-style-type: none"> <li>- D-Sub with Max. resolution: 2048 x 1536 @75Hz</li> </ul> Supports Microsoft® DirectX 10
<b>Storage</b>	Intel® H55 Express Chipset: <ul style="list-style-type: none"> <li>- 6 x Serial ATA 3.0 Gb/s connectors</li> <li>- 1 x Ultra DMA 100/66 connector (for P7H55-M LE only)</li> <li>- 1 x Floppy connector (for P7H55-M LE only)</li> </ul>
<b>LAN</b>	Realtek® 8112L PCIe Gigabit LAN controller
<b>Audio</b>	VIA® VT1708S 8-channel High Definition Audio CODEC <ul style="list-style-type: none"> <li>- Supports Multi-streaming</li> </ul>
<b>USB</b>	12 x USB 2.0/1.1 ports (6 ports at the mid-board, 6 ports at the back panel)
<b>ASUS unique features</b>	ASUS CrashFree BIOS 3 Anti-Surge protection ASUS EZ Flash 2 ASUS Q-Fan 2 ASUS AI NET 2 ASUS MyLogo 2

(continued on the next page)



## P7H55-M LE Series specifications summary

<b>Rear panel ports</b>	<ul style="list-style-type: none"> <li>1 x PS/2 Mouse port</li> <li>1 x PS/2 Keyboard port</li> <li>1 x COM port (for P7H55-M LE only)</li> <li>1 x D-Sub port</li> <li>1 x DVI-D port (for P7H55-M LE and P7H55-M LX only)</li> <li>1 x HDMI port (for P7H55-M LE only)</li> <li>1 x LAN (RJ-45) port</li> <li>6 x USB 2.0/1.1 ports</li> <li>3 x audio jacks</li> </ul>
<b>Internal connectors</b>	<ul style="list-style-type: none"> <li>3 x USB 2.0/1.1 connectors support additional 6 USB 2.0/1.1 ports</li> <li>6 x SATA connectors</li> <li>1 x 24-pin EATX power connector</li> <li>1 x 4-pin ATX 12V power connector</li> <li>1 x CPU fan connector</li> <li>1 x Chassis fan connector</li> <li>1 x Front panel audio connector</li> <li>1 x System panel connector</li> <li>1 x S/PDIF Out connector (for P7H55-M LE and P7H55-M LX only)</li> <li>1 x COM connector (for P7H55-M LE and P7H55-M LX only)</li> <li>1 x IDE connector (for P7H55-M LE only)</li> <li>1 x Floppy disk drive connector (for P7H55-M LE only)</li> <li>1 x LPT connector (for P7H55-M LE only)</li> </ul>
<b>BIOS features</b>	64 Mb Flash ROM, AMI BIOS, PnP, DMI v2.0, WfM 2.0, ACPI v2.0a, SM BIOS v2.5
<b>Manageability</b>	WOL, PXE, PME Wake up, WOR by Ring
<b>Accessories</b>	<ul style="list-style-type: none"> <li>2 x Serial ATA cables</li> <li>1 x I/O shield</li> <li>1 x IDE cable (for P7H55-M LE only)</li> <li>1 x User Manual</li> <li>1 x Support DVD</li> </ul>
<b>Support DVD</b>	<ul style="list-style-type: none"> <li>Drivers</li> <li>ASUS PC Probe II</li> <li>ASUS Update</li> <li>Anti-virus software (OEM version)</li> </ul>
<b>Form factor</b>	uATX form factor: 9.6 in x 8.6 in (24.4 cm x 22.9 cm)

\* Specifications are subject to change without notice.

# Chapter 1

## Product introduction

Thank you for buying an ASUS® P7H55-M LE Series motherboard!

Before you start installing the motherboard, and hardware devices on it, check the items in your motherboard package. Refer to page ix for the list of accessories.



---

If any of the items is damaged or missing, contact your retailer.

---

### 1.1 Before you proceed

Take note of the following precautions before you install motherboard components or change any motherboard settings.



- Unplug the power cord from the wall socket before touching any component.
  - Before handling components, use a grounded wrist strap or touch a safely grounded object or a metal object, such as the power supply case, to avoid damaging them due to static electricity
  - Hold components by the edges to avoid touching the ICs on them.
  - Whenever you uninstall any component, place it on a grounded antistatic pad or in the bag that came with the component.
  - Before you install or remove any component, switch off the ATX power supply and detach its power cord. Failure to do so may cause severe damage to the motherboard, peripherals, or components.
- 

### Onboard LED

This motherboard comes with a standby power LED that lights up to indicate that the system is ON, in sleep mode, or in soft-off mode. This is a reminder that you must shut down the system and unplug the power cable before removing or plugging in any motherboard component. The illustration below shows the location of the onboard LED.

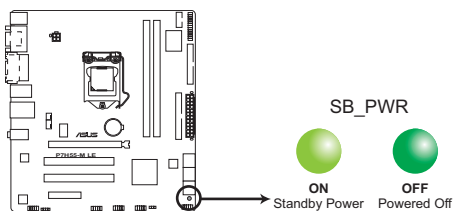

**P7H55-M LE Onboard LED**

# 1.2 Motherboard overview

## 1.2.1 Motherboard layout



The layout varies with models. The layout illustrations in this user guide are for P7H55-M LE only.



Ensure that you install the motherboard into the chassis in the correct orientation. The edge with external ports goes to the rear part of the chassis.

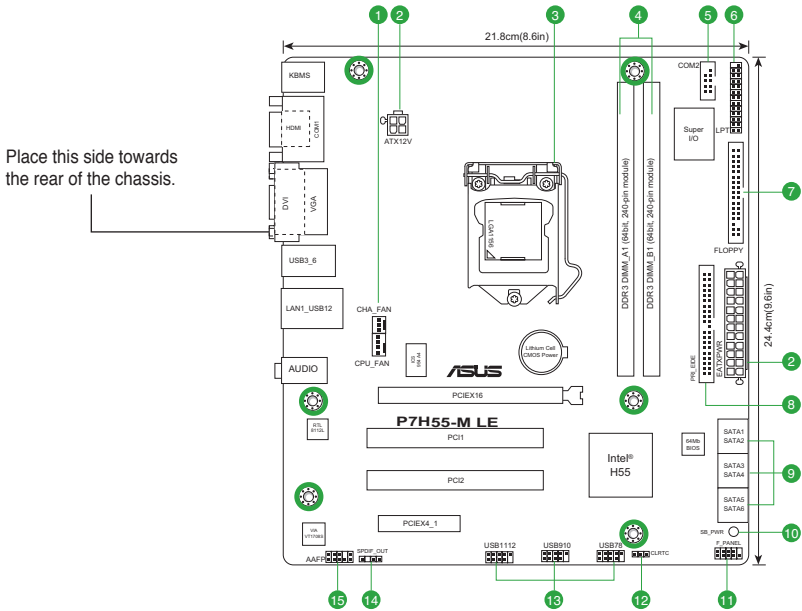

Place six screws into the holes indicated by circles to secure the motherboard to the chassis. DO NOT overtighten the screws! Doing so can damage the motherboard.

## 1.2.2 Layout contents

Connectors/Jumpers/Slots/LED	Page	Connectors/Jumpers/Slots/LED	Page
1. CPU and Chassis fan connectors (4-pin CPU_FAN, 3-pin CHA_FAN)	1-12	9. Serial ATA connectors (7-pin SATA1-6)	1-11
2. ATX power connectors (24-pin EATXPWR, 4-pin ATX12V)	1-13	10. Onboard LED (SB_PWR)	1-1
3. Intel® CPU socket		11. System panel connector (10-1 pin F_PANEL)	1-12
4. DDR3 DIMM sockets	1-3	12. Clear RTC RAM (3-pin CLRTC)	1-8
5. Serial port connectors (10-1 pin COM2)	1-15	13. USB connectors (10-1 pin USB78, USB910, USB1112)	1-10
6. LPT connector (26-1 pin LPT)	1-15	14. Digital audio connector (4-1 pin SPDIF_OUT)	1-11
7. Floppy disk drive connector (34-1 pin FLOPPY)	1-14	15. Front panel audio connector (10-1 pin AAFP)	1-14
8. IDE connector (40-1 pin PRI_EIDE)	1-16		

## 1.3 Central Processing Unit (CPU)

This motherboard comes with a surface mount LGA1156 socket designed for the Intel® Core™ i7 / Core™ i5 / Core™ i3 / Pentium® processors.



---

Ensure that all power cables are unplugged before installing the CPU.

---



- Upon purchase of the motherboard, ensure that the PnP cap is on the socket and the socket contacts are not bent. Contact your retailer immediately if the PnP cap is missing, or if you see any damage to the PnP cap/socket contacts/motherboard components. ASUS will shoulder the cost of repair only if the damage is shipment/transit-related.
  - Keep the cap after installing the motherboard. ASUS will process Return Merchandise Authorization (RMA) requests only if the motherboard comes with the cap on the LGA1156 socket.
  - The product warranty does not cover damage to the socket contacts resulting from incorrect CPU installation/removal, or misplacement/loss/incorrect removal of the PnP cap.
- 

## 1.4 System memory

### 1.4.1 Overview

This motherboard comes with two Double Data Rate 3 (DDR3) Dual Inline Memory Module (DIMM) sockets.

A DDR3 module has the same physical dimensions as a DDR3 DIMM but is notched differently to prevent installation on a DDR3 DIMM socket. DDR3 modules are developed for better performance with less power consumption. The figure illustrates the location of the DDR3 DIMM sockets:

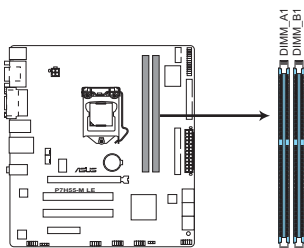

**P7H55-M LE 240-pin DDR3 DIMM sockets**

## 1.4.2 Memory configurations

You may install 512MB, 1GB, 2GB, and 4GB unbuffered non-ECC DDR3 DIMMs into the DIMM sockets.



- You may install varying memory sizes in Channel A and Channel B. The system maps the total size of the lower-sized channel for the dual-channel configuration. Any excess memory from the higher-sized channel is then mapped for single-channel operation.
- Always install DIMMs with the same CAS latency. For optimum compatibility, it is recommended that you obtain memory modules from the same vendor.
- Due to the memory address limitation on the 32-bit Windows® OS, when you install 4GB or more memory on the motherboard, the actual usable memory for the OS can be about 3GB or less. For effective use of memory, we recommend that you do either of the following:
  - Use a maximum of 3GB system memory if you are using a 32-bit Windows® OS.
  - Use a 64-bit Windows® OS if you want to install 4GB or more memory on the motherboard.
- This motherboard does not support DIMMs made up of 256 megabits (Mb) chips or less.

## P7H55-M LE Series Motherboard Qualified Vendors List (QVL)

### DDR3-1333MHz capability

Vendor	Part No.	Size	SS/DS	Chip Brand	Chip No.	Timing DIMM (BIOS)	Voltage	DIMM Support	
								A*	B*
A-Data	AD31333001GOU	1024MB	SS	A-Data	AD30908C8D-151C E0906	-	-	*	
A-Data	AD31333G001GOU	3072MB(Kit of 3)	SS	-	-	8-8-8-24	1.65-1.85V	*	*
A-Data	AD31333G002GMU	2048MB	DS	-	-	8-8-8-24	1.65-1.85V	*	*
Apacer	78.A1GC6.9L1	2048MB	DS	APACER	AM5D5808DEWSBG	-	-	*	*
CORSAIR	CM3X1024-1333C9DHX	1024MB	SS	-	-	9-9-9-24	1.60V	*	*
CORSAIR	CM3X1024-1333C9	1024MB	SS	-	-	9-9-9-24	1.60V	*	
CORSAIR	TR3X3G1333C9 G	3072MB(Kit of 3)	SS	-	-	9-9-9-24	1.50V	*	
CORSAIR	TR3X3G1333C9 G	3072MB(Kit of 3)	SS	-	-	9-9-9-24	1.50V	*	*
CORSAIR	TR3X3G1333C9	3072MB(Kit of 3)	SS	-	-	9	1.5V	*	*
CORSAIR	CM3X1024-1333C9DHX	1024MB	DS	Corsair	-	-	-	*	*
CORSAIR	CM3X2048-1333C9DHX	2048MB	DS	-	-	-	-	*	*
CORSAIR	TW3X4G1333C9 G	4096MB(Kit of 2)	DS	-	-	9-9-9-24	1.50V	*	*
CORSAIR	CMX8GX3M4A1333C9	8192MB(Kit of 4)	DS	-	-	9-9-9-24	1.50V	*	
Crucial	CT12864BA1339.8FF	1024MB	SS	Micron	9FF22D9KPT	9	-	*	*
Crucial	BL12864TA1336.8SFB1	2048MB(Kit of 2)	SS	-	-	6-6-6-20	1.8V	*	*
Crucial	CT25664BA1339.16FF	2048MB	DS	Micron	9KF27D9KPT	9	-	*	*
Crucial	BL25664ABA1336.16SFB1	4096MB(Kit of 2)	DS	-	-	6-6-6-20	1.8V	*	
Crucial	BL25664BA1336.16SFB1	4096MB(Kit of 2)	DS	-	-	6-6-6-20	1.8V	*	
Crucial	BL25664BN1337.16FF (XMP)	6144MB(Kit of 3)	DS	-	-	7-7-7-24	1.65V	*	*
ELPIDA	EBJ10UE8EDF0-DJ-F	1024MB	SS	ELPIDA	J1108EDSE-DJ-F	-	1.35V (low voltage)	*	*
ELPIDA	EBJ21UE8EDF0-DJ-F	2048MB	DS	ELPIDA	J1108EDSE-DJ-F	-	1.35V (low voltage)	*	*
G.SKILL	F3-10666CL7T-3GBPK	3072MB(Kit of 3)	SS	-	-	7-7-7-18	1.5~1.6V	*	*
G.SKILL	F3-10666CL9T-3GBNQ	3072MB(Kit of 3)	SS	-	-	9-9-9-24	1.5~1.6V	*	*

(continued on the next page)

## DDR3-1333MHz capability

Vendor	Part No.	Size	SS/ DS	Chip Brand	Chip No.	Timing DIMM (BIOS)	Voltage	DIMM Support	
								A*	B*
G.SKILL	F3-10600CL9D-2GBNQ	1024MB	DS	G.SKILL	-	-	-	*	*
G.SKILL	F3-10666CL8D-4GBECO(XMP)	4096MB(Kit of 2)	DS	-	-	8-8-8-8-24	1.35V(low voltage)	*	*
G.SKILL	F3-10666CL8D-4GBHK(XMP)	4096MB(Kit of 2)	DS	-	-	8-8-8-21	1.5-1.6V	*	*
G.SKILL	F3-10666CL7T-6GBPK(XMP)	6144MB(Kit of 3)	DS	-	-	7-7-7-18	1.5~1.6V	*	*
G.SKILL	F3-10666CL9T-6GBNQ	6144MB(Kit of 3)	DS	-	-	9-9-9-24	1.5V~1.6V	*	*
GEIL	GV32GB1333C9DC	1024MB	SS	-	-	9	-	*	*
GEIL	GV34GB1333C7DC	2048MB	DS	-	-	7-7-7-24	1.5V	*	*
GEIL	GG34GB1333C9DC	4096MB(Kit of 2)	DS	GEIL	GL1L128M88BA12N	9-9-9-24	1.3V(low voltage)	*	*
GEIL	GV32GB1333C9SC	6144MB(Kit of 3)	DS	-	-	9	1.5V	*	*
Kingmax	FLFD45F-B8MF9	1024MB	SS	Micron	8HD22D9JNM	-	-	*	*
Kingmax	FLFD45F-B8MH9 MAES	1024MB	SS	Micron	9CF22D9KPT	-	-	*	*
Kingmax	FLFE85F-B8MF9	2048MB	DS	Micron	8HD22D9JNM	-	-	*	*
Kingmax	FLFE85F-B8MH9 MEES	2048MB	DS	Micron	9GF27D9KPT	-	-	*	*
KINGSTON	KVR1333D3N9/1G	1024MB	SS	KTC	D1288JELDPGD9U	-	-	*	*
KINGSTON	KVR1333D3N9/2G	2048MB	DS	Qimonda	IDSH1G-03A1F1C-13H	-	1.5V	*	*
KINGSTON	KVR1333D3N9/4G	4096MB	DS	Hynix	H5TQ2G83AFR	-	-	*	*
Micron	MT8JTF12864AZ-1G4F1	1024MB	SS	Micron	9FF22D9KPT	9	-	*	*
Micron	MT16JTF25664AZ-1G4F1	2048MB	DS	Micron	9KF27D9KPT	9	-	*	*
OCZ	OCZ3P13332GK	2048MB(Kit of 2)	SS	-	-	7-7-7-20	1.8V	*	*
OCZ	OCZ3X1333LV3GK(XMP)	3072MB(Kit of 3)	SS	-	-	-	1.6V	*	*
OCZ	OCZ3G13334GK	4096MB(Kit of 2)	DS	-	-	-	1.7V	*	*
OCZ	OCZ3P13334GK	4096MB(Kit of 2)	DS	-	-	7-7-7-20	1.8V	*	*
OCZ	OCZ3P1333LV4GK	4096MB(Kit of 2)	DS	-	-	7-7-7-20	1.65V	*	*
OCZ	OCZ3P1333LV4GK	4096MB(Kit of 2)	DS	-	-	7-7-7-20	1.65V	*	*
OCZ	OCZ3X13334GK(XMP)	4096MB(Kit of 2)	DS	-	-	7-7-7-20	1.75V	*	*
OCZ	OCZ3G1333LV6GK	6144MB(Kit of 3)	DS	-	-	9-9-9-20	1.65V	*	*
OCZ	OCZ3P1333LV6GK	6144MB(Kit of 3)	DS	-	-	7-7-7-20	1.65V	*	*
OCZ	OCZ3X1333LV6GK(XMP)	6144MB(Kit of 3)	DS	-	-	8-8-8-20	1.60V	*	*
PSC	AL7F8G73D-DG1	1024MB	SS	PSC	A3P1GF3DGF928M9B05	8-8-8-24	1.5V	*	*
PSC	AL8F8G73D-DG1	2048MB	DS	PSC	A3P1GF3DGF928M9B05	8-8-8-24	1.5V	*	*
SAMSUNG	M378B2873DZ1-CH9	1024MB	SS	Samsung	K4B1G0846D-HCH9	-	-	*	*
SAMSUNG	M378B2873DZ1-CH9	1024MB	SS	Samsung	SEC 846 HCH9 K4B1G08460	-	-	*	*
SAMSUNG	M378B2873EH1-CH9	1024MB	SS	Samsung	SEC 913 HCH9 K4B1G0846E	-	-	*	*
SAMSUNG	M378B5673DZ1-CH9	2048MB	DS	Samsung	K4B1G0846D-HCH9	-	-	*	*
SAMSUNG	M378B5673EH1-CH9	2048MB	DS	Samsung	SEC 913 HCH9 K4B1G0846E	-	-	*	*
Transcend	TS256MLK64V3U	2048MB	DS	Micron	9GF27D9KPT	-	-	*	*

## DDR3-1066MHz capability

Vendor	Part No.	Size	SS/ DS	Chip Brand	Chip No.	Timing DIMM (BIOS)	Voltage	DIMM Support	
								A*	C*
Crucial	CT12864BA1067.8FF	1024MB	SS	Micron	9GF22D9KPT	7	-	•	•
Crucial	CT25664BA1067.16FF	2048MB	DS	Micron	9HF22D9KPT	7	-	•	•
ELPIDA	EBJ10UE8EDF0-AE-F	1024MB	SS	ELPIDA	J1108EDSE-DJ-F	-	1.35V(low voltage)	•	•
ELPIDA	EBJ51UD8BAFA-AC-E	512MB	SS	Elpida	J5308BASE-AC-E	-	-	•	•
ELPIDA	EBJ51UD8BAFA-AE-E	512MB	SS	Elpida	J5308BASE-AC-E	-	-	•	•
ELPIDA	EBJ11UD8BAFA-AE-E	1024MB	DS	Elpida	J5308BASE-AC-E	-	-	•	•
ELPIDA	EBJ21UE8EDF0-AE-F	2048MB	DS	ELPIDA	J1108EDSE-DJ-F	-	1.35V(low voltage)	•	•
KINGSTON	KVR1066D3N7/1G	1024MB	SS	Kingston	D1288JEKAPGA7U	7	1.5V	•	•
KINGSTON	KVR1066D3N7/2G	2048MB	DS	Kingston	D1288JEKAPGA7U	7	1.5V	•	•
KINGSTON	KVR1066D3N7/4G	4096MB	DS	Hynix	H5TQ2G83AFR	7	1.5V	•	•
Micron	MT8JTF12864AZ-1G1F1	1024MB	SS	Micron	9GF22D9KPT	7	-	•	•
Micron	MT16JTF25664AZ-1G1F1	2048MB	DS	Micron	9HF22D9KPT	7	-	•	•
SAMSUNG	M378B2873EH1-CF8	1024MB	SS	Samsung	SEC 901 HCF8 K4B1G0846E	-	-	•	•
SAMSUNG	M378B5273BH1-CF8	4096MB	DS	Samsung	846 K4B2G0846B-HCF8	-	-	•	•
Elixir	M2Y2G64CB8HC5N-BE	2048MB	DS	Elixir	N2CB1G80CN-BE	-	-	•	•
Elixir	M2Y2G64CBHA9N-BE	2048MB	DS	-	-	7-7-20	-	•	•
Elixir	M2Y2G64CBHC9N-BE	2048MB	DS	Elixir	-	-	-	•	•
Kingtiger	2GB DIMM PC3-8500	2048MB	DS	Hynix	H5TQ1G83AFP G7C	-	-	•	•



### SS - Single-sided / DS - Double - sided

#### DIMM support:

- **A\***: Supports one module inserted into any slot as Single-channel memory configuration.
- **B\***: Supports one pair of modules inserted into both the slots as one pair of Dual-channel memory configuration.



Visit the ASUS website at [www.asus.com](http://www.asus.com) for the latest QVL.

## 1.5 Expansion slots

In the future, you may need to install expansion cards. The following sub-sections describe the slots and the expansion cards that they support.



---

Unplug the power cord before adding or removing expansion cards. Failure to do so may cause you physical injury and damage motherboard components.

---

### 1.5.1 Installing an expansion card

To install an expansion card:

1. Before installing the expansion card, read the documentation that comes with it and make the necessary hardware settings for the card.
2. Remove the chassis cover (if your motherboard is already installed in a chassis).
3. Remove the bracket opposite the slot that you intend to use.
4. Align the card connector with the slot and press firmly until the card is completely seated on the slot.
5. Secure the card to the chassis with the screw.
6. Replace the chassis cover.

### 1.5.2 Configuring an expansion card

After installing the expansion card, configure it by adjusting the software settings.

1. Turn on the system and change the necessary BIOS settings, if any. See Chapter 2 for information on BIOS setup.
2. Assign an IRQ to the card.
3. Install the software drivers for the expansion card.



---

When using PCI cards on shared slots, ensure that the drivers support “Share IRQ” or that the cards do not need IRQ assignments; otherwise, conflicts will arise between the two PCI groups, making the system unstable and the card inoperable.

---

### 1.5.3 PCI slots

The PCI slots support cards such as LAN cards, SCSI cards, USB cards, and other cards that comply with the PCI specifications.

### 1.5.4 PCI Express x4 slot

This motherboard supports PCI Express x4 network cards, SCSI cards and other cards that comply with the PCI Express specifications.

### 1.5.5 PCI Express x16 slot

This motherboard supports PCI Express x16 graphics cards that comply with the PCI Express specifications.



## 1.6 Jumpers

### Clear RTC RAM (3-pin CLRRTC)

This jumper allows you to clear the Real Time Clock (RTC) RAM in CMOS. You can clear the CMOS memory of date, time, and system setup parameters by erasing the CMOS RTC RAM data. The onboard button cell battery powers the RAM data in CMOS, which include system setup information such as system passwords.

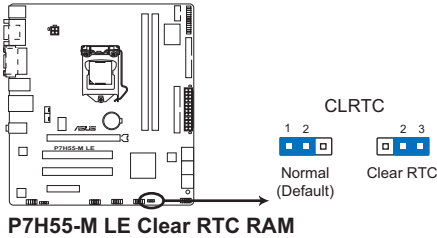

#### To erase the RTC RAM:

1. Turn OFF the computer and unplug the power cord.
2. Move the jumper cap from pins 1-2 (default) to pins 2-3. Keep the cap on pins 2-3 for about 5-10 seconds, then move the cap back to pins 1-2.
3. Plug the power cord and turn ON the computer.
4. Hold down the **<Del>** key during the boot process and enter BIOS setup to reenter data.



---

Except when clearing the RTC RAM, never remove the cap on CLRRTC jumper default position. Removing the cap will cause system boot failure!

---



- If the steps above do not help, remove the onboard battery and move the jumper again to clear the CMOS RTC RAM data. After clearing the CMOS, reinstall the battery.
  - You do not need to clear the RTC when the system hangs due to overclocking. For system failure due to overclocking, use the CPU Parameter Recall (C.P.R.) feature. Shut down and cut off the AC power, then reboot the system, the BIOS automatically resets parameter settings to default values.
-

## 1.7 Connectors

### 1.7.1 Rear panel ports

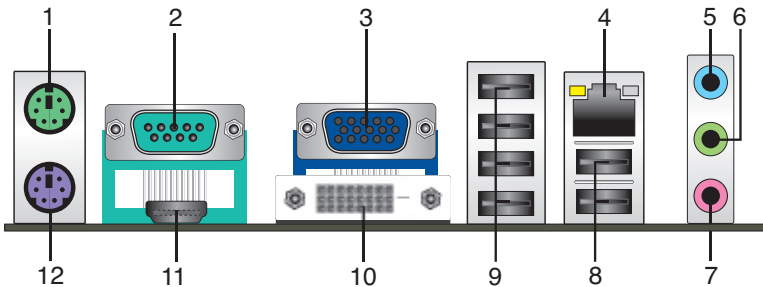

1. **PS/2 Mouse port.** This port is for a PS/2 mouse.
2. **COM port (for P7H55-M LE only).** This 9-pin COM1 port is for serial devices.
3. **Video Graphics Adapter (VGA) port.** This 15-pin port is for a VGA monitor or other VGA-compatible devices.
4. **LAN (RJ-45) port.** This port allows Gigabit connection to a Local Area Network (LAN) through a network hub. Refer to the table on the next page for the LAN port LED indicators.

#### LAN port LED indications

ACT/LINK LED		SPEED LED	
Status	Description	Status	Description
OFF	No link	OFF	10 Mbps connection
ORANGE	Linked	ORANGE	100 Mbps connection
BLINKING	Data activity	GREEN	1 Gbps connection

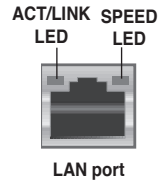

5. **Line In port (light blue).** This port connects the tape, CD, DVD player, or other audio sources.
6. **Line Out port (lime).** This port connects to a headphone or a speaker. In 4-channel, 6-channel, and 8-channel configurations, the function of this port becomes Front Speaker Out.
7. **Microphone port (pink).** This port connects a microphone.



Refer to the audio configuration table below for the function of the audio ports in the 2, 4, 6, or 8-channel configuration.

#### Audio 2, 4, 6, 8-channel configuration

Port	Headset 2-channel	4-channel	6-channel	8-channel
Light Blue (Rear panel)	Line In	Rear Speaker Out	Rear Speaker Out	Rear Speaker Out
Lime (Rear panel)	Line Out	Front Speaker Out	Front Speaker Out	Front Speaker Out
Pink (Rear panel)	Mic In	Mic In	Bass/Center	Bass/Center
Lime (Front panel)	-	-	-	Side Speaker Out



### To configure an 8-channel audio output:

Use a chassis with HD audio module in the front panel to support an 8-channel audio output.

- USB 2.0 ports 1 and 2.** These two 4-pin Universal Serial Bus (USB) ports connect to USB 2.0/1.1 devices.
- USB 2.0 ports 3, 4, 5, and 6.** These four 4-pin Universal Serial Bus (USB) ports connect to USB 2.0/1.1 devices.
- DVI-D port (for P7H55-M LE and P7H55-M LX only).** This port is for any DVI-D compatible device. DVI-D can't be converted to output RGB Signal to CRT and isn't compatible with DVI-I.
- HDMI port (for P7H55-M LE only).** This is a High-Definition Multimedia Interface (HDMI) connector, and is HDCP compliant allowing playback of HD DVD, Blu-Ray, and other protected content.
- PS/2 Keyboard port.** This port is for a PS/2 keyboard.

## 1.7.2 Internal connectors

### 1. USB connectors (10-1 pin USB78, USB910, USB1112)

These connectors are for USB 2.0 ports. Connect the USB module cable to any of these connectors, then install the module to a slot opening at the back of the system chassis. These USB connectors comply with the USB 2.0 specification that supports up to 480Mbps connection speed.

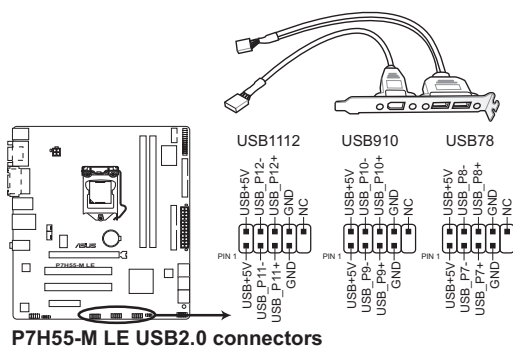

Never connect a 1394 cable to the USB connectors. Doing so will damage the motherboard!



The USB 2.0 module is purchased separately.

## 2. Serial ATA connectors (7-pin SATA1-6)

These connectors are for the Serial ATA signal cables for Serial ATA 3Gb/s hard disk and optical disk drives. The Serial ATA 3Gb/s is backward compatible with Serial ATA 1.5Gb/s specification. The data transfer rate of the Serial ATA 3Gb/s is faster than the standard parallel ATA with 133MB/s (Ultra DMA133).

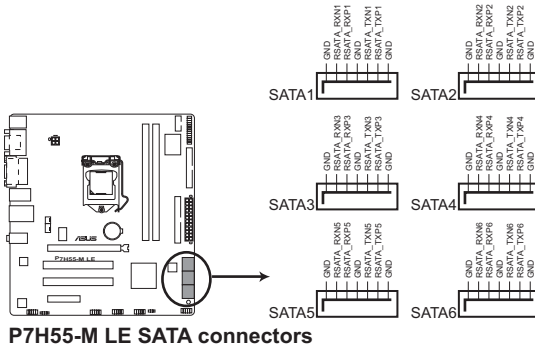

Install the Windows® XP Service Pack 2 or later version before using Serial ATA.

## 3. Digital audio connector (4-1 pin SPDIF\_OUT) (for P7H55-M LE and P7H55-M LX only)

This connector is for an additional Sony/Philips Digital Interface (S/PDIF) port.

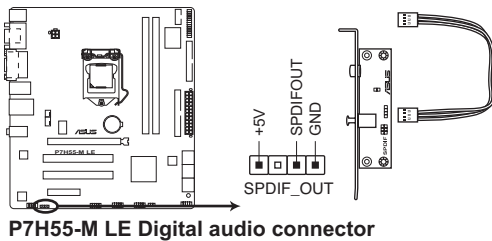

The S/PDIF module is purchased separately.

#### 4. CPU and Chassis fan connectors (4-pin CPU\_FAN, 3-pin CHA\_FAN)

Connect the fan cables to the fan connectors on the motherboard, making sure that the black wire of each cable matches the ground pin of the connector.



DO NOT forget to connect the fan cables to the fan connectors. Insufficient air flow inside the system may damage the motherboard components. They are not jumpers! DO NOT place jumper caps on the fan connectors.

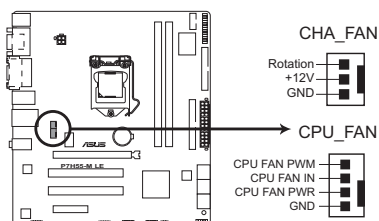

**P7H55-M LE fan connectors**

#### 5. System panel connector (10-1 pin F\_PANEL)

This connector supports several chassis-mounted functions.

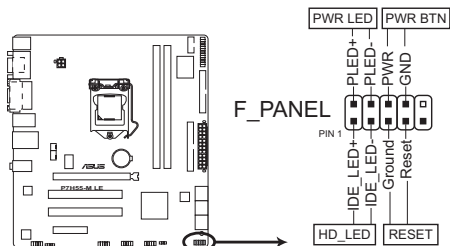

**P7H55-M LE System panel connector**

- **System power LED (2-pin PLED)**

This 2-pin connector is for the system power LED. Connect the chassis power LED cable to this connector. The system power LED lights up when you turn on the system power, and blinks when the system is in sleep mode.

- **Hard disk drive activity LED (2-pin +HDLED)**

This 2-pin connector is for the HDD Activity LED. Connect the HDD Activity LED cable to this connector. The IDE LED lights up or flashes when data is read from or written to the HDD.

- **Power/Soft-off button (2-pin PWRBTN)**

This 2-pin connector is for the system power button.

- **Reset button (2-pin RESET)**

This 2-pin connector is for the chassis-mounted reset button for system reboot without turning off the system power.

## 6. ATX power connectors (24-pin EATXPWR, 4-pin ATX12V)

These connectors are for an ATX power supply. The plugs from the power supply are designed to fit these connectors in only one orientation. Find the proper orientation and push down firmly until the connectors completely fit.

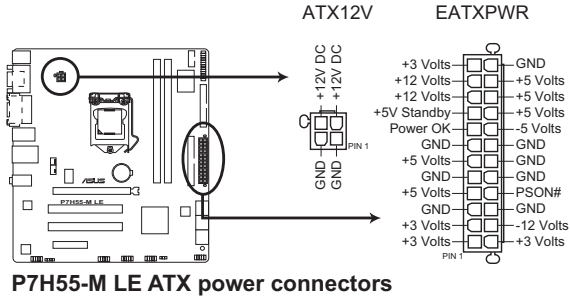

- We recommend that you use an ATX 12V Specification 2.0-compliant power supply unit (PSU) with a minimum of 300W power rating. This PSU type has 24-pin and 4-pin power plugs.
- If you intend to use a PSU with 20-pin and 4-pin power plugs, make sure that the 20-pin power plug can provide at least 15 A on +12 V and that the PSU has a minimum power rating of 300 W. The system may become unstable or may not boot up if the power is inadequate.
- DO NOT forget to connect the 4-pin ATX +12 V power plug; otherwise, the system will not boot up.
- We recommend that you use a PSU with higher power output when configuring a system with more power-consuming devices or when you intend to install additional devices. The system may become unstable or may not boot up if the power is inadequate.
- If you are uncertain about the minimum power supply requirement for your system, refer to the Recommended Power Supply Wattage Calculator at <http://support.asus.com/PowerSupplyCalculator/PSCalculator.aspx?SLanguage=en-us> for details.

### 7. Front panel audio connector (10-1 pin AAFP)

This connector is for a chassis-mounted front panel audio I/O module that supports either High Definition Audio or AC'97 audio standard. Connect one end of the front panel audio I/O module cable to this connector.

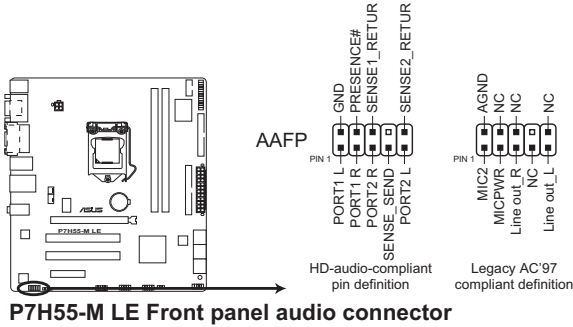

If you want to connect a high-definition front panel audio module to this connector, ensure that the **Front Panel Type** item in the BIOS is set to **[HD Audio]**. If you want to connect an AC97 front panel audio module to this connector, set the item to **[AC97]**. See section 2.4.3 **Onboard Devices Configuration** for details.

### 8. Floppy disk drive connector (34-1 pin FLOPPY) (for P7H55-M LE only)

This connector is for the floppy disk drive (FDD) signal cable. Insert one end of the cable to this connector, then connect the other end to the signal connector at the back of the floppy disk drive.



- Pin 5 on the connector is removed to prevent incorrect cable connection when using a FDD cable with a covered Pin 5.
- The FDD cable is purchased separately.

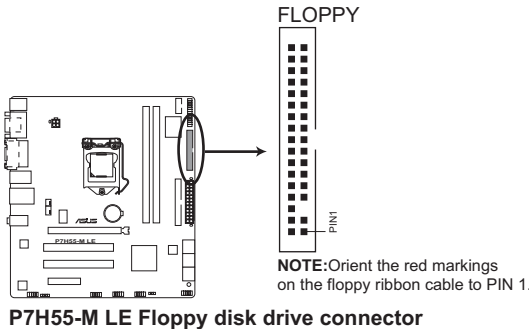

## 9. IDE connector (40-1 pin PRI\_EIDE) (for P7H55-M LE only)

The onboard IDE connector is for Ultra DMA 100/66 signal cable. There are three connectors on each Ultra DMA 100/66 signal cable: blue, black, and gray. Connect the blue connector to the motherboard's IDE connector, then select one of the following modes to configure your devices:

	Drive jumper setting	Mode of device(s)	Cable connector
Single device	Cable-Select or Master	-	Black
Two devices	Cable-Select	Master	Black
		Slave	Gray
	Master	Master	Black or gray
	Slave	Slave	



- Pin 20 on the IDE connector is removed to match the covered hole on the Ultra DMA cable connector. This prevents incorrect insertion when you connect the IDE cable.
- Use the 80-conductor IDE cable for Ultra DMA 100/66 IDE devices.



If any device jumper is set as "Cable-Select", ensure that all other device jumpers have the same setting.

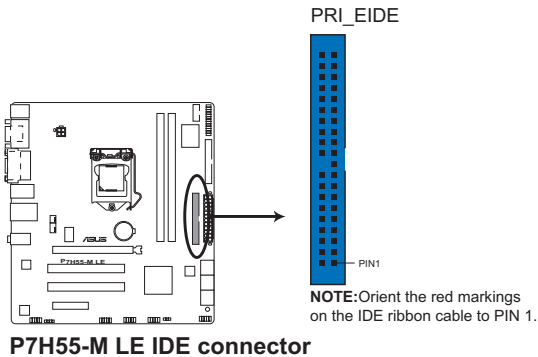



**10. Serial port connectors (10-1 pin COM2) (for P7H55-M LE and P7H55-M LX only)**

The connector is for a serial (COM) port. Connect the serial port module cable to the connector, then install the module to a slot opening at the back of the system chassis.



---

The serial port bracket (COM2) is purchased separately.

---

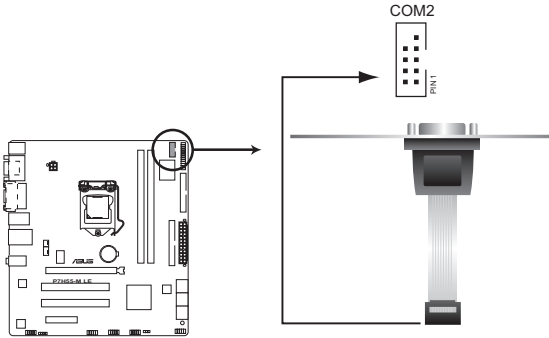

**P7H55-M LE Serial port (COM2) connector**

## 1.8 Software support

### 1.8.1 Installing an operating system

This motherboard supports Windows® XP/Vista/7 Operating Systems (OS). Always install the latest OS version and corresponding updates to maximize the features of your hardware.



- Motherboard settings and hardware options vary. Refer to your OS documentation for detailed information.
- Ensure that you install Windows® XP Service Pack 3 or later versions / Windows® Vista Service Pack 1 or later versions before installing the drivers for better compatibility and system stability.

### 1.8.2 Support DVD information

The Support DVD that comes with the motherboard package contains drivers, software applications, and utilities that you can install to get all motherboard features.

#### To run the Support DVD

Place the Support DVD into the optical drive. The DVD automatically displays the **Drivers** menu if the Autorun function is enabled on your computer.



The contents of the Support DVD are subject to change at any time without notice. Visit the ASUS website at [www.asus.com](http://www.asus.com) for updates.



Click an icon to display Support DVD/motherboard information

Click an item to install



If the Autorun function is NOT enabled on your computer, browse the contents of the Support DVD to locate the file **ASSETUP.EXE** from the **BIN** folder. Double-click **ASSETUP.EXE** to run the DVD.

# Chapter 2

## BIOS information

### 2.1 Managing and updating your BIOS



---

Save a copy of the original motherboard BIOS file to a USB flash disk in case you need to restore the BIOS in the future. Copy the original motherboard BIOS using the ASUS Update utility.

---

#### 2.1.1 ASUS Update

The ASUS Update is a utility that allows you to manage, save, and update the motherboard BIOS in Windows® environment.



- 
- ASUS Update requires an Internet connection either through a network or an Internet Service Provider (ISP).
  - This utility is available in the support DVD that comes with the motherboard package.
- 

#### Installing ASUS Update

To install ASUS Update:

1. Place the support DVD into the optical drive. The **Drivers** menu appears.
2. Click the **Utilities** tab, then click **ASUS Update**.
3. Follow the onscreen instructions to complete the installation.



---

Quit all Windows® applications before you update the BIOS using this utility.

---

#### Updating the BIOS

To update the BIOS:

1. From the Windows® desktop, click **Start > Programs > ASUS > ASUS Update > ASUS Update** to launch the ASUS Update utility.
2. From the dropdown list, select either of the following methods:

##### *Updating from the Internet*

- a. Select **Update BIOS from the Internet**, then click **Next**.
- b. Select the ASUS FTP site nearest you to avoid network traffic, or click **Auto Select** then click **Next**.
- c. From the FTP site, select the BIOS version that you want to download then click **Next**.



The ASUS Update utility is capable of updating itself through the Internet. Always update the utility to avail all its features.

#### *Updating from a BIOS file*

- a. Select **Update BIOS from a file**, then click **Next**.
  - b. Locate the BIOS file from the **Open** window, then click **Open**.
3. Follow the onscreen instructions to complete the updating process.

## 2.1.2 ASUS EZ Flash 2

The ASUS EZ Flash 2 feature allows you to update the BIOS without using an OS-based utility.



Before you start using this utility, download the latest BIOS file from the ASUS website at [www.asus.com](http://www.asus.com).

To update the BIOS using EZ Flash 2:

1. Insert the USB flash disk that contains the latest BIOS file to the USB port, then launch EZ Flash 2 in either of these two ways:
  - Press **<Alt> + <F2>** during POST.
  - Enter the BIOS setup program. Go to the **Tools** menu to select **EZ Flash 2** and press **<Enter>** to enable it.Press **<Tab>** to switch between drives until the correct BIOS file is found.

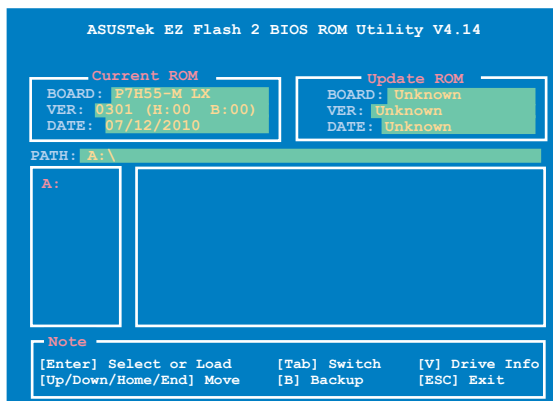

2. When the correct BIOS file is found, EZ Flash 2 performs the BIOS update process and automatically reboots the system when done.



- This function supports USB flash disks with **FAT 32/16** format and single partition only.
- **DO NOT** shut down or reset the system while updating the BIOS to prevent system boot failure!

### 2.1.3 ASUS BIOS Updater

The ASUS BIOS Updater allows you to update BIOS in DOS environment. This utility also allows you to copy the current BIOS file that you can use as a backup when the BIOS fails or gets corrupted during the updating process.



The succeeding utility screens are for reference only. The actual utility screen displays may not be same as shown.

#### Before updating BIOS

1. Prepare the motherboard support DVD and a USB flash drive in FAT32/16 format and single partition.
2. Download the latest BIOS file and BIOS Updater from the ASUS website at <http://support.asus.com> and save them on the USB flash drive.



- NTFS is not supported under DOS environment. Do not save the BIOS file and BIOS Updater to a hard disk drive or USB flash drive in NTFS format.
- Do not save the BIOS file to a floppy disk due to low disk capacity.

3. Turn off the computer and disconnect all SATA hard disk drives (optional).

#### Booting the system in DOS environment

1. Insert the USB flash drive with the latest BIOS file and BIOS Updater to the USB port.
2. Boot your computer. When the ASUS Logo appears, press <F8> to show the **BIOS Boot Device Select Menu**. Insert the support DVD into the optical drive and select the optical drive as the boot device.

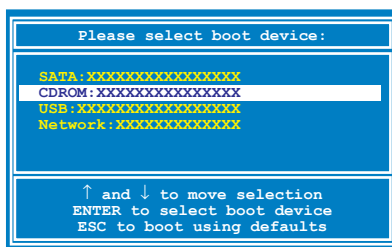

- When the Make Disk menu appears, select the FreeDOS command prompt item by pressing the item number.
- At the FreeDOS prompt, type `d:` and press `<Enter>` to switch the disk from Drive C (optical drive) to Drive D (USB flash drive).

```

Welcome to FreeDOS (http://www.freedos.org) !
C:\>d:
D:\>

```

### Backing up the current BIOS

To backup the current BIOS file using the BIOS Updater



Ensure that the USB flash drive is not write-protected and has at least 1024KB free space to save the file.

- At the FreeDOS prompt, type `bupdater /o[filename]` and press `<Enter>`.

```

D:\>bupdater /oOLDBIOS1.rom

```

Filename
Extension

The [filename] is any user-assigned filename with no more than eight alphanumeric characters for the filename and three alphanumeric characters for the extension.

- The BIOS Updater backup screen appears indicating the BIOS backup process. When BIOS backup is done, press any key to return to the DOS prompt.

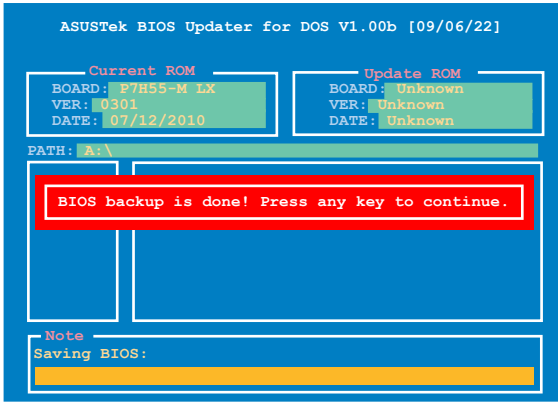

## Updating the BIOS file

To update the BIOS file using BIOS Updater

1. At the FreeDOS prompt, type `bupdater /pc /g` and press <Enter>.

```
D:\>bupdater /pc /g
```

2. The BIOS Updater screen appears as below.

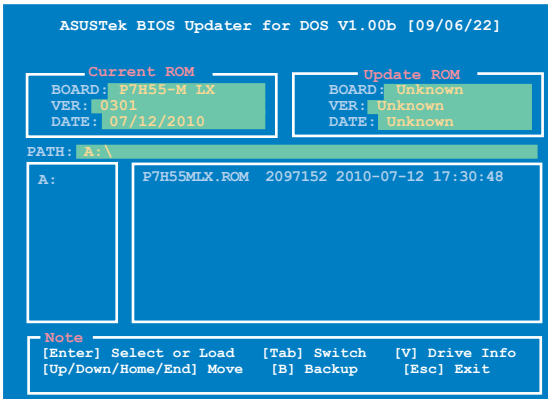

3. Press <Tab> to switch between screen fields and use the <Up/Down/Home/End> keys to select the BIOS file and press <Enter>. BIOS Updater checks the selected BIOS file and prompts you to confirm BIOS update.



4. Select **Yes** and press <Enter>. When BIOS update is done, press <ESC> to exit BIOS Updater. Restart your computer.



DO NOT shut down or reset the system while updating the BIOS to prevent system boot failure!



- For BIOS Updater version 1.04 or later, the utility automatically exits to the DOS prompt after updating BIOS.
- Ensure to load the BIOS default settings to ensure system compatibility and stability. Select the **Load Setup Defaults** item under the **Exit BIOS menu** for details.
- Ensure to connect all SATA hard disk drives after updating the BIOS file if you have disconnected them.

## 2.1.4 ASUS CrashFree BIOS 3

ASUS CrashFree BIOS 3 is an auto recovery tool that allows you to restore the BIOS file when it fails or gets corrupted during the updating process. You can restore a corrupted BIOS file using the motherboard support DVD or a USB flash drive that contains the BIOS file.



- 
- Before using this utility, rename the BIOS file in the USB flash drive into **P7H55MLE.ROM** (for **P7H55-M LE**), **P7H55MLX.ROM** (for **P7H55-M LX**), or **PH55MLX2.ROM** (for **P7H55-M LX2**).
  - Download the latest BIOS file from the ASUS website at [www.asus.com](http://www.asus.com).
- 

### Recovering the BIOS

To recover the BIOS:

1. Turn on the system.
2. Insert the support DVD to the optical drive or the removable device that contains the BIOS file to the USB port or to the floppy disk drive, if supported.
3. The utility automatically checks the devices for the BIOS file. When found, the utility reads the BIOS file and starts flashing the corrupted BIOS file.
4. Turn off the system after the utility completes the updating process and turn on again.



---

DO NOT shut down or reset the system while updating the BIOS! Doing so can cause system boot failure!

---



---

Ensure to load the BIOS default settings to ensure system compatibility and stability. Select the **Load Setup Defaults** item under the Exit menu. Refer to section **2.8 Exit menu** for details.

---



## 2.2 BIOS setup program

Use the BIOS Setup program to update the BIOS or configure its parameters. The BIOS screens include navigation keys and brief online help to guide you in using the BIOS Setup program.

### Entering BIOS Setup at startup

To enter BIOS Setup at startup:

- Press <Delete> during the Power-On Self Test (POST). If you do not press <Delete>, POST continues with its routines.

### Entering BIOS Setup after POST

To enter BIOS Setup after POST:

- Press <Ctrl>+<Alt>+<Delete> simultaneously.
- Press the reset button on the system chassis.
- Press the power button to turn the system off then back on. Do this option only if you failed to enter BIOS Setup using the first two options.



---

Using the **power button**, **reset button**, or the <Ctrl>+<Alt>+<Delete> keys to force reset from a running operating system can cause damage to your data or system. We recommend to always shut down the system properly from the operating system.

---



- The default BIOS settings for this motherboard apply for most conditions to ensure optimum performance. If the system becomes unstable after changing any BIOS settings, load the default settings to ensure system compatibility and stability. Select the **Load Setups Default** item under the Exit Menu. See section **2.8 Exit Menu**.
  - The BIOS setup screens shown in this section are for reference purposes only, and may not exactly match what you see on your screen.
  - Visit the ASUS website at [www.asus.com](http://www.asus.com) to download the latest BIOS file for this motherboard.
-

## 2.3 Main menu

When you enter the BIOS Setup program, the **Main** menu screen appears, giving you an overview of the basic system information.

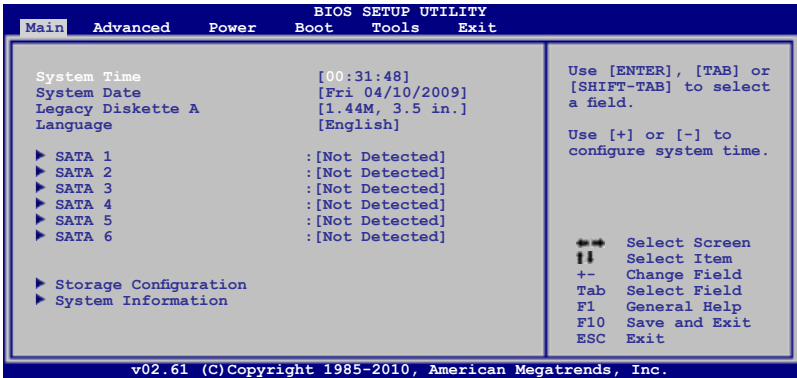

### 2.3.1 System Time [xx:xx:xx]

Allows you to set the system time.

### 2.3.2 System Date [Day xx/xx/xxxx]

Allows you to set the system date.

### 2.3.3 Legacy Diskette A [1.44M, 3.5 in.]

Sets the type of floppy drive installed. Configuration options: [Disabled] [360K, 5.25 in.] [1.2M , 5.25 in.] [720K , 3.5 in.] [1.44M, 3.5 in.] [2.88M, 3.5 in.]



This item appears only on P7H55-M LE.

### 2.3.4 Language [English]

Allows you to choose the display language in BIOS.

Configuration options: [繁體中文] [简体中文] [日本語] [Français] [Deutsch] [English]

### 2.3.5 SATA 1-6

While entering Setup, the BIOS automatically detects the presence of SATA devices. There is a separate sub-menu for each SATA device. Select a device item then press <Enter> to display the SATA device information.

The BIOS automatically detects the values opposite the dimmed items (Device, Vendor, Size, LBA Mode, Block Mode, PIO Mode, Async DMA, Ultra DMA, and SMART Monitoring). These values are not user-configurable. These items show N/A if no Serial ATA device is installed in the system.

## Type [Auto]

Selects the type of SATA drive. Setting to [Auto] allows automatic selection of the appropriate SATA device type. Select [CDROM] if you are specifically configuring a CD-ROM drive. Select [ARMD] (ATAPI Removable Media Device) if your device is either a ZIP, LS-120, or MO drive. Configuration options: [Not Installed] [Auto] [CDROM] [ARMD]



---

This item does not appear if you select SATA 5/6 devices.

---

## LBA/Large Mode [Auto]

Enables or disables the LBA mode. Setting to [Auto] enables the LBA mode if the device supports this mode, and if the device was not previously formatted with LBA mode disabled. Configuration options: [Disabled] [Auto]

## Block (Multi-sector Transfer) M [Auto]

Enables or disables data multi-sectors transfers. When set to [Auto], the data transfer from and to the device occurs multiple sectors at a time if the device supports multi-sector transfer feature. When set to [Disabled], the data transfer from and to the device occurs one sector at a time. Configuration options: [Disabled] [Auto]

## PIO Mode [Auto]

Selects the PIO mode. Configuration options: [Auto] [0] [1] [2] [3] [4]

## DMA Mode [Auto]

Selects the DMA mode. Configuration options: [Auto]

## SMART Monitoring [Auto]

Sets the Smart Monitoring, Analysis, and Reporting Technology. Configuration options: [Auto] [Disabled] [Enabled]

## 32Bit Data Transfer [Enabled]

Enables or disables 32-bit data transfer. Configuration options: [Disabled] [Enabled]

## 2.3.6 Storage Configuration

The items in this menu allow you to set or change the configurations for the SATA devices installed in the system. Select an item then press <Enter> if you want to configure the item.

### SATA Configuration [Enhanced]

Allows you to set the SATA configuration. Configuration options: [Disabled] [Compatible] [Enhanced]

#### Configure SATA as [IDE]

Sets the configuration for the Serial ATA connectors supported by the Southbridge chip. Configuration options: [IDE] [AHCI]



---

Due to Intel chipset driver support regulation, the AHCI mode is not supported in Windows XP environment. The AHCI mode is only supported by Windows Vista/7 with OS built-in driver.

---

### Hard Disk Write Protect [Disabled]

Disables or enables device write protection. This will be effective only if device is accessed through BIOS. Configuration option: [Disabled] [Enabled]

### IDE Detect Time Out (Sec) [35]

Selects the time out value for detecting ATA/ATAPI devices.  
Configuration options: [0] [5] [10] [15] [20] [25] [30] [35]

## 2.3.7 System Information

This menu gives you an overview of the general system specifications. The BIOS automatically detects the items in this menu.

### Bios Information

Displays the auto-detected BIOS information.

### Processor

Displays the auto-detected CPU specification.

### System Memory

Displays the auto-detected system memory.

## 2.4 Advanced menu

The **Advanced** menu items allow you to change the settings for the CPU and other system devices.



Take caution when changing the settings of the Advanced menu items. Incorrect field values can cause the system to malfunction.

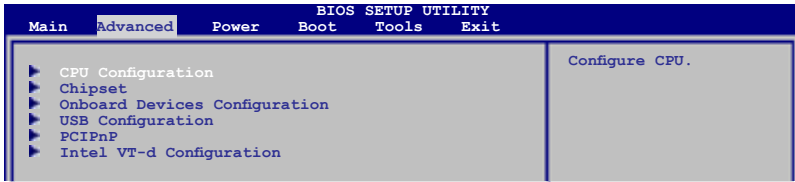

### 2.4.1 CPU Configuration

The items in this menu show the CPU-related information that the BIOS automatically detects.

#### Ratio CMOS Setting [Auto]

Sets the ration between CPU core clock and the FSB frequency. Key in ratio numbers directly.



If an invalid ratio is set in CMOS, then the actual and set values may differ.

### **C1E Support [Enabled]**

Allows you to enable or disable C1E Support. Configuration options: [Disabled] [Enabled]

### **Hardware Prefetcher [Enabled]**

Setting this item to **[Enabled]** allows the processor to fetch data and instructions from the memory into the cache that are likely to be required in the near future. This reduces the latency associated with memory reads. Configuration options: [Disabled] [Enabled]

### **Adjacent Cache Line Prefetch [Enabled]**

When this item is set to **[Enabled]**, the processor fetches the currently requested cache line, as well as the subsequent cache line. This reduces the cache latency by making the next cache line immediately available if the processor requires it as well. When set to **[Disabled]**, the processor fetches only the currently requested cache line. Configuration options: [Disabled] [Enabled]

### **Max CPUID Value Limit [Disabled]**

Setting this item to **[Enabled]** allows legacy operating systems to boot even without support for CPUs with extended CPUID functions. Configuration options: [Disabled] [Enabled]

### **Intel® Virtualization Tech [Enabled]**

Enables or disables Intel® Virtualization Technology. Virtualization enhanced by Intel® Virtualization Technology allows a platform to run multiple operating systems and applications in independent partitions. With virtualization, one computer system can function as multiple virtual systems. Configuration options: [Enabled] [Disabled]

### **CPU TM function [Enabled]**

Enables or disables Intel® CPU Thermal Monitor (TM) function, a CPU overheating protection function. When enabled, the CPU core frequency and voltage are reduced when the CPU overheats. Configuration options: [Disabled] [Enabled]

### **Execute-Disable Bit Capability [Enabled]**

Allows you to enable or disable the No-Execution Page Protection Technology. Setting this item to **[Disabled]** forces the XD feature flag to always return to zero (0). Configuration options: [Disabled] [Enabled]

### **Active Processor Cores [All]**

Allows you to choose the number of CPU cores to activate in each processor package. Configuration options: [All] [1] [2]

### **A20M [Disabled]**

Setting this item to **[Enabled]** allows Legacy OSES to be compatible with APs. Configuration options: [Disabled] [Enabled]



---

The following item appears only when you installed an Intel® CPU that supports the Enhanced Intel® SpeedStep® Technology (EIST).

---

### **Intel(R) SpeedStep(TM) Tech [Enabled]**

When this item is set to **[Enabled]**, the CPU speed is controlled by the operating system.

When this item is set to **[Disabled]**, the CPU runs at its default speed.

Configuration options: [Enabled] [Disabled]

### **Intel(R) TurboMode Tech [Enabled]**

This item appears only if you set the **CPU Ratio Setting** item to [Auto]. Turbo mode allows processor cores to run faster than marked frequency in specific condition. Configuration options: [Disabled] [Enabled]

### **Intel(R) C-STATE Tech [Enabled]**

Allows you enable or disable the Intel® C-STATE Technology. When enabled, the CPU idle is set to C2/C3/C4/C6. Configuration options: [Disabled] [Enabled]

### **C State package limit setting [Auto]**

This item appears only when you set the **Intel® C-STATE Tech** item to **[Enabled]**. We recommend that you set this item to [Auto] for BIOS to automatically detect the C-State mode supported by your CPU. Configuration options: [Auto] [C1] [C3] [C6]

## **2.4.2 Chipset**

The **Chipset** menu allows you to change the advanced chipset settings. Select an item then press **<Enter>** to display the submenu.

### **Uncore configuration**

#### *DRAM Frequency [Auto]*

Allows you to adjust the DRAM frequency.

Configuration options: [Auto] [DDR3-800 MHz] [DDR3-1066 MHz] [DDR3-1333 MHz]

#### *Memory Remap Feature [Enabled]*

Allows you to enable or disable the remapping of the overlapped PCI memory above the total physical memory. Enable this option only when you install 64-bit operating system. Configuration options: [Disabled] [Enabled]

#### *Initiate Graphic Adapter [PCIe/PCI]*

Allows you to decide which graphics controller to use as the primary boot device. The configuration options for this item vary with CPUs. When a Lynnfield CPU is installed, the default setting is [PCIe/PCI]. The configuration options are [PCI/PCIe] [PCIe/PCI]. When a Clarkdale CPU is installed, the default setting is [PEG/PCI]. The configuration options are [IGD] [PCI/IGD] [PCI/PEG] [PEG/IGD] [PEG/PCI].

## **2.4.3 Onboard Devices Configuration**

### **HDA Controller [Enabled]**

Allows you to enable or disable the high definition audio controller.

Configuration options: [Enabled] [Disabled]

#### *Front Panel Type [HD Audio]*

Allows you to select the front panel type. If High Definition Audio Front Panel used, please set HD Audio mode. Configuration options: [AC97] [HD Audio]

### JMB368 IDE [Enabled]

Allows you to enable or disable the JMB368 IDE Controller.

Configuration options: [Disabled] [Enabled]



---

This item appears only on P7H55-M LE.

---

### Onboard LAN [Enabled]

Allows you to enable or disable the onboard LAN controller.

Configuration options: [Enabled] [Disabled]

#### Onboard LAN Boot ROM [Disabled]

Allows you to enable or disable the boot ROM in the onboard LAN controller. This item appears only when the **Onboard LAN** item is set to **[Enabled]**. Configuration options: [Disabled] [Enabled]

### Serial Port1 Address [3F8/IRQ4]

Allows you to select the Serial Port1 base address.

Configuration options: [Disabled] [3F8/IRQ4] [2F8/IRQ3] [3E8/IRQ4] [2E8/IRQ3]



---

The following items appear only on P7H55-M LE.

---

### Serial Port2 Address [2F8/IRQ3]

Allows you to select the Serial Port2 base address.

Configuration options: [Disabled] [2F8/IRQ3] [3E8/IRQ4] [2E8/IRQ3]

### Parallel Port Address [378]

Allows you to select the Parallel Port base addresses. Configuration options: [Disabled] [378] [278]

### Parallel Port Mode [ECP]

Allows you to select the Parallel Port mode.

Configuration options: [Normal] [EPP] [ECP] [EPP+ECP]

#### ECP Mode DMA Channel [DMA3]

Appears only when the Parallel Port Mode item is set to **[ECP]** or **[EPP+ECP]**. This item allows you to set the Parallel Port ECP DMA. Configuration options: [DMA0] [DMA1] [DMA3]

#### EPP Version [1.9]

Appears only when the Parallel Port Mode item is set to **[EPP]** or **[EPP+ECP]**. This item allows you to select the EPP version. Configuration options: [1.9] [1.7]

#### Parallel Port IRQ [IRQ7]

Allows you to select parallel port IRQ. Configuration options: [IRQ5] [IRQ7]

## 2.4.4 USB Configuration

The items in this menu allows you to change the USB-related features. Select an item then press **<Enter>** to display the configuration options.



---

The Module Version and USB Devices Enabled items show the auto-detected values. If no USB device is detected, the item shows **None**.

---

### USB Functions [Enabled]

Allows you to disable or enable the USB functions. Configuration options: [Disabled] [Enabled]

### Legacy USB Support [Auto]

Allows you to enable or disable support for Legacy USB storage devices, including USB flash drives and USB hard drives. Setting to **[Auto]** allows the system to detect the presence of USB devices at startup. If detected, the USB controller legacy mode is enabled. If no USB device is detected, the legacy USB support is disabled. Configuration options: [Disabled] [Enabled] [Auto]

### BIOS EHCI Hand-off [Enabled]

Allows you to enable or disable the BIOS EHCI Hand-off function. Configuration options: [Disabled] [Enabled]



---

The following items may only appear when a USB storage device is plugged.

---

### USB Mass Storage Device Configuration

#### USB Mass Storage Reset Delay [20 Sec]

Allows you to set the maximum time that the BIOS waits for the USB storage device to initialize. Configuration options: [10 Sec] [20 Sec] [30 Sec] [40 Sec]

#### Emulation Type [Auto]

Allows you to select the emulation type. Configuration options: [Auto] [Floppy] [Forced]

## 2.4.5 PCI PnP

The PCI PnP menu items allow you to change the advanced settings for PCI/PnP devices. The menu includes setting IRQ and DMA channel resources for either PCI/PnP or legacy ISA devices, and setting the memory size block for legacy ISA devices.



---

Take caution when changing the settings of the PCI PnP menu items. Incorrect field values can cause the system to malfunction.

---

### Plug and Play O/S [No]

When set to [No], BIOS configures all the devices in the system. When set to [Yes] and if you install a Plug and Play operating system, the operating system configures the Plug and Play devices not required for boot. Configuration options: [No] [Yes]



## 2.4.6 Intel VT-d Configuration

### Intel VT-d [Disabled]

Allows you to enable or disable the Intel® Virtualization Technology for Directed I/O.  
Configuration options: [Disabled] [Enabled]

## 2.5 Power menu

The Power menu items allow you to change the settings for the Advanced Power Management (APM). Select an item then press <Enter> to display the configuration options.

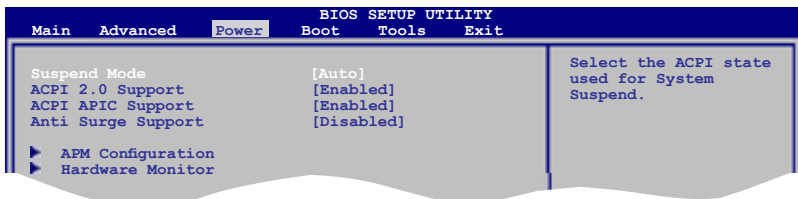

### 2.5.1 Suspend Mode [Auto]

Allows you to select the Advanced Configuration and Power Interface (ACPI) state to be used for system suspend. Configuration options: [S1 (POS) Only] [S3 Only] [Auto]

**[S1(POS) Only]** - Enables the system to enter the ACPI S1 (Power on Suspend) sleep state. In S1 sleep state, the system appears suspended and stays in a low power mode. The system can be resumed at any time.

**[S3 Only]** - Enables the system to enter the ACPI S3 (Suspend to RAM) sleep state (default). In S3 sleep state, the system appears to be off and consumes less power than in the S1 state. When signaled by a wake-up device or event, the system resumes to its working state exactly where it was left off.

**[Auto]** - Detected by OS.

### 2.5.2 ACPI 2.0 Support [Enabled]

Allows you to add more tables for Advanced Configuration and Power Interface (ACPI) 2.0 specifications. Configuration options: [Disabled] [Enabled]

### 2.5.3 ACPI APIC Support [Enabled]

Allows you to enable or disable the Advanced Configuration and Power Interface (ACPI) support in the Application-Specific Integrated Circuit (ASIC). When set to Enabled, the ACPI APIC table pointer is included in the RSDT pointer list. Configuration options: [Disabled] [Enabled]

### 2.5.4 Anti Surge Support [Disabled]

Allows you to enable or disable the Anti Surge function. Configuration options: [Disabled] [Enabled]

## 2.5.5 APM Configuration

### Restore on AC Power Loss [Power Off] (P7H55-M LE only)

When set to [Power Off], the system goes into off state after an AC power loss. When set to [Power On], the system goes on after an AC power loss. When set to [Last State], the system goes into either off or on state, whatever the system state was before the AC power loss. Configuration options: [Power Off] [Power On] [Last State]

### Power On By RTC Alarm [Disabled]

Allows you to enable or disable RTC to generate a wake event. When this item is set to Enabled, the items RTC Alarm Date, RTC Alarm Hour, RTC Alarm Minute, and RTC Alarm Second appear with set values. Configuration options: [Disabled] [Enabled]

### Power On By External Modems [Disabled]

This allows either settings of [Enabled] or [Disabled] for powering up the computer when the external modem receives a call while the computer is in Soft-off mode. Configuration options: [Disabled] [Enabled]

### Power On PCI Devices [Disabled]

When set to [Enabled], this parameter allows you to wake the system through a PCI LAN or modem card. This feature requires an ATX power supply that provides at least 1A on the +5VSB lead. Configuration options: [Disabled] [Enabled]

### Power On PCIE Devices [Disabled]

When set to [Enabled], this parameter allows you to wake the system through a PCI Express card. This feature requires an ATX power supply that provides at least 1A on the +5VSB lead. Configuration options: [Disabled] [Enabled]

### Power On By PS/2 KB [Disabled]

Allows you to use specific keys on the PS/2 keyboard to turn on the system. This feature requires an ATX power supply that provides at least 1A on the +5VSB lead. Configuration options: [Disabled] [Space Bar] [Ctrl-Esc] [Power Key]

### Power On By PS/2 Mouse [Disabled]

When set to [Enabled], this parameter allows you to use the PS/2 mouse to turn on the system. This feature requires an ATX power supply that provides at least 1A on the +5VSB lead. Configuration options: [Disabled] [Enabled]

## 2.5.6 Hardware Monitor

### CPU/MB Temperature [xxx°C/xxx°F] or [Ignored]

The onboard hardware monitor automatically detects and displays the motherboard and CPU temperatures. Select **Ignored** if you do not wish to display the detected temperatures.

### CPU/Chassis Fan Speed [xxxxRPM] or [Ignored]

The onboard hardware monitor automatically detects and displays the CPU/chassis fan speed in rotations per minute (RPM). If the fan is not connected to the motherboard, the field shows **N/A**. Select **Ignored** if you do not wish to display the detected speed.

### CPU Voltage, 3.3V Voltage, 5V Voltage, 12V Voltage [xxxV] or [Ignored]

The onboard hardware monitor automatically detects the voltage output through the onboard voltage regulators.

## CPU/Chassis Q-Fan Function [Enabled]

Allows you to enable or disable the CPU/Chassis Q-Fan function.  
Configuration options: [Disabled] [Enabled]

## CPU/Chassis Q-Fan Mode [Optimal]

Allows you to select CPU/Chassis Q-Fan mode.  
Configuration options: [Performance] [Optimal] [Silent]

## 2.6 Boot menu

The **Boot** menu items allow you to change the system boot options. Select an item then press **<Enter>** to display the sub-menu.

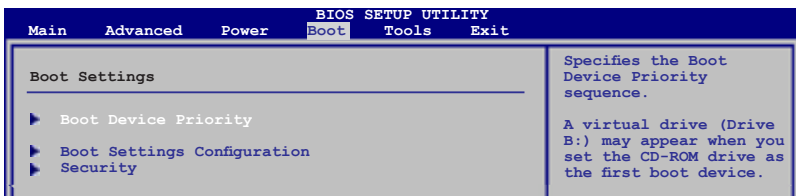

### 2.6.1 Boot Device Priority

#### 1st ~ xxth Boot Device

These items specify the boot device priority sequence from the available devices. The number of device items that appears on the screen depends on the number of devices installed in the system. Configuration options: [1st FLOPPY DRIVE] (for P7H55-M LE) / [Removable Dev.] (for P7H55-M LX) [Hard Drive] [ATAPI CD-ROM] [Disabled]



- To select the boot device during system startup, press <F8> when ASUS Logo appears.
- To access Windows® OS in Safe Mode, do any of the following:
  - Press <F5> when ASUS Logo appears.
  - Press <F8> after POST.

### 2.6.2 Boot Settings Configuration

#### Quick Boot [Enabled]

Enabling this item allows the BIOS to skip some power on self tests (POST) while booting to decrease the time needed to boot the system. When set to **[Disabled]**, BIOS performs all the POST items. Configuration options: [Disabled] [Enabled]

#### Full Screen Logo [Enabled]

This allows you to enable or disable the full screen logo display feature. Configuration options: [Disabled] [Enabled]



Set this item to **[Enabled]** to use the ASUS MyLogo2™ feature.

### AddOn ROM Display Mode [Force BIOS]

Sets the display mode for option ROM. Configuration options: [Force BIOS] [Keep Current]

### Bootup Num-Lock [On]

Allows you to select the power-on state for the NumLock. Configuration options: [Off] [On]

### Wait For 'F1' If Error [Enabled]

When set to **Enabled**, the system waits for the F1 key to be pressed when error occurs. Configuration options: [Disabled] [Enabled]

### Hit 'DEL' Message Display [Enabled]

When set to [Enabled], the system displays the message **Press DEL to run Setup** during POST. Configuration options: [Disabled] [Enabled]

## 2.6.3 Security

The **Security** menu items allow you to change the system security settings. Select an item then press **<Enter>** to display the configuration options.

### Change Supervisor Password

Select this item to set or change the supervisor password. The **Supervisor Password** item on top of the screen shows the default **Not Installed**. After you set a password, this item shows **Installed**.

#### To set a Supervisor Password:

1. Select the **Change Supervisor Password** item and press **<Enter>**.
2. On the password box, key in a password containing up to six letters, or numbers, or both, then press **<Enter>**.
3. Confirm the password when prompted.

The message **Password Installed** appears after you successfully set your password. To change the supervisor password, follow the same steps in setting a supervisor password. To clear the supervisor password, select the **Change Supervisor Password** then press **<Enter>** twice. The message **Password uninstalled** appears.



---

If you forget your BIOS password, you can clear it by erasing the CMOS Real Time Clock (RTC) RAM. See section 1.6 **Jumpers** for information on how to erase the RTC RAM.

---

After you have set a supervisor password, the other items appear to allow you to change other security settings.

### User Access Level [Full Access]

This item allows you to select the access restriction to the Setup items. Configuration options: [No Access] [View Only] [Limited] [Full Access]

**[No Access]** - prevents user access to the Setup utility.

**[View Only]** - allows access but does not allow change to any field.

**[Limited]** - allows changes only to selected fields, such as Date and Time.

**[Full Access]** - allows viewing and changing all the fields in the Setup utility.

## Change User Password

Select this item to set or change the user password. The **User Password** item on top of the screen shows the default **Not Installed**. After you set a password, this item shows **Installed**. To set a User Password:

1. Select the **Change User Password** item and press **<Enter>**.
2. On the password box, key in a password containing up to six letters, or numbers, or both, then press **<Enter>**.
3. Confirm the password when prompted.

The message **Password Installed** appears after you set your password successfully. To change the user password, follow the same steps in setting a user password.

## Clear User Password

Select this item to clear the user password.

## Password Check [Setup]

When set to **[Setup]**, BIOS checks for user password when accessing the Setup utility. When set to **[Always]**, BIOS checks for user password both when accessing Setup and booting the system. Configuration options: **[Setup]** **[Always]**

## 2.7 Tools menu

The Tools menu items allow you to configure options for special functions. Select an item then press **<Enter>** to display the sub-menu.

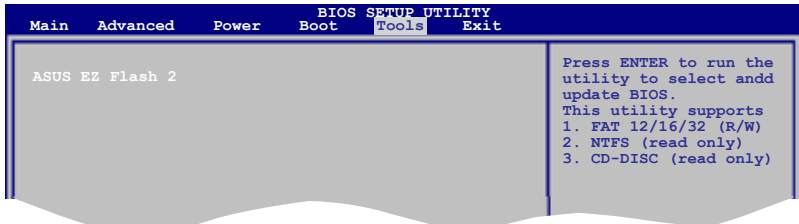

### ASUS EZ Flash 2

Allows you to run ASUS EZ Flash 2. When you press **<Enter>**, a confirmation message appears. Use the left/right arrow key to select between **[Yes]** or **[No]**, then press **<Enter>** to confirm your choice. Please see section 2.1.2 for details.

## 2.8 Exit menu

The Exit menu items allow you to load the optimal or failsafe default values for the BIOS items, and save or discard your changes to the BIOS items.

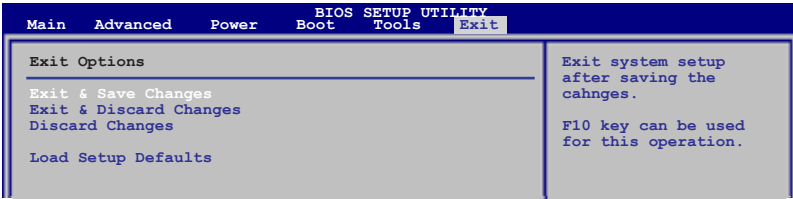

Pressing **<Esc>** does not immediately exit this menu. Select one of the options from this menu or **<F10>** from the legend bar to exit.

### Exit & Save Changes

Once you are finished making your selections, choose this option from the Exit menu to ensure the values you selected are saved to the CMOS RAM. An onboard backup battery sustains the CMOS RAM so it stays on even when the PC is turned off. When you select this option, a confirmation window appears. Select **OK** to save changes and exit.

### Exit & Discard Changes

Select this option only if you do not want to save the changes that you made to the Setup program. If you made changes to fields other than System Date, System Time, and Password, the BIOS asks for a confirmation before exiting.

### Discard Changes

This option allows you to discard the selections you made and restore the previously saved values. After selecting this option, a confirmation appears. Select **OK** to discard any changes and load the previously saved values.

### Load Setup Defaults

This option allows you to load the default values for each of the parameters on the Setup menus. When you select this option or if you press **<F5>**, a confirmation window appears. Select **OK** to load default values. Select **Exit & Save Changes** or make other changes before saving the values to the non-volatile RAM.

# P7P55/P7H57/P7H55 series motherboards installation notices

## Intel® LGA1156 processor and chipset combination instruction

Chipset \ CPU type	Clarkdale CPU (with integrated GPU)	Lynnfield CPU
H57/H55	<ul style="list-style-type: none"> <li>Integrated GPU enabled</li> <li>HDMI/DVI/D-Sub ports enabled*</li> </ul>	Discrete VGA card required
P55	Discrete VGA card required	Discrete VGA card required
* Only available for motherboards with this function.		

## Memory configuration

Chipset \ CPU type	Clarkdale CPU (with integrated GPU)	Lynnfield CPU
1 DIMM	supports one module inserted into <b>ANY</b> slot as Single-channel memory configuration	supports one module inserted into <b>Slot A1 or B1</b> as Single-channel memory configuration
2 DIMMs	supports two modules inserted into either the blue slots or the black slots as one pair of Dual-channel memory configuration	supports two modules inserted into the <b>blue slots (A1 and B1)</b> as one pair of Dual-channel memory configuration
4 DIMMs	supports four modules inserted into both the blue and the black slots as two pairs of Dual-channel memory configuration	

## Configurations for the PCI Express x16 slots

According to Intel® CPU spec, the PCIe x 6\_2 slot of the H57/H55 chipset will be disabled when using Clarkdale CPU. Refer to the table below for details.

Chipset	PCI Express x16 slot	CPU type	
		Clarkdale CPU (with integrated GPU)	Lynnfield CPU
H57/H55	PCIe x16_1 (blue)	O	O
	PCIe x16_2 (white)*	X	O
	PCIe x16_2 (black)*	O	O
P55	PCIe x16_1 (blue)	No limitation	No limitation
	PCIe x16_2 (white)*	No limitation	No limitation
	PCIe x16_2 (black)*	No limitation	No limitation
	PCIe x16_3* (black)	No limitation	No limitation
* The color of the PCIe x16_2 slot varies by model. ** The PCIe x16_2 slot can work at maximum x8 link only.			

## ASUS contact information

### ASUSTeK COMPUTER INC.

Address	15 Li-Te Road, Peitou, Taipei, Taiwan 11259
Telephone	+886-2-2894-3447
Fax	+886-2-2890-7798
E-mail	info@asus.com.tw
Web site	www.asus.com.tw

#### *Technical Support*

Telephone	+86-21-38429911
Online support	support.asus.com

### ASUS COMPUTER INTERNATIONAL (America)

Address	800 Corporate Way, Fremont, CA 94539, USA
Telephone	+1-510-739-3777
Fax	+1-510-608-4555
Web site	usa.asus.com

#### *Technical Support*

Telephone	+1-812-282-2787
Support fax	+1-812-284-0883
Online support	support.asus.com

### ASUS COMPUTER GmbH (Germany and Austria)

Address	Harkort Str. 21-23, D-40880 Ratingen, Germany
Fax	+49-2102-959911
Web site	www.asus.de
Online contact	www.asus.de/sales

#### *Technical Support*

Telephone (Component)	+49-1805-010923*
Telephone (System/Notebook/Eee/LCD)	+49-1805-010920*
Support Fax	+49-2102-9599-11
Online support	support.asus.com

\* EUR 0.14/minute from a German fixed landline; EUR 0.42/minute from a mobile phone.



# DECLARATION OF CONFORMITY

Per FCC Part 2 Section 2.1077(e)



Responsible Party Name: **Asus Computer International**

Address: **800 Corporate Way, Fremont, CA 94539.**

Phone/Fax No: **(510)739-3777/(510)608-4555**

hereby declares that the product

**Product Name : Motherboard**

**Model Number : P7H55-M LE/SI, P7H55-M LX, P7H55-M LX2**

Conforms to the following specifications:

- FCC Part 15, Subpart B, Unintentional Radiators
- FCC Part 15, Subpart C, Intentional Radiators
- FCC Part 15, Subpart E, Intentional Radiators

### Supplementary Information:

This device complies with part 15 of the FCC Rules. Operation is subject to the following two conditions: (1) This device may not cause harmful interference, and (2) this device must accept any interference received, including interference that may cause undesired operation.

Representative Person's Name : Steve Chang / President

Signature : Steve Chang

Date : Jul. 21, 2010

# EC Declaration of Conformity

We, the undersigned,

Manufacturer: **ASUS TEK COMPUTER INC.**  
Address, City: **No. 150, LI-HE RD., PEITOU, TAIPEI 112, TAIWAN R.O.C.**  
Country: **TAIWAN**  
Authorized representative in Europe: **ASUS COMPUTER GmbH**  
Address, City: **HARKORT STR. 21-23, 40880 PATINGEN**  
Country: **GERMANY**

declare the following apparatus:

Product name : **Motherboard**  
Model name : **P7H55-M LE/SI/P7H55-M LX/P7H55-M LX2**

conform with the essential requirements of the following directives:

**2004/109/EC-EMC Directive**  
 EN 55022:2006+A1:2007  
 EN 55024:1998+A1:2001+A2:2005  
 EN 55032:2001+A1:2003+A2:2006  
 EN 55020:2007

**1999/5/EC-R&TTE Directive**  
 EN 300 328 V1.7.1 (2006-05)  
 EN 300 440-1 V1.4.1 (2006-05)  
 EN 300 440-2 V1.4.1 (2006-05)  
 EN 301 511 V0.2 (2003-03)  
 EN 301 511 V0.2 (2003-03)  
 EN 301 608-1 V0.2.1 (2007-05)  
 EN 301 608-2 V0.2.1 (2007-05)  
 EN 301 888-1 V1.4.1 (2005-05)  
 EN 50369:2001  
 EN 50371:2002  
 EN 50383:2002

**2006/95/EC-LVD Directive**  
 EN 60950-1:2001+A11:2004  
 EN 60950-1:2006  
 EN 60950-2:2006+A1:2006  
 EN 60950-1:2006+A11:2009

**2009/125/EC-EIP Directive**  
Regulation (EC) No. 1275/2008  
 EN 62301:2005  
Regulation (EC) No. 642/2009  
 EN 62301:2005

**CE marking**



(EC conformity marking)

Position : **CEO**  
Name : **Jerry Shen**

Signature : Jerry Shen

Declaration Date: **Jul. 21, 2010**  
Year to begin affixing CE marking: **2010**