

P5G41-M SI

Motherboard

ASUS®

E4986

Second Edition V2

August 2009

Copyright © 2009 ASUSTeK Computer Inc. All Rights Reserved.

No part of this manual, including the products and software described in it, may be reproduced, transmitted, transcribed, stored in a retrieval system, or translated into any language in any form or by any means, except documentation kept by the purchaser for backup purposes, without the express written permission of ASUSTeK Computer Inc. ("ASUS").

Product warranty or service will not be extended if: (1) the product is repaired, modified or altered, unless such repair, modification or alteration is authorized in writing by ASUS; or (2) the serial number of the product is defaced or missing.

ASUS PROVIDES THIS MANUAL "AS IS" WITHOUT WARRANTY OF ANY KIND, EITHER EXPRESS OR IMPLIED, INCLUDING BUT NOT LIMITED TO THE IMPLIED WARRANTIES OR CONDITIONS OF MERCHANTABILITY OR FITNESS FOR A PARTICULAR PURPOSE. IN NO EVENT SHALL ASUS, ITS DIRECTORS, OFFICERS, EMPLOYEES OR AGENTS BE LIABLE FOR ANY INDIRECT, SPECIAL, INCIDENTAL, OR CONSEQUENTIAL DAMAGES (INCLUDING DAMAGES FOR LOSS OF PROFITS, LOSS OF BUSINESS, LOSS OF USE OR DATA, INTERRUPTION OF BUSINESS AND THE LIKE), EVEN IF ASUS HAS BEEN ADVISED OF THE POSSIBILITY OF SUCH DAMAGES ARISING FROM ANY DEFECT OR ERROR IN THIS MANUAL OR PRODUCT.

SPECIFICATIONS AND INFORMATION CONTAINED IN THIS MANUAL ARE FURNISHED FOR INFORMATIONAL USE ONLY, AND ARE SUBJECT TO CHANGE AT ANY TIME WITHOUT NOTICE, AND SHOULD NOT BE CONSTRUED AS A COMMITMENT BY ASUS. ASUS ASSUMES NO RESPONSIBILITY OR LIABILITY FOR ANY ERRORS OR INACCURACIES THAT MAY APPEAR IN THIS MANUAL, INCLUDING THE PRODUCTS AND SOFTWARE DESCRIBED IN IT.

Products and corporate names appearing in this manual may or may not be registered trademarks or copyrights of their respective companies, and are used only for identification or explanation and to the owners' benefit, without intent to infringe.

Contents

Notices.....	v
Safety information	vi
Safety information	vii
P5G41-M SI specifications summary	viii

Chapter 1: Product introduction

1.1	Before you proceed	1-1
1.2	Motherboard overview.....	1-2
	1.2.1 Motherboard layout	1-2
	1.2.2 Layout contents.....	1-2
1.3	Central Processing Unit (CPU)	1-3
1.4	System memory	1-3
	1.4.1 Overview	1-3
	1.4.2 Memory configurations.....	1-4
1.5	Expansion slots.....	1-6
	1.5.1 Installing an expansion card	1-6
	1.5.2 Configuring an expansion card	1-7
	1.5.3 PCI slots.....	1-7
	1.5.4 PCI Express x16 slot.....	1-7
1.6	Jumpers	1-7
1.7	Connectors	1-9
	1.7.1 Rear panel ports	1-9
	1.7.2 Internal connectors	1-10
1.8	Software support.....	1-17
	1.8.1 Installing an operating system	1-17
	1.8.2 Support DVD information	1-17

Chapter 2: BIOS information

2.1	Managing and updating your BIOS	2-1
	2.1.1 ASUS Update utility	2-1
	2.1.2 ASUS EZ Flash 2 utility.....	2-2
	2.1.3 ASUS CrashFree BIOS.....	2-3
2.2	BIOS setup program	2-4
	2.2.1 BIOS menu screen.....	2-5

Contents

2.2.2	Menu bar	2-5
2.2.3	Navigation keys.....	2-5
2.2.4	Menu items	2-5
2.2.5	Submenu items	2-6
2.2.6	Configuration fields	2-6
2.2.7	Pop-up window	2-6
2.2.8	Scroll bar.....	2-6
2.2.9	General help	2-6
2.3	Main menu	2-6
2.3.1	System Time	2-7
2.3.2	System Date	2-7
2.3.3	Legacy Diskette A	2-7
2.3.4	Primary IDE Master/Slave and SATA 1-4.....	2-7
2.3.5	Storage Configuration	2-8
2.3.6	System Information.....	2-8
2.4	Advanced menu	2-9
2.4.1	CPU Configuration	2-9
2.4.2	Chipset.....	2-10
2.4.3	Onboard Devices Configuration.....	2-11
2.4.4	USB Configuration	2-11
2.4.5	PCI PnP	2-12
2.5	Power menu.....	2-13
2.5.1	Suspend Mode.....	2-13
2.5.2	ACPI 2.0 Support	2-13
2.5.3	ACPI APIC Support	2-13
2.5.4	APM Configuration.....	2-13
2.5.5	Hardware Monitor	2-14
2.6	Boot menu	2-15
2.6.1	Boot Device Priority	2-15
2.6.2	Boot Settings Configuration	2-15
2.6.3	Security	2-16
2.7	Tools menu	2-17
2.7.1	ASUS EZ Flash 2.....	2-17
2.7.2	AI NET 2.....	2-17
2.8	Exit menu.....	2-18

Notices

Federal Communications Commission Statement

This device complies with Part 15 of the FCC Rules. Operation is subject to the following two conditions:

- This device may not cause harmful interference, and
- This device must accept any interference received including interference that may cause undesired operation.

This equipment has been tested and found to comply with the limits for a Class B digital device, pursuant to Part 15 of the FCC Rules. These limits are designed to provide reasonable protection against harmful interference in a residential installation. This equipment generates, uses and can radiate radio frequency energy and, if not installed and used in accordance with manufacturer's instructions, may cause harmful interference to radio communications. However, there is no guarantee that interference will not occur in a particular installation. If this equipment does cause harmful interference to radio or television reception, which can be determined by turning the equipment off and on, the user is encouraged to try to correct the interference by one or more of the following measures:

- Reorient or relocate the receiving antenna.
- Increase the separation between the equipment and receiver.
- Connect the equipment to an outlet on a circuit different from that to which the receiver is connected.
- Consult the dealer or an experienced radio/TV technician for help.



The use of shielded cables for connection of the monitor to the graphics card is required to assure compliance with FCC regulations. Changes or modifications to this unit not expressly approved by the party responsible for compliance could void the user's authority to operate this equipment.

Canadian Department of Communications Statement

This digital apparatus does not exceed the Class B limits for radio noise emissions from digital apparatus set out in the Radio Interference Regulations of the Canadian Department of Communications.

This class B digital apparatus complies with Canadian ICES-003.

REACH

Complying with the REACH (Registration, Evaluation, Authorisation, and Restriction of Chemicals) regulatory framework, we published the chemical substances in our products at ASUS REACH website at <http://green.asus.com/english/REACH.htm>.



DO NOT throw the motherboard in municipal waste. This product has been designed to enable proper reuse of parts and recycling. This symbol of the crossed out wheeled bin indicates that the product (electrical and electronic equipment) should not be placed in municipal waste. Check local regulations for disposal of electronic products.



DO NOT throw the mercury-containing button cell battery in municipal waste. This symbol of the crossed out wheeled bin indicates that the battery should not be placed in municipal waste.

Safety information

Electrical safety

- To prevent electric shock hazard, disconnect the power cable from the electric outlet before relocating the system.
- When adding or removing devices to or from the system, ensure that the power cables for the devices are unplugged before the signal cables are connected. If possible, disconnect all power cables from the existing system before you add a device.
- Before connecting or removing signal cables from the motherboard, ensure that all power cables are unplugged.
- Seek professional assistance before using an adapter or extension cord. These devices could interrupt the grounding circuit.
- Ensure that your power supply is set to the correct voltage in your area. If you are not sure about the voltage of the electrical outlet you are using, contact your local power company.
- If the power supply is broken, do not try to fix it by yourself. Contact a qualified service technician or your retailer.
- The optical S/PDIF is an optional component (may or may not be included in your motherboard) and is defined as a CLASS 1 LASER PRODUCT.



INVISIBLE LASER RADIATION, AVOID EXPOSURE TO BEAM.

- Never dispose of the battery in fire. It could explode and release harmful substances into the environment.
- Never dispose of the battery with your regular household waste. Take it to a hazardous material collection point.
- Never replace the battery with an incorrect battery type.



-
- RISK OF EXPLOSION IF BATTERY IS REPLACED BY AN INCORRECT TYPE.
 - DISPOSE OF USED BATTERIES ACCORDING TO THE ABOVE BATTERY-RELATED INSTRUCTIONS.
-

Operation safety

- Before installing the motherboard and adding devices on it, carefully read all the manuals that came with the package.
- Before using the product, ensure that all cables are correctly connected and the power cables are not damaged. If you detect any damage, contact your dealer immediately.
- To avoid short circuits, keep paper clips, screws, and staples away from connectors, slots, sockets and circuitry.
- Avoid dust, humidity, and temperature extremes. Do not place the product in any area where it may become wet.



This motherboard should only be used in environments with ambient temperatures between 5°C (14°F) and 40°C (104°F).

- Place the product on a stable surface.
- If you encounter technical problems with the product, contact a qualified service technician or your retailer.

Safety information

Electrical safety

- To prevent electrical shock hazard, disconnect the power cable from the electrical outlet before relocating the system.
- When adding or removing devices to or from the system, ensure that the power cables for the devices are unplugged before the signal cables are connected. If possible, disconnect all power cables from the existing system before you add a device.
- Before connecting or removing signal cables from the motherboard, ensure that all power cables are unplugged.
- Seek professional assistance before using an adapter or extension cord. These devices could interrupt the grounding circuit.
- Make sure that your power supply is set to the correct voltage in your area. If you are

Where to find more information

Refer to the following sources for additional information and for product and software updates.

1. ASUS websites

The ASUS website provides updated information on ASUS hardware and software products. Refer to the ASUS contact information.

2. Optional documentation

Your product package may include optional documentation, such as warranty flyers, that may have been added by your dealer. These documents are not part of the standard package.

Conventions used in this guide

To make sure that you perform certain tasks properly, take note of the following symbols used throughout this manual.



DANGER/WARNING: Information to prevent injury to yourself when trying to complete a task.



CAUTION: Information to prevent damage to the components when trying to complete a task.



IMPORTANT: Instructions that you **MUST** follow to complete a task.



NOTE: Tips and additional information to help you complete a task.

Typography

Bold text

Indicates a menu or an item to select.

Italics

Used to emphasize a word or a phrase.

<Key>

Keys enclosed in the less-than and greater-than sign means that you must press the enclosed key.

Example: <Enter> means that you must press the Enter or Return key.

<Key1>+<Key2>+<Key3>

If you must press two or more keys simultaneously, the key names are linked with a plus sign (+).

Example: <Ctrl>+<Alt>+<D>

P5G41-M SI specifications summary

CPU	<p>LGA775 Socket for Intel® Core™2 Extreme /Core™2 Quad / Core™2 Duo / Pentium® dual-core / Celeron® dual-core / Celeron® processors</p> <p>Supports Intel® 45nm multi-core CPU</p> <p>Intel® Hyper-Threading Technology ready</p> <p>Support Enhanced Intel SpeedStep Technology (EIST)</p> <p>* Ensure that you use a supported CPU, otherwise the system will show a warning message and automatically shutdown.</p>
Chipset	<p>Northbridge: Intel® G41</p> <p>Southbridge: Intel® ICH7</p>
System bus	1333/1066/800MHz
Memory	<p>Dual-channel memory architecture</p> <ul style="list-style-type: none"> - 4 x 240-pin DIMM sockets support unbuffered non-ECC DDR2 800/667MHz memory modules - Supports up to 8GB system memory <p>** When you install a total memory of 4GB capacity or more, Windows® 32-bit operating system may only recognize less than 3GB. We recommend a maximum of 3GB system memory if you are using a Windows® 32-bit OS.</p>
Expansion slots	<p>1 x PCI Express x16 slot</p> <p>3 x PCI slots</p> <p>Support PCIe 1.1 Architecture</p>
VGA	<p>Integrated Intel® Graphics Media Accelerator (Intel® GMA4500)</p> <p>Supports Microsoft® DirectX 10</p> <p>D-SUB Max. resolution: 2048 x 1536 x 32Bpp @75Hz</p> <p>DVI Max. resolution: 1920 x 1200 x 32Bpp @60Hz</p> <p>HDMI Max. resolution: 1920 x 1080 @60Hz</p>
Storage	<p>Southbridge Intel® ICH7 supports:</p> <ul style="list-style-type: none"> 4 x Serial ATA 3Gb/s connectors 1 x UltraDMA 100/66 connector
LAN	Realtek® 8112L PCIe Gb LAN controller
Audio	<p>VT1708S High Definition Audio 6-channel CODEC</p> <p>Supports Multi-Streaming</p>
USB	8 x USB 2.0/1.1 ports (4 ports at mid-board, 4 ports at back panel)
ASUS Special features	<p>ASUS CrashFree BIOS 3</p> <p>ASUS EZ Flash2</p> <p>ASUS AI NET2</p> <p>ASUS MyLogo 2</p> <p>ASUS Q-Fan</p>

(continued on the next page)

P5G41-M SI specifications summary

Rear panel ports	<ul style="list-style-type: none"> 1 x PS/2 keyboard port 1 x PS/2 mouse port 1 x LAN (RJ-45) port 4 x USB 2.0/1.1 ports 6-channel audio I/O port 1 x VGA port 1 x DVI port 1 x HDMI port 1 x COM port
Internal connectors	<ul style="list-style-type: none"> 1 x High Definition front panel audio connector 1 x S/PDIF out connector 1 x System panel connector 2 x USB 2.0 connectors support additional 4 USB 2.0 ports 1 x CPU fan connector 1 x Chassis fan connector 1 x CD audio-in connector 1 x 24-pin EATX Power connector 1 x 4-pin ATX 12V Power connector 4 x SATA connectors 1 x COM connector 1 x IDE connector 1 x TPM connector 1 x Floppy connector 1 x LPT connector
BIOS features	8 Mb Flash ROM, AMI BIOS, PnP, DMI v2.0, WfM2.0, SMBIOS v2.5, ACPI v2.0a
Manageability	WOL, PXE, WOR by Ring, PME Wake Up
Accessories	<ul style="list-style-type: none"> 1 x UltraDMA 100/66 cable 2 x Serial ATA cables 1 x Floppy cable 1 x I/O shield User Manual 1 x Support DVD
Support DVD	<ul style="list-style-type: none"> Drivers ASUS Update ASUS PC Probe II Anti-virus software (OEM version)
Form factor	MicroATX form factor: 9.6 in x 9.6 in (24.4 cm x 24.4cm)

*Specifications are subject to change without notice.

Chapter 1

Product introduction

Thank you for buying an ASUS® P5G41-M SI motherboard!

Before you start installing the motherboard, and hardware devices on it, check the items in your motherboard package. Refer to page ix for the list of accessories.



If any of the items is damaged or missing, contact your retailer.

1.1 Before you proceed

Take note of the following precautions before you install motherboard components or change any motherboard settings.



- Unplug the power cord from the wall socket before touching any component.
 - Before handling components, use a grounded wrist strap or touch a safely grounded object or a metal object, such as the power supply case, to avoid damaging them due to static electricity
 - Hold components by the edges to avoid touching the ICs on them.
 - Whenever you uninstall any component, place it on a grounded antistatic pad or in the bag that came with the component.
 - Before you install or remove any component, switch off the ATX power supply and detach its power cord. Failure to do so may cause severe damage to the motherboard, peripherals, or components.
-

Onboard LED

This motherboard comes with a standby power LED that lights up to indicate that the system is ON, in sleep mode, or in soft-off mode. This is a reminder that you must shut down the system and unplug the power cable before removing or plugging in any motherboard component. The illustration below shows the location of the onboard LED.

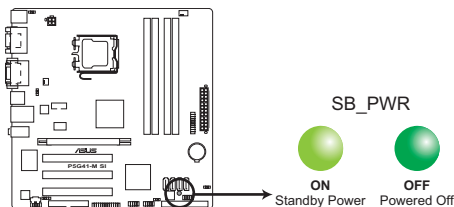

P5G41-M SI Onboard LED

1.2 Motherboard overview

1.2.1 Motherboard layout



Ensure that you install the motherboard into the chassis in the correct orientation. The edge with external ports goes to the rear part of the chassis.

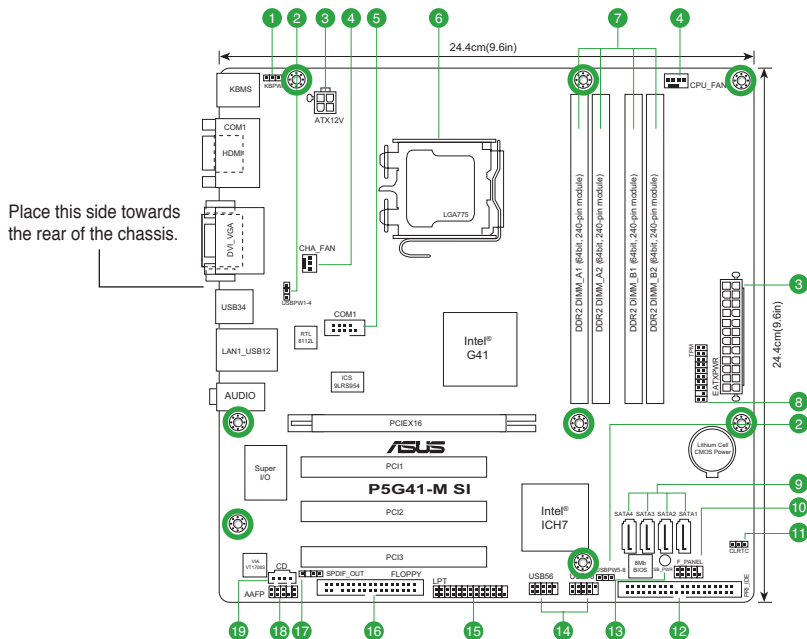

Place eight screws into the holes indicated by circles to secure the motherboard to the chassis. DO NOT overtighten the screws! Doing so can damage the motherboard.

1.2.2 Layout contents

Connectors/Jumpers/Slots/LED	Page	Connectors/Jumpers/Slots/LED	Page
1. Keyboard power (3-pin KBPWR)	1-8	11. Clear RTC RAM (3-pin CLRRTC)	1-7
2. USB device wake-up (3-pin USBPW1-4, USBPW5-8)	1-8	12. IDE connector (40-1 pin PRI_IDE)	1-11
3. ATX power connectors (24-pin EATXPWR, 4-pin ATX12V)	1-13	13. Onboard LED	1-1
4. CPU and Chassis fan connectors (4-pin CPU_FAN, 3-pin CHA_FAN)	1-10	14. USB connectors (10-1 pin USB56, USB78)	1-12
5. Serial port connectors (10-1 pin COM1)	1-12	15. LPT connector (26-1 pin LPT)	1-16
6. Intel CPU socket	1-3	16. Floppy disk drive connector (34-1 pin FLOPPY)	1-16
7. DDR2 DIMM sockets	1-3	17. Digital audio connector (4-1 pin SPDIF_OUT)	1-15
8. TPM connector (20-1 pin TPM)	1-14	18. Front panel audio connector (10-1 pin AAFP)	1-15
9. Serial ATA connectors (7-pin SATA1-4)	1-11	19. Optical drive audio in connector (4-pin CD)	1-13
10. System panel connector (10-1 pin F_PANEL)	1-14		

1.3 Central Processing Unit (CPU)

This motherboard comes with a surface mount LGA775 socket designed for the Intel® Core™ 2 Quad / Core™2 Extreme / Core™2 Duo / Pentium® dual-core / Celeron® dual-core / Celeron® processors.



Ensure that all power cables are unplugged before installing the CPU.



- Upon purchase of the motherboard, ensure that the PnP cap is on the socket and the socket contacts are not bent. Contact your retailer immediately if the PnP cap is missing, or if you see any damage to the PnP cap/socket contacts/motherboard components. ASUS will shoulder the cost of repair only if the damage is shipment/transit-related.
 - Keep the cap after installing the motherboard. ASUS will process Return Merchandise Authorization (RMA) requests only if the motherboard comes with the cap on the LGA775 socket.
 - The product warranty does not cover damage to the socket contacts resulting from incorrect CPU installation/removal, or misplacement/loss/incorrect removal of the PnP cap.
-



This motherboard supports Intel® Hyper-Threading Technology and Enhanced Intel SpeedStep® Technology (EIST).

1.4 System memory

1.4.1 Overview

This motherboard comes with four Double Data Rate 2 (DDR2) Dual Inline Memory Module (DIMM) sockets. A DDR2 DIMM has the same physical dimensions as a DDR DIMM but has a 240-pin footprint compared to the 184-pin DDR DIMM. DDR2 DIMMs are notched differently to prevent installation on a DDR DIMM socket. The figure illustrates the location of the DDR2 DIMM sockets:

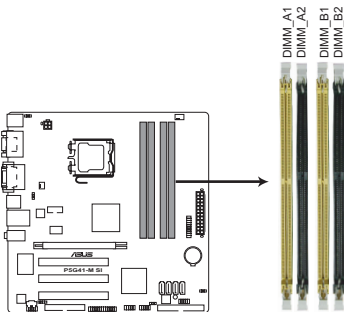

P5G41-M SI 240-pin DDR2 DIMM sockets

1.4.2 Memory configurations

You may install a 512MB, 1GB, and 2GB unbuffered non-ECC DDR2 DIMM into the DIMM socket.



-
- You may install varying memory sizes in Channel A and Channel B. The system maps the total size of the lower-sized channel for the dual-channel configuration. Any excess memory from the higher-sized channel is then mapped for single-channel operation.
 - For dual-channel configuration, you can:
 - install two identical DIMMs in DIMM_A1 and DIMM_B1; or
 - install four identical DIMMs in all four slots; or
 - install one identical DIMM pair in DIMM_A1 and DIMM_B1 (yellow slots) and another identical DIMM pair in DIMM_A2 and DIMM_B2 (black slots).
 - Due to the memory address limitation on the 32-bit Windows® OS, when you install 4GB or more memory on the motherboard, the actual usable memory for the OS can be about 3GB or less. For effective use of memory, we recommend that you do either of the following:
 - Install a maximum of 3GB system memory if you are using a 32-bit Windows® OS.
 - Use a 64-bit Windows® OS if you want to install 4GB or more memory on the motherboard.
 - This motherboard does not support DIMMs made up of 256 megabits (Mb) chips or less.



-
- This motherboard supports up to 8GB on Windows® XP Professional x64 and Windows® Vista x64 editions. You may install a maximum of 2GB DIMMs on each slot.
 - The default memory operation frequency is dependent on its Serial Presence Detect (SPD), which is the standard way of accessing information from a memory module. Under the default state, some memory modules for overclocking may operate at a lower frequency than the vendor-marked value.
 - For system stability, use a more efficient cooling system to support a full memory load (4 DIMMs) or overclocking conditions.
-

P5G41-M SI Motherboard Qualified Vendors List (QVL)

DDR2-800MHz capability

Vendor	Part No.	Size	SS/ DS	Chip Brand	Chip No.	Timing DIMM (BIOS)	Voltage	DIMM Support		
								A*	B*	C*
A-Data	M2GVD6G314170Q1E58	1024MB	DS	VDATA	VD29608A8A-25EG80813			.	.	.
A-Data	AD280002GMU	2048MB	DS	Hynix	Heat-Sink Package			.	.	.
A-Data	AD2800E002GOU	4096MB(Kit of 2)	DS	N/A	Heat-Sink Package	4-4-4-12	1.9~2.1V	.	.	.
Corsair	CM2X1024-6400	1024MB	DS	Corsair	Heat-Sink Package			.	.	.
Corsair	XMS2-6400	1024MB	DS	Corsair	Heat-Sink Package	4		.	.	.
Corsair	XMS2-6400	1024MB	DS	Corsair	Heat-Sink Package	5		.	.	.
Corsair	CM2X2048-6400C5	4096MB(Kit of 2)	DS	N/A	Heat-Sink Package	5		.	.	.
Crucial	BL12864AL80A.8FE5(EPP)	2048MB(Kit of 2)	SS	N/A	Heat-Sink Package	4-4-4-12		.	.	.
Crucial	BL25664AL80A.16FE5(EPP)	4096MB(Kit of 2)	DS	N/A	Heat-Sink Package	4-4-4-12		.	.	.
Crucial	BL25664AR80A.16FE5(EPP)	4096MB(Kit of 2)	DS	N/A	Heat-Sink Package	4-4-4-12		.	.	.
G.SKILL	F2-6400CL5D-1GBNQ	512MB	SS	G.SKILL	Heat-Sink Package SN:8151030036642	5-5-5-15		.	.	.
G.SKILL	F2-6400CL4D-2GBPK	1024MB	DS	G.SKILL	Heat-Sink Package	4		.	.	.
G.SKILL	F2-6400CL5D-2GBNQ	1024MB	DS	G.SKILL	Heat-Sink Package	5		.	.	.
G.SKILL	F2-6400CL4D-4GBPK	2048MB	DS	G.SKILL	Heat-Sink Package	4		.	.	.
G.SKILL	F2-6400CL5D-4GBPQ	2048MB	DS	G.SKILL	Heat-Sink Package	5		.	.	.
G.SkILL	F2-6400CL6D-4GBMQ	4096MB(Kit of 2)	DS	N/A	Heat-Sink Package	6-6-6-18	1.8-1.9V	.	.	.
G.SKILL	F2-6400CL6Q-16GMQ	4096MB	DS	N/A	Heat-Sink Package	5		.	.	.
GEIL	GB28GB6400C5QC	2048MB	DS	GEIL	GL2L128M88BA25AB	5		.	.	.
GEIL	GX24GB6400DC	2048MB	DS	GEIL	Heat-Sink Package	5		.	.	.
Kingmax	KLDD48F-B8KU5 NGES	1024MB	SS	Kingmax	KKB8FNUBF-DNX-25A			.	.	.
Kingston	KVR800D2N5/ 512(low profile modules)	512MB	SS	ELPIDA	E5108AJBG-8E-E		1.8V	.	.	.
Kingston	KVR800D2N6/4G	4096MB	DS	Elpida	E2108ABSE-8G-E	6	1.8V	.	.	.
OCZ	OCZ2G800R22GK	1024MB	DS	OCZ	Heat-Sink Package	4-5-5-15	2.0V	.	.	.
OCZ	OCZ2SE8002GK	2048MB(Kit of 2)	DS	N/A	Heat-Sink Package	5-5-5-15	1.8V	.	.	.
OCZ	OCZ2P8004GK	4096MB(Kit of 2)	DS	N/A	Heat-Sink Package	5-4-4-15	2.1v	.	.	.
PSC	PL8E8F73C-8E1	2048MB	DS	PSC	SHG772-AA3G	5		.	.	.
SAMSUNG	M378T6553GZS-CF7	512MB	SS	Qimonda	K4T51083QG-HCF7	6		.	.	.
SAMSUNG	M378T2863QZS-CF7	1024MB	SS	Qimonda	K4T1G084QQ-HCF7	6		.	.	.
SAMSUNG	M378T2953GZ3-CF7	1024MB	DS	Samsung	K4T51083QG			.	.	.
SAMSUNG	M378T2953GZ3-CF7	1024MB	DS	Samsung	K4T51083QG-HCF7	6		.	.	.
SAMSUNG	M37875663QZ3-CF7	2048MB	DS	Samsung	K4T1G084QQ-HCF7	6		.	.	.
Super Talent	T800UB1GC4	1024MB	DS	Super Talent	Heat-Sink Package	4	1.8V	.	.	.
Transcend	TS64MLQ64V8J	512MB	SS	Micron	7HD22 D9GMH	5		.	.	.
Transcend	TS128MLQ64V8U	1024MB	SS	ELPIDA	E1108ACBG-8E-E	5		.	.	.

DDR2-667MHz capability

Vendor	Part No.	Size	SS/ DS	Chip Brand	Chip No.	Timing DIMM	Voltage	DIMM Support		
								A*	B*	C*
A-Data	M2OAD5H3J41701C53	2048MB	DS	ADATA	AD20908A8A-3EG 30724			.	.	.
Apacer	78.91G92.9K5	512MB	SS	Apacer	AM4B570BJQJS7E0751C	5		.	.	.
Apacer	78.01G9O.9K5	1024MB	SS	Apacer	AM4B5808CQJS7E0751C	5		.	.	.
Corsair	XMS2-5400	1024MB	DS	Corsair	Heat-Sink Package	4		.	.	.
G.SKILL	F2-5400PHU2-2GBNT	2048MB(Kit of 2)	DS	G.SKILL	D2 64M8CCF 0815 C7173S	5-5-5-15		.	.	.
GEIL	GX21GB5300SX	1024MB	DS	GEIL	Heat-Sink Package	3		.	.	.
GEIL	GX22GB5300LX	2048MB	DS	GEIL	Heat-Sink Package	5		.	.	.
GEIL	GX24GB5300LDC	2048MB	DS	GEIL	Heat-Sink Package	5		.	.	.
Kingston	KVR667D2N5/1G(low profile modules)	1024MB	SS	Elpida	E1108AEBG-8E-F		1.8V	.	.	.
Kingston	KVR667D2N5/2G(low profile modules)	2048MB	DS	Elpida	E1108ACBG-8E-E	5	1.8V	.	.	.
PSC	AL7E8F73C-6E1	1024MB	SS	PSC	A3R1GE3CFF734MAA0J	5		.	.	.
PSC	AL6E8E63J-6E1	1024MB	DS	PSC	A3R12E3JFF717B9A01	5		.	.	.
SAMSUNG	M378T5263AZ3-CE6	4096MB	DS	Samsung	K4T2G084QA-HCE6			.	.	.



SS - Single-sided / DS - Double - sided DIMM support:

- **A***: Supports one module inserted into any slot as Single-channel memory configuration.
- **B***: Supports one pair of modules inserted into either the yellow or black slots as one pair of Dual-channel memory configuration.
- **C***: Supports four modules inserted into both the yellow and black slots as two pairs of Dual-channel memory configuration.



Visit the ASUS website at www.asus.com for the latest QVL.

1.5 Expansion slots

In the future, you may need to install expansion cards. The following sub-sections describe the slots and the expansion cards that they support.



Unplug the power cord before adding or removing expansion cards. Failure to do so may cause you physical injury and damage motherboard components.

1.5.1 Installing an expansion card

To install an expansion card:

1. Before installing the expansion card, read the documentation that comes with it and make the necessary hardware settings for the card.
2. Remove the chassis cover (if your motherboard is already installed in a chassis).
3. Remove the bracket opposite the slot that you intend to use.
4. Align the card connector with the slot and press firmly until the card is completely seated on the slot.
5. Secure the card to the chassis with the screw.
6. Replace the chassis cover.

1.5.2 Configuring an expansion card

After installing the expansion card, configure it by adjusting the software settings.

1. Turn on the system and change the necessary BIOS settings, if any. See Chapter 2 for information on BIOS setup.
2. Assign an IRQ to the card.
3. Install the software drivers for the expansion card.



When using PCI cards on shared slots, ensure that the drivers support “Share IRQ” or that the cards do not need IRQ assignments; otherwise, conflicts will arise between the two PCI groups, making the system unstable and the card inoperable.

1.5.3 PCI slots

The PCI slots support cards such as LAN cards, SCSI cards, USB cards, and other cards that comply with the PCI specifications.

1.5.4 PCI Express x16 slot

This motherboard supports PCI Express x16 graphics cards that comply with the PCI Express specifications.

1.6 Jumpers

1. Clear RTC RAM (3-pin CLRRTC)

This jumper allows you to clear the Real Time Clock (RTC) RAM in CMOS. You can clear the CMOS memory of date, time, and system setup parameters by erasing the CMOS RTC RAM data. The onboard button cell battery powers the RAM data in CMOS, which include system setup information such as system passwords.

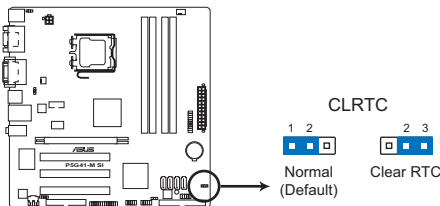

P5G41-M SI Clear RTC RAM

To erase the RTC RAM:

1. Turn OFF the computer and unplug the power cord.
2. Move the jumper cap from pins 1-2 (default) to pins 2-3. Keep the cap on pins 2-3 for about 5-10 seconds, then move the cap back to pins 1-2.
3. Plug the power cord and turn ON the computer.
4. Hold down the key during the boot process and enter BIOS setup to reenter data.



Except when clearing the RTC RAM, never remove the cap on CLRRTC jumper default position. Removing the cap will cause system boot failure!



- If the steps above do not help, remove the onboard battery and move the jumper again to clear the CMOS RTC RAM data. After clearing the CMOS, reinstall the battery.
- You do not need to clear the RTC when the system hangs due to overclocking. For system failure due to overclocking, use the CPU Parameter Recall (C.P.R.) feature. Shut down and cut off the AC power, then reboot the system, the BIOS automatically resets parameter settings to default values.

2. Keyboard power (3-pin KBPWR)

This jumper allows you to enable or disable the keyboard wake-up feature. When you set this jumper to pins 2–3 (+5VSB), you can wake up the computer by pressing a key on the keyboard (the default is the Space Bar)s. This feature requires an ATX power supply that can supply at least 1A on the +5VSB lead, and a corresponding setting in the BIOS.

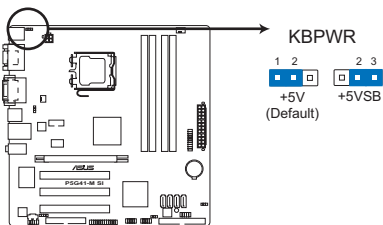

P5G41-M SI Keyboard Power Setting

3. USB device wake-up (3-pin USBPW1-4, USBPW5-8)

Set the jumper to +5V to wake up the computer from S1 sleep mode (CPU stopped, DRAM refreshed, system running in low power mode) using the connected USB devices. Set to +5VSB to wake up from S3 and S4 sleep modes (no power to CPU, DRAM in slow refresh, power supply in reduced power mode).

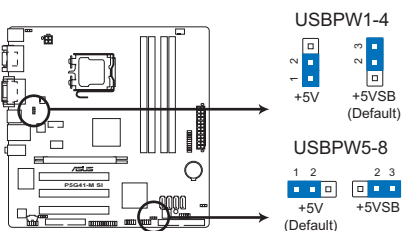

P5G41-M SI USB Device Wake Up



- The USB device wake-up feature requires a power supply that can provide 500mA on the +5VSB lead for each USB port; otherwise, the system would not power up.
- The total current consumed must NOT exceed the power supply capability (+5VSB) whether under normal condition or in sleep mode.

1.7 Connectors

1.7.1 Rear panel ports

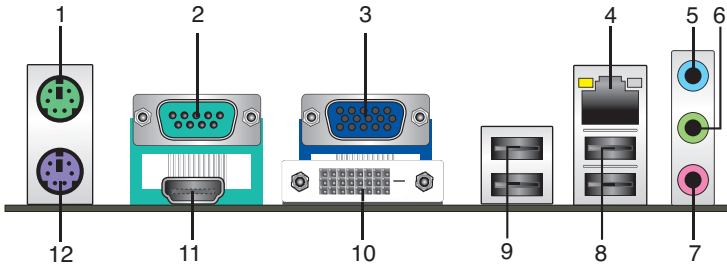

1. **PS/2 Mouse port.** This port is for a PS/2 mouse.
2. **COM port.** This 9-pin COM1 port is for pointing devices or other serial devices.
3. **Video Graphics Adapter (VGA) port.** This 15-pin port is for a VGA monitor or other VGA-compatible devices.
4. **LAN (RJ-45) port.** This port allows Gigabit connection to a Local Area Network (LAN) through a network hub. Refer to the table below for the LAN port LED indicators.

LAN port LED indications

ACT/LINK LED		SPEED LED	
Status	Description	Status	Description
OFF	No link	OFF	10 Mbps connection
ORANGE	Linked	ORANGE	100 Mbps connection
BLINKING	Data activity	GREEN	1 Gbps connection

ACT/LINK LED SPEED LED

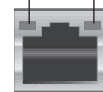

LAN port

5. **Line In port (light blue).** This port connects to the tape, CD, DVD player, or other audio sources.
6. **Line Out port (lime).** This port connects to a headphone or a speaker. In 4-channel and 6-channel configurations, the function of this port becomes Front Speaker Out.
7. **Microphone port (pink).** This port connects to a microphone.



Refer to the audio configuration table below for the function of the audio ports in 2, 4, or 6-channel configuration.

Audio 2, 4, 6-channel configuration

Port	Headset 2-channel	4-channel	6-channel
Light Blue	Line In	Rear Speaker Out	Rear Speaker Out
Lime	Line Out	Front Speaker Out	Front Speaker Out
Pink	Mic In	Mic In	Bass/Center

8. **USB 2.0 ports 1 and 2.** These two 4-pin Universal Serial Bus (USB) ports connect to USB 2.0/1.1 devices.
9. **USB 2.0 ports 3 and 4.** These two 4-pin Universal Serial Bus (USB) ports connect to USB 2.0/1.1 devices.

- 10. **DVI port.** This port is for any DVI-D compatible device. DVI-D can't be converted to output RGB Signal to CRT and isn't compatible with DVI-I.
- 11. **HDMI port.** This port is for a High-Definition Multimedia Interface (HDMI) connector, and is HDCP compliant allowing playback of HD DVD, Blu-Ray and other protected content.



Dual display output support

- This table indicates that whether the following dual display outputs are supported for your motherboard:

Dual display outputs	Supported	Not supported
DVI + D-Sub	•	
DVI + HDMI		•
HDMI + D-Sub	•	

- During POST, only the monitor connected to the D-Sub port has display. The dual display function works only under Windows.

- 12. **PS/2 Keyboard port.** This port is for a PS/2 keyboard.

1.7.2 Internal connectors

1. CPU and Chassis fan connectors (4-pin CPU_FAN, 3-pin CHA_FAN)

The fan connectors support cooling fans of 350 mA ~ 2000 mA (24 W max.) or a total of 1 A ~ 7 A (84 W max.) at +12V. Connect the fan cables to the fan connectors on the motherboard, making sure that the black wire of each cable matches the ground pin of the connector.



DO NOT forget to connect the fan cables to the fan connectors. Insufficient air flow inside the system may damage the motherboard components. They are not jumpers! DO NOT place jumper caps on the fan connectors.

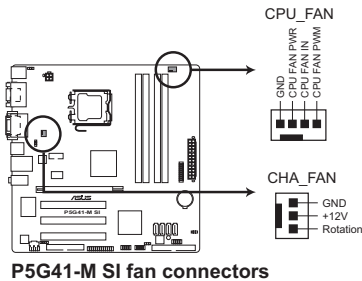

Only the 4-pin CPU fan connector supports the ASUS Q-FAN feature.

2. Serial ATA connectors (7-pin SATA1-4)

These connectors are for the Serial ATA signal cables for Serial ATA 3Gb/s hard disk and optical disk drives. The Serial ATA 3Gb/s is backward compatible with Serial ATA 1.5Gb/s specification. The data transfer rate of the Serial ATA 3Gb/s is faster than the standard parallel ATA with 133MB/s (Ultra DMA133).

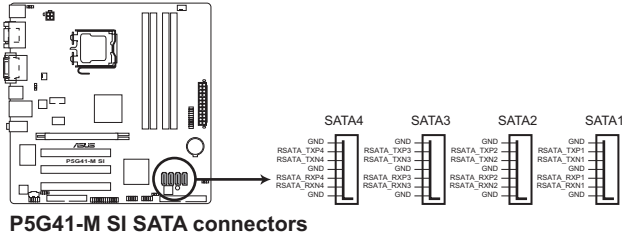

Install the Windows® XP Service Pack 2 or later version before using Serial ATA.

3. IDE connector (40-1 pin PRI_IDE)

The onboard IDE connector is for Ultra DMA 100/66/33 signal cable. There are three connectors on each Ultra DMA 100 / 66 / 33 signal cable: blue, black, and gray. Connect the blue connector to the motherboard's IDE connector, then select one of the following modes to configure your devices:

	Drive jumper setting	Mode of device(s)	Cable connector
Single device	Cable-Select or Master	-	Black
Two devices	Cable-Select	Master	Black
		Slave	Gray
	Master	Master	Black or gray
Slave	Slave		



- Pin 20 on the IDE connector is removed to match the covered hole on the Ultra DMA cable connector. This prevents incorrect insertion when you connect the IDE cable.
- Use the 80-conductor IDE cable for Ultra DMA 100/66/33 IDE devices.



If any device jumper is set as "Cable-Select", ensure that all other device jumpers have the same setting.

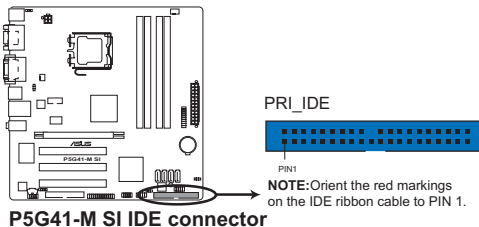

4. USB connectors (10-1 pin USB56, USB78)

These connectors are for USB 2.0 ports. Connect the USB module cable to any of these connectors, then install the module to a slot opening at the back of the system chassis. These USB connectors comply with the USB 2.0 specification that supports up to 480Mbps connection speed.

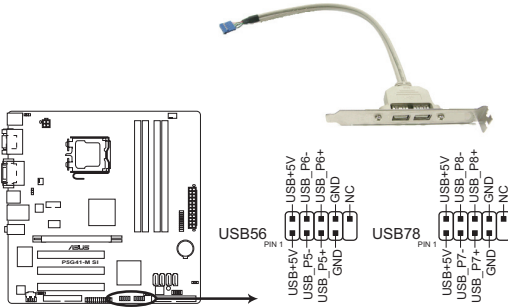

P5G41-M SI USB2.0 connectors



Never connect a 1394 cable to the USB connectors. Doing so will damage the motherboard!



The USB 2.0 module is purchased separately.

5. Serial port connectors (10-1 pin COM1)

The connector is for a serial (COM) port. Connect the serial port module cable to the connector, then install the module to a slot opening at the back of the system chassis.



The serial port bracket (COM1) is purchased separately.

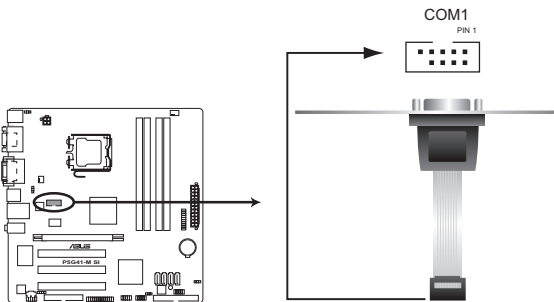

P5G41-M SI Serial port (COM1) connector

6. ATX power connectors (24-pin EATXPWR, 4-pin ATX12V)

These connectors are for an ATX power supply. The plugs from the power supply are designed to fit these connectors in only one orientation. Find the proper orientation and push down firmly until the connectors completely fit.

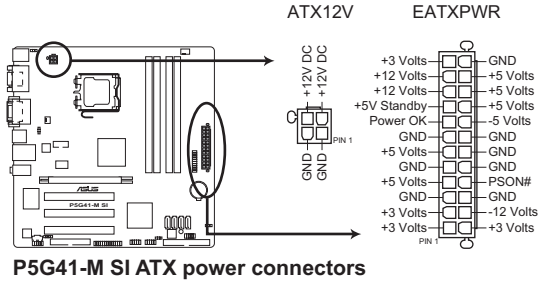

P5G41-M SI ATX power connectors



- We recommend that you use an ATX 12V Specification 2.0-compliant power supply unit (PSU) with a minimum of 300W power rating. This PSU type has 24-pin and 4-pin power plugs.
- If you intend to use a PSU with 20-pin and 4-pin power plugs, make sure that the 20-pin power plug can provide at least 15 A on +12 V and that the PSU has a minimum power rating of 300 W. The system may become unstable or may not boot up if the power is inadequate.
- DO NOT forget to connect the 4-pin ATX +12 V power plug; otherwise, the system will not boot up.
- We recommend that you use a PSU with higher power output when configuring a system with more power-consuming devices or when you intend to install additional devices. The system may become unstable or may not boot up if the power is inadequate.
- If you are uncertain about the minimum power supply requirement for your system, refer to the Recommended Power Supply Wattage Calculator at <http://support.asus.com/PowerSupplyCalculator/PSCalculator.aspx?SLanguage=en-us> for details.

7. Optical drive audio in connector (4-pin CD)

This connector allows you to receive stereo audio input from sound sources such as a CD-ROM, TV tuner, or MPEG card.

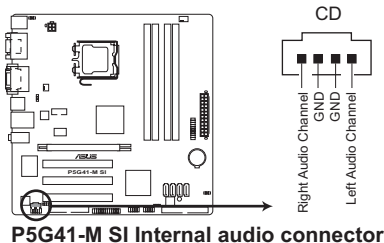

P5G41-M SI Internal audio connector

8. System panel connector (10-1 pin F_PANEL)

This connector supports several chassis-mounted functions.

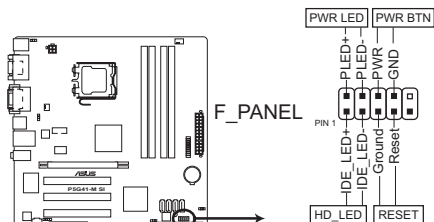

P5G41-M SI System panel connector

- **System power LED (2-pin PLED)**

This 2-pin connector is for the system power LED. Connect the chassis power LED cable to this connector. The system power LED lights up when you turn on the system power, and blinks when the system is in sleep mode.

- **Hard disk drive activity LED (2-pin +HDLED)**

This 2-pin connector is for the HDD Activity LED. Connect the HDD Activity LED cable to this connector. The IDE LED lights up or flashes when data is read from or written to the HDD.

- **Power/Soft-off button (2-pin PWRBTN)**

This 2-pin connector is for the system power button. Pressing the power button turns the system ON or puts the system in SLEEP or SOFT-OFF mode depending on the BIOS settings. Pressing the power switch for more than four seconds while the system is ON turns the system OFF.

- **Reset button (2-pin RESET)**

This 2-pin connector is for the chassis-mounted reset button for system reboot without turning off the system power.

9. TPM connector (20-1 pin TPM)

This connector supports a Trusted Platform Module (TPM) system, which can securely store keys, digital certificates, passwords, and data. A TPM system also helps enhance network security, protects digital identities, and ensures platform integrity.

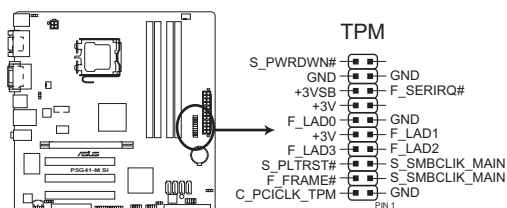

P5G41-M SI TPM Connector



The TPM module is purchased separately.

10. Digital audio connector (4-1 pin SPDIF_OUT)

This connector is for an additional Sony/Philips Digital Interface (S/PDIF) port.

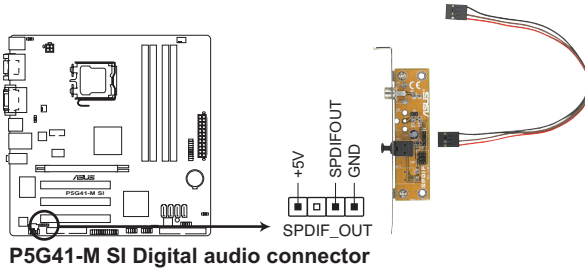

P5G41-M SI Digital audio connector



The S/PDIF module is purchased separately.

11. Front panel audio connector (10-1 pin AAFP)

This connector is for a chassis-mounted front panel audio I/O module that supports either High Definition Audio or AC'97 audio standard. Connect one end of the front panel audio I/O module cable to this connector.

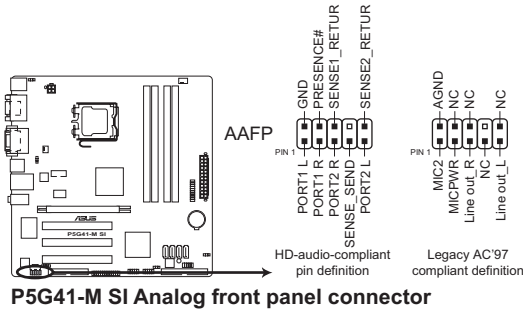

P5G41-M SI Analog front panel connector



If you want to connect a high-definition front panel audio module to this connector, ensure that the **Front Panel Type** item in the BIOS is set to **[HD Audio]**. If you want to connect an AC97 front panel audio module to this connector, set the item to **[AC97]**. See page 2-10 for details.

12. Floppy disk drive connector (34-1 pin FLOPPY)

This connector is for the provided floppy disk drive (FDD) signal cable. Insert one end of the cable to this connector, then connect the other end to the signal connector at the back of the floppy disk drive.



Pin 5 on the connector is removed to prevent incorrect cable connection when using a FDD cable with a covered Pin 5.

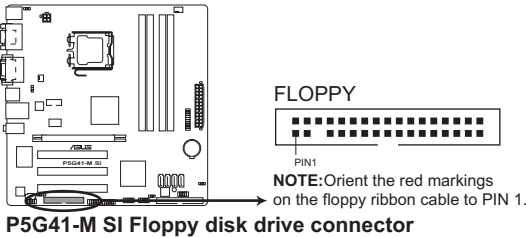

13. LPT connector (26-1 pin LPT)

The LPT (Line Printing Terminal) connector supports devices such as a printer. LPT standardizes as IEEE 1284, which is the parallel port interface on IBM PC-compatible computers.

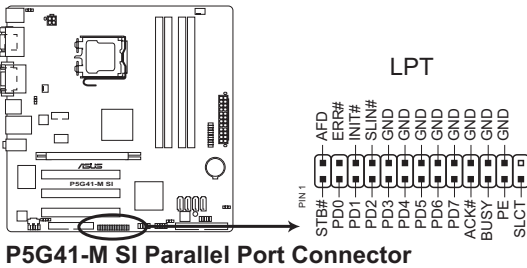

1.8 Software support

1.8.1 Installing an operating system

This motherboard supports Windows® XP/Vista Operating Systems (OS). Always install the latest OS version and corresponding updates to maximize the features of your hardware.



- Motherboard settings and hardware options vary. Refer to your OS documentation for detailed information.
- Ensure that you install Windows® XP Service Pack 3 or later versions / Windows® Vista Service Pack 1 or later versions before installing the drivers for better compatibility and system stability.

1.8.2 Support DVD information

The Support DVD that comes with the motherboard package contains drivers, software applications, and utilities that you can install to get all motherboard features.

To run the Support DVD

Place the Support DVD into the optical drive. The DVD automatically displays the **Drivers** menu if the Autorun function is enabled on your computer.



The contents of the Support DVD are subject to change at any time without notice. Visit the ASUS website at www.asus.com for updates.



Click an icon to display Support DVD/motherboard information

Click an item to install



If the Autorun function is NOT enabled on your computer, browse the contents of the Support DVD to locate the file **ASSETUP.EXE** from the **BIN** folder. Double-click **ASSETUP.EXE** to run the DVD.

Chapter 2

BIOS information

2.1 Managing and updating your BIOS



Save a copy of the original motherboard BIOS file to a USB flash disk in case you need to restore the BIOS in the future. Copy the original motherboard BIOS using the ASUS Update utility.

2.1.1 ASUS Update utility

The ASUS Update is a utility that allows you to manage, save, and update the motherboard BIOS in Windows® environment.



This utility is available in the support DVD that comes with the motherboard package.

Installing ASUS Update

To install ASUS Update:

1. Place the support DVD in the optical drive. The **Drivers** menu appears.
2. Click the **Utilities** tab, then click **ASUS Update**.
3. Follow the onscreen instructions to complete the installation.



Quit all Windows® applications before you update the BIOS using this utility.

Updating the BIOS

To update the BIOS:

1. From the Windows® desktop, click **Start > Programs > ASUS > ASUSUpdate > ASUSUpdate** to launch the ASUS Update utility.
2. From the dropdown list, select **Update BIOS from a file**, then click **Next**.
3. Locate the BIOS file from the **Open** window, then click **Open**.
4. Follow the onscreen instructions to complete the updating process.

2.1.2 ASUS EZ Flash 2 utility

The ASUS EZ Flash 2 feature allows you to update the BIOS without using an OS-based utility.

To update the BIOS using EZ Flash 2:

1. Insert the USB flash disk that contains the latest BIOS file to the USB port, then launch EZ Flash 2 in any of these two ways:
 - Press **<Alt> + <F2>** during POST to display the following:
 - Enter the BIOS setup program. Go to the **Tools** menu to select **EZ Flash 2** and press **<Enter>** to enable it.
Press **<Tab>** to switch between drives until the correct BIOS file is found.

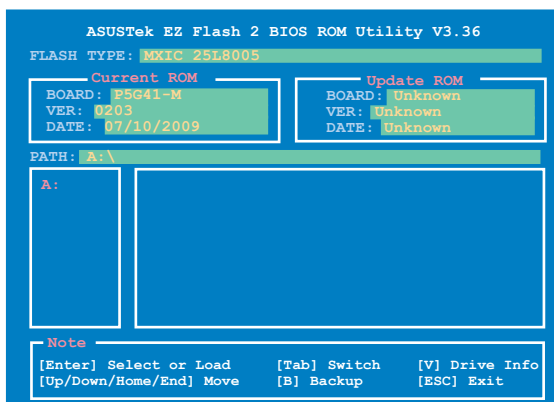

2. When the correct BIOS file is found, EZ Flash 2 performs the BIOS update process and automatically reboots the system when done.



- Only a USB flash disk with **FAT 32/16** format and single partition can support the ASUS EZ Flash 2 utility.
- Do not shut down or reset the system while updating the BIOS to prevent system boot failure!

2.1.3 ASUS CrashFree BIOS

The ASUS CrashFree BIOS is an auto recovery tool that allows you to restore the BIOS file when it fails or gets corrupted during the updating process. You can restore a corrupted BIOS file using the motherboard support DVD or a removable device that contains the updated BIOS file.



-
- Before using this utility, rename the BIOS file in the removable device into P5G41MSI.ROM.
 - The BIOS file in the support DVD may not be the latest version. Download the latest BIOS file from the ASUS website at www.asus.com.
 - The removable device that ASUS CrashFree BIOS support vary with motherboard models. For motherboards without the floppy connector, prepare a USB flash disk before using this utility.
-

Recovering the BIOS

To recover the BIOS:

1. Turn on the system.
2. Insert the support DVD to the optical drive or the removable device that contains the BIOS file to the USB port or to the floppy disk drive, if supported.
3. The utility automatically checks the devices for the BIOS file. When found, the utility reads the BIOS file and starts flashing the corrupted BIOS file.
4. Turn off the system after the utility completes the updating process and turn on again.



DO NOT shut down or reset the system while updating the BIOS! Doing so can cause system boot failure!



Ensure to load the BIOS default settings to ensure system compatibility and stability. Select the **Load Setup Defaults** item under the Exit menu. Refer to section **2.8 Exit Menu** for details.

2.2 BIOS setup program

This motherboard supports a programmable Serial Peripheral Interface (SPI) chip that you can update using the provided utility described in section “2.1 Managing and updating your BIOS.”

Use the BIOS Setup program when you are installing a motherboard, reconfiguring your system, or prompted to “Run Setup.” This section explains how to configure your system using this utility.

Even if you are not prompted to use the Setup program, you can change the configuration of your computer in the future. For example, you can enable the security password feature or change the power management settings. This requires you to reconfigure your system using the BIOS Setup program so that the computer can recognize these changes and record them in the CMOS RAM of the SPI chip.

The SPI chip on the motherboard stores the Setup utility. When you start up the computer, the system provides you with the opportunity to run this program. Press **<Ctrl>+<Alt>+** during the Power-On Self-Test (POST) to enter the Setup utility. Otherwise, POST continues with its test routines.

If you wish to enter Setup after POST, reboot the system by doing any of the following procedures:

- Restart using the OS standard shutdown procedure.
- Press **<Ctrl>+<Alt>+** simultaneously.
- Press the reset button on the system chassis.
- Press the power button to turn the system off then back on.



Using the **power button**, **reset button**, or the **<Ctrl>+<Alt>+** keys to force reset from a running operating system can cause damage to your data or system. We recommend to always shut down the system properly from the operating system.

The Setup program is designed to make it as easy to use as possible. Being a menu-driven program, it lets you scroll through the various submenus and make your selections from the available options using the navigation keys.



- The default BIOS settings for this motherboard apply for most conditions to ensure optimum performance. If the system becomes unstable after changing any BIOS settings, load the default settings to ensure system compatibility and stability. Select the **Load Setups Default** item under the Exit Menu. See section **2.8 Exit Menu**.
 - The BIOS setup screens shown in this section are for reference purposes only, and may not exactly match what you see on your screen.
 - Visit the ASUS website at www.asus.com to download the latest BIOS file for this motherboard.
-

2.2.1 BIOS menu screen

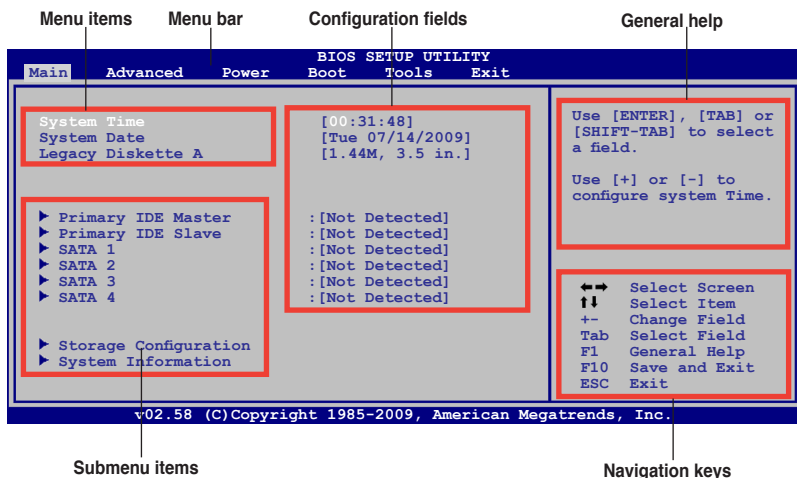

2.2.2 Menu bar

The menu bar on top of the screen has the following main items:

- Main** For changing the basic system configuration.
- Advanced** For changing the advanced system settings.
- Power** For changing the advanced power management (APM) configuration.
- Boot** For changing the system boot configuration.
- Tools** For configuring options for special functions.
- Exit** For selecting the exit options and loading default settings.

To select an item on the menu bar, press the right or left arrow key on the keyboard until the desired item is highlighted.

2.2.3 Navigation keys

At the bottom right corner of a menu screen are the navigation keys for that particular menu. Use the navigation keys to select items in the menu and change the settings.



Some of the navigation keys differ from one screen to another.

2.2.4 Menu items

The highlighted item on the menu bar displays the specific items for that menu. For example, selecting Main shows the Main menu items.

The other items (Advanced, Power, Boot, Tools, and Exit) on the menu bar have their respective menu items.

2.2.5 Submenu items

A solid triangle before each item on any menu screen means that the item has a submenu. To display the submenu, select the item and press <Enter>.

2.2.6 Configuration fields

These fields show the values for the menu items. If an item is user-configurable, you can change the value of the field opposite the item. You cannot select an item that is not user-configurable. A configurable field is enclosed in brackets, and is highlighted when selected. To change the value of a field, select it then press <Enter> to display a list of options. Refer to 2.2.7 Pop-up window.

2.2.7 Pop-up window

Select a menu item then press <Enter> to display a pop-up window with the configuration options for that item.

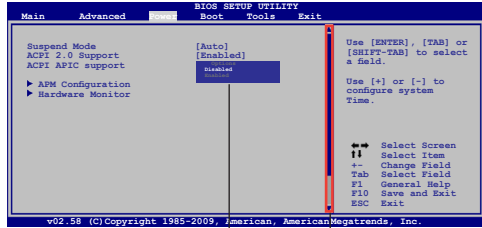

Pop-up window

Scroll bar

2.2.8 Scroll bar

A scroll bar appears on the right side of a menu screen when there are items that do not fit on the screen. Press the <Up> / <Down> arrow keys or <Page Up> / <Page Down> keys to display the other items on the screen.

2.2.9 General help

At the top right corner of the menu screen is a brief description of the selected item.

2.3 Main menu

When you enter the BIOS Setup program, the Main menu screen appears, giving you an overview of the basic system information.



Refer to section 2.2.1 BIOS menu screen for information on the menu screen items and how to navigate through them.

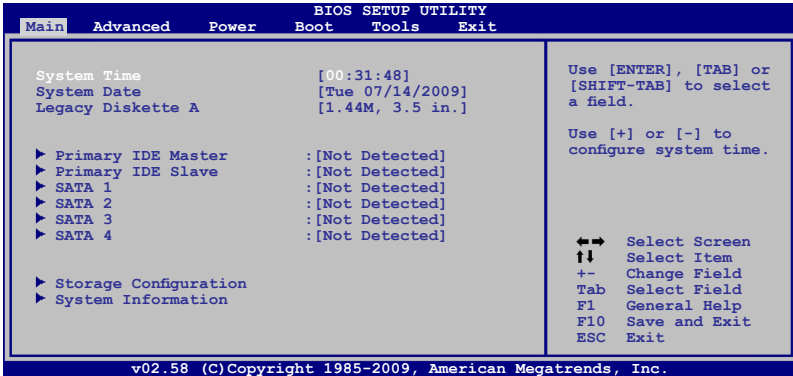

2.3.1 System Time [xx:xx:xx]

Allows you to set the system time.

2.3.2 System Date [Day xx/xx/xxxx]

Allows you to set the system date.

2.3.3 Legacy Diskette A [1.44M, 3.5 in.]

Sets the type of floppy drive installed. Configuration options: [Disabled] [360K, 5.25 in.] [1.2M, 5.25 in.] [720K, 3.5 in.] [1.44M, 3.5 in.] [2.88M, 3.5 in.]

2.3.4 Primary IDE Master/Slave and SATA 1-4

While entering Setup, the BIOS automatically detects the presence of IDE/SATA devices. There is a separate sub-menu for each IDE/SATA device. Select a device item then press <Enter> to display the IDE/SATA device information.

The BIOS automatically detects the values opposite the dimmed items (Device, Vendor, Size, LBA Mode, Block Mode, PIO Mode, Async DMA, Ultra DMA, and SMART Monitoring). These values are not user-configurable. These items show **Not Detected** if no IDE/ Serial ATA device is installed in the system.

Type [Auto]

Selects the type of IDE drive. Setting to [Auto] allows automatic selection of the appropriate IDE device type. Select [CDROM] if you are specifically configuring a CD-ROM drive. Select [ARMD] (ATAPI Removable Media Device) if your device is either a ZIP, LS-120, or MO drive. Configuration options: [Not Installed] [Auto] [CDROM] [ARMD]



This item does not appear if you select SATA 1/2/3/4 devices.

LBA/Large Mode [Auto]

Enables or disables the LBA mode. Setting to [Auto] enables the LBA mode if the device supports this mode, and if the device was not previously formatted with LBA mode disabled. Configuration options: [Disabled] [Auto]

Block (Multi-sector Transfer) M [Auto]

Enables or disables data multi-sectors transfers. When set to [Auto], the data transfer from and to the device occurs multiple sectors at a time if the device supports multi-sector transfer feature. When set to [Disabled], the data transfer from and to the device occurs one sector at a time. Configuration options: [Disabled] [Auto]

PIO Mode [Auto]

Selects the PIO mode. Configuration options: [Auto] [0] [1] [2] [3] [4]

DMA Mode [Auto]

Selects the DMA mode. Configuration options: [Auto]

SMART Monitoring [Auto]

Sets the Smart Monitoring, Analysis, and Reporting Technology. Configuration options: [Auto] [Disabled] [Enabled]

32Bit Data Transfer [Enabled]

Enables or disables 32-bit data transfer. Configuration options: [Disabled] [Enabled]

2.3.5 Storage Configuration

The items in this menu allow you to set or change the configurations for the SATA devices installed in the system. Select an item then press <Enter> if you want to configure the item.

ATA/IDE Configuration [Enhanced]

Allows you to set the ATA/IDE configuration. Configuration options: [Disabled] [Compatible] [Enhanced]



The following item appears only when you set the **ATA/IDE Configuration** item to **[Enhanced]**.

Enhanced Mode Support On [S-ATA]

Configuration options: [S-ATA+P-ATA] [S-ATA] [P-ATA]



The following item appears only when you set the **ATA/IDE Configuration** item to **[Compatible]**.

Legacy IDE Channels [PATA Pri, SATA Sec]

Configuration options: [SATA Only] [PATA Pri, SATA Sec] [PATA Only]

IDE Detect Time Out (Sec) [35]

Selects the time out value for detecting ATA/ATAPI devices.

Configuration options: [0] [5] [10] [15] [20] [25] [30] [35]

2.3.6 System Information

This menu gives you an overview of the general system specifications. The BIOS automatically detects the items in this menu.

Bios Information

Displays the auto-detected BIOS information.

Processor

Displays the auto-detected CPU specification.

System Memory

Displays the auto-detected system memory.

2.4 Advanced menu

The **Advanced** menu items allow you to change the settings for the CPU and other system devices.



Take caution when changing the settings of the Advanced menu items. Incorrect field values can cause the system to malfunction.

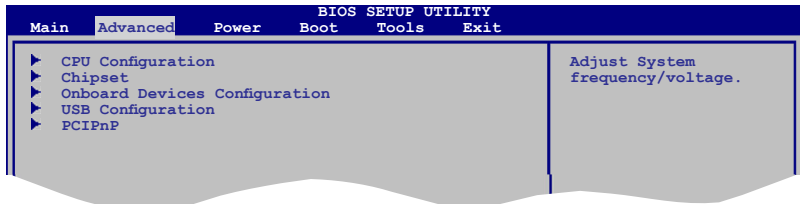

2.4.1 CPU Configuration

The items in this menu show the CPU-related information that the BIOS automatically detects.

Ratio CMOS Setting [Auto]

Sets the ratio between CPU core clock and the FSB frequency. Press <+> / <-> to adjust the value. Configuration options: [Auto] [06.0] [07.0]



If an invalid ratio is set in CMOS, then the actual and set values may differ.

C1E Support [Enabled]

Allows you to enable or disable C1E Support. Configuration options: [Disabled] [Enabled]

Max CPUID Value Limit [Disabled]

Setting this item to **[Enabled]** allows legacy operating systems to boot even without support for CPUs with extended CPUID functions. Configuration options: [Disabled] [Enabled]

Intel® Virtualization Tech [Enabled]

Enables or disables Intel® Virtualization Technology. Virtualization enhanced by Intel® Virtualization Technology allows a platform to run multiple operating systems and applications in independent partitions. With virtualization, one computer system can function as multiple virtual systems. Configuration options: [Enabled] [Disabled]

CPU TM function [Enabled]

Enables or disables Intel® CPU Thermal Monitor (TM) function, a CPU overheating protection function. When enabled, the CPU core frequency and voltage are reduced when the CPU overheats. Configuration options: [Disabled] [Enabled]

Execute-Disable Bit Capability [Enabled]

Allows you to enable or disable the No-Execution Page Protection Technology. Setting this item to **[Disabled]** forces the XD feature flag to always return to zero (0). Configuration options: [Disabled] [Enabled]



The following item appears only when you installed an Intel® CPU that supports the Enhanced Intel® SpeedStep® Technology (EIST).

Intel(R) SpeedStep(TM) Tech [Enabled]

Allows you to use the Enhanced Intel® SpeedStep® Technology. When set to [Enabled], you can adjust the system power settings in the operating system to use the EIST feature. Set this item to [Disabled] if you do not want to use the EIST. Configuration options: [Enabled] [Disabled]

2.4.2 Chipset

The **Chipset** menu allows you to change the advanced chipset settings. Select an item then press <Enter> to display the submenu.

North Bridge Configuration

Memory Remap Feature [Enabled]

Allows you to enable or disable the remapping of the overlapped PCI memory above the total physical memory. Enable this option only when you install 64-bit operating system. Configuration options: [Disabled] [Enabled]

Configure DRAM Timing by SPD [Enabled]

Allows you to enable or disable configuring the DRAM Timing by SPD. Configuration options: [Enabled] [Disabled]

Initiate Graphic Adapter [PEG/PCI]

Allows you to decide which graphics controller to use as the primary boot device. Configuration options: [IGD] [PCI/IGD] [PCI/PEG] [PEG/IGD] [PEG/PCI]

IGD Graphics Mode Select [Enabled, 32MB]

Sets the internal graphics mode. Configuration options: [Disabled] [Enabled, 32MB] [Enabled, 64MB] [Enabled, 128]

DVMT Memory [256MB]

Allows you to set the DVMT memory. Configuration options: [128MB] [256MB] [Maximum DVMT]

South Bridge Configuration

Audio Controller [Enabled]

Allows you to set the audio controller. Configuration options: [Enabled] [Disabled]

Front Panel Type [HD Audio]

Allows you to select the front panel support type. If High Definition Audio Front Panel used, please set HD Audio mode. Configuration options: [AC97] [HD Audio]

Onboard Gigabit LAN [Enabled]

Allows you to enable or disable the onboard LAN controller.

Configuration options: [Enabled] [Disabled]

Onboard LAN Boot ROM [Disabled]

Allows you to enable or disable the boot ROM in the onboard LAN controller. This item appears only when the Onboard LAN item is set to Enabled. Configuration options: [Disabled] [Enabled]

2.4.3 Onboard Devices Configuration

Serial Port1 Address [3F8/IRQ4]

Allows you to select the Serial Port1 base address.

Configuration options: [Disabled] [3F8/IRQ4] [3E8/IRQ4] [2E8/IRQ3]

Serial Port1 Mode [Normal]

Allows you to select the Serial Port1 mode.

Configuration options: [Normal] [IrDA] [ASK IR]

Serial Port2 Address [2F8/IRQ3]

Allows you to select the Serial Port2 base address.

Configuration options: [Disabled] [2F8/IRQ3] [3E8/IRQ4] [2E8/IRQ3]

Serial Port2 Mode [Normal]

Allows you to select the Serial Port2 mode.

Configuration options: [Normal] [IrDA] [ASK IR]

2.4.4 USB Configuration

The items in this menu allows you to change the USB-related features. Select an item then press **<Enter>** to display the configuration options.



The Module Version and USB Devices Enabled items show the auto-detected values. If no USB device is detected, the item shows **None**.

USB Functions [Enabled]

Allows you to disable or enable the USB functions. Configuration options: [Disabled] [Enabled]

USB 2.0 Controller [Enabled]

Allows you to enable or disable USB 2.0 controller.

Configuration options: [Enabled] [Disabled]

Legacy USB Support [Auto]

Allows you to enable or disable support for Legacy USB storage devices, including USB flash drives and USB hard drives. Setting to **[Auto]** allows the system to detect the presence of USB devices at startup. If detected, the USB controller legacy mode is enabled. If no USB device is detected, the legacy USB support is disabled. Configuration options: [Disabled] [Enabled] [Auto]

USB 2.0 Controller Mode [HiSpeed]

Allows you to configure the USB 2.0 controller in HiSpeed (480Mbps) or Full Speed (12Mbps). Configuration options: [FullSpeed] [HiSpeed]



The following items may only appear when a USB storage device is plugged.

USB Mass Storage Device Configuration

USB Mass Storage Reset Delay [20 Sec]

Allows you to set the maximum time that the BIOS waits for the USB storage device to initialize. Configuration options: [10 Sec] [20 Sec] [30 Sec] [40 Sec]

Emulation Type [Auto]

Allows you to set the emulation type. Configuration options: [Auto] [Floppy] [Forced FDD] [Hard Disk] [CDROM]

2.4.5 PCI PnP

The PCI PnP menu items allow you to change the advanced settings for PCI/PnP devices. The menu includes setting IRQ and DMA channel resources for either PCI/PnP or legacy ISA devices, and setting the memory size block for legacy ISA devices.



Take caution when changing the settings of the PCI PnP menu items. Incorrect field values can cause the system to malfunction.

Plug and Play O/S [No]

When set to [No], BIOS configures all the devices in the system. When set to [Yes] and if you install a Plug and Play operating system, the operating system configures the Plug and Play devices not required for boot. Configuration options: [No] [Yes]

2.5 Power menu

The Power menu items allow you to change the settings for the Advanced Power Management (APM). Select an item then press <Enter> to display the configuration options.

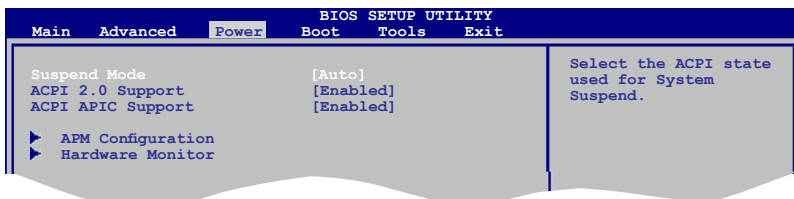

2.5.1 Suspend Mode [Auto]

Allows you to select the Advanced Configuration and Power Interface (ACPI) state to be used for system suspend. Configuration options: [S1 (POS) Only] [S3 Only] [Auto]

[S1(POS) Only] - Enables the system to enter the ACPI S1 (Power on Suspend) sleep state. In S1 sleep state, the system appears suspended and stays in a low power mode. The system can be resumed at any time.

[S3 Only] - Enables the system to enter the ACPI S3 (Suspend to RAM) sleep state (default). In S3 sleep state, the system appears to be off and consumes less power than in the S1 state. When signaled by a wake-up device or event, the system resumes to its working state exactly where it was left off.

[Auto] - Detected by OS.

2.5.2 ACPI 2.0 Support [Enabled]

Allows you to add more tables for Advanced Configuration and Power Interface (ACPI) 2.0 specifications. Configuration options: [Disabled] [Enabled]

2.5.3 ACPI APIC Support [Enabled]

Allows you to enable or disable the Advanced Configuration and Power Interface (ACPI) support in the Application-Specific Integrated Circuit (ASIC). When set to Enabled, the ACPI APIC table pointer is included in the RSDT pointer list. Configuration options: [Disabled] [Enabled]

2.5.4 APM Configuration

Restore on AC Power Loss [Power Off]

When set to **[Power Off]**, the system goes into off state after an AC power loss. When set to **[Power On]**, the system goes on after an AC power loss. When set to **[Last State]**, the system goes into either off or on state, whatever the system state was before the AC power loss. Configuration options: [Power Off] [Power On] [Last State]

Power On By RTC Alarm [Disabled]

Allows you to enable or disable RTC to generate a wake event. When this item is set to Enabled, the items RTC Alarm Date, RTC Alarm Hour, RTC Alarm Minute, and RTC Alarm Second appear with set values. Configuration options: [Disabled] [Enabled]

Power On By External Modem [Disabled]

This allows either settings of [Enabled] or [Disabled] for powering up the computer when the external modem receives a call while the computer is in Soft-off mode. Configuration options: [Disabled] [Enabled]

Power On By PCI (E) Devices [Disabled]

When set to [Enabled], this parameter allows you to wake the system through a PCI Express/PCI card. This feature requires an ATX power supply that provides at least 1A on the +5VSB lead. Configuration options: [Disabled] [Enabled]

Power On By PS/2 Keyboard [Disabled]

Allows you to use specific keys on the keyboard to turn on the system. This feature requires an ATX power supply that provides at least 1A on the +5VSB lead. Configuration options: [Disabled] [Space Bar] [Ctrl-Esc] [Power Key]

Power On By PS/2 Mouse [Disabled]

When set to [Enabled], this parameter allows you to use the PS/2 mouse to turn on the system. This feature requires an ATX power supply that provides at least 1A on the +5VSB lead. Configuration options: [Disabled] [Enabled]

2.5.5 Hardware Monitor

CPU Temperature [xxx°C/xxx°F] or [Ignored]

MB Temperature [xxx°C/xxx°F] or [Ignored]

The onboard hardware monitor automatically detects and displays the motherboard and CPU temperatures. Select **Ignored** if you do not wish to display the detected temperatures.

CPU Fan Speed [xxxxRPM] or [Ignored]

The onboard hardware monitor automatically detects and displays the CPU fan speed in rotations per minute (RPM). If the fan is not connected to the motherboard, the field shows **N/A**. Select **Ignored** if you do not wish to display the detected speed.

Chassis Fan Speed [xxxxRPM] or [Ignored]

The onboard hardware monitor automatically detects and displays the chassis fan speed in rotations per minute (RPM). If the fan is not connected to the motherboard, the field shows **N/A**. Select **Ignored** if you do not wish to display the detected speed.

CPU Over Voltage, 3.3V Voltage, 5V Voltage, 12V Voltage [xxxV] or [Ignored]

The onboard hardware monitor automatically detects the voltage output through the onboard voltage regulators.

CPU Q-Fan Function [Disabled]

Allows you to enable or disable the CPU Q-Fan function. Configuration options: [Disabled] [Enabled]

2.6 Boot menu

The **Boot** menu items allow you to change the system boot options. Select an item then press **<Enter>** to display the sub-menu.

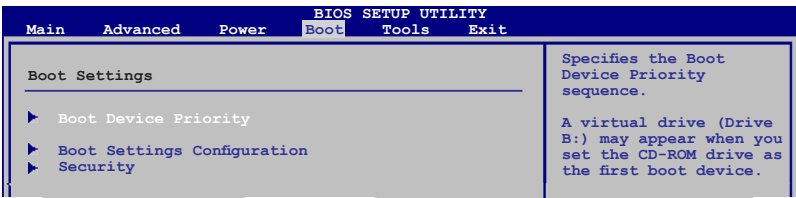

2.6.1 Boot Device Priority

1st/2nd/3rd Boot Device

These items specify the boot device priority sequence from the available devices. The number of device items that appears on the screen depends on the number of devices installed in the system. Configuration options: [Removable Dev.] [Hard Drive] [ATAPI CD-ROM] [Disabled]



- To select the boot device during system startup, press **<F8>** when ASUS Logo appears.
- To access Windows® OS in Safe Mode, do any of the following:
 - Press **<F5>** when ASUS Logo appears.
 - Press **<F8>** after POST.

2.6.2 Boot Settings Configuration

Quick Boot [Enabled]

Enabling this item allows the BIOS to skip some power on self tests (POST) while booting to decrease the time needed to boot the system. When set to **[Disabled]**, BIOS performs all the POST items. Configuration options: [Disabled] [Enabled]

Full Screen Logo [Enabled]

This allows you to enable or disable the full screen logo display feature. Configuration options: [Disabled] [Enabled]



Set this item to **[Enabled]** to use the ASUS MyLogo2™ feature.

AddOn ROM Display Mode [Force BIOS]

Sets the display mode for option ROM. Configuration options: [Force BIOS] [Keep Current]

Bootup Num-Lock [On]

Allows you to select the power-on state for the NumLock. Configuration options: [Off] [On]

Wait For 'F1' If Error [Enabled]

When set to **Enabled**, the system waits for the F1 key to be pressed when error occurs.
Configuration options: [Disabled] [Enabled]

Hit 'DEL' Message Display [Enabled]

When set to **[Enabled]**, the system displays the message **Press DEL to run Setup** during POST. Configuration options: [Disabled] [Enabled]

2.6.3 Security

The **Security** menu items allow you to change the system security settings. Select an item then press **<Enter>** to display the configuration options.

Change Supervisor Password

Select this item to set or change the supervisor password. The **Supervisor Password** item on top of the screen shows the default **Not Installed**. After you set a password, this item shows **Installed**.

To set a Supervisor Password:

1. Select the **Change Supervisor Password** item and press **<Enter>**.
2. On the password box, key in a password containing up to six letters, or numbers, or both, then press **<Enter>**.
3. Confirm the password when prompted.

The message **Password Installed** appears after you successfully set your password.
To change the supervisor password, follow the same steps in setting a supervisor password.
To clear the supervisor password, select the **Change Supervisor Password** then press **<Enter>** twice. The message **Password uninstalled** appears.



If you forget your BIOS password, you can clear it by erasing the CMOS Real Time Clock (RTC) RAM. See section 1.6 Jumpers for information on how to erase the RTC RAM.

After you have set a supervisor password, the other items appear to allow you to change other security settings.

User Access Level [Full Access]

This item allows you to select the access restriction to the Setup items.
Configuration options: [No Access] [View Only] [Limited] [Full Access]

[No Access] - prevents user access to the Setup utility.

[View Only] - allows access but does not allow change to any field.

[Limited] - allows changes only to selected fields, such as Date and Time.

[Full Access] - allows viewing and changing all the fields in the Setup utility.

Change User Password

Select this item to set or change the user password. The **User Password** item on top of the screen shows the default **Not Installed**. After you set a password, this item shows **Installed**.

To set a User Password:

1. Select the **Change User Password** item and press **<Enter>**.
2. On the password box, key in a password containing up to six letters, or numbers, or both, then press **<Enter>**.
3. Confirm the password when prompted.

The message **Password Installed** appears after you set your password successfully. To change the user password, follow the same steps in setting a user password.

Clear User Password

Select this item to clear the user password.

Password Check [Setup]

When set to **[Setup]**, BIOS checks for user password when accessing the Setup utility. When set to **[Always]**, BIOS checks for user password both when accessing Setup and booting the system. Configuration options: [Setup] [Always]

2.7 Tools menu

The Tools menu items allow you to configure options for special functions. Select an item then press **<Enter>** to display the sub-menu.

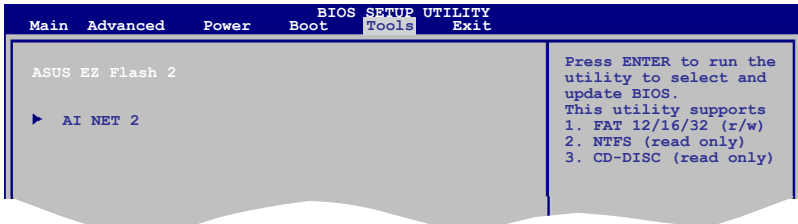

2.7.1 ASUS EZ Flash 2

Allows you to run ASUS EZ Flash 2. When you press **<Enter>**, a confirmation message appears. Use the left/right arrow key to select between **[Yes]** or **[No]**, then press **<Enter>** to confirm your choice. Please see section 2.1.2 for details.

2.7.2 AI NET 2

Check Realtek LAN cable [Disabled]

Enables or disables checking of the Realtek LAN cable during the Power-On Self-Test (POST). Configuration options: [Disabled] [Enabled]

2.8 Exit menu

The Exit menu items allow you to load the optimal or failsafe default values for the BIOS items, and save or discard your changes to the BIOS items.

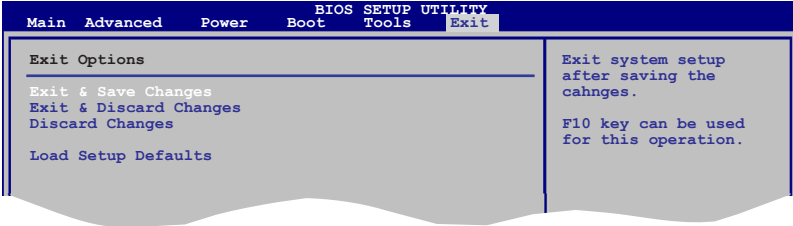

Pressing **<Esc>** does not immediately exit this menu. Select one of the options from this menu or **<F10>** from the legend bar to exit.

Exit & Save Changes

Once you are finished making your selections, choose this option from the Exit menu to ensure the values you selected are saved to the CMOS RAM. An onboard backup battery sustains the CMOS RAM so it stays on even when the PC is turned off. When you select this option, a confirmation window appears. Select **OK** to save changes and exit.

Exit & Discard Changes

Select this option only if you do not want to save the changes that you made to the Setup program. If you made changes to fields other than System Date, System Time, and Password, the BIOS asks for a confirmation before exiting.

Discard Changes

This option allows you to discard the selections you made and restore the previously saved values. After selecting this option, a confirmation appears. Select **OK** to discard any changes and load the previously saved values.

Load Setup Defaults

This option allows you to load the default values for each of the parameters on the Setup menu. When you select this option or if you press **<F5>**, a confirmation window appears. Select **OK** to load default values. Select **Exit & Save Changes** or make other changes before saving the values to the non-volatile RAM.