

**P5Q PRO**

**ASUS**<sup>®</sup>

**Motherboard**

E4427

Third Edition V3

December 2008

**Copyright © 2008 ASUSTeK COMPUTER INC. All Rights Reserved.**

No part of this manual, including the products and software described in it, may be reproduced, transmitted, transcribed, stored in a retrieval system, or translated into any language in any form or by any means, except documentation kept by the purchaser for backup purposes, without the express written permission of ASUSTeK COMPUTER INC. ("ASUS").

Product warranty or service will not be extended if: (1) the product is repaired, modified or altered, unless such repair, modification or alteration is authorized in writing by ASUS; or (2) the serial number of the product is defaced or missing.

ASUS PROVIDES THIS MANUAL "AS IS" WITHOUT WARRANTY OF ANY KIND, EITHER EXPRESS OR IMPLIED, INCLUDING BUT NOT LIMITED TO THE IMPLIED WARRANTIES OR CONDITIONS OF MERCHANTABILITY OR FITNESS FOR A PARTICULAR PURPOSE. IN NO EVENT SHALL ASUS, ITS DIRECTORS, OFFICERS, EMPLOYEES OR AGENTS BE LIABLE FOR ANY INDIRECT, SPECIAL, INCIDENTAL, OR CONSEQUENTIAL DAMAGES (INCLUDING DAMAGES FOR LOSS OF PROFITS, LOSS OF BUSINESS, LOSS OF USE OR DATA, INTERRUPTION OF BUSINESS AND THE LIKE), EVEN IF ASUS HAS BEEN ADVISED OF THE POSSIBILITY OF SUCH DAMAGES ARISING FROM ANY DEFECT OR ERROR IN THIS MANUAL OR PRODUCT.

SPECIFICATIONS AND INFORMATION CONTAINED IN THIS MANUAL ARE FURNISHED FOR INFORMATIONAL USE ONLY, AND ARE SUBJECT TO CHANGE AT ANY TIME WITHOUT NOTICE, AND SHOULD NOT BE CONSTRUED AS A COMMITMENT BY ASUS. ASUS ASSUMES NO RESPONSIBILITY OR LIABILITY FOR ANY ERRORS OR INACCURACIES THAT MAY APPEAR IN THIS MANUAL, INCLUDING THE PRODUCTS AND SOFTWARE DESCRIBED IN IT.

Products and corporate names appearing in this manual may or may not be registered trademarks or copyrights of their respective companies, and are used only for identification or explanation and to the owners' benefit, without intent to infringe.

# Contents

Contents .....	iii
Notices.....	vii
Safety information .....	viii
About this guide .....	ix
P5Q PRO specifications summary.....	xi
<b>Chapter 1: Product introduction</b>	
1.1 Welcome! .....	1-1
1.2 Package contents.....	1-1
1.3 Special features.....	1-2
1.3.1 Product highlights .....	1-2
1.3.2 ASUS unique features .....	1-4
1.3.3 ASUS Exclusive Overclocking Features .....	1-7
<b>Chapter 2: Hardware information</b>	
2.1 Before you proceed .....	2-1
2.2 Motherboard overview.....	2-2
2.2.1 Motherboard layout.....	2-2
2.2.2 Layout contents.....	2-3
2.2.3 Placement direction .....	2-4
2.2.4 Screw holes .....	2-4
2.3 Central Processing Unit (CPU) .....	2-5
2.3.1 Installing the CPU .....	2-5
2.3.2 Installing the CPU heatsink and fan .....	2-8
2.3.3 Uninstalling the CPU heatsink and fan .....	2-9
2.4 System memory .....	2-10
2.4.1 Overview .....	2-10
2.4.2 Memory configurations.....	2-11
2.4.3 Installing a DDR2 DIMM .....	2-16
2.4.4 Removing a DDR2 DIMM .....	2-16
2.5 Expansion slots.....	2-17
2.5.1 Installing an expansion card .....	2-17
2.5.2 Configuring an expansion card .....	2-17
2.5.3 Interrupt assignments .....	2-18
2.5.4 PCI slots.....	2-19
2.5.5 PCI Express x1 slots.....	2-19
2.5.6 PCI Express 2.0 x16 slot.....	2-19
2.6 Jumper .....	2-20

# Contents

<b>2.7</b>	<b>Connectors</b> .....	<b>2-23</b>
2.7.1	Rear panel connectors.....	2-23
2.7.2	Internal connectors .....	2-25
<b>2.8</b>	<b>Starting up for the first time</b> .....	<b>2-37</b>
<b>2.9</b>	<b>Turning off the computer</b> .....	<b>2-38</b>
2.9.1	Using the OS shut down function.....	2-38
2.9.2	Using the dual function power switch.....	2-38
 <b>Chapter 3: BIOS setup</b>		
<b>3.1</b>	<b>Managing and updating your BIOS</b> .....	<b>3-1</b>
3.1.1	ASUS Update utility .....	3-1
3.1.2	ASUS EZ Flash 2 utility.....	3-4
3.1.3	AFUDOS utility.....	3-5
3.1.4	ASUS CrashFree BIOS 3 utility .....	3-7
<b>3.2</b>	<b>BIOS setup program</b> .....	<b>3-8</b>
3.2.1	BIOS menu screen.....	3-9
3.2.2	Menu bar.....	3-9
3.2.3	Navigation keys.....	3-9
3.2.4	Menu items .....	3-10
3.2.5	Sub-menu items.....	3-10
3.2.6	Configuration fields .....	3-10
3.2.7	Pop-up window .....	3-10
3.2.8	Scroll bar.....	3-10
3.2.9	General help .....	3-10
<b>3.3</b>	<b>Main menu</b> .....	<b>3-11</b>
3.3.1	System Time [xx:xx:xx] .....	3-11
3.3.2	System Date [Day xx/xx/xxxx].....	3-11
3.3.3	Legacy Diskette A [1.44M, 3.5 in.] .....	3-11
3.3.4	Language [English] .....	3-11
3.3.5	SATA 1-6 .....	3-12
3.3.6	Storage Configuration .....	3-13
3.3.7	AHCI Configuration .....	3-14
3.3.8	System Information .....	3-15
<b>3.4</b>	<b>Ai Tweaker menu</b> .....	<b>3-16</b>
3.4.1	Ai Overclock Tuner [Auto] .....	3-16
3.4.2	CPU Ratio Setting [Auto] .....	3-17
3.4.3	FSB Strap to North Bridge [Auto].....	3-17
3.4.4	DRAM Frequency [Auto].....	3-17

# Contents

3.4.5	DRAM Timing Control [Auto] .....	3-18
3.4.6	DRAM Static Read Control [Auto] .....	3-19
3.4.7	DRAM Read Training [Auto] .....	3-20
3.4.8	MEM. OC Charger .....	3-20
3.4.9	Ai Clock Twister [Auto] .....	3-20
3.4.10	Ai Transaction Booster [Auto] .....	3-20
3.4.11	CPU Voltage [Auto] .....	3-21
3.4.12	CPU PLL Voltage [Auto] .....	3-21
3.4.13	FSB Termination Voltage [Auto] .....	3-21
3.4.14	DRAM Voltage [Auto] .....	3-21
3.4.15	NB Voltage [Auto] .....	3-21
3.4.16	SB Voltage [Auto] .....	3-22
3.4.17	PCIe SATA Voltage [Auto] .....	3-22
3.4.18	Load-Line Calibration [Auto] .....	3-22
3.4.19	CPU Spread Spectrum [Auto] .....	3-22
3.4.20	PCIe Spread Spectrum [Auto] .....	3-22
<b>3.5</b>	<b>Advanced menu .....</b>	<b>3-23</b>
3.5.1	TPM Configuration .....	3-23
3.5.2	CPU Configuration .....	3-24
3.5.3	Chipset .....	3-26
3.5.4	Onboard Device Configuration .....	3-27
3.5.5	USB Configuration .....	3-29
3.5.6	PCIe PnP .....	3-30
<b>3.6</b>	<b>Power menu .....</b>	<b>3-31</b>
3.6.1	Suspend Mode [Auto] .....	3-31
3.6.2	Repost Video on S3 Resume [No] .....	3-31
3.6.3	ACPI 2.0 Support [Disabled] .....	3-31
3.6.4	ACPI APIC Support [Enabled] .....	3-31
3.6.5	APM Configuration .....	3-32
3.6.6	Hardware Monitor .....	3-33
<b>3.7</b>	<b>Boot menu .....</b>	<b>3-35</b>
3.7.1	Boot Device Priority .....	3-35
3.7.2	Boot Settings Configuration .....	3-36
3.7.3	Security .....	3-37
<b>3.8</b>	<b>Tools menu .....</b>	<b>3-39</b>
3.8.1	ASUS EZ Flash 2 .....	3-39
3.8.2	Drive Xpert .....	3-40

# Contents

3.8.3	Express Gate .....	3-41
3.8.4	ASUS O.C. Profile.....	3-42
3.8.5	AI NET 2.....	3-43
<b>3.9</b>	<b>Exit menu.....</b>	<b>3-44</b>
<b>Chapter 4: Software support</b>		
<b>4.1</b>	<b>Installing an operating system .....</b>	<b>4-1</b>
<b>4.2</b>	<b>Support DVD information .....</b>	<b>4-1</b>
4.2.1	Running the support DVD .....	4-1
4.2.2	Drivers menu.....	4-2
4.2.3	Utilities menu .....	4-3
4.2.4	Make disk menu.....	4-5
4.2.5	Manual menu .....	4-6
4.2.6	ASUS Contact information .....	4-6
4.2.7	Other information .....	4-7
<b>4.3</b>	<b>Software information .....</b>	<b>4-9</b>
4.3.1	ASUS MyLogo2™ .....	4-9
4.3.2	AI NET2 .....	4-11
4.3.3	ASUS PC Probe II.....	4-12
4.3.4	ASUS AI Suite.....	4-18
4.3.5	ASUS AI Nap .....	4-20
4.3.6	ASUS Fan Xpert .....	4-21
4.3.7	ASUS AI Booster.....	4-23
4.3.8	ASUS EPU—6 Engine .....	4-24
4.3.9	ASUS AI Direct Link.....	4-28
4.3.10	ASUS Drive Xpert .....	4-30
4.3.11	ASUS Express Gate .....	4-41
<b>4.4</b>	<b>RAID configurations .....</b>	<b>4-51</b>
4.4.1	RAID definitions .....	4-51
4.4.2	Installing Serial ATA hard disks .....	4-52
4.4.3	Intel® RAID configurations.....	4-52
<b>4.5</b>	<b>Creating a RAID driver disk.....</b>	<b>4-60</b>
4.5.1	Creating a RAID driver disk without entering the OS....	4-60
4.5.2	Creating a RAID driver disk in Windows® .....	4-60
<b>Appendix: CPU features</b>		
<b>A.1</b>	<b>Intel® EM64T.....</b>	<b>A-1</b>
<b>A.2</b>	<b>Enhanced Intel SpeedStep® Technology (EIST).....</b>	<b>A-1</b>
<b>A.3</b>	<b>Intel® Hyper-Threading Technology .....</b>	<b>A-3</b>

# Notices

## Federal Communications Commission Statement

This device complies with Part 15 of the FCC Rules. Operation is subject to the following two conditions:

- This device may not cause harmful interference, and
- This device must accept any interference received including interference that may cause undesired operation.

This equipment has been tested and found to comply with the limits for a Class B digital device, pursuant to Part 15 of the FCC Rules. These limits are designed to provide reasonable protection against harmful interference in a residential installation. This equipment generates, uses and can radiate radio frequency energy and, if not installed and used in accordance with manufacturer's instructions, may cause harmful interference to radio communications. However, there is no guarantee that interference will not occur in a particular installation. If this equipment does cause harmful interference to radio or television reception, which can be determined by turning the equipment off and on, the user is encouraged to try to correct the interference by one or more of the following measures:

- Reorient or relocate the receiving antenna.
- Increase the separation between the equipment and receiver.
- Connect the equipment to an outlet on a circuit different from that to which the receiver is connected.
- Consult the dealer or an experienced radio/TV technician for help.



---

The use of shielded cables for connection of the monitor to the graphics card is required to assure compliance with FCC regulations. Changes or modifications to this unit not expressly approved by the party responsible for compliance could void the user's authority to operate this equipment.

---

## Canadian Department of Communications Statement

This digital apparatus does not exceed the Class B limits for radio noise emissions from digital apparatus set out in the Radio Interference Regulations of the Canadian Department of Communications.

This class B digital apparatus complies with Canadian ICES-003.

# Safety information

## Electrical safety

- To prevent electrical shock hazard, disconnect the power cable from the electrical outlet before relocating the system.
- When adding or removing devices to or from the system, ensure that the power cables for the devices are unplugged before the signal cables are connected. If possible, disconnect all power cables from the existing system before you add a device.
- Before connecting or removing signal cables from the motherboard, ensure that all power cables are unplugged.
- Seek professional assistance before using an adapter or extension cord. These devices could interrupt the grounding circuit.
- Make sure that your power supply is set to the correct voltage in your area. If you are not sure about the voltage of the electrical outlet you are using, contact your local power company.
- If the power supply is broken, do not try to fix it by yourself. Contact a qualified service technician or your retailer.

## Operation safety

- Before installing the motherboard and adding devices on it, carefully read all the manuals that came with the package.
- Before using the product, make sure all cables are correctly connected and the power cables are not damaged. If you detect any damage, contact your dealer immediately.
- To avoid short circuits, keep paper clips, screws, and staples away from connectors, slots, sockets and circuitry.
- Avoid dust, humidity, and temperature extremes. Do not place the product in any area where it may become wet.
- Place the product on a stable surface.
- If you encounter technical problems with the product, contact a qualified service technician or your retailer.



---

This symbol of the crossed out wheeled bin indicates that the product (electrical, electronic equipment and mercury-containing button cell battery) should not be placed in municipal waste. Check local regulations for disposal of electronic products.

---



# About this guide

This user guide contains the information you need when installing and configuring the motherboard.

## How this guide is organized

This guide contains the following parts:

- **Chapter 1: Product introduction**  
This chapter describes the features of the motherboard and the new technology it supports.
- **Chapter 2: Hardware information**  
This chapter lists the hardware setup procedures that you have to perform when installing system components. It includes description of the switches, jumpers, and connectors on the motherboard.
- **Chapter 3: BIOS setup**  
This chapter tells how to change system settings through the BIOS Setup menu. Detailed descriptions of the BIOS parameters are also provided.
- **Chapter 4: Software support**  
This chapter describes the contents of the support CD that comes with the motherboard package and the software.
- **Appendix: CPU features**  
The Appendix describes the CPU features and technologies that the motherboard supports.

## Where to find more information

Refer to the following sources for additional information and for product and software updates.

1. **ASUS websites**  
The ASUS website provides updated information on ASUS hardware and software products. Refer to the ASUS contact information.
2. **Optional documentation**  
Your product package may include optional documentation, such as warranty flyers, that may have been added by your dealer. These documents are not part of the standard package.

## Conventions used in this guide

To make sure that you perform certain tasks properly, take note of the following symbols used throughout this manual.



**DANGER/WARNING:** Information to prevent injury to yourself when trying to complete a task.



**CAUTION:** Information to prevent damage to the components when trying to complete a task.



**IMPORTANT:** Instructions that you **MUST** follow to complete a task.



**NOTE:** Tips and additional information to help you complete a task.

## Typography

**Bold text**

Indicates a menu or an item to select.

*Italics*

Used to emphasize a word or a phrase.

<Key>

Keys enclosed in the less-than and greater-than sign means that you must press the enclosed key.

Example: <Enter> means that you must press the Enter or Return key.

<Key1+Key2+Key3>

If you must press two or more keys simultaneously, the key names are linked with a plus sign (+).

Example: <Ctrl+Alt+D>

**Command**

Means that you must type the command exactly as shown, then supply the required item or value enclosed in brackets.

Example: At the DOS prompt, type the command line:

```
afudos /i[filename]
```

```
afudos /iP5QPRO.ROM
```

# P5Q PRO

## specifications summary

<b>CPU</b>	LGA775 socket for Intel® Core™2 Extreme/Core™2 Quad/ Core™2 Duo/Pentium® dual-core/Celeron® dual-core /Celeron® Processors Compatible with Intel® 05B/05A/06 processors Support Intel® 45nm Multi-Core CPU * Refer to <a href="http://www.asus.com">www.asus.com</a> for Intel CPU support list
<b>Chipset</b>	Intel® P45 / ICH10R
<b>System Bus</b>	1600 / 1333 / 1066 / 800 MHz
<b>Memory</b>	4 x DIMM, max. 16GB, DDR2 1200 / 1066 / 800 / 667 MHz, non-ECC, un-buffered memory Dual channel memory architecture * Refer to <a href="http://www.asus.com">www.asus.com</a> for the Memory QVL (Qualified Vendors Lists). ** Due to OS limitation, when installing total memory of 4GB capacity or more, Windows® 32-bit operation system may only recognize less than 3GB. Hence, a total installed memory of less than 3GB is recommended.
<b>Expansion Slots</b>	2 x PCIe 2.0 x16, support ATI CrossFireX™ technology dual at x 8 link(blue) (PCIe x16_1 blue, PCIe x16_2 black*) 3 x PCIe x1 2 x PCI * PCIe x16 slot (black at max. x8 link)
<b>Storage</b>	Intel® ICH10R Southbridge - 6 x SATA 3Gb/s ports - Intel® Matrix Storage, supporting SATA RAID 0,1, 5 and 10 Marvell® 88SE6111 PATA controller - 1 x UltraDMA 133/100/66 for up to 2 PATA devices Silicon Image® SiI5723 (Drive Xpert Technology) - 2 x SATA 3 Gb/s ports - Supports EZ Backup and SuperSpeed functions
<b>LAN</b>	PCIe Gb LAN controller, featuring AI NET2
<b>Audio</b>	Realtek® ALC1200 8-channel High Definition Audio CODEC - Supports Jack-detection, Multi-streaming, Front Panel Jack-Retasking technology - Coaxial S/PDIF out ports at back I/O - ASUS Noise Filter
<b>IEEE 1394</b>	LSI3227 controller supports 2 x 1394a ports
<b>USB</b>	Max. 12 USB2.0/1.1 ports(6 ports at mid-board, 6 ports at back panel)

*(continued on the next page)*

# P5Q PRO

## specifications summary

<b>ASUS Unique Features</b>	<b>ASUS Power Saving Solution:</b> <ul style="list-style-type: none"><li>- ASUS EPU-6 Engine</li><li>- ASUS 8-phase Power Design</li><li>- ASUS AI Nap</li></ul> <b>ASUS Unique Features:</b> <ul style="list-style-type: none"><li>- ASUS Express Gate</li><li>- ASUS AI Direct Link</li></ul> <b>ASUS Quiet Thermal Solution:</b> <ul style="list-style-type: none"><li>- ASUS Fanless Design: Heat-pipe solution</li><li>- ASUS Fan Xpert</li></ul> <b>ASUS EZ DIY:</b> <ul style="list-style-type: none"><li>- ASUS Q-Shield</li><li>- ASUS Drive Xpert</li><li>- ASUS Q-Connector</li><li>- ASUS O.C. Profile</li><li>- ASUS CrashFree BIOS 3</li><li>- ASUS EZ Flash 2</li></ul>
<b>ASUS Stylish Features</b>	ASUS MyLogo2™
<b>ASUS Exclusive Overclocking Features</b>	<b>ASUS AI Booster utility</b> <b>Precision Tweaker 2:</b> <ul style="list-style-type: none"><li>- vCore: Adjustable CPU voltage at 6.25mV increment</li><li>- vDIMM: 64-step DRAM voltage control</li><li>- vChipset (N.B.): 55-step chipset voltage control</li><li>- vFSB Termination: 15-step reference voltage control</li><li>- vCPU PLL: 64-step CPU PLL voltage control</li></ul> <b>SFS (Stepless Frequency Selection)</b> <ul style="list-style-type: none"><li>- FSB tuning from 200MHz up to 800MHz at 1MHz increment</li><li>- PCI Express frequency tuning from 100MHz up to 180MHz at 1MHz increment</li></ul> <b>Overclocking Protection:</b> <ul style="list-style-type: none"><li>- ASUS C.P.R.(CPU Parameter Recall)</li></ul>

*(continued on the next page)*

# P5Q PRO

## specifications summary

<b>Back Panel I/O Ports</b>	<ul style="list-style-type: none"> <li>1 x PS/2 Keyboard port</li> <li>1 x PS/2 Mouse port</li> <li>1 x S/PDIF Out (Coaxial)</li> <li>1 x IEEE1394a</li> <li>1 x RJ45 ports</li> <li>6 x USB 2.0/1.1</li> <li>8-channel Audio I/O</li> </ul>
<b>Internal I/O Connectors</b>	<ul style="list-style-type: none"> <li>3 x USB connectors support additional 6 USB ports</li> <li>1 x Floppy disk drive connector</li> <li>1 x COM connector</li> <li>1 x IDE connector</li> <li>1 x TPM connector</li> <li>6 x SATA connectors (Red)</li> <li>2 x Drive Xpert SATA connectors (Orange and white)</li> <li>1 x CPU Fan connector</li> <li>2 x Chassis Fan connectors</li> <li>1 x Power Fan connector</li> <li>1 x IEEE1394a connector</li> <li>Front panel audio connector</li> <li>1 x S/PDIF Out Header</li> <li>Chassis Intrusion connector</li> <li>CD audio in</li> <li>24-pin ATX Power connector</li> <li>1 x 8-pin ATX 12V Power connectors</li> <li>System Panel (Q-Connector)</li> </ul>
<b>BIOS Features</b>	8 Mb Flash ROM, AMI BIOS, PnP, DMI 2.0, WfM 2.0, SM BIOS 2.4, ACPI 2.0a
<b>Manageability</b>	WOL by PME, WOR by PME, PXE, WOR by Ring, Chassis Intrusion
<b>Support CD Contents</b>	<ul style="list-style-type: none"> <li>Drivers</li> <li>Express Gate</li> <li>ASUS PC Probe II</li> <li>ASUS Update</li> <li>ASUS AI Suite</li> <li>Anti-virus software (OEM version)</li> <li>Image-Editing Suite</li> </ul>
<b>Form Factor</b>	ATX Form Factor, 12"x 9.6" (30.5cm x 24.4cm)

\*Specifications are subject to change without notice.



This chapter describes the motherboard features and the new technologies it supports.

# 1 Product introduction

# Chapter summary



- 1.1 Welcome! ..... 1-1
- 1.2 Package contents..... 1-1
- 1.3 Special features..... 1-2



## 1.1 Welcome!

Thank you for buying an ASUS® P5Q PRO motherboard!

The motherboard delivers a host of new features and latest technologies, making it another standout in the long line of ASUS quality motherboards!

Before you start installing the motherboard, and hardware devices on it, check the items in your package with the list below.

## 1.2 Package contents

Check your motherboard package for the following items.

Motherboard	ASUS P5Q PRO
I/O modules	1 x eSATA+4-pin 1394 bracket
Cables	1 x 2-port Serial ATA power cable for 2 devices 4 x Serial ATA signal cables 1 x Ultra DMA 133/100/66 cable 1 x Floppy disk drive cable
Accessories	1 x ASUS Q-Shield (I/O shield) 1 x ASUS Q-Connector Kit (USB, 1394, system panel; Retail version only)
Application CD	ASUS motherboard Support DVD
Documentation	User guide



If any of the above items is damaged or missing, contact your retailer.

## 1.3 Special features

### 1.3.1 Product highlights

#### Intel® Core™2 Extreme / Core™ 2 Quad / Core™2 Duo Processor Support



This motherboard supports the latest Intel® Core™ 2 Extreme / Core™ 2 Quad / Core™ 2 Duo processors in the LGA775 package. It is excellent for multi-tasking, multi-media and enthusiastic gamers with 1600 / 1333 / 1066 / 800 MHz FSB. The Intel® Core™ 2 series processor is one of the most powerful CPUs in the world. This motherboard also supports Intel® CPUs in the new 45nm manufacturing process.

#### Intel® P45 Chipset



The Intel® P45 Chipset is the latest chipset designed to support 16GB of dual-channel DDR2 800/667 MHz memory architecture, 1333/1066/800 MHz FSB (Front Side Bus) and multi-core CPUs. It especially includes Intel® Fast Memory Access technology that significantly optimizes the use of available memory bandwidth and reduces the latency of the memory accesses.

#### PCIe 2.0



This motherboard supports the latest PCIe 2.0 device for twice the current speed and bandwidth. This enhances system performance while still providing backward compatibility to PCIe 1.0 devices.

#### Dual-channel DDR2 1200 memory support



The motherboard supports DDR2 memory that features data transfer rates of 1200/1066/800/667 MHz to meet the higher bandwidth requirements of the latest 3D graphics, multimedia, and Internet applications. The dual-channel DDR2 architecture doubles the bandwidth of your system memory to boost system performance, eliminating bottlenecks with peak bandwidths of up to 19.2 GB/s. Furthermore, this motherboard does not restrict the memory size across two channels. Users may install different memory size DIMMs into the two channels and enjoy dual-channel and single-channel functions at the same time. This new feature optimizes the use of available memory size. See page 2-10 for details.

## ASUS Express Gate



Taking only 5 seconds to go online from bootup, Express Gate is the one-stop gateway to instant fun! It's a unique motherboard built-in OS. You can utilize the most popular Instant Messengers (IM) like MSN, Skype, Google talk, QQ, and Yahoo! Messenger to keep in touch with friends, or quickly check on the weather and e-mails just before leaving your house. What's more, the user-friendly picture manager lets you view your pictures without entering Windows at anytime!



---

The actual boot time depends on the system configuration.

---

## Serial ATA 3Gb/s technology



This motherboard supports the hard drives based on the Serial ATA (SATA) 3Gb/s storage specification, delivering enhanced scalability and doubling the bus bandwidth for high-speed data retrieval and saves. See page 2-27 for details.



## IEEE 1394a support

The IEEE 1394a interface provides high speed digital interface for audio/video appliances such as digital television, digital video camcorders, storage peripherals & other PC portable devices. See page 2-30 for details.

## S/PDIF digital sound ready



This motherboard provides convenient connectivity to external home theater audio systems via coaxial S/PDIF-out (SONY-PHILIPS Digital Interface) jacks. It allows to transfer digital audio without converting to analog format and keeps the best signal quality. See page 2-32 for details.

## High Definition Audio



Enjoy high-end sound quality on your PC! The onboard 8-channel HD audio (High Definition Audio, previously codenamed Azalia) CODEC enables high-quality 192KHz/24-bit audio output that simultaneously sends different audio streams to different destinations. You can now talk to your partners on the headphone while playing multi-channel network games. See pages 2-22 and 2-23 for details.

## 100% Japan-made conductive polymer capacitors



This motherboard uses all Japan-made conductive polymer capacitors for durability, improved lifespan and enhanced thermal capacity.

## Green ASUS



This motherboard and its packaging comply with the European Union's Restriction on the use of Hazardous Substances (RoHS). This is in line with the ASUS vision of creating environment-friendly and recyclable products/packagings to safeguard consumers' health while minimizing the impact on the environment.

### 1.3.2 ASUS unique features

#### ASUS Power Saving Solution

ASUS Power Saving solution intelligently and automatically provides balanced computing power and energy consumption.

#### ASUS EPU-6 Engine



The new ASUS EPU - the world's first power saving engine, has been upgraded to a new six engine version, which provides total system power savings by detecting current PC loadings and intelligently moderating power in real-time. With auto phase switching for components (which includes the CPU, VGA card, memory, chipset, drives and system fan), the EPU automatically provides the most appropriate power usage via intelligent acceleration and overclocking - helping save power and money.

#### AI Nap



With AI Nap, the system can continue running at minimum power and noise when you are temporarily away. To wake up the system and return to the OS environment, simply click the mouse or press a key.

#### ASUS Quiet Thermal Solution

ASUS Quiet Thermal solution makes system more stable and enhances the overclocking capability.

## ASUS 8-Phase Power Design



### ***Longer Life, & Higher Efficiency!***

With power efficiency so important to operating temperatures, ASUS 8-phase VRM design leads the industry with its 96% power efficiency. High quality power components such as low RDS (on) MOSFETs for minimum switching loss & lower temperatures, Ferrite core chokes with lower hysteresis loss, and high quality Japanese-made conductive polymer capacitors all add up to ensure longer component life and lower power loss - creating more energy efficiency.



## Fan Xpert

“ASUS Fan Xpert intelligently allows users to adjust both the CPU and chassis fan speed according to different ambient temperature, which is caused by different climate conditions in different geographic regions and system loading. Built-in variety of useful profiles offer flexible controls of fan speed to achieve a quiet and cool environment.”

## Fanless Design and Heat-pipe



The ASUS fanless design allows multi-directional heat flow from major thermal sources in the motherboard to lower overall system temperature, resulting in quieter operation and longer system life. ASUS has devoted special efforts to address the thermal issues across the motherboard, and most notably in the following areas: CPU, power, VGA, Northbridge and Southbridge. The heat pipe, heatsink, and strategic board layout were tailor made to dissipate heat in the most efficient manner.

## ASUS Crystal Sound

This feature can enhance speech-centric applications like Skype, online game, video conference and recording.

## Noise Filter



This feature detects repetitive and stationary noises (non-voice signals) like computer fans, air conditioners, and other background noises then eliminates it in the incoming audio stream while recording.

## ASUS EZ DIY

ASUS EZ DIY feature collection provides you easy ways to install computer components, update the BIOS or back up your favorite settings.

## Drive Xpert



Without drivers or BIOS setups, the ASUS exclusive Drive Xpert is ideal for anyone who needs to secure data on their hard drives or enhance hard drive performances without the hassles of complicated configurations. With Drive Xpert's user-friendly graphical user interface, users can easily arrange hard drive backups or enhance their hard drive transfer rates - making sure that data is looked after every moment, every day.

## ASUS AI Direct Link



AI Direct Link can easily and efficiently transfer large amounts of data via the network cable - saving up to 70% of the total time taken. With AI Direct Link, it becomes easy to backup or share large data files like movies or other media content.

## ASUS Q-Shield



Easy and Comfortable Installations

The specially designed ASUS Q-Shield does without the usual "fingers" - making it convenient and easy to install. With better electric conductivity, it ideally protects your motherboard against static electricity and shields it against Electronic Magnetic Interference (EMI).

## ASUS Q-Connector



ASUS Q-Connector allows you to easily connect or disconnect the chassis front panel cables to the motherboard. This unique module eliminates the trouble of connecting the system panel cables one at a time and avoiding wrong cable connections. See page 2-35 for details.

## ASUS O.C. Profile



The motherboard features the ASUS O.C. Profile that allows users to conveniently store or load multiple BIOS settings. The BIOS settings can be stored in the CMOS or a separate file, giving users freedom to share and distribute their favorite settings. See page 4-35 for details.

## ASUS CrashFree BIOS 3



The ASUS CrashFree BIOS 3 allows users to restore corrupted BIOS data from a USB flash disk containing the BIOS file.

## ASUS EZ Flash 2



EZ Flash 2 is a user-friendly BIOS update utility. Simply press the predefined hotkey to launch the utility and update the BIOS without entering the OS. Update your BIOS easily without preparing a bootable diskette or using an OS-based flash utility.

## ASUS MyLogo2™



This feature allows you to convert your favorite photo into a 256-color boot logo for a more colorful and vivid image on your screen.

### 1.3.3 ASUS Exclusive Overclocking Features

#### AI Booster

The ASUS AI Booster allows you to overclock the CPU speed in Windows environment without the hassle of booting the BIOS.

#### Precision Tweaker 2



Allows the user to adjust the NB Voltage, FSB termination Voltage, CPU PLL Voltage and the DRAM Voltage in 0.02v steps to finetune voltages to achieve the most precise setting for the ultimate customized overclocking configuration.

#### C.P.R. (CPU Parameter Recall)



The C.P.R. feature of the motherboard BIOS allows automatic re-setting to the BIOS default settings in case the system hangs due to overclocking. When the system hangs due to overclocking, C.P.R. eliminates the need to open the system chassis and clear the RTC data. Simply shut down and reboot the system, and the BIOS automatically restores the CPU default setting for each parameter.





This chapter lists the hardware setup procedures that you have to perform when installing system components. It includes description of the jumpers and connectors on the motherboard.

# Hardware information



2.1	Before you proceed .....	2-1
2.2	Motherboard layout.....	2-2
2.3	Motherboard overview.....	2-4
2.4	System memory .....	2-10
2.5	Expansion slots.....	2-16
2.6	Jumper .....	2-19
2.7	Connectors .....	2-22
2.8	Starting up for the first time.....	2-36
2.7	Turning off the computer.....	2-37

## 2.1 Before you proceed

Take note of the following precautions before you install motherboard components or change any motherboard settings.



- Unplug the power cord from the wall socket before touching any component.
- Use a grounded wrist strap or touch a safely grounded object or a metal object, such as the power supply case, before handling components to avoid damaging them due to static electricity.
- Hold components by the edges to avoid touching the ICs on them.
- Whenever you uninstall any component, place it on a grounded antistatic pad or in the bag that came with the component.
- Before you install or remove any component, ensure that the ATX power supply is switched off or the power cord is detached from the power supply. Failure to do so may cause severe damage to the motherboard, peripherals, and/or components.

### Onboard LED

The motherboard comes with a standby power LED. The green LED lights up to indicate that the system is ON, in sleep mode, or in soft-off mode. This is a reminder that you should shut down the system and unplug the power cable before removing or plugging in any motherboard component. The illustration below shows the location of the onboard LED.

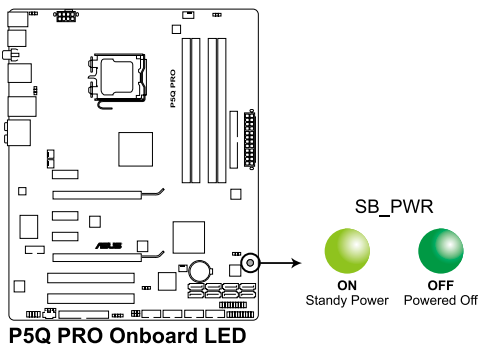

## 2.2 Motherboard overview

### 2.2.1 Motherboard layout

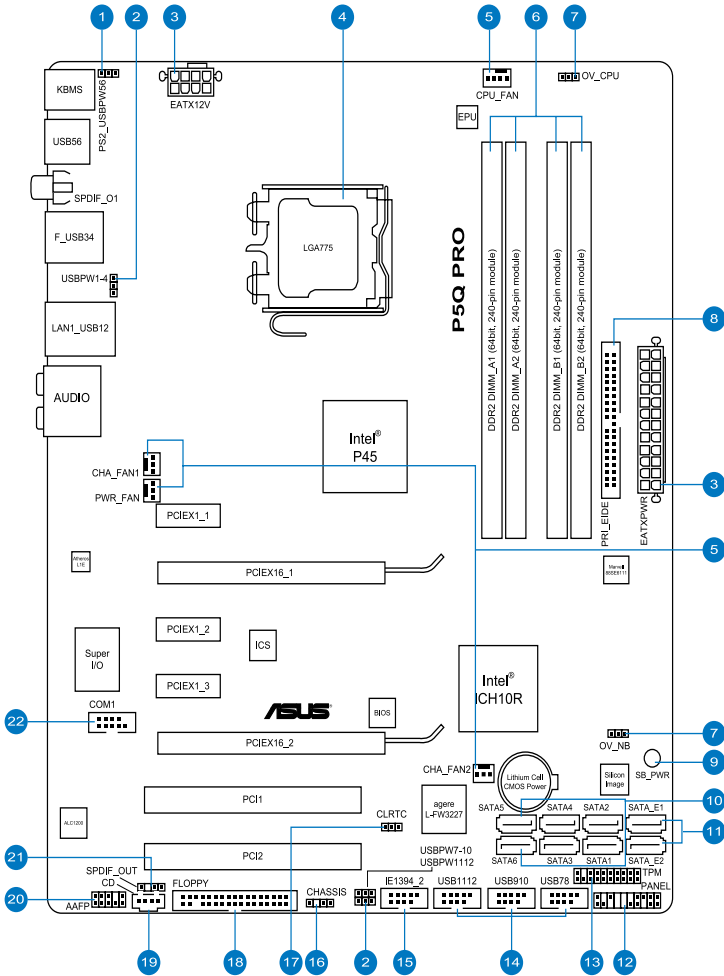

Refer to **2.7 Connectors** for more information about rear panel connectors and internal connectors.

## 2.2.2 Layout contents

Connectors/Jumpers/Slots		Page
1	PS2 keyboard/mouse wake-up (3-pin PS2_USBPW56)	2-22
2.	USB device wake-up (3-pin USBPW1-4, PS2_USBPW56, USBPW7-10, USBPW1112)	2-22
3.	ATX power connectors (24-pin EATXPWR, 8-pin EATX12V)	2-34
4.	LGA775 CPU socket	2-5
5.	CPU, chassis, and power fan connectors (4-pin CPU_FAN, 3-pin CHA_FAN1-2, 3-pin PWR_FAN)	2-31
6.	DDR2 DIMM slots	2-10
7.	CPU / Northbridge overvoltage setting (3-pin OV_CPU, 3-pin OV_NB)	2-21
8.	IDE connector (40-1 pin PRI_EIDE)	2-26
9.	Standby power LED (SB_PWR)	2-1
10.	ICH10R Serial ATA connectors (7-pin SATA1-6)	2-27
11.	Silicon Image® Serial ATA RAID connectors (7-pin SATA_E1, 7-pin SATA_E2)	2-28
12.	System panel connector (20-8 pin PANEL)	2-35
13.	TPM connector (20-1 pin TPM)	2-33
14.	USB connectors (10-1 pin USB78, USB910, USB1112)	2-28
15.	IEEE 1394a port connector (10-1 pin IE1394_2)	2-30
16.	Chassis intrusion connector (4-1 pin CHASSIS)	2-32
17.	Clear RTC RAM (3-pin CLRTC)	2-30
18.	Floppy disk drive connector (34-1 pin FLOPPY)	2-25
19.	Optical drive audio connector (4-pin CD)	2-31
20.	Front panel audio connector (10-1 pin AAFP)	2-33
21.	Digital audio connector (4-1 pin SPDIF_OUT for ASUS HDMI VGA card)	2-32
22.	Serial port connector (10-1 pin COM1)	2-29

## 2.2.3 Placement direction

When installing the motherboard, make sure that you place it into the chassis in the correct orientation. The edge with external ports goes to the rear part of the chassis as indicated in the image below.

## 2.2.4 Screw holes

Place six (9) screws into the holes indicated by circles to secure the motherboard to the chassis.



DO NOT overtighten the screws! Doing so can damage the motherboard.

Place this side towards  
the rear of the chassis

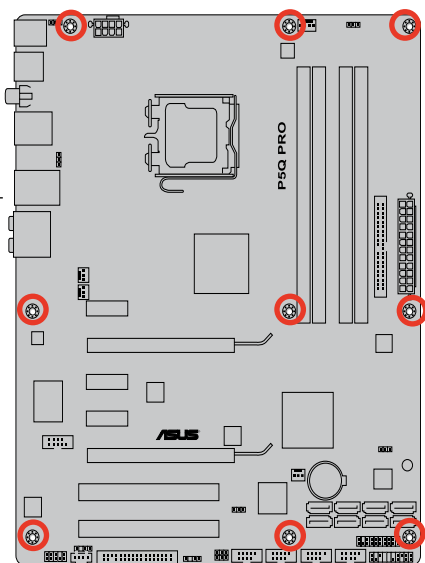

## 2.3 Central Processing Unit (CPU)

The motherboard comes with a surface mount LGA775 socket designed for the Intel® Core™2 Quad / Core™2 Extreme / Core™2 Duo / Pentium® Extreme / Pentium® D / Pentium® 4 Processors.



- Make sure that all power cables are unplugged before installing the CPU.
- If installing a dual-core CPU, connect the chassis fan cable to the CHA\_FAN1 connector to ensure system stability.
- Due to the chipset limitation, we recommend you use FSB 800MHz CPU or above.



- Upon purchase of the motherboard, make sure that the PnP cap is on the socket and the socket contacts are not bent. Contact your retailer immediately if the PnP cap is missing, or if you see any damage to the PnP cap/socket contacts/motherboard components. ASUS will shoulder the cost of repair only if the damage is shipment/transit-related.
- Keep the cap after installing the motherboard. ASUS will process Return Merchandise Authorization (RMA) requests only if the motherboard comes with the cap on the LGA775 socket.
- The product warranty does not cover damage to the socket contacts resulting from incorrect CPU installation/removal, or misplacement/loss/incorrect removal of the PnP cap.

### 2.3.1 Installing the CPU

To install a CPU:

1. Locate the CPU socket on the motherboard.

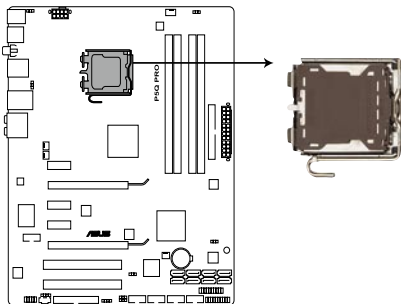

**P5Q PRO CPU socket 775**



Before installing the CPU, make sure that the cam box is facing towards you and the load lever is on your left.

2. Press the load lever with your thumb (A), then move it to the left (B) until it is released from the retention tab.



To prevent damage to the socket pins, do not remove the PnP cap unless you are installing a CPU.

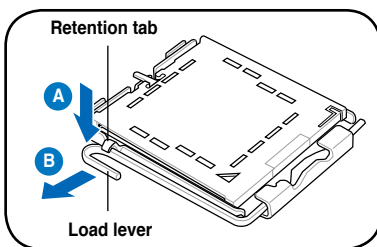

3. Lift the load lever in the direction of the arrow to a 135° angle.
4. Lift the load plate with your thumb and forefinger to a 100° angle (4A), then push the PnP cap from the load plate window to remove (4B).

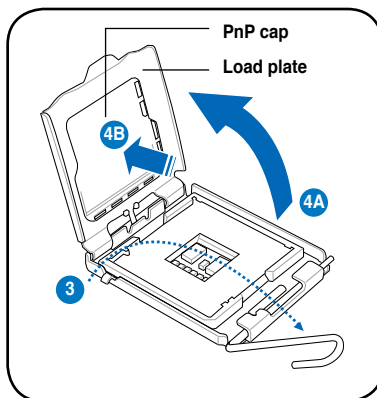

5. Position the CPU over the socket, making sure that the gold triangle is on the bottom-left corner of the socket then fit the socket alignment key into the CPU notch.



The CPU fits in only one correct orientation. DO NOT force the CPU into the socket to prevent bending the connectors on the socket and damaging the CPU!

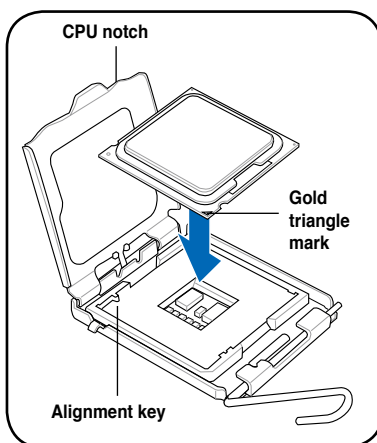



6. Apply several drops of thermal paste to the exposed area of the CPU that the heatsink will be in contact with, ensuring that it is spread in an even thin layer.



Some heatsinks come with pre-applied thermal paste. If so, skip this step.

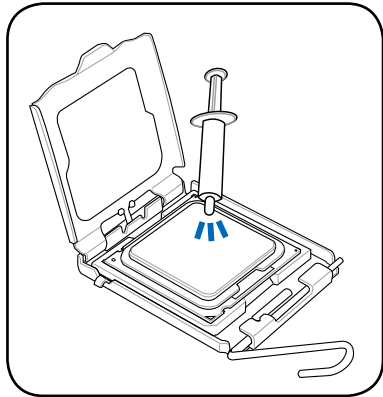

The Thermal Interface Material is toxic and inedible. If it gets into your eyes or touches your skin, ensure to wash it off immediately, and seek professional medical help.



To prevent contaminating the paste, DO NOT spread the paste with your finger directly.

7. Close the load plate (A), then push the load lever (B) until it snaps into the retention tab.

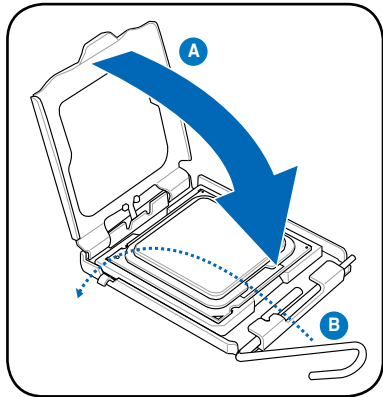

The motherboard supports Intel® LGA775 processors with the Intel® Enhanced Memory 64 Technology (EM64T), Enhanced Intel SpeedStep® Technology (EIST), and Hyper-Threading Technology. Refer to the Appendix for more information on these CPU features.

### 2.3.2 Installing the CPU heatsink and fan

The Intel® LGA775 processor requires a specially designed heatsink and fan assembly to ensure optimum thermal condition and performance.



- When you buy a boxed Intel® processor, the package includes the CPU fan and heatsink assembly. If you buy a CPU separately, make sure that you use only Intel®-certified multi-directional heatsink and fan.
- Your Intel® LGA775 heatsink and fan assembly comes in a push-pin design and requires no tool to install.
- If you purchased a separate CPU heatsink and fan assembly, make sure that you have properly applied Thermal Interface Material to the CPU heatsink or CPU before you install the heatsink and fan assembly.



Make sure that you have installed the motherboard to the chassis before you install the CPU fan and heatsink assembly.



If you purchased a separate CPU heatsink and fan assembly, ensure that the Thermal Interface Material is properly applied to the CPU heatsink or CPU before you install the heatsink and fan assembly.

To install the CPU heatsink and fan:

1. Place the heatsink on top of the installed CPU, making sure that the four fasteners match the holes on the motherboard.
2. Push down two fasteners at a time in a diagonal sequence to secure the heatsink and fan assembly in place.

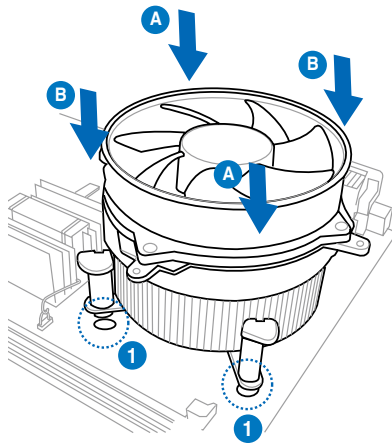
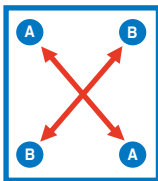

Orient the heatsink and fan assembly such that the CPU fan cable is closest to the CPU fan connector.

3. Connect the CPU fan cable to the connector on the motherboard labeled CPU\_FAN.

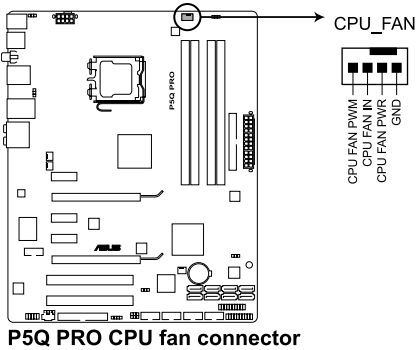

DO NOT forget to connect the CPU fan connector! Hardware monitoring errors can occur if you fail to plug this connector.

### 2.3.3 Uninstalling the CPU heatsink and fan

To uninstall the CPU fan cable and fan:

1. Disconnect the CPU fan cable from the connector on the motherboard.
2. Rotate each fastener counterclockwise.
3. Pull up two fasteners at a time in a diagonal sequence to disengage the heatsink and fan assembly from the motherboard.

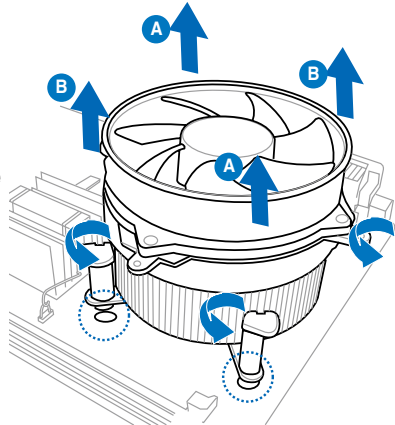
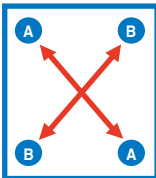

4. Carefully remove the heatsink and fan assembly from the motherboard.

## 2.4 System memory

### 2.4.1 Overview

The motherboard comes with four Double Data Rate 2 (DDR2) Dual Inline Memory Modules (DIMM) sockets.

The figure illustrates the location of the DDR2 DIMM sockets:

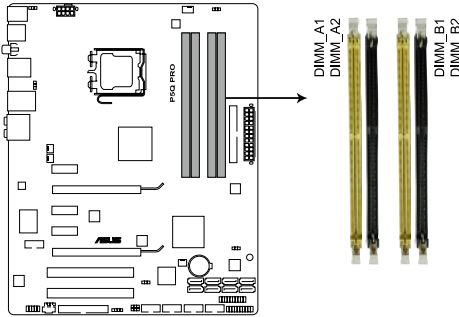

**P5Q PRO 240-pin DDR2 DIMM sockets**

Channel	Sockets
Channel A	DIMM_A1 and DIMM_A2
Channel B	DIMM_B1 and DIMM_B2

## 2.4.2 Memory configurations

You may install 512 MB, 1 GB, 2 GB and 4GB unbuffered non-ECC DDR2 DIMMs into the DIMM sockets.



- 
- You may install varying memory sizes in Channel A and Channel B. The system maps the total size of the lower-sized channel for the dual-channel configuration. Any excess memory from the higher-sized channel is then mapped for single-channel operation.
  - It is recommended that you install the memory module from yellow slots for better overclocking capability.
  - Always install DIMMs with the same CAS latency. For optimum compatibility, it is recommended that you obtain memory modules from the same vendor.
  - When installing total memory of 4GB capacity or more, Windows 32-bit operation system may only recognize less than 3GB. Hence, a total installed memory of less than 3GB is recommended.
  - This motherboard does not support memory modules made up of 256 Mb chips.
- 



- 
- Due to chipset limitation, this motherboard can only support up to 16 GB on the operating systems listed below. You may install a maximum of 4 GB DIMMs on each slot.

### 64-bit

Windows® XP Professional x64 Edition  
Windows® Vista x64 Edition

- The default memory operation frequency is dependent on its SPD. Under the default state, some memory modules for overclocking may operate at a lower frequency than the vendor-marked value. To operate at the vendor-marked or at a higher frequency, see section **3.4 Ai Tweaker menu** for manual memory frequency adjustment.
  - The memory modules may require a better cooling system to work stably under full loading (4 DIMMs) or overclocking setting.
-

## P5Q PRO Motherboard Qualified Vendors Lists (QVL) DDR2-1066MHz capability

Size	Vendor	Chip No.	CL	Chip Brand	SS/DS	Part No.	DIMM socket support (Optional)		
							A*	B*	C*
1024MB	APACER	N/A	N/A	APACER	DS	78.0AG9S.9KF	V		
4096MB(Kit of 2)	CORSAIR	Heat-Sink Package	5-5-5-15	N/A	DS	Box P/N:TWIN2X4096-8500C5DF(CM2X2048-8500C5D)(EPP)	V	V	
1024MB	CORSAIR	Heat-Sink Package	N/A	N/A	DS	CM2X1024-8500C5D(EPP)	V		
2048MB(Kit of 2)	G.SKILL	Heat-Sink Package	5-5-5-15	N/A	DS	F2-8500CL5D-2GBPK		V	
1024MB	G.SKILL	Heat-Sink Package	5-5-5-15	N/A	DS	F2-8500CL5S-1GBPK	V	V	
1024MB	GEIL	GL2L128M88BA25AB	5-5-5-15	GEIL	SS	GB22GB8500C5DC	V	V	V
4096MB(Kit of 4)	GEIL	Heat-Sink Package	5-5-5-15	N/A	SS	GE24GB1066C5QC	V	V	V
2048MB	GEIL	GL2L128M88BA25AB	5-5-5-15	GEIL	DS	GB24GB8500C5DC	V		
4096MB(Kit of 2)	GEIL	Heat-Sink Package	5-5-5-15	N/A	DS	GX24GB8500C5UDC		V	
512MB	KINGMAX	KK48FE1BF-HJK-18E	N/A	N/A	SS	KLEC28F-ABK15-EGAS	V		
512MB	Kingston	E5108AJBG -1J-E	N/A	N/A	SS	KVR1066D2N7/ 512	V	V	V
1024MB	Kingston	E5108AJBG -1J-E	N/A	N/A	DS	KVR1066D2N7/1G	V	V	
2048MB(Kit of 2)	Kingston	N/A	N/A	Kingston	DS	KVR1066D2N7K2/2G	V	V	
2048MB	OCZ	N/A	N/A	N/A	DS	HOCZ2RPR10662GK			V

## P5Q PRO Motherboard Qualified Vendors Lists (QVL) DDR2-800MHz capability

Size	Vendor	Chip No.	CL	Chip Brand	SS/DS	Part No.	DIMM socket support (Optional)		
							A*	B*	C*
512MB	A-DATA	AD29608A8A-25EG	N/A	N/A	SS	M2OAD6G3H3160G1E53	V	V	V
1024MB	A-DATA	AD26908A8A-25EG	N/A	N/A	DS	M2OAD6G3J4170H1E58		V	
2048MB	A-DATA	AD20908A8A-25EG	N/A	A-DATA	DS	M2OAD6H3J4171Q1E52		V	V
512MB	Apacer	AM4B5708JQJ58E	N/A	APACER	SS	78.91G9I.9K5	V	V	V
1024MB	Apacer	AM4B5808CQJ58E	N/A	APACER	SS	78.01GA0.9K5	V	V	V
2048MB	Apacer	AM4B5808CQJ58E	5	APACER	DS	78.A1GA0.9K4	V	V	V
1024MB	CORSAIR	Heat-Sink Package	4	N/A	DS	CM2X1024-6400C4	V	V	V
1024MB	Crucial	Heat-Sink Package	4	N/A	DS	BL12864AA804.16FD	V	V	V
1024MB	Crucial	Heat-Sink Package	4	N/A	DS	BL12864AL804.16FD3	V	V	V
1024MB	Crucial	Heat-Sink Package	4	N/A	DS	BL12864AA804.16FD3	V	V	V
1024MB	ELPIDA	E1108AB-8E-E(ECC)	5	ELPIDA	SS	EBE10EE8ABFA-8E-E	V		V
1024MB	G.SKILL	Heat-Sink Package	N/A	N/A	DS	F2-6400CL4D-2GBPK	V	V	V
1024MB	G.SKILL	Heat-Sink Package	N/A	N/A	DS	F2-6400CL5D-2GBNQ	V		V
1024MB	G.SKILL	Heat-Sink Package	N/A	N/A	DS	F2-6400PHU2-2GBNR	V	V	V
1024MB	G.SKILL	Heat-Sink Package	N/A	N/A	DS	F2-6400CL4D-2GBHK	V	V	V
4096MB(Kit of 2)	G.SKILL	Heat-Sink Package	4	N/A	DS	F2-6400CL4D-4GBPK	V	V	V
4096MB(Kit of 2)	G.SKILL	Heat-Sink Package	6	N/A	DS	F2-6400CL6D-4GBMQ	V	V	V
4096MB(Kit of 2)	G.SKILL	Heat-Sink Package	5	N/A	DS	F2-6400CL5D-4GBPQ	V	V	V

# P5Q PRO Motherboard Qualified Vendors Lists (QVL)

## DDR2-800MHz capability

Size	Vendor	Chip No.	CL	Chip Brand	SS/DS	Part No.	DIMM socket support (Optional)		
							A*	B*	C*
2048MB	GEIL	GL2L128M088BA25CW	5	GEIL	DS	GB28GB6400C50C	V	V	V
2048MB	GEIL	GE24GB800C5DC	5-5-5-15	N/A	DS	Heat-Sink Package	V	V	V
2048MB	GEIL	GE28GB800C5QC	5-5-5-15	N/A	DS	Heat-Sink Package	V	V	
2048MB	GEIL	GE28GB800C4QC	4-4-4-12	N/A	DS	Heat-Sink Package	V	V	
2048MB	GEIL	GE24GB800C4DC	4-4-4-12	N/A	DS	Heat-Sink Package	V	V	
2048MB	GEIL	GB24GB6400C5DC	5-5-5-15	GEIL	DS	GL2L128M88BA25AB	V	V	V
512MB	Hynix	HY5PS12821CFP-S5	5-5-5	Hynix	SS	HYMP564U64CP8-S5	V	V	V
1024MB	Hynix	HY5PS12821CFP-S5	5-5-5	Hynix	DS	HYMP512U64CP8-S5	V	V	V
512MB	KINGMAX	KK48FEIBF-HJK-25A	N/A	KINGMAX	SS	KLDC28F-ABK15	V	V	
1024MB	KINGMAX	KK48FEIBF-HJK-25A	N/A	KINGMAX	DS	KLDD48F-ABK15	V	V	V
2048MB	KINGMAX	KK88FBFXF-CFA-25A	N/A	KINGMAX	DS	KLDE88F-B8KB5	V	V	V
512MB	KINGSTON	E5108AJBG-8E-E	N/A	ELPIDA	SS	KVR800D2N5/512	V	V	V
512MB	KINGSTON	E5108AJBG-8E-E	1.8	ELPIDA	SS	KVR800D2N6/512	V	V	V
1024MB	KINGSTON	Heat-Sink Package	4-4-4-12	N/A	SS	KHX6400D2LLK2/1GN(EPP)	V	V	V
1024MB	KINGSTON	Heat-Sink Package	N/A	N/A	SS	KHX6400D2ULK2/1G	V	V	
1024MB	KINGSTON	Heat-Sink Package	4-4-4-12	N/A	DS	KHX6400D2LL/1G	V	V	
1024MB	KINGSTON	V59C1512804QBF25	N/A	N/A	DS	KVR800D2N5/1G	V	V	V
1024MB	KINGSTON	E5108AJBG-8E-E	1.8	ELPIDA	DS	KVR800D2N6/1G	V	V	V
2048MB	KINGSTON	E1108ACBG-8E-E	N/A	ELPIDA	DS	KVR800D2N5/2G	V	V	V
512MB	NANYA	NT5TU64M8BE-25C	5	NANYA	SS	NT512T64U880BY-25C	V	V	V
1024MB	NANYA	NT5TU64M8BE-25C	5	NANYA	DS	NT1GT64U8H80BY-25C	V	V	V
1024MB	NANYA	NT5TU64M8CE-25D	N/A	NANYA	DS	NT1GT64U8H80BY-25D	V	V	V
2048MB	NANYA	NT5TU128M8CE-AC	5	NANYA	DS	NT2GT64U8H80BY-AC	V	V	V
1024MB	OCZ	Heat-Sink Package	5	N/A	DS	OCZ2T8002GK	V		
2048MB	OCZ	Heat-Sink Package	5-4-4-15	N/A	DS	OCZ2P8004GK	V	V	V
2048MB(Kit of 2)	OCZ	Heat-Sink Package	4	N/A	DS	OCZ2P800R22GK	V	V	V
4096MB(Kit of 2)	OCZ	Heat-Sink Package	5-4-4	N/A	DS	OCZ2P8004GK	V	V	V
2048MB	PSC	A3R1GE3CF7734MAA0E	5	PSC	DS	AL8E8F73C-8E1	V	V	V
2048MB	Qimonda	HYB18T1G800C2F-25F	5	QIMONDA	DS	HYS64T256020EU-25F-C2	V	V	V
2048MB	Qimonda	HYB18T1G800C2F-2.5	6	QIMONDA	DS	HYS64T256020EU-2.5-C2	V	V	V
512MB	SAMSUNG	K4T51083QG	6	SAMSUNG	SS	M378T6553GZ3-CF7	V	V	
1024MB	SAMSUNG	K4T1G084QQ	6	SAMSUNG	SS	M378T2863QZ3-CF7	V	V	V
800 1024MB	SAMSUNG	K4T1G084QQ(ECC)	6	SAMSUNG	SS	M391T2863QZ3-CF7	V	V	V
1024MB	SAMSUNG	K4T51083QG	6	SAMSUNG	DS	M378T2953GZ3-CF7	V	V	V
4096MB	SAMSUNG	K4T2G084QA-HCF7	6	SAMSUNG	DS	M378T5263AZ3-CF7	V	V	V
2048MB	SAMSUNG	K4T1G084QQ	6	SAMSUNG	DS	M391T5663QZ3-CF7	V	V	V
2048MB	SAMSUNG	K4T1G084QQ(ECC)	6	SAMSUNG	DS	M378T5663QZ3-CF7	V	V	V
512MB	Super Talent	Heat-Sink Package	N/A	N/A	SS	T800U1A12C4	V	V	V
1024MB	Super Talent	Heat-Sink Package	N/A	N/A	DS	T800UB1GC4	V		

## P5Q PRO Motherboard Qualified Vendors Lists (QVL) DDR2-800MHz capability

Size	Vendor	Chip No.	CL	Chip Brand	SS/DS	Part No.	DIMM socket support (Optional)		
							A*	B*	C*
1024MB	Aeneon	AET03R25DC	5	Aeneon	SS	AET760UD00-25DC08X	V	V	
1024MB	Aeneon	AET93R25DB	N/A	Aeneon	DS	AET760UD00-25DB97X	V	V	
2048MB	Aeneon	AET03R25DC	5	Aeneon	DS	AET860UD00-25DC08X	V	V	V
1024MB	Asint	DDR11208-GE	N/A	Asint	SS	SLY2128M8-JGE	V	V	V
2048MB	Asint	DDR11208-GE	N/A	Asint	DS	SLZ2128M8-JGE	V	V	
512MB	CENTURY	HY5PS12821BFP-S5	N/A	Hynix	SS	28V2H8	V	V	
1024MB	CENTURY	HY5PS12821BFP-S5	N/A	Hynix	DS	28VOH8	V	V	
1024MB	Elixir	N2TU51280BE-25C	5	Elixir	DS	M2Y1G64TU8HB0B-25C	V	V	
1024MB	Oci	64M8PC6400	5	Jnfinity	DS	04701G16CZ5D2A	V	V	V
512MB	Patriot	PM64M8D2BU-25EC	N/A	N/A	SS	PSD251280081	V	V	V
2048MB	Patriot	PM128M8D2BU-25KC	5	Patriot	DS	PSD22GB002	V		
1024MB	UMAX	U2S12D30TP-8E	N/A	UMAX	DS	D48001GP3-63BJU	V	V	V
2048MB	UMAX	U2S12D30TP-8E	N/A	UMAX	DS	D48002GP0-73BCU	V	V	V

## P5Q PRO Motherboard Qualified Vendors Lists (QVL) DDR2-667MHz capability

Size	Vendor	Chip No.	CL	Chip Brand	SS/DS	Part No.	DIMM socket support (Optional)		
							A*	B*	C*
512MB	A-DATA	AD29608A8A-3EG	5	A-DATA	SS	M2OAD5G3H1661C52	V	V	V
1024MB	A-DATA	AD29608A8A-3EG	5	A-DATA	DS	M2OAD5G3I41761C52	V	V	V
2048MB	A-DATA	NT5TU128M8BJ-3C	N/A	N/A	DS	M2ON1Y5H3J41701C5Z	V	V	V
512MB	Apacer	AM4B5708JQS7E	N/A	APACER	SS	78.91G92.9K5	V	V	V
1024MB	Apacer	AM4B5808CQJS7E	N/A	APACER	SS	78.01G90.9K5	V	V	V
2048MB	Apacer	AM4B5808CQJS7E	N/A	APACER	DS	78.A1G90.9K4	V	V	V
512MB	CORSAIR	64M8CFEG	N/A	N/A	SS	V5S12MB667D2	V	V	V
1024MB	CORSAIR	64M8CFEG	N/A	N/A	DS	VS1GB667D2	V	V	V
512MB	crucial	Heat-Sink Package	3	N/A	SS	BL6464AA663.8FD	V	V	V
1024MB	crucial	Heat-Sink Package	3	N/A	DS	BL12864AA663.16FD	V	V	V
1024MB	crucial	Heat-Sink Package	3	N/A	DS	BL12864AL664.16FD	V	V	V
1024MB	crucial	Heat-Sink Package	3	N/A	DS	BL12864AA663.16FD2		V	
512MB	ELPIDA	E5108AE-6E-E	5	ELPIDA	SS	EBE51UD8AEFA-6E-E	V	V	V
1024MB	Hynix	HY5PS12821CFP-Y5	5	Hynix	DS	HYMP512U64CP8-Y5	V	V	V
512MB	Kingmax	KKEA88B4LAUG-29DX	5	KINGMAX	SS	KLCC28F-A8KB5	V	V	V
1024MB	Kingmax	KKEA88B4LAUG-29DX	5	KINGMAX	DS	KLCD48F-A8KB5	V	V	V
512MB	KINGSTON	D6408TEBGL3U	5	KINGSTON	SS	KVR667D2N5/512	V	V	V
1024MB	KINGSTON	E5108AGBG-6E-E	N/A	KINGSTON	DS	KVR667D2N5/1G	V	V	V
2048MB	KINGSTON	E1108AB-6E-E	N/A	ELPIDA	DS	KVR667D2N5/2G	V	V	V
2048MB	KINGSTON	HY5PS1G831CFP-Y5	N/A	Hynix	DS	KVR667D2N5/2G	V	V	V
512MB	NANYA	NT5TU64M8BE-3C	5	NANYA	SS	NT512T64U88B0BY-3C	V	V	V
2048MB	NANYA	NT5TU128M8BJ-3C	5	NANYA	DS	NT2GT64U8HB0JY-3C	V	V	V



## P5Q PRO Motherboard Qualified Vendors Lists (QVL) DDR2-667MHz capability

Size	Vendor	Chip No.	CL	Chip Brand	SS/DS	Part No.	DIMM socket support (Optional)		
							A*	B*	C*
1024MB	PSC	A3R12E3JFF719A9T02	5	PSC	DS	AL7E8E83J-6E1	V	V	V
2048MB	Qimonda	HYB18T1GB00C2F-3S	5	QIMONDA	DS	HYS64T256020EU-3S-C2	V	V	V
512MB	SAMSUNG	K4T51083QE	5	SAMSUNG	SS	M378T6553EZS-CE6	V	V	V
1024MB	SAMSUNG	K4T51083QE	5	SAMSUNG	DS	M378T2953EZ3-CE6	V	V	V
4096MB	SAMSUNG	K4T2G084QA-HCE6	5	SAMSUNG	DS	M378T5263AZ3-CE6	V	V	V
512MB	Super Talent	Heat-Sink Package	5	N/A	SS	T6UA512C5	V	V	V
1024MB	Super Talent	Heat-Sink Package	5	N/A	DS	T6UB1GC5	V	V	V
512MB	TwinMOS	TMM6208G8M30C	5	TwinMOS	SS	8D-23JK5M2ETP	V	V	V
512MB	Aeneon	AET93R300B	5	AENEON	SS	AET660UD00-30DB97X	V	V	
1024MB	Aeneon	AET93R30DB	5	AENEON	DS	AET760UD00-30B97X	V	V	
2048MB	Aeneon	AET03F30DB	5	AENEON	DS	AET860UD00-30DB08X	V	V	
512MB	Asint	DDR116408-6E	N/A	Asint	SS	SLX264M8-J6E	V	V	V
1024MB	Asint	DDR11208-6E	N/A	Asint	SS	Sly2128M8-J6E	V	V	V
512MB	CENTURY	HY5PS12821CFP-Y5	5	Hynix	SS	26VH8	V	V	V
1024MB	CENTURY	HY5PS12821CFP-Y5	5	Hynix	DS	26VOH8	V		
1024MB	Kingbox	EPD264082200E-4	N/A	Kingbox	DS	N/A	V	V	V
512MB	MDT	18D51280D-30648	4	MDT	SS	M512-667-8	V	V	V
1024MB	MDT	18D51280D-30648E	4	MDT	DS	M924-667-16	V	V	V
512MB	Patriot	PM64M8D2BU-3KC	N/A	N/A	SS	PSD251266781	V	V	V
1024MB	Patriot	PM64M8D2BU-3PAC	5	Patriot	DS	PSD21G6672	V	V	V
1024MB	UMAX	U2S12D30TP-6E	N/A	UMAX	DS	D46701GP3-63BJU	V	V	V
2048MB	UMAX	U2S24D30TP-6E	N/A	UMAX	DS	D46702GP0-73BCU	V	V	V



### SS - Single-sided / DS - Double-sided

#### DIMM support:

- **A\***: Supports one modules inserted into either slot as Single-channel memory configuration.
- **B\***: Supports one pair of modules inserted into either the yellow slots or the black slots as one pair of Dual-channel memory configuration.
- **C\***: Supports 4 modules inserted into both the yellow and black slots as two pairs of Dual-channel memory configuration.



Visit the ASUS website for the latest DDR2-1066/800/667 MHz QVL.

### 2.4.3 Installing a DDR2 DIMM



Make sure to unplug the power supply before adding or removing DIMMs or other system components. Failure to do so may cause severe damage to both the motherboard and the components.

1. Unlock a DDR2 DIMM socket by pressing the retaining clips outward.
2. Align a DIMM on the socket such that the notch on the DIMM matches the break on the socket.

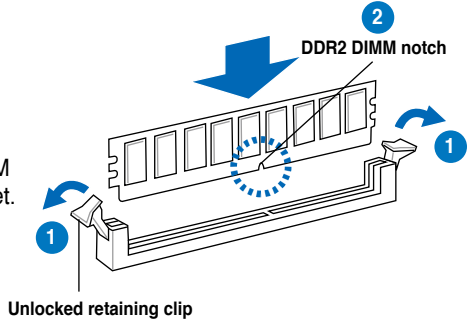

A DDR2 DIMM is keyed with a notch so that it fits in only one direction. DO NOT force a DIMM into a socket to avoid damaging the DIMM.

3. Firmly insert the DIMM into the socket until the retaining clips snap back in place and the DIMM is properly seated.

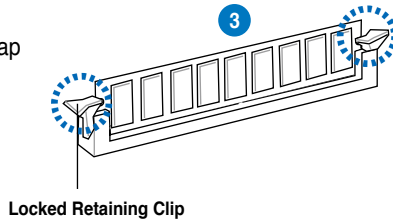

### 2.4.4 Removing a DDR2 DIMM

Follow these steps to remove a DIMM.

1. Simultaneously press the retaining clips outward to unlock the DIMM.

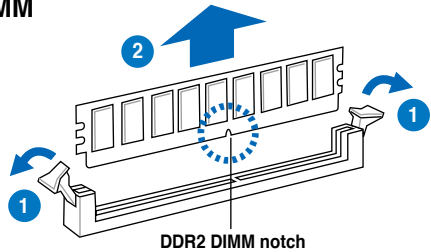

Support the DIMM lightly with your fingers when pressing the retaining clips. The DIMM might get damaged when it flips out with extra force.

2. Remove the DIMM from the socket.

## 2.5 Expansion slots

In the future, you may need to install expansion cards. The following sub-sections describe the slots and the expansion cards that they support.



---

Make sure to unplug the power cord before adding or removing expansion cards. Failure to do so may cause you physical injury and damage motherboard components.

---

### 2.5.1 Installing an expansion card

To install an expansion card:

1. Before installing the expansion card, read the documentation that came with it and make the necessary hardware settings for the card.
2. Remove the system unit cover (if your motherboard is already installed in a chassis).
3. Remove the bracket opposite the slot that you intend to use. Keep the screw for later use.
4. Align the card connector with the slot and press firmly until the card is completely seated on the slot.
5. Secure the card to the chassis with the screw you removed earlier.
6. Replace the system cover.

### 2.5.2 Configuring an expansion card

After installing the expansion card, configure it by adjusting the software settings.

1. Turn on the system and change the necessary BIOS settings, if any. See Chapter 4 for information on BIOS setup.
2. Assign an IRQ to the card. Refer to the tables on the next page.
3. Install the software drivers for the expansion card.



---

When using PCI cards on shared slots, ensure that the drivers support “Share IRQ” or that the cards do not need IRQ assignments. Otherwise, conflicts will arise between the two PCI groups, making the system unstable and the card inoperable. Refer to the table on the next page for details.

---

## 2.5.3 Interrupt assignments

IRQ	Priority	Standard function
0	1	System timer
1	2	Keyboard controller
2	–	Re-direct to IRQ#9
3	11	IRQ holder for PCI steering*
4	12	Communications port (COM1)*
5	13	IRQ holder for PCI steering*
6	14	Floppy disk controller
7	15	Printer port (LPT1)*
8	3	System CMOS/Real Time Clock
9	4	IRQ holder for PCI steering*
10	5	IRQ holder for PCI steering*
11	6	IRQ holder for PCI steering*
12	7	PS/2 compatible mouse port*
13	8	Numeric data processor
14	9	SATA Primary IDE (legacy mode)
15	10	SATA Secondary IDE (legacy mode)

\* These IRQs are usually available for PCI devices.

### IRQ assignments for this motherboard

	A	B	C	D	E	F	G	H
PCI slot 1	shared	–	–	–	–	–	–	–
PCI slot 2	–	shared	–	–	–	–	–	–
LAN (L1E)	–	–	shared	–	–	–	–	–
SATA (5723)	shared	–	–	–	–	–	–	–
PCIe x16_1	shared	–	–	–	–	–	–	–
PCIe x16_2	shared	–	–	–	–	–	–	–
PCIe x1_1	shared	–	–	–	–	–	–	–
PCIe x1_2	–	–	shared	–	–	–	–	–
PCIe x1_3	–	–	–	shared	–	–	–	–
USB controller 1	–	–	–	–	–	–	–	shared
USB controller 2	–	–	–	shared	–	–	–	–
USB controller 3	–	–	shared	–	–	–	–	–
USB controller 4	shared	–	–	–	–	–	–	–
USB controller 5	–	–	–	–	–	shared	–	–
USB controller 6	–	–	shared	–	–	–	–	–
USB 2.0 controller 1	–	–	–	–	–	–	–	shared
USB 2.0 controller 2	–	–	shared	–	–	–	–	–
SATA controller 1	–	–	–	shared	–	–	–	–
SATA controller 2	–	–	–	–	–	–	shared	–

## 2.5.4 PCI slots

The PCI slots support cards such as a LAN card, SCSI card, USB card, and other cards that comply with PCI specifications. Refer to the figure below for the location of the slots.

## 2.5.5 PCI Express x1 slots

This motherboard supports PCI Express x1 network cards, SCSI cards and other cards that comply with the PCI Express specifications. Refer to the figure below for the location of the slots.

## 2.5.6 PCI Express 2.0 x16 slot

This motherboard supports a PCI Express x16 graphics card that comply with the PCI Express specifications. Refer to the figure below for the location of the slot.

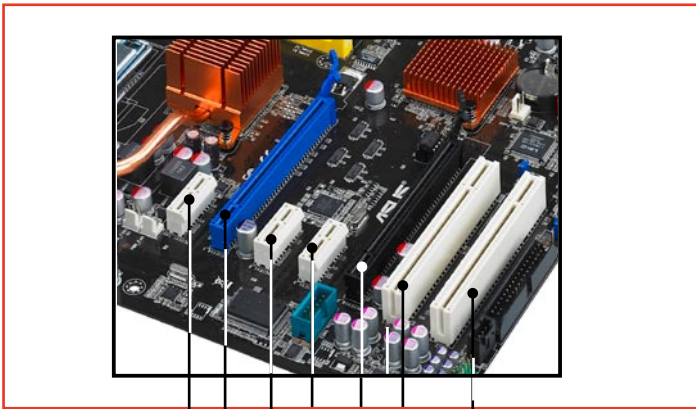

PCI Express x1 slot 1  
PCI Express x1 slot 2  
PCI Express x1 slot 3  
PCI Express 2.0 x16 slot (Blue)  
PCI slot 1  
PCI slot 2  
PCI Express 2.0 x16 slot 2 (Black)



- In single VGA card mode, use first the PCIe 2.0 x16\_1 slot (blue) for a PCI Express x16 graphics card to get better performance.
- In CrossFireX™ mode, use the PCIe 2.0 x16\_1 (blue) and PCIe 2.0 x16\_2 (black) slots for PCI Express x16 graphics cards to get better performance.
- Use the two PCIe 2.0 x16 slots and the universal PCIe x16 slot for 3-Way CrossFireX™ mode.
- We recommend that you provide sufficient power when running CrossFireX™ mode. See page 2-36 for details.
- Connect a chassis fan to the motherboard connector labeled CHA\_FAN1/2/3 when using multiple graphics cards for better thermal environment. See page 2-33 for details.

## 2.6 Jumper

### 1. Clear RTC RAM (3-pin CLRTC)

This jumper allows you to clear the Real Time Clock (RTC) RAM in CMOS. You can clear the CMOS memory of date, time, and system setup parameters by erasing the CMOS RTC RAM data. The onboard button cell battery powers the RAM data in CMOS, which include system setup information such as system passwords.

To erase the RTC RAM:

1. Turn OFF the computer and unplug the power cord.
2. Move the jumper cap from pins 1-2 (default) to pins 2-3. Keep the cap on pins 2-3 for about 5~10 seconds, then move the cap back to pins 1-2.
3. Plug the power cord and turn ON the computer.
4. Hold down the <Del> key during the boot process and enter BIOS setup to re-enter data.



Except when clearing the RTC RAM, never remove the cap on CLRTC jumper default position. Removing the cap will cause system boot failure!



If the steps above do not help, remove the onboard battery and move the jumper again to clear the CMOS RTC RAM data. After the CMOS clearance, reinstall the battery.

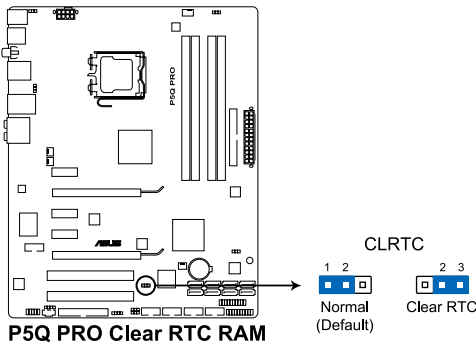

- You do not need to clear the RTC when the system hangs due to overclocking. For system failure due to overclocking, use the C.P.R. (CPU Parameter Recall) feature. Shut down and reboot the system so the BIOS can automatically reset parameter settings to default values.
- Due to the chipset limitation, AC power off is required prior using C.P.R. function. You must turn off and on the power supply or unplug and plug the power cord before reboot the system.

## 2. CPU / Northbridge overvoltage setting (3-pin OV\_CPU, 3-pin OV\_NB)

These jumpers allow you to enable or disable the advanced CPU and Northbridge overvoltage settings in BIOS. Read the following information before you change the jumper settings. Set to pins 1-2 to activate the advanced CPU / Northbridge overvoltage feature.

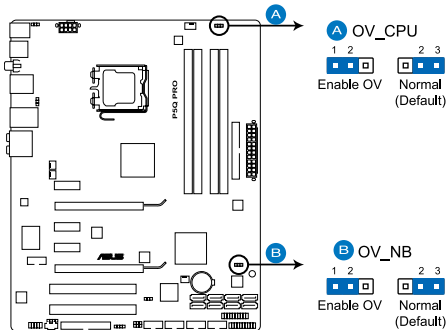

### P5Q PRO CPU/Northbridge overvoltage setting

	OV_CPU	OV_NB
Pins 2-3 (Default)	up to 1.70V	up to 1.90V
Pins 1-2 (OV Enabled)	up to 2.10V	up to 2.20V



- Before you change the jumper settings for extra-high overvoltage ability, use the BIOS items introduced in **3.4 Ai Tweaker** first to adjust the desired CPU and Northbridge performance. Make sure your system function well under the highest BIOS voltage settings before you change the setting of these two jumpers.
- Refer to **3.4 Ai Tweaker** for more information about CPU and Northbridge overvoltage settings.
- DO NOT set the OV\_CPU jumper to pins 1-2 when you install a new CPU and have not booted for the first time. Doing so may cause the system to halt. For system failure due to the wrong setting of the OV\_CPU jumper, shut down the computer and move the cap back to pins 2-3.
- The system may need a better cooling system (for example, a water-cooling system) to work stably under high voltage settings.

### 3. Keyboard/Mouse power (3-pin PS2 USBPWR56)

This jumper allows you to enable or disable the keyboard/mouse wake-up feature. Set this jumper to pins 2-3 (+5VSB) to wake up the computer when you press a key on the keyboard/mouse (the default is the Space Bar). This feature requires an ATX power supply that can supply at least 500 mA on the +5VSB lead, and a corresponding setting in the BIOS.

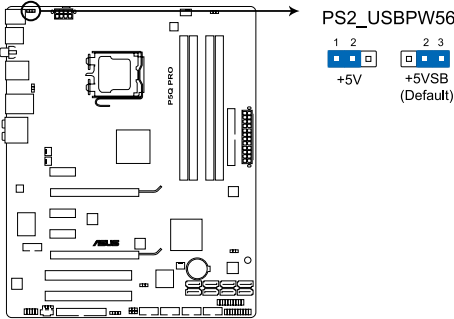

**P5Q PRO Keyboard/Mouse power**

### 4. USB device wake-up (3-pin USBPW1-4, PS2\_USB PWR56, USBPW7-10, USBPW1112)

Set these jumpers to +5V to wake up the computer from S1 sleep mode (CPU stopped, DRAM refreshed, system running in low power mode) using the connected USB devices. Set to +5VSB to wake up from S3 and S4 sleep modes.

The USBPW1-4/PS2\_USB PWR56 jumpers are for the rear USB ports. The USBPW7-10/USBPW1112 jumpers are for the internal USB connectors that you can connect to additional USB ports.

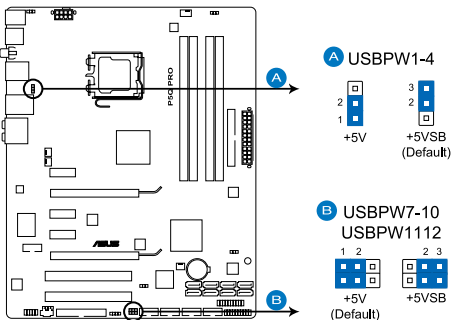

**P5Q PRO USB device wake-up**



- The USB device wake-up feature requires a power supply that can provide 500mA on the +5VSB lead for each USB port; otherwise, the system will not power up.
- The total current consumed must NOT exceed the power supply capability (+5VSB) whether under normal condition or in sleep mode.



## 2.7 Connectors

### 2.7.1 Rear panel connectors

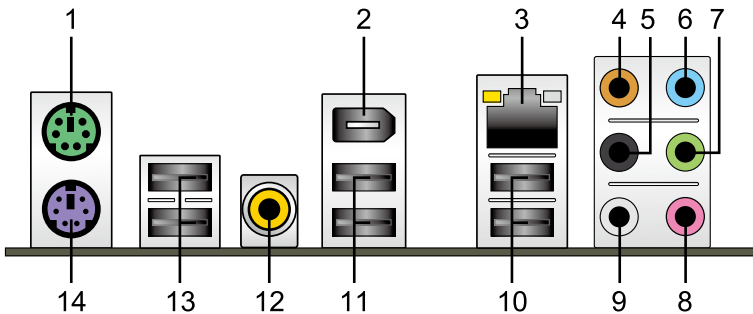

1. **PS/2 mouse port (green).** This port is for a PS/2 mouse.
2. **IEEE 1394a port.** This 6-pin IEEE 1394a port provides high-speed connectivity for audio/video devices, storage peripherals, PCs, or portable devices.
3. **LAN (RJ-45) port.** This port allows Gigabit connection to a Local Area Network (LAN) through a network hub. Refer to the table below for the LAN port LED indications.

#### LAN port LED indications

Activity Link LED		Speed LED	
Status	Description	Status	Description
OFF	No link	OFF	10 Mbps connection
ORANGE	Linked	ORANGE	100 Mbps connection
BLINKING	Data activity	GREEN	1 Gbps connection

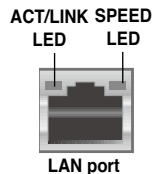

4. **Center/Subwoofer port (orange).** This port connects the center/subwoofer speakers.
5. **Rear Speaker Out port (black).** This port connects the rear speakers on a 4-channel, 6-channel, or 8-channel audio configuration.
6. **Line In port (light blue).** This port connects the tape, CD, DVD player, or other audio sources.
7. **Line Out port (lime).** This port connects a headphone or a speaker. In 4-channel, 6-channel, and 8-channel configuration, the function of this port becomes Front Speaker Out.
8. **Microphone port (pink).** This port connects a microphone.

9. **Side Speaker Out port (gray).** This port connects the side speakers in an 8-channel audio configuration.



Refer to the audio configuration table below for the function of the audio ports in 2, 4, 6, or 8-channel configuration.

**Audio 2, 4, 6, or 8-channel configuration**

Port	Headset 2-channel	4-channel	6-channel	8-channel
Light Blue	Line In	Line In	Line In	Line In
Lime	Line Out	Front Speaker Out	Front Speaker Out	Front Speaker Out
Pink	Mic In	Mic In	Mic In	Mic In
Orange	–	–	Center/Subwoofer	Center/Subwoofer
Black	–	Rear Speaker Out	Rear Speaker Ou	Rear Speaker Out
Gray	–	–	–	Side Speaker Out

10. **USB 2.0 ports 1 and 2 .** These two 4-pin Universal Serial Bus (USB) ports are available for connecting USB 2.0 devices.
11. **USB 2.0 ports 3 and 4.** These 4-pin Universal Serial Bus (USB) ports are available for connecting USB 2.0 devices.
12. **Coaxial S/PDIF Out port.** This port connects an external audio output device via a coaxial S/PDIF cable.
13. **USB 2.0 ports 5 and 6.** These 4-pin Universal Serial Bus (USB) ports are available for connecting USB 2.0 devices.
14. **PS/2 keyboard port (purple).** This port is for a PS/2 keyboard.

## 2.7.2 Internal connectors

### 1. Floppy disk drive connector (34-1 pin FLOPPY)

This connector is for the provided floppy disk drive (FDD) signal cable. Insert one end of the cable to this connector, then connect the other end to the signal connector at the back of the floppy disk drive.



Pin 5 on the connector is removed to prevent incorrect cable connection when using a FDD cable with a covered Pin 5.

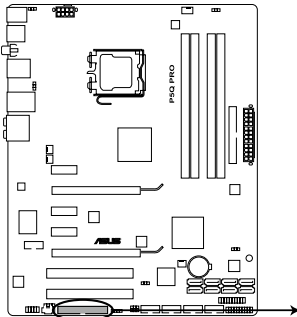

FLOPPY

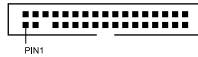

**NOTE:** Orient the red markings on the floppy ribbon cable to PIN 1.

**P5Q PRO Floppy disk drive connector**

## 2. IDE connector (40-1 pin PRI\_EIDE)

The onboard IDE connector is for the Ultra DMA 133/100/66 signal cable. There are three connectors on each Ultra DMA 133/100/66 signal cable: blue, black, and gray. Connect the blue connector to the motherboard's IDE connector, then select one of the following modes to configure your device.

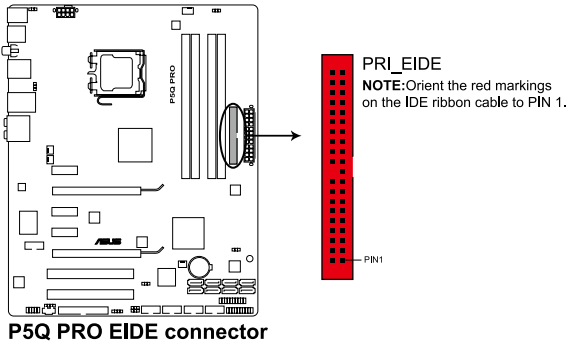

	Drive jumper setting	Mode of device(s)	Cable connector
Single device	Cable-Select or Master	-	Black
Two devices	Cable-Select	Master	Black
		Slave	Gray
	Master	Master	Black or gray
	Slave	Slave	



- Pin 20 on the IDE connector is removed to match the covered hole on the Ultra DMA cable connector. This prevents incorrect insertion when you connect the IDE cable.
- Use the 80-conductor IDE cable for Ultra DMA 133/100/66 IDE devices.



If any device jumper is set as "Cable-Select," make sure all other device jumpers have the same setting.

### 3. ICH10R Serial ATA connectors (7-pin SATA1-6 [red])

These connectors are for the Serial ATA signal cables for Serial ATA hard disk drives.

If you installed Serial ATA hard disk drives, you can create a RAID 0, RAID 1, RAID 5, RAID 10 configuration with the Intel® Matrix Storage Technology through the onboard Intel® ICH10R RAID controller.

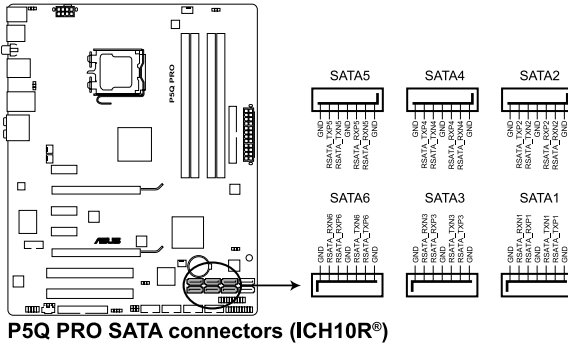

**P5Q PRO SATA connectors (ICH10R®)**



- These connectors are set to Standard IDE mode by default. In Standard IDE mode, you can connect Serial ATA boot/data hard disk drives to these connectors. If you intend to create a Serial ATA RAID set using these connectors, set the **Configure SATA as** item in the BIOS to [RAID]. See section 3.3.6 Storage Configuration for details.
- Before creating a RAID set, refer to section 4.4.3 Intel RAID configurations or the manual bundled in the motherboard support DVD.
- You must install the Windows® XP Service Pack 1 before using Serial ATA hard disk drives. The Serial ATA RAID feature (RAID 0, 1, 5, and 10) is available only if you are using Windows® XP or later version.
- When using hot-plug and NCQ, set the **Configure SATA as** in the BIOS to [AHCI]. See section 3.3.6 Storage Configuration for details.



Connect the right-angle side of SATA signal cable to SATA device. Or you may connect the right-angle side of SATA cable to the onboard SATA port to avoid mechanical conflict with huge graphics cards.

right angle side

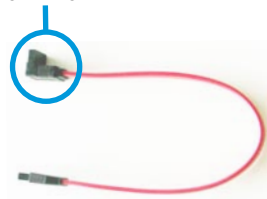

#### 4. Silicon Image® Serial ATA RAID connectors (7-pin SATA\_E1 [Port0, Orange], SATA\_E2 [Port1, White] )

These connectors are for the Serial ATA signal cables for Serial ATA hard disk drives.

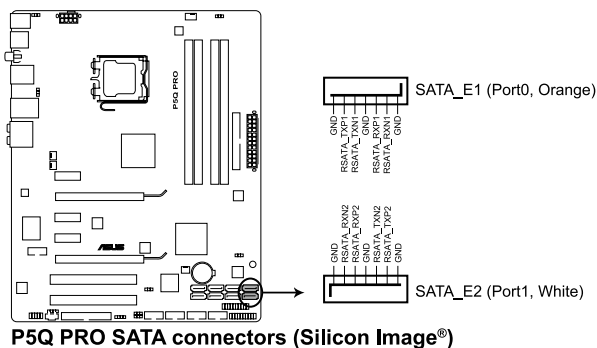

**P5Q PRO SATA connectors (Silicon Image®)**



- The SATA\_E1 (orange, port 0) and SATA\_E2 (white, port 1) ports are for SATA hard drives only. ATAPI device is not supported.
- Make necessary backup before using the **Drive Xpert** function: All data of the SATA\_E2 (port1) hard drive will be erased for **EZ Backup** setup. All data of the two hard drives will be erased for **Super Speed** setup.



Before using the Drive Xpert technology, make sure that you have connected the SATA signal cables and installed SATA hard disk drives.



Refer to **4.3.10 ASUS Drive Xpert** for detailed application instructions.

## 5. USB connectors (10-1 pin USB 78, USB 910, USB 1112)

These connectors are for USB 2.0 ports. Connect the USB module cable to any of these connectors, then install the module to a slot opening at the back of the system chassis. These USB connectors comply with USB 2.0 specification that supports up to 480 Mbps connection speed.

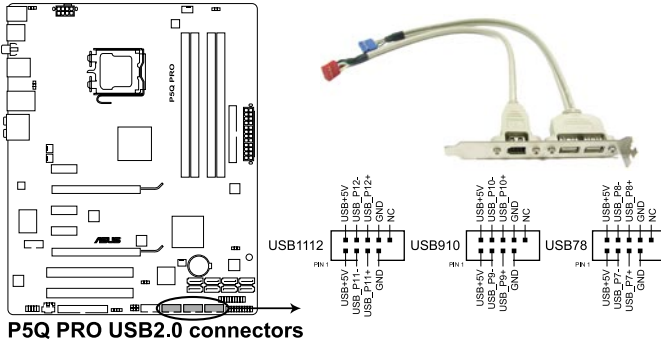

Never connect a 1394 cable to the USB connectors. Doing so will damage the motherboard!



If your chassis supports front panel USB ports, you can attach a front panel USB cable to these connectors. Connect the USB cable to ASUS Q-Connector (USB, blue) first, and then install the Q-Connector (USB) to the USB connector onboard.



This module should be purchased separately.

## 6. Serial port connector (10-1 pin COM1)

This connector is for a serial (COM) port. Connect the serial port module cable to this connector, then install the module to a slot opening at the back of the system chassis.

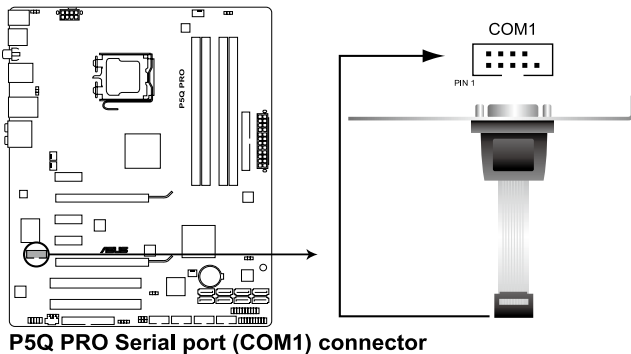

**7. IEEE 1394a port connector (10-1 pin IE1394\_2)**

This connector is for a IEEE 1394a port. Connect the IEEE 1394a module cable to this connector, then install the module to a slot opening at the back of the system chassis.

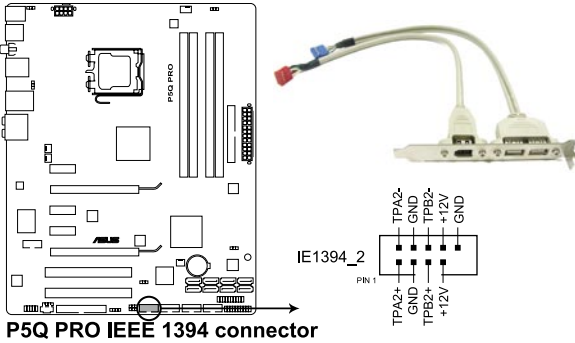

**P5Q PRO IEEE 1394 connector**



Never connect a USB cable to the IEEE 1394a connector. Doing so will damage the motherboard!



You can attach a FireWire/1394 cable to this connector if your chassis supports the front panel IEEE1394 port. Connect the 1394 cable to ASUS Q-Connector (1394, red) first, and then install the Q-Connector (1394) to the 1394 connector onboard.



## 8. CPU, chassis, and power fan connectors (4-pin CPU\_FAN, 3-pin CHA\_FAN1-2, 3-pin PWR\_FAN)

The fan connectors support cooling fans of 350 mA~2000 mA (24 W max.) or a total of 1 A~6 A (72 W max.) at +12V. Connect the fan cables to the fan connectors on the motherboard, making sure that the black wire of each cable matches the ground pin of the connector.

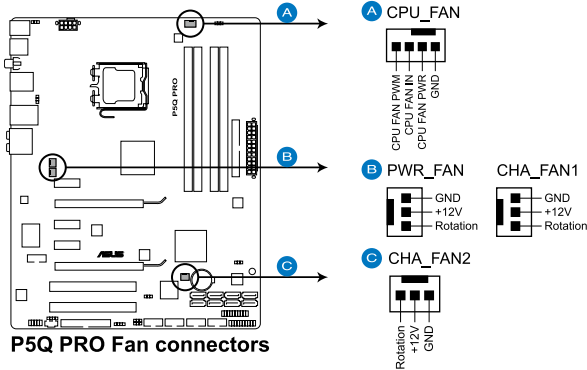

DO NOT forget to connect the fan cables to the fan connectors. Insufficient air flow inside the system may damage the motherboard components. These are not jumpers! DO NOT place jumper caps on the fan connectors!



- Only the CPU-FAN and CHA-FAN 1-3 connectors support the ASUS Q-Fan feature.
- If you install two or more VGA cards, we recommend that you plug the rear chassis fan cable to the motherboard connector labeled CHA\_FAN1, CHA\_FAN2 or CHA\_FAN3 for better thermal environment.

## 9. Optical drive audio connector (4-pin CD)

This connector allows you to receive stereo audio input from sound sources such as a CD-ROM, TV tuner, or MPEG card.

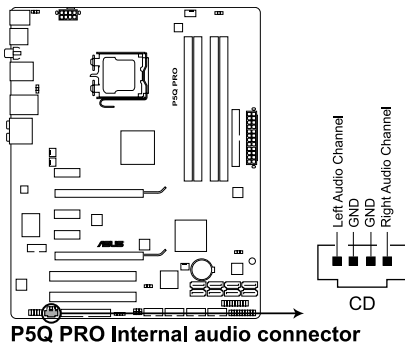

## 10. Chassis intrusion connector (4-1 pin CHASSIS)

This connector is for a chassis-mounted intrusion detection sensor or switch. Connect one end of the chassis intrusion sensor or switch cable to this connector. The chassis intrusion sensor or switch sends a high-level signal to this connector when a chassis component is removed or replaced. The signal is then generated as a chassis intrusion event.

By default, the pin labeled “Chassis Signal” and “Ground” are shorted with a jumper cap. Remove the jumper caps only when you intend to use the chassis intrusion detection feature.

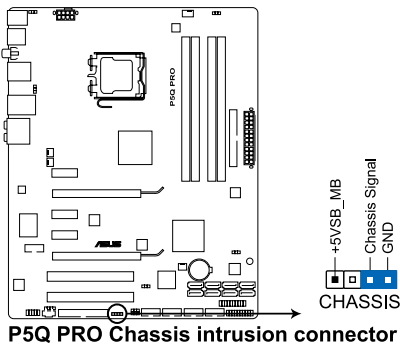

## 11. Digital audio connector (4-1 pin SPDIF\_OUT)

This connector is for an additional Sony/Philips Digital Interface (S/PDIF) port(s).

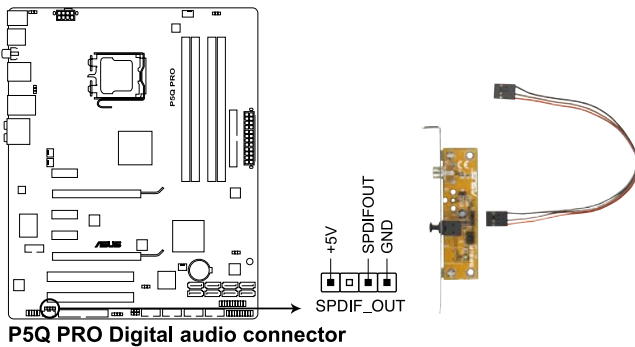

The S/PDIF Out cable are purchased separately.

## 12. Front panel audio connector (10-1 pin AAFP)

This connector is for a chassis-mounted front panel audio I/O module that supports either HD Audio or legacy AC' 97 audio standard. Connect one end of the front panel audio I/O module cable to this connector.

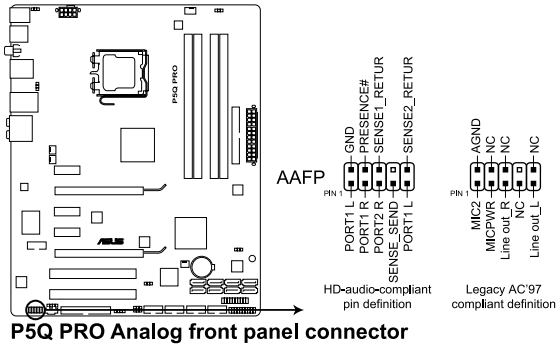

- We recommend that you connect a high-definition front panel audio module to this connector to avail of the motherboard's high-definition audio capability.
- If you want to connect a high-definition front panel audio module to this connector, make sure that the **Front Panel Type** item in the BIOS is set to [HD Audio]. If you want to connect an AC' 97 front panel audio module to this connector, set the item to [AC97]. Refer to page 3-27 for details.

## 13. TPM connector (20-1 pin TPM)

This connector supports a Trusted Platform Module (TPM) system, which can securely store keys, digital certificates, passwords, and data. A TPM system also helps enhance network security, protects digital identities, and ensures platform integrity. See section "3.5.1 Security" for details.

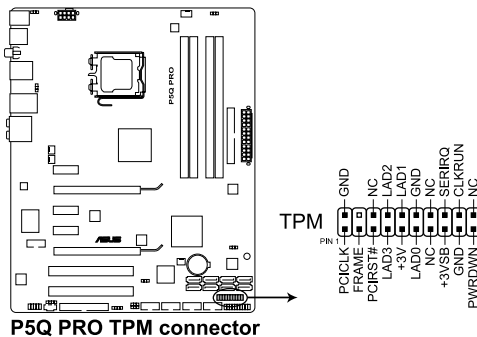

The TPM module is purchased separately. Use the ASUS TPM module ONLY.

#### 14. ATX power connectors (24-pin EATXPWR, 8-pin EATX12V)

These connectors are for ATX power supply plugs. The power supply plugs are designed to fit these connectors in only one orientation. Find the proper orientation and push down firmly until the connectors completely fit.

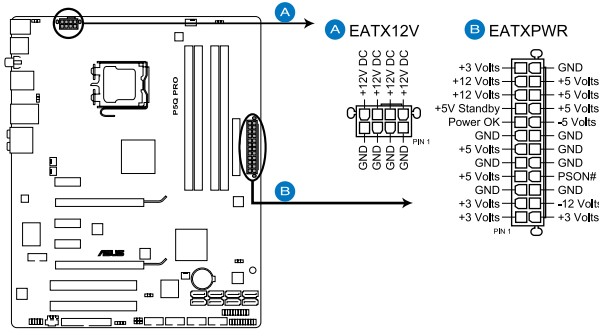

**P5Q PRO ATX power connectors**



- Make sure to remove the cap on the EATX12V connector before connecting an 8-pin EPS +12V power plug.
- Use only an 8-pin EPS +12V power plug for the EATX12V connector.



- For a fully configured system, we recommend that you use a power supply unit (PSU) that complies with ATX 12 V Specification 2.0 (or later version) and provides a minimum power of 400 W.
- Do not forget to connect the 8-pin EATX12V power plug; otherwise, the system will not boot.
- Use of a PSU with a higher power output is recommended when configuring a system with more power-consuming devices. The system may become unstable or may not boot up if the power is inadequate.
- If you want to use two high-end PCI Express x16 cards, use a PSU with 500W to 600W power or above to ensure the system stability.
- If you are uncertain about the minimum power supply requirement for your system, refer to the **Recommended Power Supply Wattage Calculator** at <http://support.asus.com/PowerSupplyCalculator/PSCalculator.aspx?SLanguage=en-us> for details.

## 15. System panel connector (20-pin PANEL)

This connector supports several chassis-mounted functions.

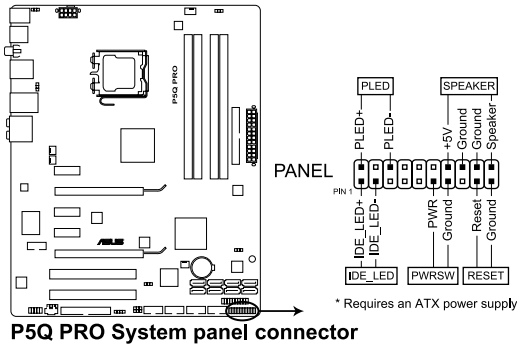

- **System power LED (2-pin PLED)**

This 2-pin connector is for the system power LED. Connect the chassis power LED cable to this connector. The system power LED lights up when you turn on the system power, and blinks when the system is in sleep mode.

- **Hard disk drive activity LED (2-pin IDE\_LED)**

This 2-pin connector is for the HDD Activity LED. Connect the HDD Activity LED cable to this connector. The IDE LED lights up or flashes when data is read from or written to the HDD.

- **System warning speaker (4-pin SPEAKER)**

This 4-pin connector is for the chassis-mounted system warning speaker. The speaker allows you to hear system beeps and warnings.

- **ATX power button/soft-off button (2-pin PWRSW)**

This connector is for the system power button. Pressing the power button turns the system on or puts the system in sleep or soft-off mode depending on the BIOS settings. Pressing the power switch for more than four seconds while the system is ON turns the system OFF.

- **Reset button (2-pin RESET)**

This 2-pin connector is for the chassis-mounted reset button for system reboot without turning off the system power.

### ASUS Q-Connector (system panel)

You can use the ASUS Q-Connector to connect/disconnect chassis front panel cables in a few steps. Refer to the instructions below to install the ASUS Q-Connector.

1. Connect the front panel cables to the ASUS Q-Connector.  
Refer to the labels on the Q-Connector to know the detailed pin definitions, then match them to the respective front panel cable labels.

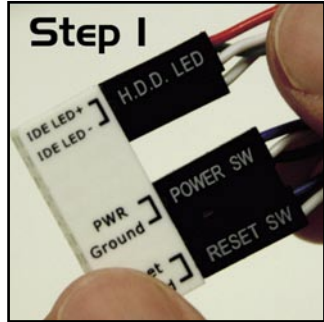

2. Install the ASUS Q-Connector to the system panel connector, making sure the orientation matches the labels on the motherboard.

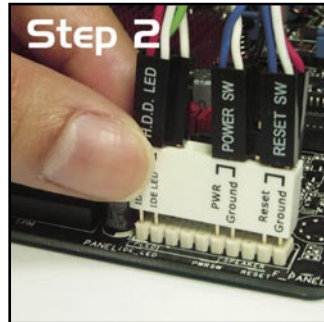

3. The front panel functions are now enabled. The figure shows the Q-Connector properly installed on the motherboard.

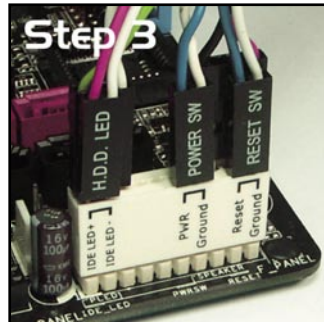

## 2.8 Starting up for the first time

1. After making all the connections, replace the system case cover.
2. Be sure that all switches are off.
3. Connect the power cord to the power connector at the back of the system chassis.
4. Connect the power cord to a power outlet that is equipped with a surge protector.
5. Turn on the devices in the following order:
  - a. Monitor
  - b. External SCSI devices (starting with the last device on the chain)
  - c. System power
6. After applying power, the system power LED on the system front panel case lights up. For systems with ATX power supplies, the system LED lights up when you press the ATX power button. If your monitor complies with “green” standards or if it has a “power standby” feature, the monitor LED may light up or switch between orange and green after the system LED turns on.

The system then runs the power-on self tests or POST. While the tests are running, the BIOS beeps (see BIOS beep codes table below) or additional messages appear on the screen. If you do not see anything within 30 seconds from the time you turned on the power, the system may have failed a power-on test. Check the jumper settings and connections or call your retailer for assistance.

BIOS Beep	Description
One short beep	VGA detected Quick boot set to disabled No keyboard detected
One continuous beep followed by two short beeps then a pause (repeated)	No memory detected
One continuous beep followed by three short beeps	No VGA detected
One continuous beep followed by four short beeps	Hardware component failure

7. At power on, hold down the <Delete> key to enter the BIOS Setup. Follow the instructions in Chapter 3.

## 2.9 Turning off the computer

### 2.9.1 Using the OS shut down function

If you are using Windows® Vista™:

1. Click the **Start** button then select **ShutDown**.
2. The power supply should turn off after Windows® shuts down.

If you are using Windows® XP:

1. Click the **Start** button then select **Turn Off Computer**.
2. Click the **Turn Off** button to shut down the computer.
3. The power supply should turn off after Windows® shuts down.

### 2.9.2 Using the dual function power switch

While the system is ON, pressing the power switch for less than four seconds puts the system to sleep mode or to soft-off mode, depending on the BIOS setting. Pressing the power switch for more than four seconds lets the system enter the soft-off mode regardless of the BIOS setting. Refer to section 3.6 Power Menu for details.



This chapter tells how to change the system settings through the BIOS Setup menus. Detailed descriptions of the BIOS parameters are also provided.

# BIOS setup **3**

<b>3.1</b>	<b>Managing and updating your BIOS .....</b>	<b>3-1</b>
<b>3.2</b>	<b>BIOS setup program .....</b>	<b>3-9</b>
<b>3.3</b>	<b>Main menu .....</b>	<b>3-12</b>
<b>3.4</b>	<b>Ai Tweaker .....</b>	<b>3-17</b>
<b>3.5</b>	<b>Advanced menu .....</b>	<b>3-23</b>
<b>3.6</b>	<b>Power menu.....</b>	<b>3-31</b>
<b>3.7</b>	<b>Boot menu .....</b>	<b>3-35</b>
<b>3.8</b>	<b>Tools menu .....</b>	<b>3-39</b>
<b>3.9</b>	<b>Exit menu.....</b>	<b>3-43</b>

## 3.1 Managing and updating your BIOS

The following utilities allow you to manage and update the motherboard Basic Input/Output System (BIOS) setup.

1. **ASUS Update** (Updates the BIOS in Windows® environment.)
2. **ASUS EZ Flash 2** (Updates the BIOS using a floppy disk or USB flash disk.)
3. **ASUS AFUDOS** (Updates the BIOS using a bootable floppy disk)  
Refer to the corresponding sections for details on these utilities.
4. **ASUS CrashFree BIOS 3** (Updates the BIOS using a USB flash disk or the motherboard support DVD when the BIOS file fails or gets corrupted.)



---

Save a copy of the original motherboard BIOS file to a bootable floppy disk or USB flash disk in case you need to restore the BIOS in the future. Copy the original motherboard BIOS using the ASUS Update or AFUDOS utilities.

---

### 3.1.1 ASUS Update utility

The ASUS Update is a utility that allows you to manage, save, and update the motherboard BIOS in Windows® environment. The ASUS Update utility allows you to:

- Save the current BIOS file
- Download the latest BIOS file from the Internet
- Update the BIOS from an updated BIOS file
- Update the BIOS directly from the Internet, and
- View the BIOS version information.

This utility is available in the support DVD that comes with the motherboard package.



---

ASUS Update requires an Internet connection either through a network or an Internet Service Provider (ISP).

---

### Installing ASUS Update

To install ASUS Update:

1. Place the support DVD in the optical drive. The Drivers menu appears.
2. Click the Utilities tab, then click Install ASUS Update VX.XX.XX.
3. The ASUS Update utility is copied to your system.



Quit all Windows® applications before you update the BIOS using this utility.

## Updating the BIOS through the Internet

To update the BIOS through the Internet:

1. Launch the ASUS Update utility from the Windows® desktop by clicking **Start > Programs > ASUS > ASUSUpdate > ASUSUpdate**. The ASUS Update main window appears.

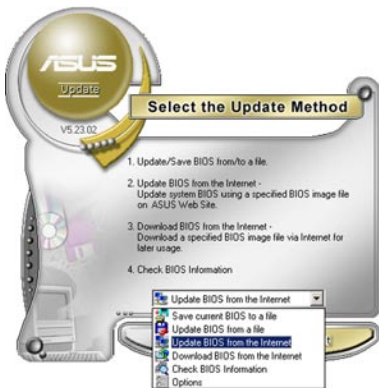
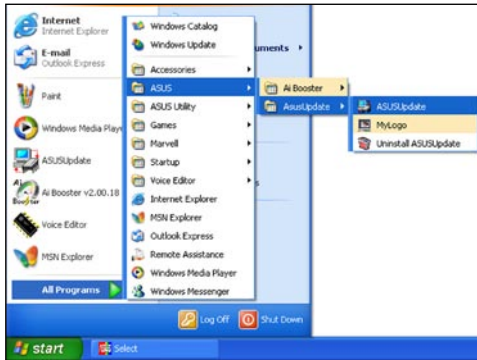

2. Select **Update BIOS** from the Internet option from the drop-down menu, then click **Next**.



3. Select the ASUS FTP site nearest you to avoid network traffic, or click **Auto Select**. Click **Next**.

- From the FTP site, select the BIOS version that you wish to download. Click **Next**.
- Follow the screen instructions to complete the update process.



The ASUS Update utility is capable of updating itself through the Internet. Always update the utility to avail all its features.



## Updating the BIOS through a BIOS file

To update the BIOS through a BIOS file:

- Launch the ASUS Update utility from the Windows® desktop by clicking **Start** > **Programs** > **ASUS** > **ASUSUpdate** > **ASUSUpdate**. The ASUS Update main window appears.
- Select **Update BIOS** from a file option from the drop-down menu, then click **Next**.

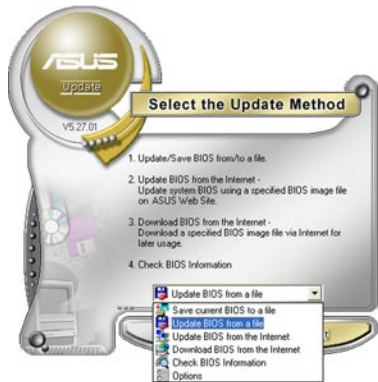

- Locate the BIOS file from the Open window, then click **Open**.
- Follow the screen instructions to complete the update process.

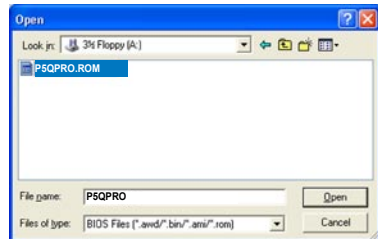

### 3.1.2 ASUS EZ Flash 2 utility

The ASUS EZ Flash 2 feature allows you to update the BIOS without having to go through the long process of booting from a floppy disk and using a DOS-based utility. The EZ Flash 2 utility is built-in the BIOS chip so it is accessible by pressing <Alt> + <F2> during the Power-On Self Tests (POST).

To update the BIOS using EZ Flash 2

1. Visit the ASUS website (www.asus.com) to download the latest BIOS file for the motherboard.
2. Save the BIOS file to a floppy disk or a USB flash disk, then restart the system.
3. You can launch the EZ Flash 2 by two methods.
  - (1) Insert the floppy disk / USB flash disk that contains the BIOS file to the floppy disk drive or the USB port.  
Press <Alt> + <F2> during POST to display the following.

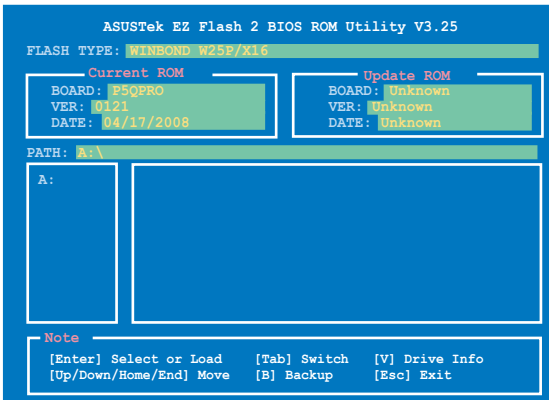

- (2) Enter BIOS setup program. Go to the **Tools** menu to select **EZ Flash2** and press <Enter> to enable it.  
You can switch between drives by pressing <Tab> before the correct file is found. Then press <Enter>.
4. When the correct BIOS file is found, EZ Flash 2 performs the BIOS update process and automatically reboots the system when done.



- This function can support devices such as a USB flash disk or a floppy disk with **FAT 32/16** format and single partition only.
- DO NOT shut down or reset the system while updating the BIOS to prevent system boot failure!

### 3.1.3 AFUDOS utility

The AFUDOS utility allows you to update the BIOS file in DOS environment using a bootable floppy disk with the updated BIOS file. This utility also allows you to copy the current BIOS file that you can use as backup when the BIOS fails or gets corrupted during the updating process.

#### Copying the current BIOS

To copy the current BIOS file using the AFUDOS utility



- Make sure that the floppy disk is not write-protected and has at least 1024KB free space to save the file.
- The succeeding BIOS screens are for reference only. The actual BIOS screen displays may not be same as shown.

1. Copy the AFUDOS utility (afudos.exe) from the motherboard support DVD to the bootable floppy disk you created earlier.
2. Boot the system in DOS mode, then at the prompt type:

```
afudos /o[filename]
```

where the [filename] is any user-assigned filename not more than eight alphanumeric characters for the main filename and three alphanumeric characters for the extension name.

```
A:\>afudos /oOLDBIOS1.rom
```

Main filename    Extension name

3. Press <Enter>. The utility copies the current BIOS file to the floppy disk.

```
A:\>afudos /oOLDBIOS1.rom
AMI Firmware Update Utility - Version 1.19 (ASUS V2.07 (03.11.24BB))
Copyright (C) 2002 American Megatrends, Inc. All rights reserved.
Reading flash ..... done
Write to file..... ok
A:\>
```

The utility returns to the DOS prompt after copying the current BIOS file.

#### Updating the BIOS file

To update the BIOS file using the AFUDOS utility:

1. Visit the ASUS website ([www.asus.com](http://www.asus.com)) and download the latest BIOS file for the motherboard. Save the BIOS file to a bootable floppy disk.



---

Write the BIOS filename on a piece of paper. You need to type the exact BIOS filename at the DOS prompt.

---

- Copy the AFUDOS utility (afudos.exe) from the motherboard support DVD to the bootable floppy disk you created earlier.
- Boot the system in DOS mode, then at the prompt type:  
**afudos /i[filename]**

where [filename] is the latest or the original BIOS file on the bootable floppy disk.

```
A:\>afudos /iP5QPRO.ROM
```

- The utility verifies the file and starts updating the BIOS.

```
A:\>afudos /iP5QPRO.ROM
AMI Firmware Update Utility - Version 1.19(ASUS V2.07(03.11.24BB))
Copyright (C) 2002 American Megatrends, Inc. All rights reserved.

WARNING!! Do not turn off power during flash BIOS
Reading file ..... done
Reading flash ..... done

Advance Check .....
Erasing flash ..... done
Writing flash ..... 0x0008CC00 (9%)
```



---

**DO NOT** shut down or reset the system while updating the BIOS to prevent system boot failure!

---

- The utility returns to the DOS prompt after the BIOS update process is completed. Reboot the system from the hard disk drive.

```
A:\>afudos /iP5QPRO.ROM
AMI Firmware Update Utility - Version 1.19(ASUS V2.07(03.11.24BB))
Copyright (C) 2002 American Megatrends, Inc. All rights reserved.

WARNING!! Do not turn off power during flash BIOS
Reading file ..... done
Reading flash ..... done

Advance Check .....
Erasing flash ..... done
Writing flash ..... done
Verifying flash .... done

Please restart your computer

A:\>
```



### 3.1.4 ASUS CrashFree BIOS 3 utility

The ASUS CrashFree BIOS 3 is an auto recovery tool that allows you to restore the BIOS file when it fails or gets corrupted during the updating process. You can update a corrupted BIOS file using the motherboard support DVD or the USB flash disk that contains the updated BIOS file.



- Prepare the motherboard support DVD or the USB flash disk containing the updated motherboard BIOS before using this utility.
- If you use a SATA optical drive, always connect the SATA cable to the SATA1/SATA 2/SATA3/SATA4/SATA5/SATA6 connector; otherwise, the utility will not function.

#### Recovering the BIOS from the support DVD

To recover the BIOS from the support DVD:

1. Turn on the system.
2. Insert the motherboard support DVD to the optical drive.
3. The utility displays the following message and automatically checks the DVD for the BIOS file.

```
Bad BIOS checksum. Starting BIOS recovery...
Checking for floppy...
```

When found, the utility reads the BIOS file and starts flashing the corrupted BIOS file.

```
Bad BIOS checksum. Starting BIOS recovery...
Checking for floppy...
Floppy found!
Reading file "P5QPRO.ROM". Completed.
Start flashing...
```

4. Restart the system after the utility completes the updating process.

#### Recovering the BIOS from the USB flash disk

To recover the BIOS from the USB flash disk:

1. Insert the USB flash disk that contains BIOS file to the USB port.
2. Turn on the system.
3. The utility will automatically checks the devices for the BIOS file. When found, the utility reads the BIOS file and starts flashing the corrupted BIOS file.
4. Restart the system after the utility completes the updating process.



- Only the USB flash disk with FAT 32/16 format and single partition can support ASUS CrashFree BIOS 3. The device size should be smaller than 8GB.
- DO NOT shut down or reset the system while updating the BIOS! Doing so can cause system boot failure!

## 3.2 BIOS setup program

This motherboard supports a programmable firmware chip that you can update using the provided utility described in section 3.1 **Managing and updating your BIOS**.

Use the BIOS Setup program when you are installing a motherboard, reconfiguring your system, or prompted to “Run Setup.” This section explains how to configure your system using this utility.

Even if you are not prompted to use the Setup program, you can change the configuration of your computer in the future. For example, you can enable the security password feature or change the power management settings. This requires you to reconfigure your system using the BIOS Setup program so that the computer can recognize these changes and record them in the CMOS RAM of the SPI chip.

The firmware chip on the motherboard stores the Setup utility. When you start up the computer, the system provides you with the opportunity to run this program. Press <Del> during the Power-On Self-Test (POST) to enter the Setup utility; otherwise, POST continues with its test routines.

If you wish to enter Setup after POST, restart the system by pressing <Ctrl+Alt+Delete>, or by pressing the reset button on the system chassis. You can also restart by turning the system off and then back on. Do this last option only if the first two failed.

The Setup program is designed to make it as easy to use as possible. Being a menu-driven program, it lets you scroll through the various sub-menus and make your selections from the available options using the navigation keys.



- 
- The default BIOS settings for this motherboard apply for most conditions to ensure optimum performance. If the system becomes unstable after changing any BIOS settings, load the default settings to ensure system compatibility and stability. Select the **Load Setup Defaults** item under the Exit Menu. See section 3.9 **Exit Menu**.
  - The BIOS setup screens shown in this section are for reference purposes only, and may not exactly match what you see on your screen.
  - Visit the ASUS website ([www.asus.com](http://www.asus.com)) to download the latest BIOS file for this motherboard.
-

## 3.2.1 BIOS menu screen

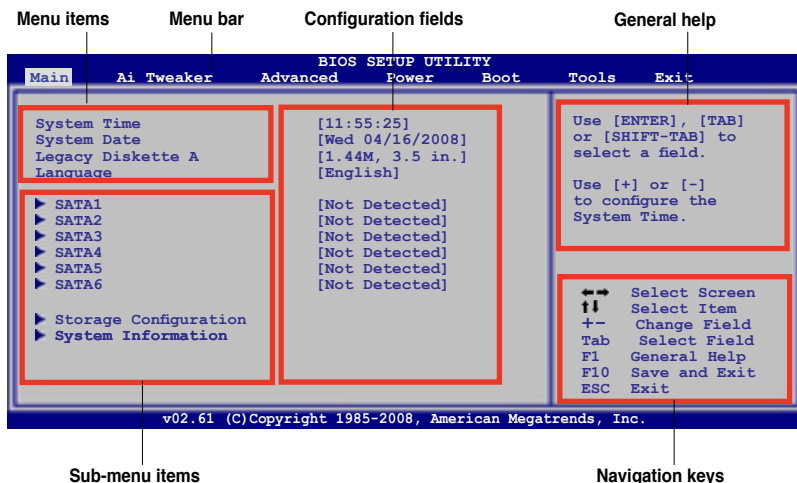

## 3.2.2 Menu bar

The menu bar on top of the screen has the following main items:

- |                   |  |
|-------------------|--|
| <b>Main</b>       | For changing the basic system configuration                    |
| <b>Ai Tweaker</b> | For changing the overclocking settings                         |
| <b>Advanced</b>   | For changing the advanced system settings                      |
| <b>Power</b>      | For changing the advanced power management (APM) configuration |
| <b>Boot</b>       | For changing the system boot configuration                     |
| <b>Tools</b>      | For configuring options for special functions                  |
| <b>Exit</b>       | For selecting the exit options and loading default settings    |

To select an item on the menu bar, press the right or left arrow key on the keyboard until the desired item is highlighted.

## 3.2.3 Navigation keys

At the bottom right corner of a menu screen are the navigation keys for that particular menu. Use the navigation keys to select items in the menu and change the settings.



The navigation keys may differ from one screen to another.

### 3.2.4 Menu items

The highlighted item on the menu bar displays the specific items for that menu. For example, selecting Main shows the Main menu items.

The other items (Advanced, Power, Boot, and Exit) on the menu bar have their respective menu items.

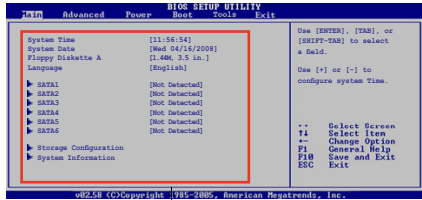

Main menu items

### 3.2.5 Sub-menu items

A solid triangle before each item on any menu screen means that the item has a sub-menu. To display the sub-menu, select the item and press <Enter>.

### 3.2.6 Configuration fields

These fields show the values for the menu items. If an item is user-configurable, you can change the value of the field opposite the item. You cannot select an item that is not user-configurable.

A configurable field is enclosed in brackets, and is highlighted when selected. To change the value of a field, select it then press <Enter> to display a list of options. Refer to 3.2.7 Pop-up window.

### 3.2.7 Pop-up window

Select a menu item then press <Enter> to display a pop-up window with the configuration options for that item.

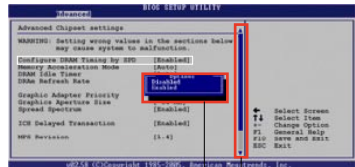

Pop-up window

Scroll bar

### 3.2.8 Scroll bar

A scroll bar appears on the right side of a menu screen when there are items that do not fit on the screen. Press the Up/Down arrow keys or <Page Up> /<Page Down> keys to display the other items on the screen.

### 3.2.9 General help

At the top right corner of the menu screen is a brief description of the selected item.

## 3.3 Main menu

When you enter the BIOS Setup program, the Main menu screen appears, giving you an overview of the basic system information.



Refer to section **3.2.1 BIOS menu screen** for information on the menu screen items and how to navigate through them.

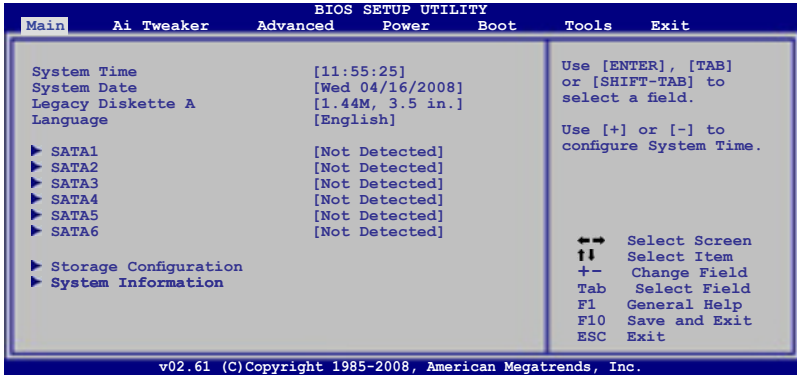

### 3.3.1 System Time [xx:xx:xx]

Allows you to set the system time.

### 3.3.2 System Date [Day xx/xx/xxxx]

Allows you to set the system date.

### 3.3.3 Legacy Diskette A [1.44M, 3.5 in.]

Sets the type of floppy drive installed.

Configuration options: [Disabled] [720K , 3.5 in.] [1.44M, 3.5 in.]

### 3.3.4 Language [English]

Allows you to select the display language for the BIOS setup screen.

Configuration options: [Chinese(BIG5)] [Chinese(GB)] [English]

### 3.3.5 SATA 1-6

While entering Setup, the BIOS automatically detects the presence of Serial ATA devices. There is a separate sub-menu for each SATA device. Select a device item then press <Enter> to display the SATA device information.

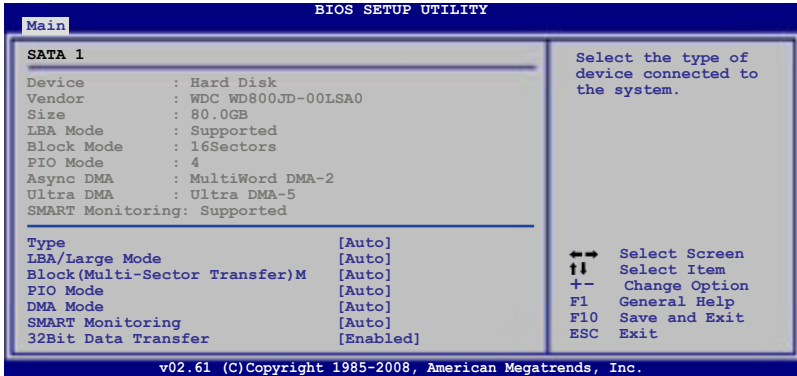

The BIOS automatically detects the values opposite the dimmed items (Device, Vendor, Size, LBA Mode, Block Mode, PIO Mode, Async DMA, Ultra DMA, and SMART monitoring). These values are not user-configurable. These items show N/A if no IDE device is installed in the system.

#### Type [Auto]

Selects the type of IDE drive. Setting to [Auto] allows automatic selection of the appropriate IDE device type. Select [CDROM] if you are specifically configuring a CD-ROM drive. Select [ARMD] (ATAPI Removable Media Device) if your device is either a ZIP, LS-120, or MO drive.

Configuration options: [Not Installed] [Auto] [CDROM] [ARMD]

#### LBA/Large Mode [Auto]

Enables or disables the LBA mode. Setting to [Auto] enables the LBA mode if the device supports this mode, and if the device was not previously formatted with LBA mode disabled.

Configuration options: [Disabled] [Auto]

#### Block (Multi-Sector Transfer) M [Auto]

Enables or disables data multi-sectors transfers. When set to [Auto], the data transfer from and to the device occurs multiple sectors at a time if the device supports multi-sector transfer feature. When set to [Disabled], the data transfer from and to the device occurs one sector at a time.

Configuration options: [Disabled] [Auto]

#### PIO Mode [Auto]

Allows you to select the data transfer mode.

Configuration options: [Auto] [0] [1] [2] [3] [4]

## DMA Mode [Auto]

Selects the DMA mode.

Configuration options: [Auto] [SWDMA0] [SWDMA1] [SWDMA2] [MWDMA0] [MWDMA1] [MWDMA2] [UDMA0] [UDMA1] [UDMA2] [UDMA3] [UDMA4] [UDMA5]

## SMART Monitoring [Auto]

Sets the Smart Monitoring, Analysis, and Reporting Technology.

Configuration options: [Auto] [Disabled] [Enabled]

## 32Bit Data Transfer [Enabled]

Enables or disables 32-bit data transfer.

Configuration options: [Disabled] [Enabled]

## 3.3.6 Storage Configuration

The items in this menu allow you to set or change the configurations for the SATA devices installed in the system. Select an item then press <Enter> if you want to configure the item.

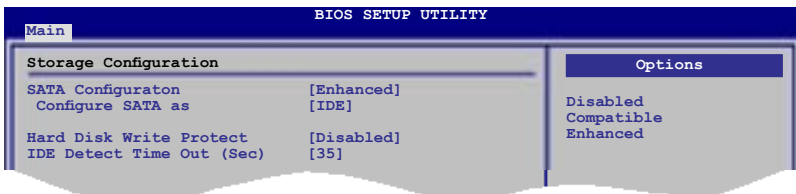

### SATA Configuration [Enhanced]

Configuration options: [Disabled] [Compatible] [Enhanced]

#### Configure SATA as [IDE]

Sets the configuration for the Serial ATA connectors supported by the Southbridge chip. Configuration options: [IDE] [RAID] [AHCI]



- If you want to use the Serial ATA hard disk drives as Parallel ATA physical storage devices, keep the default setting [IDE].
- If you want the Serial ATA hard disk drives to use the Advanced Host Controller Interface (AHCI), set this item to [AHCI]. The AHCI allows the onboard storage driver to enable advanced Serial ATA features that increases storage performance on random workloads by allowing the drive to internally optimize the order of commands.
- If you want to create a RAID 0, RAID 1, RAID 5, RAID 10, or the Intel® Matrix Storage Technology configuration from the Serial ATA hard disk drives, set this item to [RAID].

### Hard Disk Write Protect [Disabled]

Disables or enables device write protection. This will be effective only if the device is accessed through BIOS.

Configuration option: [Disabled] [Enabled]

### IDE Detect Time Out (Sec) [35]

Selects the time out value for detecting ATA/ATAPI devices.

Configuration options: [0] [5] [10] [15] [20] [25] [30] [35]

## 3.3.7 AHCI Configuration

This menu is the section for AHCI configuration. It appears only when you set the item **Configure SATA as** from the sub-menu of **SATA Configuration** to [AHCI].

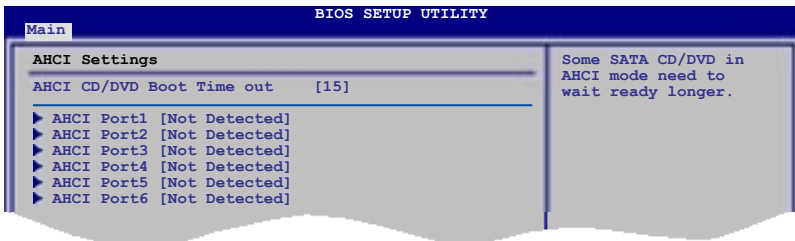

### AHCI CD/DVD Boot Time out [15]

Selects the boot time out value for ACHI CD/DVD devices.

Configuration options: [0] [5] [10] [15] [20] [25] [30] [35]

### AHCI Port1~6 [XXXX]

Displays the status of auto-detection of SATA devices.

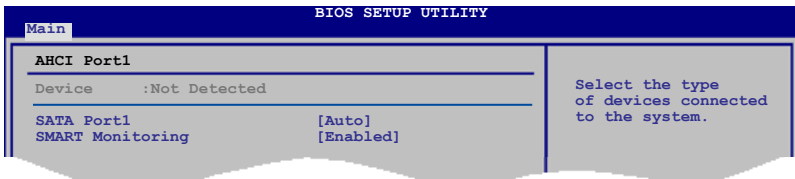

#### SATA Port1 [Auto]

Allows you to select the type of device connected to the system.

Configuration options: [Auto] [Not Installed]

#### SMART Monitoring [Enabled]

Allows you to set the Self-Monitoring, Analysis and Reporting Technology.

Configuration options: [Disabled] [Enabled]



### 3.3.8 System Information

This menu gives you an overview of the general system specifications. The BIOS automatically detects the items in this menu.

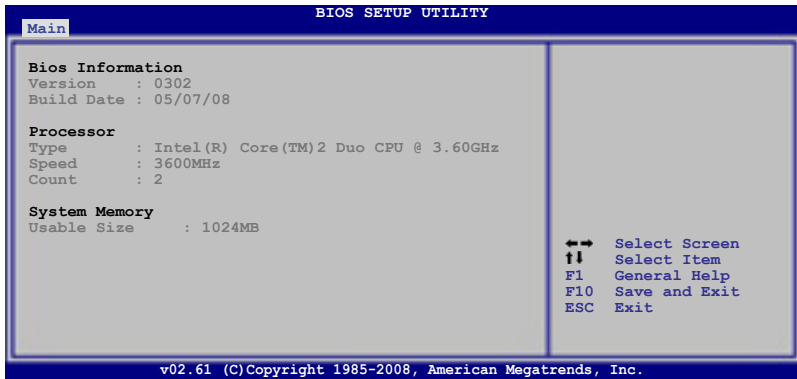

#### Bios Information

Displays the auto-detected BIOS information.

#### Processor

Displays the auto-detected CPU specification.

#### System Memory

Displays the auto-detected system memory.

## 3.4 Ai Tweaker menu

The Ai Tweaker menu items allow you to configure overclocking-related items.



Take caution when changing the settings of the Ai Tweaker menu items. Incorrect field values can cause the system to malfunction.



The default values of the following items vary depending on the CPU and memory modules you install on the motherboard.

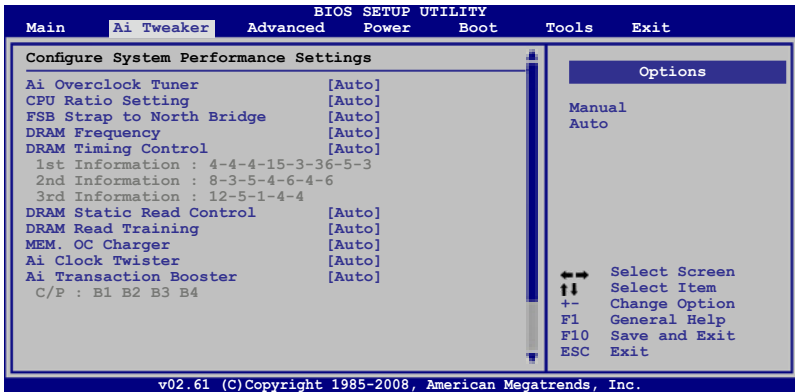

Scroll down to display the following items:

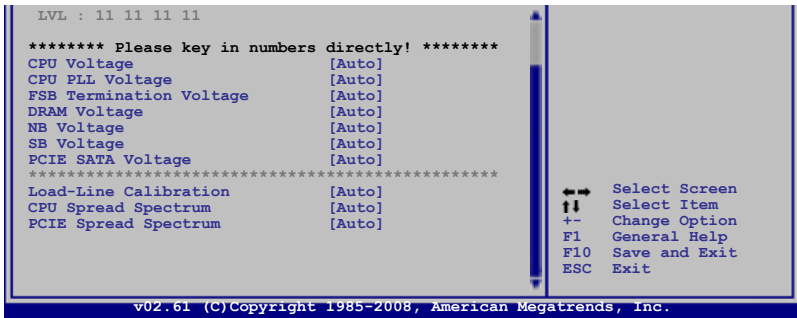

### 3.4.1 Ai Overclock Tuner [Auto]

Allows selection of CPU overclocking options to achieve desired CPU internal frequency. Select either one of the preset overclocking configuration options:

<b>Manual</b>	Allows you to individually set overclocking parameters.
<b>Auto</b>	Loads the optimal settings for the system.

### 3.4.2 CPU Ratio Setting [Auto]

Allows you to adjust the ratio between CPU Core Clock and FSB Frequency. Use the <+> and <-> keys to adjust the value.

Configuration options: [Auto] [06.0] [07.0] [08.0] [09.0]



The following two items appear only when you set the **Ai Overclock Tuner** item to [Manual].

### FSB Frequency [XXX]

Displays the frequency sent by the clock generator to the system bus and PCI bus. The value of this item is auto-detected by the BIOS. Use the <+> and <-> keys to adjust the FSB frequency. You can also type the desired CPU frequency using the numeric keypad. The values range from 200 to 800. Refer to the table below for the correct Front Side Bus and CPU External Frequency settings.

#### FSB/CPU External Frequency Synchronization

Front Side Bus	FSB 1600	FSB 1333	FSB 1066	FSB 800
CPU External Frequency	400 MHz	333 MHz	266 MHz	200 MHz

### PCI Express Frequency [Auto]

Allows you to set the PCI Express frequency. Use the <+> and <-> keys to adjust the PCI Express frequency. The values range from 100 to 180.

### 3.4.3 FSB Strap to North Bridge [Auto]

When set to [Auto], the FSB Strap will be adjusted automatically by FSB Frequency and DRAM Frequency.

Configuration options: [Auto] [200 MHz] [266 MHz] [333 MHz] [400 MHz]

### 3.4.4 DRAM Frequency [Auto]

Allows you to set the DDR2 operating frequency.

Configuration options: [Auto] [DDR2-667 MHz] [DDR2-800 MHz] [DDR2-835MHz] [DDR2-887 MHz] [DDR2-1002MHz] [DDR2-1066MHz] [DDR2-1111] [DDR2-1335MHz]



The **DRAM Frequency** configuration options vary with the **FSB Frequency** item settings.



Selecting a very high DRAM frequency may cause the system to become unstable! If this happens, revert to the default setting.

### 3.4.5 DRAM Timing Control [Auto]

Configuration options: [Auto] [Manual]



- The following sub-items appear only when you set the **DRAM Timing Control** item to [Manual].
- The configuration options for some of the following items vary depending on the DIMMs you install on the motherboard.

---

#### 1st Information: 4-4-15-3-36-5-3

The values vary depending on your settings of the following sub-items:

CAS# Latency [ 5 DRAM Clocks]

Configuration options: [3 DRAM Clocks] [4 DRAM Clocks] [5 DRAM Clocks] [6 DRAM Clocks] [7 DRAM Clocks] [8 DRAM Clocks] [9 DRAM Clocks] [10 DRAM Clocks] [11 DRAM Clocks]

DRAM RAS# to CAS# Delay [ 5 DRAM Clocks]

Configuration options: [3 DRAM Clocks] [4 DRAM Clocks] – [17 DRAM Clocks] [18 DRAM Clocks]

DRAM RAS# Precharge [ 5 DRAM Clocks]

Configuration options: [3 DRAM Clocks] [4 DRAM Clocks] – [17 DRAM Clocks] [18 DRAM Clocks]

DRAM RAS# Activate to Precharge Time [15 DRAM Clocks]

Configuration options: [3 DRAM Clocks] [4 DRAM Clocks] – [33 DRAM Clocks] [34 DRAM Clocks]

RAS# to RAS# Delay [Auto]

Configuration options: [Auto] [1 DRAM Clocks] – [15 DRAM Clocks]

Row Refresh Cycle Time [Auto]

Configuration options: [Auto] [20 DRAM Clocks] [25 DRAM Clocks] [30 DRAM Clocks] [35 DRAM Clocks] [42 DRAM Clocks]

Write Recovery Time [Auto]

Configuration options: [Auto] [1 DRAM Clocks] – [15 DRAM Clocks]

Read to Precharge Time [Auto]

Configuration options: [Auto] [1 DRAM Clocks] – [15 DRAM Clocks]

## 2nd Information: 8-3-5-4-6-4-6

The values vary depending on your settings of the following sub-items:

READ to WRITE Delay(S/D) [Auto]

Configuration options: [Auto] [1 DRAM Clocks] – [15 DRAM Clocks]

Write to Read Delay(S) [Auto]

Configuration options: [Auto] [1 DRAM Clocks] – [15 DRAM Clocks]

WRITE to READ Delay(D) [Auto]

Configuration options: [Auto] [1 DRAM Clocks] – [15 DRAM Clocks]

READ To READ Delay(S) [Auto]

Configuration options: [Auto] [1 DRAM Clocks] – [15 DRAM Clocks]

READ To READ Delay(D) [Auto]

Configuration options: [Auto] [1 DRAM Clocks] – [15 DRAM Clocks]

WRITE To WRITE Delay(S) [Auto]

Configuration options: [Auto] [1 DRAM Clocks] – [15 DRAM Clocks]

WRITE To WRITE Delay(D) [Auto]

Configuration options: [Auto] [1 DRAM Clocks] – [15 DRAM Clocks]

## 3rd Information: 12-5-1-4-4

The values vary depending on your settings of the following sub-items:

WRITE to PRE Delay [Auto]

Configuration options: [Auto] [1 DRAM Clocks] – [31 DRAM Clocks]

READ to PRE Delay [Auto]

Configuration options: [Auto] [1 DRAM Clocks] – [15 DRAM Clocks]

PRE to PRE Delay [Auto]

Configuration options: [Auto] [1 DRAM Clocks] – [3 DRAM Clocks]

ALL PRE to ACT Delay [Auto]

Configuration options: [Auto] [1 DRAM Clocks] – [15 DRAM Clocks]

ALL PRE to REF Delay [Auto]

Configuration options: [Auto] [1 DRAM Clocks] – [15 DRAM Clocks]

### 3.4.6 DRAM Static Read Control [Auto]

Adjusting this item might enhance DRAM overclocking ability.

Configuration options: [Auto] [Disabled] [Enabled]

### 3.4.7 DRAM Read Training [Auto]

Allows you to set DRAM read data timing optimization. Setting this item to [Disabled] may help enhance DRAM overclocking ability.

Configuration options: [Auto] [Disabled] [Enabled]

### 3.4.8 MEM. OC Charger

Allows you to enable or disable the memory overclocking charger feature. Setting this item to [Enabled] may help enhance DRAM overclock ability.

Configuration options: [Auto] [Disabled] [Enabled]

### 3.4.9 Ai Clock Twister [Auto]

Allows you to set the DRAM performance. Set this item to [Light] or [Lighter] to enhance DRAM compatibility, or [Strong] or [Stronger] to accelerate DRAM performance.

Configuration options: [Auto] [Lighter] [Light] [Moderate] [Strong] [Stronger]

### 3.4.10 Ai Transaction Booster [Auto]

Allows you to set the system performance.

Configuration options: [Auto] [Manual]



---

The following two sub-items appear only when you set the **Ai Transaction Booster** item to [Manual].

---

#### Common Performance Level [05]

Set this item to a higher level for better compatibility or a lower level for better performance. Use the <+> and <-> keys to adjust the value. The values range from 1 to 31.

#### Pull-In of CHA/B PH1/2/3/4 [Disabled]

Set this item to [Enabled] to apply enhancement on DRAM Channel A and B, Phase 1 to 4. The number of phases is determined by DRAM frequency and FSB strap.

Configuration options: [Disabled] [Enabled]



---

The following ten (10) items on the next page are adjusted by typing the desired values using the numeric keypad and press the <Enter> key. You can also use the <+> and <-> keys to adjust the value. To restore the default setting, type [auto] using the keyboard and press the <Enter> key.

---

### 3.4.11 CPU Voltage [Auto]

Allows you to set the CPU VCore voltage. The values range from 0.85000V to 2.10000V\* with a 0.00625V interval.



- Refer to the CPU documentation before setting the CPU Vcore voltage. Setting a high VCore voltage may damage the CPU permanently, and setting a low VCore voltage may make the system unstable.
- The value [2.10000V] of the CPU Voltage item is supported only if the **OV\_CPU jumper** is enabled, otherwise the maximum voltage supported is [1.70000V]. See 2. **CPU / Northbridge overvoltage setting** on page 2-19 for details.

### 3.4.12 CPU PLL Voltage [Auto]

Allows you to set the CPU PLL voltage. The values range from 1.50V to 2.78V with a 0.02V interval.

### 3.4.13 FSB Termination Voltage [Auto]

Allows you to set the front side bus termination voltage. The values range from 1.20V\* to 1.90V with a 0.02V interval.



The minimum value of this item becomes 1.10V when a 45nm CPU is installed.

### 3.4.14 DRAM Voltage [Auto]

Allows you to set the DRAM voltage. The values range from 1.80V to 3.08V with a 0.02V interval.

### 3.4.15 NB Voltage [Auto]

Allows you to set the North Bridge voltage. The values range from 1.10V to 2.20V\* with a 0.02V interval.



- The value [2.20V] of the **NB Voltage** item is supported only if the **OV\_NB jumper** is enabled, otherwise the maximum voltage supported is [1.9V]. See **2. CPU / Northbridge overvoltage setting** on page 2-19 for details.
- Setting the **CPU PLL Voltage**, **FSB Termination Voltage**, **DRAM Voltage** and **NB Voltage** items to a high level may damage the chipset, memory module and CPU permanently. Proceed with caution.
- Some values of the **CPU PLL Voltage**, **FSB Termination Voltage**, **DRAM Voltage** and **NB Voltage** items are labeled in different color, indicating the risk levels of high voltage settings. Refer to the table below for details.
- The system may need better cooling system to work stably under high voltage settings.

	Blue	Yellow	Purple	Red
CPU PLL Voltage	1.50V~1.78V	1.80V~2.00V	2.02V~2.20V	2.22V~2.78V
FSB Termination Voltage	1.20V~1.38V	1.40V~1.90V	N/A	N/A
DRAM Voltage	1.80V~1.98V	2.00V~2.20V	2.22V~2.40V	2.42V~3.08V
NB Voltage	1.10V~1.26V	1.28V~1.40V	1.42V~1.58V	1.60V~2.20V

### 3.4.16 SB Voltage [Auto]

Allows you to set the South Bridge voltage. The values range from 1.10V to 1.40V with a 0.10V interval.

### 3.4.17 PCIE SATA Voltage [Auto]

Allows you to set the PCI Express SATA voltage. The values range from 1.50V to 1.80V with a 0.10V interval.

### 3.4.18 Load-Line Calibration [Auto]

Allows you to select the CPU Load-Line mode. Set to [Disabled] to follow Intel specifications, or to [Enabled] to improve CPU Vdroop directly.

Configuration options: [Auto] [Disabled] [Enabled]

### 3.4.19 CPU Spread Spectrum [Auto]

Set to [Disabled] to enhance FSB overclocking ability or [Auto] for EMI control.

Configuration options: [Auto] [Disabled]

### 3.4.20 PCIE Spread Spectrum [Auto]

Set to [Disabled] to enhance PCIE overclocking ability or [Auto] for EMI control.

Configuration options: [Auto] [Disabled]



## 3.5 Advanced menu

The Advanced menu items allow you to change the settings for the CPU and other system devices.



Take caution when changing the settings of the Advanced menu items. Incorrect field values can cause the system to malfunction.

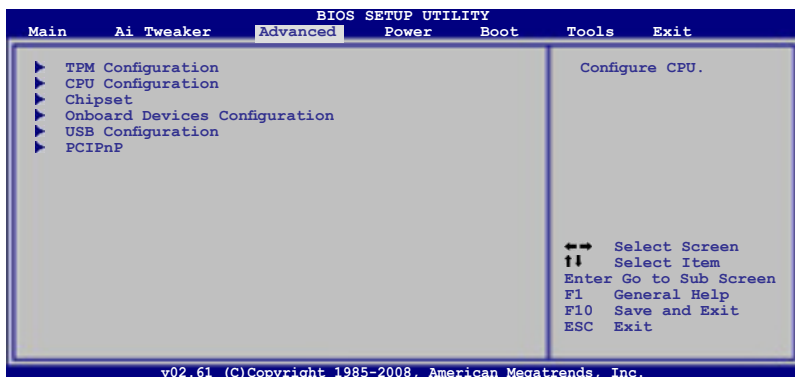

### 3.5.1 TPM Configuration

The items in this menu allow you to set the TPM (Trusted Platform Module) features. Select an item then press <Enter> to display the configuration options.

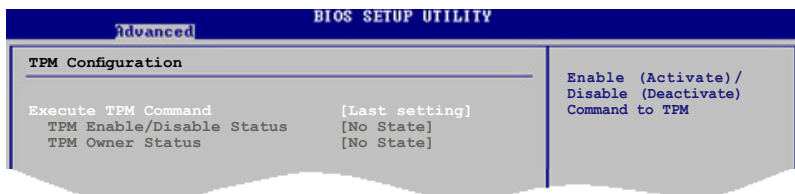

#### Execute TPM Command [Last setting]

Allows you to enable or disable the TPM security chip.  
Configuration options: [Last setting] [Disabled] [Enabled]

TPM Enable / Disable Status [No State]

The item is not configurable.

TPM Owner Status [No State]

The item is not configurable.



To enable the TPM function, set the **Execute TPM Command** item to [Enabled] and then save the change (see “2.8 Exit menu” for details). After the system reboots, the TPM Configuration menu will change into the following one.

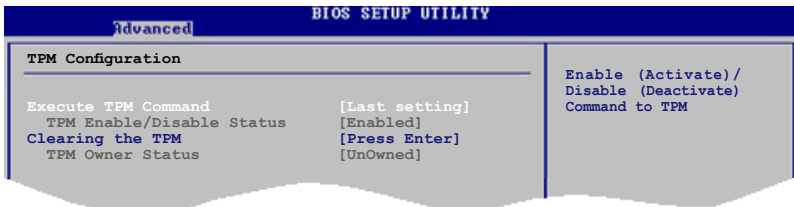

### Clearing the TPM [Press Enter]

Allows you to clear the user information saved in the TPM security chip. When you press <Enter>, a warning message will appear to ask if you want to clear the user information in the security chip. Use the left/right arrow key to select between [OK] and [Cancel], then press <Enter> to confirm your choice.



After you select [OK] to execute the **Clearing the TPM** function, the data saved in the TPM security chip will be cleared and can never be restored.

## 3.5.2 CPU Configuration

The items in this menu show the CPU-related information that the BIOS automatically detects.



The items shown in this screen may be different due to the CPU you installed.

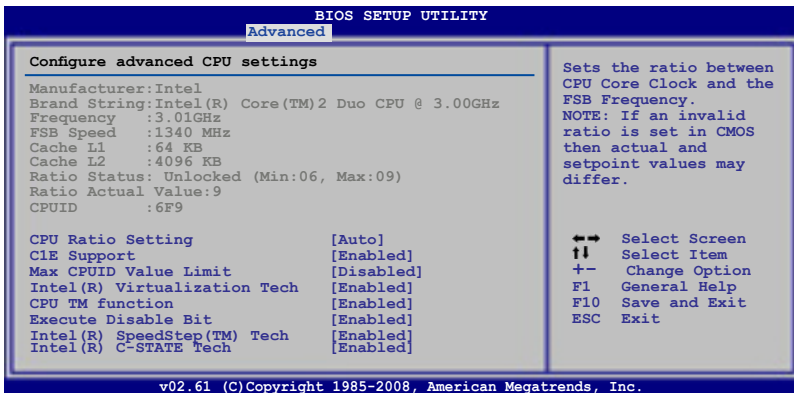

### **CPU Ratio Setting [Auto]**

Allows you to adjust the ratio between CPU Core Clock and FSB Frequency. Use the <+> and <-> keys to adjust the value.

Configuration options: [Auto] [06.0] [07.0] [08.0] [09.0]

### **C1E Support [Enabled]**

Allows you to enable or disable Enhanced Halt State support.

Configuration options: [Disabled] [Enabled]

### **Max CPUID Value Limit [Disabled]**

Setting this item to [Enabled] allows legacy operating systems to boot even without support for CPUs with extended CPUID functions.

Configuration options: [Disabled] [Enabled]

### **Intel(R) Virtualization Tech [Enabled]**

The Intel® Virtualization Technology allows a hardware platform to run multiple operating systems separately and simultaneously, enabling one system to virtually function as several systems.

Configuration options: [Disabled] [Enabled]

### **CPU TM function [Enabled]**

This function enables the overheated CPU to throttle the clock speed to cool down.

Configuration options: [Disabled] [Enabled]

### **Execute Disable Bit [Enabled]**

Allows you to enable or disable the No-Execution Page Protection Technology.

Setting this item to [Disabled] forces the XD feature flag to always return to zero (0).

Configuration options: [Disabled] [Enabled]



---

The following items appear only when you set the **CPU Ratio Control** item to [Auto].

---

### **Intel(R) SpeedStep (TM) Tech [Enabled]**

When set to [Disabled], the CPU runs at its default speed. When set to [Enabled], the CPU speed is controlled by the operating system.

Configuration options: [Disabled] [Enabled]

### **Intel(R) C-STATE Tech [Enabled]**

Configuration options: [Disabled] [Enabled]

### 3.5.3 Chipset

The Chipset menu allows you to change the advanced chipset settings. Select an item then press <Enter> to display the sub-menu.

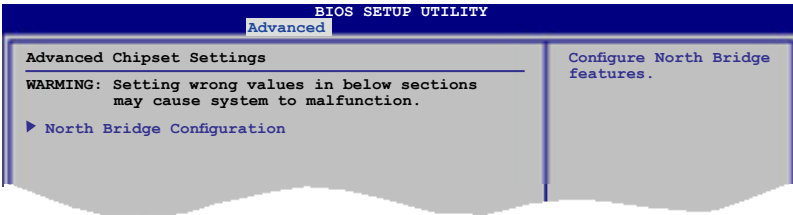

#### North Bridge Chipset Configuration

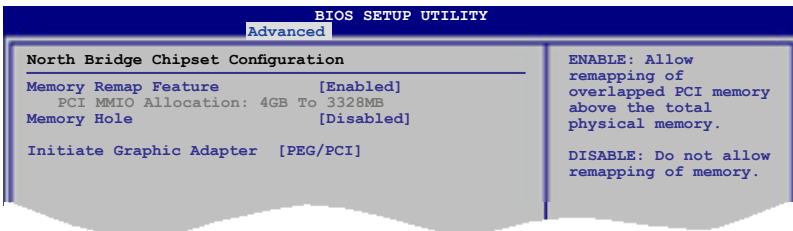

##### Memory Remap Feature [Enabled]

Allows you to enable or disable the remapping of the overlapped PCI memory above the total physical memory. Enable this option only when you install 64-bit operating system.

Configuration options: [Disabled] [Enabled]

##### Memory Hole [Disabled]

Allows you to set the memory hole mode.

Configuration options: [Disabled] [15MB-16MB]

##### Initiate Graphic Adapter [PEG/PCI]

Allows you to decide which graphics controller to use as the primary boot device.

Configuration options: [PCI/PEG] [PEG/PCI]

## 3.5.4 Onboard Device Configuration

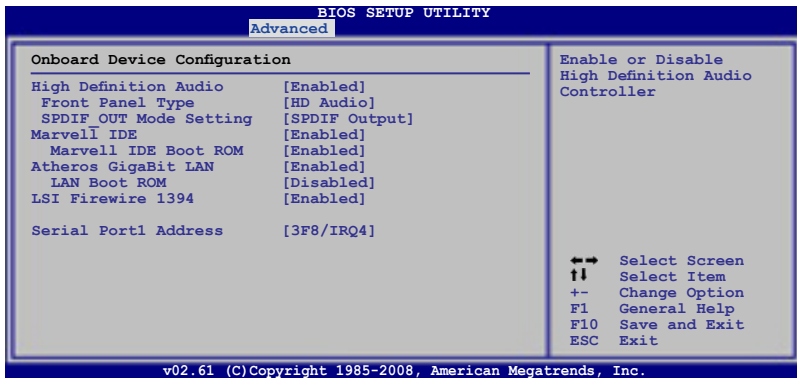

### High Definition Audio [Enabled]

Allows you to enable or disable the High Definition Audio Controller.

Configuration options: [Enabled] [Disabled]

#### Front Panel Type [HD Audio]

Allows you to set the front panel audio connector (AAFP) mode to legacy AC'97 or high-definition audio depending on the audio standard that the front panel audio module supports. Configuration options: [AC97] [HD Audio]

#### SPDIF\_OUT Mode Setting [SPDIF Output]

Allows you to set the SPDIF output mode. If your VGA card has HDMI output and need to use SPDIF signal from SPDIF\_OUT header, you need to change HDMI Output for HDMI audio output. Configuration options: [SPDIF Output] [HDMI Output]

### Marvell IDE [Enabled]

Allows you to enable or disable the onboard Marvell IDE controller.

Configuration options: [Enabled] [Disabled]

#### Marvell IDE Boot ROM [Enabled]

This item appears only when you set the previous item to [Enabled].

Configuration options: [Disabled] [Enabled]

### Atheros GigaBit LAN [Enabled]

Allows you to enable or disable the onboard Atheros LAN port.

Configuration options: [Enabled] [Disabled]

#### LAN Boot ROM [Disabled]

This item appears only when you enable the previous item.

Configuration options: [Disabled] [Enabled]

### **LSI Firewire 1394 [Enabled]**

Configuration options: [Enabled] [Disabled]

### **Serial Port1 Address [3F8/IRQ4]**

Allows you to select the Serial Port1 base address.

Configuration options: [Disabled] [3F8/IRQ4] [2F8/IRQ3] [3E8/IRQ4] [2E8/IRQ3]

### 3.5.5 USB Configuration

The items in this menu allows you to change the USB-related features. Select an item then press <Enter> to display the configuration options.

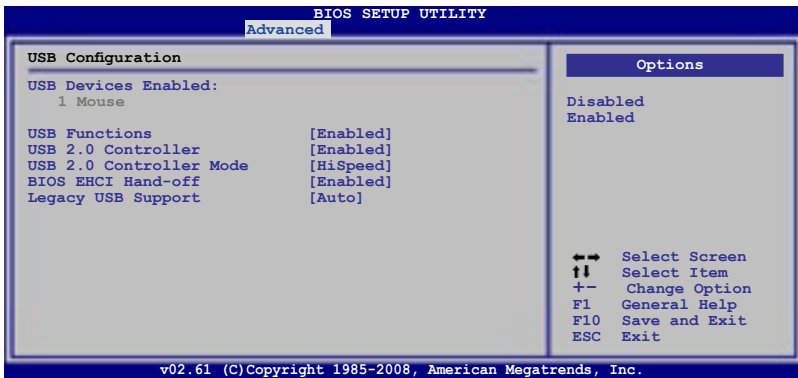

The **USB Devices Enabled** item shows the auto-detected values. If no USB device is detected, the item shows **None**.

#### USB Functions [Enabled]

Allows you to enable or disable the USB Host Controllers.  
Configuration options: [Disabled] [Enabled]



The following items appear only when you set **USB Functions** to [Enabled].

#### USB 2.0 Controller [Enabled]

Allows you to enable or disable the USB 2.0 controller.  
Configuration options: [Enabled] [Disabled]

#### USB 2.0 Controller Mode [HiSpeed]

Allows you to set the USB 2.0 controller mode to HiSpeed (480 Mbps) or FullSpeed (12 Mbps).  
Configuration options: [FullSpeed] [HiSpeed]



The **USB 2.0 Controller Mode** item appears only when you enable the **USB 2.0 Controller**.

#### BIOS EHCI Hand-off [Enabled]

Allows you to enable the support for operating systems without an EHCI hand-off feature.  
Configuration options: [Disabled] [Enabled]

### Legacy USB Support [Auto]

Allows you to enable or disable the support for legacy USB devices. Setting to [Auto] allows the system to detect the presence of USB devices at startup. If detected, the USB controller legacy mode is enabled. If no USB device is detected, the legacy USB support is disabled.

Configuration options: [Disabled] [Enabled] [Auto]

### 3.5.6 PCIPnP

The PCIPnP menu items allow you to change the advanced settings for PCI/PnP devices.

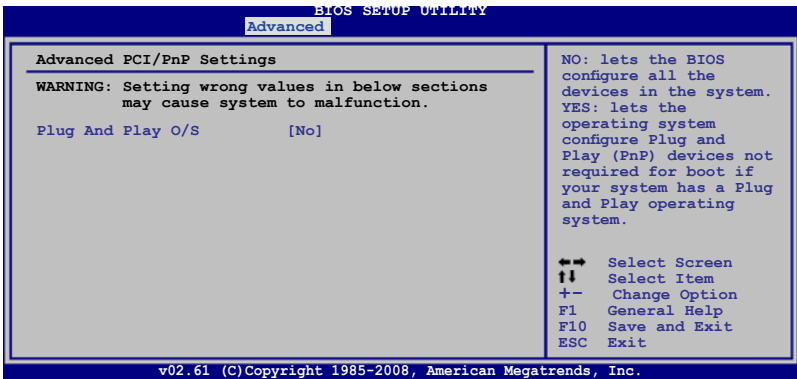

### Plug And Play O/S [No]

When set to [NO], BIOS configures all the devices in the system. When set to [YES] and if you install a Plug and Play operating system, the operating system configures the Plug and Play devices not required for boot.

Configuration options: [No] [Yes]



## 3.6 Power menu

The Power menu items allow you to change the settings for the Advanced Power Management (APM). Select an item then press <Enter> to display the configuration options.

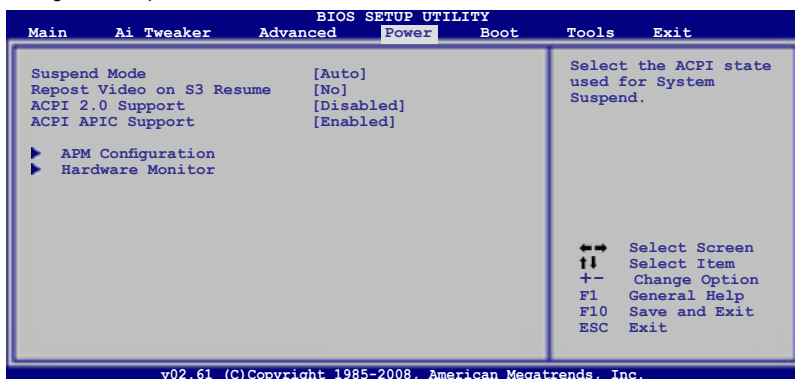

### 3.6.1 Suspend Mode [Auto]

Allows you to select the Advanced Configuration and Power Interface (ACPI) state to be used for system suspend.

Configuration options: [S1 (POS) Only] [S3 Only] [Auto]

### 3.6.2 Repost Video on S3 Resume [No]

Determines whether to invoke VGA BIOS POST on S3/STR resume.

Configuration options: [No] [Yes]

### 3.6.3 ACPI 2.0 Support [Disabled]

Add additional tables as per ACPI 2.0 specifications.

Configuration options: [Disabled] [Enabled]

### 3.6.4 ACPI APIC Support [Enabled]

Allows you to enable or disable the Advanced Configuration and Power Interface (ACPI) support in the Advanced Programmable Interrupt Controller (APIC). When set to [Enabled], the ACPI APIC table pointer is included in the RSDT pointer list.

Configuration options: [Disabled] [Enabled]

### 3.6.5 APM Configuration

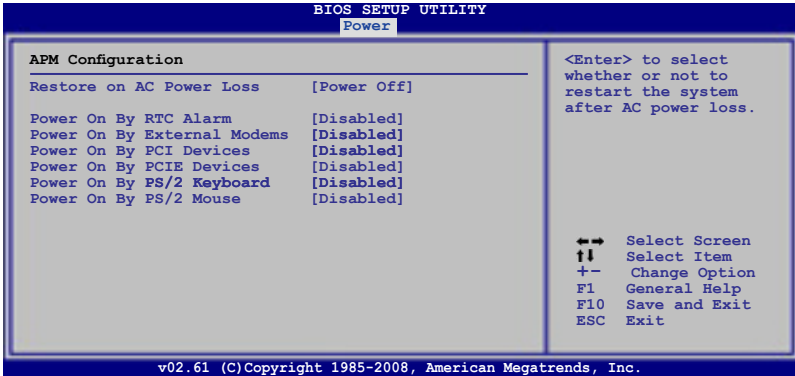

#### Restore On AC Power Loss [Power Off]

When set to [Power Off], the system goes into off state after an AC power loss. When set to [Power On], the system goes on after an AC power loss. When set to [Last State], the system goes into either off or on state, whatever the system state was before the AC power loss.

Configuration options: [Power Off] [Power On] [Last State]

#### Power On By RTC Alarm [Disabled]

Allows you to enable or disable RTC to generate a wake event. When this item is set to [Enabled], the items **RTC Alarm Date/ RTC Alarm Hour/ RTC Alarm Minute/ RTC Alarm Second** will become user-configurable with set values.

Configuration options: [Disabled] [Enabled]

#### Power On By External Modems [Disabled]

This allows either settings of [Enabled] or [Disabled] for powering up the computer when the external modem receives a call while the computer is in Soft-off mode.

Configuration options: [Disabled] [Enabled]



The computer cannot receive or transmit data until the computer and applications are fully running. Thus, connection cannot be made on the first try. Turning an external modem off and then back on while the computer is off causes an initialization string that turns the system power on.

#### Power On By PCI Devices [Disabled]

Allows you to enable or disable the PME to wake up from S5 by PCI devices.

Configuration options: [Disabled] [Enabled]

#### Power On By PCIE Devices [Disabled]

Allows you to enable or disable the PCIE devices to generate a wake event.

Configuration options: [Disabled] [Enabled]

### Power On By PS/2 Keyboard [Disabled]

Allows you to disable the Power On by PS/2 keyboard function or set specific keys on the PS/2 keyboard to turn on the system. This feature requires an ATX power supply that provides at least 1A on the +5VSB lead.

Configuration options: [Disabled] [Space Bar] [Ctrl-Esc] [Power Key]

### Power On By PS/2 Mouse [Disabled]

Allows you to disable the Power On by PS/2 Mouse function or set the PS/2 mouse to turn on the system. This feature requires an ATX power supply that provides at least 1A on the +5VSB lead.

Configuration options: [Disabled] [Enabled]

## 3.6.6 Hardware Monitor

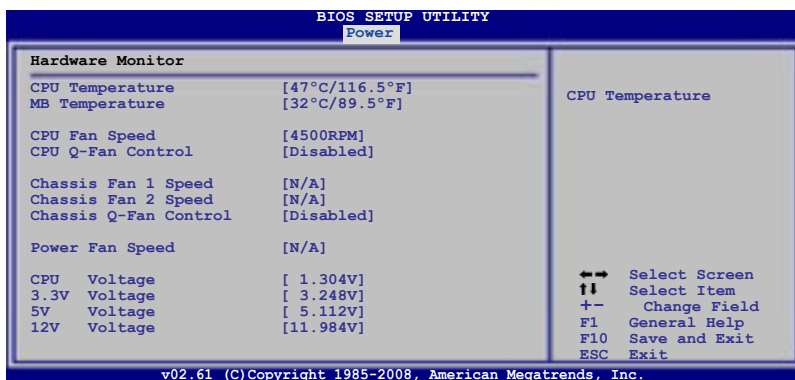

### CPU Temperature [xxx°C/xxx°F]

### MB Temperature [xxx°C/xxx°F]

The onboard hardware monitor automatically detects and displays the motherboard and CPU temperatures. Select [Ignored] if you do not wish to display the detected temperatures.

### CPU Fan Speed [xxxxRPM] or [Ignored] / [N/A]

The onboard hardware monitor automatically detects and displays the CPU fan speed in rotations per minute (RPM). If the fan is not connected to the motherboard, the field shows [N/A].

### CPU Q-Fan Control [Disabled]

Allows you to enable or disable the CPU Q-fan control feature.

Configuration options: [Disabled] [Enabled]



The following item appears only when you enable the **CPU Q-Fan Control** item.

### *CPU Fan Profile [Standard]*

Allows you to set the appropriate performance level of the ASUS Q-Fan. When set to [Standard], the CPU fan automatically adjusts depending on the CPU temperature. Set this item to [Silent] to minimize fan speed for quiet CPU fan operation, or [Turbo] to achieve maximum CPU fan speed. Configuration options: [Standard] [Silent] [Turbo]

### **Chassis Fan 1/2 Speed [xxxxRPM] or [Ignored] / [N/A]**

The onboard hardware monitor automatically detects and displays the chassis fan speed in rotations per minute (RPM). If the fan is not connected to the motherboard, the field shows [N/A].

### **Chassis Q-Fan Control [Disabled]**

Allows you to enable or disable the Chassis Q-fan control feature. Configuration options: [Disabled] [Enabled]



---

The following item appears only when you enable the **Chassis Q-Fan Control** item.

---

### *Chassis Fan Profile [Standard]*

Allows you to set the appropriate performance level of the ASUS Q-Fan. When set to [Standard], the chassis fan automatically adjusts depending on the chassis temperature. Set this item to [Silent] to minimize fan speed for quiet chassis fan operation, or [Turbo] to achieve maximum chassis fan speed.

Configuration options: [Standard] [Silent] [Turbo]

### **Power Fan Speed [xxxxRPM] or [Ignored] / [N/A]**

The onboard hardware monitor automatically detects and displays the power fan speed in rotations per minute (RPM). If the fan is not connected to the motherboard, the field shows [N/A].

### **CPU Voltage, 3.3V Voltage, 5V Voltage, 12V Voltage**

The onboard hardware monitor automatically detects the voltage output through the onboard voltage regulators. Select [Ignored] if you do not want to detect this item.

## 3.7 Boot menu

The Boot menu items allow you to change the system boot options. Select an item then press <Enter> to display the sub-menu.

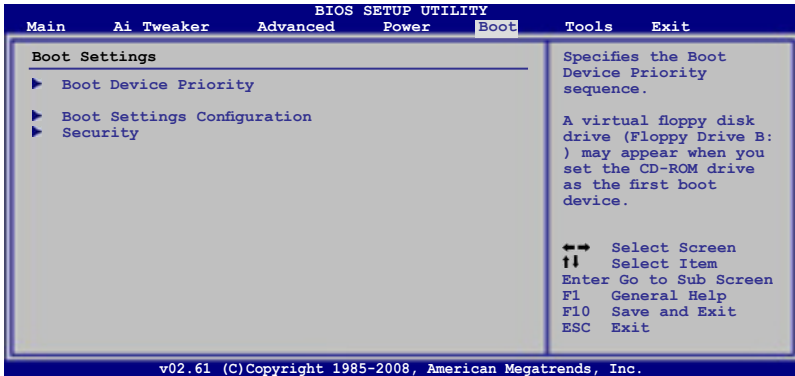

### 3.7.1 Boot Device Priority

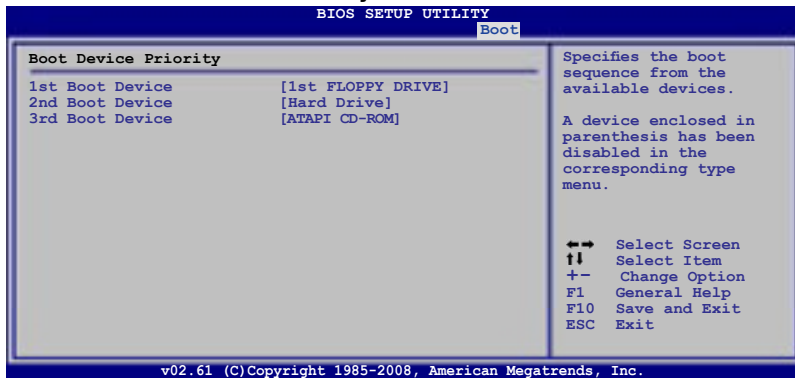

#### 1st ~ xxth Boot Device [xxx Drive]

These items specify the boot device priority sequence from the available devices. The number of device items that appears on the screen depends on the number of devices installed in the system.

Configuration options: [1st FLOPPY DRIVE] [Hard Drive] [ATAPI CD-ROM] [Disabled]

## 3.7.2 Boot Settings Configuration

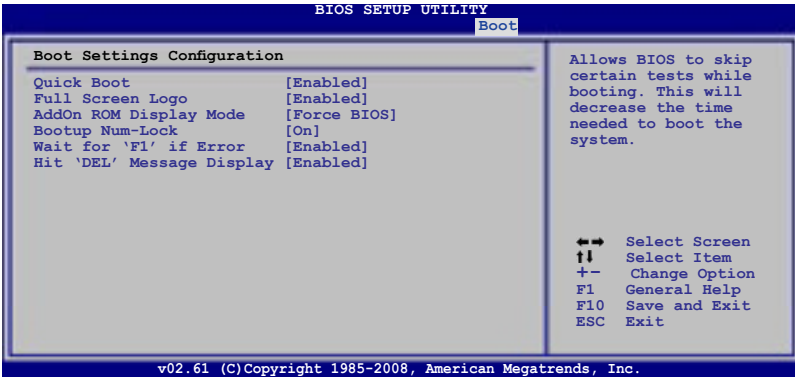

### Quick Boot [Enabled]

Enabling this item allows the BIOS to skip some power on self tests (POST) while booting to decrease the time needed to boot the system. When set to [Disabled], BIOS performs all the POST items.

Configuration options: [Disabled] [Enabled]

### Full Screen Logo [Enabled]

This allows you to enable or disable the full screen logo display feature.

Configuration options: [Disabled] [Enabled]



---

Set this item to [Enabled] to use the ASUS MyLogo2™ feature.

### AddOn ROM Display Mode [Force BIOS]

Sets the display mode for option ROM.

Configuration options: [Force BIOS] [Keep Current]

### Bootup Num-Lock [On]

Allows you to select the power-on state for the NumLock.

Configuration options: [Off] [On]

### Wait for 'F1' If Error [Enabled]

When set to [Enabled], the system waits for the <F1> key to be pressed when error occurs.

Configuration options: [Disabled] [Enabled]

### Hit 'DEL' Message Display [Enabled]

When set to [Enabled], the system displays the message "Press DEL to run Setup" during POST.

Configuration options: [Disabled] [Enabled]

### 3.7.3 Security

The Security menu items allow you to change the system security settings. Select an item then press <Enter> to display the configuration options.

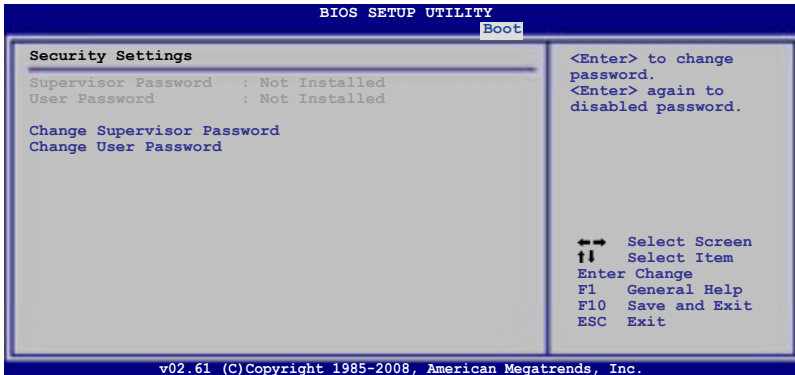

#### Change Supervisor Password

Select this item to set or change the supervisor password. The **Supervisor Password** item on top of the screen shows the default **Not Installed**. After you set a password, this item shows **Installed**.

To set a Supervisor Password:

1. Select the **Change Supervisor Password** item and press <Enter>.
2. From the password box, type a password composed of at least six letters and/or numbers, then press <Enter>.
3. Confirm the password when prompted.

The message "Password Installed" appears after you successfully set your password.

To change the supervisor password, follow the same steps as in setting a user password.

To clear the supervisor password, select the **Change Supervisor Password** then press <Enter>. The message "Password Uninstalled" appears.



If you forget your BIOS password, you can clear it by erasing the CMOS Real Time Clock (RTC) RAM. See section **2.6 Jumpers** for information on how to erase the RTC RAM.

After you have set a supervisor password, the other items appear to allow you to change other security settings.

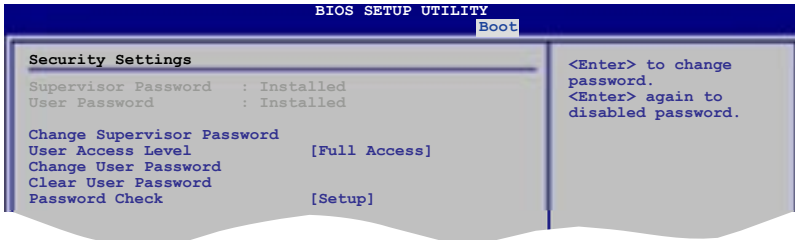

### User Access Level [Full Access]

This item allows you to select the access restriction to the Setup items. Configuration options: [No Access] [View Only] [Limited] [Full Access]

[No Access] prevents user access to the Setup utility.

[View Only] allows access but does not allow change to any field.

[Limited] allows changes only to selected fields, such as Date and Time.

[Full Access] allows viewing and changing all the fields in the Setup utility.

### Change User Password

Select this item to set or change the user password. The **User Password** item on top of the screen shows the default **Not Installed**. After you set a password, this item shows Installed.

To set a User Password

1. Select the **Change User Password** item and press <Enter>.
2. On the password box that appears, type a password composed of at least six letters and/or numbers, then press <Enter>.
3. Confirm the password when prompted.

The message "Password Installed" appears after you set your password successfully.

To change the user password, follow the same steps as in setting a user password.

### Clear User Password

Select this item to clear the user password.

### Password Check [Setup]

When set to [Setup], BIOS checks for user password when accessing the Setup utility. When set to [Always], BIOS checks for user password both when accessing Setup and booting the system.

Configuration options: [Setup] [Always]



## 3.8 Tools menu

The Tools menu items allow you to configure options for special functions. Select an item then press <Enter> to display the sub-menu.

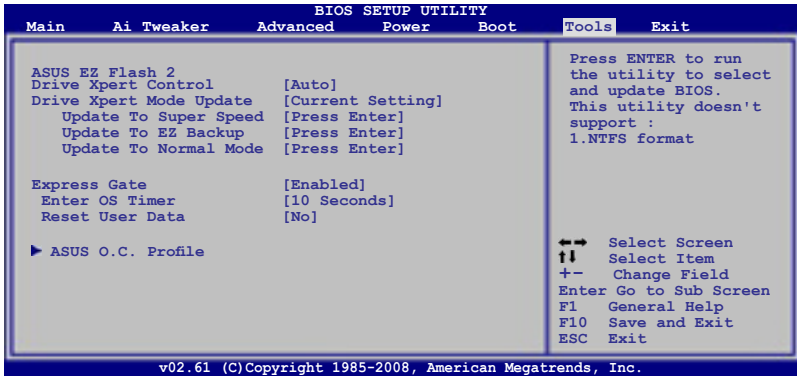

### 3.8.1 ASUS EZ Flash 2

Allows you to run ASUS EZ Flash 2. When you press <Enter>, a confirmation message appears. Use the left/right arrow key to select between [Yes] or [No], then press <Enter> to confirm your choice. Please see page 3-4, section 3.1.2 for details.

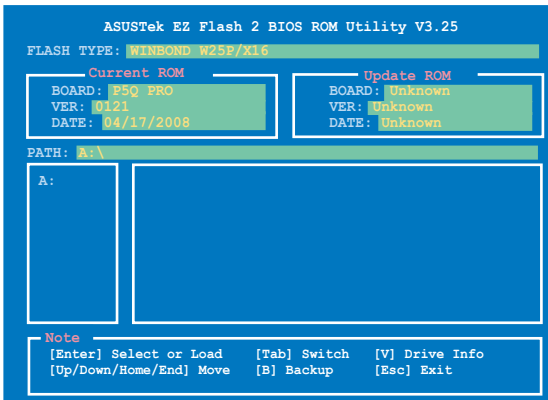

## 3.8.2 Drive Xpert

### Drive Xpert Control [Auto]

This item allow you to enabled or disabled the function of Drive Xpert Control.  
Configuration options: [Auto] [Enabled] [Disabled]

### Drive Xpert Mode Update [Current setting]

Set this item to [Mode change] to show further settings of the Drive Xpert feature.  
Configuration options: [Current setting] [Mode change]

#### Update To Super Speed [Press Enter]

This item appears only when the Drive **Xpert Mode Update** item is set to [Mode change] and allows you to use **Super Speed** function. Plug two identical SATA hard drives in the SATA\_E1 (orange, port 0) and SATA\_E2 (white, port 1) connectors on the motherboard and press the <Enter> key.

#### Update To EZ Backup [Press Enter]

This item appears only when the **Drive Xpert Mode Update** item is set to [Mode change] and allows you to use **EZ Backup** function. Plug two identical SATA hard drives in the SATA\_E1 (orange, port 0) and SATA\_E2 (white, port 1) connectors on the motherboard and press the <Enter> key.



---

Make necessary backup before using the **Drive Xpert** function:

- All original data of the hard drive connected to the SATA\_E2 (white, port 1) connector on the motherboard will be erased for EZ Backup setup
  - All original data of the two hard drives will be erased for Super Speed setup.
- 

#### Update To Normal Mode [Press Enter]

This item appears only when the **Drive Xpert Mode Update** item is set to [Mode change] and allows you to use the SATA\_E1 (orange, port 0) and SATA\_E2 (white, port 1) connectors as normal SATA connectors.

### 3.8.3 Express Gate

Allows you to enable or disable the ASUS Express Gate feature. The ASUS Express Gate feature is a unique instant-on environment that provides quick access to the Internet browser and Skype. Refer to section **4.3.11 ASUS Express GATE** for details.

Configuration options: [Enabled] [Disabled]

#### *Enter OS Timer [10 Seconds]*

Sets countdown duration that the system waits at the Express Gate's first screen before starting Windows or other installed OS. Choose [Prompt User] to stay at the first screen of Express Gate for user action.

Configuration options: [Prompt User] [1 second] [3 seconds] [5 seconds] [10 seconds] [15 seconds] [20 seconds] [30 seconds]

#### *Reset User Data [No]*

Allows you to clear Express Gate's user data.

Configuration options: [No] [Reset]

When setting this item to [Reset], make sure to save the setting to the BIOS so that the user data will be cleared the next time you enter the Express Gate. User data includes the Express Gate's settings as well as any personal information stored by the web browser (bookmarks, cookies, browsing history, etc.). This is useful in the rare case where corrupt settings prevent the Express Gate environment from launching properly.



---

The first time wizard will run again when you enter the Express Gate environment after clearing its settings.

---

### 3.8.4 ASUS O.C. Profile

This item allows you to store or load multiple BIOS settings.

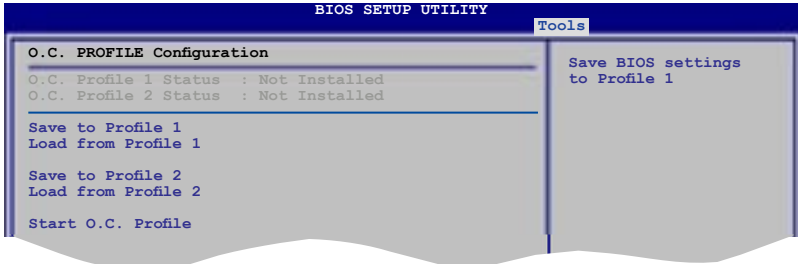

#### Save to Profile 1/2

Allows you to save the current BIOS file to the BIOS Flash. Press <Enter> to save the file.

#### Load from Profile 1/2

Allows you to load the previous BIOS settings saved in the BIOS Flash. Press <Enter> to load the file.

#### Start O.C. Profile

Allows you to run the utility to save and load CMOS. Press <Enter> to run the utility.

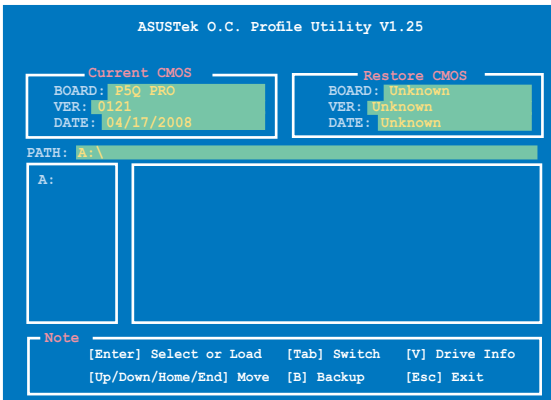

- This function can support devices such as a USB flash disk or a floppy disk with FAT 32/16 format and single partition only.
- DO NOT shut down or reset the system while updating the BIOS to prevent the system boot failure!

## 3.8.5 AI NET 2

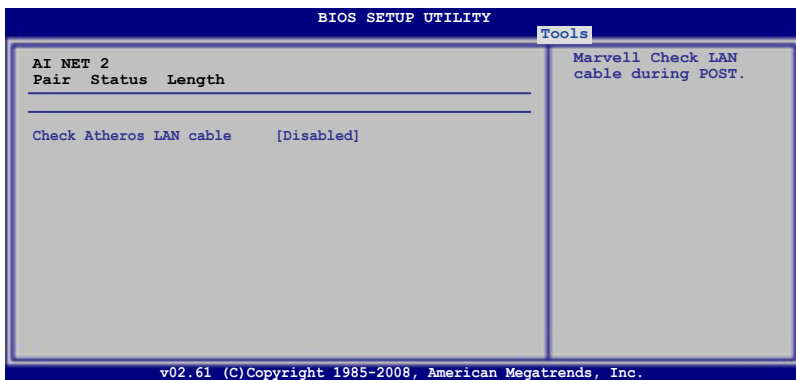

### Check Atheros LAN Cable [Disabled]

Enables or disables checking of the Atheros LAN cable during the Power-On Self-Test (POST).

Configuration options: [Disabled] [Enabled]

## 3.9 Exit menu

The Exit menu items allow you to load the optimal or failsafe default values for the BIOS items, and save or discard your changes to the BIOS items.

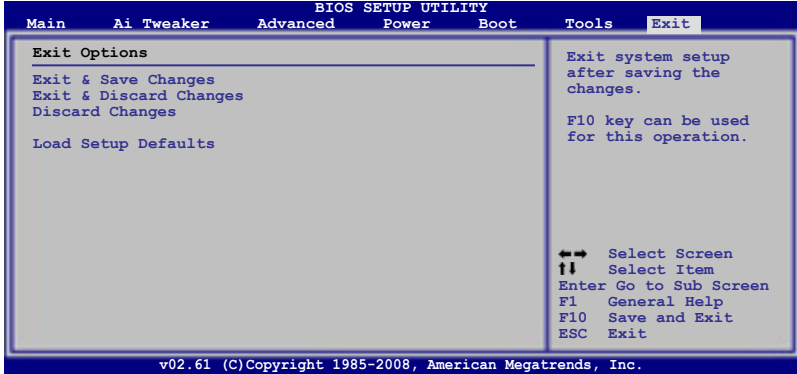

Pressing <Esc> does not immediately exit this menu. Select one of the options from this menu or <F10> from the legend bar to exit.

### Exit & Save Changes

Once you are finished making your selections, choose this option from the Exit menu to ensure the values you selected are saved to the CMOS RAM. An onboard backup battery sustains the CMOS RAM so it stays on even when the PC is turned off. When you select this option, a confirmation window appears. Select **Ok** to save changes and exit.



If you attempt to exit the Setup program without saving your changes, the program prompts you with a message asking if you want to save your changes before exiting. Press <Enter> to save the changes while exiting.

### Exit & Discard Changes

Select this option only if you do not want to save the changes that you made to the Setup program. If you made changes to fields other than System Date, System Time, and Password, the BIOS asks for a confirmation before exiting.

### Discard Changes

This option allows you to discard the selections you made and restore the previously saved values. After selecting this option, a confirmation appears. Select **Ok** to discard any changes and load the previously saved values.

### Load Setup Defaults

This option allows you to load the default values for each of the parameters on the Setup menus. When you select this option or if you press <F5>, a confirmation window appears. Select **Ok** to load default values. Select **Exit & Save Changes** or make other changes before saving the values to the non-volatile RAM.

This chapter describes the contents of the support DVD that comes with the motherboard package and the software.

# 4 Software support

4.1	Installing an operating system .....	4-1
4.2	Support DVD information .....	4-1
4.3	Software information .....	4-9
4.4	RAID configurations .....	4-34
4.5	Creating a RAID driver disk.....	4-42



## 4.1 Installing an operating system

This motherboard supports Windows® XP/ 64-bit XP/ Vista™ operating systems (OS). Always install the latest OS version and corresponding updates to maximize the features of your hardware.



- Motherboard settings and hardware options vary. Use the setup procedures presented in this chapter for reference only. Refer to your OS documentation for detailed information.
- Make sure that you install the Windows® XP Service Pack2 or later versions before installing the drivers for better compatibility and system stability.

## 4.2 Support DVD information

The support DVD that came with the motherboard package contains the drivers, software applications, and utilities that you can install to avail all motherboard features.



The contents of the support DVD are subject to change at any time without notice. Visit the ASUS website([www.asus.com](http://www.asus.com)) for updates.

### 4.2.1 Running the support DVD

Place the support DVD to the optical drive. The DVD automatically displays the Drivers menu if Autorun is enabled in your computer.

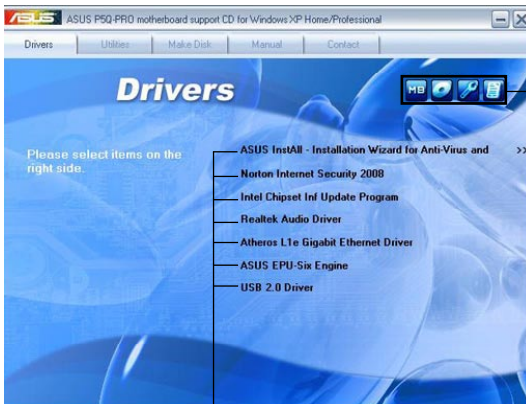

Click an icon to display support DVD/motherboard information

Click an item to install



If Autorun is NOT enabled in your computer, browse the contents of the support DVD to locate the file ASSETUP.EXE from the BIN folder. Double-click the ASSETUP.EXE to run the DVD.

## 4.2.2 Drivers menu

The Drivers menu shows the available device drivers if the system detects installed devices. Install the necessary drivers to activate the devices.



### **ASUS InstAll - Installation Wizard for Anti-Virus and Drivers**

Installs the anti-virus utility and all of the drivers through the Installation Wizard.

### **Norton Internet Security 2008**

Installs the Norton Internet Security 2008 anti-virus utility.

### **Intel Chipset Inf Update Program**

Installs the Intel® chipset Inf update program.

### **Realtek Audio Driver**

Installs the Realtek® audio driver and application.

### **Atheros L1e Gigabit Ethernet Driver**

Installs the Atheros® L1e Gigabit Ethernet driver.

### **Marvell 61xx SATA RAID Controller Driver**

Installs the Marvell® 61xx SATA RAID controller driver.

### **ASUS EPU-6 Engine**

Installs the ASUS EPU-6 Engine driver and utility.

### **USB 2.0 Driver**

Installs the USB 2.0 driver.

### 4.2.3 Utilities menu

The Utilities menu shows the applications and other software that the motherboard supports.



Click to display the next page



Click to return to the previous page

#### ASUS InstAll - Installation Wizard for Utilities

Installs all of the utilities through the Installation Wizard.

#### ASUS Update

The ASUS Update utility allows you to update the motherboard BIOS in Windows® environment. This utility requires an Internet connection either through a network or an Internet Service Provider (ISP).

#### ASUS PC Probe II

This smart utility monitors the fan speed, CPU temperature, and system voltages, and alerts you of any detected problems. This utility helps you keep your computer in healthy operating condition.

## **ASUS AI Suite**

The ASUS AI Suite is an innovative application to do overclocking, fan control, power saving and quiet thermal control.

## **ASUS AI Direct Link**

The ASUS AI Direct Link provides up to 70% transferring speed improvement when compared to traditional USB 2.0 and is the easiest and fastest way for users to enjoy large-sized data exchange of files such as movies, music, etc

## **ASUS Express Gate**

Installs the ASUS Express Gate update application.

## **Drive Xpert**

Installs the ASUS Drive Xpert utility.

## **Marvell Yukon VCT Application**

Installs the Marvell® Yukon Virtual Cable Tester™ (VCT) application that diagnoses and reports LAN cable faults and shorts using the Time Domain Reflectometry (TDR) technology.

## **Adobe Acrobat Reader 8**

Installs the Adobe® Acrobat® Reader that allows you to open, view, and print documents in Portable Document Format (PDF).

## **Ulead Burn.Now**

Installs the Ulead Burn.Now application for Audio DVD, CD and data disc creation.

## **Microsoft DirectX 9.0c**

Installs the Microsoft® DirectX 9.0c driver. The Microsoft DirectX® 9.0c is a multimedia technology that enhances computer graphics and sound. DirectX® improves the multimedia features of your computer so you can enjoy watching TV and movies, capturing videos, or playing games in your computer. Visit the Microsoft website ([www.microsoft.com](http://www.microsoft.com)) for updates.

## **Corel MediaOne Starter**

Installs the Corel MediaOne Starter application to easily manage, edit share and protect your multimedia data.

## **Ulead PhotoImpact 12 SE**

Installs the PhotoImpact image editing software.

## **Winzip 11**

Installs the Winzip utility for easy file-compression and protection.

## 4.2.4 Make disk menu

The Make disk menu contains items to create the Intel ICH10R or Marvell® 61xx driver disk.



### **Intel ICH10R 32/64 bit RAID/AHCI Driver Disk**

Allows you to create an ICH10R 32/64bit RAID/AHCI driver disk.

### **Marvell 61xx 32/64bit Driver**

Allows you to create a Marvell® 61xx 32/64bit driver disk.

## 4.2.5 Manual menu

The Manual menu contains a list of supplementary user manuals. Click an item to open the folder of the user manual.



Most user manual files are in Portable Document Format (PDF). Install the Adobe® Acrobat® Reader from the Utilities menu before opening a user manual file.

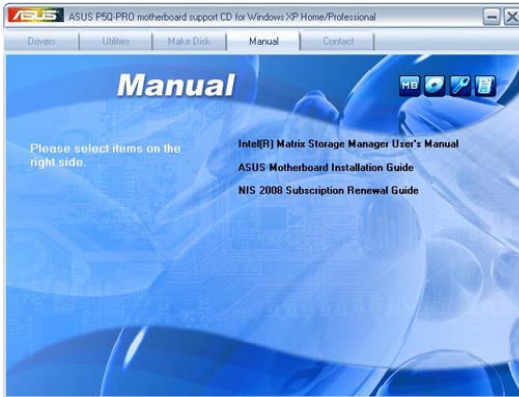

## 4.2.6 ASUS Contact information

Click the Contact tab to display the ASUS contact information. You can also find this information on the inside front cover of this user guide.

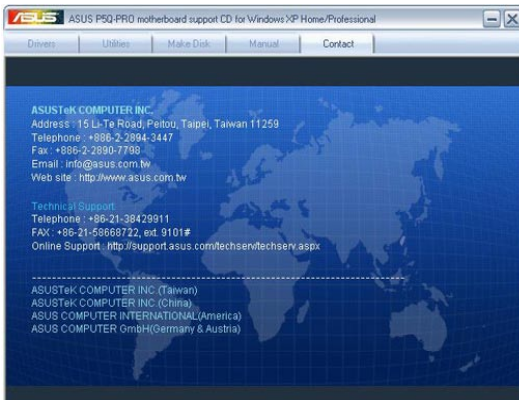



## Technical support Form

Displays the ASUS Technical Support Request Form that you have to fill out when requesting technical support.



```
File Edit Format View Help
ASUSTEK TECHNICAL SUPPORT REQUEST FORM      DATE:
-----
ORIGINATOR DESCRIPTION
-----
COMPANY NAME:                               CONTACT NAME:
PHONE (AREA) :                               FAX # (AREA):
EMAIL ADDRESS:
-----
HARDWARE DESCRIPTION
-----
MOTHERBOARD :                               REVISION #:                               BIOS:#401A0-
CPU BRAND :                                   SPEED(MHZ):
DRAM BRAND :                                   SPEED(MHz) :                               SIZE(MB):
CACHE BRAND :                               SPEED(MHz) :                               SIZE(KB):
HARD DISK :                                   MODEL NAME:                               SIZE(MB):
CDROM BRAND :                               MODEL NAME:                               SIZE(MB):
BACKUP BRAND :                               MODEL NAME:                               SIZE(MB):
OTHER STORAGE:
-----
ADD-IN CARD DESCRIPTION (MODEL NAME/VENDOR)
-----
(E)ISA SLOT 1:
(E)ISA SLOT 2:
(E)ISA SLOT 3:
(E)ISA SLOT 4:
PCI-E SLOT 1:
PCI-E SLOT 2:
PCI-E SLOT 3:
PCI SLOT 1:
PCI SLOT 2:
PCI SLOT 3:
PCI SLOT 4:
PCI SLOT 5:
-----
```

## Filelist

Displays the contents of the support DVD in text format.



```
File Edit Format View Help
$File list for the included support software for P5Q / P5QJ Deluxe motherboard
-----
File Name      Description
-----
--Drivers
-Chipsset      -intel(x) chipsset software installation utility v9.0.0.1007 for
windows xp/ 64bit xp/ vista/ 64bit vista.
-Audio         -SoundMAX Audio Driver v5.10.1.6450 for windows xp.
-64bit        -SoundMAX Audio Driver v5.10.2.6450 for windows 64bit xp.
-vista       -SoundMAX Audio Driver v6.10.1.6450 for 32bit windows vista &
v6.10.2.6450 for 64bit vista.
-Epusetup     -ASUS EPU Driver + AI Gear 3 Utility v1.00.00 for windows xp & 64bit
xp & 32/64bit vista.
-Lan          -9056
-Windows      -Marvell yukon gigabit ethernet driver v10.22.4.3 for windows
xp/64bit xp(x64).
-VCT          -Marvell yukon VCT Application v2.16.3.3 Package v2.14.3.3 for
windows xp/ 64bit xp.
-UNDI        -Marvell UNDI Driver for E132 v2.02.
-Client_32   -Marvell yukon Client 32 Driver v7.03.
-OOI         -Marvell DOS OOI Driver v7.06.
-Netware     -Marvell yukon Netware 5.1/6 driver v7.03.
-unix        -Marvell SCO UnixWare 7.1.x Driver and Openunix 8.0.
-BIS         -Marvell BIS Driver v8.56.1.3 for windows 2000/XP/2003.
Marvell BIS Driver v8.56.1.3 for windows 64bit xp/2003.
-RAID
```



## 4.3 Software information

Most of the applications in the support DVD have wizards that will conveniently guide you through the installation. View the online help or readme file that came with the software application for more information.

### 4.3.1 ASUS MyLogo2™

The ASUS MyLogo2™ utility lets you customize the boot logo. The boot logo is the image that appears on screen during the Power-On-Self-Tests (POST). The ASUS MyLogo2™ is automatically installed when you install the ASUS Update utility from the support DVD. See section 4.2.3 **Utilities menu** for details.



- Before using the ASUS MyLogo2™, use the AFUDOS utility to make a copy of your original BIOS file, or obtain the latest BIOS version from the ASUS website. See section 3.1.3 **AFUDOS utility**.
- Make sure that the BIOS item Full Screen Logo is set to [Enabled] if you wish to use ASUS MyLogo3. See section 3.7.2 **Boot Settings Configuration**.
- You can create your own boot logo image in GIF, JPG, or BMP file formats.

To launch the ASUS MyLogo2™:

1. Launch the ASUS Update utility. Refer to section 3.1.1 **ASUS Update utility** for details.
2. Select **Options** from the drop down menu, and then click **Next**.
3. Check the option **Launch MyLogo** to replace system boot logo before flashing BIOS, and then click **Next**.
4. Select **Update BIOS from a file** from the drop down menu, and then click **Next**.
5. When prompted, locate the new BIOS file, and then click **Next**. The ASUS MyLogo3 window appears.
6. From the left window pane, select the folder that contains the image you intend to use as your boot logo.



- 7. When the logo images appear on the right window pane, select an image to enlarge by clicking on it.



- 8. Adjust the boot image to your desired size by selecting a value on the Ratio box.



- 9. When the screen returns to the ASUS Update utility, flash the original BIOS to load the new boot logo.
- 10. After flashing the BIOS, restart the computer to display the new boot logo during POST.

### 4.3.2 AI NET2

The AI NET2 features the Marvell® Virtual Cable Tester™ (VCT). VCT is a cable diagnostic utility that reports LAN cable faults and shorts using the Time Domain Reflectometry (TDR) technology. The VCT detects and reports open and shorted cables, impedance mismatches, pair swaps, pair polarity problems, and pair skew problems of up to 64 ns at one meter accuracy.

The VCT feature reduces networking and support costs through a highly manageable and controlled network system. This utility can be incorporated in the network systems software for ideal field support as well as development diagnostics.

#### Using the Virtual Cable Tester™

To use the the Marvell® Virtual Cable Tester™ utility:

1. Launch the VCT utility from the Windows® desktop by clicking **Start > All Programs > Marvell > Virtual Cable Tester**.
2. Click **Virtual Cable Tester** from the menu to display the screen below.

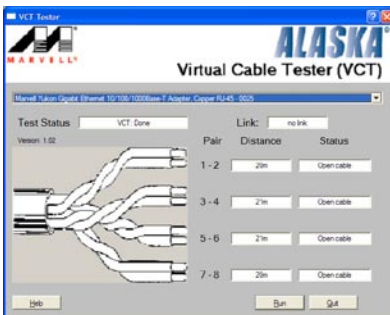

3. Click the **Run** button to perform a cable test.



- The VCT utility only tests Ethernet cables connected to Gigabit LAN port(s).
- The Run button on the Virtual Cable Tester™ main window is disabled if no problem is detected on the LAN cable(s) connected to the LAN port(s).
- If you want the system to check the status of the LAN cable before entering the OS, enable the item Post Check LAN Cable in the BIOS Setup.

### 4.3.3 ASUS PC Probe II

PC Probe II is a utility that monitors the computer's vital components, and detects and alerts you of any problem with these components. PC Probe II senses fan rotations, CPU temperature, and system voltages, among others. Because PC Probe II is software-based, you can start monitoring your computer the moment you turn it on. With this utility, you are assured that your computer is always at a healthy operating condition.

#### Installing PC Probe II

To install PC Probe II on your computer:

1. Place the support DVD to the optical drive. The Drivers installation tab appears if your computer has an enabled Autorun feature.



If Autorun is not enabled in your computer, browse the contents of the support DVD to locate the setup.exe file from the ASUS PC Probe II folder. Double-click the setup.exe file to start installation.

2. Click the Utilities tab, then click ASUS PC Probe II.
3. Follow the screen instructions to complete installation.

#### Launching PC Probe II

You can launch the PC Probe II right after installation or anytime from the Windows® desktop.

To launch the PC Probe II from the Windows® desktop, click **Start > All Programs > ASUS > PC Probe II > PC Probe II v1.xx.xx**. The PC Probe II main window appears.

After launching the application, the PC Probe II icon appears in the Windows® taskbar. Click this icon to close or restore the application.









#### Using PC Probe II

##### Main window

The PC Probe II main window allows you to view the current status of your system and change the utility configuration. By default, the main window displays the Preference section. You can close or restore the Preference section by clicking on the triangle on the main window right handle.



Click to close the Preference panel

Button	Function
	Opens the Configuration window
	Opens the Report window
	Opens the Desktop Management Interface window
	Opens the Peripheral Component Interconnect window
	Opens the Windows Management Instrumentation window
	Opens the hard disk drive, memory, CPU usage window
	Shows/Hides the Preference section
	Minimizes the application
	Closes the application

### *Sensor alert*

When a system sensor detects a problem, the main window right handle turns red, as the illustrations below show.

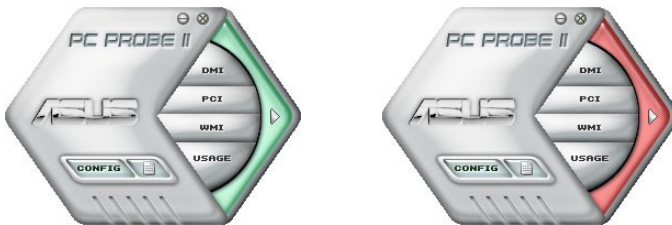

When displayed, the monitor panel for that sensor also turns red. Refer to the Monitor panels section for details.

### Preference

You can customize the application using the Preference section in the main window. Click the box before each preference to activate or deactivate.

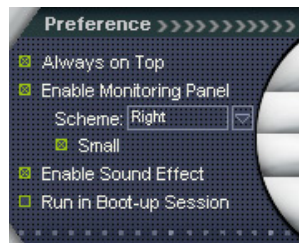

## Hardware monitor panels

The hardware monitor panels display the current value of a system sensor such as fan rotation, CPU temperature, and voltages.

The hardware monitor panels come in two display modes: hexagonal (large) and rectangular (small). When you check the Enable Monitoring Panel option from the Preference section, the monitor panels appear on your computer's desktop.



Large display



Small display

### Changing the monitor panels position

To change the position of the monitor panels in the desktop, click the arrow down button of the Scheme options, then select another position from the list box. Click OK when finished.





### Moving the monitor panels

All monitor panels move together using a magnetic effect. If you want to detach a monitor panel from the group, click the horseshoe magnet icon. You can now move or reposition the panel independently.



### Adjusting the sensor threshold value

You can adjust the sensor threshold value in the monitor panel by clicking the  or  buttons. You can also adjust the threshold values using the Config window.

You cannot adjust the sensor threshold values in a small monitoring panel.

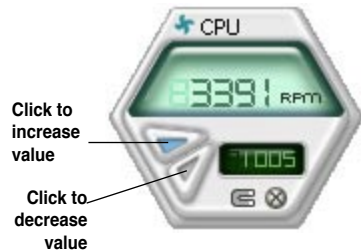

### Monitoring sensor alert

The monitor panel turns red when a component value exceeds or is lower than the threshold value. Refer to the illustrations below.



Large display



Small display

## WMI browser

Click **WMI** to display the WMI (Windows Management Instrumentation) browser. This browser displays various Windows® management information. Click an item from the left panel to display on the right panel. Click the plus sign (+) before WMI Information to display the available information.

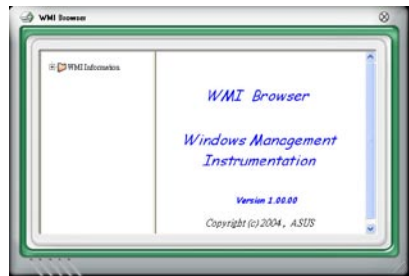

You can enlarge or reduce the browser size by dragging the bottom right corner of the browser.

## DMI browser

Click **DMI** to display the DMI (Desktop Management Interface) browser. This browser displays various desktop and system information. Click the plus sign (+) before DMI Information to display the available information.



## PCI browser

Click **PCI** to display the PCI (Peripheral Component Interconnect) browser. This browser provides information on the PCI devices installed on your system. Click the plus sign (+) before the PCI Information item to display available information.

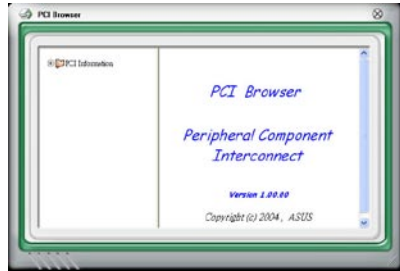

## Usage

The Usage browser displays real-time information on the CPU, hard disk drive space, and memory usage. Click **USAGE** to display the Usage browser.

### CPU usage

The CPU tab displays real-time CPU usage in line graph representation. If the CPU has an enabled Hyper-Threading, two separate line graphs display the operation of the two logical processors.

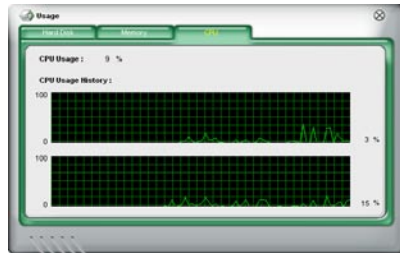

### Hard disk drive space usage

The Hard Disk tab displays the used and available hard disk drive space. The left panel of the tab lists all logical drives. Click a hard disk drive to display the information on the right panel. The pie chart at the bottom of the window represents the used (blue) and the available HDD space.





### Memory usage

The Memory tab shows both used and available physical memory. The pie chart at the bottom of the window represents the used (blue) and the available physical memory.

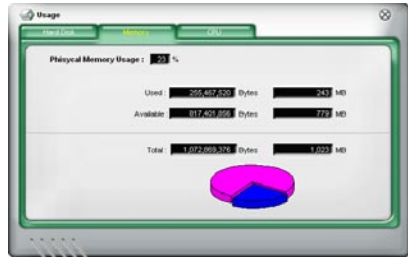

## Configuring PC Probe II

Click **CONFIG** to view and adjust the sensor threshold values.

The Config window has two tabs: Sensor/Threshold and Preference. The Sensor/Threshold tab enables you to activate the sensors or to adjust the sensor threshold values. The Preference tab allows you to customize sensor alerts, or change the temperature scale.

Enabled	Sensor Name	Nominal Value	Current Value	Threshold
<input checked="" type="checkbox"/>	CPU		43	60 °C
<input checked="" type="checkbox"/>	MB		34	45 °C

Buttons: Default, Apply, Cancel, Save As, Load

Callouts:

- Default: Loads the default threshold values for each sensor
- Apply: Applies your changes
- Cancel: Cancels or ignores your changes
- Save As: Saves your configuration
- Load: Loads your saved configuration

### 4.3.4 ASUS AI Suite

ASUS AI Suite allows you to launch several ASUS utilities easily.

#### Launching AI Suite

1. Install AI Suite from the motherboard support DVD.
2. Launch AI Suite by clicking **Start > All Programs > ASUS > AI Suite > AI Suite v1.xx.xx**. The AI Suite main window appears.
3. The AI Suite icon  appears in the Windows® notification area. If you minimize the application main window, click this icon to restore the window.

#### Using AI Suite

Click each utility button to launch the utility, or click the **Normal** button to restore system default settings.

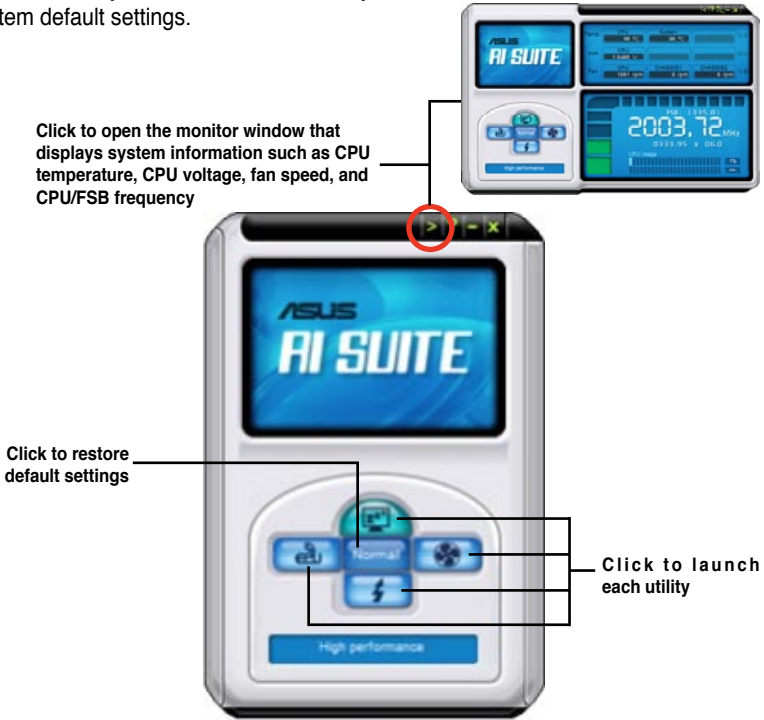

- The screenshots in this section are for reference only. The actual utility buttons vary by models.
- Refer to the software manual in the support DVD or visit the ASUS website at [www.asus.com](http://www.asus.com) for detailed software configuration.

### Other feature buttons

Click  on right corner of the main window to open the monitor window.

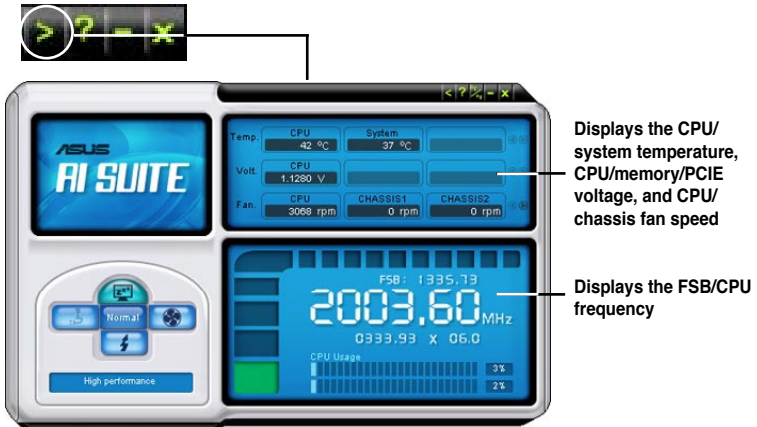

Click  on right corner of the expanded window to switch the temperature from degrees Centigrade to degrees Fahrenheit.



### 4.3.5 ASUS AI Nap

This feature allows you to minimize the power consumption of your computer whenever you are away. Enable this feature for minimum power consumption and a more quiet system operation.

After installing AI Suite from the bundled support DVD, you can launch the utility by double-clicking the AI Suite icon on the Windows OS taskbar and click the AI Nap button on the AI Suite main window.

Click **Yes** on the confirmation screen.

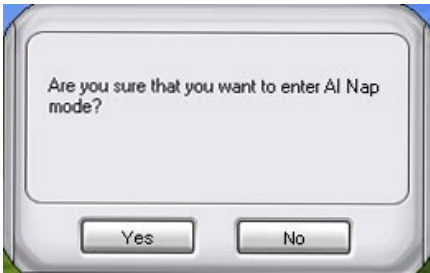

To exit AI Nap mode, press the system power or mouse button then click **Yes** on the confirmation screen.

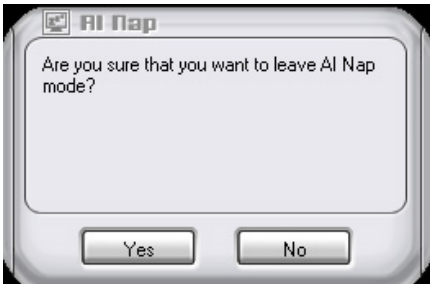

---

To switch the power button functions from AI Nap to shutting down, just right click the **AI Suite** icon on the OS taskbar, select **AI Nap** and click **Use power button**. Unclick the the item to switch the function back.

---

### 4.3.6 ASUS Fan Xpert

Asus Fan Xpert intelligently allows you to adjust both the CPU and chassis fan speeds according to different ambient temperatures caused by different climate conditions in different geographic regions and your PC's system loading. The built-in variety of useful profiles offer flexible controls of fan speed to achieve a quiet and cool environment.

Install AI Suite from the bundled support DVD. To launch the ASUS Fan Xpert utility, double-click the **AI Suite** icon on the Windows® notification bar and click the **Fan Xpert** button on the AI Suite main window.

Click the dropdown list button and display the fan types. Select **CPU Fan** or **Chassis Fan**.



## Fan profile modes

- **Disable:** Select this mode to disable the **Fan Xpert** function.
- **Standard:** This mode makes the fan adjust speed in moderate pattern.
- **Silent:** This mode minimizes fan speed for quiet fan operation.
- **Turbo:** This mode boosts the fan to achieve maximal fan speed for the best cooling effect.
- **Intelligent:** This mode automatically adjusts the CPU fan speed with the ambient temperature.
- **Stable:** This mode keeps the CPU fan at the same speed to avoid noise caused by the unsteady fan rotation. However, the fan will speed up when the temperature exceeds 70°C.
- **User:** This mode allows you to change the CPU fan profile under certain limitation.



For **Chassis Fan**, only Disable/Standard/Silent/Turbo modes could be selected.



Click to close the Calibration window

100%	N/A	rpm
90%	N/A	rpm
80%	N/A	rpm
70%	N/A	rpm
60%	N/A	rpm
50%	N/A	rpm
40%	N/A	rpm
30%	N/A	rpm
20%	N/A	rpm

Click to get the calibration between the fan rotation and fan speed ratio

### 4.3.7 ASUS AI Booster

The ASUS AI Booster application allows you to overclock the CPU speed in Windows® environment without the hassle of booting the BIOS.

After installing AI Suite from the bundled support DVD, you can launch the utility by double-clicking the AI Suite icon on the Windows® OS taskbar and click the AI Booster button on the the AI Suite main window.

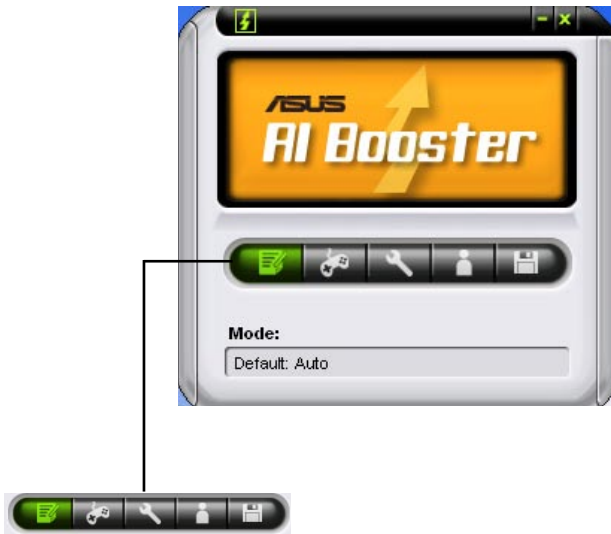

The options on the taskbar allow you to use the default settings, adjust CPU/ Memory/PCI-E frequency manually, or create and apply your personal overclocking configurations.

### 4.3.8 ASUS EPU—6 Engine

ASUS EPU—6 Engine is an energy-efficient tool that satisfies different computing needs. This utility provides four modes that you can select to enhance system performance or save power. Selecting Auto mode will have the system shift modes automatically according to current system status. You can also customize each mode by configuring settings like CPU frequency, vCore Voltage, and Fan Control.

#### Installing EPU-6 Engine

To install EPU-6 Engine on your computer:

1. Place the support DVD to the optical drive. The Drivers installation tab appears if your computer has an enabled Autorun feature.
2. Click the **Drivers** tab and then click **ASUS EPU—6 Engine**.
3. Follow the screen instructions to complete installation.

#### Launching EPU-6 Engine

Launch EPU-6 Engine by double-clicking the EPU-6 Engine icon on the Windows® notification area.



The first time you launch EPU-6 Engine, the following message will appear, asking you to run Calibration first. Running calibration allows the system to detect CPU properties to optimize power management.



Click **Run Calibration** and wait for a few seconds. Then, the EPU-6 Engine main menu appears.



# EPU-6 Engine main menu

The screenshot shows the EPU-6 Engine main menu with the following components and labels:

- Top Left Pop-up:** Displays CPU Power and Total CPU Energy Saving.
- Top Middle Pop-up:** Displays the following message if no VGA power saving engine is detected.
- Top Right Pop-up:** Lights up when power saving engine is activated.
- Bottom Right Pop-up:** Displays the the display of Total amount of CO2 and Current CO2 reduced. \*Shifts between the display of Total amount of CO2 and Current CO2 reduced.
- Main Menu Header:** Six Engine the complete system power saving solution.
- Component Icons:** CPU, VGA, Chipset, Memory, Drive, Fan.
- CO2 Emission:** Reduced CO2 Emmission 12122.352 mg. Includes buttons for Current and Total.
- Mode Setting:** High Performance. Includes buttons for Auto, Turbo, High Performance, Medium Power Saving, and Max. Power Saving.
- Current CPU Status:** Tranquility, Performance, Convenience, Reliability, Energy Saving.
- Buttons:** Advance, Calibrate, Exit.

Advanced settings for each mode (refer to the next page for further information)



- \* Click Current to show the CO2 that has been reduced since you click the Renew button Since 2007. 04. 12
- \* Click Total to show the total CO2 that has been reduced since you launched EPU-6 Engine.

## Advanced settings menu

Click Advance (  ) from the Six Engine main menu to display configuration options in each mode. Some options in certain modes are dimmed, meaning that they are not available.

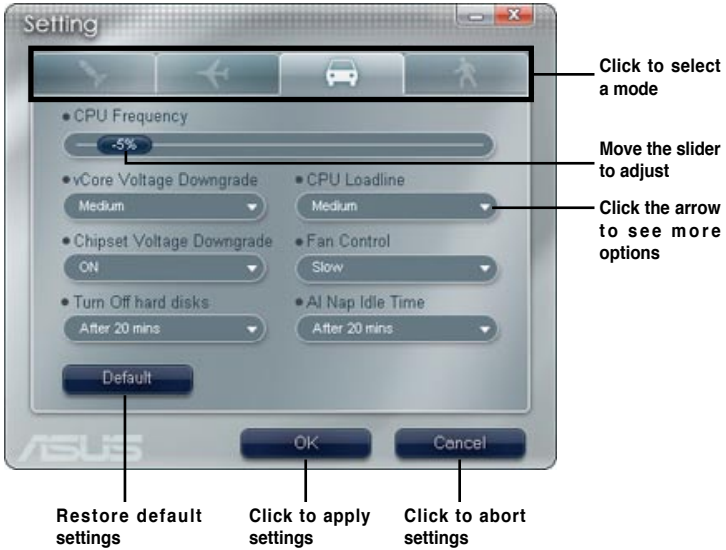

## Configuration options in Advanced settings menu

The following lists the configuration options and their definitions in Advanced settings menu.

- **CPU Frequency:** Raises or lowers CPU frequency to a certain percentage.
- **vCore Voltage Downgrade:** Lowers CPU vCore voltage.
  - **High:** Downgrades voltage to the highest level for CPU power saving.
  - **Medium:** Downgrades voltage to the medium level.
  - **Small:** Downgrades voltage to the minimum level.
- **Chipset Voltage Downgrade:** Turns on/off chipset voltage.
- **Turn Off hard disks:** Turns off hard disk drives when they are not accessed after a certain time.
- **CPU Loadline:** Sets up the CPU loadline to manage CPU power saving.
  - **Light:** Saves CPU power to the minimum level.
  - **Medium:** Saves CPU power to the medium level.
  - **Heavy:** Saves CPU power to the highest level.

- **Fan Control:** Adjusts fan speeds to reduce noise and save system power.
  - **Quiet:** Lowers CPU fan speed and shuts off two chassis fans.
  - **Slow:** Lowers CPU fan and two chassis fan speeds.
- **AI Nap Idle Time:** Enters AI Nap mode after a certain time during system idle process.

Refer to the following table for the configuration options in each mode.

Configuration options	Turbo Mode	H i g h Performance Mode	Medium Power Saving Mode	M a x i m u m Power Saving Mode
C P U Frequency	Overclocking +1% to +30%	N/A	Downclocking -1% to -50%	Downclocking -1% to -50%
vCore Voltage Downgrade	N/A	N/A	Small/Medium/ High	Small/Medium/ High
C h i p s e t Voltage Downgrade	N/A	N/A	On/Off	On/Off
T u r n O f f hard disks	Never/After 3 mins–After 5 hours	Never/After 3 mins–After 5 hours	Never/After 3 mins–After 5 hours	Never/After 3 mins–After 5 hours
CPU Loadline	N/A	N/A	Light/Medium/ Heavy	Light/Medium/ Heavy
Fan Control	N/A	N/A	Keep Bios Setting/Slow	Keep Bios Setting/Quiet
A I N a p Idle Time	Never/After 3 mins–After 5 hours	Never/After 3 mins–After 5 hours	Never/After 3 mins–After 5 hours	Never/After 3 mins–After 5 hours

### 4.3.9 ASUS AI Direct Link

ASUS AI Direct Link allows you to form a computer-to-computer network via a network cable to share files with high transfer rate. You must first connect two computers (at least one of them is ASUS product) using a network cable, and then install the utility to both computers to avail the AI Direct Link feature.



- Turn off your firewall software other than Windows Firewall before launching AI Direct Link.
- The transfer rate is limited if you use a 10/100 LAN card.

### Using AI Direct Link

To enable the incoming folder:

1. From the Windows® taskbar, right click on the AI Direct Link icon  and select **Incoming folder > Enable incoming folder**.



For Windows XP Home edition users, click **Steps of enabling file sharing** on this pop-up message and follow the instructions to enable the incoming folder.

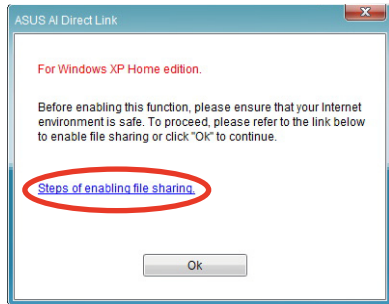

2. If you want to verify the incoming user, select **Use my account** and set your username and password. Otherwise, select **Use public account**.



For security's sake, it is recommended that you set a username and password.

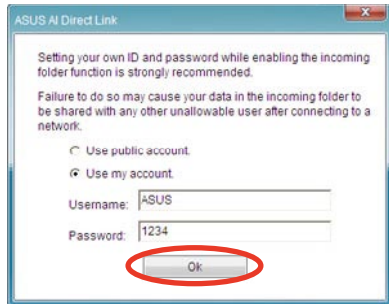

3. Click **OK** and the “Ready for incoming” message appears.



To disable the incoming folder, select **Incoming folder > Disable incoming folder**.



- Right click on the AI Direct Link icon and select **Incoming folder > Open incoming folder**. The **AIDirectLinkIncoming** folder opens. Put the files you want to share into this folder. The authorized user has full access to this folder.

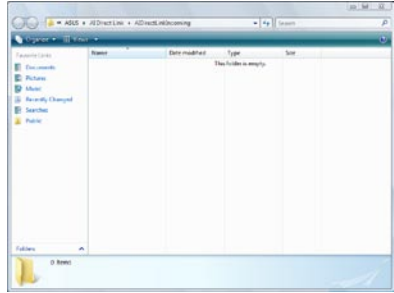

The default path of the AIDirectLinkIncoming folder is C:\Program Files\ASUS\AI Direct Link. To change its location, **disable the incoming folder first. Then, select Incoming folder > Change incoming folder** to open the system directories, and move the AIDirectLinkIncoming folder under another directory.

To connect to another computer:



This function is valid for ASUS products only.

- From the Windows® taskbar, right click on the AI Direct Link icon and select **Connect**. The following screen displays.
- Click **Refresh**. The software starts searching for the connected computer.

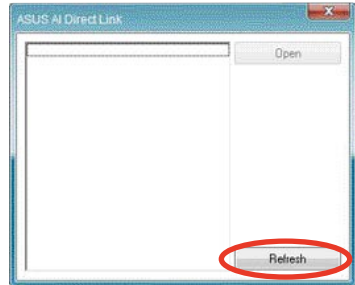

- The name of the computer found is listed. Click **Open** to open its shared folder.
- If necessary, enter the authorized username and password. Click **OK** to log in and have full access to this shared folder.

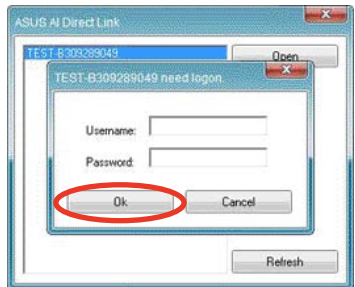
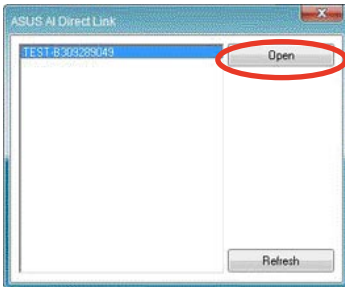

### 4.3.10 ASUS Drive Xpert

Drive Xpert, an ASUS exclusive technology, secures the data on your hard disk and enhances hard drive performance without the hassles of complicated configurations. With its user-friendly graphical user interface, you can easily arrange hard drive backups or enhance the hard drive's transfer rate.

#### Installing Serial ATA hard disks

For using Drive Xpert in Windows® operating system, we recommend that you prepare three hard disks: one hard disk with operating system already installed, and two hard disks for Drive Xpert configuration.

To install Serial ATA hard disks for Drive Xpert configuration:

1. Install two SATA hard disks into the drive bays.
2. Plug one end of the SATA signal cables to each drive, and plug the other end of the SATA signal cables to the SATA\_E1 (orange, port 0) and SATA\_E2 (white, port 1) connectors on the motherboard. Refer to page 2-28 for the exact location of the SATA connectors.
3. Connect a SATA power cable to the power connector of each drive.



- For optimal performance, we highly recommend that you install identical drives of the same model and capacity.
- The SATA\_E1 (orange, port 0) and SATA\_E2 (white, port 1) connectors on the motherboard do not support ATAPI devices and hot-plug function.

#### Launching Drive Xpert in Windows® OS

After installing Drive Xpert from the bundled support DVD, double-click the **Drive Xpert** icon on the Windows® notification area. The main screen as shown on the right hand side appears. There are two modes for Drive Xpert: **EZ Backup** and **Super Speed**.



- Before using the Drive Xpert function, ensure that you have installed the Marvell 61xx driver in the system.
- Ensure to install two hard disks to the SATA\_E1 (orange, port 0) and SATA\_E2 (white, port 1) connectors when the Drive Xpert mode in BIOS setup is configured as **EZ Backup** or **Super Speed**. Otherwise, the HDD LED in the front panel flashes.

## Configuring EZ Backup

This mode allows one hard disk to backup the other hard disk automatically. This helps you to save your vital data even if one hard disk is damaged.



- We recommend that you use two new hard disks for this setup.
- This setup erases all original data in the hard disk connected to the SATA\_E2 (white, port 1) connector on the motherboard. Ensure to back up the data in the hard disk before using this setup.

To start **EZ Backup** configuration:

1. Click **EZ Backup** from the main screen.
2. Click **Apply** to start configuration.



3. A warning message appears, reminding you that all original data in the hard disk connected to the SATA\_E2 (white, port 1) connector on the motherboard will be erased. Click **Ok** to continue.
4. The setup is completed. Click **Ok** to restart your computer at once.



5. After restarting your computer, the **Drive Xpert** icon on the Windows® notification area turns green to indicate that **EZ Backup** is set up successfully.



## Configuring Super Speed

This mode allows two hard disks to access data simultaneously. The dual channel design can largely enhance hard disk transfer rate.



- We recommend that you use two new hard disks for this setup.
- This setup erases all original data in both hard disks. Ensure to back up all data in the hard disks before using this setup.

To start **Super Speed** configuration:

1. Click **Super Speed** from the main screen.



If you are in **EZ Backup** mode, click **Mode Change** to return to the main screen.

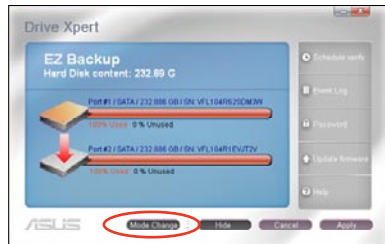

2. Click **Apply** to start configuration.

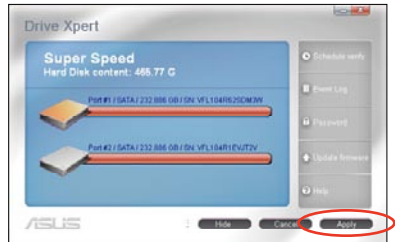

3. A warning message appears, reminding you that all original data in the two hard disks will be erased. Click **OK** to continue.
4. The setup is completed. Click **OK** to restart your computer at once.



5. After restarting your computer, the **Drive Xpert** icon on the Windows® notification area turns green to indicate that **Super Speed** is set up successfully.



If one hard disk is corrupt, all data in both hard disks will be lost.



## Changing to Normal Mode

This mode allows you to disable the **Drive Xpert** function and use the two SATA connectors as the other onboard SATA connectors.



When using one hard disk in **Normal Mode**, connect the hard disk to the SATA\_E1 (orange, port 0) connector on the motherboard.

To change to **Normal Mode**:

1. Click **Mode Change** to return to the main screen.



2. Click **Disable** to start configuration.



3. The setup is completed. Click **Ok** to restart your computer at once.



4. After restarting your computer, the **Drive Xpert** icon on the Windows® notification area turns gray to indicate that the **Drive Xpert** function is disabled.



## Partitioning volumes

You have to partition volumes for the hard disk after Drive Xpert configuration.

To partition volumes:

1. Right-click **My Computer** on the Windows<sup>®</sup> desktop, and then select **Manage** from the pop-up window.

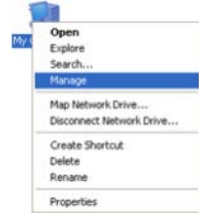

2. Select **Disk Management**. Right-click the unallocated space of the disk, and then select **New Partition**.

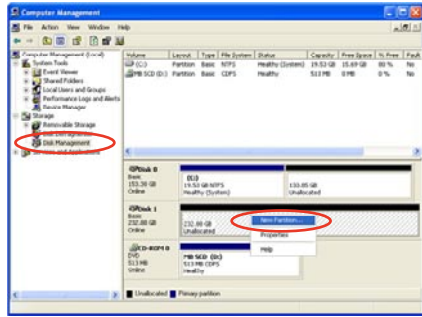

If the **New Partition** option is not available, right-click **Disk** item, and then select **Initialize Disk** to initialize the disk first.

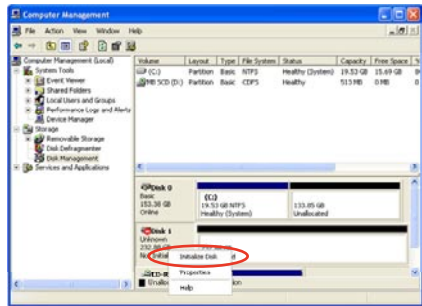

3. A **New Partition Wizard** screen appears. Follow the onscreen instructions to complete the volume partition.

## Other feature buttons

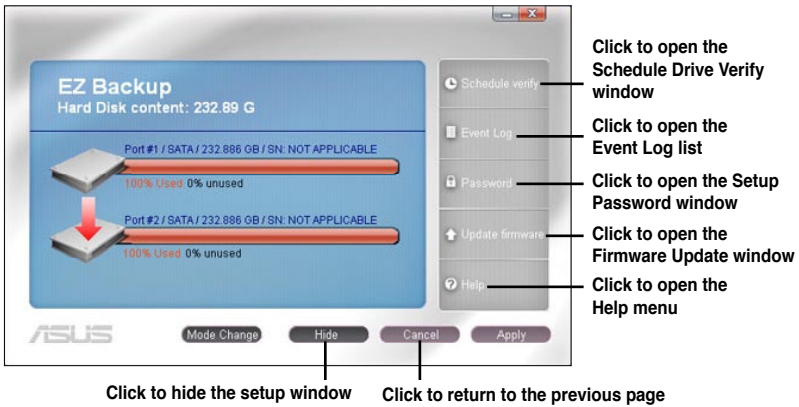

### Schedule Drive Verify

Allows you to set up the schedule for verifying the hard disks. Click **Ok** to apply the settings; click **Cancel** to close the window; and click **Right Now** to start verification at once.

#### **Add / Modify / Delete**

Allows you to create a new schedule, and modify/delete an existing schedule.

#### **Schedule Activity**

Allows you to set verification schedule daily, weekly, or monthly.

#### **New Schedule**

Allows you to set specific date and time for the schedule.

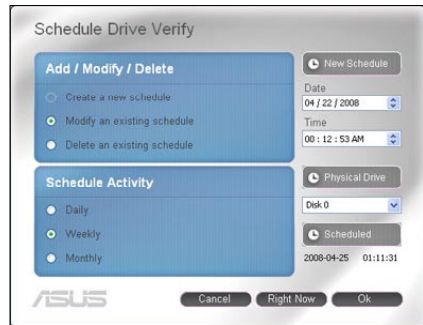

#### **Physical Drive**

Allows you to set schedule for the selected hard disk.

#### **Scheduled**

Displays the date and time for the setup schedule.

### Event Log

Displays event log list that might be helpful for troubleshooting and locating a system malfunction. Click **Refresh** to update the event log list; and click **Ok** to close the window.

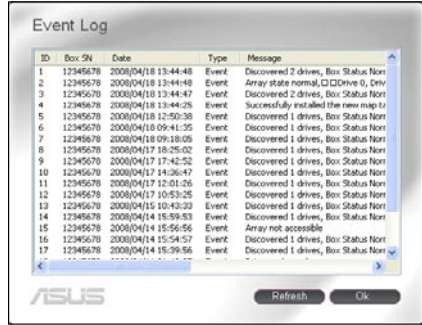

### Setup Password

Allows you to set the password for configuration access. Key in the user name and password. Click **Ok** to apply the settings.



### Firmware Update

Allows you to update the firmware. Click **Browse** to locate the firmware file that you want to update. Then click **Update** to start the update process.

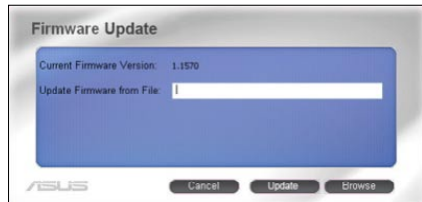

## Using Drive Xpert function in Express Gate environment

You may use **Drive Xpert** function in Express Gate environment by preparing only two hard disks.

For Express Gate environment, you need to use another computer to install Express Gate on a USB flash disk drive in advance.

Follow below instructions to complete the installation:

1. Plug a USB flash disk drive in a computer with OS already installed.
2. Refer to the Express Gate installation on page 4-30. Ensure to select **USB** as the target disk volume when the **Choose target volume** screen appears.
3. Plug the USB flash disk drive to the motherboard. Restart the system, and launch the Express Gate.



### Launching Drive Xpert

To open the ASUS Utility panel, click . Launch Drive Xpert from the ASUS Utility panel. The main screen as shown below appears. Select **EZ Backup** or **Super Speed** according to your need.



Before using the Drive Xpert function, ensure that you have back up all your data in your hard disks.

- **EZ Backup** erases all original data in the hard disk connected to the SATA\_E2 (white, port 1) connector on the motherboard.
- **Super Speed** erases all original data in both hard disks.

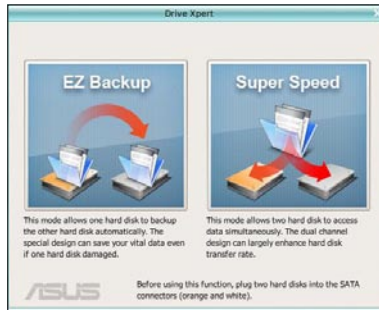

## EZ Backup

To start **EZ Backup** configuration:

1. Click **EZ Backup** from the main screen.
2. Check if the SATA cables and power cords are installed properly. Click **Next** to continue.



3. Click **Next** to continue the configuration.



4. All original data on the hard drive connected to the SATA\_E2 (white, port 1) connector on the motherboard will be erased. Make necessary backup before proceeding. Click **Next** to continue.

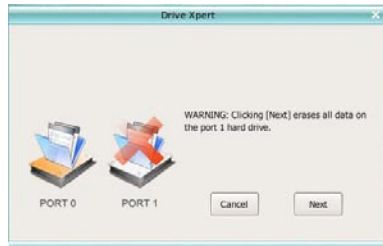

5. The setup is completed. Click **OK** to close the configuration window.

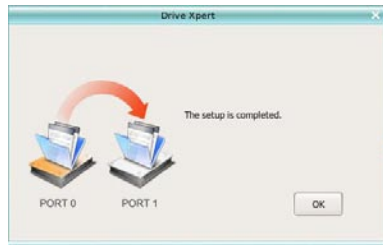

## Super Speed

To start **Super Speed** configuration:

1. Click **Super Speed** from the main screen.
2. Check if the SATA cables and power cords are installed properly. Click **Next** to continue.



3. Click **Next** to continue the configuration.

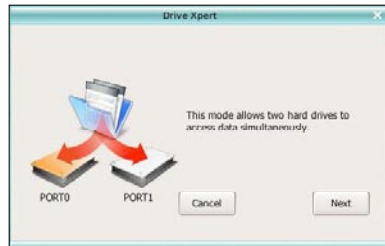

4. Before proceeding, ensure to back up all original data in the two hard disks. Otherwise, the system erases all data in both hard disks. Click **Next** to continue.



5. The setup is completed. Click **OK** to close the configuration window.

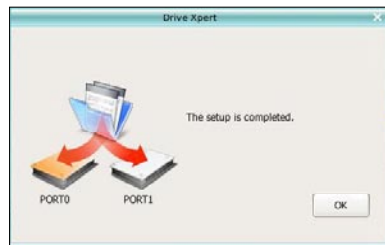

## Using Drive Xpert function in BIOS setup environment

You may use Drive Xpert function in BIOS setup environment. To enter BIOS setup, press **DEL** key after powering on. Drive Xpert configuration options are under **Tools** menu.



Before using the Drive Xpert function, ensure that you have back up all your data in your hard disks.

- **EZ Backup** erases all original data in the hard disk connected to the SATA\_E2 (white, port 1) connector on the motherboard.
- **Super Speed** erases all original data in both hard disks.

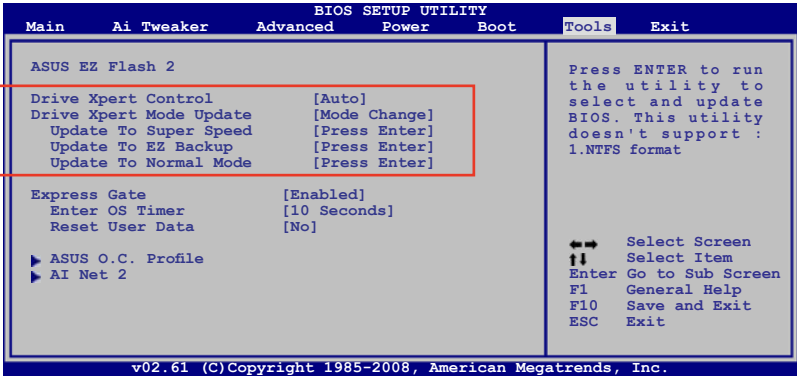

### Drive Xpert Control [Auto]

This item allows you to enable or disable the Drive Xpert function.

Configuration options: [Auto] [Enabled] [Disabled]

### Drive Xpert Mode Update [Last Setting]

This item appears only when you set **Drive Xpert Control** to [Auto] or [Enabled]. Set this item to [Mode Change] to show further settings of the Drive Xpert function. Configuration options: [Last Setting] [Mode Change]



The following items appear only when you set **Drive Xpert Mode Update** to [Mode Change].

### **Update To Super Speed [Press Enter]**

This item allows you to use **Super Speed** function. Plug two identical SATA hard drives in the SATA\_E1 (orange, port 0) and SATA\_E2 (white, port 1) connectors on the motherboard and press the <Enter> key.

### **Update To EZ Backup [Press Enter]**

This item allows you to use **EZ Backup** function. Plug two identical SATA hard drives in the SATA\_E1 (orange, port 0) and SATA\_E2 (white, port 1) connectors on the motherboard and press the <Enter> key.

### **Update To Normal Mode [Press Enter]**

This item allows you to use the SATA\_E1 (orange, port 0) and SATA\_E2 (white, port 1) connectors as normal SATA connectors.



When using one hard disk in **Normal Mode**, connect the hard disk to the SATA\_E1 (orange, port 0) connector on the motherboard.



### 4.3.11 ASUS Express Gate

ASUS Express Gate is an instant-on environment that gives you quick access to the Internet. Within a few seconds of powering on your computer, you will be at the Express Gate menu where you can start the web browser, Skype, or other Express Gate softwares.

#### Installing ASUS Express Gate



- ASUS Express Gate supports installation on SATA HDDs in **IDE mode** only.
- ASUS Express Gate supports HDDs connected to **motherboard chipset-controlled onboard SATA ports** only. All onboard extended SATA ports and external SATA ports are NOT supported. See chapter 2 for the exact location of onboard SATA ports.
- ASUS Express Gate supports installation on USB HDDs and Flash drives, but the software performance may be slower than installed on SATA HDDs.

To install Express Gate on your computer

1. Place the support CD/DVD to the optical drive. The **Drivers** installation tab appears if your computer has enabled Autorun feature.
2. Click the **Utilities** tab, then click **ASUS Express Gate Installer**.
3. Select the language for installation and click **OK**.

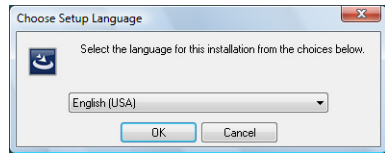

4. The InstallShield Wizard for Express Gate appears. Click **Next** to continue.



5. Select the target disk volume for you to install Express Gate. If you have multiple volumes and OS installed in your hard drive, it is recommended to install Express Gate in **Volume C**. Click **Next** to continue.
6. Follow the screen instructions to complete installation.

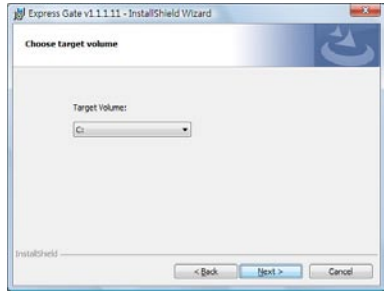

### The First Screen

Express Gate’s first screen appears within a few seconds after you power on the computer. From here, you can immediately start the web browser or Skype.



You can also choose to continue booting normally (e.g. to your installed OS such as Windows), enter BIOS setup, or power off.

If you don’t make any selection, Express Gate will automatically exit and boot to your normal OS after a certain amount of time. The timer countdown is shown on-screen inside the “boot to OS” button. As you move the mouse or type a key, the countdown stops and the timer disappears, so you can take your time to make a selection.

### The Express Gate Environment

The very first time you enter the Express Gate environment (by launching either web or Skype from the first screen), a first time wizard will guide you through basic Express Gate configurations. Basic configurations include language, date and time and screen resolution.

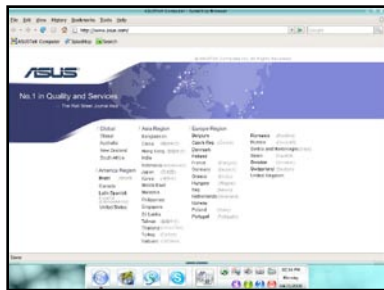

Once inside the Express Gate environment, click on the icons on the LaunchBar, by default at bottom of the screen, to launch or switch between softwares. You can re-arrange, re-size and move windows. Bring a window to the foreground by clicking within it or by clicking on its corresponding software icon. Re-size a window by dragging any of its four corners. Move a window by dragging its title bar.

Besides using the LaunchBar, you can also switch between softwares by pressing <Alt> +<Tab> on the keyboard. You can also right-click anywhere on the desktop to bring up a menu of softwares.

The red triangle on an software icon in the LaunchBar denotes that the software is already running. This means that you can switch to it without any delay. In the rare case where an software stops responding, right-click on its icon to force close it.

## Knowing the Express Gate hot-keys

Here is a list of common-used hot-keys for Express Gate.

### In the First Screen:

Key	Function
PAUSE/BREAK	Power-off
ESC	Continue to boot OS
DEL	Enter BIOS setup
F8	Enter Boot selection pop-up

### In the Express Gate Environment:

Key	Function
<Alt> + <Tab>	Switch between softwares
<Ctrl> + <Alt> + <Del>	Bring up Power-Off dialog box
<Ctrl> + <Alt> + <Print Screen>	Save screen snapshot as picture to file

## Using the Configuration Panel

Use the configuration panel to change various Express Gate settings.

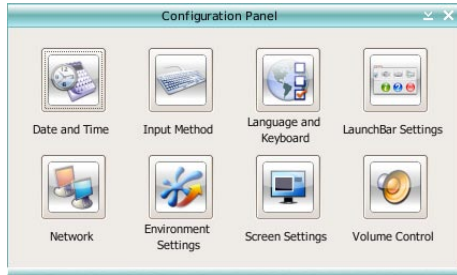

Click on an icon to open a particular configuration tool. The following tools are available:

- **Date and Time:** set current date and time as well as time zone.
- **Input Method:** choose your preferred input language and method.
- **Language and Keyboard:** choose your language and keyboard preferences.
- **LaunchBar Settings:** customize your LaunchBar (where it docks, whether it auto-hides, etc.)
- **Network:** Specify how your computer connects to the Internet. Enable all the network ports that you may use (LAN1, LAN2, and/or wireless [optional]). LAN1 and LAN2 refer to the two RJ-45 network ports on your computer.



- The number of the LAN ports may differ from motherboards.
- You can connect the LAN cable to either port, and Express Gate will automatically use the connected port.

Also specify whether each port uses DHCP (most common) or static IP. For PPPoE and wireless (optional), set the login credentials (user name, password, SSID, etc.) as well.

- **Environment Settings:** This function allows you to clear the Express Gate settings, as well as any personal information stored by the web browser (Bookmarks, Cookies, History, etc.). The user data will be reset to the original default configuration.

After you click **Restore System**, a confirmation dialog box will open. If you click "Yes" in the confirmation dialog box, your system will immediately restart and then re-enter Express Gate to finish clearing the settings. This is also useful in the rare case where settings might become corrupted.



The first-time Wizard will run again when you enter the Express Gate environment after clearing its settings.

- **Screen Settings:** Choose the most optimal screen resolution for your display.
- **Volume Control:** Control the volume for your speaker output, microphone input, etc.

## Using the LaunchBar

The LaunchBar has several system icons that show you various system statuses and let you configure individual Express Gate settings. The LaunchBar can be configured to auto-hide, if you want more screen space for the softwares. It can also be configured to dock on any of the four sides of the screen.



Starts the **Web Browser** for quick access to the World Wide Web.



Starts the **Photo Manager** album / organizer tool.



Starts the **Chat** instant messaging tool.



Start the **Skype** software, which lets you call other people on Skype for free, as well as offering affordable, high quality voice communications to phones all over the world.



Opens **Configuration Panel**, which lets you specify network settings and other preferences.

In the rare case that one of the above softwares stops responding, you can right-click on its icon and then select **Close** to force it to close.

The smaller icons on the right side of the LaunchBar are:



Click on this icon to open the **File Manager** window, which lets you conveniently access the files on a USB drive. If a USB device is detected, the icon contains a green arrow.



ASUS Express Gate supports file uploading from SATA HDDs, ODDs and USB drive and downloading to USB drives only.



Shows network status; click to configure network.



Shows mute status; click to change volume.



Click to choose input language and method as well as keyboard shortcuts (Ctrl-Space by default).



Click to change LaunchBar options (auto-hide, docking position, etc).



Click to show the “ASUS Utility” panel.



Click to show “About Express Gate ”.



Click to open Express Gate Help.



Click to bring up power options window to boot to OS, restart or power down. This window is also shown when you press **Ctrl-Alt-Del** on the keyboard.

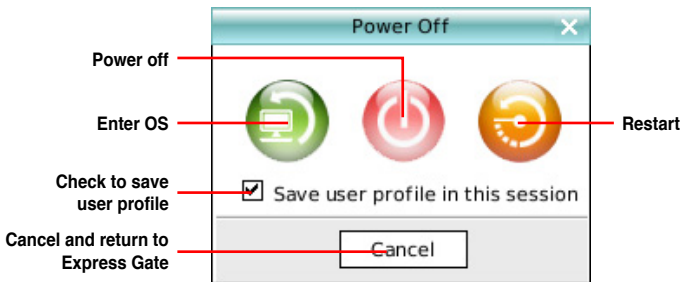

## How Do I Get on to the Internet

If Internet doesn't seem to be working in the Express Gate environment, check the following:

### 1. Open the Configuration Panel.



Open Configuration Panel

## 2. Open Network.

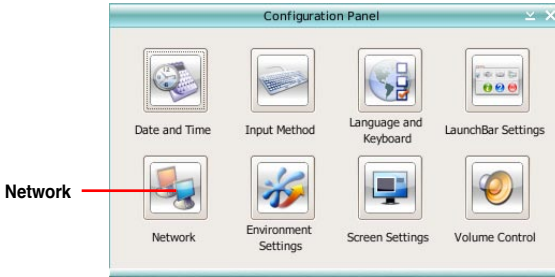

## 3. Make the proper network configurations.

Each network interface is enabled immediately when you check the box next to it.

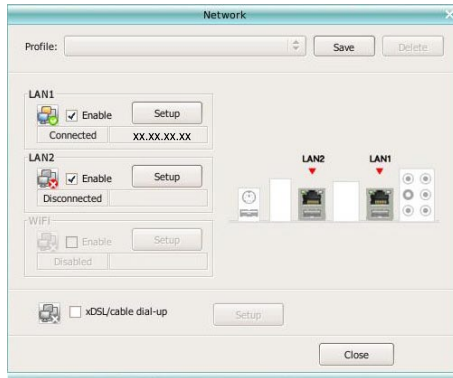

- If you use a network cable connected to a home router (which is then connected to your DSL/cable modem), enable both LAN1 and LAN2. Express Gate will automatically use whichever port (LAN1 or LAN2) is connected.



If you plug the network cable into a different port while Express Gate is running (e.g. move the cable from LAN1 to LAN2), you may need to press the "Refresh" button to detect the change.

- The most common scenario is for your computer to automatically obtain network settings (i.e. DHCP). If this is the case, you don't need to click **Setup** for any LAN port. If this is not the case, click **Setup** to configure the static IP settings manually.

- If you have wireless network, click **Setup** for the WiFi option. In the **WiFi** tab of the **Advanced Network Settings** box, enter the name of your wireless access point in the **SSID** field. If your wireless access point has security enabled, select the corresponding security algorithm from the drop-down list (e.g. WEP/AUTO) in the **Encryption Type** field, and enter the password.  
Click **OK** to enable WiFi and establish the wireless connection.
- If you use a network cable connected directly to your DSL/cable modem (no router in between), click **Setup** for xDSL/cable dial-up. This method is also referred to as PPPoE. Choose whether the DSL/cable modem is connected to your computer's LAN port. Then enter the username and password for your dial-up account.  
Click **OK** to enable xDSL/cable dial-up and establish the PPPoE connection. When PPPoE is enabled, the port it uses will automatically be unchecked and grayed out.

## Using the Photo Manager

Express Gate provides a easy-to-use **Photo Manager** that allows you to view pictures stored in your hard drive or external storage devices (such as USB dongles, card readers, or optical disks). You can view pictures in thumbnail view; in an enlarged view individually; in a filename/data list view; or play them in a slideshow with background music and fancy transition effects. JPEG, GIF, BMP, and PNG formats are supported. Refer to the on-line Help for detailed software operation.

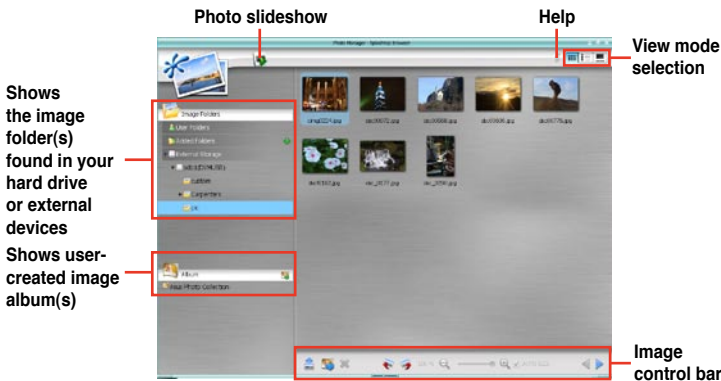

ASUS Express Gate supports HDDs connected to **motherboard chipset-controlled onboard SATA ports** only. All onboard extended SATA ports and external SATA ports are NOT supported.



## Using ASUS Drive Xpert

Without drivers or BIOS setups, the ASUS exclusive Drive Xpert is ideal for anyone who needs to secure data on their hard drives or enhance hard drive performances without the hassles of complicated configurations.

To start ASUS Drive Xpert application

1. Open the ASUS Utility panel.



Open ASUS Utility Panel

2. Launch Drive Xpert from the ASUS Utility Panel.



3. Select **EZ Backup** or **Super Speed** according to your need.

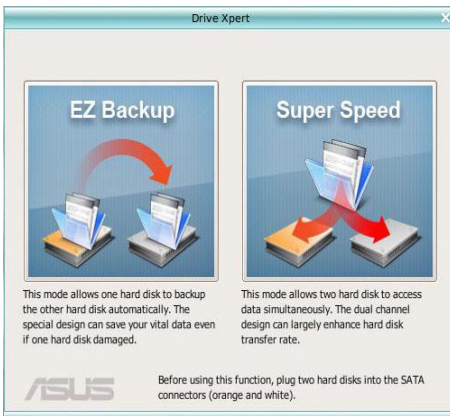

Refer to section **4.3.11 ASUS Drive Xpert** for detailed software settings.

## Configuring Express Gate in BIOS Setup

Enter BIOS setup by pressing DEL key after powering on or by clicking on the BIOS setup icon on Express Gate's first screen. Express Gate configuration options are under the **Tools** menu. Refer to section **3.8.2 Express Gate** for details.

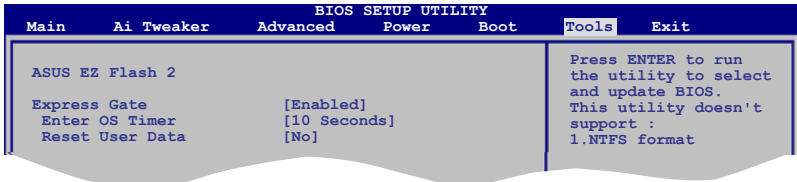

## Updating Express Gate

You may update your existing Express Gate software to new versions. New versions of the Express Gate software will be released regularly, adding refinements or new applications. You can find original version of the software on the support DVD or download new versions from the ASUS support website.

To update Express Gate

1. Double-click the Express Gate setup file to start software update.
2. A software update confirmation dialog box appears. Click **Yes** to continue.
3. The InstallShield Wizard for Express Gate appears. Click **Next** to continue.
4. Follow the screen instructions to complete installation.

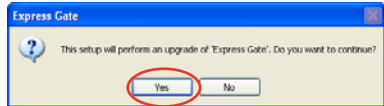

## Repairing Express Gate

In case Express Gate cannot start normally, you can repair Express Gate by reinstalling the software or using the repairing utility.

To repair Express Gate

- Click **Start > All Programs > Express Gate > Express Gate Installer > Repair this software.**  
OR
- Double click the Express Gate setup file, choose **Repair**, and click **Next** to continue.

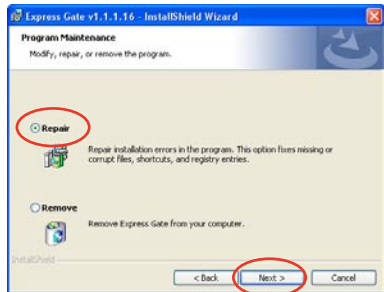

## 4.4 RAID configurations

The motherboard comes with the Intel® ICH10R Southbridge controller that supports RAID 0, RAID 1, RAID 10, and RAID 5 for six independent Serial ATA channels.

### 4.4.1 RAID definitions

**RAID 0 (Data striping)** optimizes two identical hard disk drives to read and write data in parallel, interleaved stacks. Two hard disks perform the same work as a single drive but at a sustained data transfer rate, double that of a single disk alone, thus improving data access and storage. Use of two new identical hard disk drives is required for this setup.

**RAID 1 (Data mirroring)** copies and maintains an identical image of data from one drive to a second drive. If one drive fails, the disk array management software directs all applications to the surviving drive as it contains a complete copy of the data in the other drive. This RAID configuration provides data protection and increases fault tolerance to the entire system. Use two new drives or use an existing drive and a new drive for this setup. The new drive must be of the same size or larger than the existing drive.

**RAID 5** stripes both data and parity information across three or more hard disk drives. Among the advantages of RAID 5 configuration include better HDD performance, fault tolerance, and higher storage capacity. The RAID 5 configuration is best suited for transaction processing, relational database applications, enterprise resource planning, and other business systems. Use a minimum of three identical hard disk drives for this setup.

**RAID 10** is data striping and data mirroring combined without parity (redundancy data) having to be calculated and written. With the RAID 10\* configuration you get all the benefits of both RAID 0 and RAID 1 configurations. Use four new hard disk drives or use an existing drive and three new drives for this setup.

**Intel® Matrix Storage.** The Intel® Matrix Storage technology supported by the ICH9R chip allows you to create a RAID 0, RAID 1, RAID 5, and RAID 10\* function to improve both system performance and data safety. You can also combine two RAID sets to get higher performance, capacity, or fault tolerance provided by the difference RAID function. For example, RAID 0 and RAID 1 set can be created by using only two identical hard disk drives.



---

If you want to boot the system from a hard disk drive included in a created RAID set, copy first the RAID driver from the support DVD to a floppy disk before you install an operating system to the selected hard disk drive. Refer to section 4.5 **Creating a RAID driver disk** for details.

---

## 4.4.2 Installing Serial ATA hard disks

The motherboard supports Serial ATA hard disk drives. For optimal performance, install identical drives of the same model and capacity when creating a disk array.

To install the SATA hard disks for a RAID configuration:

1. Install the SATA hard disks into the drive bays.
2. Connect the SATA signal cables.
3. Connect a SATA power cable to the power connector on each drive.

## 4.4.3 Intel® RAID configurations

This motherboard supports RAID 0, RAID 1, RAID 5, RAID 10 and Intel® Matrix Storage configurations for Serial ATA hard disks drives through the Intel® ICH10R Southbridge chip.

### Setting the RAID item in BIOS

You must set the RAID item in the BIOS Setup before you can create a RAID set(s). To do this:

1. Enter the BIOS Setup during POST.
2. Go to the **Main** menu, select **Storage Configuration**, then press <Enter>.
3. Select the item **Configure SATA as**, then press <Enter> to display the configuration options.
4. Select [RAID] from the **Configure SATA as** item options, then press <Enter>.
5. Save your changes, then exit the BIOS Setup.



---

Refer to the system or the motherboard user guide for details on entering and navigating through the BIOS Setup.

---

## Intel® Matrix Storage Manager option ROM utility

The Intel® Matrix Storage Manager Option ROM utility allows you to create RAID 0, RAID 1, RAID 10 (RAID 0+1), and RAID 5 set(s) from Serial ATA hard disk drives that are connected to the Serial ATA connectors supported by the Southbridge.

To enter the Intel® Matrix Storage Manager option ROM utility:

1. Install all the Serial ATA hard disk drives.
2. Turn on the system.
3. During POST, press <Ctrl+I> to display the utility main menu.

```
Intel(R) Matrix Storage Manager Option ROM v8.0.0.1027 ICH10R wRAID5
Copyright(C) 2003-08 Intel Corporation. All Rights Reserved.

[ MAIN MENU ]
1. Create RAID Volume          3. Reset Disks to Non-RAID
2. Delete RAID Volume         4. Exit

[ DISK/VOLUME INFORMATION ]

RAID Volumes:
None defined.

Physical Disks:
Port Drive Model      Serial #              Size   Type/Status (Vol ID)
0  XXXXXXXXXXXX        XXXXXXXX             XX.XXGB Non-RAID Disk
1  XXXXXXXXXXXX        XXXXXXXX             XX.XXGB Non-RAID Disk
2  XXXXXXXXXXXX        XXXXXXXX             XX.XXGB Non-RAID Disk
3  XXXXXXXXXXXX        XXXXXXXX             XX.XXGB Non-RAID Disk

[↑]-Select      [ESC]-Exit      [ENTER]-Select Menu
```

The navigation keys at the bottom of the screen allow you to move through the menus and select the menu options.



The RAID BIOS setup screens shown in this section are for reference only and may not exactly match the items on your screen.

## Creating a RAID 0 set (striped)

To create a RAID 0 set:

1. From the utility main menu, select **1. Create RAID Volume** and press <Enter>. The following screen appears.



2. Enter a name for the RAID 0 set and press <Enter>.
3. When the RAID Level item is highlighted, press the up/down arrow key to select **RAID 0(Stripe)**, and then press <Enter>.
4. When the Disks item is highlighted, press <Enter> to select the hard disk drives to configure as RAID. The following screen appears.

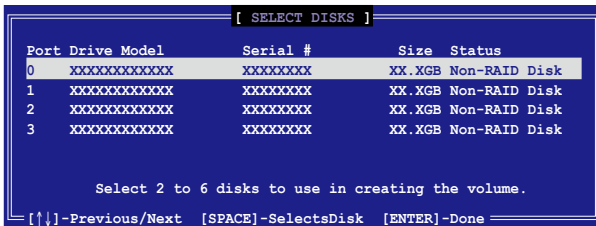

5. Use the up/down arrow key to highlight a drive, and then press <Space> to select. A small triangle marks the selected drive. Press <Enter> after completing your selection.

6. Use the up/down arrow key to select the stripe size for the RAID 0 array, and then press <Enter>. The available stripe size values range from 4 KB to 128 KB. The default stripe size is 128 KB.



---

We recommend a lower stripe size for server systems, and a higher stripe size for multimedia computer systems used mainly for audio and video editing.

---

7. Enter the RAID volume capacity that you want and press <Enter>. The default value indicates the maximum capacity allowed.
8. Press <Enter> when the Create Volume item is highlighted. The following warning message appears.



9. Press <Y> to create the RAID volume and return to the main menu, or <N> to go back to the Create Volume menu.

## Creating a RAID 1 set (mirrored)

To create a RAID 1 set:

1. From the utility main menu, select **1. Create RAID Volume** and press <Enter>. The following screen appears.

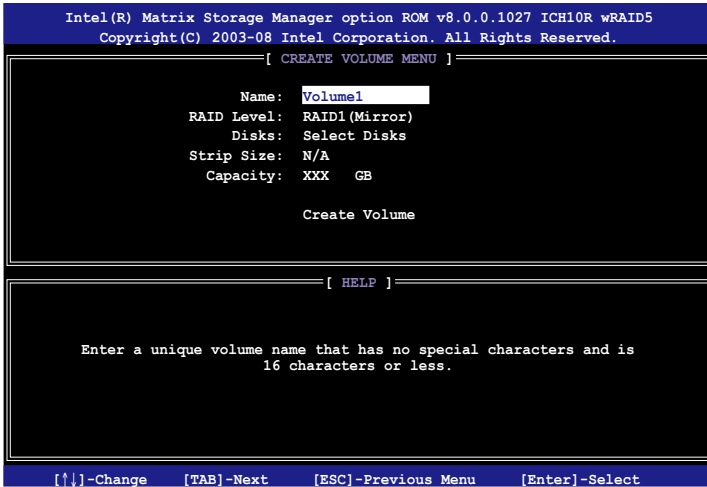

2. Enter a name for the RAID 1 set and press <Enter>.
3. When the RAID Level item is highlighted, press the up/down arrow key to select **RAID 1(Mirror)**, then press <Enter>.
4. When the Capacity item is highlighted, enter the RAID volume capacity that you want, and then press <Enter>. The default value indicates the maximum capacity allowed.
5. Press <Enter> when the Create Volume item is highlighted. The following warning message appears.



6. Press <Y> to create the RAID volume and return to main menu or <N> to go back to Create Volume menu.



## Creating a RAID 10 set (RAID 0+1)

To create a RAID 10 set:

1. From the utility main menu, select **1. Create RAID Volume** and press <Enter>. The following screen appears.

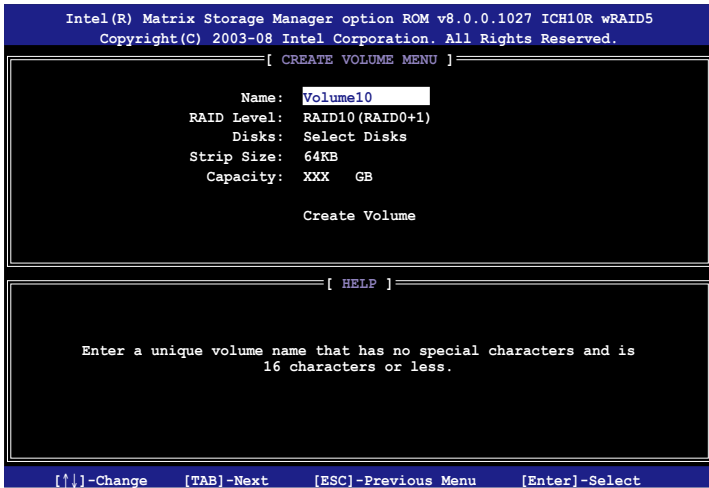

2. Enter a name for the RAID 10 set and press <Enter>.
3. When the RAID Level item is highlighted, press the up/down arrow key to select **RAID 10 (RAID 0+1)**, and then press <Enter>.
4. When the Stripe Size item is highlighted, press the up/down arrow key to select the stripe size for the RAID 10 array, and then press <Enter>. The available stripe size values range from 4 KB to 64 KB. The default stripe size is 64 KB.



---

We recommend a lower stripe size for server systems, and a higher stripe size for multimedia computer systems used mainly for audio and video editing.

---

5. Enter the RAID volume capacity that you want and press <Enter>. The default value indicates the maximum capacity allowed.

- Press <Enter> when the Create Volume item is highlighted. The following warning message appears.

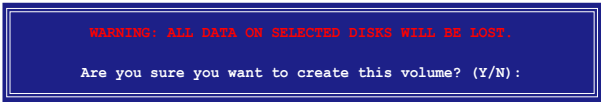

- Press <Y> to create the RAID volume and return to the main menu or <N> to go back to the Create Volume menu.

### Creating a RAID 5 set (parity)

To create a RAID 5 set:

- From the utility main menu, select **1. Create RAID Volume** and press <Enter>. The following screen appears.

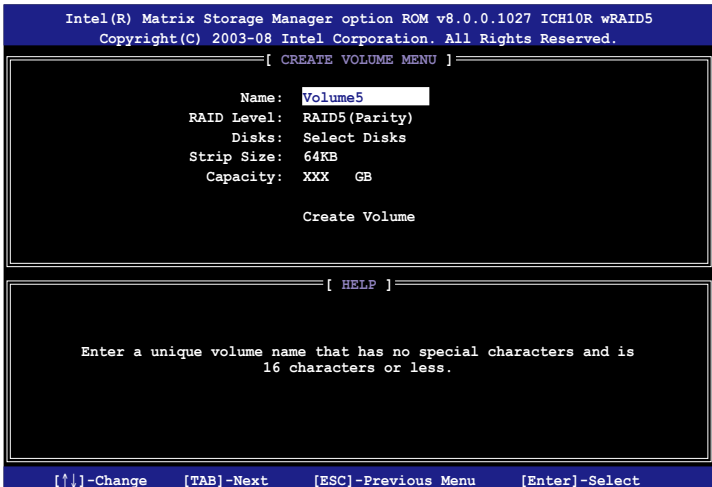

- Enter a name for the RAID 5 set and press <Enter>.
- When the RAID Level item is highlighted, press the up/down arrow key to select **RAID 5(Parity)**, and then press <Enter>.

- The Disks item is highlighted, press <Enter> to select the hard disk drives to configure as RAID. The following screen appears.

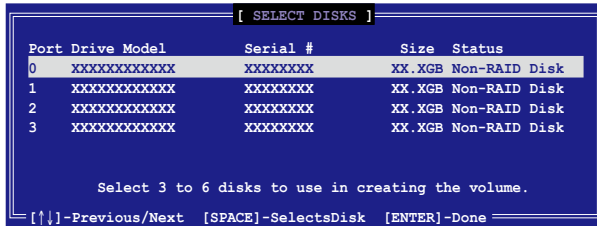

- Use the up/down arrow key to highlight the drive you want to set, and then press <Space> to select. A small triangle marks the selected drive. Press <Enter> after completing your selection.
- When the Stripe Size item is highlighted, press the up/down arrow key to select the stripe size for the RAID 5 array, and then press <Enter>. The available stripe size values range from 16 KB to 128 KB. The default stripe size is 64 KB.



We recommend a lower stripe size for server systems, and a higher stripe size for multimedia computer systems used mainly for audio and video editing.

- Enter the RAID volume capacity that you want and then press <Enter>. The default value indicates the maximum allowed capacity.
- Press <Enter> when the Create Volume item is highlighted. The following warning message appears.



- Press <Y> to create the RAID volume and return to the main menu or <N> to go back to the Create Volume menu.

## 4.5 Creating a RAID driver disk

A floppy disk with the RAID driver is required when installing Windows® XP/Vista and later operating system on a hard disk drive that is included in a RAID set. For Windows Vista user, you can create a RAID driver disk with a floppy disk drive or a USB flash disk drive.

### 4.5.1 Creating a RAID driver disk without entering the OS

To create a RAID driver disk without entering the OS:

1. Boot your computer.
2. Press <Del> during POST to enter the BIOS setup utility.
3. Set the optical drive as the primary boot device.
4. Insert the support DVD into the optical drive.
5. Save changes and exit BIOS.
6. Press any key when the system prompts “Press any key to boot from the optical drive.”
7. When the menu appears, press <1> to create a RAID driver disk.
8. Insert a formatted floppy disk into the floppy drive then press <Enter>.
9. Follow succeeding screen instructions to complete the process.

### 4.5.2 Creating a RAID driver disk in Windows®

To create a RAID driver disk in Windows®:

1. Start Windows®.
2. Place the motherboard support DVD into the optical drive.
3. Go to the **Make disk** menu, and then click **Intel ICH10R 32/64 bit RAID Driver Disk** to create an Intel® ICH10R RAID driver disk.
4. Insert a floppy disk into the floppy disk drive or connect a USB flash disk if you are using Windows Vista OS.
5. Follow succeeding screen instructions to complete the process.



---

Write-protect the floppy disk to avoid computer virus infection.

---

To install the RAID driver in Windows XP:

1. During the OS installation, the system prompts you to press the <F6> key to install third-party SCSI or RAID driver.
2. Press <F6> then insert the floppy disk with RAID driver into the floppy disk drive.
3. When prompted to select the SCSI adapter to install, make sure you select **Intel(R) SATA RAID Controller (Desktop ICH10R)**.
4. Follow the succeeding screen instructions to complete the installation.

To install the RAID driver in Windows® Vista:

1. Insert the floppy disk/USB device with RAID driver into the floppy disk drive/USB port.
2. During the OS installation, select **Intel(R) SATA RAID Controller (Desktop ICH10R)**.
3. Follow the succeeding screen instructions to complete the installation.



The Appendix describes the CPU features and technologies that the motherboard supports.

# CPU features



## Chapter summary



A.1	Intel® EM64T.....	A-1
A.2	Enhanced Intel SpeedStep® Technology (EIST).....	A-1
A.3	Intel® Hyper-Threading Technology .....	A-3



## A.1 Intel® EM64T



- The motherboard is fully compatible with Intel® LGA775 processors running on 32-bit operating systems.
- The motherboard comes with a BIOS file that supports EM64T. You can download the latest BIOS file from the ASUS website ([www.asus.com/support/download/](http://www.asus.com/support/download/)) if you need to update the BIOS file. See Chapter 4 for details.
- Visit [www.intel.com](http://www.intel.com) for more information on the EM64T feature.
- Visit [www.microsoft.com](http://www.microsoft.com) for more information on Windows® 64-bit OS.

### Using the Intel® EM64T feature

To use the Intel® EM64T feature:

1. Install an Intel® CPU that supports the Intel® EM64T.
2. Install a 64-bit operating system (Windows® Vista 64-bit Edition or Windows® XP Professional x64 Edition).
3. Install the 64-bit drivers for the motherboard components and devices from the support DVD.
4. Install the 64-bit drivers for expansion cards or add-on devices, if any.



Refer to the expansion card or add-on device(s) documentation, or visit the related website, to verify if the card/device supports a 64-bit system.

## A.2 Enhanced Intel SpeedStep® Technology (EIST)



- The motherboard comes with a BIOS file that supports EIST. You can download the latest BIOS file from the ASUS website ([www.asus.com/support/download/](http://www.asus.com/support/download/)) if you need to update the BIOS. See Chapter 4 for details.
- Visit [www.intel.com](http://www.intel.com) for more information on the EIST feature.

### A.2.1 System requirements

Before using EIST, check your system if it meets the following requirements:

- Intel® processor with EIST support
- BIOS file with EIST support
- Operating system with EIST support (Windows® Vista, Windows® XP SP2/ Linux 2.6 kernel or later versions)

## A.2.2 Using the EIST

To use the EIST feature:

1. Turn on the computer, then enter the BIOS Setup.
2. Go to the Advanced Menu, highlight CPU Configuration, then press <Enter>.
3. Set the Intel(R) SpeedStep Technology item to [Automatic], then press <Enter>.
4. Press <F10> to save your changes and exit the BIOS setup.
5. After the computer restarts, right click on a blank space on the desktop, then select Properties from the pop-up menu.
6. When the Display Properties window appears, click the Screen Saver tab.
7. Click the Power button on the Monitor power section to open the Power Options Properties window.

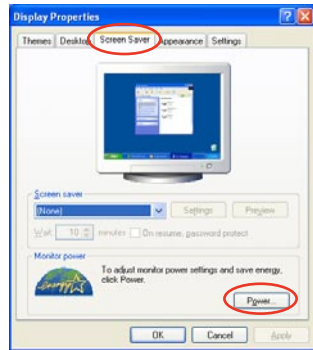

8. On the Power schemes section, click , then select any option except Home/Office Desktop or Always On.
9. Click Apply, then click OK.
10. Close the Display Properties window.

After you adjust the power scheme, the CPU internal frequency slightly decreases when the CPU loading is low.

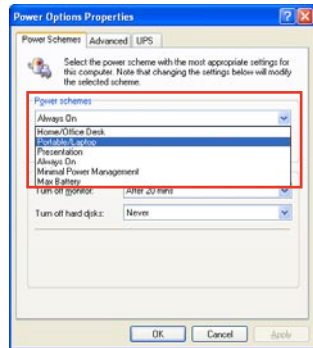

The screen displays and procedures may vary depending on the operating system.

## A.3 Intel® Hyper-Threading Technology

---



- The motherboard supports Intel® Pentium® 4 LGA775 processors with Hyper-Threading Technology.
  - Hyper-Threading Technology is supported under Windows® Vista/XP and Linux 2.4.x (kernel) and later versions only. Under Linux, use the Hyper-Threading compiler to compile the code. If you are using any other operating systems, disable the Hyper-Threading Technology item in the BIOS to ensure system stability and performance.
  - Installing Windows® XP Service Pack 1 or later version is recommended.
  - Make sure to enable the Hyper-Threading Technology item in BIOS before installing a supported operating system.
  - For more information on Hyper-Threading Technology, visit [www.intel.com/info/hyperthreading](http://www.intel.com/info/hyperthreading).
- 

### Using the Hyper-Threading Technology

To use the Hyper-Threading Technology:

1. Install an Intel® Pentium® 4 CPU that supports Hyper-Threading Technology.
2. Power up the system and enter the BIOS Setup. Under the Advanced Menu, make sure that the item **Hyper-Threading Technology** is set to [Enabled].  
The BIOS item appears only if you installed a CPU that supports Hyper-Threading Technology.
3. Restart the computer.

