

P5E3 Deluxe



Motherboard

E3843

Third Edition V3

April 2008

Copyright © 2008 ASUSTeK COMPUTER INC. All Rights Reserved.

No part of this manual, including the products and software described in it, may be reproduced, transmitted, transcribed, stored in a retrieval system, or translated into any language in any form or by any means, except documentation kept by the purchaser for backup purposes, without the express written permission of ASUSTeK COMPUTER INC. ("ASUS").

Product warranty or service will not be extended if: (1) the product is repaired, modified or altered, unless such repair, modification or alteration is authorized in writing by ASUS; or (2) the serial number of the product is defaced or missing.

ASUS PROVIDES THIS MANUAL "AS IS" WITHOUT WARRANTY OF ANY KIND, EITHER EXPRESS OR IMPLIED, INCLUDING BUT NOT LIMITED TO THE IMPLIED WARRANTIES OR CONDITIONS OF MERCHANTABILITY OR FITNESS FOR A PARTICULAR PURPOSE. IN NO EVENT SHALL ASUS, ITS DIRECTORS, OFFICERS, EMPLOYEES OR AGENTS BE LIABLE FOR ANY INDIRECT, SPECIAL, INCIDENTAL, OR CONSEQUENTIAL DAMAGES (INCLUDING DAMAGES FOR LOSS OF PROFITS, LOSS OF BUSINESS, LOSS OF USE OR DATA, INTERRUPTION OF BUSINESS AND THE LIKE), EVEN IF ASUS HAS BEEN ADVISED OF THE POSSIBILITY OF SUCH DAMAGES ARISING FROM ANY DEFECT OR ERROR IN THIS MANUAL OR PRODUCT.

SPECIFICATIONS AND INFORMATION CONTAINED IN THIS MANUAL ARE FURNISHED FOR INFORMATIONAL USE ONLY, AND ARE SUBJECT TO CHANGE AT ANY TIME WITHOUT NOTICE, AND SHOULD NOT BE CONSTRUED AS A COMMITMENT BY ASUS. ASUS ASSUMES NO RESPONSIBILITY OR LIABILITY FOR ANY ERRORS OR INACCURACIES THAT MAY APPEAR IN THIS MANUAL, INCLUDING THE PRODUCTS AND SOFTWARE DESCRIBED IN IT.

Products and corporate names appearing in this manual may or may not be registered trademarks or copyrights of their respective companies, and are used only for identification or explanation and to the owners' benefit, without intent to infringe.

Contents

Contents	iii
Notices	viii
Safety information	ix
About this guide	x
P5E3 Deluxe specifications summary	xii
Chapter 1: Product introduction	
1.1 Welcome!	1-1
1.2 Package contents	1-1
1.3 Special features	1-2
1.3.1 Product highlights	1-2
1.3.2 ASUS AI Lifestyle unique features	1-4
1.3.3 ASUS Intelligent Performance and Overclocking features	1-7
Chapter 2: Hardware information	
2.1 Before you proceed	2-1
Onboard LED	2-1
2.2 Motherboard overview	2-2
2.2.1 Placement direction	2-2
2.2.2 Screw holes	2-2
2.2.3 Motherboard layout	2-3
2.2.4 Layout contents	2-4
2.3 Central Processing Unit (CPU)	2-6
2.3.1 Installing the CPU	2-7
2.3.2 Installing the CPU heatsink and fan	2-9
2.3.3 Uninstalling the CPU heatsink and fan	2-11
2.4 System memory	2-13
2.4.1 Overview	2-13
2.4.2 Memory configurations	2-13
2.4.3 Installing a DIMM	2-17
2.4.4 Removing a DIMM	2-17
2.5 Expansion slots	2-18
2.5.1 Installing an expansion card	2-18
2.5.2 Configuring an expansion card	2-18
2.5.3 Interrupt assignments	2-19

Contents

- 2.5.4 PCI slots..... 2-20
- 2.5.5 PCI Express x1 slots..... 2-20
- 2.5.6 PCI Express 2.0 x16 slots..... 2-20
- 2.5.7 AI Slot Detector..... 2-21
- 2.6 Jumper..... 2-22**
- 2.7 Connectors..... 2-23**
 - 2.7.1 Rear panel connectors..... 2-23
 - 2.7.2 Internal connectors..... 2-26
 - 2.7.3 Installing the optional fans..... 2-38

- Chapter 3: Powering up**
 - 3.1 Starting up for the first time..... 3-1**
 - 3.2 Turning off the computer..... 3-2**
 - 3.2.1 Using the OS shut down function..... 3-2
 - 3.2.2 Using the dual function power switch..... 3-2

- Chapter 4: BIOS setup**
 - 4.1 Managing and updating your BIOS..... 4-1**
 - 4.1.1 ASUS Update utility..... 4-1
 - 4.1.2 ASUS EZ Flash 2 utility..... 4-4
 - 4.1.3 AFUDOS utility..... 4-5
 - 4.1.4 ASUS CrashFree BIOS 3 utility..... 4-7
 - 4.2 BIOS setup program..... 4-8**
 - 4.2.1 BIOS menu screen..... 4-9
 - 4.2.2 Menu bar..... 4-9
 - 4.2.3 Navigation keys..... 4-9
 - 4.2.4 Menu items..... 4-10
 - 4.2.5 Sub-menu items..... 4-10
 - 4.2.6 Configuration fields..... 4-10
 - 4.2.7 Pop-up window..... 4-10
 - 4.2.8 Scroll bar..... 4-10
 - 4.2.9 General help..... 4-10
 - 4.3 Main menu..... 4-11**
 - 4.3.1 System Time..... 4-11
 - 4.3.2 System Date..... 4-11
 - 4.3.3 Legacy Diskette A..... 4-11

Contents

4.3.4	Language	4-11
4.3.5	SATA 1-6	4-12
4.3.6	SATA Configuration	4-13
4.3.7	AHCI Configuration	4-14
4.3.8	System Information	4-15
4.4	Ai Tweaker menu	4-16
4.4.1	Ai Overclock Tuner	4-16
4.4.2	CPU Ratio Control	4-17
4.4.3	FSB Strap to North Bridge	4-17
4.4.4	DRAM Frequency	4-18
4.4.5	DRAM Command Rate	4-18
4.4.6	DRAM Timing Control	4-18
4.4.7	DRAM Static Read Control	4-19
4.4.8	DRAM Dynamic Write Control	4-19
4.4.9	Ai Clock Twister	4-19
4.4.10	Ai Clock Skew for Channel A	4-20
4.4.11	Ai Clock Skew for Channel B	4-20
4.4.12	Ai Transaction Booster	4-20
4.4.13	CPU Spread Spectrum	4-22
4.4.14	PCIe Spread Spectrum	4-22
4.5	Advanced menu	4-23
4.5.1	CPU Configuration	4-23
4.5.2	Chipset	4-25
4.5.3	Onboard Device Configuration	4-26
4.5.4	USB Configuration	4-27
4.5.5	PCIPnP	4-28
4.6	Power menu	4-29
4.6.1	Suspend Mode	4-29
4.6.2	Repost Video on S3 Resume	4-29
4.6.3	ACPI 2.0 Support	4-29
4.6.4	ACPI APIC Support	4-29
4.6.5	APM Configuration	4-30
4.6.6	Hardware Monitor	4-31
4.7	Boot menu	4-33
4.7.1	Boot Device Priority	4-33

Contents

- 4.7.2 Boot Settings Configuration 4-34
- 4.7.3 Security 4-35
- 4.8 Tools menu 4-37**
 - 4.8.1 ASUS EZ Flash 2 4-37
 - 4.8.2 ASUS O.C. Profile..... 4-38
 - 4.8.3 Ai Net 2 4-39
- 4.9 Exit menu 4-40**

- Chapter 5: Software support**
- 5.1 Installing an operating system 5-1**
- 5.2 Support DVD information 5-1**
 - 5.2.1 Running the support DVD 5-1
 - 5.2.2 Drivers menu..... 5-2
 - 5.2.3 Utilities menu 5-3
 - 5.2.4 Make disk menu..... 5-5
 - 5.2.5 Manual menu 5-6
 - 5.2.6 ASUS Contact information 5-6
 - 5.2.7 Other information 5-7
- 5.3 Software information 5-9**
 - 5.3.1 ASUS MyLogo3™ 5-9
 - 5.3.2 AI NET25-11
 - 5.3.3 ASUS PC Probe II..... 5-12
 - 5.3.4 ASUS AI Suite..... 5-18
 - 5.3.5 ASUS EPU Utility—AI Gear 3+..... 5-20
 - 5.3.6 ASUS AI Nap 5-22
 - 5.3.7 ASUS Q-Fan 2 5-23
 - 5.3.8 ASUS AI Booster..... 5-24
 - 5.3.9 ASUS AI Direct Link 5-25
 - 5.3.10 AI Audio 2 (SoundMAX® High Definition Audio utility) ... 5-27
- 5.4 RAID configurations 5-36**
 - 5.4.1 RAID definitions 5-36
 - 5.4.2 Installing Serial ATA hard disks 5-37
 - 5.4.3 Intel® RAID configurations..... 5-37
 - 5.4.4 JMicron® RAID Configuration 5-45
- 5.5 Creating a RAID driver disk..... 5-53**
 - 5.5.1 Creating a RAID driver disk without entering the OS.... 5-53

5.5.2	Creating a RAID driver disk in Windows®	5-53
-------	---	------

Chapter 6: ATI® CrossFire™ technology support

6.1	Overview	6-1
6.1.1	Requirements	6-1
6.1.2	Before you begin	6-1
6.2	Installing CrossFire™ graphics cards	6-2
6.3	Software information	6-5
6.3.1	Installing the device drivers	6-5
6.3.2	Using the Catalyst™ Control Center	6-7

Appendix: CPU features

A.1	Intel® EM64T	A-1
	Using the Intel® EM64T feature	A-1
A.2	Enhanced Intel SpeedStep® Technology (EIST)	A-1
A.2.1	System requirements	A-1
A.2.2	Using the EIST	A-2
A.3	Intel® Hyper-Threading Technology	A-3
	Using the Hyper-Threading Technology	A-3

Notices

Federal Communications Commission Statement

This device complies with Part 15 of the FCC Rules. Operation is subject to the following two conditions:

- This device may not cause harmful interference, and
- This device must accept any interference received including interference that may cause undesired operation.

This equipment has been tested and found to comply with the limits for a Class B digital device, pursuant to Part 15 of the FCC Rules. These limits are designed to provide reasonable protection against harmful interference in a residential installation. This equipment generates, uses and can radiate radio frequency energy and, if not installed and used in accordance with manufacturer's instructions, may cause harmful interference to radio communications. However, there is no guarantee that interference will not occur in a particular installation. If this equipment does cause harmful interference to radio or television reception, which can be determined by turning the equipment off and on, the user is encouraged to try to correct the interference by one or more of the following measures:

- Reorient or relocate the receiving antenna.
- Increase the separation between the equipment and receiver.
- Connect the equipment to an outlet on a circuit different from that to which the receiver is connected.
- Consult the dealer or an experienced radio/TV technician for help.



The use of shielded cables for connection of the monitor to the graphics card is required to assure compliance with FCC regulations. Changes or modifications to this unit not expressly approved by the party responsible for compliance could void the user's authority to operate this equipment.

Canadian Department of Communications Statement

This digital apparatus does not exceed the Class B limits for radio noise emissions from digital apparatus set out in the Radio Interference Regulations of the Canadian Department of Communications.

This class B digital apparatus complies with Canadian ICES-003.

Safety information

Electrical safety

- To prevent electrical shock hazard, disconnect the power cable from the electrical outlet before relocating the system.
- When adding or removing devices to or from the system, ensure that the power cables for the devices are unplugged before the signal cables are connected. If possible, disconnect all power cables from the existing system before you add a device.
- Before connecting or removing signal cables from the motherboard, ensure that all power cables are unplugged.
- Seek professional assistance before using an adapter or extension cord. These devices could interrupt the grounding circuit.
- Make sure that your power supply is set to the correct voltage in your area. If you are not sure about the voltage of the electrical outlet you are using, contact your local power company.
- If the power supply is broken, do not try to fix it by yourself. Contact a qualified service technician or your retailer.

Operation safety

- Before installing the motherboard and adding devices on it, carefully read all the manuals that came with the package.
- Before using the product, make sure all cables are correctly connected and the power cables are not damaged. If you detect any damage, contact your dealer immediately.
- To avoid short circuits, keep paper clips, screws, and staples away from connectors, slots, sockets and circuitry.
- Avoid dust, humidity, and temperature extremes. Do not place the product in any area where it may become wet.
- Place the product on a stable surface.
- If you encounter technical problems with the product, contact a qualified service technician or your retailer.



This symbol of the crossed out wheeled bin indicates that the product (electrical, electronic equipment and mercury-containing button cell battery) should not be placed in municipal waste. Check local regulations for disposal of electronic products.

About this guide

This user guide contains the information you need when installing and configuring the motherboard.

How this guide is organized

This guide contains the following parts:

- **Chapter 1: Product introduction**
This chapter describes the features of the motherboard and the new technology it supports.
- **Chapter 2: Hardware information**
This chapter lists the hardware setup procedures that you have to perform when installing system components. It includes description of the switches, jumpers, and connectors on the motherboard.
- **Chapter 3: Powering up**
This chapter describes the power up sequence and ways of shutting down the system.
- **Chapter 4: BIOS setup**
This chapter tells how to change system settings through the BIOS Setup menus. Detailed descriptions of the BIOS parameters are also provided.
- **Chapter 5: Software support**
This chapter describes the contents of the support CD that comes with the motherboard package and the software.
- **Chapter 6: ATI CrossFire™ support**
This chapter describes the ATI CrossFire™ feature and shows the graphics card installation procedures.
- **Appendix: CPU features**
The Appendix describes the CPU features and technologies that the motherboard supports.

Where to find more information

Refer to the following sources for additional information and for product and software updates.

1. **ASUS websites**
The ASUS website provides updated information on ASUS hardware and software products. Refer to the ASUS contact information.
2. **Optional documentation**
Your product package may include optional documentation, such as warranty flyers, that may have been added by your dealer. These documents are not part of the standard package.

Conventions used in this guide

To make sure that you perform certain tasks properly, take note of the following symbols used throughout this manual.



DANGER/WARNING: Information to prevent injury to yourself when trying to complete a task.



CAUTION: Information to prevent damage to the components when trying to complete a task.



IMPORTANT: Instructions that you **MUST** follow to complete a task.



NOTE: Tips and additional information to help you complete a task.

Typography

Bold text

Indicates a menu or an item to select.

Italics

Used to emphasize a word or a phrase.

<Key>

Keys enclosed in the less-than and greater-than sign means that you must press the enclosed key.

Example: <Enter> means that you must press the Enter or Return key.

<Key1+Key2+Key3>

If you must press two or more keys simultaneously, the key names are linked with a plus sign (+).

Example: <Ctrl+Alt+D>

Command

Means that you must type the command exactly as shown, then supply the required item or value enclosed in brackets.

Example: At the DOS prompt, type the command line:

```
afudos /i [filename]
```

```
afudos /iP5E3D.ROM
```

P5E3 Deluxe

specifications summary

CPU	LGA775 socket for Intel® Core™2 Quad / Core™2 Extreme / Core™2 Duo / Pentium® Extreme / Pentium® D / Pentium® 4 Processors Compatible with Intel® 05B/05A/06 processors Intel® next generation 45nm Multi-Core CPU * Refer to www.asus.com for Intel CPU support list
Chipset	Intel® X38 / ICH9R with Intel® Fast Memory Access Technology
System Bus	1600 / 1333 / 1066 / 800 MHz
Memory	4 x DIMM, max. 8GB, DDR3 1800 (O.C) / 1600 (O.C) / 1333 / 1066 / 800 MHz, ECC, un-buffered memory Dual channel memory architecture * Refer to www.asus.com for the Memory QVL (Qualified Vendors Lists).
Expansion Slots	3 x PCIe x16 supports CrossFire Technology (blue @ PCIe2.0 x16 mode, black @ PCIe x4 or x1 mode) 2 x PCIe x1 2 x PCI
Storage	Intel® ICH9R Southbridge <ul style="list-style-type: none"> - 6 x SATA 3.0 Gb/s ports - Intel® Matrix Storage, supporting SATA RAID 0, 1, 5 and 10 JMicron® JMB363 SATA/PATA controller <ul style="list-style-type: none"> - 1 x UltraDMA 133/100 for up to 2 PATA devices - 2 x External SATA 3 Gb/s ports (SATA On-the-Go) - Supports SATA RAID 0, 1, JBOD
LAN	Dual Gigabit LAN controllers, featuring AI NET2 Marvell® 88E8056 PCI-E Gigabit LAN controller Realtek® RTL8110SC PCI Gigabit LAN controller
Audio	ADI® AD1988B 8-channel High Definition Audio CODEC <ul style="list-style-type: none"> - Supports Jack-Sensing, Enumeration, Multi-streaming technology - Coaxial / Optical S/PDIF out ports at back I/O - ASUS AI Audio 2 - ASUS Noise Filter
IEEE 1394	Agere® L-FW3227 1394a controller supports 2 x IEEE 1394a ports (one at midboard; one at back panel)
USB	12 x USB 2.0 ports (6 ports at mid-board, 6 ports at back panel)

(continued on the next page)

P5E3 Deluxe

specifications summary

<p>ASUS AI Lifestyle Unique features</p>	<p>ASUS Power Saving Solution:</p> <ul style="list-style-type: none"> - ASUS EPU (Energy Processing Unit) - ASUS AI Gear 3+ (ASUS EPU Utility) - ASUS AI Nap <p>ASUS AI Life Features:</p> <ul style="list-style-type: none"> - ASUS AI Direct Link <p>ASUS Quiet Thermal Solution:</p> <ul style="list-style-type: none"> - ASUS 8-Phase Power Design - ASUS Fanless Design: Heat-pipe solution - ASUS Fanless Design: StackCool 2 - ASUS Q-Fan 2 - ASUS Optional Fan for Water-cooling or Passive-Cooling only <p>ASUS EZ DIY:</p> <ul style="list-style-type: none"> - ASUS Q-Shield - ASUS Q-Connector - ASUS O.C. Profile - ASUS CrashFree BIOS 3 - ASUS EZ Flash 2 - ASUS AI Slot Detector
<p>ASUS Stylish Features</p>	<p>ASUS MyLogo3™ Multi-language BIOS</p>
<p>ASUS Exclusive Overclocking Features</p>	<p>ASUS AI Booster utility</p> <p>Precision Tweaker 2:</p> <ul style="list-style-type: none"> - vCore: Adjustable CPU voltage at 0.0625V increment - vDIMM: 64-step DRAM voltage control - vChipset (N.B.): 33-step chipset voltage control - vFSB Termination: 15-step reference voltage control - vCPU PLL: 64-step CPU PLL voltage control <p>SFS (Stepless Frequency Selection)</p> <ul style="list-style-type: none"> - FSB tuning from 200MHz up to 800MHz at 1MHz increment - Memory tuning from 800MHz up to 3200MHz - PCI Express frequency tuning from 100MHz up to 150MHz at 1MHz increment <p>Overclocking Protection:</p> <ul style="list-style-type: none"> - ASUS C.P.R.(CPU Parameter Recall)

(continued on the next page)

P5E3 Deluxe

specifications summary

Back Panel I/O Ports	<ul style="list-style-type: none"> 1 x PS/2 Keyboard 1 x S/PDIF Out (Coaxial + Optical) 2 x External SATA 1 x IEEE1394a 2 x RJ45 ports 6 x USB 2.0/1.1 8-channel Audio I/O
Internal I/O Connectors	<ul style="list-style-type: none"> 3 x USB connectors support additional 6 USB ports 1 x Floppy disk drive connector 1 x COM connector 1 x IDE connector 6 x SATA connectors 1 x CPU Fan connector 4 x Chassis Fan connectors 1 x Power Fan connector 1 x IEEE1394a connector Front panel audio connector 1 x S/PDIF Out Header Chassis Intrusion connector CD audio in 24-pin ATX Power connector 2 x 4-pin ATX 12V Power connectors System Panel (Q-Connector)
BIOS Features	<ul style="list-style-type: none"> 16 Mb Flash ROM, AMI BIOS, PnP, DMI 2.0, WfM 2.0, SM BIOS 2.3, ACPI 2.0a, Multi-language BIOS, ASUS EZ Flash 2, ASUS CrashFree BIOS 3
Manageability	<ul style="list-style-type: none"> WfM 2.0, DMI 2.0, WOL by PME, WOR by PME, PXE
Support CD Contents	<ul style="list-style-type: none"> Drivers ASUS PC Probe II ASUS Update ASUS AI Suite Image-Editing Suite Anti-virus software (<i>OEM version</i>)
Form Factor	<ul style="list-style-type: none"> ATX Form Factor, 12"x 9.6" (30.5cm x 24.4cm)

*Specifications are subject to change without notice.

This chapter describes the motherboard features and the new technologies it supports.

1 Product introduction

Chapter summary

1

1.1	Welcome!	1-1
1.2	Package contents.....	1-1
1.3	Special features.....	1-2

1.1 Welcome!

Thank you for buying an ASUS® P5E3 Deluxe motherboard!

The motherboard delivers a host of new features and latest technologies, making it another standout in the long line of ASUS quality motherboards!

Before you start installing the motherboard, and hardware devices on it, check the items in your package with the list below.

1.2 Package contents

Check your motherboard package for the following items.

Motherboard	ASUS P5E3 Deluxe
I/O modules	1 x Multi-function module (1-port IEEE 1394a module and 2-port USB 2.0 module)
Cables	1 x Serial ATA power cable for 2 devices 6 x Serial ATA signal cables 1 x Ultra DMA 133/100 cable 1 x Floppy disk drive cable
Accessories	ASUS Q-Shield (I/O shield) 2 x ASUS Optional Fans for Water-Cooling or Passive-Cooling only 1 x ASUS Q-Connector Kit (USB, 1394, system panel; Retail version only)
Application DVD	ASUS motherboard support DVD
Documentation	User guide



If any of the above items is damaged or missing, contact your retailer.

1.3 Special features

1.3.1 Product highlights

Green ASUS



This motherboard and its packaging comply with the European Union's Restriction on the use of Hazardous Substances (RoHS). This is in line with the ASUS vision of creating environment-friendly and recyclable products/packagings to safeguard consumers' health while minimizing the impact on the environment.

Intel® Core™ 2 Quad Processor Ready



This motherboard supports the latest Intel® Core™ 2 Quad processors in the LGA775 package. It is excellent for multi-tasking, multi-media and enthusiastic gamers with 1066 / 800 MHz FSB. The Intel® Core™ 2 Quad processor is one of the most powerful CPUs in the world. This motherboard also supports Intel® CPUs in the new 45 nm manufacturing process.

Intel® Core™ 2 Duo / Extreme CPU support



This motherboard supports the latest Intel® Core™ 2 processor in the LGA775 package. With the new Intel® Core™ microarchitecture technology and 1600 / 1333/ 1066 / 800 MHz FSB, the Intel® Core™ 2 is one of the most powerful and energy efficient CPUs in the world.

Intel X38 Chipset



The Intel® X38 Express Chipset is the latest chipset designed to support 8GB of dual-channel DDR3 1333/1066/800 MHz memory architecture, 1333/1066/800 FSB (Front Side Bus), dual PCI Express 2.0 x16 graphics and multi-core CPUs. It especially includes Intel® Fast Memory Access technology that significantly optimizes the use of available memory bandwidth and reduces the latency of the memory accesses.

DDR3 memory support



The motherboard supports DDR3 memory that features data transfer rates of 1800 (O.C.) / 1600 (O.C.) / 1333 /1066 / 800 MHz to meet the higher bandwidth requirements of the latest 3D graphics, multimedia, and Internet applications. The dual-channel DDR3 architecture doubles the bandwidth of your system memory to boost system performance. Furthermore, this motherboard does not restrict the memory size across two channels. Users may install different memory size DIMMs into the two channels and enjoy dual-channel and single-channel functions at the same time. This new feature optimizes the use of available memory size. See page 2-13 for details.

PCIe 2.0

This motherboard supports the latest PCIe 2.0 device for twice the current speed and bandwidth. This enhances system performance while still providing backward compatibility to PCIe 1.0 devices.

Serial ATA 3 Gb/s technology and SATA-On-The-Go

This motherboard supports hard drives based on the Serial ATA (SATA) 3 Gb/s storage specification, delivering enhanced scalability and doubling the bus bandwidth for high-speed data retrieval and saves. The external SATA port located at the back I/O provides smart setup and hot-plug functions. Easily backup photos, videos and other entertainment contents to external devices. See pages 2-24 and 2-28 for details.

Dual RAID solution

The Intel® X38 chipset incorporates six Serial ATA connectors with high performance RAID 0, 1, 5, and 10 functions, and the JMicron controller provides another two external Serial ATA connectors for RAID 0, 1, and JBOD functions, making this motherboard an ideal solution to enhance hard disk performance and data back up protection without the cost of add-on cards. See pages 2-24 and 2-28 for details.

IEEE 1394a support

The IEEE 1394a interface provides high speed digital interface for audio/video appliances such as digital television, digital video camcorders, storage peripherals & other PC portable devices. See pages 2-23 and 2-30 for details.

S/PDIF digital sound ready

This motherboard provides convenient connectivity to external home theater audio systems via coaxial and optical S/PDIF-out (SONY-PHILIPS Digital Interface) jacks. It allows to transfer digital audio without converting to analog format and keeps the best signal quality. See page 2-23 and 2-25 for details.

Dual Gigabit LAN solution

The integrated dual Gigabit LAN design allows a PC to serve as a network gateway for managing traffic between two separate networks. This capability ensures rapid transfer of data from WAN to LAN without any added arbitration or latency. See page 2-23 for details.

High Definition Audio



Enjoy high-end sound quality on your PC! The onboard 8-channel HD audio (High Definition Audio, previously codenamed Azalia) CODEC enables high-quality 192KHz/24-bit audio output that simultaneously sends different audio streams to different destinations. You can now talk to your partners on the headphone while playing multi-channel network games. See pages 2-23 and 2-24 for details.

1.3.2 ASUS AI Lifestyle unique features



ASUS Power Saving Solution

ASUS Power Saving solution intelligently and automatically provides balanced computing power and energy consumption.

ASUS EPU



The ASUS EPU utilizes innovative technology to digitally monitor and tune the CPU power supply with improved VR responses in heavy or light loadings. It automatically provides power for higher performance or improve efficiency by 50% when the PC is running low intensity applications. Working together with AI Gear 3+, this can help you attain the best possible power efficiency and energy savings up to 80.23% to help save the environment. See page 5-20 for details.

AI Nap



With AI Nap, the system can continue running at minimum power and noise when you are temporarily away. To wake the system and return to the OS environment, simply click the mouse or press a key. See page 5-21 for details.

ASUS Quiet Thermal Solution

ASUS Quiet Thermal solution makes system more stable and enhances the overclocking capability.

ASUS 3rd Generation 8-Phase Power Design



Longer life & higher efficiency! With power efficiency so important to operating temperature, ASUS' 3rd generation 8-phase VRM design leads the industry with its 95% power efficiency. High quality power components such as low RDS (on) MOSFETs for minimum switching loss & lower temperature, Ferrite core chokes with lower hysteresis loss, and high quality Japanese-made conductive polymer capacitors all add up to ensure longer component life and lower power loss -- creating more energy efficiency.

Fanless Design - Stack Cool 2



ASUS Stack Cool 2 is a fan-less and zero-noise cooling solution that lowers the temperature of critical heat generating components. The motherboard uses a special design on the printed circuit board (PCB) to dissipate heat these critical components generate.

Fanless Design - Pure Copper Heat-pipe



The Heat Pipe design effectively directs the heat generated by the chipsets to the heatsink near the back IO ports, where it can be carried away by existing airflow from CPU fan or bundled optional fan. The purpose of the innovative heat pipe design on this motherboard is that the groundbreaking fanless design does not have lifetime problems as a chipset fan does. Furthermore, it provides options for users to install side-flow fan or passive cooler. The Heat Pipe design is the most reliable fanless thermal solution to date.



DO NOT uninstall the heat-pipe by yourself. Doing so may bend the tubing and affect the heat dissipation performance.

Optional Fan (for Water-Cooling or Passive-Cooling only)



The optional fan is specifically designed to provide sufficient airflow over the CPU power modules and chipset area when water-cooling or passive-cooling is utilized, ensuring effective heat dissipation for the entire system. See page 2-38 and 2-39 for details.

Q-Fan 2



ASUS Q-Fan2 technology intelligently adjusts both CPU fan and chassis fan speeds according to system loading to ensure quiet, cool and efficient operation. See page 4-32 and 5-22 for details.

ASUS Crystal Sound

This feature can enhance speech-centric applications like Skype, online game, video conference and recording.

ASUS AI Audio 2



AI Audio 2 creates a virtual center channel that expands the overall sound field without introducing a picket fencing effect. Preserving the dialogue or solo performances with downmixing from multichannels will allow you to experience true-to-life high quality audio. See page 5-26 for details.

Noise Filter



This feature detects repetitive and stationary noises (non-voice signals) like computer fans, air conditioners, and other background noises then eliminates it in the incoming audio stream while recording. See page 5-29 and 5-34 for details.

ASUS EZ DIY

ASUS EZ DIY feature collection provides you easy ways to install computer components, update the BIOS or back up your favorite settings.

ASUS AI Direct Link



AI Direct Link can easily and efficiently transfer large amounts of data via the network cable - saving up to 70% of the total time taken. With AI Direct Link, it becomes easy to backup or share large data files like movies or other media content. See page 5-24 for details.

ASUS Q-Shield



The specially designed ASUS Q-Shield does without the usual “fingers” -- making it convenient and easy to install. With better electric conductivity, it ideally protects your motherboard against static electricity and shields it against Electronic Magnetic Interference (EMI).

ASUS Q-Connector



ASUS Q-Connector allows you to easily connect or disconnect the chassis front panel cables to the motherboard. This unique module eliminates the trouble of connecting the system panel cables one at a time and avoiding wrong cable connections. See page 2-37 for details.

ASUS O.C. Profile



The motherboard features the ASUS O.C. Profile that allows users to conveniently store or load multiple BIOS settings. The BIOS settings can be stored in the CMOS or a separate file, giving users freedom to share and distribute their favorite settings. See page 4-38 for details.

ASUS CrashFree BIOS 3



The ASUS CrashFree BIOS 3 allows users to restore corrupted BIOS data from a USB flash disk containing the BIOS file. See page 4-7 for details.

ASUS EZ Flash 2



EZ Flash 2 is a user-friendly BIOS update utility. Simply press the predefined hotkey to launch the utility and update the BIOS without entering the OS. Update your BIOS easily without preparing a bootable diskette or using an OS-based flash utility. See pages 4-4 and 4-37 for details.

ASUS AI Slot Detector



When PCIe/PCI devices are installed, you can find out if they are installed successfully via ASUS's innovatively designed on-board LEDs when they switch on the power. This provides an efficient way to identify the correct way to set up without entering the operating system. See page 2-21 for details.

ASUS MyLogo3™



This feature allows you to convert your favorite photo into a 256-color boot logo for a more colorful and vivid image on your screen. See page 4-34 and 5-9 for details.

ASUS Multi-language BIOS



The multi-language BIOS allows you to select the language of your choice from the available options. The localized BIOS setup menu helps you configure your system easier and faster. See page 4-11 for details.

1.3.3 ASUS Intelligent Performance and Overclocking features

AI Booster

The ASUS AI Booster allows you to overclock the CPU speed in Windows environment without the hassle of booting the BIOS.

Precision Tweaker 2



Allows the user to adjust the NB Voltage, FSB termination Voltage, CPU PLL Voltage and the DRAM Voltage in 0.02v steps to finetune voltages to achieve the most precise setting for the ultimate customized overclocking configuration. See page 4-21 for details.

C.P.R. (CPU Parameter Recall)



The C.P.R. feature of the motherboard BIOS allows automatic re-setting to the BIOS default settings in case the system hangs due to overclocking. When the system hangs due to overclocking, C.P.R. eliminates the need to open the system chassis and clear the RTC data. Simply shut down and reboot the system, and the BIOS automatically restores the CPU default setting for each parameter.

This chapter lists the hardware setup procedures that you have to perform when installing system components. It includes description of the jumpers and connectors on the motherboard.

Hardware information

A large, light gray, stylized number '2' is positioned behind the word 'Hardware' in the title.

2.1	Before you proceed	2-1
2.2	Motherboard overview.....	2-2
2.3	Central Processing Unit (CPU)	2-6
2.4	System memory	2-13
2.5	Expansion slots.....	2-18
2.6	Jumper	2-22
2.7	Connectors	2-23

2.1 Before you proceed

Take note of the following precautions before you install motherboard components or change any motherboard settings.



- Unplug the power cord from the wall socket before touching any component.
- Use a grounded wrist strap or touch a safely grounded object or a metal object, such as the power supply case, before handling components to avoid damaging them due to static electricity.
- Hold components by the edges to avoid touching the ICs on them.
- Whenever you uninstall any component, place it on a grounded antistatic pad or in the bag that came with the component.
- Before you install or remove any component, ensure that the ATX power supply is switched off or the power cord is detached from the power supply. Failure to do so may cause severe damage to the motherboard, peripherals, and/or components.

Onboard LED

The motherboard comes with a standby power LED. The green LED lights up to indicate that the system is ON, in sleep mode, or in soft-off mode. This is a reminder that you should shut down the system and unplug the power cable before removing or plugging in any motherboard component. The illustration below shows the location of the onboard LED.

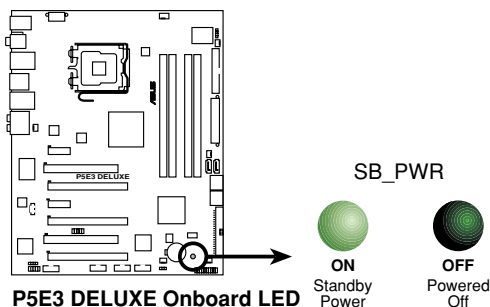

2.2 Motherboard overview

Before you install the motherboard, study the configuration of your chassis to ensure that the motherboard fits into it.



Make sure to unplug the power cord before installing or removing the motherboard. Failure to do so can cause you physical injury and damage motherboard components.

2.2.1 Placement direction

When installing the motherboard, make sure that you place it into the chassis in the correct orientation. The edge with external ports goes to the rear part of the chassis as indicated in the image below.

2.2.2 Screw holes

Place nine (9) screws into the holes indicated by circles to secure the motherboard to the chassis.



DO NOT overtighten the screws! Doing so can damage the motherboard.

Place this side towards
the rear of the chassis

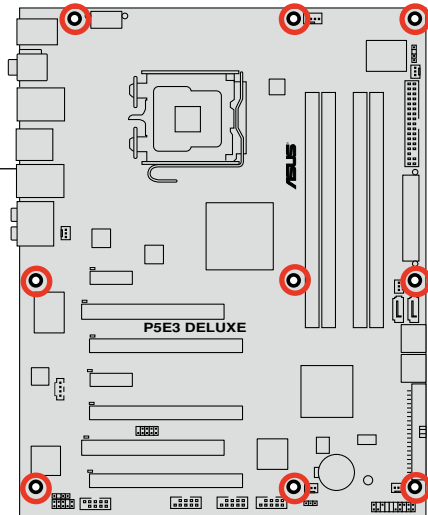

2.2.3 Motherboard layout

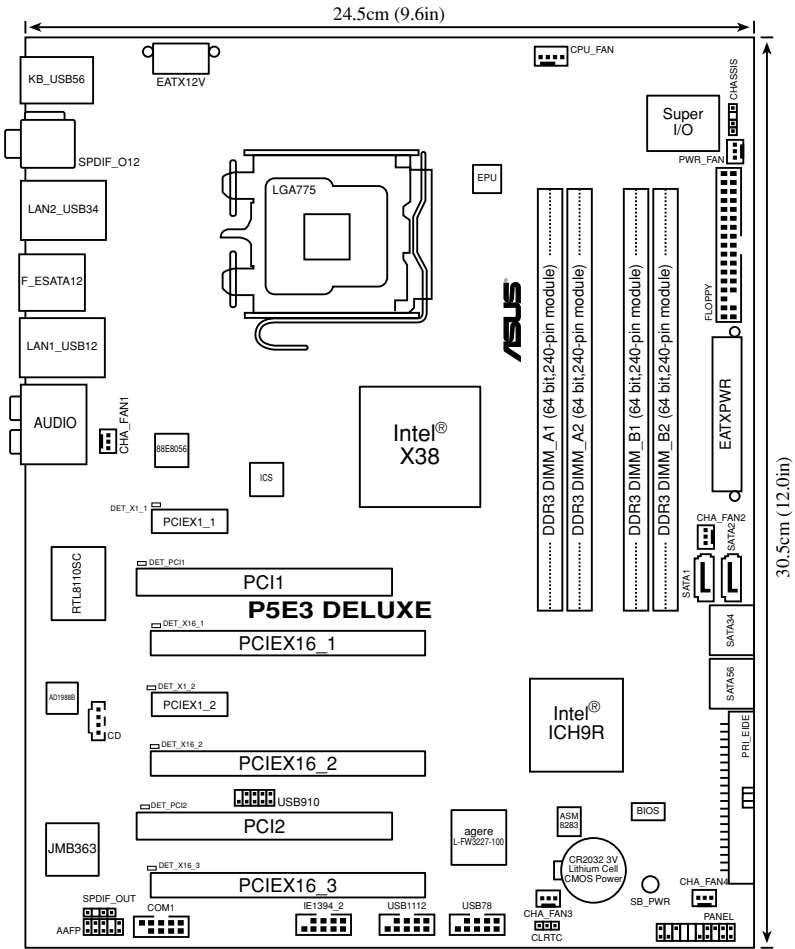

Refer to **2.7 Connectors** for more information about rear panel connectors and internal connectors.

2.2.4 Layout contents

Slots		Page
1.	DDR3 DIMM slots	2-13
2.	PCI slots	2-20
3.	PCI Express x 1 slots	2-20
4.	PCI Express x16 slots	2-20

Jumper		Page
1.	Clear RTC RAM (3-pin CLRRTC)	2-22

Rear panel connectors		Page
1.	PS/2 keyboard port (purple)	2-23
2.	Coaxial S/PDIF Out port	2-23
3.	LAN 1 (RJ-45) port	2-23
4.	IEEE 1394a port	2-23
5.	LAN 2 (RJ-45) port	2-23
6.	Center/Subwoofer port (orange)	2-23
7.	Rear Speaker Out port (black)	2-23
8.	Line In port (light blue)	2-23
9.	Line Out port (lime)	2-23
10.	Microphone port (pink)	2-24
11.	Side Speaker Out port (gray)	2-24
12.	USB 2.0 ports 1 and 2	2-24
13.	External SATA port 1/2	2-24
14.	USB 2.0 ports 3 and 4	2-25
15.	Optical S/PDIF Out port	2-25
16.	USB 2.0 ports 5 and 6	2-25

Internal connectors		Page
1.	Floppy disk drive connector (34-1 pin FLOPPY)	2-26
2.	IDE connector (40-1 pin PRI_EIDE)	2-27
3.	ICH9R Serial ATA connectors (7-pin SATA1-6)	2-28
4.	USB connectors (10-1 pin USB78, USB910, USB1112)	2-29
5.	IEEE 1394a port connector (10-1 pin IE1394_2)	2-30
6.	CPU, chassis and power fan connectors (4-pin CPU_FAN, 3-pin CHA_FAN1-4, 3-pin PWR_FAN)	2-31
7.	Chassis intrusion connector (4-1 pin CHASSIS)	2-32
8.	ATX power connectors (24-pin EATXPWR, 2x4-pin EATX12V)	2-33
9.	Front panel audio connector (10-1 pin AAFP)	2-34
10.	Optical drive audio connector (4-pin CD)	2-35
11.	Digital audio connector (4-1 pin SPDIF, for ASUS HDMI card)	2-35
12.	System panel connector (20-8 pin PANEL)	2-36
13.	ASUS Q-Connector (system panel)	2-37

2.3 Central Processing Unit (CPU)

The motherboard comes with a surface mount LGA775 socket designed for the Intel® Core™2 Quad / Core™2 Extreme / Core™2 Duo / Pentium® Extreme / Pentium® D / Pentium® 4 Processors.



-
- Make sure that all power cables are unplugged before installing the CPU.
 - If installing a dual-core CPU, connect the chassis fan cable to the CHA_FAN1 connector to ensure system stability.
 - Due to the chipset limitation, we recommend you use FSB 800MHz CPU or above.
-



-
- Upon purchase of the motherboard, make sure that the PnP cap is on the socket and the socket contacts are not bent. Contact your retailer immediately if the PnP cap is missing, or if you see any damage to the PnP cap/socket contacts/motherboard components. ASUS will shoulder the cost of repair only if the damage is shipment/transit-related.
 - Keep the cap after installing the motherboard. ASUS will process Return Merchandise Authorization (RMA) requests only if the motherboard comes with the cap on the LGA775 socket.
 - The product warranty does not cover damage to the socket contacts resulting from incorrect CPU installation/removal, or misplacement/loss/incorrect removal of the PnP cap.
-

2.3.1 Installing the CPU

To install a CPU:

1. Locate the CPU socket on the motherboard.

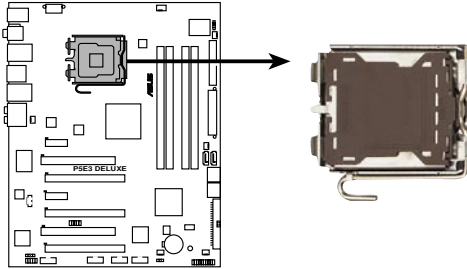

P5E3 DELUXE CPU Socket 775



Before installing the CPU, make sure that the cam box is facing towards you and the load lever is on your left.

2. Press the load lever with your thumb (A), then move it to the left (B) until it is released from the retention tab.

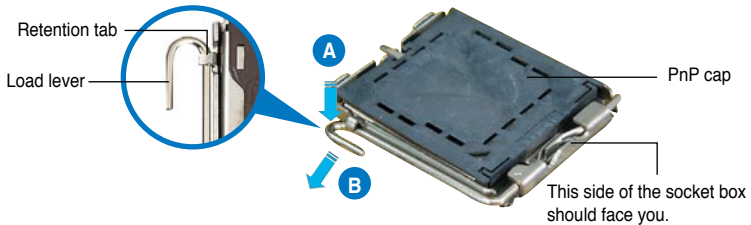

To prevent damage to the socket pins, do not remove the PnP cap unless you are installing a CPU.

3. Lift the load lever in the direction of the arrow to a 135° angle.

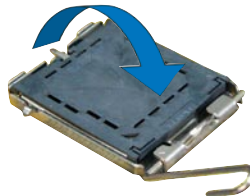

- Lift the load plate with your thumb and forefinger to a 100° angle (A), then push the PnP cap from the load plate window to remove (B).

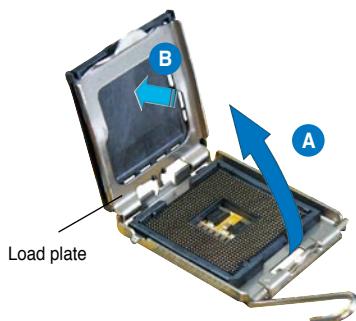

- Position the CPU over the socket, making sure that the gold triangle is on the bottom-left corner of the socket then fit the socket alignment key into the CPU notch.

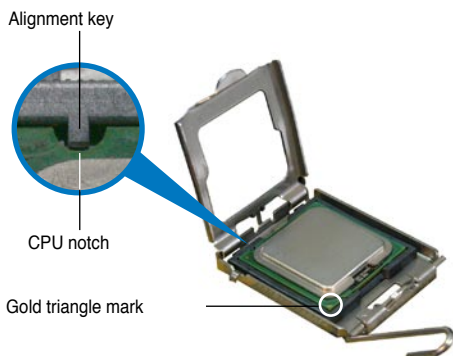

The CPU fits in only one correct orientation. DO NOT force the CPU into the socket to prevent bending the connectors on the socket and damaging the CPU!

- Close the load plate (A), then push the load lever (B) until it snaps into the retention tab.
- If installing a dual-core CPU, connect the chassis fan cable to the CHA_FAN1 connector to ensure system stability.

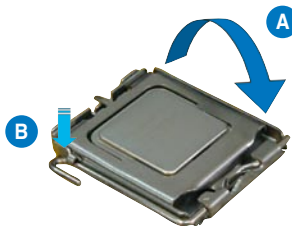

The motherboard supports Intel® LGA775 processors with the Intel® Enhanced Memory 64 Technology (EM64T), Enhanced Intel SpeedStep® Technology (EIST), and Hyper-Threading Technology. Refer to the Appendix for more information on these CPU features.

2.3.2 Installing the CPU heatsink and fan

The Intel® LGA775 processor requires a specially designed heatsink and fan assembly to ensure optimum thermal condition and performance.



- When you buy a boxed Intel® processor, the package includes the CPU fan and heatsink assembly. If you buy a CPU separately, make sure that you use only Intel®-certified multi-directional heatsink and fan.
- Your Intel® LGA775 heatsink and fan assembly comes in a push-pin design and requires no tool to install.
- If you purchased a separate CPU heatsink and fan assembly, make sure that you have properly applied Thermal Interface Material to the CPU heatsink or CPU before you install the heatsink and fan assembly.



Make sure that you have installed the motherboard to the chassis before you install the CPU fan and heatsink assembly.

To install the CPU heatsink and fan:

1. Place the heatsink on top of the installed CPU, making sure that the four fasteners match the holes on the motherboard.



Orient the heatsink and fan assembly such that the CPU fan cable is closest to the CPU fan connector.

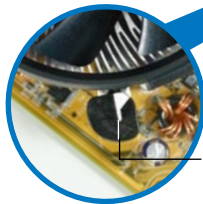

Narrow end
of the groove

Motherboard hole
Fastener



Make sure to orient each fastener with the narrow end of the groove pointing outward. (The photo shows the groove shaded for emphasis.)

2. Push down two fasteners at a time in a diagonal sequence to secure the heatsink and fan assembly in place.

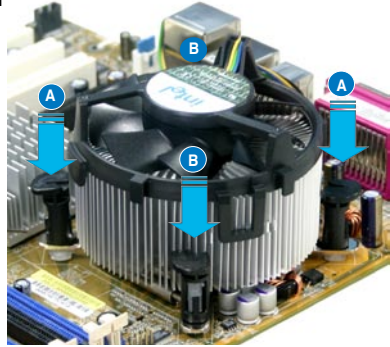
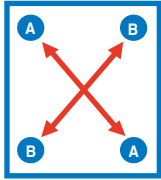

3. Connect the CPU fan cable to the connector on the motherboard labeled CPU_FAN.

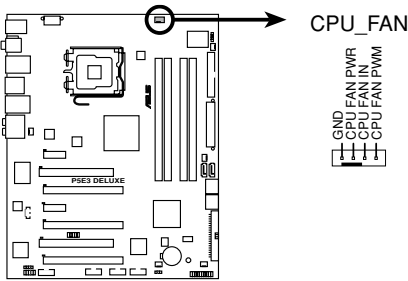

P5E3 DELUXE CPU fan connector



DO NOT forget to connect the CPU fan connector! Hardware monitoring errors can occur if you fail to plug this connector.

2.3.3 Uninstalling the CPU heatsink and fan

To uninstall the CPU heatsink and fan:

1. Disconnect the CPU fan cable from the connector on the motherboard.
2. Rotate each fastener counterclockwise.



3. Pull up two fasteners at a time in a diagonal sequence to disengage the heatsink and fan assembly from the motherboard.

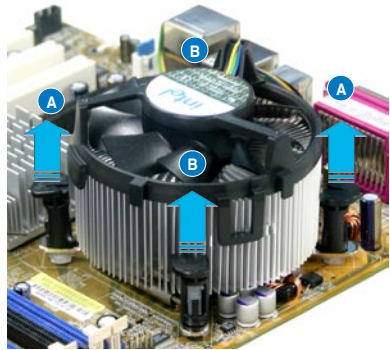
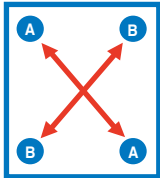

4. Carefully remove the heatsink and fan assembly from the motherboard.



- 5. Rotate each fastener clockwise to ensure correct orientation when reinstalling.

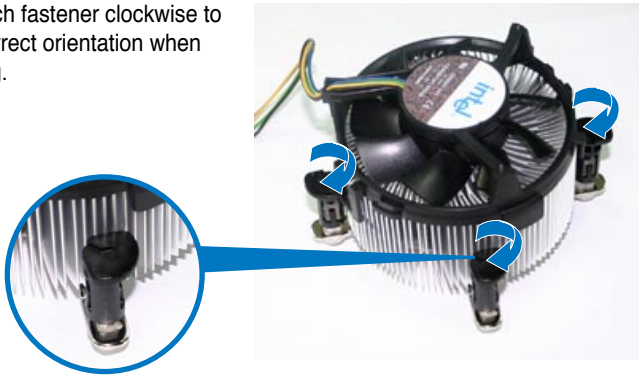

The narrow end of the groove should point outward after resetting. (The photo shows the groove shaded for emphasis.)

Narrow end of the groove



Refer to the documentation in the boxed or stand-alone CPU fan package for detailed information on CPU fan installation.

2.4 System memory

2.4.1 Overview

The motherboard comes with four Double Data Rate 3 (DDR3) Dual Inline Memory Modules (DIMM) sockets.

A DDR3 module has the same physical dimensions as a DDR2 DIMM but is notched differently to prevent installation on a DDR2 DIMM socket. DDR3 modules are developed for better performance with less power consumption.

The figure illustrates the location of the DDR3 DIMM sockets:

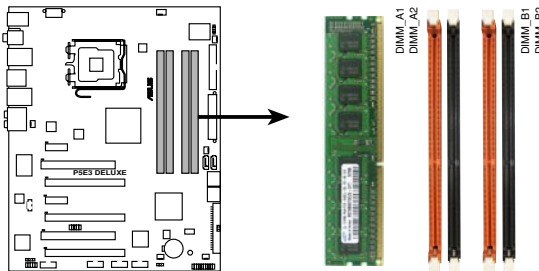

P5E3 DELUXE 240-pin DDR3 DIMM sockets

Channel	Sockets
Channel A	DIMM_A1 and DIMM_A2
Channel B	DIMM_B1 and DIMM_B2

2.4.2 Memory configurations

You may install 512 MB, 1 GB, and 2 GB unbuffered ECC, non-ECC DDR3 DIMMs into the DIMM sockets.

Recommend memory configuration

Mode	Sockets			
	DIMM_A1	DIMM_B1	DIMM_A2	DIMM_B2
Single-channel	-	-	-	populated
	-	-	populated	-
Dual-channel (1)	populated	populated	-	-
Dual-channel (2)	populated	populated	populated	populated



- You may install varying memory sizes in Channel A and Channel B. The system maps the total size of the lower-sized channel for the dual-channel configuration. Any excess memory from the higher-sized channel is then mapped for single-channel operation.
- Always install DIMMs with the same CAS latency. For optimum compatibility, it is recommended that you obtain memory modules from the same vendor.
- Due to chipset resource allocation, the system may detect less than 8 GB system memory when you installed four 2 GB DDR3 memory modules.



- If you install four 1 GB memory modules, the system may detect less than 3 GB of total memory because of address space allocation for other critical functions. This limitation applies to Windows Vista 32-bit/Windows XP 32-bit version operating system since it does not support PAE (Physical Address Extension) mode.
- If you install Windows Vista 32-bit/Windows XP 32-bit version operating system, we recommend that you install less than 3GB of total memory.

Notes on memory limitations

- Due to chipset limitation, this motherboard can only support up to 8 GB on the operating systems listed below. You may install a maximum of 2 GB DIMMs on each slot.

64-bit
Windows XP Professional x64 Edition
Windows Vista x64 Edition

P5E3 Deluxe Motherboard Qualified Vendors Lists (QVL) DDR3-1800MHz capability

Size	Vendor	Model	CL	Chip Brand	SS/ DS	Component	DIMM socket support (Optional)		
							A*	B*	C*
1GB	CORSAIR	TWIN3X2048-1800C7DF G	7	Micon	SS	Heatsink	•	•	
1GB	OCZ	OCZ3P18002GK	8	Micon	SS	Heatsink	•	•	

P5E3 Deluxe Motherboard Qualified Vendors Lists (QVL) DDR3-1600MHz capability

Size	Vendor	Chip No.	CL	Chip Brand	SS/ DS	Component	DIMM socket support (Optional)		
							A*	B*	C*
1GB	CORSAIR	CM3X1024-1600C7DHXIN	7	Micon	SS	Heatsink	•	•	
1GB	OCZ	OCZ3P16002GK	7	Micon	SS	Heatsink	•	•	
1GB	A-DATA	DDR3-1600X	7	Micon	SS	Heatsink	•	•	
1GB	SuperTalent	W1600X2G7	7	Micon	SS	Heatsink	•	•	

P5E3 Deluxe Motherboard Qualified Vendors Lists (QVL) DDR3-1333MHz capability

Size	Vendor	Chip No.	CL	Chip Brand	SS/ DS	Part No.	DIMM socket support (Optional)		
							A*	B*	C*
512MB	ELPIDA	J5308BASE-DG-E	8	ELPIDA	SS	EBJ51UD8BAFA-DG-E	•	•	•
1GB	SAMSUNG	K4B1G0846C-ZCF8	8	SAMSUNG	SS	M378B2873CZO-CG9	•	•	
1GB	OCZ	Heat-Sink Package	7-7-7-20	N/A	DS	OCZ3P13332GK	•	•	•

P5E3 Deluxe Motherboard Qualified Vendors Lists (QVL) DDR3-1066MHz capability

Size	Vendor	Chip No.	CL	Chip Brand	SS/ DS	Part No.	DIMM socket support (Optional)		
							A*	B*	C*
512MB	Qimonda	IDSH51-03A1F1C-10F	N/A	QIMONDA	SS	IMSH51U03A1F1C-10F	•	•	•
1GB	Qimonda	IDSH51-03A1F1C-10F	N/A	QIMONDA	DS	IMSH1GU13A1F1C-10F	•	•	
512MB	ELPIDA	J5308BASE-AC-E	8	ELPIDA	SS	EBJ51UD8BAFA-AG-E	•	•	•
1GB	ELPIDA	J5308BASE-AC-E	8	ELPIDA	DS	EBJ11UD8BAFA-AG-E	•	•	
512MB	NANYA	NT5CB64M8AN-BE	N/A	NANYA	SS	NT512C64B88A0NY-BF	•	•	•
1GB	MICRON	D9GTR	7	MICRON	SS	MT8JTF12864AY-1G1BZES	•	•	
2GB	MICRON	Z9HWQ	7	MICRON	DS	MT16JTF25664AY-1G1BYES	•	•	
1GB	SAMSUNG	K4B1G0846C-ZCF8	7-7-7	SAMSUNG	SS	M378B2873CZO-CF8	•	•	
1GB	SAMSUNG	K4B1G0846C-ZCG8	8	SAMSUNG	SS	M378B2873CZO-CG8	•	•	
2GB	SAMSUNG	K4B1G0846C-ZCF8	7	SAMSUNG	DS	M378B5673CZO-CF8	•	•	
1GB	SAMSUNG	K4B1G0846C-ZCF8	7	SAMSUNG	SS	M391B2873CZO-CF8	•	•	•
512MB	Kingston	IDSH51-03A1F1C-10F	N/A	QIMONDA	SS	KVR1066D3N7/512	•	•	•
1GB	Kingston	J5308BASE-AC-E	7	ELPIDA	DS	KVR1066D3N7/1G	•	•	
512MB	Kingston	J5308BASE-AC-E	7	ELPIDA	SS	KVR1066D3N7/512	•	•	•
1GB	CORSAIR	Heat-Sink Package	7	N/A	DS	CM3X1024-1066C7	•	•	
1GB	Hynix	HY5TQ1G831ZNFP-G7	7	HYNIX	SS	HYMT112U64ZNF8-G7	•	•	
2GB	Hynix	HY5TQ1G831ZNFP-G7	7	HYNIX	DS	HYMT125U64ZNF8-G7	•	•	
512MB	GEIL	Heat-Sink Package	6	N/A	SS	G31GB1066C8DC	•	•	•
1GB	WINTEC	IDSH51-03A1F1C-10F	7	QIMONDA	DS	3DU3191A-10	•	•	•

P5E3 Deluxe Motherboard Qualified Vendors Lists (QVL) DDR3-800MHz capability

Size	Vendor	Chip No.	CL	Chip Brand	SS/ DS	Part No.	DIMM socket support (Optional)		
							A*	B*	C*
512MB	ELPIDA	J5308BASE-AC-E	6	ELPIDA	SS	EBJ51UD8BAFA-8C-E	•	•	•
1GB	ELPIDA	J5308BASE-AC-E	6	ELPIDA	DS	EBJ11UD8BAFA-8C-E	•	•	•
512MB	NANYA	NT5CB64M8AN-25D	N/A	NANYA	SS	NT512C64B88A0NY-25D	•	•	•
1GB	NANYA	NT5CB64M8AN-25D	N/A	NANYA	DS	NT1GC64B88HA0NY-25D	•	•	•
1GB	Qimonda	IDSH51-03A1F1C-08E	N/A	QIMONDA	DS	IMSH1GU13A1F1C-08E	•	•	•
512MB	Qimonda	IDSH51-03A1F1C-08D	N/A	Qimonda	SS	IMSH51U03A1F1C-08D	•	•	•
512MB	Qimonda	IDSH51-03A1F1C-08E	N/A	Qimonda	SS	IMSH51U03A1F1C-08E	•	•	•
1GB	Hynix	HY5TQ1G831ZNF-S6	N/A	Hynix	SS	HYMT112U64ZNF8-S6	•	•	•
2GB	Hynix	HY5TQ1G831ZNF-S5	N/A	Hynix	DS	HYMT125U64ZNF8-S5	•	•	•

SS - Single-sided DS - Double-sided

DIMM support:

- A - Supports one module inserted into either slot, in Single-channel memory configuration.
- B - Supports one pair of modules inserted into either Channel A or Channel B as one pair of Dual-channel memory configuration.
- C - Supports four modules inserted into the orange and black slots as two pairs of Dual-channel memory configuration.



Visit the ASUS website for the latest DDR3 QVL.

2.4.3 Installing a DIMM



Unplug the power supply before adding or removing DIMMs or other system components. Failure to do so can cause severe damage to both the motherboard and the components.

To install a DIMM:

1. Unlock a DIMM socket by pressing the retaining clips outward.
2. Align a DIMM on the socket such that the notch on the DIMM matches the break on the socket.
3. Firmly insert the DIMM into the socket until the retaining clips snap back in place and the DIMM is properly seated.

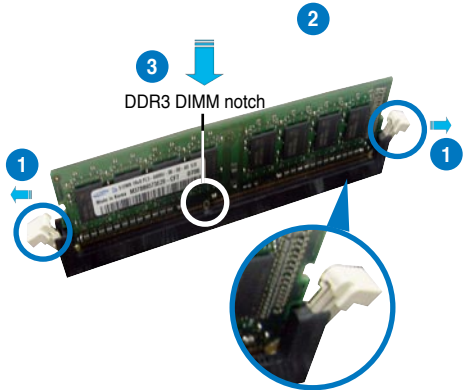

Unlocked retaining clip



- A DDR3 DIMM is keyed with a notch so that it fits in only one direction. DO NOT force a DIMM into a socket to avoid damaging the DIMM.
- The DDR3 DIMM sockets do not support DDR and DDR2 DIMMs. DO NOT install DDR or DDR2 DIMMs to the DDR3 DIMM sockets.

2.4.4 Removing a DIMM

To remove a DIMM:

1. Simultaneously press the retaining clips outward to unlock the DIMM.



Support the DIMM lightly with your fingers when pressing the retaining clips. The DIMM might get damaged when it flips out with extra force.

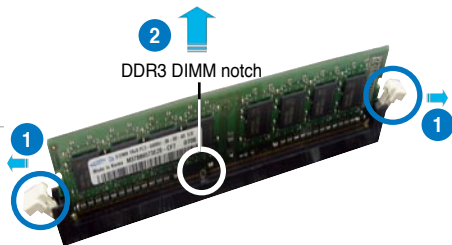

2. Remove the DIMM from the socket.

2.5 Expansion slots

In the future, you may need to install expansion cards. The following sub-sections describe the slots and the expansion cards that they support.



Make sure to unplug the power cord before adding or removing expansion cards. Failure to do so may cause you physical injury and damage motherboard components.

2.5.1 Installing an expansion card

To install an expansion card:

1. Before installing the expansion card, read the documentation that came with it and make the necessary hardware settings for the card.
2. Remove the system unit cover (if your motherboard is already installed in a chassis).
3. Remove the bracket opposite the slot that you intend to use. Keep the screw for later use.
4. Align the card connector with the slot and press firmly until the card is completely seated on the slot.
5. Secure the card to the chassis with the screw you removed earlier.
6. Replace the system cover.

2.5.2 Configuring an expansion card

After installing the expansion card, configure it by adjusting the software settings.

1. Turn on the system and change the necessary BIOS settings, if any. See Chapter 4 for information on BIOS setup.
2. Assign an IRQ to the card. Refer to the tables on the next page.
3. Install the software drivers for the expansion card.



When using PCI cards on shared slots, ensure that the drivers support “Share IRQ” or that the cards do not need IRQ assignments. Otherwise, conflicts will arise between the two PCI groups, making the system unstable and the card inoperable. Refer to the table on the next page for details.

2.5.3 Interrupt assignments

Standard interrupt assignments

IRQ	Priority	Standard Function
0	1	System Timer
1	2	Keyboard Controller
2	—	Re-direct to IRQ#9
3	9	IRQ holder for PCI steering*
4	12	Communications Port (COM1)*
5	13	IRQ holder for PCI steering*
6	14	Floppy Disk Controller
7	15	Printer Port (LPT1)*
8	3	System CMOS/Real Time Clock
9	4	IRQ holder for PCI steering*
10	5	IRQ holder for PCI steering*
11	6	IRQ holder for PCI steering*
12	7	PS/2 Compatible Mouse Port*
13	8	Numeric Data Processor
14	10	Primary IDE Channel
15	11	Secondary IDE Channel

* These IRQs are usually available for PCI devices.

IRQ assignments for this motherboard

	A	B	C	D	E	F	G	H
PCI slot 1	shared	—	—	—	—	—	—	—
PCI slot 2	—	shared	—	—	—	—	—	—
LAN(8110SC)	shared	—	—	—	—	—	—	—
SATA(363)	shared	—	—	—	—	—	—	—
LAN(8056)	—	shared	—	—	—	—	—	—
PCIe x16 1	shared	—	—	—	—	—	—	—
PCIe x16 2	shared	—	—	—	—	—	—	—
PCIe x16 3	—	—	shared	—	—	—	—	—
PCIe x1 1	—	—	shared	—	—	—	—	—
PCIe x1 2	—	—	—	shared	—	—	—	—
USB controller 1	—	—	—	—	—	—	—	shared
USB controller 2	—	—	—	shared	—	—	—	—
USB controller 3	—	—	shared	—	—	—	—	—
USB controller 4	shared	—	—	—	—	—	—	—
USB controller 5	shared	—	—	—	—	—	—	—
USB controller 6	shared			—	—	—	—	—
USB 2.0 controller 1	—	—	—	—	—	—	—	shared
USB 2.0 controller 2	—	—	shared	—	—	—	—	—
SATA controller 1	—	—	shared	—	—	—	—	—
SATA controller 2	—	shared	—	—	—	—	—	—

2.5.4 PCI slots

The PCI slots support cards such as a LAN card, SCSI card, USB card, and other cards that comply with PCI specifications. Refer to the figure below for the location of the slot.

2.5.5 PCI Express x1 slots

This motherboard supports PCI Express x1 network cards, SCSI cards and other cards that comply with the PCI Express specifications. Refer to the figure below for the location of the slot.

2.5.6 PCI Express 2.0 x16 slots

This motherboard has three PCI Express x16 slots that support PCI Express x16 graphic cards complying with the PCI Express specifications. With two graphics cards installed, the motherboard can enable dual-display. Two (blue slots) of the three PCI Express x16 slots support PCIe x16 2.0 devices.

This motherboard supports two ATI CrossFire™ PCI Express x16 graphics cards that comply with the PCI Express specifications.



We recommend that you install a VGA card on the primary (blue) PCI Express slots, and install any other PCI Express device on the Universal PCI Express slot (black).

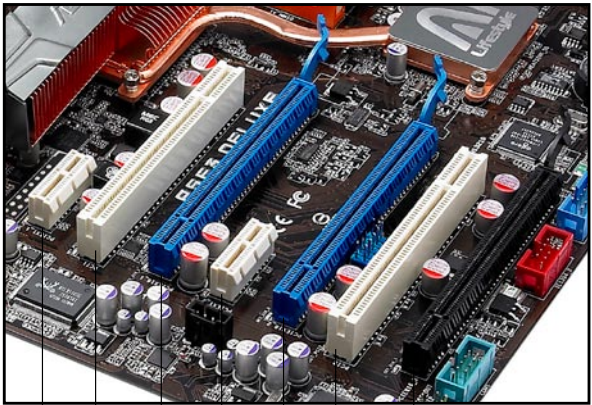

- PCI slot 1
- PCI Express x1_1 slot
- PCI slot 2
- PCI Express x1_2 slot
- PCIe 2.0 x16_1 slot (blue, @ x16)
- PCIe 2.0 x16_2 slot (blue, @ x16)
- PCIe x16_3 slot (black, @ x4 or x1)

Primary PCI Express x16 slots

The primary PCI Express x16 slots support PCI Express x16 graphic cards that comply with the PCI Express specifications.

Universal PCI Express slot (max. x4 mode)

This motherboard also supports a Universal PCI Express slot with a maximum speed of 2 GB/s. The operating frequency of this slot changes, depending on the type of PCI Express card you install. Refer to the table below for details.



If you install two VGA cards, we recommend that you plug the rear chassis fan cable to the motherboard connector labeled CHA_FAN1 for better thermal environment. See page 2-30 for the connector location.

Options for Universal PCI Express slot	PCI Express operating speed
Auto	Automatically optimizes performance and functionality according to devices installed
x4 mode [fast]	User gets the best performance but this mode disables the PCI Express x1 slot
x1 mode [compatible]	Always runs at PCI Express x1 speed



Some PCI Express devices cannot operate on x4/x1 mode.

2.5.7 AI Slot Detector

This motherboard comes with on-board LEDs that light up when the PCIe/PCI devices are not correctly installed. This is a reminder that you should reinstall these devices. Refer to the figure on the right for the location of the LEDs.



- The PCIEx16_1 slot (blue) and PCIEx16_2 slot (blue) support PCIe x16 cards only. The AI Slot Detector lights up when you install a x1 or x4 card to this slot.
- When the AI Slot Detector lights up for incorrect installation, make sure to turn off the power supply unit before reinstalling the card to avoid electrical shock hazard.

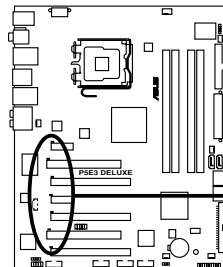

DET_X1_1
DET_PCI1
DET_X16_1
DET_X1_2
DET_X16_2
DET_PCI2
DET_X16_3

P5E3 DELUXE Slot Detector

2.6 Jumper

1. Clear RTC RAM (CLRTC)

This jumper allows you to clear the Real Time Clock (RTC) RAM in CMOS. You can clear the CMOS memory of date, time, and system setup parameters by erasing the CMOS RTC RAM data. The onboard button cell battery powers the RAM data in CMOS, which include system setup information such as system passwords.

To erase the RTC RAM:

1. Turn OFF the computer and unplug the power cord.
2. Remove the onboard battery.
3. Move the jumper cap from pins 1-2 (default) to pins 2-3. Keep the cap on pins 2-3 for about 5~10 seconds, then move the cap back to pins 1-2.
4. Reinstall the battery.
5. Plug the power cord and turn ON the computer.
6. Hold down the key during the boot process and enter BIOS setup to re-enter data.



Except when clearing the RTC RAM, never remove the cap on CLRTC jumper default position. Removing the cap will cause system boot failure!

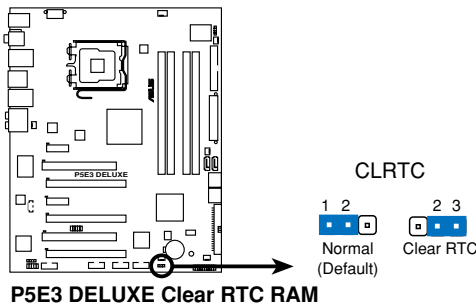

- You do not need to clear the RTC when the system hangs due to overclocking. For system failure due to overclocking, use the C.P.R. (CPU Parameter Recall) feature. Shut down and reboot the system so the BIOS can automatically reset parameter settings to default values.
- Due to the chipset behavior, AC power off is required to enable C.P.R. function. You must turn off and on the power supply or unplug and plug the power cord before reboot the system.

2.7 Connectors

2.7.1 Rear panel connectors

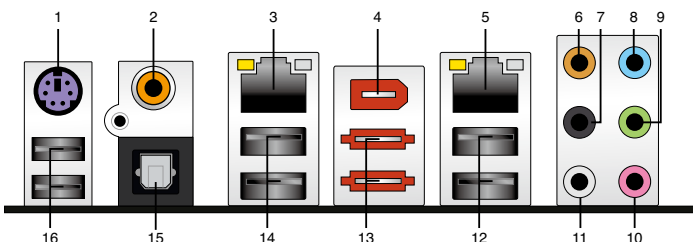

1. **PS/2 keyboard port (purple).** This port is for a PS/2 keyboard.
2. **Coaxial S/PDIF Out port.** This port connects an external audio output device via a coaxial S/PDIF cable.
3. **LAN 1 (RJ-45) port.** Supported by Marvell® LAN controller, this port allows Gigabit connection to a Local Area Network (LAN) through a network hub. Refer to the table below for the LAN port LED indications.
4. **IEEE 1394a port.** This 6-pin IEEE 1394a port provides high-speed connectivity for audio/video devices, storage peripherals, PCs, or portable devices.
5. **LAN 2 (RJ-45) port.** Supported by Realtek® LAN controller, this port allows Gigabit connection to a Local Area Network (LAN) through a network hub. Refer to the table below for the LAN port LED indications.

LAN port LED indications

Activity Link LED		Speed LED	
Status	Description	Status	Description
OFF	No link	OFF	10 Mbps connection
ORANGE	Linked	ORANGE	100 Mbps connection
BLINKING	Data activity	GREEN	1 Gbps connection

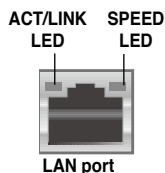

6. **Center/Subwoofer port (orange).** This port connects the center/subwoofer speakers.
7. **Rear Speaker Out port (black).** This port connects the rear speakers in a 4-channel, 6-channel, or 8-channel audio configuration..
8. **Line In port (light blue).** This port connects the tape, CD, DVD player, or other audio sources.
9. **Line Out port (lime).** This port connects a headphone or a speaker. In 4-channel, 6-channel, and 8-channel configuration, the function of this port becomes Front Speaker Out.

- 10. **Microphone port (pink).** This port connects a microphone.
- 11. **Side Speaker Out port (gray).** This port connects the side speakers in an 8-channel audio configuration.



Refer to the audio configuration table below for the function of the audio ports in 2, 4, 6, or 8-channel configuration.

Audio 2, 4, 6, or 8-channel configuration

Port	Headset 2-channel	4-channel	6-channel	8-channel
Light Blue	Line In	Line In	Line In	Line In
Lime	Line Out	Front Speaker Out	Front Speaker Out	Front Speaker Out
Pink	Mic In	Mic In	Mic In	Mic In
Orange	–	–	Center/Subwoofer	Center/Subwoofer
Black	–	Rear Speaker Out	Rear Speaker Out	Rear Speaker Out
Gray	–	–	–	Side Speaker Out

- 12. **USB 2.0 ports 1 and 2.** These 4-pin Universal Serial Bus (USB) ports are available for connecting USB 2.0 devices.
- 13. **External SATA port 1/2.** These ports connect to external Serial ATA hard disk drives. To configure a RAID0 or RAID1 set, connect an external Serial ATA hard disk drive to the External SATA port 1 and 2 respectively.



The external SATA ports support external SATA 3 Gb/s devices. Longer cables support higher power requirements to deliver signal up to two meters away, and enables improved hot-swap function.

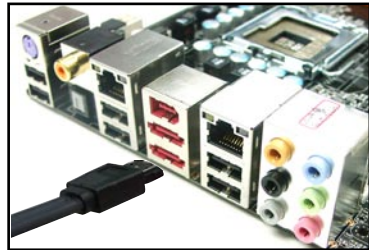

- DO NOT insert different connectors to the external SATA ports.
- DO NOT unplug the external Serial ATA box when a RAID 0 or RAID 1 is configured.



-
- Before creating a RAID set using Serial ATA hard disks, make sure that you have connected the Serial ATA signal cable and installed Serial ATA hard disk drives; otherwise, you cannot enter the JMicron RAID utility and SATA BIOS setup during POST.
 - If you intend to create a RAID configuration using this connector, set the J-Micron eSATA/PATA Controller Mode in the BIOS to [RAID]. See section **4.5.3 Onboard Device Configuration** for details.
 - When using hot-plug and NCQ, set the J-Micron eSATA/PATA Controller Mode in the BIOS to [AHC]. See section **4.5.3 Onboard Device Configuration** for details.
 - Before creating a RAID set, refer to **5.4.4 JMicron® RAID Configuration** or the manual bundled in the motherboard support DVD.
-

14. **USB 2.0 ports 3 and 4.** These 4-pin Universal Serial Bus (USB) ports are available for connecting USB 2.0 devices.
15. **Optical S/PDIF Out port.** This port connects an external audio output device via an optical S/PDIF cable.
16. **USB 2.0 ports 5 and 6.** These 4-pin Universal Serial Bus (USB) ports are available for connecting USB 2.0 devices.

2.7.2 Internal connectors

1. Floppy disk drive connector (34-1 pin FLOPPY)

This connector is for the provided floppy disk drive (FDD) signal cable. Insert one end of the cable to this connector, then connect the other end to the signal connector at the back of the floppy disk drive.

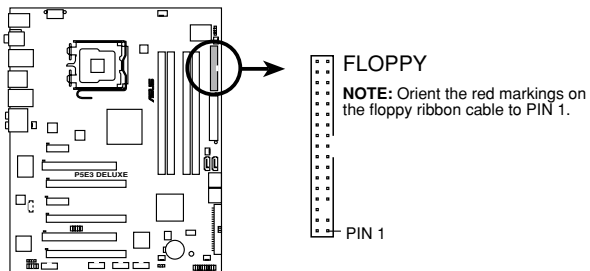

P5E3 DELUXE Floppy disk drive connector



Pin 5 on the connector is removed to prevent incorrect cable connection when using a FDD cable with a covered Pin 5.

2. IDE connector (40-1 pin PRI_E IDE)

The onboard IDE connector is for the Ultra DMA 133/100 signal cable. There are three connectors on each Ultra DMA 133/100 signal cable: blue, black, and gray. Connect the blue connector to the motherboard's IDE connector, then select one of the following modes to configure your device.

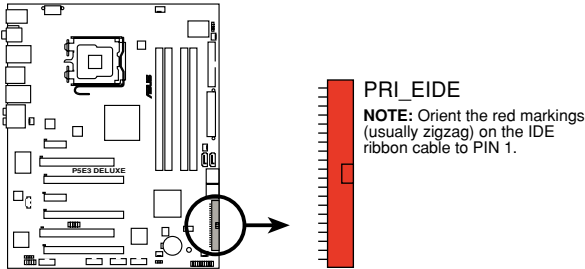

P5E3 DELUXE IDE connector

	Drive jumper setting	Mode of device(s)	Cable connector
Single device	Cable-Select or Master	-	Black
Two devices	Cable-Select	Master	Black
		Slave	Gray
	Master	Master	Black or gray
	Slave	Slave	



- Pin 20 on the IDE connector is removed to match the covered hole on the Ultra DMA cable connector. This prevents incorrect insertion when you connect the IDE cable.
- Use the 80-conductor IDE cable for Ultra DMA 133/100 IDE devices.



If any device jumper is set as "Cable-Select," make sure all other device jumpers have the same setting.

3. ICH9R Serial ATA connectors (7-pin SATA1-6)

These connectors are for the Serial ATA signal cables for Serial ATA hard disk drives and optical disc drives.

If you installed Serial ATA hard disk drives, you can create a RAID 0, 1, 5, and 10 configuration with the Intel® Matrix Storage Technology through the onboard Intel® ICH9R RAID controller.

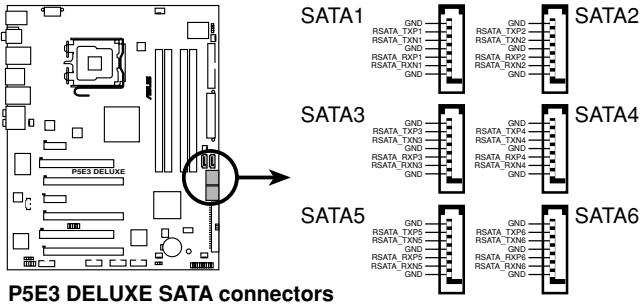

P5E3 DELUXE SATA connectors



- These connectors are set to Standard IDE mode by default. In Standard IDE mode, you can connect Serial ATA boot/data hard disk drives to these connectors. If you intend to create a Serial ATA RAID set using these connectors, set the **Configure SATA as** item in the BIOS to [RAID]. See section **4.3.6 SATA Configuration** for details.
- Before creating a RAID set, refer to **5.4.3 Intel RAID Configuration** or the manual bundled in the motherboard support CD.
- You must install the Windows® XP Service Pack 1 before using Serial ATA hard disk drives. The Serial ATA RAID feature (RAID 0, 1, 5, and 10) is available only if you are using Windows® XP or later version.
- When using the connectors in Standard IDE mode, connect the primary (boot) hard disk drive to the SATA1/2/5 connector.
- When using hot-plug and NCQ, set the **Configure SATA as** in the BIOS to [AHCI]. See section **4.3.6 SATA Configuration** for details.



Connect the right-angle side of SATA signal cable to SATA device. Or you may connect the right-angle side of SATA cable to the onboard SATA port to avoid mechanical conflict with huge graphics cards.

right angle side

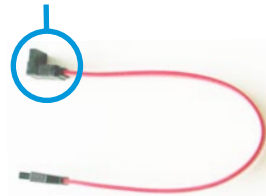

4. USB connectors (10-1 pin USB 78, USB 910, USB 1112)

These connectors are for USB 2.0 ports. Connect the USB module cable to any of these connectors, then install the module to a slot opening at the back of the system chassis. These USB connectors comply with USB 2.0 specification that supports up to 480 Mbps connection speed.

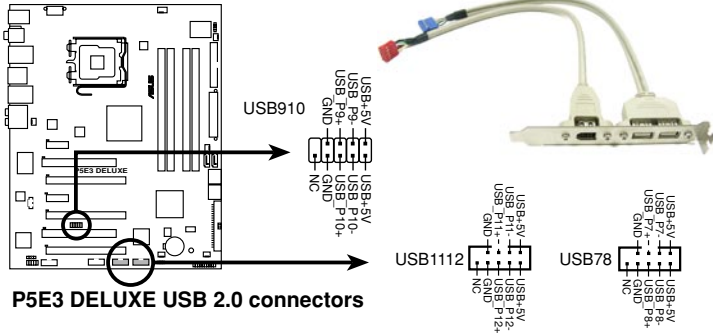

Never connect a 1394 cable to the USB connectors. Doing so will damage the motherboard!



If your chassis supports front panel USB ports, you can attach a front panel USB cable to these connectors. Connect the USB cable to ASUS Q-Connector (USB, blue) first, and then install the Q-Connector (USB) to the USB connector onboard.

5. IEEE 1394a port connector (10-1 pin IE1394_2)

This connector is for a IEEE 1394a port. Connect the IEEE 1394a module cable to this connector, then install the module to a slot opening at the back of the system chassis.

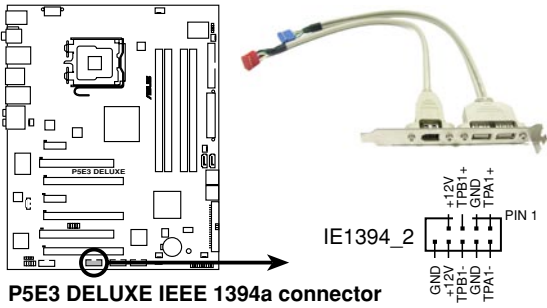

Never connect a USB cable to the IEEE 1394a connector. Doing so will damage the motherboard!



You can attach a FireWire/1394 cable to this connector if your chassis supports the front panel IEEE1394 port. Connect the 1394 cable to ASUS Q-Connector (1394, red) first, and then install the Q-Connector (1394) to the 1394 connector onboard.

**6. CPU, chassis and power fan connectors
(4-pin CPU_FAN, 3-pin CHA_FAN1-4, 3-pin PWR_FAN)**

The fan connectors support cooling fans of 350 mA ~ 2000 mA (24 W max.) or a total of 1 A ~ 7 A (84 W max.) at +12V. Connect the fan cables to the fan connectors on the motherboard, making sure that the black wire of each cable matches the ground pin of the connector.

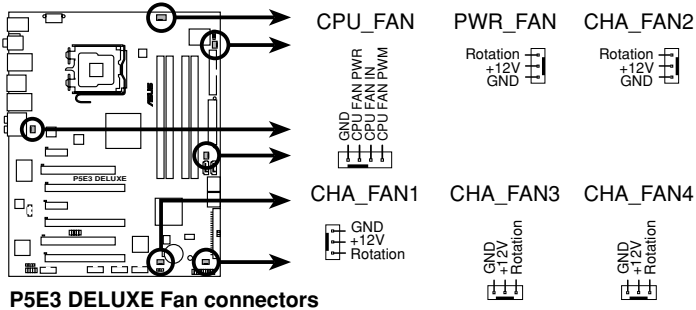

DO NOT forget to connect the fan cables to the fan connectors. Insufficient air flow inside the system may damage the motherboard components. These are not jumpers! Do not place jumper caps on the fan connectors!



- Only the CPU-FAN and CHA-FAN 1-4 connectors support the ASUS Advanced Q-Fan feature.
- If you install two VGA cards, we recommend that you plug the rear chassis fan cable to the motherboard connector labeled CHA_FAN1 or CHA_FAN2 for better thermal environment.

7. Chassis intrusion connector (4-1 pin CHASSIS)

This connector is for a chassis-mounted intrusion detection sensor or switch. Connect one end of the chassis intrusion sensor or switch cable to this connector. The chassis intrusion sensor or switch sends a high-level signal to this connector when a chassis component is removed or replaced. The signal is then generated as a chassis intrusion event.

By default, the pin labeled “Chassis Signal” and “Ground” are shorted with a jumper cap. Remove the jumper caps only when you intend to use the chassis intrusion detection feature.

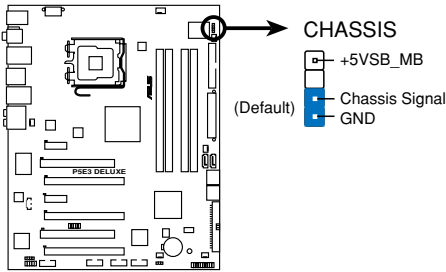

P5E3 DELUXE Chassis intrusion connector

8. ATX power connectors (24-pin EATXPWR, 2x4-pin EATX12V)

These connectors are for ATX power supply plugs. The power supply plugs are designed to fit these connectors in only one orientation. Find the proper orientation and push down firmly until the connectors completely fit.

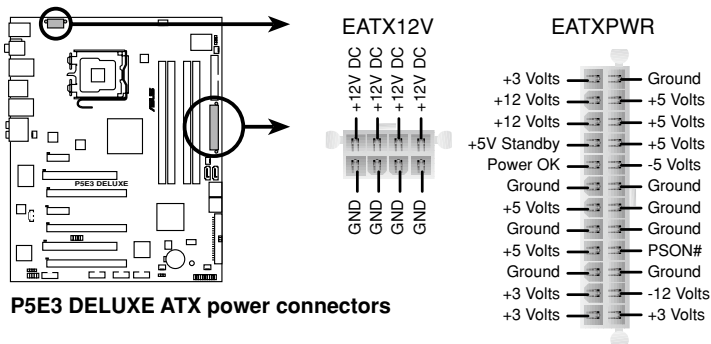

- Make sure to remove the cap on the EATX12V connector before connecting an 8-pin EPS +12V power plug.
- Use only either a 4-pin ATX12V or an 8-pin EPS +12V power plug for the EATX12V connector.



- For a fully configured system, we recommend that you use a power supply unit (PSU) that complies with ATX 12 V Specification 2.0 (or later version) and provides a minimum power of 400 W.
- Do not forget to connect the 8-pin / 4-pin EATX12V power plug; otherwise, the system will not boot.
- Use of a PSU with a higher power output is recommended when configuring a system with more power-consuming devices. The system may become unstable or may not boot up if the power is inadequate.
- If you want to use two high-end PCI Express x16 cards, use a PSU with 500W to 600W power or above to ensure the system stability.
- If you are uncertain about the minimum power supply requirement for your system, refer to the **Recommended Power Supply Wattage Calculator** at <http://support.asus.com/PowerSupplyCalculator/PSCalculator.aspx?SLanguage=en-us> for details.
- The ATX 12 V Specification 2.0-compliant (400W) PSU has been tested to support the motherboard power requirements with the following configuration:
CPU: Intel® Pentium® Extreme 3.73GHz
Memory: 512 MB DDR3 (x4)
Graphics card: ASUS EAX1900XT
Parallel ATA device: IDE hard disk drive
Serial ATA device: SATA hard disk drive (x2)
Optical drive: DVD-RW

9. Front panel audio connector (10-1 pin AAFP)

This connector is for a chassis-mounted front panel audio I/O module that supports either HD Audio or legacy AC'97 audio standard. Connect one end of the front panel audio I/O module cable to this connector.

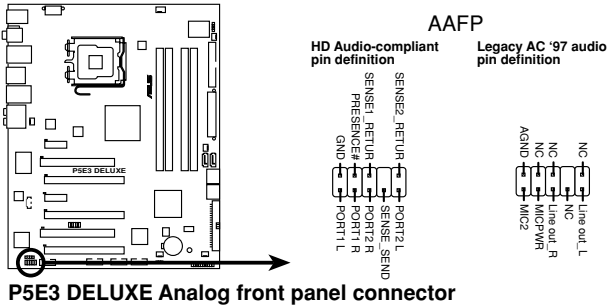

- We recommend that you connect a high-definition front panel audio module to this connector to avail of the motherboard's high-definition audio capability.
- If you want to connect a high-definition front panel audio module to this connector, make sure that the **Front Panel Type** item in the BIOS is set to [HD Audio]. If you want to connect an AC'97 front panel audio module to this connector, set the item to [AC97]. Refer to **4.5.3 Onboard Device Configuration** for details.

10. Optical drive audio connector (4-pin CD)

This connector allows you to receive stereo audio input from sound sources such as a CD-ROM, TV tuner, or MPEG card.

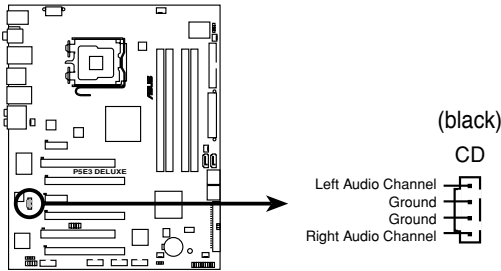

P5E3 DELUXE Internal audio connector

11. Digital audio connector (4-1 pin SPDIF, for ASUS HDMI VGA card)

This connector is for an additional Sony/Philips Digital Interface (S/PDIF) port(s). If you are using ASUS HDMI-equipped graphics card, connect the HDMI card to this connector with a S/PDIF out cable.

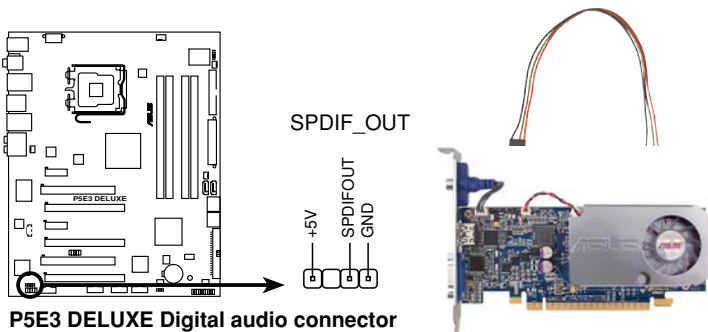

P5E3 DELUXE Digital audio connector



The ASUS HDMI-equipped graphics card and S/PDIF out cable are purchased separately.

12. System panel connector (20-8 pin PANEL)

This connector supports several chassis-mounted functions.

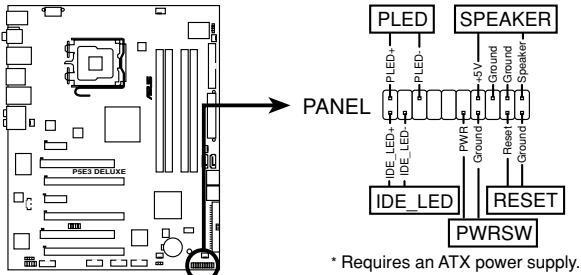

P5E3 DELUXE System panel connector

- **System power LED (2-pin PLED)**

This 2-pin connector is for the system power LED. Connect the chassis power LED cable to this connector. The system power LED lights up when you turn on the system power, and blinks when the system is in sleep mode.

- **Hard disk drive activity LED (2-pin IDE_LED)**

This 2-pin connector is for the HDD Activity LED. Connect the HDD Activity LED cable to this connector. The IDE LED lights up or flashes when data is read from or written to the HDD.

- **System warning speaker (4-pin SPEAKER)**

This 4-pin connector is for the chassis-mounted system warning speaker. The speaker allows you to hear system beeps and warnings.

- **ATX power button/soft-off button (2-pin PWRSW)**

This connector is for the system power button. Pressing the power button turns the system on or puts the system in sleep or soft-off mode depending on the BIOS settings. Pressing the power switch for more than four seconds while the system is ON turns the system OFF.

- **Reset button (2-pin RESET)**

This 2-pin connector is for the chassis-mounted reset button for system reboot without turning off the system power.

13. ASUS Q-Connector (system panel)

You can use the ASUS Q-Connector to connect/disconnect chassis front panel cables in a few steps. Refer to the instructions below to install the ASUS Q-Connector.

1. Connect the front panel cables to the ASUS Q-Connector.

Refer to the labels on the Q-Connector to know the detailed pin definitions, then match them to the respective front panel cable labels.

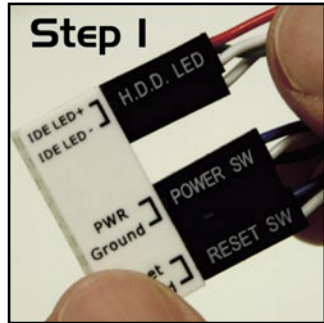

2. Install the ASUS Q-Connector to the system panel connector, making sure the orientation matches the labels on the motherboard.

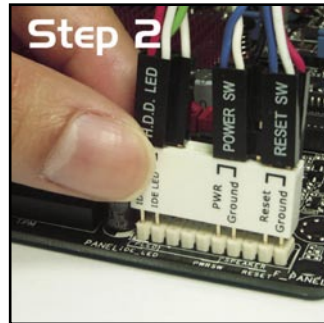

3. The front panel functions are now enabled. The figure shows the Q-Connector properly installed on the motherboard.

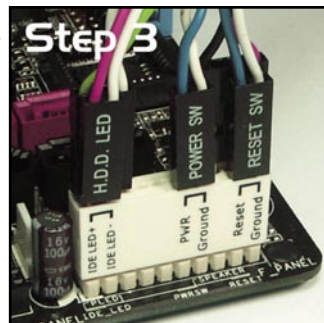

2.7.3 Installing the optional fans



Install the optional fan only if you are using a passive cooler or a water cooler. Installing the optional fan with an active CPU cooler will interfere with the airflow and destabilize the system.

1. Position the fan above the pipe and heatsink assembly.
2. Fit the fan to the grooved edge of the heatsink.

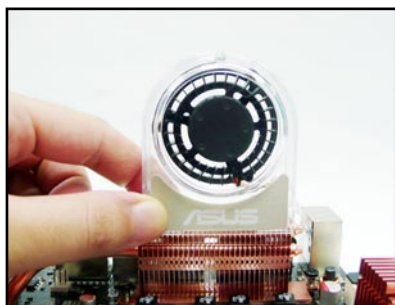

3. Carefully push down the fan until it snugly fits the heatsink, then connect the fan cable.
4. The photo shows the fan installed on the motherboard.

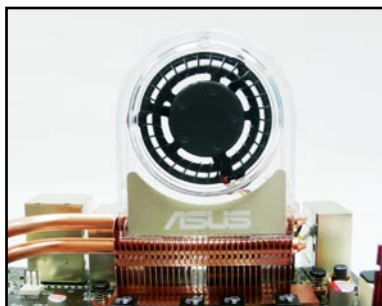

5. Follow the previous instructions to install the other optional fan.

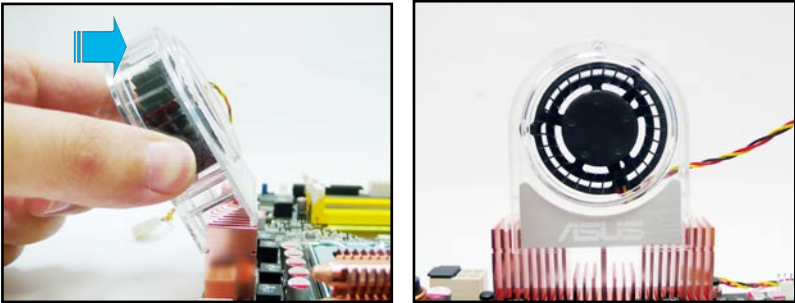
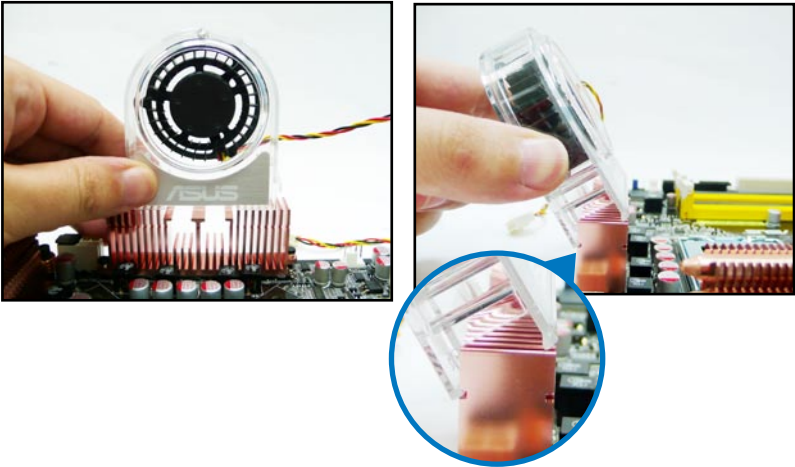

6. The photo on the right shows the fans installed on the motherboard.

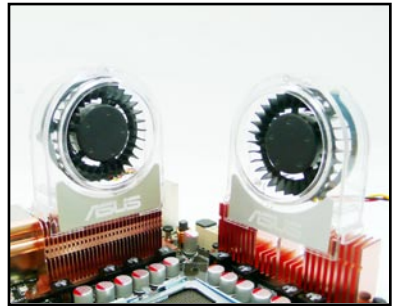

- Plug the optional fan cables to the CHA_FAN1, CHA_FAN2 or PWR_FAN connector on the motherboard.
- Make sure the optional fan is installed correctly to prevent damage to the fan and motherboard components.

This chapter describes the power up sequence, the vocal POST messages, and ways of shutting down the system.

Powering up **3**

3.1 Starting up for the first time..... 3-1
3.2 Turning off the computer..... 3-2

3.1 Starting up for the first time

1. After making all the connections, replace the system case cover.
2. Be sure that all switches are off.
3. Connect the power cord to the power connector at the back of the system chassis.
4. Connect the power cord to a power outlet that is equipped with a surge protector.
5. Turn on the devices in the following order:
 - a. Monitor
 - b. External SCSI devices (starting with the last device on the chain)
 - c. System power
6. After applying power, the system power LED on the system front panel case lights up. For systems with ATX power supplies, the system LED lights up when you press the ATX power button. If your monitor complies with “green” standards or if it has a “power standby” feature, the monitor LED may light up or switch between orange and green after the system LED turns on.

The system then runs the power-on self tests or POST. While the tests are running, the BIOS beeps (see BIOS beep codes table below) or additional messages appear on the screen. If you do not see anything within 30 seconds from the time you turned on the power, the system may have failed a power-on test. Check the jumper settings and connections or call your retailer for assistance.

BIOS Beep	Description
One short beep	VGA detected Quick boot set to disabled No keyboard detected
One continuous beep followed by two short beeps then a pause (repeated)	No memory detected
One continuous beep followed by three short beeps	No VGA detected
One continuous beep followed by four short beeps	Hardware component failure

7. At power on, hold down the <Delete> key to enter the BIOS Setup. Follow the instructions in Chapter 4.

3.2 Turning off the computer

3.2.1 Using the OS shut down function

If you are using Windows® XP:

1. Click the Start button then select Turn Off Computer.
2. Click the Turn Off button to shut down the computer.
3. The power supply should turn off after Windows® shuts down.

If you are using Windows® Vista:

1. Click the Start button then select ShutDown.
2. The power supply should turn off after Windows® shuts down.

3.2.2 Using the dual function power switch

While the system is ON, pressing the power switch for less than four seconds puts the system to sleep mode or to soft-off mode, depending on the BIOS setting. Pressing the power switch for more than four seconds lets the system enter the soft-off mode regardless of the BIOS setting. Refer to section **4.6 Power Menu** in Chapter 4 for details.

This chapter tells how to change the system settings through the BIOS Setup menus. Detailed descriptions of the BIOS parameters are also provided.

BIOS setup **4**

4.1	Managing and updating your BIOS	4-1
4.2	BIOS setup program	4-8
4.3	Main menu	4-11
4.4	Ai Tweaker	4-16
4.5	Advanced menu	4-23
4.6	Power menu.....	4-29
4.7	Boot menu	4-33
4.8	Tools menu	4-37
4.9	Exit menu	4-40

4.1 Managing and updating your BIOS

The following utilities allow you to manage and update the motherboard Basic Input/Output System (BIOS) setup.

1. **ASUS Update** (Updates the BIOS in Windows® environment.)
2. **ASUS EZ Flash 2** (Updates the BIOS using a floppy disk or USB flash disk.)
3. **ASUS AFUDOS** (Updates the BIOS using a bootable floppy disk)
4. **ASUS CrashFree BIOS 3** (Updates the BIOS using a bootable floppy disk, USB flash disk or the motherboard support DVD when the BIOS file fails or gets corrupted.)

Refer to the corresponding sections for details on these utilities.



Save a copy of the original motherboard BIOS file to a bootable floppy disk or USB flash disk in case you need to restore the BIOS in the future. Copy the original motherboard BIOS using the ASUS Update or AFUDOS utilities.

4.1.1 ASUS Update utility

The ASUS Update is a utility that allows you to manage, save, and update the motherboard BIOS in Windows® environment. The ASUS Update utility allows you to:

- Save the current BIOS file
- Download the latest BIOS file from the Internet
- Update the BIOS from an updated BIOS file
- Update the BIOS directly from the Internet, and
- View the BIOS version information.

This utility is available in the support DVD that comes with the motherboard package.



ASUS Update requires an Internet connection either through a network or an Internet Service Provider (ISP).

Installing ASUS Update

To install ASUS Update:

1. Place the support DVD in the optical drive. The Drivers menu appears.
2. Click the Utilities tab, then click Install ASUS Update VX.XX.XX.
3. The ASUS Update utility is copied to your system.



Quit all Windows® applications before you update the BIOS using this utility.

Updating the BIOS through the Internet

To update the BIOS through the Internet:

1. Launch the ASUS Update utility from the Windows® desktop by clicking **Start > Programs > ASUS > ASUSUpdate > ASUSUpdate**. The ASUS Update main window appears.

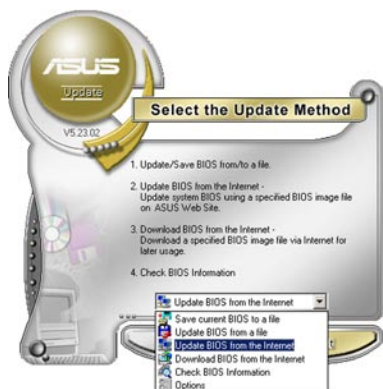
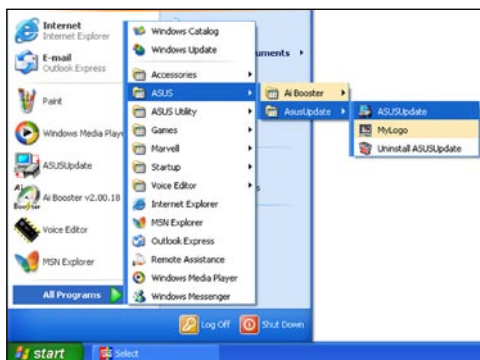

2. Select **Update BIOS** from the Internet option from the drop-down menu, then click **Next**.



3. Select the ASUS FTP site nearest you to avoid network traffic, or click **Auto Select**. Click **Next**.

- From the FTP site, select the BIOS version that you wish to download. Click **Next**.
- Follow the screen instructions to complete the update process.



The ASUS Update utility is capable of updating itself through the Internet. Always update the utility to avail all its features.



Updating the BIOS through a BIOS file

To update the BIOS through a BIOS file:

- Launch the ASUS Update utility from the Windows® desktop by clicking **Start** > **Programs** > **ASUS** > **ASUSUpdate** > **ASUSUpdate**. The ASUS Update main window appears.
- Select **Update BIOS** from a file option from the drop-down menu, then click **Next**.

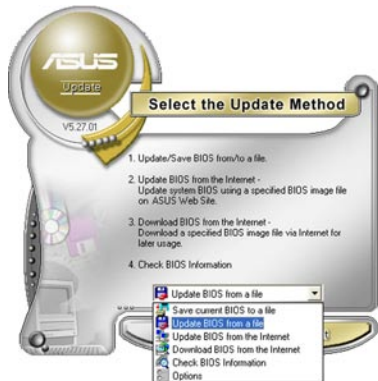

- Locate the BIOS file from the Open window, then click **Open**.
- Follow the screen instructions to complete the update process.

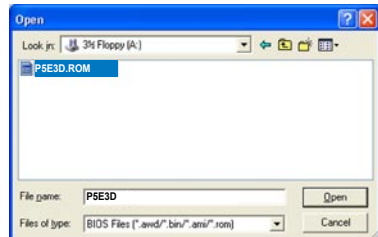

4.1.2 ASUS EZ Flash 2 utility

The ASUS EZ Flash 2 feature allows you to update the BIOS without having to go through the long process of booting from a floppy disk and using a DOS-based utility. The EZ Flash 2 utility is built-in the BIOS chip so it is accessible by pressing <Alt> + <F2> during the Power-On Self Tests (POST).

To update the BIOS using EZ Flash 2:

1. Visit the ASUS website (www.asus.com) to download the latest BIOS file for the motherboard.
2. Save the BIOS file to a floppy disk or a USB flash disk, then restart the system.
3. You can launch the EZ Flash 2 by two methods.
 - (1) Insert the floppy disk / USB flash disk that contains the BIOS file to the floppy disk drive or the USB port.

Press <Alt> + <F2> during POST to display the following.

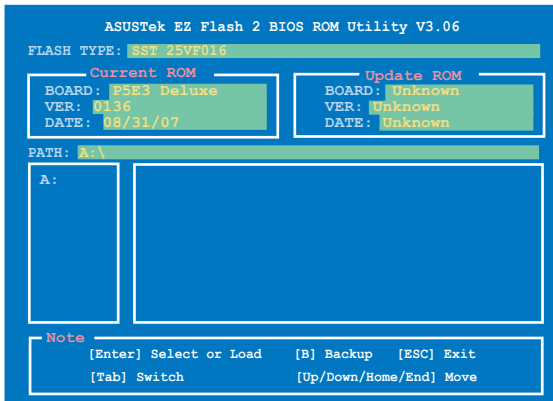

- (2) Enter BIOS setup program. Go to the **Tools** menu to select **EZ Flash2** and press <Enter> to enable it.
You can switch between drives by pressing <Tab> before the correct file is found. Then press <Enter>.
4. When the correct BIOS file is found, EZ Flash 2 performs the BIOS update process and automatically reboots the system when done.



- This function can support devices such as a USB flash disk or a floppy disk with **FAT 32/16** format and single partition only.
- DO NOT shut down or reset the system while updating the BIOS to prevent system boot failure!

4.1.3 AFUDOS utility

The AFUDOS utility allows you to update the BIOS file in DOS environment using a bootable floppy disk with the updated BIOS file. This utility also allows you to copy the current BIOS file that you can use as backup when the BIOS fails or gets corrupted during the updating process.

Copying the current BIOS

To copy the current BIOS file using the AFUDOS utility:



- Make sure that the floppy disk is not write-protected and has at least 1024KB free space to save the file.
- The succeeding BIOS screens are for reference only. The actual BIOS screen displays may not be same as shown.

1. Copy the AFUDOS utility (afudos.exe) from the motherboard support DVD to the bootable floppy disk you created earlier.
2. Boot the system in DOS mode, then at the prompt type:

```
afudos /o[filename]
```

where the [filename] is any user-assigned filename not more than eight alphanumeric characters for the main filename and three alphanumeric characters for the extension name.

```
A:\>afudos /oOLDBIOS1.rom
```

Main filename Extension name

3. Press <Enter>. The utility copies the current BIOS file to the floppy disk.

```
A:\>afudos /oOLDBIOS1.rom
AMI Firmware Update Utility - Version 1.19 (ASUS V2.07 (03.11.24BB))
Copyright (C) 2002 American Megatrends, Inc. All rights reserved.
Reading flash ..... done
Write to file..... ok
A:\>
```

The utility returns to the DOS prompt after copying the current BIOS file.

Updating the BIOS file

To update the BIOS file using the AFUDOS utility:

1. Visit the ASUS website (www.asus.com) and download the latest BIOS file for the motherboard. Save the BIOS file to a bootable floppy disk.



Write the BIOS filename on a piece of paper. You need to type the exact BIOS filename at the DOS prompt.

- Copy the AFUDOS utility (afudos.exe) from the motherboard support DVD to the bootable floppy disk you created earlier.
- Boot the system in DOS mode, then at the prompt type:

```
afudos /i[filename]
```

where [filename] is the latest or the original BIOS file on the bootable floppy disk.

```
A:\>afudos /iP5E3D.ROM
```

- The utility verifies the file and starts updating the BIOS.

```
A:\>afudos /iP5E3D.ROM
AMI Firmware Update Utility - Version 1.19(ASUS V2.07(03.11.24BB))
Copyright (C) 2002 American Megatrends, Inc. All rights reserved.

WARNING!! Do not turn off power during flash BIOS
Reading file ..... done
Reading flash ..... done

Advance Check .....
Erasing flash ..... done
Writing flash ..... 0x0008CC00 (9%)
```



DO NOT shut down or reset the system while updating the BIOS to prevent system boot failure!

- The utility returns to the DOS prompt after the BIOS update process is completed. Reboot the system from the hard disk drive.

```
A:\>afudos /iP5E3D.ROM
AMI Firmware Update Utility - Version 1.19(ASUS V2.07(03.11.24BB))
Copyright (C) 2002 American Megatrends, Inc. All rights reserved.

WARNING!! Do not turn off power during flash BIOS
Reading file ..... done
Reading flash ..... done

Advance Check .....
Erasing flash ..... done
Writing flash ..... done
Verifying flash .... done

Please restart your computer

A:\>
```

4.1.4 ASUS CrashFree BIOS 3 utility

The ASUS CrashFree BIOS 3 is an auto recovery tool that allows you to restore the BIOS file when it fails or gets corrupted during the updating process. You can update a corrupted BIOS file using the motherboard support DVD, the floppy disk, or the USB flash disk that contains the updated BIOS file.



Prepare the motherboard support DVD, the floppy disk or the USB flash disk containing the updated motherboard BIOS before using this utility.

Recovering the BIOS from the support DVD

To recover the BIOS from the support DVD:

1. Turn on the system.
2. Insert the motherboard support DVD to the optical drive.
3. The utility displays the following message and automatically checks the DVD for the BIOS file.

```
Bad BIOS checksum. Starting BIOS recovery...
Checking for floppy...
```

When found, the utility reads the BIOS file and starts flashing the corrupted BIOS file.

```
Bad BIOS checksum. Starting BIOS recovery...
Checking for floppy...
Floppy found!
Reading file "P5K3D.ROM". Completed.
Start flashing...
```

4. Restart the system after the utility completes the updating process.

Recovering the BIOS from the USB flash disk

To recover the BIOS from the USB flash disk:

1. Insert the USB flash disk that contains BIOS file to the USB port.
2. Turn on the system.
3. The utility will automatically checks the devices for the BIOS file. When found, the utility reads the BIOS file and starts flashing the corrupted BIOS file.
4. Restart the system after the utility completes the updating process.



- Only the USB flash disk with FAT 32/16 format and single partition can support ASUS CrashFree BIOS 3. The device size should be smaller than 8GB.
 - DO NOT shut down or reset the system while updating the BIOS! Doing so can cause system boot failure!
-

4.2 BIOS setup program

This motherboard supports a programmable Serial Peripheral Interface (SPI) chip that you can update using the provided utility described in section **4.1 Managing and updating your BIOS**.

Use the BIOS Setup program when you are installing a motherboard, reconfiguring your system, or prompted to “Run Setup.” This section explains how to configure your system using this utility.

Even if you are not prompted to use the Setup program, you can change the configuration of your computer in the future. For example, you can enable the security password feature or change the power management settings. This requires you to reconfigure your system using the BIOS Setup program so that the computer can recognize these changes and record them in the CMOS RAM of the SPI chip.

The SPI chip on the motherboard stores the Setup utility. When you start up the computer, the system provides you with the opportunity to run this program. Press during the Power-On Self-Test (POST) to enter the Setup utility; otherwise, POST continues with its test routines.

If you wish to enter Setup after POST, restart the system by pressing <Ctrl+Alt+Delete>, or by pressing the reset button on the system chassis. You can also restart by turning the system off and then back on. Do this last option only if the first two failed.

The Setup program is designed to make it as easy to use as possible. Being a menu-driven program, it lets you scroll through the various sub-menus and make your selections from the available options using the navigation keys.



-
- The default BIOS settings for this motherboard apply for most conditions to ensure optimum performance. If the system becomes unstable after changing any BIOS settings, load the default settings to ensure system compatibility and stability. Select the **Load Setup Defaults** item under the Exit Menu. See section **4.8 Exit Menu**.
 - The BIOS setup screens shown in this section are for reference purposes only, and may not exactly match what you see on your screen.
 - Visit the ASUS website (www.asus.com) to download the latest BIOS file for this motherboard.
-

4.2.1 BIOS menu screen

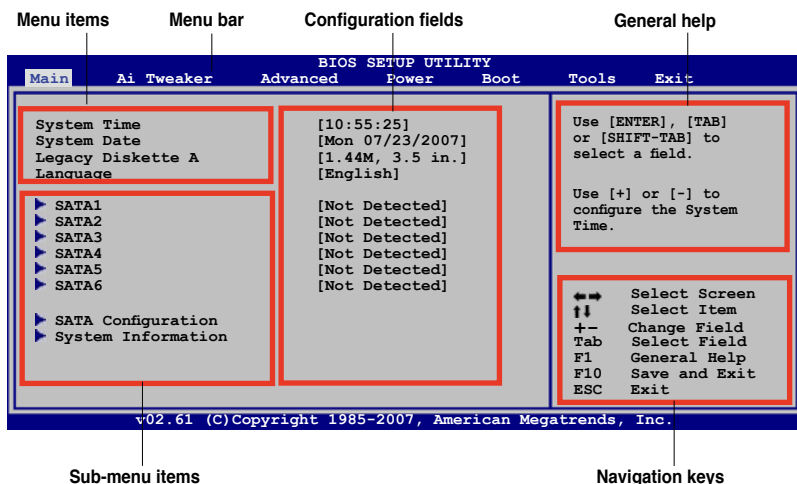

4.2.2 Menu bar

The menu bar on top of the screen has the following main items:

- | | |
|-------------------|--|
| Main | For changing the basic system configuration |
| Ai Tweaker | For changing the overclocking settings |
| Advanced | For changing the advanced system settings |
| Power | For changing the advanced power management (APM) configuration |
| Boot | For changing the system boot configuration |
| Tools | For configuring options for special functions |
| Exit | For selecting the exit options and loading default settings |

To select an item on the menu bar, press the right or left arrow key on the keyboard until the desired item is highlighted.

4.2.3 Navigation keys

At the bottom right corner of a menu screen are the navigation keys for that particular menu. Use the navigation keys to select items in the menu and change the settings.



The navigation keys may differ from one screen to another.

4.2.4 Menu items

The highlighted item on the menu bar displays the specific items for that menu. For example, selecting Main shows the Main menu items.

The other items (Advanced, Power, Boot, and Exit) on the menu bar have their respective menu items.

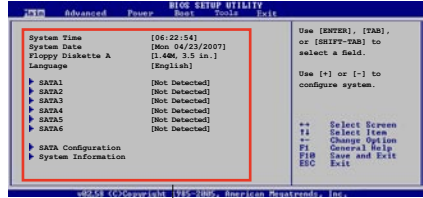

Main menu items

4.2.5 Sub-menu items

A solid triangle before each item on any menu screen means that the item has a sub-menu. To display the sub-menu, select the item and press <Enter>.

4.2.6 Configuration fields

These fields show the values for the menu items. If an item is user-configurable, you can change the value of the field opposite the item. You cannot select an item that is not user-configurable.

A configurable field is enclosed in brackets, and is highlighted when selected. To change the value of a field, select it then press <Enter> to display a list of options. Refer to 4.2.7 Pop-up window.

4.2.7 Pop-up window

Select a menu item then press <Enter> to display a pop-up window with the configuration options for that item.

4.2.8 Scroll bar

A scroll bar appears on the right side of a menu screen when there are items that do not fit on the screen. Press the Up/Down arrow keys or <Page Up> /<Page Down> keys to display the other items on the screen.

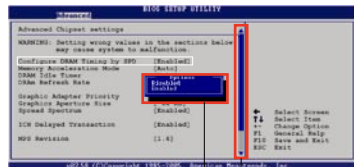

Pop-up window

Scroll bar

4.2.9 General help

At the top right corner of the menu screen is a brief description of the selected item.

4.3 Main menu

When you enter the BIOS Setup program, the Main menu screen appears, giving you an overview of the basic system information.



Refer to section **4.2.1 BIOS menu screen** for information on the menu screen items and how to navigate through them.

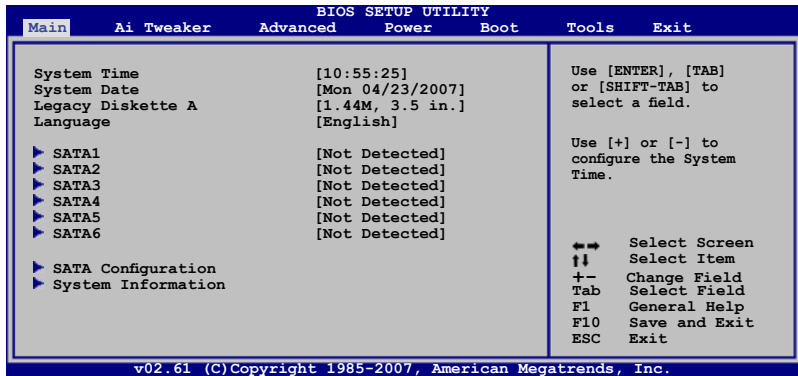

4.3.1 System Time [xx:xx:xx]

Allows you to set the system time.

4.3.2 System Date [Day xx/xx/xxxx]

Allows you to set the system date.

4.3.3 Legacy Diskette A [1.44M, 3.5 in.]

Sets the type of floppy drive installed.

Configuration options: [Disabled] [720K , 3.5 in.] [1.44M, 3.5 in.]

4.3.4 Language [English]

Allows you to select the display language for the BIOS setup screen.

Configuration options: [Chinese(BIG5)] [Chinese(GB)] [Japanese] [Français] [German] [English]

4.3.5 SATA 1-6

While entering Setup, the BIOS automatically detects the presence of Serial ATA devices. There is a separate sub-menu for each SATA device. Select a device item then press <Enter> to display the SATA device information.

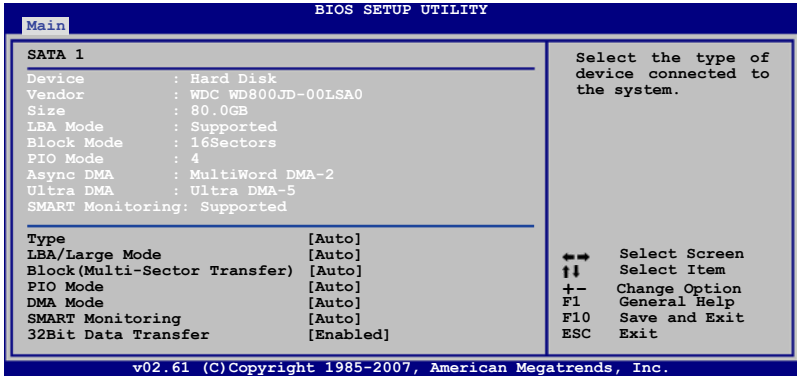

The BIOS automatically detects the values opposite the dimmed items (Device, Vendor, Size, LBA Mode, Block Mode, PIO Mode, Async DMA, Ultra DMA, and SMART monitoring). These values are not user-configurable. These items show N/A if no IDE device is installed in the system.

Type [Auto]

Selects the type of IDE drive. Setting to [Auto] allows automatic selection of the appropriate IDE device type. Select [CDROM] if you are specifically configuring a CD-ROM drive. Select [ARMD] (ATAPI Removable Media Device) if your device is either a ZIP, LS-120, or MO drive.

Configuration options: [Not Installed] [Auto] [CDROM] [ARMD]

LBA/Large Mode [Auto]

Enables or disables the LBA mode. Setting to [Auto] enables the LBA mode if the device supports this mode, and if the device was not previously formatted with LBA mode disabled. Configuration options: [Disabled] [Auto]

Block (Multi-Sector Transfer) [Auto]

Enables or disables data multi-sectors transfers. When set to [Auto], the data transfer from and to the device occurs multiple sectors at a time if the device supports multi-sector transfer feature. When set to [Disabled], the data transfer from and to the device occurs one sector at a time.

Configuration options: [Disabled] [Auto]

PIO Mode [Auto]

Allows you to select the data transfer mode.

Configuration options: [Auto] [0] [1] [2] [3] [4]

DMA Mode [Auto]

Selects the DMA mode.

Configuration options: [Auto] [SWDMA0] [SWDMA1] [SWDMA2] [MWDMA0] [MWDMA1] [MWDMA2] [UDMA0] [UDMA1] [UDMA2] [UDMA3] [UDMA4] [UDMA5]

SMART Monitoring [Auto]

Sets the Smart Monitoring, Analysis, and Reporting Technology.

Configuration options: [Auto] [Disabled] [Enabled]

32Bit Data Transfer [Enabled]

Enables or disables 32-bit data transfer.

Configuration options: [Disabled] [Enabled]

4.3.6 SATA Configuration

The items in this menu allow you to set or change the configurations for the SATA devices installed in the system. Select an item then press <Enter> if you want to configure the item.

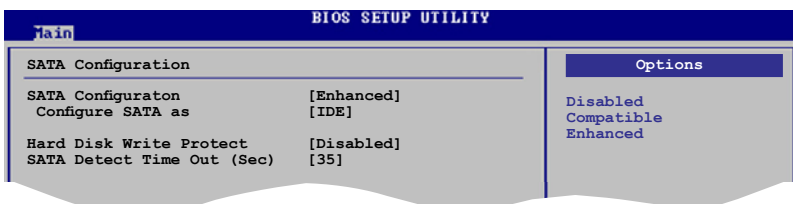

SATA Configuration [Enhanced]

Configuration options: [Disabled] [Compatible] [Enhanced]

Configure SATA as [IDE]

Sets the configuration for the Serial ATA connectors supported by the Southbridge chip. Configuration options: [IDE] [RAID] [AHCI]

The AHCI allows the onboard storage driver to enable advanced Serial ATA features that increases storage performance on random workloads by allowing the drive to internally optimize the order of commands.

If you want to create a RAID 0, RAID 1, RAID 5, RAID 10, or the Intel® Matrix Storage Technology configuration from the Serial ATA hard disk drives, set this item to [RAID].

If you want to use the Serial ATA hard disk drives as Parallel ATA physical storage devices, keep the default setting [IDE].

If you want the Serial ATA hard disk drives to use the Advanced Host Controller Interface (AHCI), set this item to [AHCI].

Hard Disk Write Protect [Disabled]

Disables or enables device write protection. This will be effective only if the device is accessed through BIOS. Configuration option: [Disabled] [Enabled]

SATA Detect Time Out (Sec) [35]

Selects the time out value for detecting ATA/ATAPI devices.
Configuration options: [0] [5] [10] [15] [20] [25] [30] [35]

4.3.7 AHCI Configuration

This menu is the section for AHCI configuration. It appears only when you set the item **Configure SATA as** from the sub-menu of **SATA Configuration** to [AHCI].

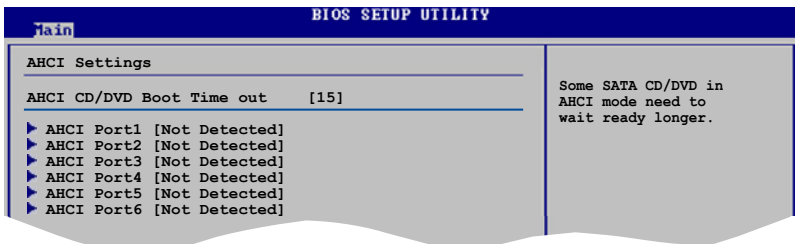

AHCI CD/DVD Boot Time out [15]

Selects the boot time out value for ACHI CD/DVD devices.
Configuration options: [0] [5] [10] [15] [20] [25] [30] [35]

AHCI Port1~6 [XXXX]

Displays the status of auto-detection of SATA devices.

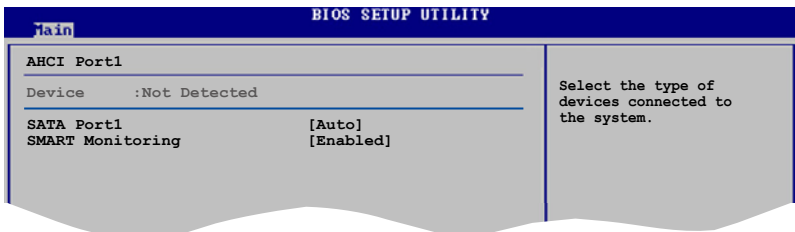

SATA Port1 [Auto]

Allows you to select the type of device connected to the system.
Configuration options: [Auto] [Not Installed]

SMART Monitoring [Enabled]

Allows you to set the Self-Monitoring, Analysis and Reporting Technology.
Configuration options: [Disabled] [Enabled]

4.3.8 System Information

This menu gives you an overview of the general system specifications. The BIOS automatically detects the items in this menu.

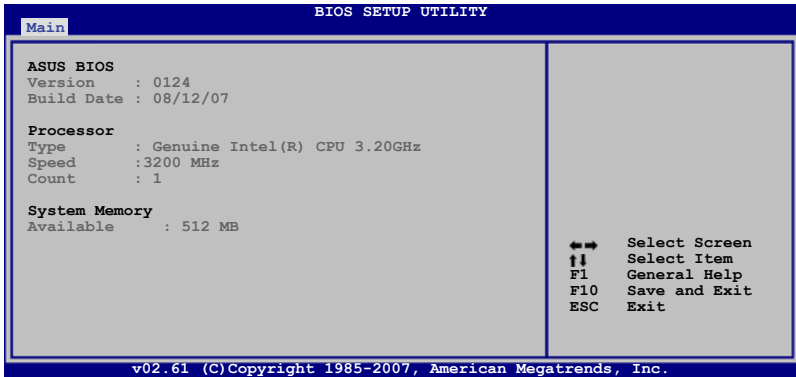

ASUS BIOS

Displays the auto-detected BIOS information.

Processor

Displays the auto-detected CPU specification.

System Memory

Displays the auto-detected system memory.

4.4 Ai Tweaker menu

The Ai Tweaker menu items allow you to configure overclocking-related items.



Take caution when changing the settings of the Ai Tweaker menu items. Incorrect field values can cause the system to malfunction.

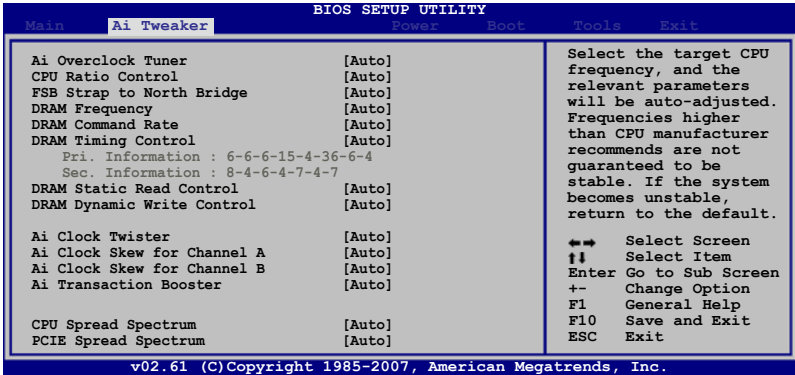

4.4.1 Ai Overclock Tuner [Auto]

Allows selection of CPU overclocking options to achieve desired CPU internal frequency. Select either one of the preset overclocking configuration options:

Manual	Allows you to individually set overclocking parameters.
Auto	Loads the optimal settings for the system.
X.M.P.	If you install memory module(s) supporting the eXtreme Memory Profile (X.M.P.) Technology, choose this item to set the profile(s) supported by your memory module(s) for optimizing the system performance.



The configuration options for the following sub-item vary depending on the DIMMs you install on the motherboard.

eXtreme Memory Profile [Disabled]

This item appears only when you set the **Ai Overclock Tuner** item to [X.M.P.]. Allows you to select the X.M.P. mode supported by your Memory module.

Configuration options: [Disabled] [Profile #1] [Profile #2]



To obtain the best performance of the X.M.P. 1600 DIMM, install only one DIMM on each memory channel. Refer to the table on the next page for X.M.P. DIMM installation recommendation.

X.M.P. DIMM Installation Recommendation

X.M.P. DIMM Frequency		1600 MHz	1600 MHz	1333 MHz	1333 MHz	1333 MHz
Sockets	DIMM_A1	√	-	√	-	√
	DIMM_B1	√	-	-	√	√
	DIMM_A2	-	√	√	-	√
	DIMM_B2	-	√	-	√	√

4.4.2 CPU Ratio Control [Auto]

Configuration options: [Auto] [Manual].

Ratio CMOS Setting [9]

This sub-item appears only when you set the **CPU Ratio Control** item to [Manual]. Allows you to set the ratio between CPU Core Clock and FSB Frequency. Use the <+> and <-> keys to adjust the ratio. If an invalid ratio is set in CMOS, then actual and setpoint values may differ.

4.4.3 FSB Strap to North Bridge [Auto]

When set to [Auto], the FSB Strap will be adjusted automatically by FSB Frequency and DRAM Frequency.

Configuration options: [Auto] [200MHz] [266MHz] [333MHz]



The following item appears only when you set the **Ai Overclock Tuner** item to [Manual].

FSB Frequency [XXX]

Displays the frequency sent by the clock generator to the system bus and PCI bus. The value of this item is auto-detected by the BIOS. Use the <+> and <-> keys to adjust the FSB frequency. You can also type the desired CPU frequency using the numeric keypad. The values range from 200 to 800. Refer to the table below for the correct Front Side Bus and CPU External Frequency settings.

FSB/CPU External Frequency Synchronization

Front Side Bus	FSB 1600	FSB 1333	FSB 1066	FSB 800
CPU External Frequency	400 MHz	333 MHz	266 MHz	200 MHz



The following item appears only when you set the **Ai Overclock Tuner** item to [Manual] and [X.M.P.].

PCIe Frequency [Auto]

Allows you to set the PCI Express frequency. Use the <+> and <-> keys to adjust the PCIe frequency. The values range from 100 to 150.

4.4.4 DRAM Frequency [Auto]

Allows you to set the DDR3 operating frequency.

Configuration options: [Auto] [DDR3-667 MHz] [DDR3-800 MHz] [DDR3-835MHz] [DDR3-887 MHz] [DDR3-1002MHz] [DDR3-1066MHz] [DDR3-1111] [DDR3-1333] [DDR3-*1600 MHz*] [DDR3-*1800 MHz*]



The **DRAM Frequency** configuration options vary with the **FSB Frequency** settings.



- Selecting a very high DRAM frequency may cause the system to become unstable! If this happens, revert to the default setting.
 - DDR3-667 help: DRAM frequency lower than 800 MHz may cause system boot failure due to spec violation.
-

4.4.5 DRAM Command Rate [Auto]

Configuration options: [Auto] [1T] [2T]

4.4.6 DRAM Timing Control [Auto]

Configuration options: [Auto] [Manual]



- The following sub-items appear only when you set the DRAM Timing Control item to [Manual].
 - The configuration options for some of the following items vary depending on the DIMMs you install on the motherboard.
-

Pri. Information: 6-6-6-15-4-36-6-4

The values vary depending on your settings of the following sub-items:

CAS# Latency [5 DRAM Clocks]

Configuration options: [5 DRAM Clocks] [6 DRAM Clocks] [7 DRAM Clocks] [8 DRAM Clocks] [9 DRAM Clocks] [10 DRAM Clocks] [11 DRAM Clocks]

RAS# to CAS# Delay [5 DRAM Clocks]

Configuration options: [3 DRAM Clocks] [4 DRAM Clocks]~[17 DRAM Clocks] [18 DRAM Clocks]

RAS# Precharge [5 DRAM Clocks]

Configuration options: [3 DRAM Clocks] [4 DRAM Clocks]~[17 DRAM Clocks] [18 DRAM Clocks]

RAS# Active Time [15 DRAM Clocks]

Configuration options: [3 DRAM Clocks] [4 DRAM Clocks]~[33 DRAM Clocks] [34 DRAM Clocks]

RAS# to RAS# Delay [Auto]

Configuration options: [Auto] [1 DRAM Clocks]~[15 DRAM Clocks]

Row Refresh Cycle Time [Auto]

Configuration options: [Auto] [30 DRAM Clocks] [36 DRAM Clocks]
[48 DRAM Clocks] [60 DRAM Clocks] [72 DRAM Clocks]

Write Recovery Time [Auto]

Configuration options: [Auto] [1 DRAM Clocks]~[15 DRAM Clocks]

Read to Precharge Time [Auto]

Configuration options: [Auto] [1 DRAM Clocks]~[15 DRAM Clocks]

Sec. Information: 8-4-6-4-7-4-7

The values vary depending on your settings of the following sub-items:

Read to Write Delay(S/D) [Auto]

Configuration options: [Auto] [1 DRAM Clocks]~[15 DRAM Clocks]

Write to Read Delay(S) [Auto]

Configuration options: [Auto] [1 DRAM Clocks]~[15 DRAM Clocks]

Write to Read Delay(D) [Auto]

Configuration options: [Auto] [1 DRAM Clocks]~[15 DRAM Clocks]

Read To Read Delay(S) [Auto]

Configuration options: [Auto] [1 DRAM Clocks]~[15 DRAM Clocks]

Read To Read Delay(D) [Auto]

Configuration options: [Auto] [1 DRAM Clocks]~[15 DRAM Clocks]

Write To Write Delay(S) [Auto]

Configuration options: [Auto] [1 DRAM Clocks]~[15 DRAM Clocks]

Write To Write Delay(D) [Auto]

Configuration options: [Auto] [1 DRAM Clocks]~[15 DRAM Clocks]

4.4.7 DRAM Static Read Control [Auto]

Configuration options: [Auto] [Disabled] [Enabled]

4.4.8 DRAM Dynamic Write Control [Auto]

Configuration options: [Auto] [Disabled] [Enabled]

4.4.9 Ai Clock Twister [Auto]

Set this item to [Light] to enhance DRAM compatibility, or [Strong] to enhance DRAM performance.

Configuration options: [Auto] [Moderate] [Light] [Strong]

4.4.10 Ai Clock Skew for Channel A [Auto]

Configuration options: [Auto] [Advance 350ps] [Advance 300ps] [Advance 250ps] [Advance 200ps] [Advance 150ps] [Advance 100ps] [Advance 50ps] [Normal] [Delay 50ps] [Delay 100ps] [Delay 150ps] [Delay 200ps] [Delay 250ps] [Delay 300ps] [Delay 350ps]

4.4.11 Ai Clock Skew for Channel B [Auto]

Configuration options: [Auto] [Advance 350ps] [Advance 300ps] [Advance 250ps] [Advance 200ps] [Advance 150ps] [Advance 100ps] [Advance 50ps] [Normal] [Delay 50ps] [Delay 100ps] [Delay 150ps] [Delay 200ps] [Delay 250ps] [Delay 300ps] [Delay 350ps]

4.4.12 Ai Transaction Booster [Auto]

Configuration options: [Auto] [Disabled] [Enabled]

Relax Level [1]

This sub-item appears only when you set the **Transaction Booster** item to [Disabled]. Set this item to a higher level to get better compatibility. Use the <+> and <-> keys to adjust the value. The values range from 1 to 8.

Boost Level [1]

This sub-item appears only when you set the **Transaction Booster** item to [Enabled]. Set this item to a higher level to get better performance. Use the <+> and <-> keys to adjust the value. The values range from 1 to 8.



The following seven items appear only when you set the **Ai Overclock Tuner** item to [Manual] and [X.M.P.] and are adjusted by typing the desired values using the numeric keypad and press the <Enter> key. Use the <+> and <-> keys to adjust the value. To restore the default setting, type [auto] using the keyboard and press the <Enter> key.

CPU Voltage [Auto]

Allows you to set the CPU VCore voltage. The values range from 1.10000V to 1.70000V with a 0.00625V interval.



Refer to the CPU documentation before setting the CPU Vcore voltage. Setting a high VCore voltage may damage the CPU permanently, and setting a low VCore voltage may make the system unstable.

CPU PLL Voltage [Auto]

Allows you to set the CPU PLL voltage. The values range from 1.50V to 2.78V with a 0.02V interval.

FSB Termination Voltage [Auto]

Allows you to set the front side bus termination voltage. The values range from 1.20V to 1.50V with a 0.02V interval.

DRAM Voltage [Auto]

Allows you to set the DRAM voltage. The values range from 1.50V to 2.78V with a 0.02V interval.

North Bridge Voltage [Auto]

Allows you to set the North Bridge voltage. The values range from 1.25V to 1.91V with a 0.02V interval.



- Setting the CPU PLL Voltage, FSB Termination Voltage, DRAM Voltage and North Bridge Voltage to a high level may damage the chipset, memory module, and CPU permanently. Proceed with caution.
- Some values of the CPU PLL Voltage, FSB Termination Voltage, DRAM Voltage and North Bridge Voltage items are labeled in different color, indicating the risk levels of high voltage settings. Refer to the table below for details.
- The system may need better cooling system to work stably under high voltage settings.

	Blue	Yellow	Purple	Red
CPU PLL Voltage	1.50V~1.78V	1.80V~2.00V	2.02V~2.20V	2.22V~2.78V
FSB Termination Voltage	1.20V~1.38V	1.40V~1.50V	N/A	N/A
DRAM Voltage	1.50V~1.68V	1.70V~1.90V	1.92V~2.10V	2.12V~2.78V
North Bridge Voltage	1.25V~1.41V	1.43V~1.55V	1.57V~1.73V	1.75V~1.91V

South Bridge Voltage [Auto]

Allows you to set the South Bridge voltage. The values range from 1.05V to 1.20V with a 0.15V interval.

Clock Over-Charging Voltage [Auto]

Allows you to set the Clock Over-Charging voltage. The values range from 0.70V to 1.00V with a 0.10V interval.



The following three items appear when you set the **Ai Overclock Tuner** item to [Manual] and [X.M.P].

CPU Voltage Damper [Auto]

Allows you to enable or disable the CPU voltage damper.

Configuration options: [Auto] [Disabled] [Enabled]

CPU Voltage Reference [Auto]

Configuration options: [Auto] [0.63x] [0.61x] [0.59x] [0.57x]

North Bridge Voltage Reference [Auto]

Configuration options: [Auto] [0.67x] [0.61x]

4.4.13 CPU Spread Spectrum [Auto]

Allows you to disable or set to auto the CPU clock spread spectrum.

Configuration options: [Auto] [Disabled]

4.4.14 PCIE Spread Spectrum [Auto]

Allows you to disable or set to auto the PCI Express clock spread spectrum.

Configuration options: [Auto] [Disabled]

4.5 Advanced menu

The Advanced menu items allow you to change the settings for the CPU and other system devices.



Take caution when changing the settings of the Advanced menu items. Incorrect field values can cause the system to malfunction.

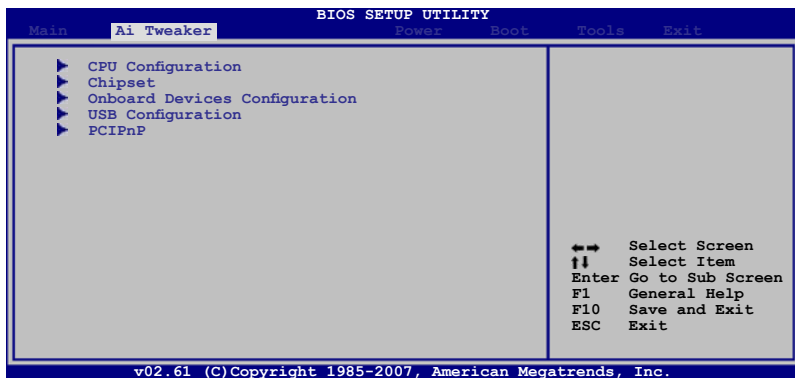

4.5.1 CPU Configuration

The items in this menu show the CPU-related information that the BIOS automatically detects.

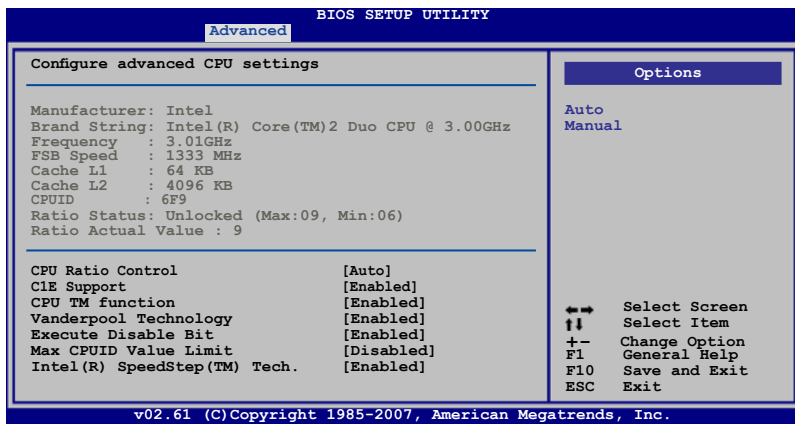

CPU Ratio Control [Auto]

Configuration options: [Auto] [Manual]



The following item appears when the item **CPU Ratio Control** is set to [Manual].

Ratio CMOS Setting: [9]

Allows you to set the ratio between the CPU Core Clock and the FSB Frequency. Use <+> and <-> to adjust the value.

Configuration options: [6] [7] [8] [9]

C1E Support [Enabled]

Allows you to enable or disable C1E Support.

Configuration options: [Disabled] [Enabled]

CPU TM function [Enabled]

Configuration options: [Disabled] [Enabled]

Vanderpool Technology [Enabled]

Configuration options: [Disabled] [Enabled]

Execute Disable Bit [Enabled]

Allows you to enable or disable the No-Execution Page Protection Technology. Setting this item to [Disabled] forces the XD feature flag to always return to zero (0). Configuration options: [Disabled] [Enabled]

Max CPUID Value Limit [Disabled]

Setting this item to [Enabled] allows legacy operating systems to boot even without support for CPUs with extended CPUID functions.

Configuration options: [Disabled] [Enabled]



The following item appears only when you set the **CPU Ratio Control** item to [Auto].

Intel(R) SpeedStep (TM) Tech. [Enabled]

Configuration options: [Disabled] [Enabled]

4.5.2 Chipset

The Chipset menu allows you to change the advanced chipset settings. Select an item then press <Enter> to display the sub-menu.

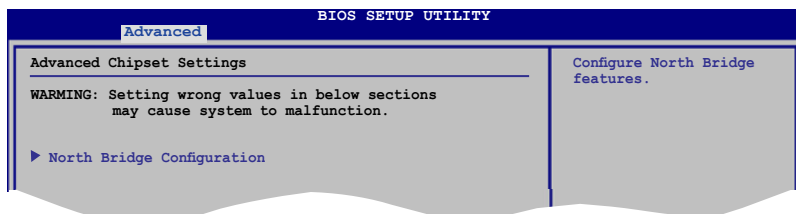

North Bridge Chipset Configuration

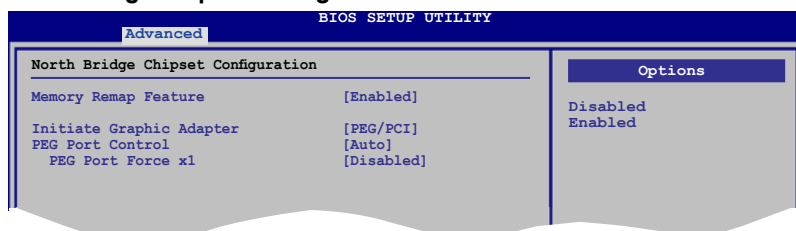

Memory Remap Feature [Disabled]

Allows you to enable or disable the remapping of the overlapped PCI memory above the total physical memory. Enable this option only when you install 64-bit operating system. Configuration options: [Disabled] [Enabled]

Initiate Graphic Adapter [PEG/PCI]

Allows you to decide which graphics controller to use as the primary boot device. Configuration options: [PCI/PEG] [PEG/PCI]

PEG Port Control [Auto]

Configuration options: [Auto] [Disabled]



The following item appears only when you set **PEG Port Control** to [Auto]

PEG Port Force x1 [Disabled]

Configuration options: [Enabled] [Disabled]

4.5.3 Onboard Device Configuration

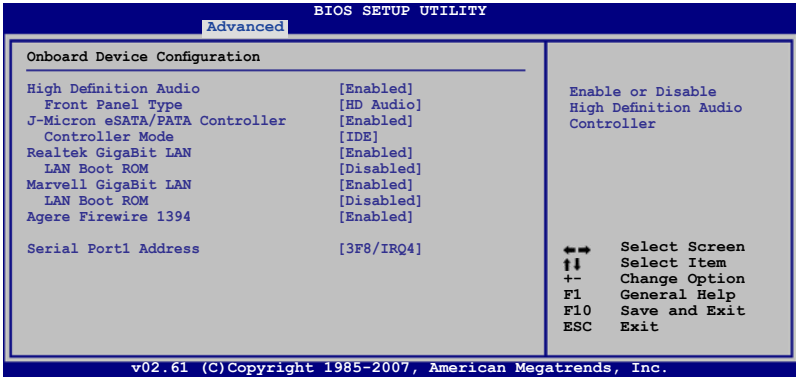

High Definition Audio [Enabled]

Allows you to enable or disable the High Definition Audio Controller.
Configuration options: [Enabled] [Disabled]

Front Panel Type [HD Audio]

Allows you to set the front panel audio connector (AAFP) mode to legacy AC'97 or high-definition audio depending on the audio standard that the front panel audio module supports. Configuration options: [AC97] [HD Audio]

J-Micron eSATA/PATA Controller [Enabled]

Configuration options: [Enabled] [Disabled]

Controller Mode [IDE]

Configuration options: [RAID] [IDE] [AHC]

Realtek GigaBit LAN [Enabled]

Configuration options: [Enabled] [Disabled]

LAN Boot ROM [Disabled]

Configuration options: [Disabled] [Enabled]

Marvell GigaBit LAN [Enabled]

Configuration options: [Enabled] [Disabled]

LAN Boot ROM [Disabled]

Configuration options: [Disabled] [Enabled]

Agere Firewire 1394 [Enabled]

Configuration options: [Enabled] [Disabled]

Serial Port1 Address [3F8/IRQ4]

Allows you to select the Serial Port1 base address.
Configuration options: [Disabled] [3F8/IRQ4] [2F8/IRQ3] [3E8/IRQ4] [2E8/IRQ3]

4.5.4 USB Configuration

The items in this menu allows you to change the USB-related features. Select an item then press <Enter> to display the configuration options.

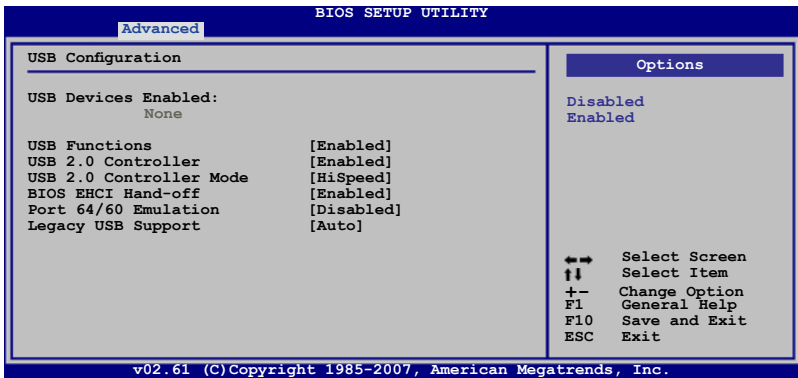

The **USB Devices Enabled** item shows the auto-detected values. If no USB device is detected, the item shows **None**.

USB Functions [Enabled]

Allows you to enable or disable the USB Host Controllers.

Configuration options: [Disabled] [Enabled]



The following items appear only when you set **USB Functions** to [Enabled].

USB 2.0 Controller [Enabled]

Allows you to enable or disable the USB 2.0 controller.

Configuration options: [Enabled] [Disabled]

USB 2.0 Controller Mode [HiSpeed]

Allows you to set the USB 2.0 controller mode to HiSpeed (480 Mbps) or

FullSpeed (12 Mbps). Configuration options: [FullSpeed] [HiSpeed]



The **USB 2.0 Controller Mode** item appears only when you enable the **USB 2.0 Controller**.

BIOS EHCI Hand-off [Enabled]

Allows you to enable the support for operating systems without an EHCI hand-off feature. Configuration options: [Disabled] [Enabled]

Port 64/60 Emulation [Disabled]

Allows you to enable or disable the I/O port 60h/64h emulation support. This item should be enabled for the complete USB keyboard legacy support for non-USB aware OSes. Configuration options: [Disabled] [Enabled]

Legacy USB Support [Auto]

Allows you to enable or disable the support for legacy USB devices. Setting to [Auto] allows the system to detect the presence of USB devices at startup. If detected, the USB controller legacy mode is enabled. If no USB device is detected, the legacy USB support is disabled.

Configuration options: [Disabled] [Enabled] [Auto]

4.5.5 PCIPnP

The PCIPnP menu items allow you to change the advanced settings for PCI/PnP devices.



Take caution when changing the settings of the PCIPnP menu items. Incorrect field values can cause the system to malfunction.

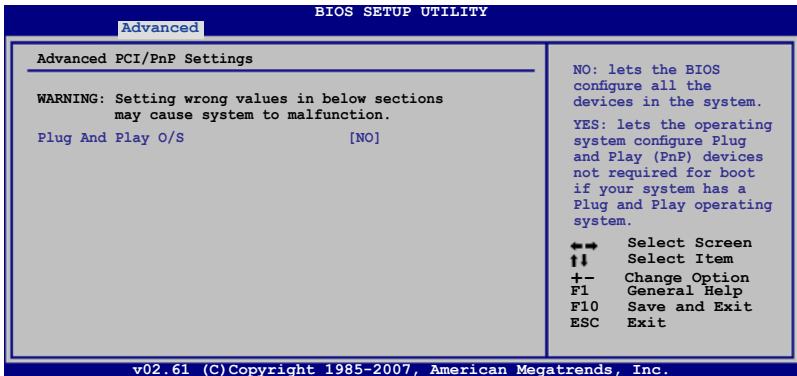

Plug And Play O/S [NO]

When set to [NO], BIOS configures all the devices in the system. When set to [YES] and if you install a Plug and Play operating system, the operating system configures the Plug and Play devices not required for boot.

Configuration options: [NO] [YES]

4.6 Power menu

The Power menu items allow you to change the settings for the Advanced Power Management (APM). Select an item then press <Enter> to display the configuration options.

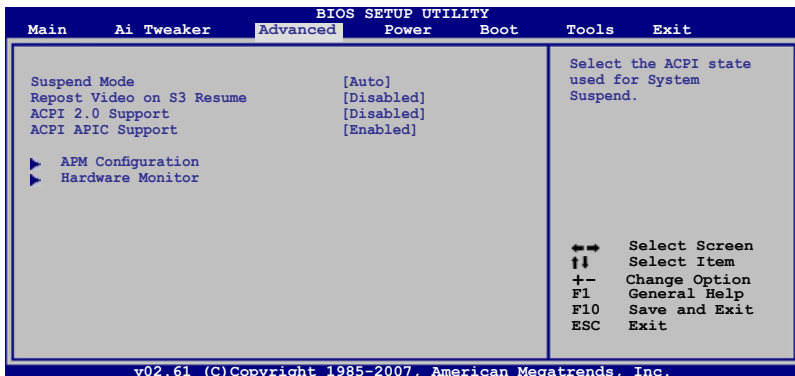

4.6.1 Suspend Mode [Auto]

Allows you to select the Advanced Configuration and Power Interface (ACPI) state to be used for system suspend.

Configuration options: [S1 (POS) Only] [S3 Only] [Auto]

4.6.2 Repost Video on S3 Resume [Disabled]

Determines whether to invoke VGA BIOS POST on S3/STR resume.

Configuration options: [Disabled] [Enabled]

4.6.3 ACPI 2.0 Support [Disabled]

Add additional tables as per ACPI 2.0 specifications.

Configuration options: [Disabled] [Enabled]

4.6.4 ACPI APIC Support [Enabled]

Allows you to enable or disable the Advanced Configuration and Power Interface (ACPI) support in the Advanced Programmable Interrupt Controller (APIC). When set to [Enabled], the ACPI APIC table pointer is included in the RSDT pointer list.

Configuration options: [Disabled] [Enabled]

4.6.5 APM Configuration

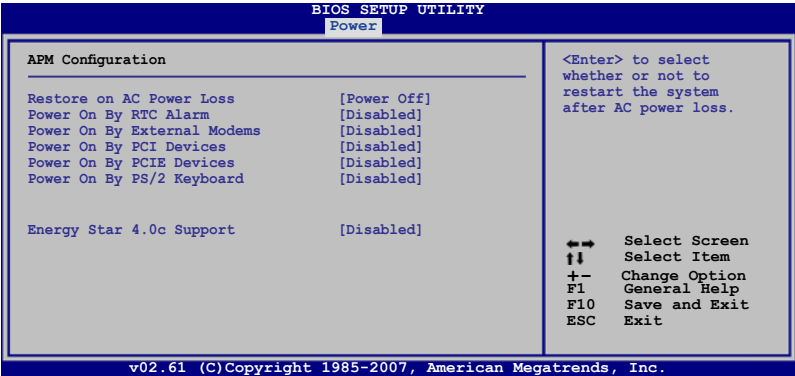

Restore On AC Power Loss [Power Off]

When set to [Power Off], the system goes into off state after an AC power loss. When set to [Power On], the system goes on after an AC power loss. When set to [Last State], the system goes into either off or on state, whatever the system state was before the AC power loss.

Configuration options: [Power Off] [Power On] [Last State]

Power On By RTC Alarm [Disabled]

Allows you to enable or disable RTC to generate a wake event. When this item is set to [Enabled], the items **RTC Alarm Date/ RTC Alarm Hour/ RTC Alarm Minute/ RTC Alarm Second** will become user-configurable with set values.

Configuration options: [Disabled] [Enabled]

Power On By External Modems [Disabled]

This allows either settings of [Enabled] or [Disabled] for powering up the computer when the external modem receives a call while the computer is in Soft-off mode.

Configuration options: [Disabled] [Enabled]



The computer cannot receive or transmit data until the computer and applications are fully running. Thus, connection cannot be made on the first try. Turning an external modem off and then back on while the computer is off causes an initialization string that turns the system power on.

Power On By PCI Devices [Disabled]

Allows you to enable or disable the PME to wake up from S5 by PCI devices.

Configuration options: [Disabled] [Enabled]

Power On By PCIE Devices [Disabled]

Allows you to enable or disable the PCIE devices to generate a wake event.

Configuration options: [Disabled] [Enabled]

Power On By PS/2 Keyboard [Disabled]

Allows you to disable the Power On by PS/2 keyboard function or set specific keys on the PS/2 keyboard to turn on the system. This feature requires an ATX power supply that provides at least 1A on the +5VSB lead.

Configuration options: [Disabled] [Space Bar] [Ctrl-Esc] [Power Key]

Energy Star 4.0c Support [Disabled]

Setting this item to [Enabled] to pass Energy Star 4.0c rating. When enabled, S3-PS/2 & USB wake-up functions will be closed, and S4/S5-Marvell LAN, PS/2 & USB devices wake-up functions will be closed.

Configuration options: [Enabled] [Disabled]

4.6.6 Hardware Monitor

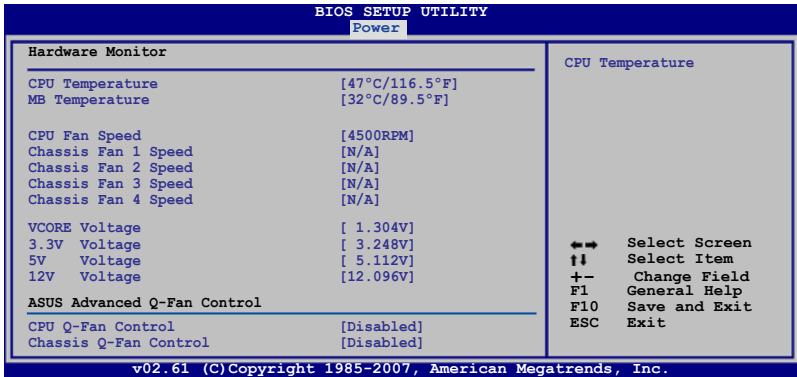

CPU Temperature [xxx°C/xxx°F]

MB Temperature [xxx°C/xxx°F]

The onboard hardware monitor automatically detects and displays the motherboard and CPU temperatures. Select [Ignored] if you do not wish to display the detected temperatures.

CPU Fan Speed [xxxxRPM] or [Ignored] / [N/A]

The onboard hardware monitor automatically detects and displays the CPU fan speed in rotations per minute (RPM). If the fan is not connected to the motherboard, the field shows [N/A].

Chassis Fan 1/2/3/4 Speed [xxxxRPM] or [Ignored] / [N/A]

The onboard hardware monitor automatically detects and displays the chassis fan speed in rotations per minute (RPM). If the fan is not connected to the motherboard, the field shows [N/A].

VCORE Voltage, 3.3V Voltage, 5V Voltage, 12V Voltage

The onboard hardware monitor automatically detects the voltage output through the onboard voltage regulators. Select [Ignored] if you do not want to detect this item.

CPU Q-Fan Control [Disabled]

Allows you to enable or disable the CPU Q-fan.

Configuration options: [Disabled] [Enabled]



The following item appears only when you enable CPU Q-Fan Control.

CPU Fan Profile [Optimal]

Allows you to set the appropriate performance level of the ASUS Q-Fan. When set to [Optimal], the CPU fan automatically adjusts depending on the CPU temperature. Set this item to [Silent Mode] to minimize fan speed for quiet CPU fan operation, or [Performance Mode] to achieve maximum CPU fan speed.

Configuration options: [Optimal] [Silent Mode] [Performance Mode]

Chassis Q-Fan Controls [Disabled]

Allows you to enable or disable the Chassis Q-fan.

Configuration options: [Disabled] [Enabled]



The following items appear only when you enable Chassis Q-Fan Control.

Chassis Fan Ratio [Auto]

Allows you to select a fan speed ratio in the low CPU temperature.

Configuration options [Auto] [90%] [80%] [70%] [60%]



A very low fan speed ratio may cause fan speed drop and trigger the hardware monitor warning message.

Chassis Target Temperature [37°C]

Chassis fan speed will auto-adjust to reach this target temperature.

Configuration options: [28°C] [31°C] [34°C] [37°C] [40°C] [43°C] [46°C]

4.7 Boot menu

The Boot menu items allow you to change the system boot options. Select an item then press <Enter> to display the sub-menu.

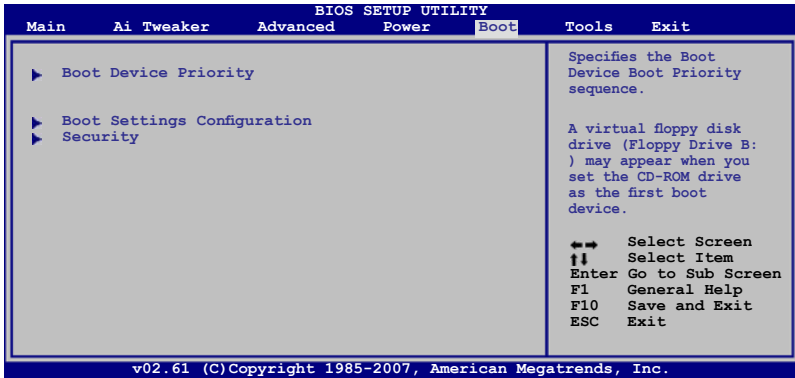

4.7.1 Boot Device Priority

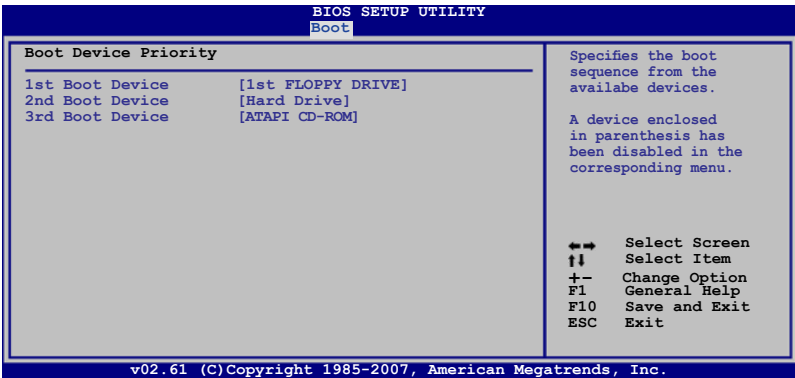

1st ~ xxth Boot Device [xxx Drive]

These items specify the boot device priority sequence from the available devices. The number of device items that appears on the screen depends on the number of devices installed in the system. Configuration options: [1st FLOPPY DRIVE] [Hard Drive] [ATAPI CD-ROM] [Disabled]

4.7.2 Boot Settings Configuration

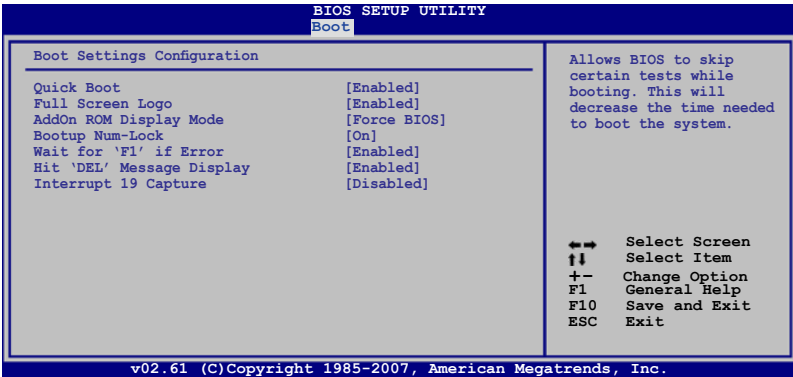

Quick Boot [Enabled]

Enabling this item allows the BIOS to skip some power on self tests (POST) while booting to decrease the time needed to boot the system. When set to [Disabled], BIOS performs all the POST items. Configuration options: [Disabled] [Enabled]

Full Screen Logo [Enabled]

This allows you to enable or disable the full screen logo display feature. Configuration options: [Disabled] [Enabled]



Set this item to [Enabled] to use the ASUS MyLogo3™ feature.

AddOn ROM Display Mode [Force BIOS]

Sets the display mode for option ROM. Configuration options: [Force BIOS] [Keep Current]

Bootup Num-Lock [On]

Allows you to select the power-on state for the NumLock. Configuration options: [Off] [On]

Wait for 'F1' If Error [Enabled]

When set to [Enabled], the system waits for the <F1> key to be pressed when error occurs. Configuration options: [Disabled] [Enabled]

Hit 'DEL' Message Display [Enabled]

When set to [Enabled], the system displays the message "Press DEL to run Setup" during POST. Configuration options: [Disabled] [Enabled]

Interrupt 19 Capture [Disabled]

When set to [Enabled], this function allows the option ROMs to trap Interrupt 19. Configuration options: [Disabled] [Enabled]

4.7.3 Security

The Security menu items allow you to change the system security settings. Select an item then press <Enter> to display the configuration options.

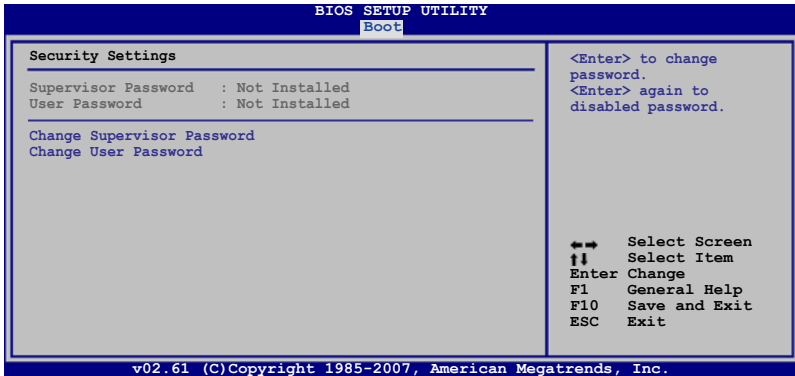

Change Supervisor Password

Select this item to set or change the supervisor password. The **Supervisor Password** item on top of the screen shows the default **Not Installed**. After you set a password, this item shows **Installed**.

To set a Supervisor Password:

1. Select the **Change Supervisor Password** item and press <Enter>.
2. From the password box, type a password composed of at least six letters and/or numbers, then press <Enter>.
3. Confirm the password when prompted.

The message "Password Installed" appears after you successfully set your password.

To change the supervisor password, follow the same steps as in setting a user password.

To clear the supervisor password, select the **Change Supervisor Password** then press <Enter>. The message "Password Uninstalled" appears.



If you forget your BIOS password, you can clear it by erasing the CMOS Real Time Clock (RTC) RAM. See section **2.6 Jumper** for information on how to erase the RTC RAM.

After you have set a supervisor password, the other items appear to allow you to change other security settings.

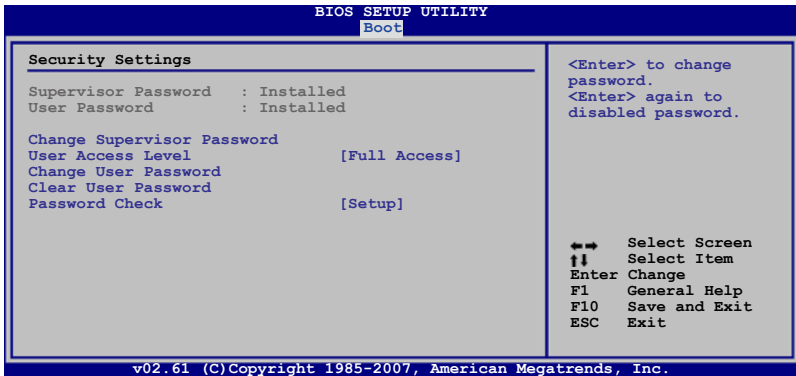

User Access Level [Full Access]

This item allows you to select the access restriction to the Setup items.
 Configuration options: [No Access] [View Only] [Limited] [Full Access]

- [No Access] prevents user access to the Setup utility.
- [View Only] allows access but does not allow change to any field.
- [Limited] allows changes only to selected fields, such as Date and Time.
- [Full Access] allows viewing and changing all the fields in the Setup utility.

Change User Password

Select this item to set or change the user password. The **User Password** item on top of the screen shows the default **Not Installed**. After you set a password, this item shows Installed.

To set a User Password:

1. Select the **Change User Password** item and press <Enter>.
2. On the password box that appears, type a password composed of at least six letters and/or numbers, then press <Enter>.
3. Confirm the password when prompted.

The message "Password Installed" appears after you set your password successfully.

To change the user password, follow the same steps as in setting a user password.

Clear User Password

Select this item to clear the user password.

Password Check [Setup]

When set to [Setup], BIOS checks for user password when accessing the Setup utility. When set to [Always], BIOS checks for user password both when accessing Setup and booting the system. Configuration options: [Setup] [Always]

4.8 Tools menu

The Tools menu items allow you to configure options for special functions. Select an item then press <Enter> to display the sub-menu.

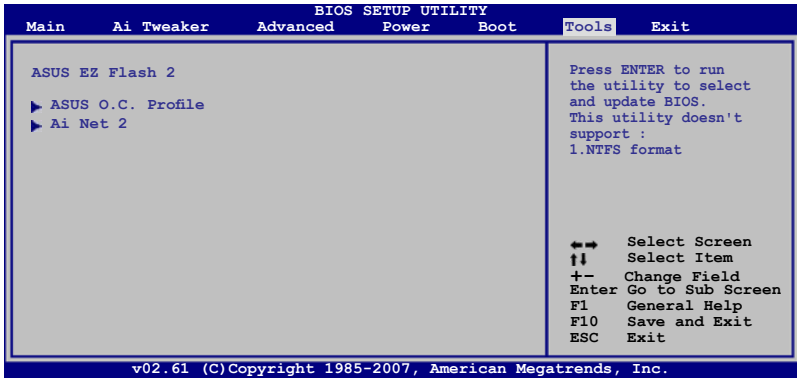

4.8.1 ASUS EZ Flash 2

Allows you to run ASUS EZ Flash 2. When you press <Enter>, a confirmation message appears. Use the left/right arrow key to select between [Yes] or [No], then press <Enter> to confirm your choice. Please see page 4-4, section 4.1.2 for details.

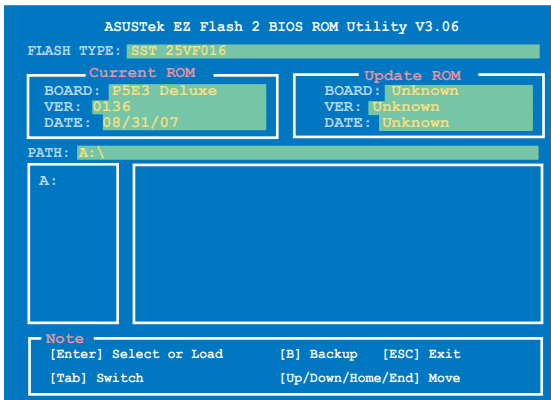

4.8.2 ASUS O.C. Profile

This item allows you to store or load multiple BIOS settings.

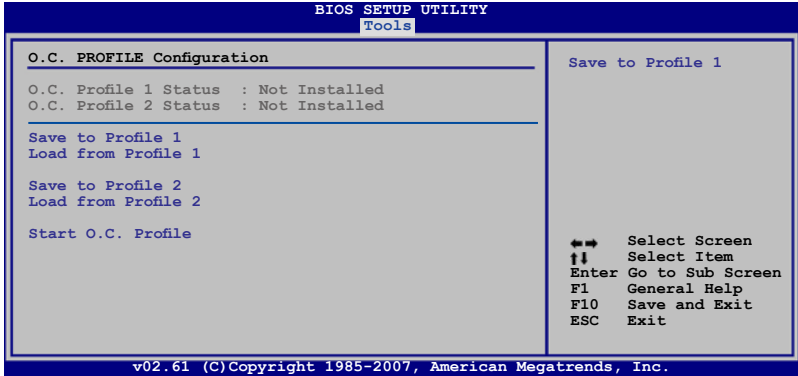

Save to Profile 1/2

Allows you to save the current BIOS file to the BIOS Flash. Press <Enter> to save the file.

Load from Profile 1/2

Allows you to load the previous BIOS settings saved in the BIOS Flash. Press <Enter> to load the file.

Start O.C. Profile

Allows you to run the utility to save and load CMOS. Press <Enter> to run the utility.

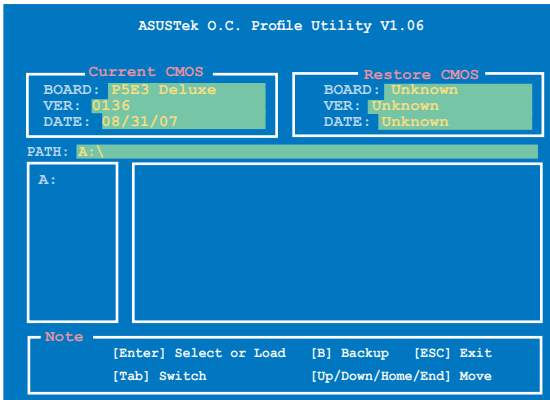

- This function can support devices such as a USB flash disk or a floppy disk with FAT 32/16 format and single partition only.
- DO NOT shut down or reset the system while updating the BIOS to prevent the system boot failure!

4.8.3 Ai Net 2

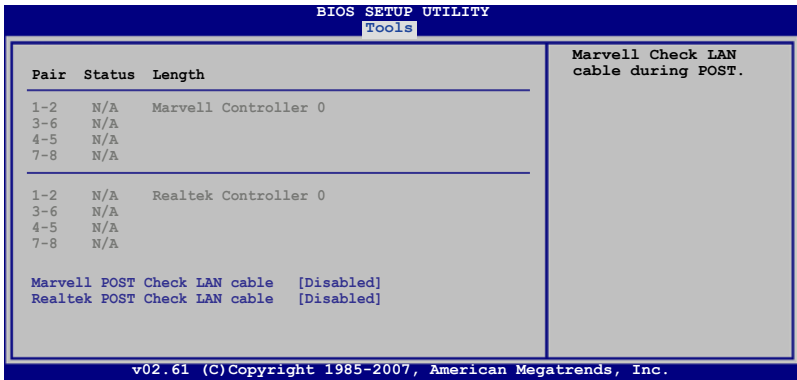

Marvell POST Check LAN Cable [Disabled]

Enables or disables checking of the Marvell LAN cable during the Power-On Self-Test (POST). Configuration options: [Disabled] [Enabled]

Realtek POST Check LAN Cable [Disabled]

Enables or disables checking of the Realtek LAN cable during the Power-On Self-Test (POST). Configuration options: [Disabled] [Enabled]

4.9 Exit menu

The Exit menu items allow you to load the optimal or failsafe default values for the BIOS items, and save or discard your changes to the BIOS items.

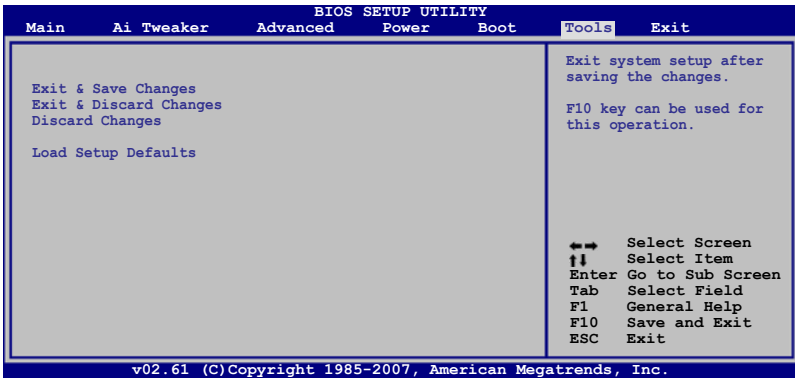

Pressing <Esc> does not immediately exit this menu. Select one of the options from this menu or <F10> from the legend bar to exit.

Exit & Save Changes

Once you are finished making your selections, choose this option from the Exit menu to ensure the values you selected are saved to the CMOS RAM. An onboard backup battery sustains the CMOS RAM so it stays on even when the PC is turned off. When you select this option, a confirmation window appears. Select **Ok** to save changes and exit.



If you attempt to exit the Setup program without saving your changes, the program prompts you with a message asking if you want to save your changes before exiting. Press <Enter> to save the changes while exiting.

Exit & Discard Changes

Select this option only if you do not want to save the changes that you made to the Setup program. If you made changes to fields other than System Date, System Time, and Password, the BIOS asks for a confirmation before exiting.

Discard Changes

This option allows you to discard the selections you made and restore the previously saved values. After selecting this option, a confirmation appears. Select **Ok** to discard any changes and load the previously saved values.

Load Setup Defaults

This option allows you to load the default values for each of the parameters on the Setup menus. When you select this option or if you press <F5>, a confirmation window appears. Select **Ok** to load default values. Select **Exit & Save Changes** or make other changes before saving the values to the non-volatile RAM.

This chapter describes the contents of the support DVD that comes with the motherboard package and the softwares.

5 Software support

5.1	Installing an operating system	5-1
5.2	Support DVD information	5-1
5.3	Software information	5-9
5.4	RAID configurations	5-36
5.5	Creating a RAID driver disk.....	5-53

5.1 Installing an operating system

This motherboard supports Windows® XP/ 64-bit XP/ Vista™ operating systems (OS). Always install the latest OS version and corresponding updates to maximize the features of your hardware.



- Motherboard settings and hardware options vary. Use the setup procedures presented in this chapter for reference only. Refer to your OS documentation for detailed information.
- Make sure that you install the Windows® XP Service Pack2 or later versions before installing the drivers for better compatibility and system stability.

5.2 Support DVD information

The support DVD that came with the motherboard package contains the drivers, software applications, and utilities that you can install to avail all motherboard features.



The contents of the support DVD are subject to change at any time without notice. Visit the ASUS website(www.asus.com) for updates.

5.2.1 Running the support DVD

Place the support DVD to the optical drive. The DVD automatically displays the Drivers menu if Autorun is enabled in your computer.



Click an icon to display support DVD/ motherboard information

Click an item to install



If Autorun is NOT enabled in your computer, browse the contents of the support DVD to locate the file ASSETUP.EXE from the BIN folder. Double-click the ASSETUP.EXE to run the DVD.

5.2.2 Drivers menu

The Drivers menu shows the available device drivers if the system detects installed devices. Install the necessary drivers to activate the devices.

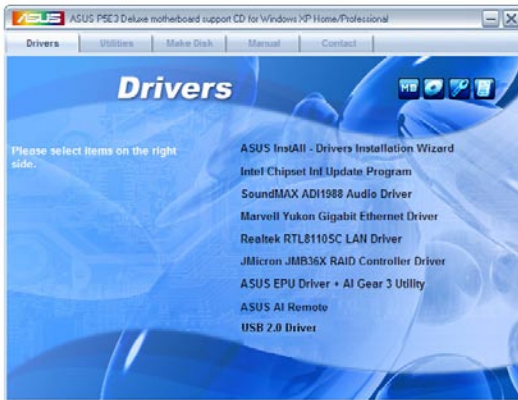

ASUS InstAll-Drivers Installation Wizard

Installs all of the drivers through the Installation Wizard.

Intel Chipset Inf Update Program

Installs the Intel® chipset Inf update program.

SoundMAX ADI1988 Audio Driver

Installs the SoundMAX® ADI1988 audio driver and application.

Marvell Yukon Gigabit Ethernet Driver

Installs the Marvell® Yukon Gigabit Ethernet driver.

Realtek RTL8110SC LAN Driver

Installs the Realtek® RTL8110SC LAN driver.

JMicro JMB36X RAID Controller Driver

Installs the JMicro® JMB36X RAID controller driver.

ASUS EPU Driver + AI Gear 3 Utility

Installs the ASUS EPU driver and AI Gear 3 utility.

ASUS AI Remote

Installs the ASUS AI Remote driver.

USB 2.0 Driver

Installs the USB 2.0 driver.

5.2.3 Utilities menu

The Utilities menu shows the applications and other software that the motherboard supports.

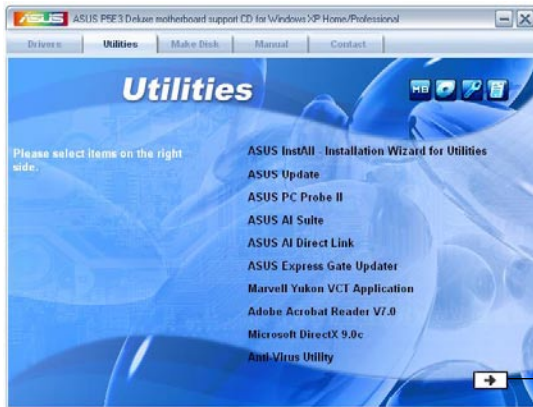

ASUS InstAll-Installation Wizard for Utilities

Installs all of the utilities through the Installation Wizard.

ASUS Update

The ASUS Update utility allows you to update the motherboard BIOS in Windows® environment. This utility requires an Internet connection either through a network or an Internet Service Provider (ISP).

ASUS PC Probe II

This smart utility monitors the fan speed, CPU temperature, and system voltages, and alerts you of any detected problems. This utility helps you keep your computer in healthy operating condition.

ASUS AI Suite

The ASUS AI Suite is an innovative application to do overclocking, fan control, power saving and quiet thermal control.

ASUS AI Direct Link

The ASUS AI Direct Link provides up to 70% transferring speed improvement when compared to traditional USB 2.0 and is the easiest and fastest way for users to enjoy large-sized data exchange of files such as movies, music, etc

Marvell Yukon VCT Application

Installs the Marvell® Yukon Virtual Cable Tester™ (VCT) application that diagnoses and reports LAN cable faults and shorts using the Time Domain Reflectometry (TDR) technology.

ADOBE Acrobat Reader V7.0

Installs the Adobe® Acrobat® Reader that allows you to open, view, and print documents in Portable Document Format (PDF).

Microsoft DirectX 9.0c

Installs the Microsoft® DirectX 9.0c driver. The Microsoft DirectX® 9.0c is a multimedia technology that enhances computer graphics and sound. DirectX® improves the multimedia features of your computer so you can enjoy watching TV and movies, capturing videos, or playing games in your computer. Visit the Microsoft website (www.microsoft.com) for updates.

Anti-Virus Utility

The anti-virus application scans, identifies, and removes computer viruses. View the online help for detailed information.

InterVideo MediaOne Gallery

Installs the media library and all-in-one software.

WinDVD Copy5 Trial

Installs the WinDVD Copy5 trial version.

Ulead PhotoImpact 12 SE

Installs the PhotoImpact image editing software.

CyberLink PowerBackup

Installs CyberLink PowerBackup to back up and restore your data easily.

Corel Snapfire Plus SE

Installs Corel Snapfire Plus SE.

5.2.4 Make disk menu

The Make disk menu contains items to create the Intel ICH9 or JMicron® JMB36X RAID/AHCI driver disk.



Make Intel ICH9 32/64bit RAID/AHCI Driver Disk

Allows you to create an ICH9 32/64bit RAID/AHCI driver disk.

Make JMicron JMB36X 32/64bit RAID/AHCI Driver

Allows you to create a JMicron® JMB36X 32/64bit RAID/AHCI driver.

5.2.5 Manual menu

The Manual menu contains a list of supplementary user manuals. Click an item to open the folder of the user manual.



Most user manual files are in Portable Document Format (PDF). Install the Adobe® Acrobat® Reader from the Utilities menu before opening a user manual file.

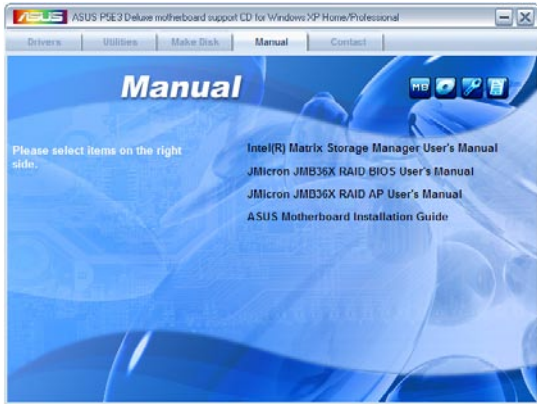

5.2.6 ASUS Contact information

Click the Contact tab to display the ASUS contact information. You can also find this information on the inside front cover of this user guide.

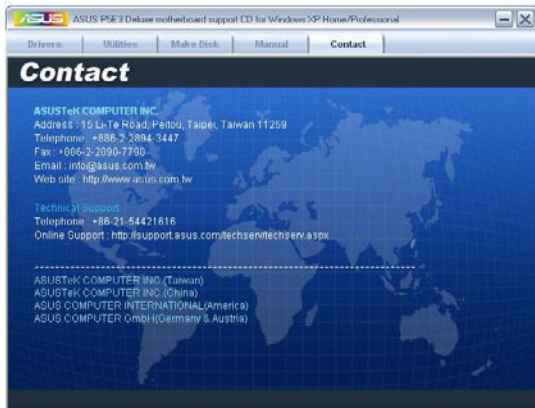

5.2.7 Other information

The icons on the top right corner of the screen give additional information on the motherboard and the contents of the support DVD. Click an icon to display the specified information.

Motherboard Info

Displays the general specifications of the motherboard.

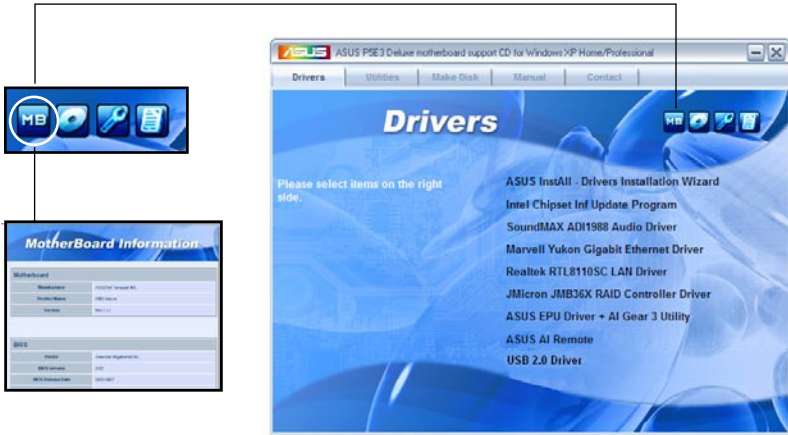

Browse this DVD

Displays the support DVD contents in graphical format.

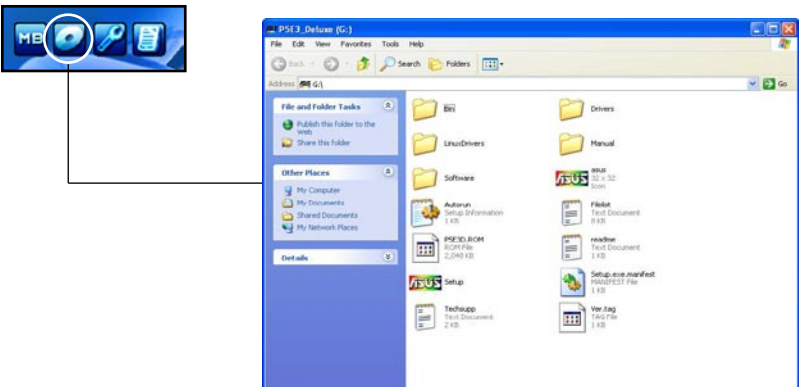

Technical support Form

Displays the ASUS Technical Support Request Form that you have to fill out when requesting technical support.

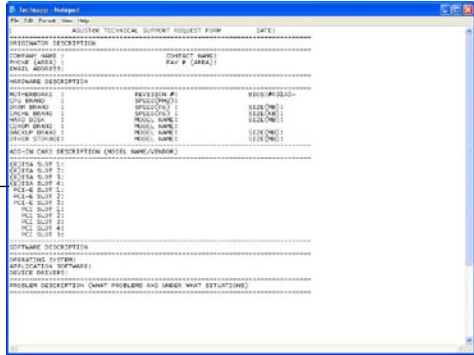

Filelist

Displays the contents of the support DVD in text format.



5.3 Software information

Most of the applications in the support DVD have wizards that will conveniently guide you through the installation. View the online help or readme file that came with the software application for more information.

5.3.1 ASUS MyLogo3™

The ASUS MyLogo3™ utility lets you customize the boot logo. The boot logo is the image that appears on screen during the Power-On-Self-Tests (POST). The ASUS MyLogo3™ is automatically installed when you install the ASUS Update utility from the support DVD. See section 5.2.3 **Utilities menu** for details.



- Before using the ASUS MyLogo3™, use the AFUDOS utility to make a copy of your original BIOS file, or obtain the latest BIOS version from the ASUS website. See section 4.1.3 **AFUDOS utility**.
- Make sure that the BIOS item Full Screen Logo is set to [Enabled] if you wish to use ASUS MyLogo3. See section 4.7.2 **Boot Settings Configuration**.
- You can create your own boot logo image in GIF, JPG, or BMP file formats.

To launch the ASUS MyLogo3™:

1. Launch the ASUS Update utility. Refer to section 4.1.1 **ASUS Update utility** for details.
2. Select **Options** from the drop down menu, then click **Next**.
3. Check the option **Launch MyLogo** to replace system boot logo before flashing BIOS, then click **Next**.
4. Select **Update BIOS from a file** from the drop down menu, then click **Next**.
5. When prompted, locate the new BIOS file, then click **Next**. The ASUS MyLogo3 window appears.
6. From the left window pane, select the folder that contains the image you intend to use as your boot logo.



- 7. When the logo images appear on the right window pane, select an image to enlarge by clicking on it.



- 8. Adjust the boot image to your desired size by selecting a value on the Ratio box.



- 9. When the screen returns to the ASUS Update utility, flash the original BIOS to load the new boot logo.
- 10. After flashing the BIOS, restart the computer to display the new boot logo during POST.

5.3.2 AI NET2

The AI NET2 features the Marvell® Virtual Cable Tester™ (VCT). VCT is a cable diagnostic utility that reports LAN cable faults and shorts using the Time Domain Reflectometry (TDR) technology. The VCT detects and reports open and shorted cables, impedance mismatches, pair swaps, pair polarity problems, and pair skew problems of up to 64 ns at one meter accuracy.

The VCT feature reduces networking and support costs through a highly manageable and controlled network system. This utility can be incorporated in the network systems software for ideal field support as well as development diagnostics.

Using the Virtual Cable Tester™

To use the the Marvell® Virtual Cable Tester™ utility:

1. Launch the VCT utility from the Windows® desktop by clicking **Start > All Programs > Marvell > Virtual Cable Tester**.
2. Click **Virtual Cable Tester** from the menu to display the screen below.

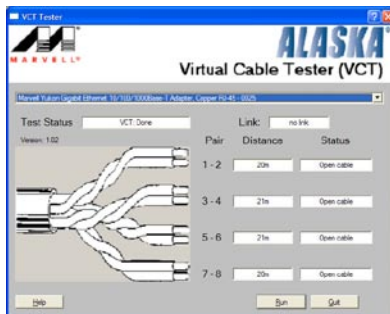

3. Click the **Run** button to perform a cable test.



- The VCT utility only tests Ethernet cables connected to Gigabit LAN port(s).
- The Run button on the Virtual Cable Tester™ main window is disabled if no problem is detected on the LAN cable(s) connected to the LAN port(s).
- If you want the system to check the status of the LAN cable before entering the OS, enable the item Post Check LAN Cable in the BIOS Setup.

5.3.3 ASUS PC Probe II

PC Probe II is a utility that monitors the computer's vital components, and detects and alerts you of any problem with these components. PC Probe II senses fan rotations, CPU temperature, and system voltages, among others. Because PC Probe II is software-based, you can start monitoring your computer the moment you turn it on. With this utility, you are assured that your computer is always at a healthy operating condition.

Installing PC Probe II

To install PC Probe II on your computer:

1. Place the support DVD to the optical drive. The Drivers installation tab appears if your computer has an enabled Autorun feature.



If Autorun is not enabled in your computer, browse the contents of the support DVD to locate the setup.exe file from the ASUS PC Probe II folder. Double-click the setup.exe file to start installation.

2. Click the Utilities tab, then click ASUS PC Probe II.
3. Follow the screen instructions to complete installation.

Launching PC Probe II

You can launch the PC Probe II right after installation or anytime from the Windows® desktop.

To launch the PC Probe II from the Windows® desktop, click **Start > All Programs > ASUS > PC Probe II > PC Probe II v1.xx.xx**. The PC Probe II main window appears.

After launching the application, the PC Probe II icon appears in the Windows® taskbar. Click this icon to close or restore the application.







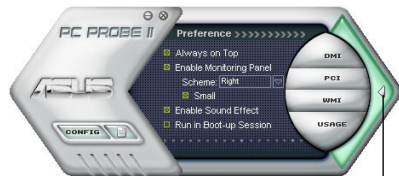

Using PC Probe II

Main window

The PC Probe II main window allows you to view the current status of your system and change the utility configuration. By default, the main window displays the Preference section. You can close or restore the Preference section by clicking on the triangle on the main window right handle.



Click to close the Preference panel

Button	Function
	Opens the Configuration window
	Opens the Report window
	Opens the Desktop Management Interface window
	Opens the Peripheral Component Interconnect window
	Opens the Windows Management Instrumentation window
	Opens the hard disk drive, memory, CPU usage window
	Shows/Hides the Preference section
	Minimizes the application
	Closes the application

Sensor alert

When a system sensor detects a problem, the main window right handle turns red, as the illustrations below show.

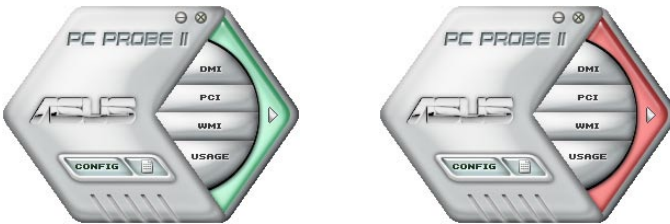

When displayed, the monitor panel for that sensor also turns red. Refer to the Monitor panels section for details.

Preference

You can customize the application using the Preference section in the main window. Click the box before each preference to activate or deactivate.

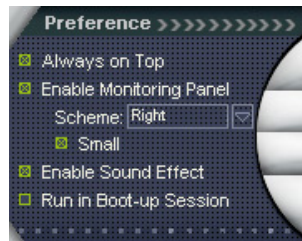

Hardware monitor panels

The hardware monitor panels display the current value of a system sensor such as fan rotation, CPU temperature, and voltages.

The hardware monitor panels come in two display modes: hexagonal (large) and rectangular (small). When you check the Enable Monitoring Panel option from the Preference section, the monitor panels appear on your computer's desktop.



Large display



Small display

Changing the monitor panels position

To change the position of the monitor panels in the desktop, click the arrow down button of the Scheme options, then select another position from the list box. Click OK when finished.





Moving the monitor panels

All monitor panels move together using a magnetic effect. If you want to detach a monitor panel from the group, click the horseshoe magnet icon. You can now move or reposition the panel independently.



Adjusting the sensor threshold value

You can adjust the sensor threshold value in the monitor panel by clicking the  or  buttons. You can also adjust the threshold values using the Config window.

You cannot adjust the sensor threshold values in a small monitoring panel.

Click to increase value

Click to decrease value



Monitoring sensor alert

The monitor panel turns red when a component value exceeds or is lower than the threshold value. Refer to the illustrations below.



Large display



Small display

WMI browser

Click **WMI** to display the WMI (Windows Management Instrumentation) browser. This browser displays various Windows® management information. Click an item from the left panel to display on the right panel. Click the plus sign (+) before WMI Information to display the available information.

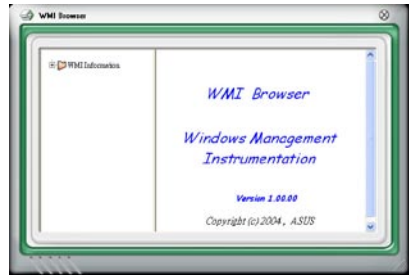

You can enlarge or reduce the browser size by dragging the bottom right corner of the browser.

DMI browser

Click **DMI** to display the DMI (Desktop Management Interface) browser. This browser displays various desktop and system information. Click the plus sign (+) before DMI Information to display the available information.



PCI browser

Click **PCI** to display the PCI (Peripheral Component Interconnect) browser. This browser provides information on the PCI devices installed on your system. Click the plus sign (+) before the PCI Information item to display available information.

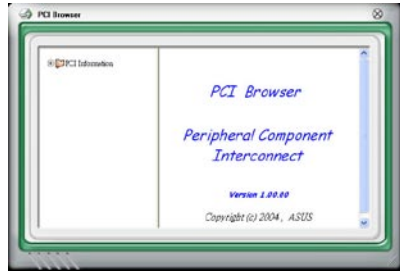

Usage

The Usage browser displays real-time information on the CPU, hard disk drive space, and memory usage. Click **USAGE** to display the Usage browser.

CPU usage

The CPU tab displays real-time CPU usage in line graph representation. If the CPU has an enabled Hyper-Threading, two separate line graphs display the operation of the two logical processors.

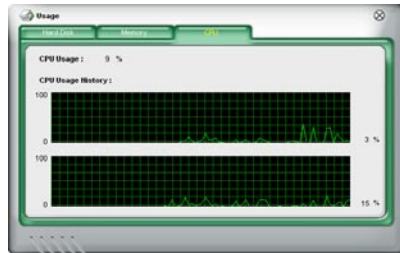

Hard disk drive space usage

The Hard Disk tab displays the used and available hard disk drive space. The left panel of the tab lists all logical drives. Click a hard disk drive to display the information on the right panel. The pie chart at the bottom of the window represents the used (blue) and the available HDD space.



Memory usage

The Memory tab shows both used and available physical memory. The pie chart at the bottom of the window represents the used (blue) and the available physical memory.

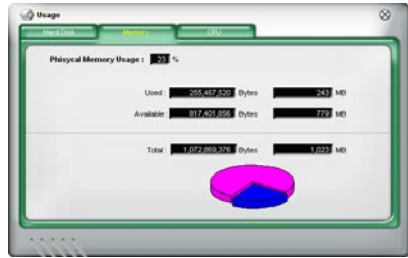

Configuring PC Probe II

Click **CONFIG** to view and adjust the sensor threshold values.

The Config window has two tabs: Sensor/Threshold and Preference. The Sensor/Threshold tab enables you to activate the sensors or to adjust the sensor threshold values. The Preference tab allows you to customize sensor alerts, or change the temperature scale.

The screenshot shows the 'Config' window with the 'Sensor / Threshold' tab selected. It features a table with the following data:

Enabled	Sensor Name	Nominal Value	Current Value	Threshold
<input checked="" type="checkbox"/>	CPU		43	60 °C
<input checked="" type="checkbox"/>	MB		34	45 °C

Below the table are five buttons: Default, Apply, Cancel, Save As, and Load. Callouts point to these buttons with the following descriptions:

- Default:** Loads the default threshold values for each sensor
- Apply:** Applies your changes
- Cancel:** Cancels or ignores your changes
- Save As:** Saves your configuration
- Load:** Loads your saved configuration

5.3.4 ASUS AI Suite

ASUS AI Suite allows you to launch AI Gear 3+, AI Booster, AI Nap, and Q-Fan 2 utilities easily.



Install the **ASUS EPU + AI Gear 3 Driver** before the ASUS AI Suite utility. Otherwise, ASUS AI Suite will not function properly.

Installing AI Suite

To install AI Suite on your computer:

1. Place the support DVD to the optical drive. The Drivers installation tab appears if your computer has an enabled Autorun feature.
2. Click the Utilities tab, then click **AI Suite**.
3. Follow the screen instructions to complete installation.

Launching AI Suite

You can launch AI Suite right after installation or anytime from the Windows® desktop.

To launch AI Suite from the Windows® desktop, click **Start > All Programs > ASUS > AI Suite > AI Suite v1.xx.xx**. The AI Suite main window appears.

After launching the application, the AI Suite icon appears in the Windows® taskbar. Click this icon to close or restore the application.

Using AI Suite

Click the AI Gear 3+, AI Nap, AI Booster, or Q-Fan 2 icon to launch the utility, or click the Normal icon to restore the system to normal state.

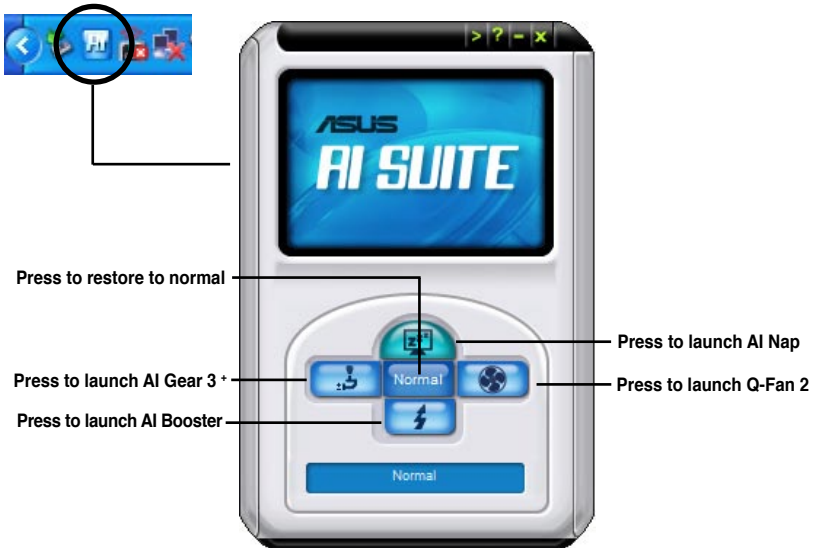

Other feature buttons

Click  on right corner of the main window to open the monitor window.

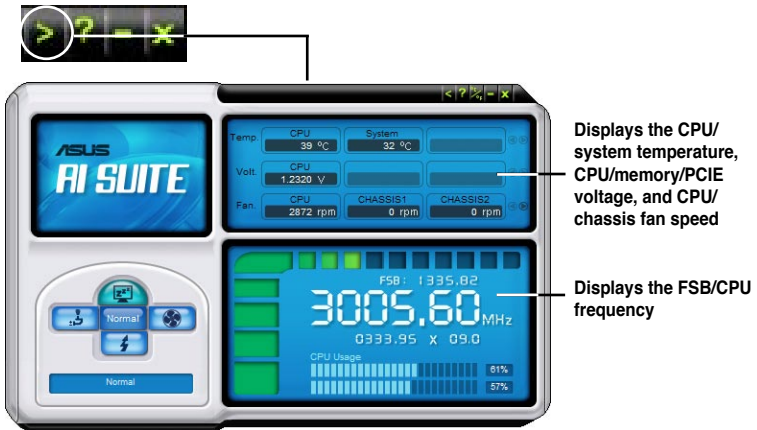

Click  on right corner of the expanded window to switch the temperature from degrees Centigrade to degrees Fahrenheit.



5.3.5 ASUS EPU Utility—AI Gear 3+

ASUS AI Gear 3+ is a utility designed to configure and support all ASUS EPU (Energy Processing Unit) features. This easy-to-use utility provides four system performance profiles that adjust the processor frequency and vCore voltage for different computing needs.

After installing ASUS AI Suite from the bundled support DVD, you can launch ASUS AI Gear 3+ by double-clicking the AI Suite icon on your Windows OS taskbar and then click the AI Gear 3+ button on the AI Suite main window.

Here are some simple ways to use AI Gear 3+:

- Click the four gear mode buttons below, including **Turbo**, **High Performance**, **Medium Power Saving**, and **Max. Power Saving**, or shift the gear to the performance setting that you like.
- Click **Calibration** first, and switch to **Auto** mode to have AI Gear 3+ automatically adjust the system performance according to the CPU loading.
- Under **Auto** mode, click **Settings** to set the time for the system to enter AI Nap mode.
- Click **Energy Saving** to show the total amount of electricity this ASUS EPU-featured motherboard saved.

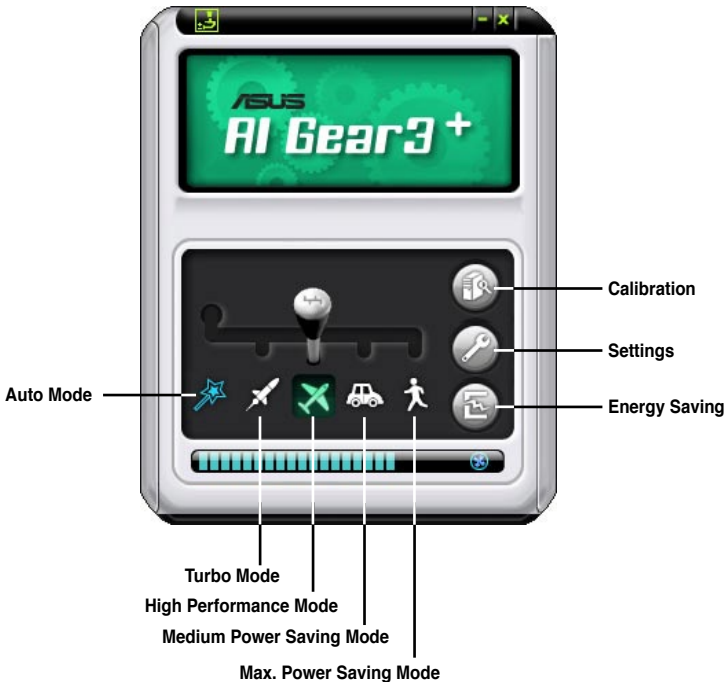

Energy Saving Status

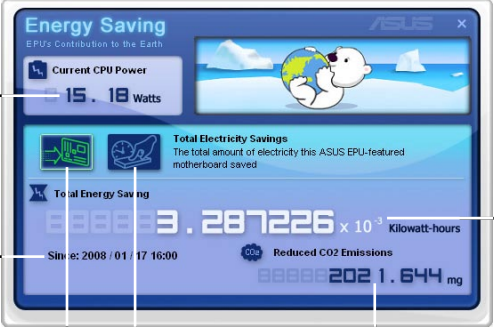

The screenshot shows the 'Energy Saving' window with the following data:

- Current CPU Power: 15.18 Watts
- Total Electricity Savings: 3.287226 x 10⁻³ Kilowatt-hours
- Time since start: 2008 / 01 / 17 16:00
- Reduced CO2 Emissions: 2021.644 mg

Annotations:

- Displays the current CPU power
- Displays the amount of electricity saved since the system started up
- Displays the time/date the calculator starts counting
- Click to switch to the "Total Electricity Savings" window
- Click to switch to the "Electricity Savings Calculator" window
- Displays the amount of CO2 that has been reduced

Click  to open the **Electricity Savings Calculator** window. You may reset the time for the calculator to start counting.

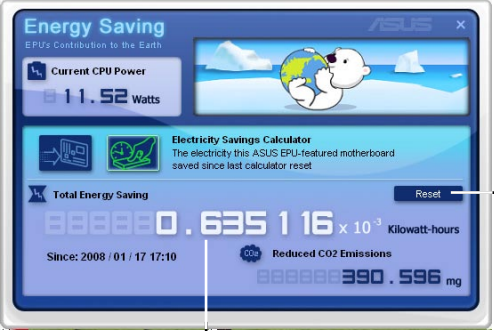

The screenshot shows the 'Energy Saving' window with the 'Electricity Savings Calculator' window open. The data is as follows:

- Current CPU Power: 11.52 Watts
- Electricity Savings Calculator: 0.635116 x 10⁻³ Kilowatt-hours
- Time since reset: 2008 / 01 / 17 17:10
- Reduced CO2 Emissions: 390.596 mg

Annotations:

- Click to reset the time the calculator starts
- Displays the electricity saved since the time was reset

5.3.6 ASUS AI Nap

This feature allows you to minimize the power consumption of your computer whenever you are away. Enable this feature for minimum power consumption and a more quiet system operation.

After installing AI Suite from the bundled support DVD, you can launch the utility by double-clicking the AI Suite icon on the Windows OS taskbar and click the AI Nap button on the AI Suite main window.

Click **Yes** on the confirmation screen.

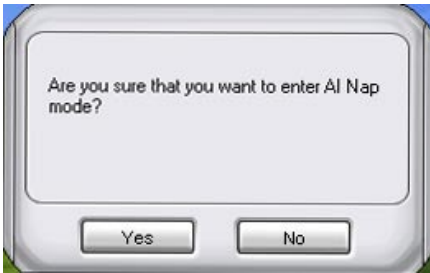

To exit AI Nap mode, press the system power or mouse button then click **Yes** on the confirmation screen.

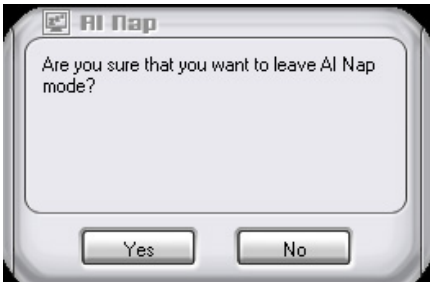

To switch the power button functions from AI Nap to shutting down, just right click the **AI Suite** icon on the OS taskbar, select **AI Nap** and click **Use power button**. Unclick the the item to switch the function back.

5.3.7 ASUS Q-Fan 2

This ASUS Q-Fan 2 Control feature allows you to set the appropriate performance level of the CPU Q-Fan 2 or the Chassis Q-Fan 2 for more efficient system operation. After enabling the Q-Fan 2 function, the fans can be set to automatically adjust depending on the temperature, to decrease fan speed, or to achieve the maximum fan speed.

After installing AI Suite from the bundled support DVD, you can launch the utility by double-clicking the AI Suite icon on the Windows® OS taskbar and click the Q-Fan 2 button on the AI Suite main window.

Click the drop-down menu button and display the fan names. Select **CPU Q-Fan 2** or **CHASSIS Q-Fan 2**. Click the box of **Enable Q-Fan 2** to activate this function.

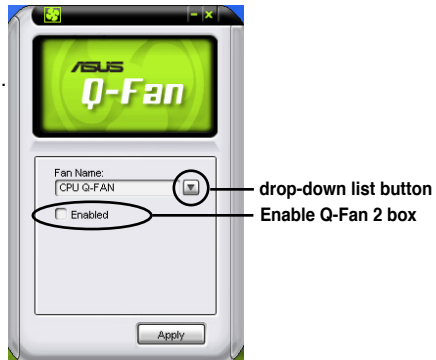

Profile list appears after clicking the **Enable Q-Fan 2** box. Click the drop-down list button and select a profile. **Optimal** mode makes the fans adjust speed with the temperature; **Silent** mode minimizes fan speed for quiet fan operation; **Performance** mode boosts the fan to achieve maximal fan speed for the best cooling effect.



Click **Apply** at the bottom to save the setup.

5.3.8 ASUS AI Booster

The ASUS AI Booster application allows you to overclock the CPU speed in Windows® environment without the hassle of booting the BIOS.

After installing AI Suite from the bundled support DVD, you can launch the utility by double-clicking the AI Suite icon on the Windows® OS taskbar and click the AI Booster button on the AI Suite main window.

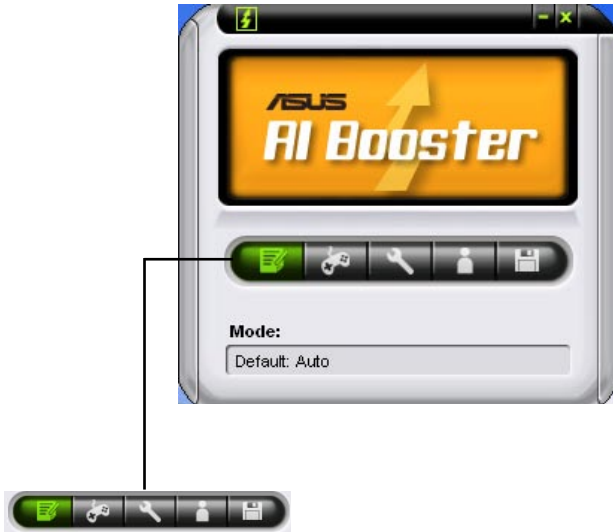

The options on the taskbar allow you to use the default settings, adjust CPU/ Memory/PCI-E frequency manually, or create and apply your personal overclocking configurations.

5.3.9 ASUS AI Direct Link

ASUS AI Direct Link allows you to form a computer-to-computer network via a network cable to share files with high transfer rate. You must first connect two computers (at least one of them is ASUS product) using a network cable, and then install the utility to both computers to avail the AI Direct Link feature.



- Turn off your firewall software other than Windows Firewall before launching AI Direct Link.
- The transfer rate is limited if you use a 10/100 LAN card.

Using AI Direct Link

To enable the incoming folder:

1. From the Windows® taskbar, right click on the AI Direct Link icon  and select **Incoming folder > Enable incoming folder**.



For Windows XP Home edition users, click **Steps of enabling file sharing** on this pop-up message and follow the instructions to enable the incoming folder.

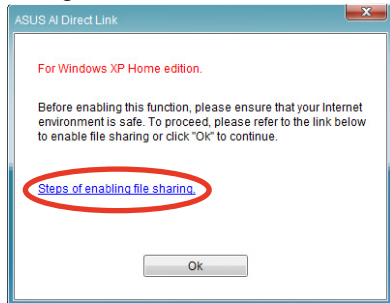

2. If you want to verify the incoming user, select **Use my account** and set your username and password. Otherwise, select **Use public account**.



For security's sake, it is recommended that you set a username and password.

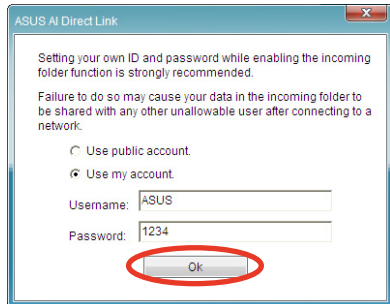

3. Click **OK** and the “Ready for incoming” message appears.



To disable the incoming folder, select **Incoming folder > Disable incoming folder**.

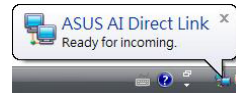

- Right click on the AI Direct Link icon and select **Incoming folder > Open incoming folder**. The **AIDirectLinkIncoming** folder opens. Put the files you want to share into this folder. The authorized user has full access to this folder.

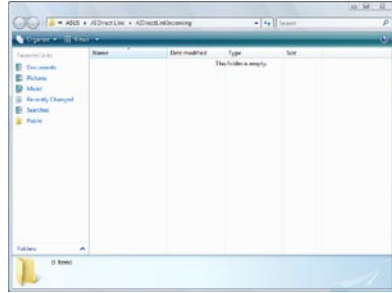

The default path of the AIDirectLinkIncoming folder is C:\Program Files\ASUS\AI Direct Link. To change its location, disable the incoming folder first. Then, select **Incoming folder > Change incoming folder** to open the system directories, and move the AIDirectLinkIncoming folder under another directory.

To connect to another computer:



This function is valid for ASUS products only.

- From the Windows® taskbar, right click on the AI Direct Link icon and select **Connect**. The following screen displays.
- Click **Refresh**. The software starts searching for the connected computer.

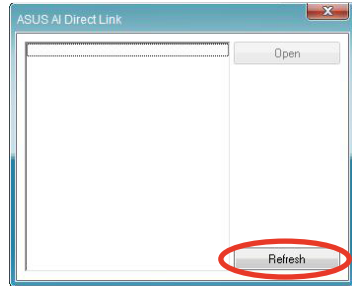

- The name of the computer found is listed. Click **Open** to open its shared folder.

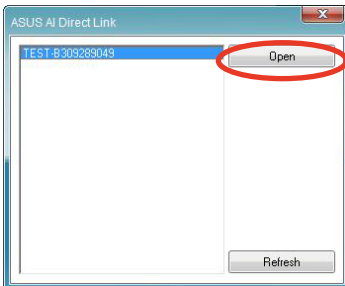

- If necessary, enter the authorized username and password. Click **OK** to log in and have full access to this shared folder.

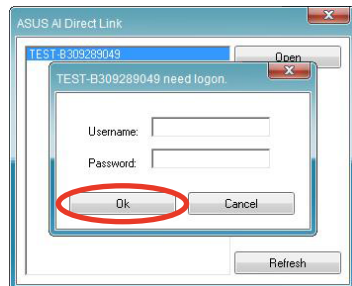

5.3.10 AI Audio 2 (SoundMAX® High Definition Audio utility)

The ADI AD1988 High Definition Audio CODEC provides 8-channel audio capability through the SoundMAX® audio utility with AudioESP™ software to deliver the ultimate audio experience on your PC. The software implements high quality audio synthesis/rendering, 3D sound positioning, and advanced voice-input technologies.

Follow the installation wizard to install the ADI AD1988 Audio Driver from the support DVD that comes with the motherboard package to activate the SoundMAX® audio utility.



You must use 4-channel, 6-channel or 8-channel speakers for this setup.

If the SoundMAX® audio utility is correctly installed, you will find the SoundMAX®/ SoundMAX® BlackHawk icon



A. SoundMAX BlackHawk (AI Audio 2)

If you are using Windows Vista™ operating system, from the taskbar, double-click on the SoundMAX® BlackHawk icon to display the SoundMAX® control panel.



Enabling AI Audio 2

Click the power button  to activate digital signal processing. AI Audio 2, with the new SoundMAX® BlackHawk by Sonic Focus, brings you more multi-media enjoyment.

Fidelity Compensation

After you click the power button, the utility will compensate for the fidelity lost in the compression process and make the audio output quasi-original when reverting the compressed audio streams back to the uncompressed condition.

Sound Field Expansion

AI Audio 2 also expands the stereophonic sound field to a multi-channel one with realistic front and rear environment.

Surround Virtualization

Activating this function virtualizes surround sound with the vocal clarity added for use with stereo speakers or headphones.



SoundMAX BlackHawk (AI Audio2) is available only under the Windows® Vista™ operating system.

Playback Settings

To configure the playback settings, click the **Playback** button on the control panel. You can adjust the volume of the **Speakers** and **SPDIF Interface** or mute the audio.

Preset settings

Click and expand the drop-down menu to select your preferred Digital Signal Processing (DSP) preset. Move the sliders to customize the values of **Voice Clarity**, **Dynamics**, **Brilliance**, and **Deep Bass** of each preset.

Click Save to save the changes to the current preset. Or, click **Reset** to discard the changes and restore the preset to the factory defaults.



Surround settings

Allows you to change the settings of the stereo speakers. Move the sliders to change the listener position or adjust the center channel volume. Press the **Test Speakers** button to perform speaker test.



Port settings

Click this port settings tab to display the rear panel ports configuration for the speakers or rear panel digital port configuration for the SPDIF interface.



Recording Settings

To change the recording settings, click the **Recording** button on the control panel. You can adjust the speaker delay of **Microphone** or **Line In** by moving the slider rightward or leftward.

Record testing

Click the tab to perform test recording and play the test sample through the speakers or the SPDIF interface.

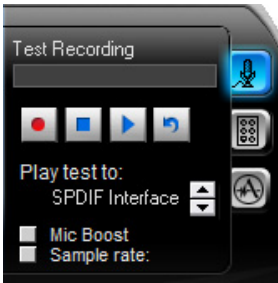

Port settings

Click the tab to display the rear panel ports for Microphone or Line In.



ANDREA settings

Allows you to select an enhanced microphone input features, including **No Filtering**, **Speakerphone**, **Voice Recording**, and **Directional Beam**.

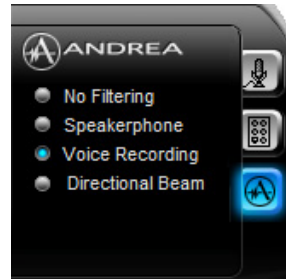

More Settings

Click  for the further configurations.

Equalizer

Allows you to configure and customize all the DSP presets through the frequencies.



Speakers

Allows you to adjust the **Speaker Trim** and **Speaker Delay**.

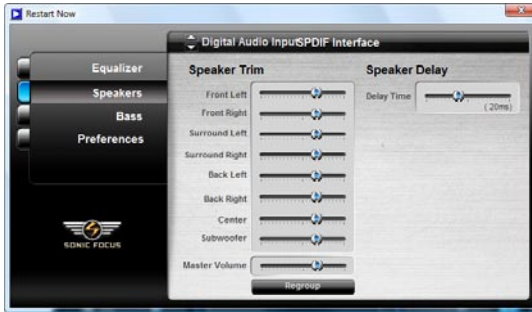

Bass

Allows you to do the Bass management.

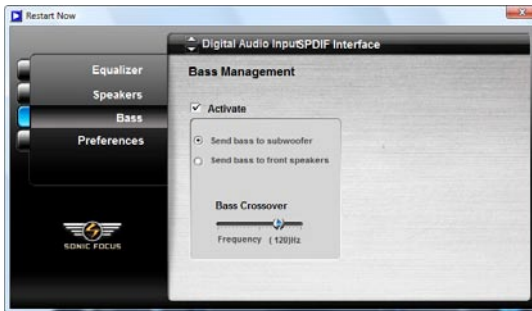

Preferences

Displays the preference options for this utility, version information, AudioESP, etc.



B. SoundMAX

If you are using Windows XP operating system, from the taskbar, double-click on the SoundMAX® icon to display the SoundMAX® Control Panel.



Audio Setup Wizard

By clicking the  icon from the SoundMAX® control panel, you can easily configure your audio settings. Simply follow succeeding screen instructions and begin enjoying High Definition Audio.



Jack configuration

This screen helps you configure your computer's audio ports, depending on the audio devices you have installed.

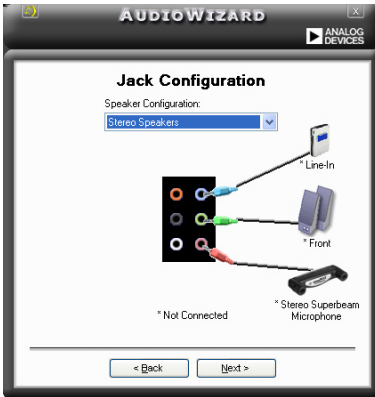

Adjust speaker volume

This screen helps you adjust speaker volume. Click the **Test** button to hear the changes you have made.



Adjust microphone volume

This screen helps you adjust microphone volume. You will be asked to read pre-written text to allow the AudioWizard to adjust the volume as you speak.



Audio preferences

Click the  icon to go to the Preferences page. This page allows you to change various audio settings.

General options

Click the General tab to choose your playback and recording devices, enable/disable the AudioESP™ feature, and enable/disable digital output.

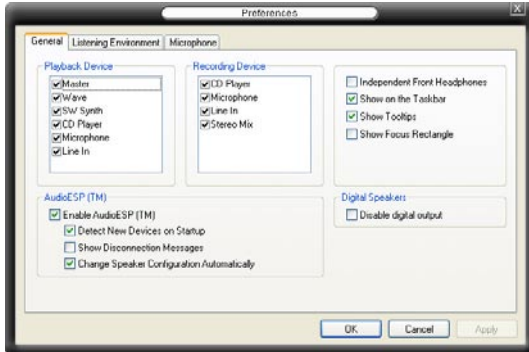

Listening Environment options

Click the Listening Environment tab to set up your speaker, acoustic environment, and enable/disable the Virtual Theater Surround function.

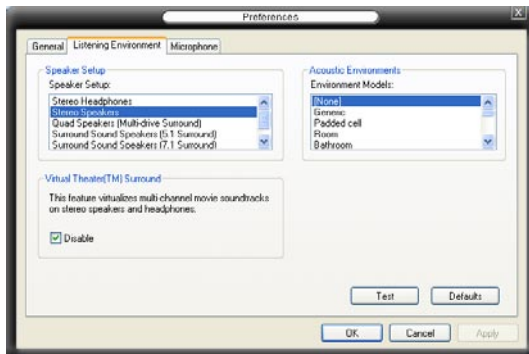

Microphone options

Click the Microphone tab allows you to optimize your microphone input settings.

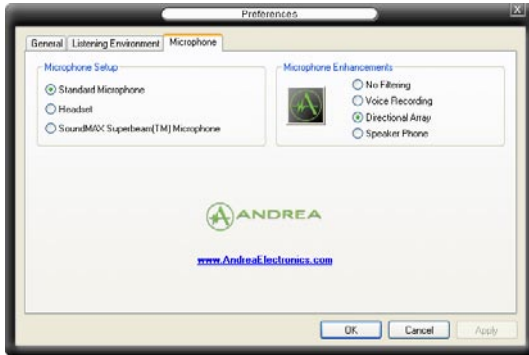

Enhanced Microphone Features

Voice recording

Enables Noise Filter function. Detects repetitive and stationary noises like computer fans, air conditioners, and other background noises then eliminates it in the incoming audio stream while recording. You can enable it for a better recording quality.

Directional Array

Receives only the sound coming from the reception cone and eliminates interferences including neighboring speakers and reverberations. You can enable it to transit clearer sound during on-line games, MSN, or Skype.

Speaker Phone

Advanced de-reverberation techniques can help to reduce echo and minimize its effect on the speech engine. You can enable it when you have conference call to reduce echoes in the other side.



- The directional Array and Speaker Phone are purchased separately and function only when working with the ASUS Array Mic.
- If you are using Windows Vista, you have to manually enable the directional Array and Speaker Phone function. Go to **Control panel > Sound**. Click the **Recording** tab on the top and select **Microphone**. Click the **Microphone Enhancement** tab and check **Array Mic**.



5.4 RAID configurations

The motherboard comes with two RAID controllers that allow you to configure Serial ATA hard disk drives as RAID sets.

- The **Intel® ICH9R Southbridge RAID** includes a high performance SATA RAID controller that supports RAID 0, RAID 1, RAID 10, and RAID 5 for six independent Serial ATA channels.
- The **JMicro® JMB363 RAID** includes a high performance SATA RAID controller that supports RAID 0, 1, and JBOD for two independent Serial ATA channels.

5.4.1 RAID definitions

RAID 0 (Data striping) optimizes two identical hard disk drives to read and write data in parallel, interleaved stacks. Two hard disks perform the same work as a single drive but at a sustained data transfer rate, double that of a single disk alone, thus improving data access and storage. Use of two new identical hard disk drives is required for this setup.

RAID 1 (Data mirroring) copies and maintains an identical image of data from one drive to a second drive. If one drive fails, the disk array management software directs all applications to the surviving drive as it contains a complete copy of the data in the other drive. This RAID configuration provides data protection and increases fault tolerance to the entire system. Use two new drives or use an existing drive and a new drive for this setup. The new drive must be of the same size or larger than the existing drive.

RAID 5 stripes both data and parity information across three or more hard disk drives. Among the advantages of RAID 5 configuration include better HDD performance, fault tolerance, and higher storage capacity. The RAID 5 configuration is best suited for transaction processing, relational database applications, enterprise resource planning, and other business systems. Use a minimum of three identical hard disk drives for this setup.

RAID 10 is data striping and data mirroring combined without parity (redundancy data) having to be calculated and written. With the RAID 10* configuration you get all the benefits of both RAID 0 and RAID 1 configurations. Use four new hard disk drives or use an existing drive and three new drives for this setup.

JBOD (Spanning) stands for Just a Bunch of Disks and refers to hard disk drives that are not yet configured as a RAID set. This configuration stores the same data redundantly on multiple disks that appear as a single disk on the operating system. Spanning does not deliver any advantage over using separate disks independently and does not provide fault tolerance or other RAID performance benefits.

Intel® Matrix Storage. The Intel® Matrix Storage technology supported by the ICH9R chip allows you to create a RAID 0, RAID 1, RAID 5, and RAID 10* function to improve both system performance and data safety. You can also combine two RAID sets to get higher performance, capacity, or fault tolerance provided by the difference RAID function. For example, RAID 0 and RAID 1 set can be created by using only two identical hard disk drives.



If you want to boot the system from a hard disk drive included in a created RAID set, copy first the RAID driver from the support DVD to a floppy disk before you install an operating system to the selected hard disk drive. Refer to section **5.5 Creating a RAID driver disk** for details.

5.4.2 Installing Serial ATA hard disks

The motherboard supports Serial ATA hard disk drives. For optimal performance, install identical drives of the same model and capacity when creating a disk array.

To install the SATA hard disks for a RAID configuration:

1. Install the SATA hard disks into the drive bays.
2. Connect the SATA signal cables.
3. Connect a SATA power cable to the power connector on each drive.

5.4.3 Intel® RAID configurations

This motherboard supports RAID 0, RAID 1, RAID 5, RAID 10 (0+1) and Intel® Matrix Storage configurations for Serial ATA hard disks drives through the Intel® ICH9R Southbridge chip.

Setting the RAID item in BIOS

You must set the RAID item in the BIOS Setup before you can create a RAID set(s). To do this:

1. Enter the BIOS Setup during POST.
2. Go to the **Main** menu, select **SATA Configuration**, then press <Enter>.
3. Select the item **Configure SATA as**, then press <Enter> to display the configuration options.
4. Select [RAID] from the **Configure SATA as** item options, then press <Enter>.
5. Save your changes, then exit the BIOS Setup.



Refer to the system or the motherboard user guide for details on entering and navigating through the BIOS Setup.

Intel® Matrix Storage Manager Option ROM Utility

The Intel® Matrix Storage Manager Option ROM utility allows you to create RAID 0, RAID 1, RAID 10 (RAID 0+1), and RAID 5 set(s) from Serial ATA hard disk drives that are connected to the Serial ATA connectors supported by the Southbridge.

To enter the Intel® Application Accelerator RAID Option ROM utility:

1. Install all the Serial ATA hard disk drives.
2. Turn on the system.
3. During POST, press <Ctrl+I> to display the utility main menu.

```
Intel(R) Matrix Storage Manager Option ROM v5.0.0.1032 ICH9R wRAID5
Copyright(C) 2003-05 Intel Corporation. All Rights Reserved.

[ MAIN MENU ]
1. Create RAID Volume
2. Delete RAID Volume
3. Reset Disks to Non-RAID
4. Exit

[ DISK/VOLUME INFORMATION ]

RAID Volumes:
None defined.

Physical Disks:
Port Drive Model      Serial #      Size      Type/Status (Vol ID)
0  XXXXXXXXXXXX      XXXXXXXX      XX.XXGB  Non-RAID Disk
1  XXXXXXXXXXXX      XXXXXXXX      XX.XXGB  Non-RAID Disk
2  XXXXXXXXXXXX      XXXXXXXX      XX.XXGB  Non-RAID Disk
3  XXXXXXXXXXXX      XXXXXXXX      XX.XXGB  Non-RAID Disk

[↑↓]-Select      [ESC]-Exit      [ENTER]-Select Menu
```

The navigation keys at the bottom of the screen allow you to move through the menus and select the menu options.



The RAID BIOS setup screens shown in this section are for reference only and may not exactly match the items on your screen.

Creating a RAID 0 set (striped)

To create a RAID 0 set:

1. From the utility main menu, select 1. Create RAID Volume, then press <Enter>. This screen appears.

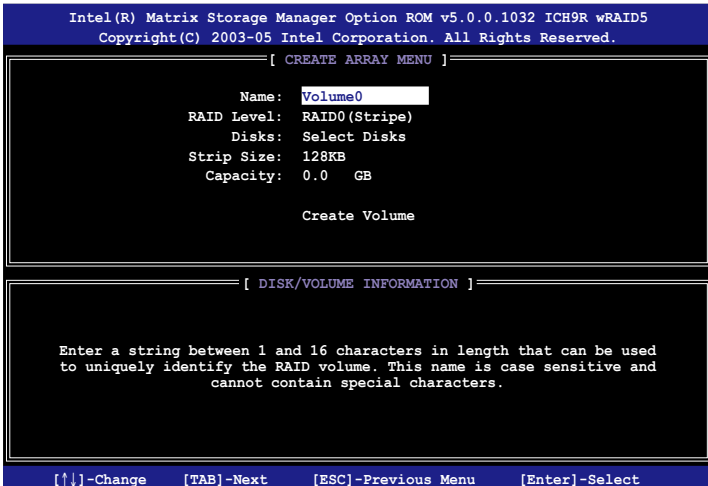

2. Enter a name for the RAID 0 set, then press <Enter>.
3. When the RAID Level item is highlighted, press the up/down arrow key to select RAID 0(Stripe), then press <Enter>.
4. When the Disks item is highlighted, press <Enter> to select the hard disk drives to configure as RAID. This pop-up screen appears.

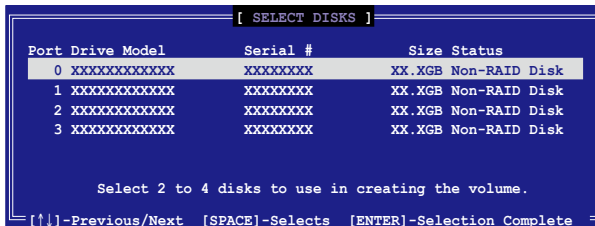

5. Use the up/down arrow key to highlight a drive, then press <Space> to select. A small triangle marks the selected drive. Press <Enter> after completing your selection.

6. Use the up/down arrow key to select the stripe size for the RAID 0 array, then press <Enter>. The available stripe size values range from 4 KB to 128 KB. The default stripe size is 128 KB.



We recommend a lower stripe size for server systems, and a higher stripe size for multimedia computer systems used mainly for audio and video editing.

7. Key in the RAID volume capacity that you want, then press <Enter>. The default value indicates the maximum allowed capacity.
8. Press <Enter> when the Create Volume item is highlighted. This warning message appears.

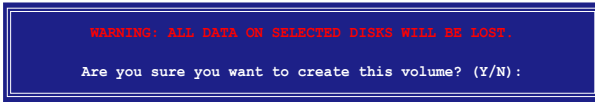

9. Press <Y> to create the RAID volume and return to the main menu, or <N> to go back to the Create Volume menu.

Creating a RAID 1 set (mirrored)

To create a RAID 1 set:

1. From the utility main menu, select 1. Create RAID Volume, then press <Enter>. This screen appears.

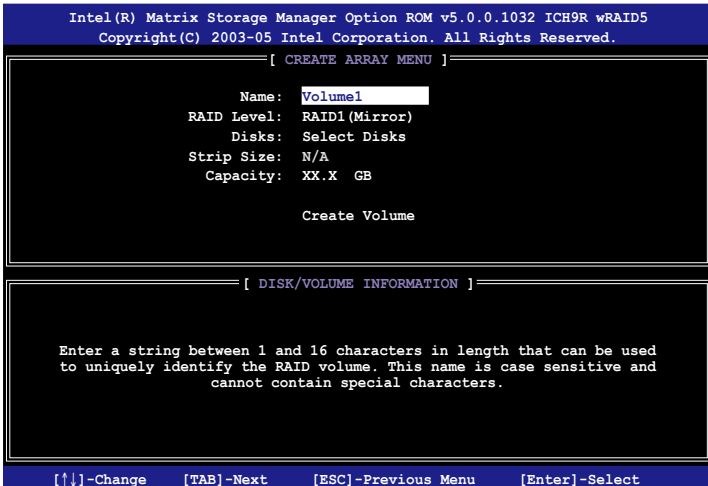

2. Enter a name for the RAID 1 set, then press <Enter>.
3. When the RAID Level item is highlighted, press the up/down arrow key to select RAID 1(Mirror), then press <Enter>.
4. When the Capacity item is highlighted, key in the RAID volume capacity that you want, then press <Enter>. The default value indicates the maximum allowed capacity.
5. Press <Enter> when the Create Volume item is highlighted. This warning message appears.

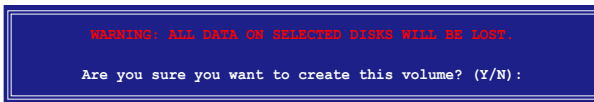

6. Press <Y> to create the RAID volume and return to main menu or <N> to go back to Create Volume menu.

Creating a RAID 10 set (RAID 0+1)

To create a RAID 10 set:

1. From the utility main menu, select 1. Create RAID Volume, then press <Enter>. This screen appears.

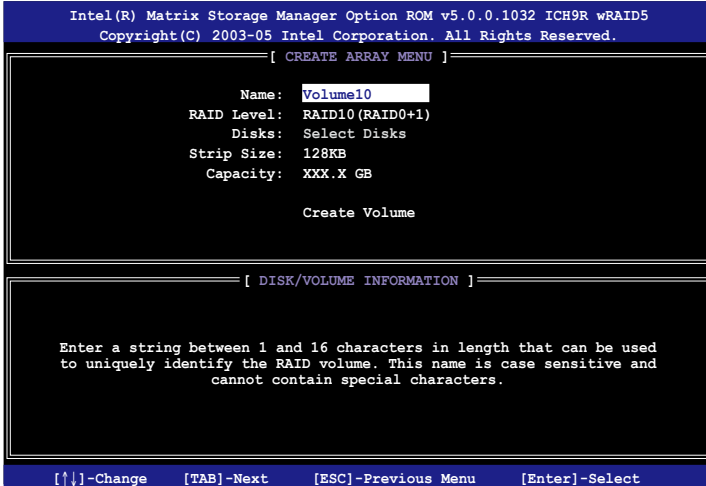

2. Enter a name for the RAID 10 set, then press <Enter>.
3. When the RAID Level item is highlighted, press the up/down arrow key to select RAID 10(RAID0+1), then press <Enter>.
4. When the Stripe Size item is highlighted, press the up/down arrow key to select the stripe size for the RAID 10 array, then press <Enter>. The available stripe size values range from 4 KB to 128 KB. The default stripe size is 64 KB.



We recommend a lower stripe size for server systems, and a higher stripe size for multimedia computer systems used mainly for audio and video editing.

5. Key in the RAID volume capacity that you want then press <Enter> when the Capacity item is highlighted. The default value indicates the maximum allowed capacity.

6. Press <Enter> when the Create Volume item is highlighted. This warning message appears.



7. Press <Y> to create the RAID volume and return to the main menu or <N> to go back to the Create Volume menu.

Creating a RAID 5 set (parity)

To create a RAID 5 set:

1. From the utility main menu, select 1. Create RAID Volume, then press <Enter>. This screen appears.

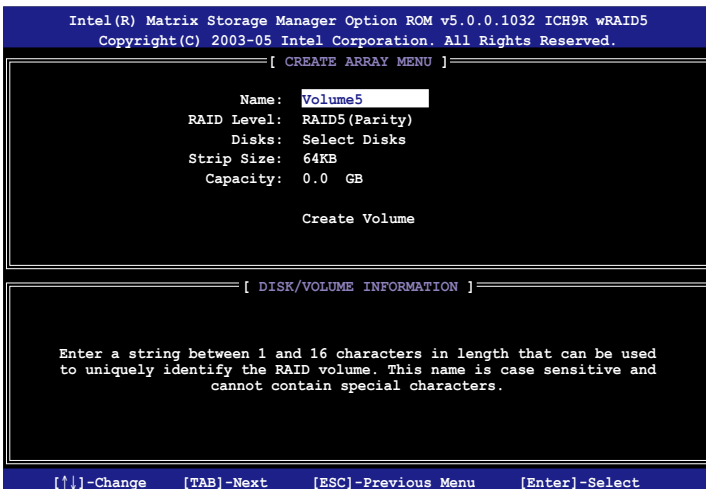

2. Enter a name for the RAID 5 set, then press <Enter>.
3. When the RAID Level item is highlighted, press the up/down arrow key to select RAID 5(Parity), then press <Enter>.

- The Disks item is highlighted, press <Enter> to select the hard disk drives to configure as RAID. The following pop-up screen appears.

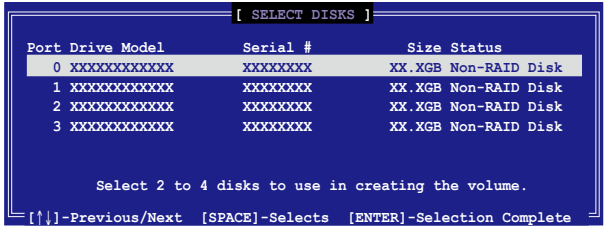

- Use the up/down arrow key to highlight the drive you want to set, then press <Space> to select. A small triangle marks the selected drive. Press <Enter> after completing your selection.
- When the Stripe Size item is highlighted, press the up/down arrow key to select the stripe size for the RAID 5 array, then press <Enter>. The available stripe size values range from 4 KB to 128 KB. The default stripe size is 64 KB.



We recommend a lower stripe size for server systems, and a higher stripe size for multimedia computer systems used mainly for audio and video editing.

- Key in the RAID volume capacity that you want, then press <Enter> when the Capacity item is highlighted. The default value indicates the maximum allowed capacity.
- Press <Enter> when the Create Volume item is highlighted. This warning message appears.

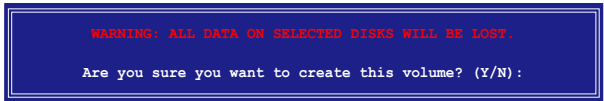

- Press <Y> to create the RAID volume and return to the main menu or <N> to go back to the Create Volume menu.

5.4.4 JMicron® RAID Configuration

The JMicron® Serial ATA controller allows you to configure RAID 0, RAID 1 and JBOD sets on the external Serial ATA hard disk drives.

Before creating a RAID set

Prepare the following items:

1. Two SATA HDDs, preferably with the same model and capacity.
2. A write-enabled floppy disk (Windows XP). A write-enabled floppy disk or a USB flash disk drive (Windows Vista)
3. Microsoft® Windows® OS installation disk (Windows XP)
4. Motherboard support CD with JMB363 driver

Complete the following steps before you create a RAID set:

1. Install the two external Serial ATA hard disk drives on your system.
2. Set the **Controller Mode** item in the BIOS to [RAID]. See section **4.5.3 Onboard Device Configuration** for details.

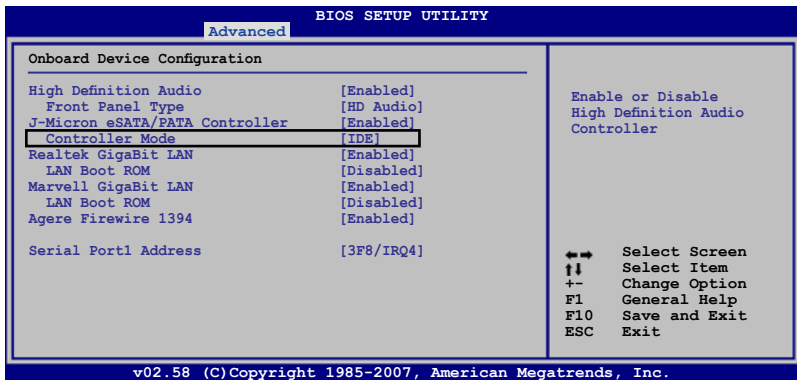

3. Enter the JMB363 RAID BIOS utility to set up your RAID configuration.
4. Create a JMB363 RAID driver disk for Windows® OS installation. See section **5.5 Creating a RAID driver disk** for details.
5. Install the JMB363 driver after the Windows® OS had been installed.



Always install the JMB363 driver before creating RAID sets.

Entering the JMB363 RAID BIOS utility

1. During POST, press <Ctrl-J> to enter the JMB363 RAID BIOS menu.

```
JMicron Technology Corp. PCI-to-SATA II/IDE RAID Controller BIOS v0.97
Copyright (C) 2004-2005 JMicron Technology          http://www.jmicron.com

HDD0 : HDS722516VLSA80                               164 GB Non-RAID
HDD1 : HDS722516DLA380                               164 GB Non-RAID

Press <Ctrl-J> to enter RAID Setup Utility...
```

2. The main JMB363 RAID BIOS menu appears.
3. Use the arrow keys to move the color bar and navigate through the items.

```
JMicron Technology Corp. PCI-to-SATA II/IDE RAID Controller BIOS v0.97

[Main Menu]
Create RAID Disk Drive
Delete RAID Disk Drive
Revert HDD to Non-RAID
Solve Mirror Conflict
Rebuild Mirror Drive
Save and Exit Setup
Exit Without Saving

[Hard Disk Drive List]
Model Name      Capacity  Type/Status
HDD0: HDS722516VLSA80  164 GB  Non-RAID
HDD1: HDS722516DLA380  164 GB  Non-RAID

[RAID Disk Drive List]

[<--> TAB]-Switch Window  [↑↓]-Select Item  [ENTER]-Action  [ESC]-Exit
```

Creating a RAID set

1. In the main JMB363 RAID BIOS menu, highlight Create RAID Disk Drive using the up/down arrow key then press <Enter>.

```
[Main Menu]
Create RAID Disk Drive
Delete RAID Disk Drive
Revert HDD to Non-RAID
Solve Mirror Conflict
Rebuild Mirror Drive
Save and Exit Setup
Exit Without Saving
```

- When the Level item is highlighted, use the up/down arrow key to select the RAID set that you want to create.



- When the Disks item is highlighted, use the up/down arrow key to highlight an HDD that you want to belong to the RAID set, then press the space bar to confirm selection. Repeat the process until the HDDs are selected.

A selected HDD shows a ► sign before it.

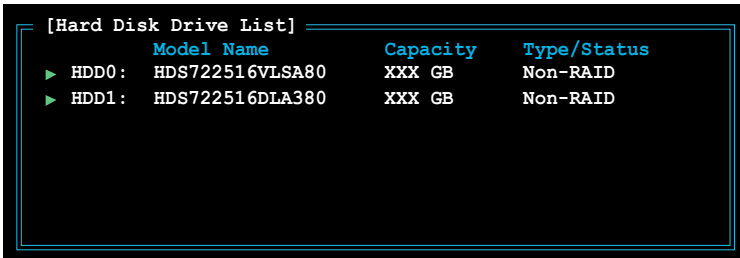

- Key in the RAID volume capacity. Use the up/down arrow to choose the block size. The default value indicates the maximum allowed capacity.



- When done, press <Enter> to confirm the creation of the RAID set. A dialogue box appears to confirm the action. Press <Y> to confirm; otherwise, press <N>.

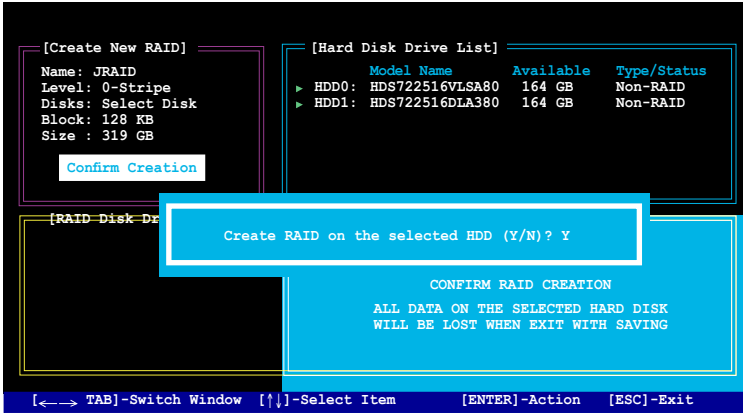

Pressing <Y> deletes all the data in the HDDs.

- The following screen appears, displaying the relevant information about the RAID set you created.

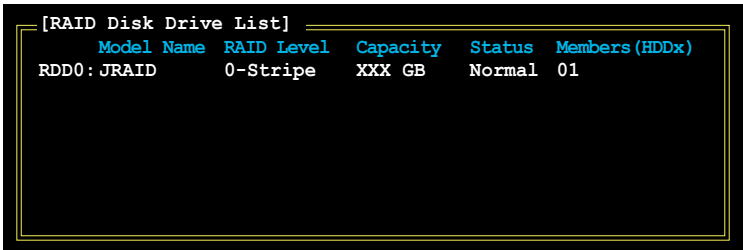

Deleting a RAID set

1. In the main JMB363 RAID BIOS menu, highlight Delete RAID Disk Drive using the up/down arrow key then press <Enter>.

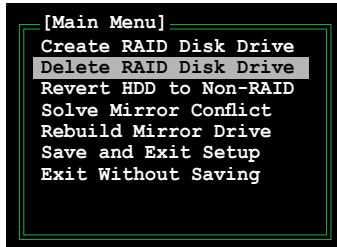

2. Use the space bar to select the RAID set you want to delete.
A selected set shows a ► sign before it. Press the key to delete the set.
3. A dialogue box appears to confirm the action. Press <Y> to confirm; otherwise, press <N>.

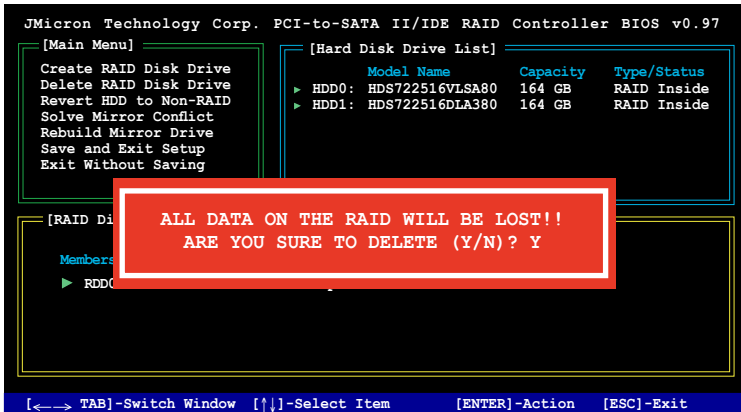

Pressing <Y> deletes all the data in the HDDs.

Resetting disks to non-RAID



- An HDD that has been previously configured as part of another RAID set in another platform is called a broken RAID HDD. When you install a broken RAID HDD, you cannot select this HDD when configuring a RAID set through the JMB363 utility.
- If you still want to use this broken RAID HDD as part of the RAID set configured through the JMB363, you may do so by resetting the disk to non-RAID. You will, however, lose all data and previous RAID configurations.

To reset disks to non-RAID:

1. In the main JMB363 RAID BIOS menu, highlight Revert HDD to non-RAID using the up/down arrow key then press <Enter>.

```
[Main Menu]
Create RAID Disk Drive
Delete RAID Disk Drive
Revert HDD to Non-RAID
Solve Mirror Conflict
Rebuild Mirror Drive
Save and Exit Setup
Exit Without Saving
```

2. Use the space bar to select the HDD that you want to reset to non-RAID. A selected HDD shows a ► sign before it.
3. A dialogue box appears to confirm the action. Press <Y> to confirm; otherwise, press <N>.



Pressing <Y> deletes all the data in the HDD.

Solving a Mirror conflict

A Mirror conflict occurs when both disks in a RAID 1 (Mirror) configuration are unplugged from the system in turn, then plugged in again. Since both disks contain exactly the same data, the system will be unable to determine which of the two is the source drive. This option allows you to set the source drive and rebuild the Mirror drive according to the contents of the source drive.

To solve a Mirror conflict:

1. In the main JMB363 RAID BIOS menu, highlight Solve Mirror Conflict using the up/down arrow key then press <Enter>.

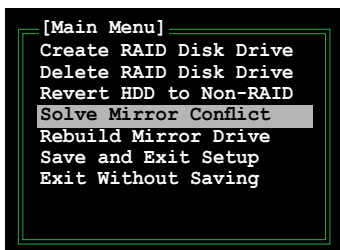

2. Use the space bar to select the HDD that you want to set as source drive. The selected HDD shows a ► sign before it.
3. Using the <TAB>, move to the RAID Disk Drive List menu and highlight the RAID set that you want to rebuild. Press to begin rebuilding the Mirror configuration.

A status bar at the bottom of the screen shows the progress of the rebuilding.

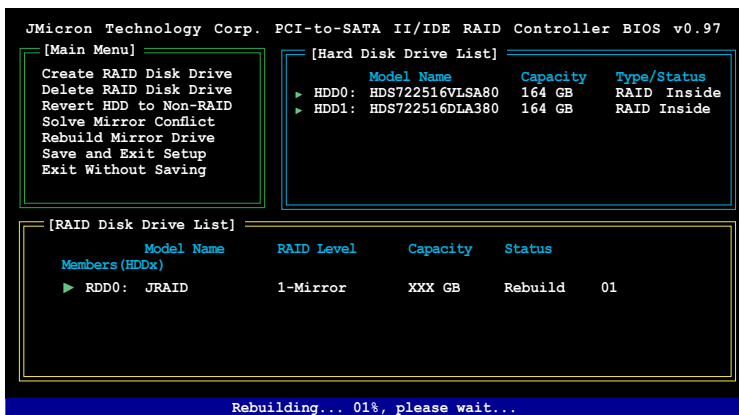

Rebuilding a Mirror Drive

When one of the disks in a RAID 1 (Mirror) configuration is unplugged from the system, then plugged in again, a dialogue box appears to ask you to rebuild the Mirror drive. Press <Y> to confirm; otherwise, press <N>.

This option allows you to rebuild the Mirror drive later and synchronize the data between two hard disks.

To rebuild a Mirror drive:

1. In the main JMB363 RAID BIOS menu, highlight Rebuild Mirror Drive using the up/down arrow key then press <Enter>.

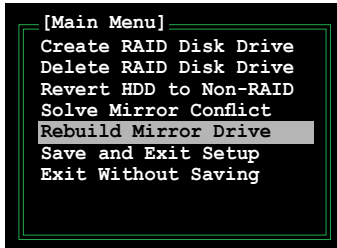

2. Using the <TAB>, move to the RAID Disk Drive List menu and highlight the RAID set that you want to rebuild. Press to begin rebuilding the Mirror configuration.

A status bar at the bottom of the screen shows the progress of the rebuilding.

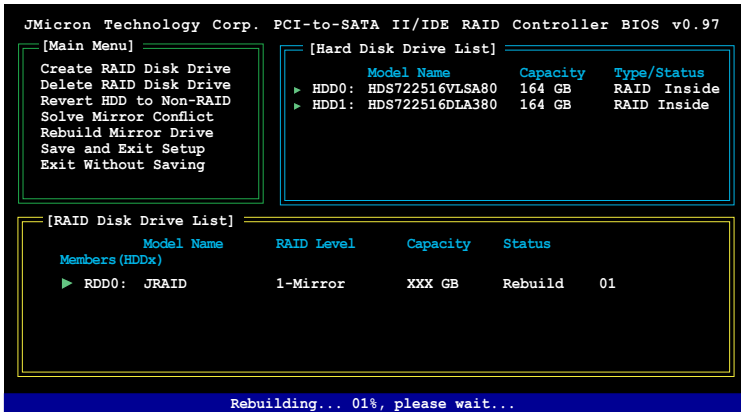

Saving the settings and exiting setup

When you have finished, highlight Save & Exit Setup using the up/down arrow key then press <Enter> to save the current RAID configuration and exit the JMB363 RAID BIOS utility.

A dialogue box appears to confirm the action. Press <Y> to confirm; otherwise, press <N> to return to the JMB RAID BIOS menu.

5.5 Creating a RAID driver disk

A floppy disk with the RAID driver is required when installing Windows® XP/Vista and later operating system on a hard disk drive that is included in a RAID set. For Windows Vista user, you can create a RAID driver disk with a floppy disk drive or a USB flash disk drive.

5.5.1 Creating a RAID driver disk without entering the OS

To create a RAID driver disk without entering the OS:

1. Boot your computer.
2. Press during POST to enter the BIOS setup utility.
3. Set the optical drive as the primary boot device.
4. Insert the support CD into the optical drive.
5. Save changes and exit BIOS.
6. Press any key when the system prompts “Press any key to boot from the optical drive.”
7. When the menu appears, press <1> to create a RAID driver disk.
8. Insert a formatted floppy disk into the floppy drive then press <Enter>.
9. Follow succeeding screen instructions to complete the process.

5.5.2 Creating a RAID driver disk in Windows®

To create a RAID driver disk in Windows®:

1. Start Windows®.
2. Place the motherboard support CD into the optical drive.
3. Go to the Make Disk menu, then click **Intel ICH9R 32/64 bit RAID Driver Disk** to create an Intel® ICH9R RAID driver disk or the **Make JMicron JMB36X 32/64-bit RAID Driver** to create a JMicron JMB363 RAID driver disk.
4. Insert a floppy disk into the floppy disk drive or connect a USB flash disk if you are using Windows Vista OS.
5. Follow succeeding screen instructions to complete the process.



Write-protect the floppy disk to avoid computer virus infection.

To install the RAID driver in Windows XP:

1. During the OS installation, the system prompts you to press the <F6> key to install third-party SCSI or RAID driver.
2. Press <F6> then insert the floppy disk with RAID driver into the floppy disk drive.
3. When prompted to select the SCSI adapter to install, make sure you select Intel(R) SATA RAID Controller (Desktop ICH9R) and JMicron JMB363.
4. Follow the succeeding screen instructions to complete the installation.

To install the RAID driver in Windows® Vista:

1. Insert the floppy disk/USB device with RAID driver into the floppy disk drive/USB port.
2. During the OS installation, select **JMicron JMB363**.
3. Follow the succeeding screen instructions to complete the installation.

This chapter tells how to install ATI®
CrossFire™ graphics cards to avail of
ATI's Multi-Video Processing technology.

ATI® CrossFire™ technology support

A large, light gray, stylized number '6' is positioned behind the text 'ATI® CrossFire™' and 'technology support', partially overlapping them.

6.1	Overview	6-1
6.2	Installing CrossFire™ graphics cards	6-2
6.3	Software information	6-5

6.1 Overview

The motherboard supports the ATI® CrossFire™ technology that allows you to install multi-graphics processing units (GPU) graphics cards. Follow the installation procedures in this section.

6.1.1 Requirements

- CrossFire™ Edition graphics card (Master)
- CrossFire™-ready graphics card (Slave)
- CrossFire™-ready motherboard
- Make sure that your power supply unit (PSU) can provide at least the minimum power required by your system. See **8. ATX Power connectors** on page 2-33 for details.



-
- Visit the ATI website or download the Radeon® X850 Crossfire™ Edition User's Guide from the support CD for detailed hardware requirements and installation procedures.
 - The ATI CrossFire™ technology supports only the following operating systems:
 - Windows® XP 32-bit (Home or Professional) with Service Pack 2 (SP2)
 - Windows® XP Professional 64-bit Edition.
 - Make sure that your graphics card driver supports the ATI® CrossFire™ Technology. Download the latest driver from the ATI website (www.ati.com)
 - The maximum resolution of Radeon™ X850 CrossFire™ Edition is 1600 x 1200 at 65 MHz when you use DVI output.
-

6.1.2 Before you begin

Uninstall other graphics card drivers in your system

To uninstall other graphics card drivers:

1. Close all current applications.
2. Go to **Control Panel > Add/Remove Programs**.
3. Select your current graphics card driver/s.
4. Select **Add/Remove**.
5. Restart your system.

6.2 Installing CrossFire™ graphics cards



Before installing a CrossFire™ system, refer to the user guide that came with the ATI® CrossFire™ Edition graphics card.

To install the graphics cards:

1. Prepare one CrossFire™ Edition (Master) graphics card and one CrossFire™-ready (Slave) graphics card.

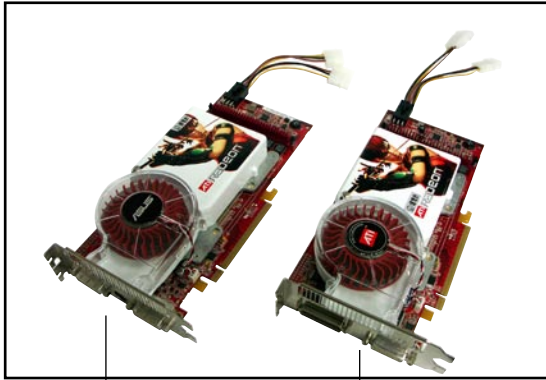

Slave graphics card

Master graphics card

2. Insert the CrossFire™ Edition (Master) graphics card into the PCI Express x16 blue slot. Make sure that the card is properly seated on the slot.

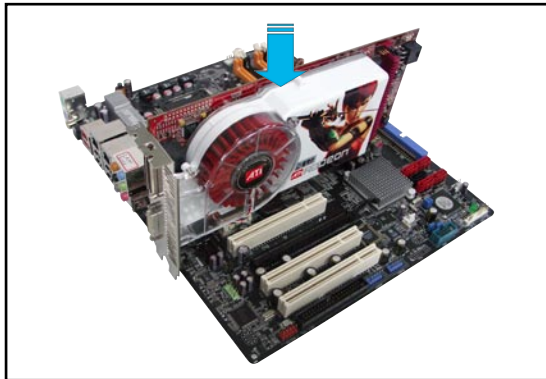

3. Insert the CrossFire™-ready (Slave) graphics card into the PCI Express x16 black slot. Make sure that the card is properly seated on the slot.

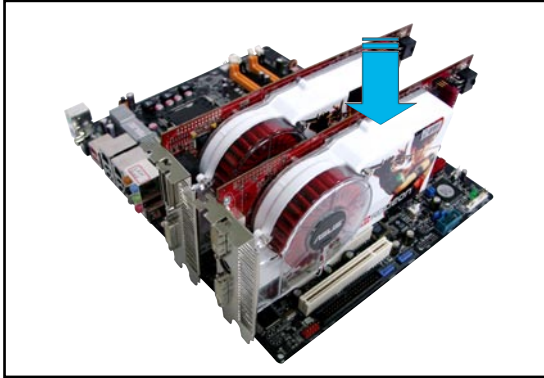

4. Connect an auxiliary power source from the power supply to the graphics cards.

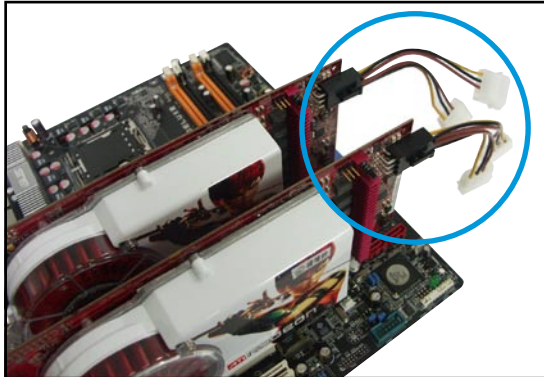

5. Connect one end of the external cable to the Master graphics card.

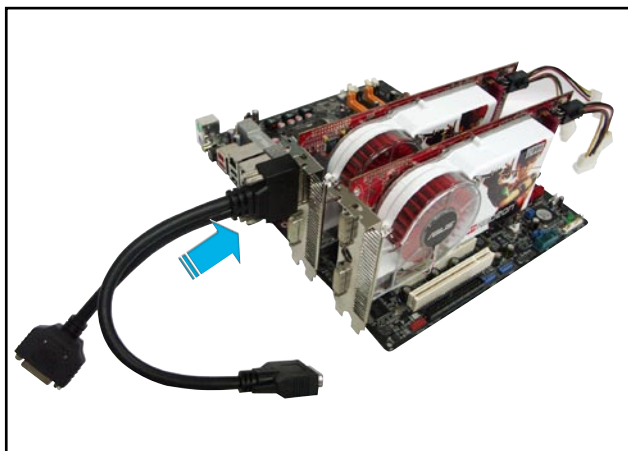

6. Connect the other end of the external cable to the Slave graphics card.
7. Connect the loose end to the corresponding port on your monitor.

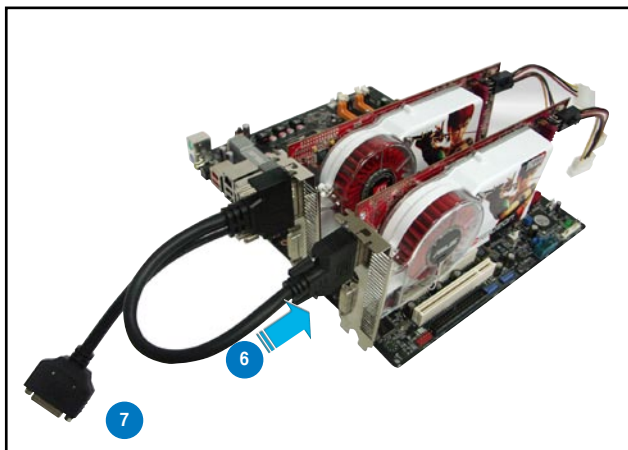

6.3 Software information

6.3.1 Installing the device drivers

Refer to the documentation that came with your graphics card package to install the device drivers.



The ATI CrossFire™ technology supports only the following operating systems:

- Windows® XP 32-bit (Home or Professional) with Service Pack 2 (SP2)
- Windows® XP Professional 64-bit Edition.
- Windows® Vista 32/64 bit Edition. (Will be ready later. Visit the ATI website (www.ati.com))

1. Turn on your system and log in with administrator rights.
2. Windows® auto-detects the CrossFire™ graphics cards and displays the Found New Hardware Wizard window. Click **Cancel**.
3. Place the CrossFire™ installation CD in your optical drive and install drivers from the opening menu.



4. Click **Next** to continue from the installation window that appears.

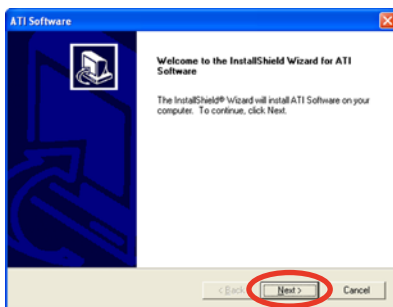

5. Read the License Agreement, then click **Yes**.

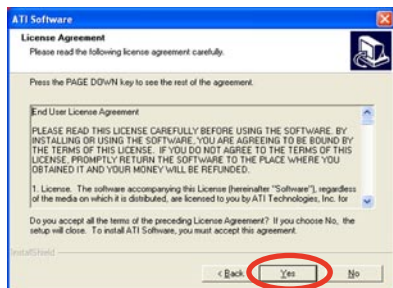

6. Select the components that you want to install, then click **Next**.

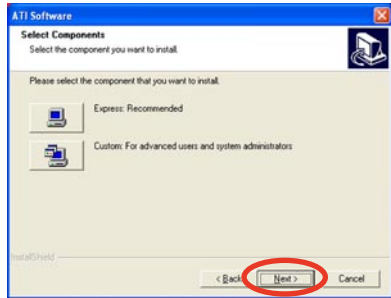

- Select Express to install the HydraVision™ multi-monitor and desktop management software, as well as the ATI driver.
- Select Custom to individually choose desired software components.

Setup prepares the installation wizard that will guide you to setup process.

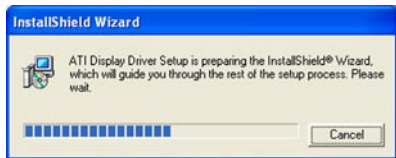

Windows automatically configures the ATI Catalyst Control Center. The status windows indicates the progress of the installation.



7. The Setup Complete window appears, indicating that the driver files have been copied to your computer.

Click **Yes** to restart your computer now or **No** to restart later

8. Click **Finish**.

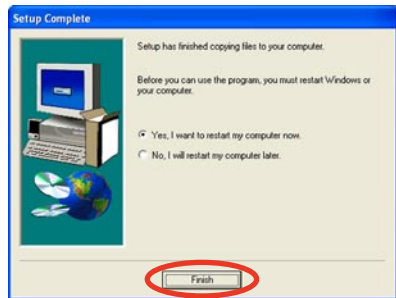

6.3.2 Using the Catalyst™ Control Center

The Catalyst™ Control Center allows you to access display features of the ATI hardware and software you installed. Use this application to adjust your graphic settings, enable/disable connected devices, and change your desktop orientation.

Launching the Catalyst™ Control Center

There are several ways to launch the Catalyst™ Control Center:

- On the Windows® task bar, click **Start > ATI Catalyst™ Control Center > Catalyst™ Control Center**
- Double-click the Catalyst™ Control Center desktop shortcut.



- On the Windows® task bar, double-click the Catalyst™ Control Center icon.



The Catalyst™ Control Center Dialog Box

View

The Catalyst™ Control Center provides two views:

Standard - simple view with wizards for beginners



Advance - allows advanced users to access and configure the complete features of the software



Set to **Advance** view to enable the CrossFire™ function.

To enable CrossFire™:

1. Set the view to **Advance**.
2. Click the Crossfire™ item in Graphics Settings.
3. In the CrossFire™ Settings dialog, tick the box opposite **Enable CrossFire™**.
4. Click **OK** to effect the setting.



Hotkeys

Click the **Hotkeys** tab on the Catalyst™ Control Center to access the Hotkeys Manager, which allows you to create key combinations as shortcuts for performing certain functions quickly.



Profiles

Click the **Profiles** tab on the Catalyst™ Control Center to access the Profiles Manager, which allows you to create customized environments for your desktop, video, and 3D applications.



Preferences

Click the **Preferences** tab on the Catalyst™ Control Center to select a language, restore defaults, change skins, or enable/disable the System Tray icon.



Help

Click the **Help** tab on the Catalyst™ Control Center to access the online help system, generate a Problem Report, and get the Catalyst™ Control Center version information.



The Appendix describes the CPU features and technologies that the motherboard supports.

CPU features



Chapter summary



A.1	Intel® EM64T.....	A-1
A.2	Enhanced Intel SpeedStep® Technology (EIST).....	A-1
A.3	Intel® Hyper-Threading Technology	A-3

A.1 Intel® EM64T



- The motherboard is fully compatible with Intel® LGA775 processors running on 32-bit operating systems.
- The motherboard comes with a BIOS file that supports EM64T. You can download the latest BIOS file from the ASUS website (www.asus.com/support/download/) if you need to update the BIOS file. See Chapter 4 for details.
- Visit www.intel.com for more information on the EM64T feature.
- Visit www.microsoft.com for more information on Windows® 64-bit OS.

Using the Intel® EM64T feature

To use the Intel® EM64T feature:

1. Install an Intel® CPU that supports the Intel® EM64T.
2. Install a 64-bit operating system (Windows® Vista 64-bit Edition or Windows® XP Professional x64 Edition).
3. Install the 64-bit drivers for the motherboard components and devices from the support DVD.
4. Install the 64-bit drivers for expansion cards or add-on devices, if any.



Refer to the expansion card or add-on device(s) documentation, or visit the related website, to verify if the card/device supports a 64-bit system.

A.2 Enhanced Intel SpeedStep® Technology (EIST)



- The motherboard comes with a BIOS file that supports EIST. You can download the latest BIOS file from the ASUS website (www.asus.com/support/download/) if you need to update the BIOS. See Chapter 4 for details.
- Visit www.intel.com for more information on the EIST feature.

A.2.1 System requirements

Before using EIST, check your system if it meets the following requirements:

- Intel® processor with EIST support
- BIOS file with EIST support
- Operating system with EIST support (Windows® Vista, Windows® XP SP2/ Linux 2.6 kernel or later versions)

A.2.2 Using the EIST

To use the EIST feature:

1. Turn on the computer, then enter the BIOS Setup.
2. Go to the Advanced Menu, highlight CPU Configuration, then press <Enter>.
3. Set the Intel(R) SpeedStep Technology item to [Automatic], then press <Enter>.
4. Press <F10> to save your changes and exit the BIOS setup.
5. After the computer restarts, right click on a blank space on the desktop, then select Properties from the pop-up menu.
6. When the Display Properties window appears, click the Screen Saver tab.
7. Click the Power button on the Monitor power section to open the Power Options Properties window.

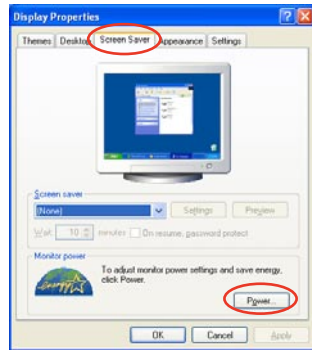

8. On the Power schemes section, click , then select any option except Home/Office Desktop or Always On.
9. Click Apply, then click OK.
10. Close the Display Properties window.

After you adjust the power scheme, the CPU internal frequency slightly decreases when the CPU loading is low.

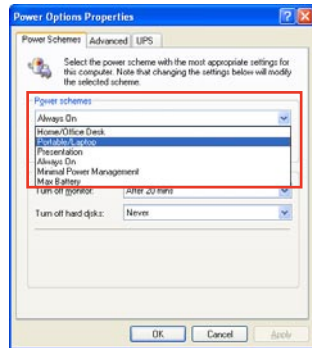

The screen displays and procedures may vary depending on the operating system.

A.3 Intel® Hyper-Threading Technology



- The motherboard supports Intel® Pentium® 4 LGA775 processors with Hyper-Threading Technology.
 - Hyper-Threading Technology is supported under Windows® Vista/XP and Linux 2.4.x (kernel) and later versions only. Under Linux, use the Hyper-Threading compiler to compile the code. If you are using any other operating systems, disable the Hyper-Threading Technology item in the BIOS to ensure system stability and performance.
 - Installing Windows® XP Service Pack 1 or later version is recommended.
 - Make sure to enable the Hyper-Threading Technology item in BIOS before installing a supported operating system.
 - For more information on Hyper-Threading Technology, visit www.intel.com/info/hyperthreading.
-

Using the Hyper-Threading Technology

To use the Hyper-Threading Technology:

1. Install an Intel® Pentium® 4 CPU that supports Hyper-Threading Technology.
2. Power up the system and enter the BIOS Setup. Under the Advanced Menu, make sure that the item **Hyper-Threading Technology** is set to [Enabled].
The BIOS item appears only if you installed a CPU that supports Hyper-Threading Technology.
3. Restart the computer.

