

**P5LD2-X/1333**



**Motherboard**

E3519

Revised Edition V2

October 2007

Copyright © 2007 ASUSTeK COMPUTER INC. All Rights Reserved.

No part of this manual, including the products and software described in it, may be reproduced, transmitted, transcribed, stored in a retrieval system, or translated into any language in any form or by any means, except documentation kept by the purchaser for backup purposes, without the express written permission of ASUSTeK COMPUTER INC. ("ASUS").

Product warranty or service will not be extended if: (1) the product is repaired, modified or altered, unless such repair, modification or alteration is authorized in writing by ASUS; or (2) the serial number of the product is defaced or missing.

ASUS PROVIDES THIS MANUAL "AS IS" WITHOUT WARRANTY OF ANY KIND, EITHER EXPRESS OR IMPLIED, INCLUDING BUT NOT LIMITED TO THE IMPLIED WARRANTIES OR CONDITIONS OF MERCHANTABILITY OR FITNESS FOR A PARTICULAR PURPOSE. IN NO EVENT SHALL ASUS, ITS DIRECTORS, OFFICERS, EMPLOYEES OR AGENTS BE LIABLE FOR ANY INDIRECT, SPECIAL, INCIDENTAL, OR CONSEQUENTIAL DAMAGES (INCLUDING DAMAGES FOR LOSS OF PROFITS, LOSS OF BUSINESS, LOSS OF USE OR DATA, INTERRUPTION OF BUSINESS AND THE LIKE), EVEN IF ASUS HAS BEEN ADVISED OF THE POSSIBILITY OF SUCH DAMAGES ARISING FROM ANY DEFECT OR ERROR IN THIS MANUAL OR PRODUCT.

SPECIFICATIONS AND INFORMATION CONTAINED IN THIS MANUAL ARE FURNISHED FOR INFORMATIONAL USE ONLY, AND ARE SUBJECT TO CHANGE AT ANY TIME WITHOUT NOTICE, AND SHOULD NOT BE CONSTRUED AS A COMMITMENT BY ASUS. ASUS ASSUMES NO RESPONSIBILITY OR LIABILITY FOR ANY ERRORS OR INACCURACIES THAT MAY APPEAR IN THIS MANUAL, INCLUDING THE PRODUCTS AND SOFTWARE DESCRIBED IN IT.

Products and corporate names appearing in this manual may or may not be registered trademarks or copyrights of their respective companies, and are used only for identification or explanation and to the owners' benefit, without intent to infringe.

# Contents

Notices.....	vi
Safety information .....	vii
About this guide .....	viii
P5LD2-X/1333 specifications summary.....	x

## Chapter 1: Product introduction

1.1	Welcome! .....	1-1
1.2	Package contents.....	1-1
1.3	Special features.....	1-2
1.3.1	Product highlights .....	1-2
1.3.2	Innovative ASUS features.....	1-4

## Chapter 2: Hardware information

2.1	Before you proceed .....	2-1
2.2	Motherboard overview.....	2-2
2.2.1	Placement direction .....	2-2
2.2.2	Screw holes .....	2-2
2.2.3	Motherboard layout.....	2-3
2.2.4	Layout contents.....	2-4
2.3	Central Processing Unit (CPU) .....	2-6
2.3.1	Installing the CPU .....	2-6
2.3.2	Installing the CPU heatsink and fan.....	2-9
2.3.3	Uninstalling the CPU heatsink and fan .....	2-11
2.4	System memory .....	2-13
2.4.1	Overview .....	2-13
2.4.2	Memory configurations.....	2-13
2.4.3	Installing a DIMM .....	2-17
2.4.4	Removing a DIMM .....	2-17
2.5	Expansion slots.....	2-18
2.5.1	Installing an expansion card .....	2-18
2.5.2	Configuring an expansion card .....	2-18
2.5.3	Interrupt assignments .....	2-19
2.5.4	PCI slots.....	2-20
2.5.5	PCI Express x16 slot.....	2-20
2.5.6	PCI Express x1 slot.....	2-20
2.6	Jumpers .....	2-21

# Contents

<b>2.7</b>	<b>Connectors</b> .....	<b>2-23</b>
2.7.1	Rear panel connectors .....	2-23
2.7.2	Internal connectors .....	2-24

## Chapter 3: Powering up

<b>3.1</b>	<b>Starting up for the first time</b> .....	<b>3-1</b>
<b>3.2</b>	<b>Powering off the computer</b> .....	<b>3-2</b>
3.2.1	Using the OS shut down function .....	3-2
3.2.2	Using the dual function power switch .....	3-2

## Chapter 4: BIOS setup

<b>4.1</b>	<b>Managing and updating your BIOS</b> .....	<b>4-1</b>
4.1.1	Creating a bootable floppy disk .....	4-1
4.1.2	AFUDOS utility .....	4-2
4.1.3	ASUS CrashFree BIOS 2 utility .....	4-5
4.1.4	ASUS EZ Flash utility .....	4-7
4.1.5	ASUS Update utility .....	4-8
<b>4.2</b>	<b>BIOS setup program</b> .....	<b>4-11</b>
4.2.1	BIOS menu screen .....	4-12
4.2.2	Menu bar .....	4-12
4.2.3	Navigation keys .....	4-12
4.2.4	Menu items .....	4-13
4.2.5	Sub-menu items .....	4-13
4.2.6	Configuration fields .....	4-13
4.2.7	Pop-up window .....	4-13
4.2.8	Scroll bar .....	4-13
4.2.9	General help .....	4-13
<b>4.3</b>	<b>Main menu</b> .....	<b>4-14</b>
4.3.1	System Time .....	4-14
4.3.2	System Date .....	4-14
4.3.3	Legacy Diskette A .....	4-14
4.3.4	Primary, Third and Fourth IDE Master/Slave .....	4-15
4.3.5	IDE Configuration .....	4-16
4.3.6	System Information .....	4-17
<b>4.4</b>	<b>Advanced menu</b> .....	<b>4-18</b>
4.4.1	USB Configuration .....	4-18

# Contents

4.4.2	CPU Configuration .....	4-20
4.4.3	Chipset .....	4-21
4.4.4	Onboard Devices Configuration .....	4-23
4.4.5	PCI PnP .....	4-25
<b>4.5</b>	<b>Power menu .....</b>	<b>4-27</b>
4.5.1	Suspend Mode .....	4-27
4.5.2	ACPI 2.0 Support .....	4-27
4.5.3	ACPI APIC Support .....	4-27
4.5.4	APM Configuration .....	4-28
4.5.5	Hardware Monitor .....	4-30
<b>4.6</b>	<b>Boot menu .....</b>	<b>4-31</b>
4.6.1	Boot Device Priority .....	4-31
4.6.2	Boot Settings Configuration .....	4-32
4.6.3	Security .....	4-33
<b>4.7</b>	<b>Exit menu .....</b>	<b>4-36</b>

## Chapter 5: Software support

<b>5.1</b>	<b>Installing an operating system .....</b>	<b>5-1</b>
<b>5.2</b>	<b>Support CD information .....</b>	<b>5-1</b>
5.2.1	Running the support CD .....	5-1
5.2.2	Drivers menu .....	5-2
5.2.3	Utilities menu .....	5-3
5.2.4	ASUS Contact information .....	5-4
5.2.5	Other information .....	5-4
<b>5.3</b>	<b>ASUS MyLogo™ .....</b>	<b>5-6</b>

## Appendix: CPU features

<b>A.1</b>	<b>Enhanced Intel SpeedStep® Technology (EIST) .....</b>	<b>A-1</b>
A.1.1	System requirements .....	A-1
A.1.2	Using the EIST .....	A-1
<b>A.2</b>	<b>Intel® Hyper-Threading Technology .....</b>	<b>A-2</b>
	Using the Hyper-Threading Technology .....	A-2

# Notices

## Federal Communications Commission Statement

This device complies with Part 15 of the FCC Rules. Operation is subject to the following two conditions:

- This device may not cause harmful interference, and
- This device must accept any interference received including interference that may cause undesired operation.

This equipment has been tested and found to comply with the limits for a Class B digital device, pursuant to Part 15 of the FCC Rules. These limits are designed to provide reasonable protection against harmful interference in a residential installation. This equipment generates, uses and can radiate radio frequency energy and, if not installed and used in accordance with manufacturer's instructions, may cause harmful interference to radio communications. However, there is no guarantee that interference will not occur in a particular installation. If this equipment does cause harmful interference to radio or television reception, which can be determined by turning the equipment off and on, the user is encouraged to try to correct the interference by one or more of the following measures:

- Reorient or relocate the receiving antenna.
- Increase the separation between the equipment and receiver.
- Connect the equipment to an outlet on a circuit different from that to which the receiver is connected.
- Consult the dealer or an experienced radio/TV technician for help.



---

The use of shielded cables for connection of the monitor to the graphics card is required to assure compliance with FCC regulations. Changes or modifications to this unit not expressly approved by the party responsible for compliance could void the user's authority to operate this equipment.

---

## Canadian Department of Communications Statement

This digital apparatus does not exceed the Class B limits for radio noise emissions from digital apparatus set out in the Radio Interference Regulations of the Canadian Department of Communications.

This class B digital apparatus complies with Canadian ICES-003.

# Safety information

## Electrical safety

- To prevent electrical shock hazard, disconnect the power cable from the electrical outlet before relocating the system.
- When adding or removing devices to or from the system, ensure that the power cables for the devices are unplugged before the signal cables are connected. If possible, disconnect all power cables from the existing system before you add a device.
- Before connecting or removing signal cables from the motherboard, ensure that all power cables are unplugged.
- Seek professional assistance before using an adapter or extension cord. These devices could interrupt the grounding circuit.
- Make sure that your power supply is set to the correct voltage in your area. If you are not sure about the voltage of the electrical outlet you are using, contact your local power company.
- If the power supply is broken, do not try to fix it by yourself. Contact a qualified service technician or your retailer.

## Operation safety

- Before installing the motherboard and adding devices on it, carefully read all the manuals that came with the package.
- Before using the product, make sure all cables are correctly connected and the power cables are not damaged. If you detect any damage, contact your dealer immediately.
- To avoid short circuits, keep paper clips, screws, and staples away from connectors, slots, sockets and circuitry.
- Avoid dust, humidity, and temperature extremes. Do not place the product in any area where it may become wet.
- Place the product on a stable surface.
- If you encounter technical problems with the product, contact a qualified service technician or your retailer.



---

The symbol of the crossed out wheeled bin indicates that the product (electrical, electronic equipment, Mercury-containing button cell battery) should not be placed in municipal waste. Check local regulations for disposal of electronic products.

---

# About this guide

This user guide contains the information you need when installing and configuring the motherboard.

## How this guide is organized

This guide contains the following parts:

- **Chapter 1: Product introduction**  
This chapter describes the features of the motherboard and the new technology it supports.
- **Chapter 2: Hardware information**  
This chapter lists the hardware setup procedures that you have to perform when installing system components. It includes description of the switches, jumpers, and connectors on the motherboard.
- **Chapter 3: Powering up**  
This chapter describes the power up sequence, the vocal POST messages, and ways of shutting down the system.
- **Chapter 4: BIOS setup**  
This chapter tells how to change system settings through the BIOS Setup menus. Detailed descriptions of the BIOS parameters are also provided.
- **Chapter 5: Software support**  
This chapter describes the contents of the support CD that comes with the motherboard package.
- **Appendix: CPU features**  
The Appendix describes the CPU features that the motherboard supports.

## Where to find more information

Refer to the following sources for additional information and for product and software updates.

1. **ASUS websites**  
The ASUS website provides updated information on ASUS hardware and software products. Refer to the ASUS contact information.
2. **Optional documentation**  
Your product package may include optional documentation, such as warranty flyers, that may have been added by your dealer. These documents are not part of the standard package.



## Conventions used in this guide

To make sure that you perform certain tasks properly, take note of the following symbols used throughout this manual.



**DANGER/WARNING:** Information to prevent injury to yourself when trying to complete a task.



**CAUTION:** Information to prevent damage to the components when trying to complete a task.



**IMPORTANT:** Instructions that you **MUST** follow to complete a task.



**NOTE:** Tips and additional information to help you complete a task.

## Typography

**Bold text**

Indicates a menu or an item to select.

*Italics*

Used to emphasize a word or a phrase.

<Key>

Keys enclosed in the less-than and greater-than sign means that you must press the enclosed key.

Example: <Enter> means that you must press the Enter or Return key.

<Key1>+<Key2>+<Key3>

If you must press two or more keys simultaneously, the key names are linked with a plus sign (+).

Example: <Ctrl>+<Alt>+<D>

**Command**

Means that you must type the command exactly as shown, then supply the required item or value enclosed in brackets.

Example: At the DOS prompt, type the command line:

```
afudos /i [filename]
afudos /iP5LD2XOC.ROM
```

## P5LD2-X/1333 specifications summary

CPU	LGA775 socket for Intel® Prescott/Smithfield/Cedarmill/Conroe/Conroe L/Presler processors Supports Intel® EIST/Hyper-Threading Technology
Chipset	Northbridge: Intel® MCH 945GC Southbridge: Intel® ICH7
Front Side Bus	1333(O.C)/1066/800/533 MHz
Memory	2 x 240-pin DIMM sockets support unbuffered non-ECC DDR2 400/533/667 memory modules Supports up to 2 GB system memory
Expansion slots	1 x PCIe x16 slot for discrete graphic card 2 x PCIe x1 slots 3 x PCI slots
Storage	Intel® ICH7 South Bridge supports: - 1 x Ultra DMA 100/66 - 4 x Serial ATA 3Gb/s devices
Audio	ALC662 High Definition Audio 6-channel CODEC Supports S/PDIF out interface and Jack-detect
USB	Supports up to 8 USB 2.0/USB 1.1 ports
LAN	PCIe 10/100Mb LAN
ASUS special features	ASUS C.P.R. (CPU Parameter Recall) ASUS CrashFree BIOS 2 ASUS MyLogo ASUS EZ Flash ASUS Q-fan ASUS CPU Lock Free ASUS CPU multiplier
BIOS features	4 Mb Flash ROM, AMI BIOS Special H/W write production, PnP, DMI v2.0, WfM2.0 SM BIOS v2.4, ACPI v2.0
Back Panel I/O Ports	1 x Parallel port 1 x COM 1 x S/PDIF Out port 1 x PS/2 keyboard port 1 x PS/2 mouse port 1 x RJ45 4 x USB 2.0/1.1 6-channel Audio I/O

(continued on the next page)

## P5LD2-X/1333 specifications summary

Internal I/O connectors	Azalia High Definition Analog Front Panel Audio connector Chassis Intrusion 1 x 4-pin internal speaker connector 1 x 24-pin EPS12V power connector 1 x 4-pin ATX 12V power connector 2 x USB connectors for 4 additional USB 2.0 ports 1 x CD audio-in connector CPU/Chassis fan connectors
Manageability	WOL by PME, WOR by PME, WOR by Ring
Support CD contents	Drivers ASUS PC Probe II ASUS LiveUpdate Utility
Accessories	1 x SATA cable 1 x SATA power cable 1 x FDD cable 1 x UltraDMA 100/66 cable 1 x I/O Shield User's manual
Form Factor	ATX Form Factor, 12"x7.2" (30.5cm x 18.3cm)

\*Specifications are subject to change without notice.



This chapter describes the motherboard features and the new technologies it supports.

# 1 Product introduction

# Chapter summary



- 1.1 Welcome! ..... 1-1
- 1.2 Package contents..... 1-1
- 1.3 Special features..... 1-2

## 1.1 Welcome!

Thank you for buying an ASUS® P5LD2-X/1333 motherboard!

The motherboard delivers a host of new features and latest technologies, making it another standout in the long line of ASUS quality motherboards!

Before you start installing the motherboard, and hardware devices on it, check the items in your package with the list below.

## 1.2 Package contents

Check your motherboard package for the following items.

<b>Motherboard</b>	ASUS P5LD2-X/1333 motherboard
<b>Cables</b>	1 x FDD cable 1 x SATA cable 1 x SATA power cable 1 x UltraDMA 100/66 cable
<b>Accessories</b>	I/O shield
<b>Application CDs</b>	ASUS motherboard support CD
<b>Documentation</b>	User guide



If any of the above items is damaged or missing, contact your retailer.

## 1.3 Special features

### 1.3.1 Product highlights

#### Latest processor technology

The motherboard comes with a 775-pin surface mount Land Grid Array (LGA) socket designed for the Intel® Prescott, Intel® Smithfield, Intel® Cedarmill, Intel® Conroe, Intel® Conroe L or Intel® Presler processor in the 775-land package. The motherboard supports the processors with 1333 (O.C)/1066/800/533 MHz Front Side Bus (FSB). The motherboard also supports the Intel® Hyper-Threading Technology and Enhanced Intel® SpeedStep Technology (EIST). See pages 2-6, A-1 and A-2 for details.



#### Intel® Core™2

This motherboard supports the latest Intel® Core™2 processor in the LGA775 package. With the new Intel® Core™ microarchitecture technology and 1333 (O.C)/1066/800/533 MHz FSB, Intel® Core™2 processor is one of the most powerful and energy efficient CPU in the world.



#### Intel® 65nm Dual-Core CPU support

This motherboard support Intel® Prescott, Intel® Smithfield, Intel® Cedarmill, Intel® Conroe, Intel® Conroe L or Intel® Presler processors built on the 65-nanometer (nm) process technology with copper interconnect. Dual-core processors contain two physical CPU cores with dedicated L2 caches to meet demands for more powerful processing. The 65nm process of Intel® is the most advanced chip manufacturing technology, delivering breakthrough performance, enhanced media experience, and low power consumption. Intel® 65nm dual-core processors utilize the latest package technologies for a thinner, lighter design without compromising performance.



#### 64-bit CPU support

64-bit computing, the next generation technology to replace current 32-bit architecture, delivers advanced system performance, faster memory access and increased productivity. This motherboard provides excellent compatibility and flexibility by supporting either 64-bit or 32-bit architecture.



## DDR2 memory support



The motherboard supports DDR2 memory that features data transfer rates of 667/533/400 MHz to meet the higher bandwidth requirements of the latest 3D graphics, multimedia, and Internet applications. The dual-channel DDR2 architecture doubles the bandwidth of your system memory to boost system performance, eliminating bottlenecks with peak bandwidths of up to 10.6 GB/s. See page 2-13 for details.

## High Definition Audio



The onboard 6-channel ALC662 High Definition audio CODEC enables high-quality audio which automatically detects peripherals are plugged into the audio I/O jacks. ALC662 also supports Windows® Vista Premium. See pages 2-23 for details.

## Serial ATA 3.0 Gb/s technology



This motherboard supports the next-generation hard drives based on the Serial ATA (SATA) 3Gb/s storage specification, delivering enhanced scalability and doubling the bus bandwidth for high-speed data retrieval and saves. Easily backup photos, videos and other entertainment contents to external devices. See page 2-25 for details.

## S/PDIF digital sound ready



The motherboard supports the S/PDIF technology through the S/PDIF interfaces on the rear panel. The S/PDIF technology turns your computer into a high-end entertainment system with digital connectivity to powerful audio and speaker systems. See page 2-24 for details.

## PCI Express™ interface



The motherboard fully supports PCI Express, the latest I/O interconnect technology that speeds up the PCI bus. PCI Express features point-to-point serial interconnections between devices and allows higher clockspeeds by carrying data in packets. This high speed interface is software compatible with existing PCI specifications. See page 2-20 for details.

## USB 2.0 technology



The motherboard implements the Universal Serial Bus (USB) 2.0 specification, dramatically increasing the connection speed from the 12 Mbps bandwidth on USB 1.1 to a fast 480 Mbps on USB 2.0. USB 2.0 is backward compatible with USB 1.1. See pages 2-24 and 2-27 for details.

## Green ASUS



The motherboard and its packaging comply with the European Union's Restriction on the use of Hazardous Substances (RoHS). This is in line with the ASUS vision of creating environment-friendly and recyclable products and packaging to safeguard consumers' health while minimizing the impact on the environment.

### 1.3.2 Innovative ASUS features

#### ASUS CrashFree BIOS 2

This feature allows you to restore the original BIOS data from the support CD in case when the BIOS codes and data are corrupted. This protection eliminates the need to buy a replacement ROM chip. See page 4-5 for details.

#### ASUS Q-Fan technology

The ASUS Q-Fan technology smartly adjusts the fan speeds according to the system loading to ensure quiet, cool, and efficient operation. See page 4-30 for details.

#### ASUS EZ Flash

With the ASUS EZ Flash, you can easily update the system BIOS even before loading the operating system. No need to use a DOS-based utility or boot from a floppy disk. See page 4-7 for details.

#### C.P.R. (CPU Parameter Recall)

The C.P.R. feature of the motherboard BIOS allows automatic re-setting to the BIOS default settings in case the system hangs due to overclocking. When the system hangs due to overclocking, C.P.R. eliminates the need to open the system chassis and clear the RTC data. Simply shut down and reboot the system, and the BIOS automatically restores the CPU default setting for each parameter.

#### ASUS CPU Lock Free

This feature allows you to adjust the CPU multiplier to 14x. Setting the appropriate BIOS setting automatically reduces the CPU multiplier value for more flexibility when increasing external FSB.

## ASUS MyLogo™



The new feature present in the motherboard allows you to personalize and add style to your system with customizable boot logos. See page 5-6 for details.



This chapter lists the hardware setup procedures that you have to perform when installing system components. It includes description of the jumpers and connectors on the motherboard.

# Hardware 2 information

2.1	Before you proceed .....	2-1
2.2	Motherboard overview.....	2-2
2.3	Central Processing Unit (CPU) .....	2-6
2.4	System memory .....	2-13
2.5	Expansion slots.....	2-18
2.6	Jumpers .....	2-21
2.7	Connectors .....	2-23

## 2.1 Before you proceed

Take note of the following precautions before you install motherboard components or change any motherboard settings.



- Unplug the power cord from the wall socket before touching any component.
- Use a grounded wrist strap or touch a safely grounded object or to a metal object, such as the power supply case, before handling components to avoid damaging them due to static electricity.
- Hold components by the edges to avoid touching the ICs on them.
- Whenever you uninstall any component, place it on a grounded antistatic pad or in the bag that came with the component.
- Before you install or remove any component, ensure that the ATX power supply is switched off or the power cord is detached from the power supply. Failure to do so may cause severe damage to the motherboard, peripherals, and/or components.

### Onboard LED

The motherboard comes with a standby power LED. The green LED lights up to indicate that the system is ON, in sleep mode, or in soft-off mode. This is a reminder that you should shut down the system and unplug the power cable before removing or plugging in any motherboard component. The illustration below shows the location of the onboard LED.

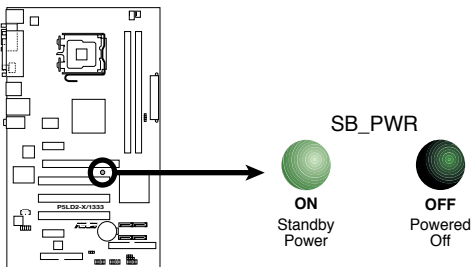

**P5LD2-X/1333 Onboard LED**

## 2.2 Motherboard overview

Before you install the motherboard, study the configuration of your chassis to ensure that the motherboard fits into it.



Make sure to unplug the power cord before installing or removing the motherboard. Failure to do so can cause you physical injury and damage motherboard components.

### 2.2.1 Placement direction

When installing the motherboard, make sure that you place it into the chassis in the correct orientation. The edge with external ports goes to the rear part of the chassis as indicated in the image below.

### 2.2.2 Screw holes

Place seven (7) screws into the holes indicated by circles to secure the motherboard to the chassis.



Do not overtighten the screws! Doing so can damage the motherboard.

Place this side towards  
the rear of the chassis

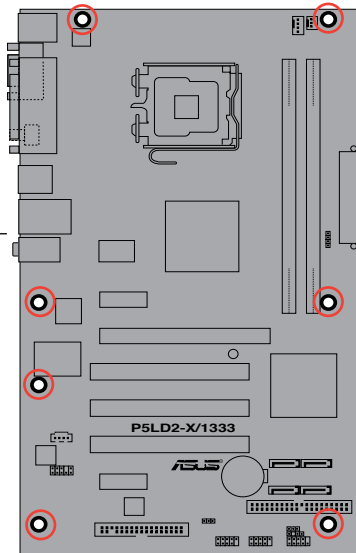



## 2.2.3 Motherboard layout

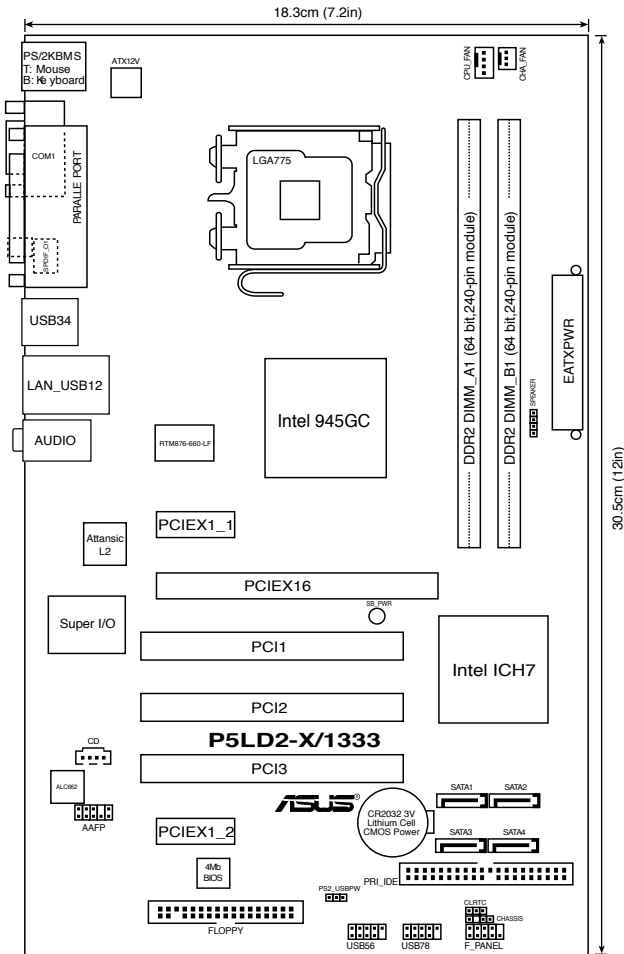

## 2.2.4 Layout contents

Slots	Page
1. PCIe x16	2-20
2. PCIe x 1	2-20
3. PCI	2-20

Jumpers	Page
1. Clear RTC RAM (3-pin CLRRTC)	2-21
2. USB Device wake-up (3-pin PS2_USBPWR)	2-22

Rear panel connectors	Page
1. PS/2 mouse port (green)	2-23
2. Parallel port	2-23
3. LAN (RJ-45) port	2-23
4. Line In port (light blue)	2-23
5. Line Out port (green)	2-23
6. Microphone port (pink)	2-23
7. USB 2.0 ports 1 and 2	2-24
8. USB 2.0 ports 3 and 4	2-24
9. Coaxial S/PDIF Out port	2-24
10. Serial port (COM1)	2-24
11. PS/2 keyboard port (purple)	2-24

Internal connectors		Page
1.	Floppy disk drive connector (34-1 pin FLOPPY)	2-24
2.	ICH7 Primary IDE connector (40-1 pin PRI_IDE)	2-25
3.	Serial ATA connectors (7-pin SATA1 [red], SATA2 [red], SATA3 [black], SATA4 [black])	2-25
4.	Optical drive audio connector (4-pin CD)	2-26
5.	Front panel audio connector (10-1 pin AAFP)	2-27
6.	USB connectors (10-1 pin USB56, USB78)	2-27
7.	CPU and Chassis Fan connectors (4-pin CPU_FAN, 3-pin CHA_FAN)	2-28
8.	Chassis intrusion connector (4-1 pin CHASSIS)	2-28
9.	ATX power connectors (24-pin EATXPWR, 4-pin ATX12V)	2-29
10.	Speaker connector (4-pin SPEAKER)	2-29
11.	System panel connector (10-1 pin F_PANEL)	2-30
	System power LED (2-pin PLED)	
	Hard disk drive activity LED (2-pin IDE_LED)	
	ATX power button/soft-off button (2-pin PWRBTN)	
	Reset button (2-pin RESET)	

## 2.3 Central Processing Unit (CPU)

The motherboard comes with a surface mount LGA775 socket designed for the Intel® Prescott/Smithfield/Cedarmill/ Conroe/Conroe L/Presler processor in the 775-land package



- Upon purchase of the motherboard, make sure that the PnP cap is on the socket and the socket contacts are not bent. Contact your retailer immediately if the PnP cap is missing, or if you see any damage to the PnP cap/socket contacts/motherboard components. ASUS will shoulder the cost of repair only if the damage is shipment/transit-related.
- Keep the cap after installing the motherboard. ASUS will process Return Merchandise Authorization (RMA) requests only if the motherboard comes with the cap on the LGA775 socket.
- The product warranty does not cover damage to the socket contacts resulting from incorrect CPU installation/removal, or misplacement/loss/incorrect removal of the PnP cap.

### 2.3.1 Installing the CPU

To install a CPU:

1. Locate the CPU socket on the motherboard.

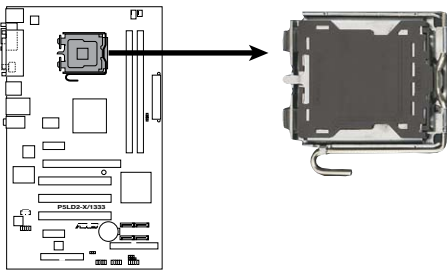

**P5LD2-X/1333 CPU Socket 775**



Before installing the CPU, make sure that the cam box is facing towards you and the load lever is on your left.

2. Press the load lever with your thumb (A), then move it to the left (B) until it is released from the retention tab.

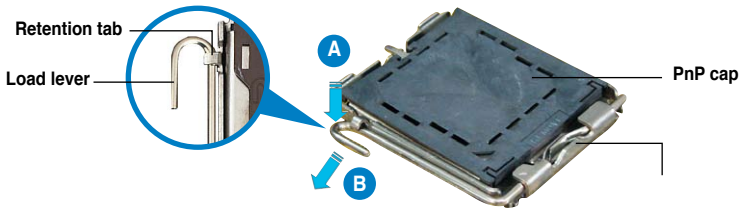

To prevent damage to the socket pins, do not remove the PnP cap unless you are installing a CPU.

3. Lift the load lever in the direction of the arrow to a 135° angle.

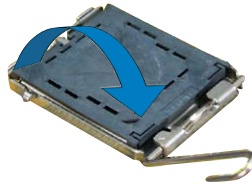

4. Lift the load plate with your thumb and forefinger to a 100° angle (A), then push the PnP cap from the load plate window to remove (B).

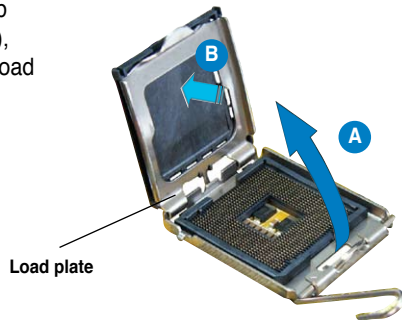

5. Position the CPU over the socket, making sure that the gold triangle is on the bottom-left corner of the socket. The socket alignment key should fit into the CPU notch.

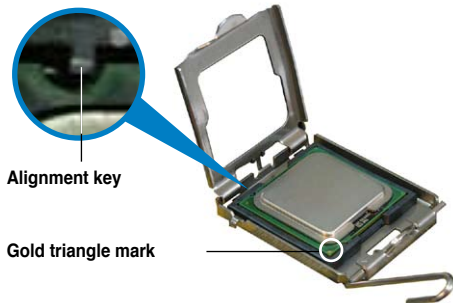



---

The CPU fits in only one correct orientation. DO NOT force the CPU into the socket to prevent bending the connectors on the socket and damaging the CPU!

---

6. Close the load plate (A), then push the load lever (B) until it snaps into the retention tab.

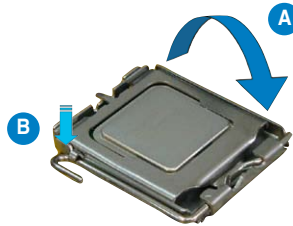

---

The motherboard supports Intel® Prescott/Smithfield/Cedarmill/ Conroe/Conroe L/Presler LGA775 processors with the Intel® Enhanced Intel SpeedStep® Technology (EIST) and Hyper-Threading Technology. Refer to the Appendix for more information on these CPU features.

---

## 2.3.2 Installing the CPU heatsink and fan

The Intel® Prescott/Smithfield/Cedarmill/ Conroe/Conroe L/Presler LGA775 processor requires a specially designed heatsink and fan assembly to ensure optimum thermal condition and performance.



- When you buy a boxed Intel® Prescott/Smithfield/Cedarmill/ Conroe/Conroe L/Presler processor, the package includes the CPU fan and heatsink assembly. If you buy a CPU separately, make sure that you use only Intel®-certified multi-directional heatsink and fan.
- Your Intel® Prescott/Smithfield/Cedarmill/ Conroe/Conroe L/Presler LGA775 heatsink and fan assembly comes in a push-pin design and requires no tool to install.
- If you purchased a separate CPU heatsink and fan assembly, make sure that you have properly applied Thermal Interface Material to the CPU heatsink or CPU before you install the heatsink and fan assembly.



Make sure that you have installed the motherboard to the chassis before you install the CPU fan and heatsink assembly.

To install the CPU heatsink and fan:

1. Place the heatsink on top of the installed CPU, making sure that the four fasteners match the holes on the motherboard.



Orient the heatsink and fan assembly such that the CPU fan cable is closest to the CPU fan connector.

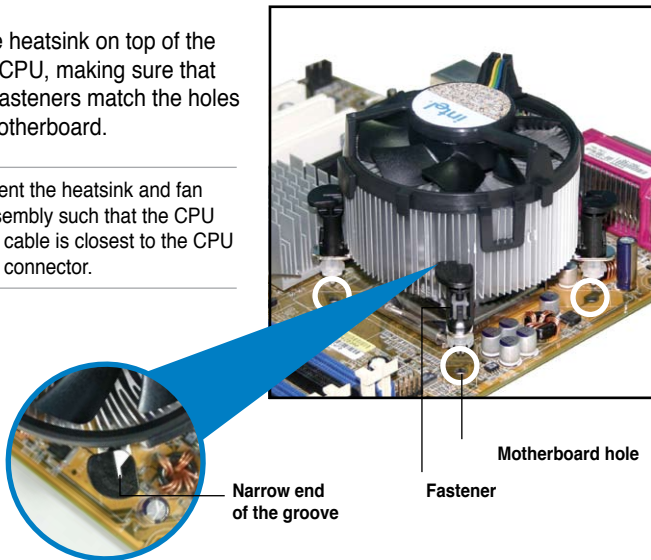

Make sure to orient each fastener with the narrow end of the groove pointing outward. (The photo shows the groove shaded for emphasis.)

2. Push down two fasteners at a time in a diagonal sequence to secure the heatsink and fan assembly in place.

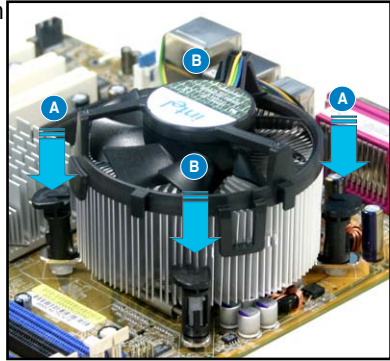
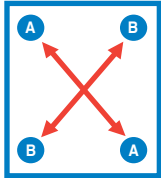

3. Connect the CPU fan cable to the connector on the motherboard labeled CPU\_FAN.

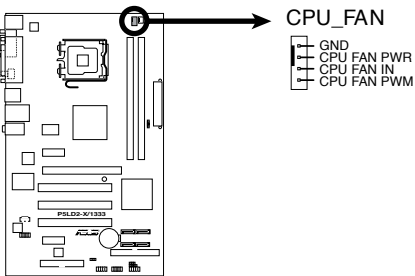

**P5LD2-X/1333 CPU Fan Connector**



Do not forget to connect the CPU fan connector! Hardware monitoring errors can occur if you fail to plug this connector.



### 2.3.3 Uninstalling the CPU heatsink and fan

To uninstall the CPU heatsink and fan:

1. Disconnect the CPU fan cable from the connector on the motherboard.
2. Rotate each fastener counterclockwise.

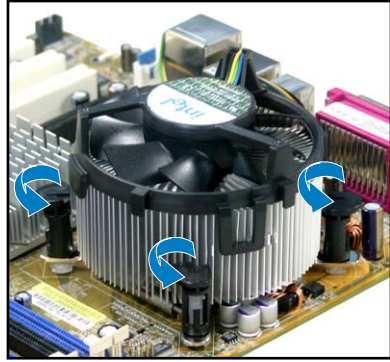

3. Pull up two fasteners at a time in a diagonal sequence to disengage the heatsink and fan assembly from the motherboard.

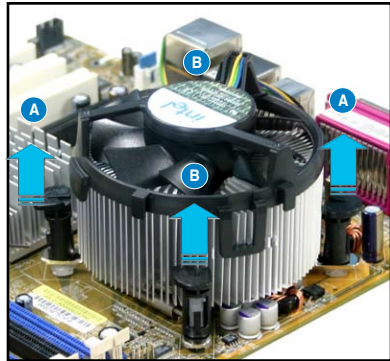
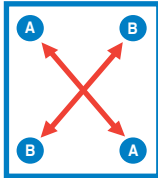

4. Carefully remove the heatsink and fan assembly from the motherboard.



5. Rotate each fastener clockwise to ensure correct orientation when reinstalling.

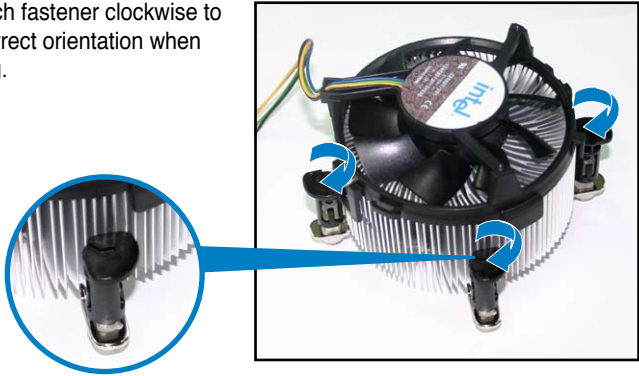

Narrow end of the groove



The narrow end of the groove should point outward after resetting. (The photo shows the groove shaded for emphasis.)

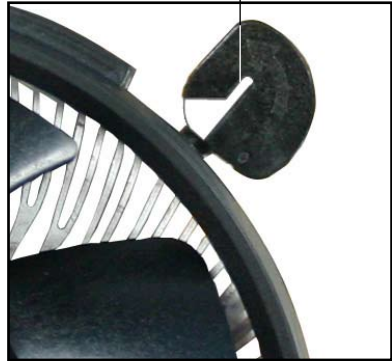

Refer to the documentation in the boxed or stand-alone CPU fan package for detailed information on CPU fan installation.

## 2.4 System memory

### 2.4.1 Overview

The motherboard comes with two Double Data Rate 2 (DDR2) Dual Inline Memory Modules (DIMM) sockets.

The figure illustrates the location of the DDR2 DIMM sockets:

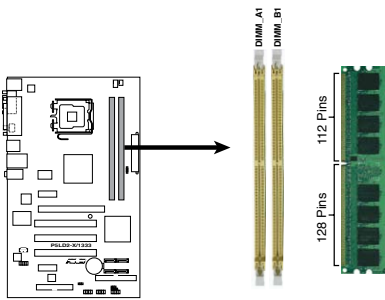

P5LD2-X/1333 240-pin DDR2 DIMM Sockets

Channel	Sockets
Channel A	DIMM_A1
Channel B	DIMM_B1

### 2.4.2 Memory configurations

You may install 128 MB, 256 MB, 512 MB and 1 GB unbuffered non-ECC DDR2 DIMMs into the DIMM sockets.



- You may install varying memory sizes in Channel A and Channel B. The system maps the total size of the lower-sized channel for the dual-channel configuration. Any excess memory from the higher-sized channel is then mapped for single-channel operation.
- Always install DIMMs with the same CAS latency. For optimum compatibility, it is recommended that you obtain memory modules from the same vendor. Refer to the DDR2 Qualified Vendors List on the next page for details.
- If you install two 1 memory modules, the system may only recognize less than 2GB because the address space is reserved for other critical functions. This limitation appears on Windows® XP 32-bit operation system which does not support Physical Address Extension (PAE).
- If you install Windows® XP 32-bit operation system, a total memory of less than 2GB is recommended.
- This motherboard does not support memory modules made up of 128 Mb chips or double sided x16 memory modules.

# Qualified Vendors Lists (QVL)

## DDR2-533

Size	Vendor	Mode	CL	Brand	Side(s)	Component	DIMM support	
							A	B
256MB	Kingston	KVR533D2N4/256	N/A	Elpida	SS	E5116AB-5C-E	.	.
256MB	Kingston	KVR533D2N4/256	N/A	Elpida	SS	E5116AF-5C-E	.	.
512MB	Kingston	KVR533D2N4/512	N/A	Hynix	DS	H5P5S6821F-C4	.	.
512MB	Kingston	KVR533D2N4/512	N/A	Infneon	SS	HYB18T512800AF3733336550	.	.
1G	Kingston	KVR533D2N4/1G	N/A	Kingston	DS	D6408TE7BL-37	.	.
1G	Kingston	KVR533D2N4/1G	N/A	Kingston	DS	D6408TLRAGL37U	.	.
256MB	Samsung	M378T3253FG0-CD5	N/A	Samsung	SS	K4T56083QF-GCD5	.	.
512MB	Samsung	M378T6553BG0-CD5	4	Samsung	SS	K4T51083QB-GCD5	.	.
256MB	Qimonda	HYS64T32000HU-3.7-A	4	Qimonda	SS	HYB18T512160AF-3.7AFSS31270	.	.
512MB	Qimonda	HYS64T64000GU-3.7-A	4	Qimonda	SS	HYB18T512800AC37SSS11511	.	.
512MB	Qimonda	HYS64T64000HU-3.7-A	N/A	Qimonda	SS	HYB18T512800AF37SSS12079	.	.
512MB	Qimonda	HYS64T64000HU-3.7-A	N/A	Qimonda	SS	HYB18T512800AF37FSS29334	.	.
256MB	HY	HYMP532U64CP6-C4	AB 4	Hynix	SS	HYSP5121621CFP-C4	.	.
1G	HY	HYMP512U64CP8-C4	AB 4	Hynix	DS	HYSP512821CFP-C4	.	.
512MB	Micron	MT 16HTF6464AG-53EB2	4	Micron	DS	D9BOM	.	.
512MB	Micron	MT 16HTF6464AG-53EB2	4	Micron	DS	Z9BQT	.	.
1G	Micron	MT 16HTF12864AY-53EA14		Micron	DS	D9CRZ	.	.
512MB	Corsair	VS512MB533D2	N/A	Corsair	DS	MIII0052532M8CEC	.	.
512MB	Corsair	VS512MB533D2	N/A	Corsair	DS	M110052532M8CEC	.	.
1G	Corsair	VS1GB533D2	N/A	Corsair	DS	64M8CFEQIB0900718	.	.
512MB	Elpida	EBE51UD8ABFA-5C-E	N/A	Elpida	SS	E5108AB-5C-E	.	.
512MB	Kingmax	KLBC28F-A8KB4	N/A	Kingmax	SS	KKEA88B4IAK-37	.	.
256MB	Kingmax	KLBB68F-36EP4	N/A	Elpida	SS	E5116AB-5C-E	.	.
512MB	Kingmax	KLBC28F-A8EB4	N/A	Elpida	SS	E5108AE-5C-E	.	.
512MB	PQI	MEAB-323LA	N/A	PQI	SS	D2-E04180W025	.	.
1G	PQI	MEAB-423LA	N/A	PQI	DS	D2-E04230W107	.	.
512MB	AENEON	AET660UD00-370A98Z	4	AENEON	SS	AET93F370A G 0513	.	.
256MB	AENEON	AET560UD00-370A98Z	4	AENEON	SS	AET94F370AWVV34635G0520	.	.
512MB	AENEON	AET660UD00-370A98Z	4	AENEON	SS	AET93F370A 3VV36328G 0522	.	.
512MB	AENEON	AET660UD00-370A98X	N/A	AENEON	SS	AET93F370A 0518	.	.
512MB	AENEON	AET660UD00-370A88S	N/A	AENEON	DS	AET82F370A 0550	.	.
512MB	AENEON	AET660UD00-370B97X	4	AENEON	SS	AET93R370B 0640	.	.
1G	AENEON	AET760UD00-370A98Z	N/A	AENEON	DS	AET93F370A 0551	.	.
1G	AENEON	AET760UD00-370A98S	N/A	AENEON	DS	AET92F370A 0606	.	.
1G	AENEON	AET760UD00-370B97X	4	AENEON	DS	AET93R370B 0640	.	.
1G	AENEON	AET760UD00-370B97S	4	AENEON	DS	AET92R370B 0644	.	.
2G	AENEON	AET860UD00-370A08X	N/A	AENEON	DS	AET03F370AFVV26176G 0542	.	.
512MB	REMAXEL	RML1040EG38D6F-533	4	Elpida	SS	E5108AG-5C-E	.	.
256MB	TAKEMS	TMS25B264B161-534KQ	4	takeMS	SS	MS18T51216-3.70711	.	.
512MB	TAKEMS	TMS51B264C081-534QI	4	takeMS	SS	MS18T51280-3.7	.	.
512MB	TAKEMS	TMS51B264C081-534AP	4	takeMS	SS	MS18T51280-3.7P0704D	.	.
512MB	TAKEMS	TMS51B264C081-534AE	4	takeMS	SS	MS18T51280-3.7EA07100	.	.
1G	TAKEMS	TMS1GB264C081-534AE	4	takeMS	DS	MS18T51280-3.7EA0651D	.	.
1G	TAKEMS	TMS1GB264C081-534QI	4	takeMS	DS	MS18T51280-3.7	.	.
1G	TAKEMS	TMS1GB264C081-534AP	4	takeMS	DS	MS18T51280-3.7P0645D	.	.
512MB	VERITECH	GTP512HLTM46DG	N/A	VERITECH	SS	VTD264M8PC6G01A164129621	.	.
1G	VERITECH	GTP01GHLTM56DG	N/A	VERITECH	DS	VTD264M8PC6G01A16412962	.	.

# DDR2-667

Size	Vendor	Model	CL	Brand	Side(s)	Component	DIMM support	
							A	B
256MB	Kingston	KVR667D2N5/256	N/A	Elpida	SS	E2508AB-6E-E	.	.
256MB	Kingston	KVR667D2N5/256	N/A	Kingston	SS	D3216TLSAKL3U	.	.
512MB	Kingston	KVR667D2N5/512	N/A	Kingston	SS	D6408TE8WL-27	.	.
1G	Kingston	KVR667D2N5/1G	N/A	Kingston	DS	D6408TE8WL-3	.	.
1G	Kingston	KVR667D2N5/1G	N/A	Kingston	DS	D6408TEBGGGL3U	.	.
512MB	Samsung	KR M378T6553CZ0-CE6	N/A	Samsung	SS	K4T51083QC	.	.
512MB	Samsung	KR M378T6453FZ0-CE6	N/A	Samsung	DS	K4T56083QF-ZCE6	.	.
512MB	Samsung	M378T6553CZ3-CE6	N/A	Samsung	SS	K4T51083QC-ZCE6	.	.
1G	Samsung	M378T2953CZ3-CE6	N/A	Samsung	DS	K4T51083QC-ZCE	.	.
1G	Samsung	KR M378T2953CZ0-CE6	N/A	Samsung	DS	K4T51083QC-ZCE6	.	.
256MB	Qimonda	HYS64T32000HU-3S-A	N/A	Qimonda	SS	HYB18T512160AF-3SSSS17310	.	.
512MB	Qimonda	HYS64T32000HU-3S-A	N/A	Qimonda	SS	HYB18T512800AF-3SSSS27416	.	.
512MB	Qimonda	HYS64T64000HU-3S-A	N/A	Qimonda	SS	HYB18T512800AF3SFFSS05346	.	.
1G	Qimonda	HYS64T128020HU-3S-A	N/A	Qimonda	DS	HYB18T512800AF3SSSS28104	.	.
512MB	Corsair	VS512MB667D2	N/A	Corsair	DS	MIII0052532M8CEC	.	.
1G	Corsair	Heat-Sink Package	4	Corsair	DS	XMS2-5400	.	.
1G	Corsair	VS1GB667D2	N/A	Corsair	DS	MID095D62864M8CEC	.	.
256MB	HY	HYMP532U64CP6-Y5 AB	5	Hynix	SS	HY5PS121621CFP-Y5	.	.
512MB	HY	HYMP564U64AP8-Y4 AA	N/A	Hynix	SS	HY5PS12821AFP-Y4	.	.
512MB	HY	HYMP564U64AP8-Y5 AA	N/A	Hynix	SS	HY5PS12821AFP-Y5	.	.
1G	HY	HYMP512U64AP8-Y5 AB	N/A	Hynix	DS	HY5PS12821AFP-Y5	.	.
1G	HY	HYMP512U64CP8-Y5 AB	5	Hynix	DS	HY5PS12521CFP-Y5	.	.
512MB	Kingmax	KLCC28F-A8EB5	N/A	Elpida	SS	E5108AE-6E-E	.	.
512MB	Kingmax	KLCC28F-A8KB5	N/A	Kingmax	SS	KKEA88B4LAUG-29DX	.	.
1G	Kingmax	KLCD48F-A8KB5	N/A	Kingmax	DS	KKEA88B4LAUG-29DX	.	.
512MB	Apacer	78.91092.420	N/A	Elpida	SS	E5108AE-6E-E	.	.
512MB	Apacer	AU512E667C5KBGC	5	Apacer	SS	AM4B5708MJS7E0627B	.	.
512MB	Apacer	AU512E667C5KBGC	5	Apacer	SS	AM4B5708GQS7E06332F	.	.
1G	Apacer	AU01GE667C5KBGC	N/A	Apacer	DS	AM4B5708GQS7E0636B	.	.
1G	Apacer	78.01092.420	5	Elpida	DS	E5108AE-6E-E	.	.
1G	Apacer	AU01GE667C5KBGC	5	Apacer	DS	AM4B5708MJS7E0627B	.	.
512MB	ADATA	M20EL5G3H3160B1C0Z	N/A	Elpida	SS	E5108AE-6E-E	.	.
512MB	ADATA	M20AD5G3H316611C52	N/A	ADATA	SS	AD29608A8A-3EG20648	.	.
1G	ADATA	M20AD5G3H317611C52	N/A	ADATA	DS	AD29608A8A-3EG20645	.	.
512MB	VDATA	M2GVD5G3H31A411C52	N/A	VDATA	SS	VD29608A8A-3EC20615	.	.
512MB	VDATA	M2YVD5G3H31P411C52	N/A	VDATA	SS	VD29608A8A-3EG20627	.	.
512MB	VDATA	M2GVD5G3H16611C52	N/A	VDATA	SS	VD29608A8A-3EG20637	.	.
1G	VDATA	M2GVD5G3I41P611C52	N/A	VDATA	DS	VD29608A8A-3EG20627	.	.
1G	VDATA	M2GVD5G3I41C411C52	N/A	VDATA	DS	VD29608A8A-3EC20620	.	.
1G	VDATA	M2GVD5G3I417611C52	N/A	VDATA	DS	VD29608A8A-3EG20641	.	.
512MB	PSC	AL6E8E63B-6E1K	5	PSC	SS	A3R12E3GEF637BLC5N	.	.
1G	PSC	AL7E8E63B-6E1K	5	PSC	DS	A3R12E3GEF637BLC5N	.	.
256MB	Nanya	NT256T64UH4A1FY-3C	N/A	Nanya	SS	NT57U32M16AG-3C	.	.
512MB	Nanya	NT512T64U88A1BY-3C	N/A	Nanya	SS	NT57U64M8AE-3C	.	.
512MB	MDT	MDT 512MB	4	MDT	SS	18D51280D-30648	.	.
1G	MDT	MDT 1024MB	4	MDT	DS	18D51200D-30646	.	.
1G	MDT	MDT 1024MB	4	MDT	DS	18D51280D-30646E	.	.

(continued on the next page)

## DDR2-667

Size	Vendor	Mode	CL	Brand	Side(s)	Component	DIMM support	
							A	B
1G	PQI	DDR2-667U 1G	N/A	Hynix	DS	HY5PS12821BFP-E3 A	.	.
512MB	AENEON	AET660UD00-30DA98Z	N/A	AENEON	SS	AET93F30DA 0552	.	.
512MB	AENEON	AET660UD00-30DB97X	5	AENEON	SS	AET93R300B 0634	.	.
1G	AENEON	AET760UD00-30DA98Z	N/A	AENEON	DS	AET93F30DA8EE47414G 0540	.	.
512MB	AENEON	AET660UD00-30DA98Z	N/A	AENEON	SS	AET93F300A 0606	.	.
1G	AENEON	AET760UD00-30DA98Z	N/A	AENEON	DS	AET93F30DA 0604	.	.
1G	AENEON	AET760UD00-30DB97X	5	AENEON	DS	AET93R300B 0639	.	.
512MB	TAKEMS	TMS51B264C081-665QI	5	takeMS	SS	MS18T51280-3	.	.
512MB	TAKEMS	TMS51B264C081-665AP	5	takeMS	SS	MS18T51280-3S0627D	.	.
1G	TAKEMS	TMS1GB264C081-665QI	5	takeMS	DS	MS18T51280-3	.	.
1G	TAKEMS	TMS1GB264C081-665AE	5	takeMS	DS	MS18T51280-3SEA07100	.	.
1G	TAKEMS	TMS1GB264C081-665AP	5	takeMS	DS	MS18T51280-3SP0717A	.	.
512MB	VERITECH	GTP512HLTM45EG	N/A	VERITECH	SS	VTD264M8PC6G01A164129621	.	.
1G	VERITECH	GTP01GHMTM55EG	N/A	VERITECH	DS	VTD264M8PC6G01A164129621	.	.
512MB	GEIL	GX21GB5300DC	4	GEIT	SS	Heat-Sink Package	.	.
512MB	TEAM	TVDD512M667C5	N/A	TEAM	SS	T2D648MT-6	.	.
1G	TEAM	TVDD1.02M667C4	N/A	TEAM	DS	T2D648PT-6	.	.
512MB	Century	CENTURY 512MB	N/A	Nanya	SS	NT5TU64M8AE-3C	.	.
512MB	Century	CENTURY 512MB	N/A	Hynix	SS	HY5PS12821AFP-Y5	.	.
1G	Century	CENTURY 1G	N/A	Hynix	DS	HY5PS12821AFP-Y5	.	.
1G	Century	CENTURY 1G	N/A	Nanya	DS	NT5TU64M8AE-3C	.	.
512MB	KINGBOX	512MB 667MHz	N/A	KINGBOX	SS	EPD264082200-4	.	.
1G	KINGBOX	DDRIII 1G 667MHz	N/A	KINGBOX	DS	EPD264082200-4	.	.

Side(s): SS - Single-sided DS - Double-sided CL: CAS Latency

### DIMM support:

- A** - Supports one module inserted into either slot, in Single-channel memory configuration.
- B** - Supports one pair of modules inserted into either the yellow slots or the black slots as one pair of Dual-channel memory configuration.



Visit the ASUS website for the latest DDR2-667/533 MHz QVL.

### 2.4.3 Installing a DIMM



Unplug the power supply before adding or removing DIMMs or other system components. Failure to do so can cause severe damage to both the motherboard and the components.

To install a DIMM:

1. Unlock a DIMM socket by pressing the retaining clips outward.
2. Align a DIMM on the socket such that the notch on the DIMM matches the break on the socket.
3. Firmly insert the DIMM into the socket until the retaining clips snap back in place and the DIMM is properly seated.

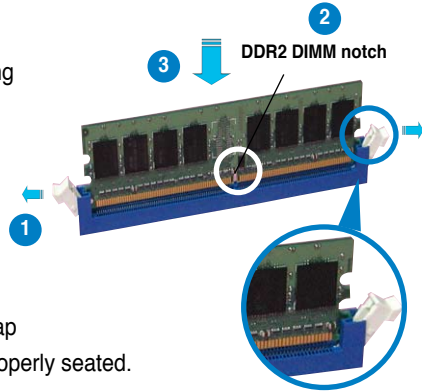

Unlocked retaining clip



- A DDR2 DIMM is keyed with a notch so that it fits in only one direction. Do not force a DIMM into a socket to avoid damaging the DIMM.
- The DDR2 DIMM sockets do not support DDR DIMMs. DO not install DDR DIMMs to the DDR2 DIMM sockets.

### 2.4.4 Removing a DIMM

Follow these steps to remove a DIMM.

1. Simultaneously press the retaining clips outward to unlock the DIMM.



Support the DIMM lightly with your fingers when pressing the retaining clips. The DIMM might get damaged when it flips out with extra force.

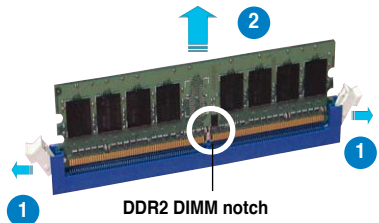

2. Remove the DIMM from the socket.

## 2.5 Expansion slots

In the future, you may need to install expansion cards. The following sub-sections describe the slots and the expansion cards that they support.



---

Make sure to unplug the power cord before adding or removing expansion cards. Failure to do so may cause you physical injury and damage motherboard components.

---

### 2.5.1 Installing an expansion card

To install an expansion card:

1. Before installing the expansion card, read the documentation that came with it and make the necessary hardware settings for the card.
2. Remove the system unit cover (if your motherboard is already installed in a chassis).
3. Remove the bracket opposite the slot that you intend to use. Keep the screw for later use.
4. Align the card connector with the slot and press firmly until the card is completely seated on the slot.
5. Secure the card to the chassis with the screw you removed earlier.
6. Replace the system cover.

### 2.5.2 Configuring an expansion card

After installing the expansion card, configure the it by adjusting the software settings.

1. Turn on the system and change the necessary BIOS settings, if any. See Chapter 4 for information on BIOS setup.
2. Assign an IRQ to the card. Refer to the tables on the next page.
3. Install the software drivers for the expansion card.



---

When using PCI cards on shared slots, ensure that the drivers support “Share IRQ” or that the cards do not need IRQ assignments. Otherwise, conflicts will arise between the two PCI groups, making the system unstable and the card inoperable. Refer to the table on the next page for details.

---



## 2.5.3 Interrupt assignments

### Standard interrupt assignments

IRQ	Standard Function
0	System Timer
1	Keyboard Controller
2	Re-direct to IRQ#9
3	—
4	Communications Port (COM1)*
5	IRQ holder for PCI steering*
6	Floppy Disk Controller
7	Printer Port (LPT1)*
8	System CMOS/Real Time Clock
9	IRQ holder for PCI steering*
10	IRQ holder for PCI steering*
11	IRQ holder for PCI steering*
12	PS/2 Compatible Mouse Port*
13	Numeric Data Processor
14	Primary IDE Channel

\* These IRQs are usually available for ISA or PCI devices.

### IRQ assignments for this motherboard

	A	B	C	D	E	F	G	H
PCI slot 1	—	shared	—	—	—	—	—	—
PCI slot 2	—	—	—	—	—	shared	—	—
PCI slot 3	—	—	—	—	—	—	shared	—
PCIe x16 slot	shared	—	—	—	—	—	—	—
PCIe x1 slot 1	shared	—	—	—	—	—	—	—
PCIe x1 slot 2	—	—	shared	—	—	—	—	—
Onboard USB controller 1	shared	—	—	—	—	—	—	—
Onboard USB controller 2	—	shared	—	—	—	—	—	—
Onboard USB controller 3	—	—	shared	—	—	—	—	—
Onboard USB controller 4	—	—	—	shared	—	—	—	—
Onboard USB 2.0 controller	—	—	—	—	shared	—	—	—
Onboard IDE port	—	—	—	—	—	—	shared	—
Onboard HD Audio controller	—	—	—	shared	—	—	—	—
Onboard LAN controller	—	shared	—	—	—	—	—	—

## 2.5.4 PCI slots

The PCI slots support cards such as a LAN card, SCSI card, USB card, and other cards that comply with PCI specifications. The figure shows a LAN card installed on a PCI slot.

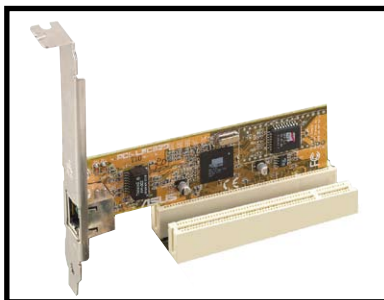

## 2.5.5 PCI Express x16 slot

This motherboard supports PCI Express x16 graphic cards that comply with the PCI Express specifications. The following figure shows a graphics card installed on the PCI Express x16 slot.

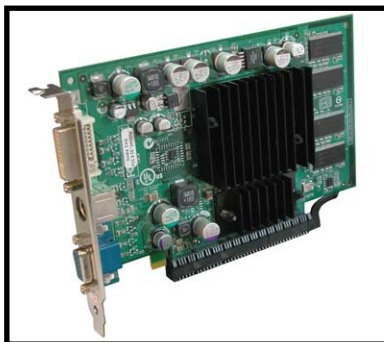

## 2.5.6 PCI Express x1 slot

This motherboard supports PCI Express x1 network cards, SCSI cards and other cards that comply with the PCI Express specifications. The following figure shows a network card installed on the PCI Express x1 slot.

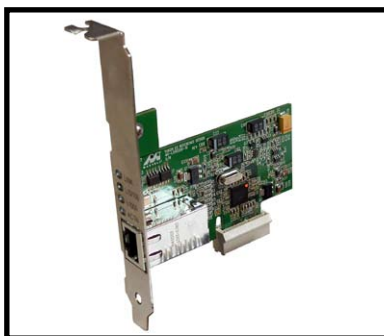

## 2.6 Jumpers

### 1. Clear RTC RAM (CLRRTC)

This jumper allows you to clear the Real Time Clock (RTC) RAM in CMOS. You can clear the CMOS memory of date, time, and system setup parameters by erasing the CMOS RTC RAM data. The onboard button cell battery powers the RAM data in CMOS, which include system setup information such as system passwords.

To erase the RTC RAM:

1. Turn OFF the computer and unplug the power cord.
2. Remove the onboard battery.
3. Move the jumper cap from pins 1-2 (default) to pins 2-3. Keep the cap on pins 2-3 for about 5~10 seconds, then move the cap back to pins 1-2.
4. Re-install the battery.
5. Plug the power cord and turn ON the computer.
6. Hold down the <Del> key during the boot process and enter BIOS setup to re-enter data.



Except when clearing the RTC RAM, never remove the cap on CLRRTC jumper default position. Removing the cap will cause system boot failure!

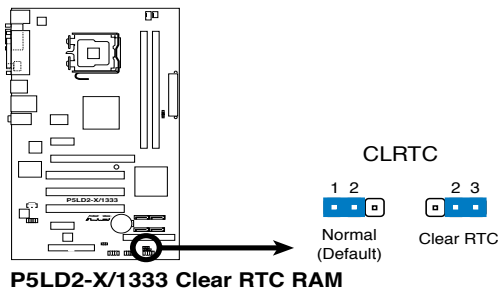

You do not need to clear the RTC when the system hangs due to overclocking. For system failure due to overclocking, use the C.P.R. (CPU Parameter Recall) feature. Shut down and reboot the system so the BIOS can automatically reset parameter settings to default values.

## 2. USB device wake-up (3-pin PS2\_USBPW)

This jumper allows you to wake up the computer from S1 mode (CPU stopped, DRAM refreshed, system running in low power mode) using the connected USB device. Set this jumper to pins 2-3 (+5VSB) to wake up the computer from S3 and S4 modes (no power to CPU, DRAM in slow refresh, power supply in reduced power mode).

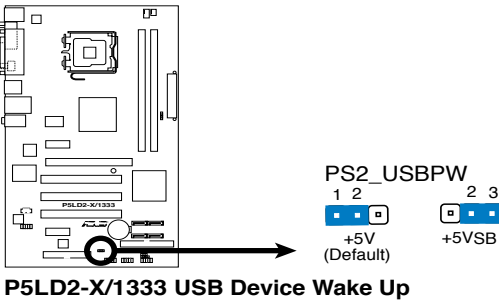

---

The total current consumed must NOT exceed the power supply capability (+5VSB) whether under normal condition or in sleep mode.

---

## 2.7 Connectors

### 2.7.1 Rear panel connectors

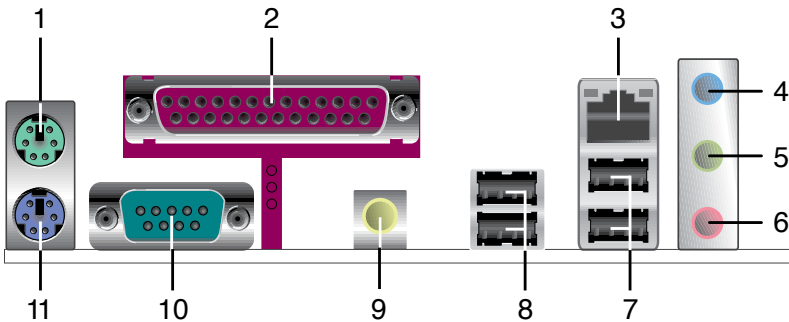

1. **PS/2 mouse port (green).** This port is for a PS/2 mouse.
2. **Parallel port.** This 25-pin port connects a parallel printer, a scanner, or other devices.
3. **LAN (RJ-45) port.** This port allows 10/100Mb connection to a Local Area Network (LAN) through a network hub. Refer to the table below for the LAN port LED indications.

LAN port LED indications

ACT/LINK LED		SPEED LED	
Status	Description	Status	Description
OFF	No link	OFF	10 Mbps connection
GREEN	Linked	Orange	100 Mbps connection

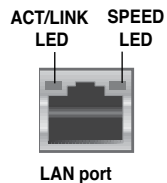

4. **Line In port (light blue).** This port connects a tape, CD, DVD player, or other audio sources.
5. **Line Out port (lime).** This port connects a headphone or a speaker. In 4-channel, and 6-channel configuration, the function of this port becomes Front Speaker Out.
6. **Microphone port (pink).** This port connects a microphone.



Refer to the audio configuration table on next page for the function of the audio ports in 2, 4, or 6-channel configuration.

Audio 2, 4, or 6-channel configuration

Port	2-channel	4-channel	6-channel
Light Blue	Line In	Line In	Line In
Lime	Line Out	Front Speaker Out	Front Speaker Out
Pink	Mic In	Mic In	Mic In

- 7. USB 2.0 ports 1 and 2.** These two 4-pin Universal Serial Bus (USB) ports are available for connecting USB 2.0/1.1 devices.
- 8. USB 2.0 ports 3 and 4.** These two 4-pin Universal Serial Bus (USB) ports are available for connecting USB 2.0/1.1 devices.
- 9. Coaxial S/PDIF Out port.** This port connects an external audio output device via a coaxial S/PDIF cable.
- 10. Serial port.** This port connects a modem, or other devices that conform with serial specification.
- 11. PS/2 keyboard port (purple).** This port is for a PS/2 keyboard.

## 2.7.2 Internal connectors

### 1. Floppy disk drive connector (34-1 pin FLOPPY)

This connector is for the provided floppy disk drive (FDD) signal cable. Insert one end of the cable to this connector, then connect the other end to the signal connector at the back of the floppy disk drive.



Pin 5 on the connector is removed to prevent incorrect cable connection when using a FDD cable with a covered Pin 5.

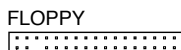
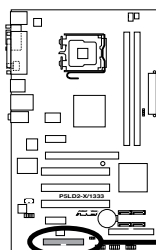

PIN 1

**NOTE:** Orient the red markings on the floppy ribbon cable to PIN 1.

**P5LD2-X/1333 Floppy Disk Drive Connector**

## 2. ICH7 Primary IDE connector (40-pin PRI\_IDE)

This connector is for an Ultra DMA 100/66/33 signal cable. The Ultra DMA 100/66/33 signal cable has three connectors: a blue connector for the primary IDE connector on the motherboard, a black connector for an Ultra DMA 100/66/33 IDE slave device (optical drive/hard disk drive), and a gray connector for an Ultra DMA 100/66/33 IDE master device (hard disk drive). If you install two hard disk drives, you must configure the second drive as a slave device by setting its jumper accordingly. Refer to the hard disk documentation for the jumper settings.



- Pin 20 on the IDE connector is removed to match the covered hole on the Ultra DMA cable connector. This prevents incorrect insertion when you connect the IDE cable.
- Use the 80-conductor IDE cable for Ultra DMA 100/66/33 IDE devices.

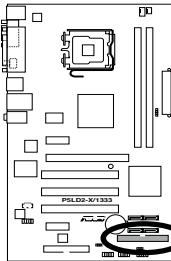

**P5LD2-X/1333 IDE Connector**

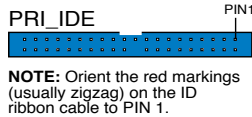

## 3. Serial ATA connectors (7-pin SATA1 [red], SATA2 [red], SATA3 [black], SATA4 [black])

These connectors are for the Serial ATA signal cables for Serial ATA hard disk drives.

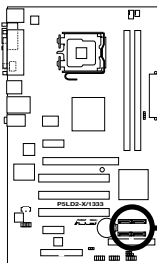

**P5LD2-X/1333 SATA Connectors**

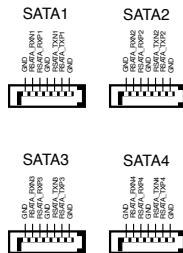



### Important notes on Serial ATA

- You must install Windows® 2000 Service Pack 4 or the Windows® XP Service Pack 1 before using Serial ATA hard disk drives.
- When using the connectors in Standard IDE mode, connect the primary (boot) hard disk drive to the SATA1 or SATA2 connector. Refer to the table below for the recommended SATA hard disk drive connections.

### Serial ATA hard disk drive connection

Connector	Color	Setting	Use
SATA1/SATA2	Red	Master	Boot disk
SATA3/SATA4	Black	Slave	Data disk

#### 4. Optical drive audio connector (4-pin CD)

This connector is for the 4-pin audio cable that connects to the audio connector at the back of the optical drive.

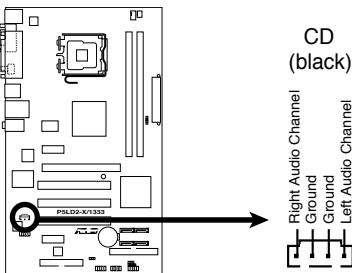

**P5LD2-X/1333 Internal Audio Connector**



## 5. Front panel audio connector (10-1 pin AAFP)

This connector is for a chassis-mounted front panel audio I/O module that supports either HD Audio or legacy AC'97 audio standard.

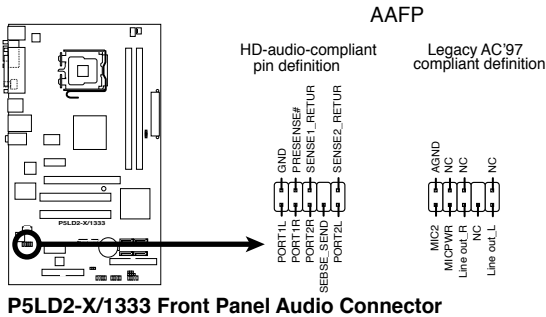

We recommend that you connect a high-definition front panel audio module to this connector to avail the motherboard high-definition audio capability.

## 6. USB port connectors (10-1 pin USB56, USB78)

These connectors are for USB 2.0 ports. Connect the optional USB module cable to any of these connectors, then install the module to a slot opening at the back of the system chassis. These USB connectors comply with USB 2.0 specification that supports up to 480 Mbps connection speed.

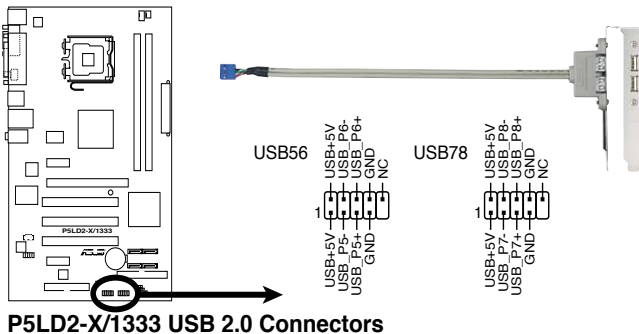

The USB cable is not included in this product.

## 7. CPU and chassis fan connectors (4-pin CPU\_FAN, 3-pin CHA\_FAN)

The fan connectors support cooling fans of 350 mA ~ 2000 mA (24 W max.) or a total of 1 A ~ 3.48 A (41.76 W max.) at +12V. Connect the fan cables to the fan connectors on the motherboard, making sure that the black wire of each cable matches the ground pin of the connector.



Do not forget to connect the fan cables to the fan connectors. Insufficient air flow inside the system may damage the motherboard components. These are not jumpers! Do not place jumper caps on the fan connectors!

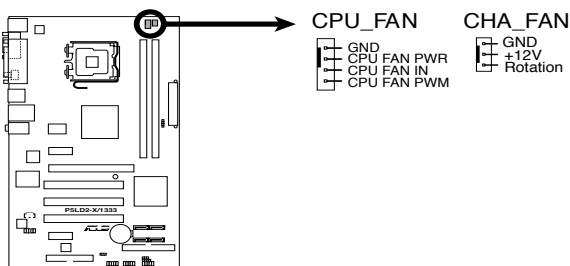

**P5LD2-X/1333 Fan Connectors**



Only the CPU\_FAN connector support the ASUS Q-Fan feature.

## 8. Chassis intrusion connector (4-1 pin CHASSIS)

This connector is for a chassis-mounted intrusion detection sensor or switch. Connect one end of the chassis intrusion sensor or switch cable to this connector. The chassis intrusion sensor or switch sends a high-level signal to this connector when a chassis component is removed or replaced. The signal is then generated as a chassis intrusion event.

By default, the pins labeled “Chassis Signal” and “GND” are shorted with a jumper cap. Remove the jumper caps only when you intend to use the chassis intrusion detection feature.

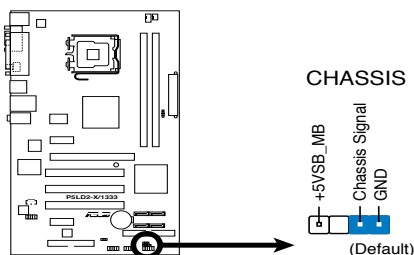

**P5LD2-X/1333 Intrusion Connector**

## 9. ATX power connectors (24-pin EATXPW, 4-pin ATX12V)

These connectors are for ATX power supply plugs. The power supply plugs are designed to fit these connectors in only one orientation. Find the proper orientation and push down firmly until the connectors completely fit.



- Use of an ATX 12 V Specification 2.0 -compliant power supply unit (PSU) that provides a minimum power of 350 W is recommended for a fully-configured system.
- Do not forget to connect the 4-pin ATX +12 V power plug; otherwise, the system will not boot up.
- Use of a PSU with a higher power output is recommended when configuring a system with more power consuming devices. The system may become unstable or may not boot up if the power is inadequate.

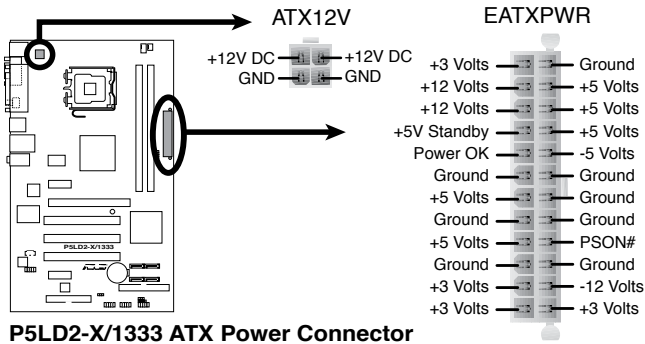

## 10. Speaker connector (4-pin SPEAKER)

This 4-pin connector is for the chassis-mounted system warning speaker. The speaker allows you to hear system beeps and warnings.

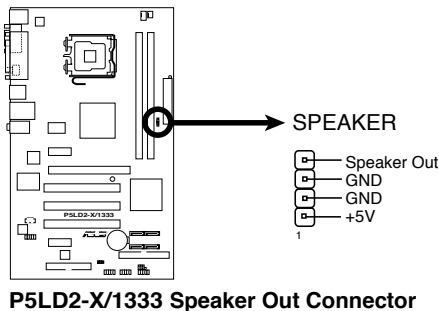

## 11. System panel connector (10-1 pin F\_PANEL)

This connector supports several chassis-mounted functions.

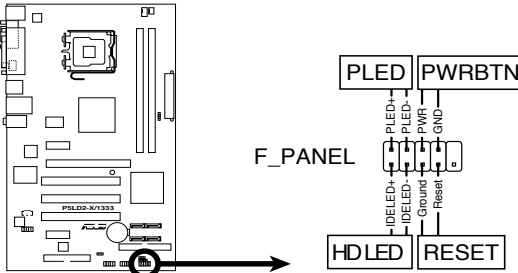

**P5LD2-X/1333 System Panel Connector**

- **System power LED (2-pin PLED)**  
This 2-pin connector is for the system power LED. Connect the chassis power LED cable to this connector. The system power LED lights up when you turn on the system power, and blinks when the system is in sleep mode.
- **Hard disk drive activity LED (2-pin IDE\_LED)**  
This 2-pin connector is for the HDD Activity LED. Connect the HDD Activity LED cable to this connector. The IDE LED lights up or flashes when data is read from or written to the HDD.
- **ATX power button/soft-off button (2-pin PWRBTN)**  
This connector is for the system power button. Pressing the power button turns the system on or puts the system in sleep or soft-off mode depending on the BIOS settings. Pressing the power switch for more than four seconds while the system is ON turns the system OFF.
- **Reset button (2-pin RESET)**  
This 2-pin connector is for the chassis-mounted reset button for system reboot without turning off the system power.

This chapter describes the power up sequence, the vocal POST messages, and ways of shutting down the system.

# Powering up **3**

## Chapter summary

# 3

3.1	Starting up for the first time.....	3-1
3.2	Powering off the computer.....	3-2

## 3.1 Starting up for the first time

1. After making all the connections, replace the system case cover.
2. Be sure that all switches are off.
3. Connect the power cord to the power connector at the back of the system chassis.
4. Connect the power cord to a power outlet that is equipped with a surge protector.
5. Turn on the devices in the following order:
  - a. Monitor
  - b. External SCSI devices (starting with the last device on the chain)
  - c. System power
6. After applying power, the system power LED on the system front panel case lights up. For systems with ATX power supplies, the system LED lights up when you press the ATX power button. If your monitor complies with “green” standards or if it has a “power standby” feature, the monitor LED may light up or switch between orange and green after the system LED turns on.

The system then runs the power-on self tests or POST. While the tests are running, the BIOS beeps (see BIOS beep codes table below) or additional messages appear on the screen. If you do not see anything within 30 seconds from the time you turned on the power, the system may have failed a power-on test. Check the jumper settings and connections or call your retailer for assistance.

### AMI BIOS beep codes

Beep Description	Error
One beep	Keyboard controller error Refresh Time error No master drive detected
Two continuous beeps followed by two short beeps	Floppy controller failure
Two continuous beeps followed by four short beeps	Hardware component failure

7. At power on, hold down the <Delete> key to enter the BIOS Setup. Follow the instructions in Chapter 4.

## 3.2 Powering off the computer

### 3.2.1 Using the OS shut down function

If you are using Windows® 2000:

1. Click the **Start** button then click **Shut Down...**
2. Make sure that the **Shut Down** option button is selected, then click the **OK** button to shut down the computer.

If you are using Windows® XP:

1. Click the **Start** button then select **Turn Off Computer**.
2. Click the **Turn Off** button to shut down the computer.

If you are using Windows® Vista:

1. Click  >  .
2. From the shortcut menu, click **Shut Down** option to shut down the computer.

### 3.2.2 Using the dual function power switch

While the system is ON, pressing the power switch for less than four seconds puts the system to sleep mode or to soft-off mode, depending on the BIOS setting. Pressing the power switch for more than four seconds lets the system enter the soft-off mode regardless of the BIOS setting. Refer to section “4.5 Power Menu” in Chapter 4 for details.



This chapter tells how to change the system settings through the BIOS Setup menus. Detailed descriptions of the BIOS parameters are also provided.

# BIOS setup **4**

4.1	Managing and updating your BIOS .....	4-1
4.2	BIOS setup program .....	4-11
4.3	Main menu .....	4-14
4.4	Advanced menu .....	4-18
4.5	Power menu.....	4-27
4.6	Boot menu .....	4-31
4.7	Exit menu.....	4-36

## 4.1 Managing and updating your BIOS

The following utilities allow you to manage and update the motherboard Basic Input/Output System (BIOS) setup.

1. ASUS AFUDOS (Updates the BIOS in DOS mode using a bootable floppy disk.)
2. ASUS CrashFree BIOS 2 (Updates the BIOS using a bootable floppy disk or the motherboard support CD when the BIOS file fails or gets corrupted.)
3. ASUS EZ Flash (Updates the BIOS using a floppy disk during POST.)
4. ASUS Update (Updates the BIOS in Windows® environment.)

Refer to the corresponding sections for details on these utilities.



---

Save a copy of the original motherboard BIOS file to a bootable floppy disk in case you need to restore the BIOS in the future. Copy the original motherboard BIOS using the ASUS Update or AFUDOS utilities.

---

### 4.1.1 Creating a bootable floppy disk

1. Do either one of the following to create a bootable floppy disk.

#### *DOS environment*

- a. Insert a 1.44MB floppy disk into the drive.
- b. At the DOS prompt, type `format A: /s` then press <Enter>.

#### *Windows® XP environment*

- a. Insert a 1.44 MB floppy disk to the floppy disk drive.
- b. Click **Start** from the Windows® desktop, then select My Computer.
- c. Select the 3 1/2 Floppy Drive icon.
- d. Click File from the menu, then select Format. A Format 3 1/2 Floppy Disk window appears.
- e. Windows® XP users: Select Create an MS-DOS startup disk from the format options field, then click **Start**.

### Windows® 2000 environment

To create a set of boot disks for Windows® 2000:

- a. Insert a formatted, high density 1.44 MB floppy disk into the drive.
- b. Insert the Windows® 2000 CD to the optical drive.
- c. Click **Start**, then select Run.
- d. In the Open field, type `D:\bootdisk\makeboot a:` assuming that D is your optical drive letter.
- e. Press <Enter>, then follow screen instructions to continue.

### Windows® Vista environment

- a. Insert a formatted, high density 1.44 MB floppy disk to the floppy disk drive.
- b. Click  from the Windows® desktop, then select **Computer**.
- c. Right-click **Floppy Disk Drive** then click **Format** to display the **Format 3 1/2 Floppy** dialog box.
- d. Select the **Create an MS-DOS startup disk** check box.
- e. Click **Start**.

2. Copy the original or the latest motherboard BIOS file to the bootable floppy disk.

## 4.1.2 AFUDOS utility

The AFUDOS utility allows you to update the BIOS file in DOS environment using a bootable floppy disk with the updated BIOS file. This utility also allows you to copy the current BIOS file that you can use as backup when the BIOS fails or gets corrupted during the updating process.

### Copying the current BIOS

To copy the current BIOS file using the AFUDOS utility:



- 
- Make sure that the floppy disk is not write-protected and has at least 1.2 MB free space to save the file.
  - The succeeding BIOS screens are for reference only. The actual BIOS screen displays may not be same as shown.
-

1. Copy the AFUDOS utility (afudos.exe) from the motherboard support CD to the bootable floppy disk you created earlier.
2. Boot the system in DOS mode, then at the prompt type:

```
afudos /o[filename]
```

where the [filename] is any user-assigned filename not more than eight alphanumeric characters for the main filename and three alphanumeric characters for the extension name.

```
A:\>afudos /oOLDBIOS1.rom
```

Main filename    Extension name

3. Press <Enter>. The utility copies the current BIOS file to the floppy disk.

```
A:\>afudos /oOLDBIOS1.rom
AMI Firmware Update Utility - Version 1.19 (ASUS V2.07 (03.11.24BB))
Copyright (C) 2002 American Megatrends, Inc. All rights reserved.
Reading flash ..... done
Write to file..... ok
A:\>
```

The utility returns to the DOS prompt after copying the current BIOS file.

## Updating the BIOS file

To update the BIOS file using the AFUDOS utility:

1. Visit the ASUS website ([www.asus.com](http://www.asus.com)) and download the latest BIOS file for the motherboard. Save the BIOS file to a bootable floppy disk.



---

Write the BIOS filename on a piece of paper. You need to type the exact BIOS filename at the DOS prompt.

---

2. Copy the AFUDOS utility (afudos.exe) from the motherboard support CD to the bootable floppy disk you created earlier.
3. Boot the system in DOS mode, then at the prompt type:

```
afudos /i[filename]
```

where [filename] is the latest or the original BIOS file on the bootable floppy disk.

```
A:\>afudos /iP5LD2XOC.rom
```

4. The utility verifies the file and starts updating the BIOS.

```
A:\>afudos /iP5LD2XOC.rom
AMI Firmware Update Utility - Version 1.19(ASUS V2.07(03.11.24BB))
Copyright (C) 2002 American Megatrends, Inc. All rights reserved.

WARNING!! Do not turn off power during flash BIOS
Reading file ..... done
Reading flash ..... done

Advance Check .....
Erasing flash ..... done
Writing flash ..... 0x0008CC00 (9%)
```



Do not shut down or reset the system while updating the BIOS to prevent system boot failure!

5. The utility returns to the DOS prompt after the BIOS update process is completed. Reboot the system from the hard disk drive.

```
A:\>afudos /iP5LD2XOC.rom
AMI Firmware Update Utility - Version 1.19(ASUS V2.07(03.11.24BB))
Copyright (C) 2002 American Megatrends, Inc. All rights reserved.

WARNING!! Do not turn off power during flash BIOS
Reading file ..... done
Reading flash ..... done

Advance Check .....
Erasing flash ..... done
Writing flash ..... done
Verifying flash .... done

Please restart your computer

A:\>
```

### 4.1.3 ASUS CrashFree BIOS 2 utility

The ASUS CrashFree BIOS 2 is an auto recovery tool that allows you to restore the BIOS file when it fails or gets corrupted during the updating process. You can update a corrupted BIOS file using the motherboard support CD or the floppy disk that contains the updated BIOS file.



- Prepare the motherboard support CD or the floppy disk containing the updated motherboard BIOS before using this utility.
- Make sure that you rename the original or updated BIOS file in the floppy disk to P5LD2X.ROM.

### Recovering the BIOS from a floppy disk

To recover the BIOS from a floppy disk:

1. Turn on the system.
2. Insert the floppy disk with the original or updated BIOS file to the floppy disk drive.
3. The utility displays the following message and automatically checks the floppy disk for the original or updated BIOS file.

```
Bad BIOS checksum. Starting BIOS recovery...
Checking for floppy...
```

When found, the utility reads the BIOS file and starts flashing the corrupted BIOS file.

```
Bad BIOS checksum. Starting BIOS recovery...
Checking for floppy...
Floppy found!
Reading file "P5LD2X.rom". Completed.
Start flashing...
```



**DO NOT** shut down or reset the system while updating the BIOS! Doing so can cause system boot failure!

4. Restart the system after the utility completes the updating process.

## Recovering the BIOS from the support CD

To recover the BIOS from the support CD:

1. Remove any floppy disk from the floppy disk drive, then turn on the system.
2. Insert the support CD to the optical drive.
3. The utility displays the following message and automatically checks the floppy disk for the original or updated BIOS file.

```
Bad BIOS checksum. Starting BIOS recovery...
Checking for floppy...
```

When no floppy disk is found, the utility automatically checks the optical drive for the original or updated BIOS file. The utility then updates the corrupted BIOS file.

```
Bad BIOS checksum. Starting BIOS recovery...
Checking for floppy...
Floppy not found!
Checking for CD-ROM...
CD-ROM found!
Reading file "P5LD2X.rom". Completed.
Start flashing...
```



---

DO NOT shut down or reset the system while updating the BIOS! Doing so can cause system boot failure!

---

4. Restart the system after the utility completes the updating process.



---

The recovered BIOS may not be the latest BIOS version for this motherboard. Visit the ASUS website ([www.asus.com](http://www.asus.com)) to download the latest BIOS file.

---



#### 4.1.4 ASUS EZ Flash utility

The ASUS EZ Flash feature allows you to update the BIOS without having to go through the long process of booting from a floppy disk and using a DOS-based utility. The EZ Flash utility is built-in the BIOS chip so it is accessible by pressing <Alt> + <F2> during the Power-On Self Tests (POST).

To update the BIOS using EZ Flash:

1. Visit the ASUS website ([www.asus.com](http://www.asus.com)) to download the latest BIOS file for the motherboard and rename the same to P5LD2X.ROM.
2. Save the BIOS file to a floppy disk, then restart the system.
3. Press <Alt> + <F2> during POST to display the following.

```
EZFlash starting BIOS update
Checking for floppy...
```

4. Insert the floppy disk that contains the BIOS file to the floppy disk drive. When the correct BIOS file is found, EZ Flash performs the BIOS update process and automatically reboots the system when done.

```
EZFlash starting BIOS update
Checking for floppy...
Floppy found!
Reading file "P5LD2X.rom". Completed.
Start erasing.....|
Start programming...|
Flashed successfully. Rebooting.
```



- Do not shut down or reset the system while updating the BIOS to prevent system boot failure!
- A "Floppy not found!" error message appears if there is no floppy disk in the drive. A "P5LD2X.ROM not found!" error message appears if the correct BIOS file is not found in the floppy disk. Make sure that you rename the BIOS file to P5LD2X.ROM.

### 4.1.5 ASUS Update utility

The ASUS Update is a utility that allows you to manage, save, and update the motherboard BIOS in Windows® environment. The ASUS Update utility allows you to:

- Save the current BIOS file
- Download the latest BIOS file from the Internet
- Update the BIOS from an updated BIOS file
- Update the BIOS directly from the Internet, and
- View the BIOS version information.

This utility is available in the support CD that comes with the motherboard package.



ASUS Update requires an Internet connection either through a network or an Internet Service Provider (ISP).

---

### Installing ASUS Update

To install ASUS Update:

1. Place the support CD in the optical drive. The Drivers menu appears.
2. Click the Utilities tab, then click Install ASUS Update VX.XX.XX. See page 5-3 for the Utilities screen menu.
3. The ASUS Update utility is copied to your system.



Quit all Windows® applications before you update the BIOS using this utility.

---

## Updating the BIOS through the Internet

To update the BIOS through the Internet:

1. Launch the ASUS Update utility from the Windows® desktop by clicking **Start > Programs > ASUS > ASUSUpdate > ASUSUpdate**. The ASUS Update main window appears.

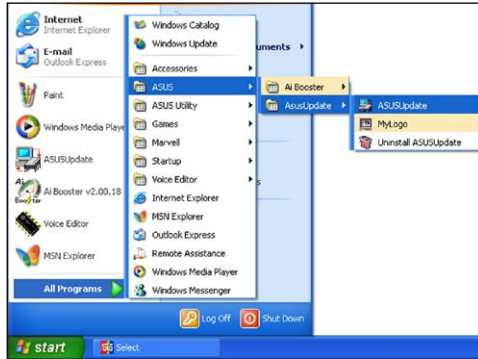

2. Select Update BIOS from the Internet option from the drop-down menu, then click **Next**.
3. Select the ASUS FTP site nearest you to avoid network traffic, or click Auto Select. Click **Next**.

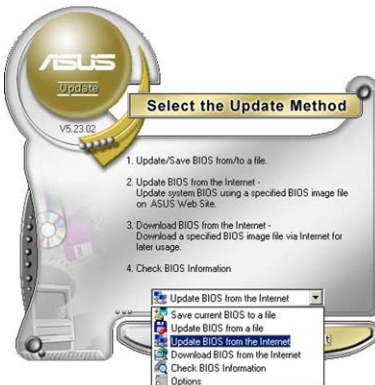

- From the FTP site, select the BIOS version that you wish to download. Click **Next**.
- Follow the screen instructions to complete the update process.



The ASUS Update utility is capable of updating itself through the Internet. Always update the utility to avail all its features.

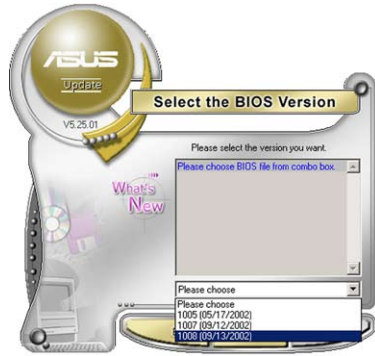

## Updating the BIOS through a BIOS file

To update the BIOS through a BIOS file:

- Launch the ASUS Update utility from the Windows® desktop by clicking **Start > Programs > ASUS > ASUSUpdate > ASUSUpdate**. The ASUS Update main window appears.
- Select Update BIOS from a file option from the drop-down menu, then click **Next**.

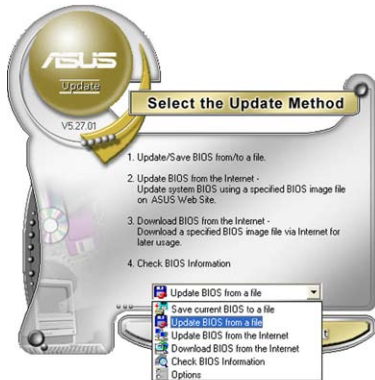

- Locate the BIOS file from the Open window, then click **Open**.
- Follow the screen instructions to complete the update process.

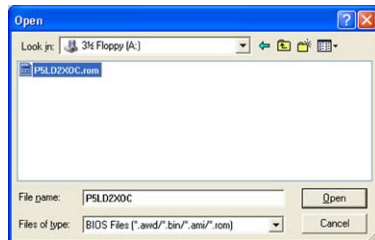

## 4.2 BIOS setup program

This motherboard supports a programmable Serial Peripheral Interface (SPI) chip that you can update using the provided utility described in section “4.1 Managing and updating your BIOS.”

Use the BIOS Setup program when you are installing a motherboard, reconfiguring your system, or prompted to “Run Setup.” This section explains how to configure your system using this utility.

Even if you are not prompted to use the Setup program, you can change the configuration of your computer in the future. For example, you can enable the security password feature or change the power management settings. This requires you to reconfigure your system using the BIOS Setup program so that the computer can recognize these changes and record them in the CMOS RAM of the SPI chip.

The SPI chip on the motherboard stores the Setup utility. When you start up the computer, the system provides you with the opportunity to run this program. Press <Del> during the Power-On Self-Test (POST) to enter the Setup utility; otherwise, POST continues with its test routines.

If you wish to enter Setup after POST, reboot the system by doing any of the following procedures:

- Restart using the OS standard shut-down procedure.
- Press <Ctrl>+<Alt>+<Del> simultaneously.
- Press the reset button on the system chassis.
- Press the power button to turn the system off then back on.



---

Using the **power button**, **reset button**, or the <Ctrl>+<Alt>+<Del> keys to force reset from a running operating system can cause damage to your data or system. We recommend to always shut-down the system properly from the operating system.

---

The Setup program is designed to make it as easy to use as possible. Being a menu-driven program, it lets you scroll through the various sub-menus and make your selections from the available options using the navigation keys.



- 
- The default BIOS settings for this motherboard apply for most conditions to ensure optimum performance. If the system becomes unstable after changing any BIOS settings, load the default settings to ensure system compatibility and stability. Select the **Load Default Settings** item under the Exit Menu. See section “4.7 Exit Menu.”
  - The BIOS setup screens shown in this section are for reference purposes only, and may not exactly match what you see on your screen.
  - Visit the ASUS website ([www.asus.com](http://www.asus.com)) to download the latest BIOS file for this motherboard.
-

## 4.2.1 BIOS menu screen

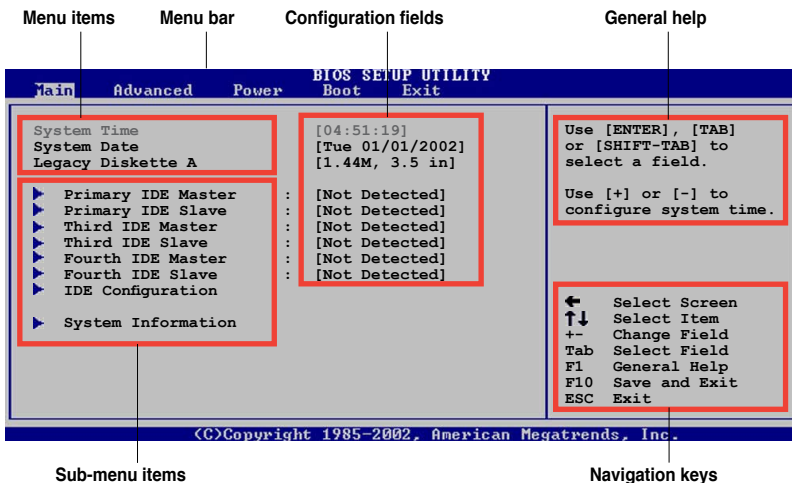

## 4.2.2 Menu bar

The menu bar on top of the screen has the following main items:

Main	For changing the basic system configuration
Advanced	For changing the advanced system settings
Power	For changing the advanced power management (APM) configuration
Boot	For changing the system boot configuration
Exit	For selecting the exit options and loading default settings

To select an item on the menu bar, press the right or left arrow key on the keyboard until the desired item is highlighted.

## 4.2.3 Navigation keys

At the bottom right corner of a menu screen are the navigation keys for that particular menu. Use the navigation keys to select items in the menu and change the settings.



---

Some of the navigation keys differ from one screen to another.

---

## 4.2.4 Menu items

The highlighted item on the menu bar displays the specific items for that menu. For example, selecting Main shows the Main menu items.

The other items (Advanced, Power, Boot, and Exit) on the menu bar have their respective menu items.



Main menu items

## 4.2.5 Sub-menu items

A solid triangle before each item on any menu screen means that the item has a sub-menu. To display the sub-menu, select the item and press <Enter>.

## 4.2.6 Configuration fields

These fields show the values for the menu items. If an item is user-configurable, you can change the value of the field opposite the item. You cannot select an item that is not user-configurable.

A configurable field is enclosed in brackets, and is highlighted when selected. To change the value of a field, select it then press <Enter> to display a list of options. Refer to section “4.2.7 Pop-up window”.

## 4.2.7 Pop-up window

Select a menu item then press <Enter> to display a pop-up window with the configuration options for that item.

## 4.2.8 Scroll bar

A scroll bar appears on the right side of a menu screen when there are items that do not fit on the screen. Press the Up/Down arrow keys or <Page Up> /<Page Down> keys to display the other items on the screen.

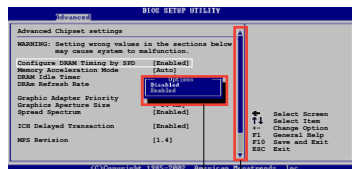

Pop-up window

Scroll bar

## 4.2.9 General help

At the top right corner of the menu screen is a brief description of the selected item.

## 4.3 Main menu

When you enter the BIOS Setup program, the Main menu screen appears, giving you an overview of the basic system information.



Refer to section "4.2.1 BIOS menu screen" for information on the menu screen items and how to navigate through them.



### 4.3.1 System Time [xx:xx:xx]

Allows you to set the system time.

### 4.3.2 System Date [Day xx/xx/xxxx]

Allows you to set the system date.

### 4.3.3 Legacy Diskette A [1.44M, 3.5 in.]

Sets the type of floppy drive installed. Configuration options: [Disabled] [360K, 5.25 in.] [1.2M, 5.25 in.] [720K, 3.5 in.] [1.44M, 3.5 in.] [2.88M, 3.5 in.]



### 4.3.4 Primary, Third and Fourth IDE Master/Slave

The BIOS automatically detects the connected IDE devices. There is a separate sub-menu for each IDE device. Select a device item, then press <Enter> to display the IDE device information.

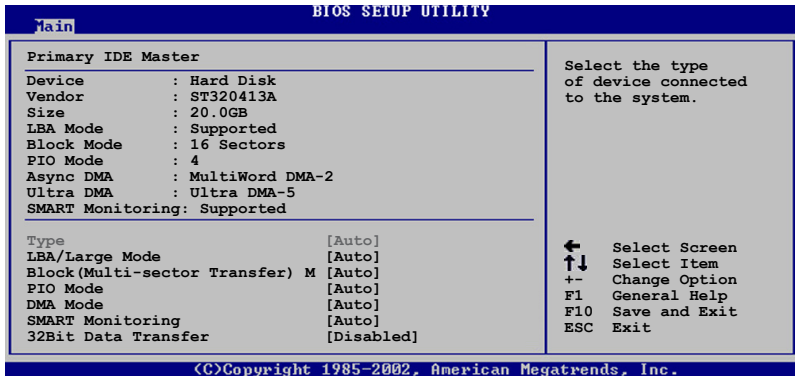

The BIOS automatically detects the values opposite the dimmed items (Device, Vendor, Size, LBA Mode, Block Mode, PIO Mode, Async DMA, Ultra DMA, and SMART monitoring). These values are not user-configurable. These items show N/A if no IDE device is installed in the system.

#### Type [Auto]

Selects the type of IDE drive. Setting to [Auto] allows automatic selection of the appropriate IDE device type. Select [CDROM] if you are specifically configuring a CD-ROM drive. Select [ARMD] (ATAPI Removable Media Device) if your device is either a ZIP, LS-120, or MO drive.

Configuration options: [Not Installed] [Auto] [CDROM] [ARMD]

#### LBA/Large Mode [Auto]

Enables or disables the LBA mode. Setting to [Auto] enables the LBA mode if the device supports this mode, and if the device was not previously formatted with LBA mode disabled.

Configuration options: [Disabled] [Auto]

#### Block (Multi-sector Transfer) M [Auto]

Enables or disables data multi-sectors transfers. When set to [Auto], the data transfer from and to the device occurs multiple sectors at a time if the device supports multi-sector transfer feature. When set to [Disabled], the data transfer from and to the device occurs one sector at a time. Configuration options:

[Disabled] [Auto]

### PIO Mode [Auto]

Selects the PIO mode.

Configuration options: [Auto] [0] [1] [2] [3] [4]

### DMA Mode [Auto]

Selects the DMA mode.

Configuration options: [Auto]

### SMART Monitoring [Auto]

Sets the Smart Monitoring, Analysis, and Reporting Technology. Configuration options: [Auto] [Disabled] [Enabled]

### 32Bit Data Transfer [Disabled]

Enables or disables 32-bit data transfer.

Configuration options: [Disabled] [Enabled]

## 4.3.5 IDE Configuration

The items in this menu allow you to set or change the configurations for the IDE devices installed in the system. Select an item then press <Enter> if you wish to configure the item.

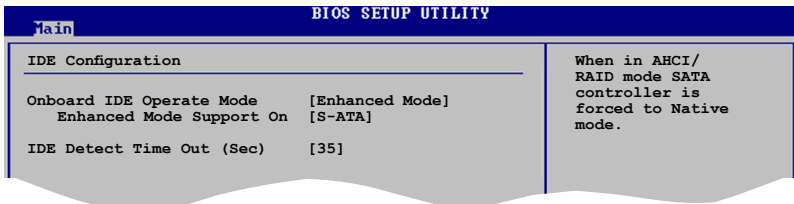

### Onboard IDE Operate Mode [Enhanced Mode]

Allows selection of the IDE operation mode depending on the installed operating system (OS). Set to [Enhanced Mode] if you are using native OS including Windows® 2000/XP/Vista.

Configuration options: [Disabled] [Compatible Mode] [Enhanced Mode]

#### *Enhanced Mode Support On [S-ATA]*

Allows you to use native OS on Serial ATA and Parallel ATA ports. It is recommend that you do not change the default setting for better OS compatibility. In this setting, you may use legacy OS on the Parallel ATA ports only if you do not install any Serial ATA device.

The P-ATA+S-ATA and P-ATA options are for advanced users only. If you set to any of these options and encountered problems, revert to the default setting S-ATA.

Configuration options: [S-ATA+P-ATA] [S-ATA] [P-ATA]



The Onboard IDE Operate Mode and sub-menu items appear only when the Configure SATA As item is set to [Standard IDE].

### IDE Detect Time Out [35]

Selects the time out value for detecting ATA/ATAPI devices.

Configuration options: [0] [5] [10] [15] [20] [25] [30] [35]

## 4.3.6 System Information

This menu gives you an overview of the general system specifications. The BIOS automatically detects the items in this menu.



### AMI BIOS

Displays the auto-detected BIOS information.

### Processor

Displays the auto-detected CPU specification.

### System Memory

Displays the auto-detected total, appropriated (in use), and available system memory.

## 4.4 Advanced menu

The Advanced menu items allow you to change the settings for the CPU and other system devices.



Take caution when changing the settings of the Advanced menu items. Incorrect field values can cause the system to malfunction.

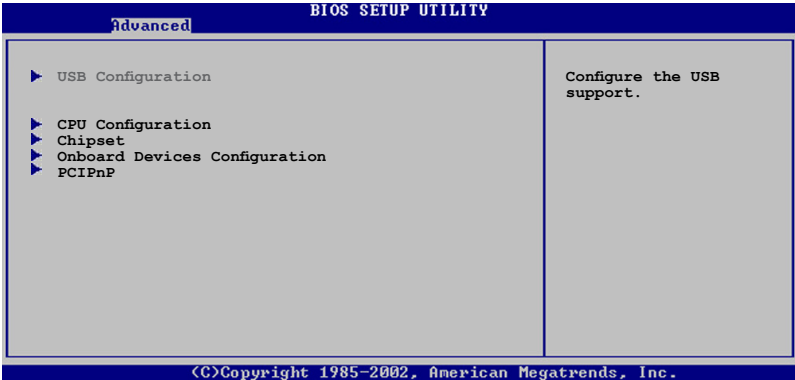

### 4.4.1 USB Configuration

The items in this menu allows you to change the USB-related features. Select an item then press <Enter> to display the configuration options.

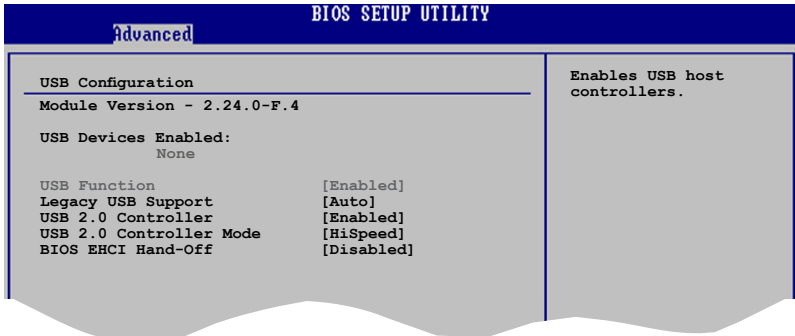

The Module Version and USB Devices Enabled items show the auto-detected values. If no USB device is detected, the item shows None.

### **USB Function [Enabled]**

Allows the BIOS to auto-detect the number of USB ports in your system. Setting this item to [Disable] disables the USB device detection function.

Configuration options: [Disabled] [Enabled]

### **Legacy USB Support [Auto]**

Allows you to enable or disable support for legacy USB devices. Setting to [Auto] allows the system to detect the presence of USB devices at startup. If detected, the USB controller legacy mode is enabled. If no USB device is detected, the legacy USB support is disabled.

Configuration options: [Disabled] [Enabled] [Auto]

### **USB 2.0 Controller [Enabled]**

Allows you to enable or disable the USB 2.0 controller.

Configuration options: [Enabled] [Disabled]

### **USB 2.0 Controller Mode [HiSpeed]**

Allows you to configure the USB 2.0 controller in HiSpeed or Full Speed

Configuration options: [FullSpeed] [HiSpeed]

### **BIOS EHCI Hand-Off [Disabled]**

Allows you to enable support for operating systems without an EHCI hand-off feature.

Configuration options: [Enabled] [Disabled]

## 4.4.2 CPU Configuration

The items in this menu show the CPU-related information that the BIOS automatically detects.

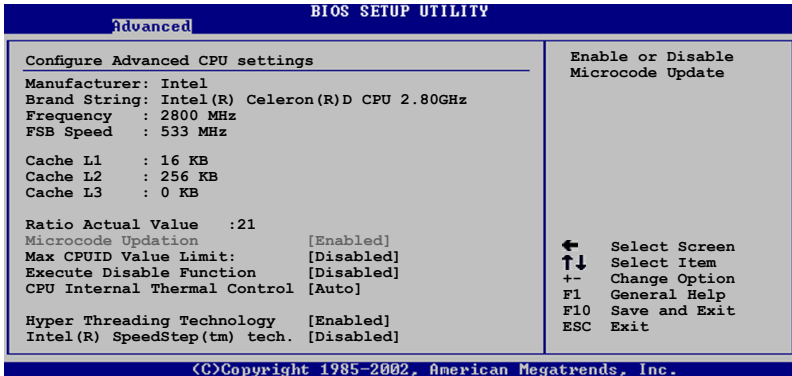

### Microcode Updation [Enabled]

Allows you to enable or disable the microcode updation.

Configuration options: [Disabled] [Enabled]

### Max CPUID Value Limit [Disabled]

Setting this item to [Enabled] allows legacy operating systems to boot even without support for CPUs with extended CPUID functions.

Configuration options: [Disabled] [Enabled]

### Execute Disable Function [Disabled]

Allows you to enable or disable the execute disable function.

Configuration options: [Enabled] [Disabled]

### CPU Internal Thermal Control [Auto]

Allows you to disable or set to auto the CPU Internal Thermal Control function.

Configuration options: [Auto] [Disabled]

### Hyper-Threading Technology [Enabled]

Allows you to enable or disable Hyper-Threading Technology.

Configuration options: [Enable] [Disabled]

### Intel(R) SpeedStep(tm) tech. [Disabled]

Allows you to enable or disable the Intel® SpeedStep™ Technology.

Configuration options: [Enable] [Disabled]

### 4.4.3 Chipset

The menu allows you to change the advanced chipset settings. Select an item then press <Enter> to display the sub-menu.

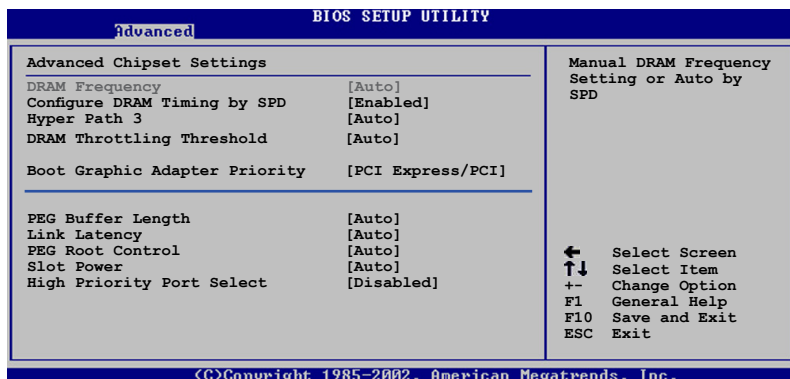

#### Advanced Chipset Settings

##### DRAM Frequency [Auto]

Allows you to set the frequency of DDR memory module.

Configuration options: [Auto] [400Mhz] [533Mhz]

##### Configure DRAM Timing by SPD [Enabled]

When this item is enabled, the DRAM timing parameters are set according to the DRAM SPD (Serial Presence Detect). When disabled, you can manually set the DRAM timing parameters through the DRAM sub-items. The following sub-items appear when this item is Disabled. Configuration options: [Disabled] [Enabled]

###### DRAM CAS# Latency [5 Clocks]

Controls the latency between the SDRAM read command and the time the data actually becomes available.

Configuration options: [6 Clock] [5 Clocks] [4 Clocks] [3 Clocks]

###### DRAM RAS# Precharge [4 Clocks]

Controls the idle clocks after issuing a precharge command to the DDR SDRAM. Configuration options: [2 Clocks] [3 Clocks] [4 Clocks] [5 Clocks] [6 Clocks]

###### DRAM RAS# to # Delay [4 Clocks]

Controls the latency between the DDR active command and the read/write command. Configuration options: [2 Clocks] [3 Clocks] [4 Clocks] [5 Clocks] [6 Clocks]

*DRAM # Activate to Precharge [15 Clocks]*

Configuration options: [4 Clocks] [5 Clocks] ~ [18 Clocks]

*DRAM Write Recovery Time [4 Clocks]*

Configuration options: [2 Clocks] [3 Clocks] [4 Clocks] [5 Clocks] [6 Clocks]

### **Hyper Path 3 [Auto]**

Allows you to enable or disable the ASUS Hyper Path 3 feature. Configuration options: [Disabled] [Enabled] [Auto]

### **DRAM Throttling Threshold [Auto]**

Enable DRAM Throttling Thermal Throttling will make your system more stable. Configuration options: [Disabled] [Auto]

### **Booting Graphic Adapter Priority [PCI Express/PCI]**

Allows selection of the graphics controller to use as primary boot device. Configuration options: [PCI Express/ /PCI Express]

### **PEG Buffer Length [Auto]**

Sets the length of the PCI Express graphics card buffer. Configuration options: [Auto] [Long] [Short]

### **Link Latency [Auto]**

Sets the PCI Express graphics card link latency. Configuration options: [Auto] [Slow] [Normal]

### **PEG Root Control [Auto]**

Allows you to enable, disable, or set to automatic the PCI Express graphics card root control. Configuration options: [Auto] [Disabled] [Enabled]

### **Slot Power [Auto]**

Sets the PCI Express graphics card slot power. Configuration options: [Auto] [Light] [Normal] [Heavy] [Heavier]

### **High Priority Port Select [Disabled]**

Allows you to disable or select the high priority port. The specified high priority port will be given arbitration above but below . Configuration options: [Disabled] [PCI Express Port 4]



## 4.4.4 Onboard Devices Configuration

Advanced		BIOS SETUP UTILITY	
<b>Configure Win627DHG Super IO Chipset</b>		Enable or disable High Definition Audio Controller.	
HD Audio Controller	[Enabled]		
Front Panel Support Type	[HD Audio]		
Onboard PCIEX 10/100Mb LAN	[Enabled]		
LAN Option ROM	[Disabled]		
Serial Port1 Address	[3F8/IRQ4]		
Parallel Port Address	[378]		
Parallel Port Mode	[ECP]		
ECP Mode DMA Channel	[DMA3]		
Parallel Port IRQ	[IRQ7]		

(C)Copyright 1985-2002, American Megatrends, Inc.

### HD Audio Controller [Enabled]

Allows you to enable or disable the high-definition audio CODEC.  
Configuration options: [Enabled] [Disabled]

### Front Panel Support Type [HD Audio]

Allows you to select mode according to your panel type.  
Configuration options: [AC97] [HD Audio]

### OnBoard PCIEX 10/100Mb LAN [Enabled]

Allows you to enable or disable the onboard PCI Express 10/100Mb LAN controller.  
Configuration options: [Disabled] [Enabled]

#### *LAN Option ROM [Disabled]*

This item allows you to enable or disable the option ROM in the onboard LAN controller. This item appears only when the Onboard PCIEX 10/100Mb LAN items are set to Enabled.  
Configuration options: [Disabled] [Enabled]

### Serial Port1 Address [3F8/IRQ4]

Allows you to select the Serial Port1 base address.  
Configuration options: [Disabled] [3F8/IRQ4] [2F8/IRQ3] [3E8/IRQ4] [2E8/IRQ3]

### Parallel Port Address [378]

Allows you to select the Parallel Port base addresses.  
Configuration options: [Disabled] [378] [278] [3BC]

## **Parallel Port Mode [ECP]**

Allows you to select the Parallel Port mode.

Configuration options: [Normal] [Bi-directional] [EPP] [ECP]

ECP Mode DMA Channel [DMA3]

Appears only when the Parallel Port Mode is set to [ECP].

This item allows you to set the Parallel Port ECP DMA.

Configuration options: [DMA0] [DMA1] [DMA3]

*Parallel Port IRQ [IRQ7]*

Configuration options: [IRQ5] [IRQ7]

## 4.4.5 PCI PnP

The PCI PnP menu items allow you to change the advanced settings for PCI/PnP devices. The menu includes setting IRQ and DMA channel resources for either PCI/PnP or legacy ISA devices, and setting the memory size block for legacy ISA devices.



Take caution when changing the settings of the PCI PnP menu items. Incorrect field values can cause the system to malfunction.

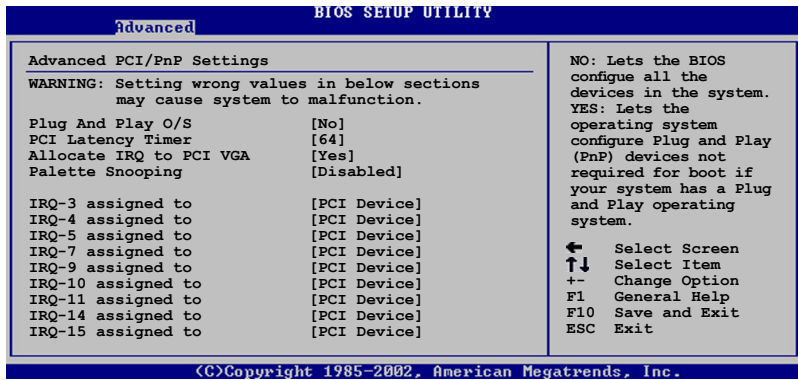

### Plug And Play O/S [No]

When set to [No], BIOS configures all the devices in the system. When set to [Yes] and if you install a Plug and Play operating system, the operating system configures the Plug and Play devices not required for boot. Configuration options: [No] [Yes]

### PCI Latency Timer [64]

Allows you to select the value in units of PCI clocks for the PCI device latency timer register. Configuration options: [32] [64] [96] [128] [160] [192] [224] [248]

### Allocate IRQ to PCI VGA [Yes]

When set to [Yes], BIOS assigns an IRQ to PCI VGA card if the card requests for an IRQ. When set to [No], BIOS does not assign an IRQ to the PCI VGA card even if requested. Configuration options: [No] [Yes]

### Palette Snooping [Disabled]

When set to [Enabled], the palette snooping feature informs the PCI devices that an ISA graphics device is installed in the system so that the latter can function correctly. Configuration options: [Disabled] [Enabled]

**IRQ-xx assigned to [PCI Device]**

When set to [PCI Device], the specific IRQ is free for use of PCI/PnP devices.

When set to [Reserved], the IRQ is reserved for legacy ISA devices. Configuration options: [PCI Device] [Reserved]

## 4.5 Power menu

The Power menu items allow you to change the settings for the ACPI and Advanced Power Management (APM) features. Select an item then press <Enter> to display the configuration options.

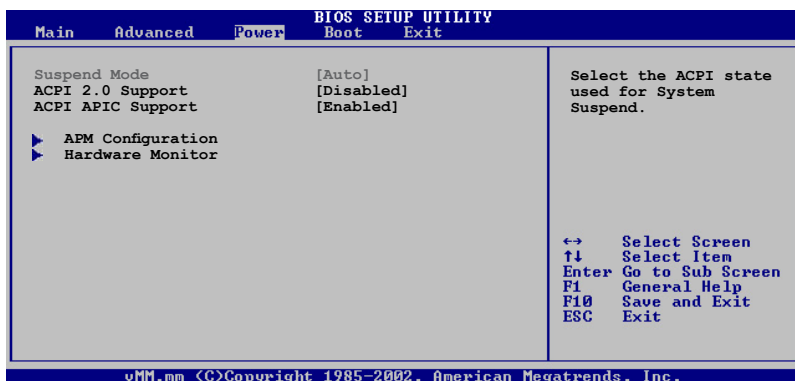

### 4.5.1 Suspend Mode [Auto]

Allows you to select the Advanced Configuration and Power Interface (ACPI) state to be used for system suspend.

Configuration options: [S1 (POS) Only] [S3 Only] [Auto]

### 4.5.2 ACPI 2.0 Support [Disabled]

Allows you to add more tables for Advanced Configuration and Power Interface (ACPI) 2.0 specifications.

Configuration options: [Disabled] [Enabled]

### 4.5.3 ACPI APIC Support [Enabled]

Allows you to enable or disable the Advanced Programmable Interrupt Controller (APIC) mode under Advanced Configuration and Power Interface (ACPI).

When enabled, the ACPI APIC table pointer is included in the RSDT pointer list.

Configuration options: [Disabled] [Enabled]

## 4.5.4 APM Configuration

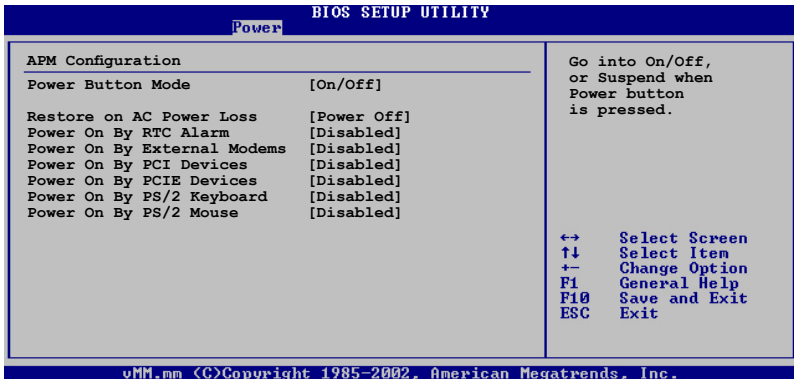

### Power Button Mode [On/Off]

Allows the system to go into On/Off mode or suspend mode when the power button is pressed. Configuration options: [On/Off] [Suspend]

### Restore on AC Power Loss [Power Off]

When set to Power Off, the system goes into off state after an AC power loss. When set to Power On, the system goes on after an AC power loss. When set to Last State, the system goes into either off or on state, whatever the system state was before the AC power loss.

Configuration options: [Power Off] [Power On] [Last State]

### Power On By RTC Alarm [Disabled]

Allows you to enable or disable RTC to generate a wake event. Configuration options: [Disabled] [Enabled]



The succeeding items appear when the Power On By RTC Alarm item is set to Enabled.

#### RTC Alarm Date

To set the alarm date, highlight this item and press the <+> or <-> key to make the selection. Configuration options: [Everyday] [1] [2] [3]... ~ [31]

#### RTC Alarm Hour

To set the alarm hour, highlight this item and press the <+> or <-> key to make the selection. Configuration options: [00] [1]... ~ [23]

#### *RTC Alarm Minute*

To set the alarm minute, highlight this item and press the <+> or <-> key to make the selection. Configuration options: [00] [1]... ~ [59]

#### *RTC Alarm Second*

To set the alarm second, highlight this item and press the <+> or <-> key to make the selection. Configuration options: [00] [1]... ~ [59]

### **Power On By External Modems [Disabled]**

Allows either settings of [Enabled] or [Disabled] for powering up the computer when the external modem receives a call while the computer is in Soft-off mode. Configuration options: [Disabled] [Enabled]



---

The computer cannot receive or transmit data until the computer and applications are fully running. Thus, connection cannot be made on the first try. Turning an external modem off and then back on while the computer is off causes an initialization string that turns the system power on.

---

### **Power On By PCI Devices [Disabled]**

When set to [Enabled], this parameter allows you to turn on the system through a PCI LAN or modem card. This feature requires an ATX power supply that provides at least 1A on the +5VSB lead.

Configuration options: [Disabled] [Enabled]

### **Power On By PCIE Devices [Disabled]**

When set to [Enabled], this parameter allows you to turn on the system through a PCI Express card. This feature requires an ATX power supply that provides at least 1A on the +5VSB lead.

Configuration options: [Disabled] [Enabled]

### **Power On By PS/2 Keyboard [Disabled]**

Allows you to use specific keys on the keyboard to turn on the system. This feature requires an ATX power supply that provides at least 1A on the +5VSB lead.

Configuration options: [Disabled] [Space Bar] [Ctrl-Esc] [Power Key]

### **Power On By PS/2 Mouse [Disabled]**

When set to [Enabled], this parameter allows you to use the PS/2 mouse to turn on the system. This feature requires an ATX power supply that provides at least 1A on the +5VSB lead. Configuration options: [Disabled] [Enabled]

## 4.5.5 Hardware Monitor

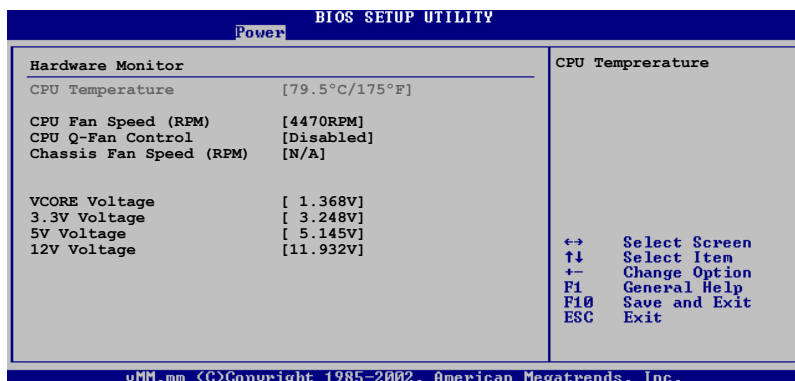

### CPU Temperature [xx.x°C/xx.x°F]

### CPU Fan Speed (RPM) [xxxx RPM] or [Ignored]

The onboard hardware monitor automatically detects and displays the CPU fan speed in rotations per minute (RPM). If the fan is not connected to the motherboard, the field shows N/A.

### CPU Q-Fan Control [Disabled]

Allows you to enable or disable the ASUS Q-Fan feature that smartly adjusts the fan speeds for more efficient system operation. Configuration options: [Disabled] [Enabled]

---

The CPU Fan Profile Mode item appears when you enable the CPU Q-Fan Control feature.

---

#### *CPU Fan Profile Mode [Optimal]*

Allows you to set the appropriate CPU fan performance level. When set to [Optimal], the CPU fan speed automatically adjusts depending on the CPU temperature. Set this item to [Silent Mode] for silent CPU fan operation or [Performance Mode] to achieve the maximum CPU fan speed. Configuration options: [Optimal]

[Silent Mode] [Performance Mode]

### Chassis Fan1 Speed (RPM) [N/A] [xxxx RPM] or [Ignored]

The onboard hardware monitor automatically detects and displays the chassis fan speed in rotations per minute (RPM). If the fan is not connected to the chassis, the specific field shows N/A.

### VCORE Voltage, 3.3V Voltage, 5V Voltage, 12V Voltage

The onboard hardware monitor automatically detects the voltage output through the onboard voltage regulators.



## 4.6 Boot menu

The Boot menu items allow you to change the system boot options. Select an item then press <Enter> to display the sub-menu.

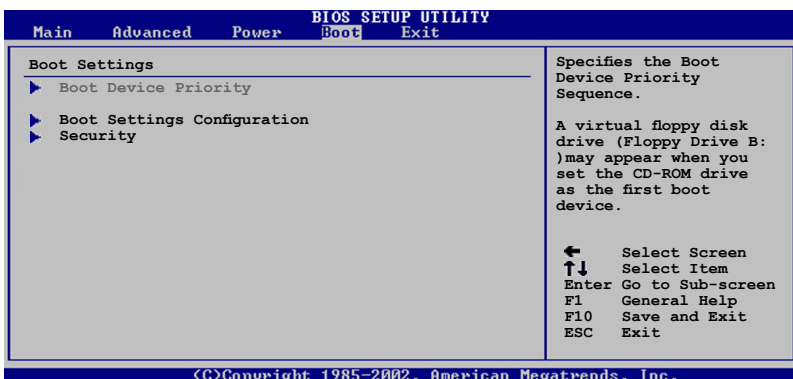

### 4.6.1 Boot Device Priority

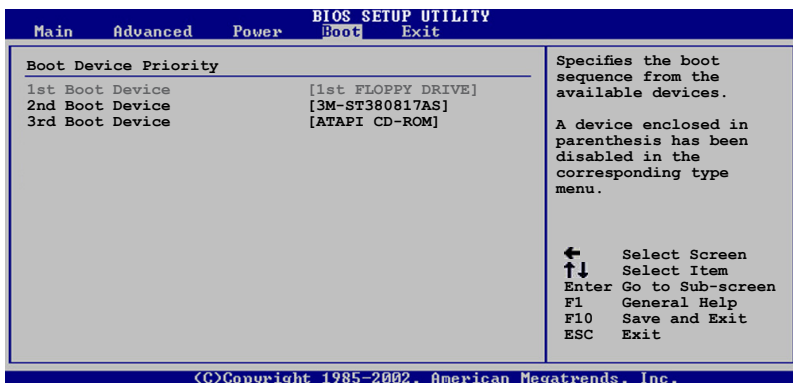

#### 1st ~ xxth Boot Device [1st Floppy Drive]

These items specify the boot device priority sequence from the available devices. The number of device items that appears on the screen depends on the number of devices installed in the system.

Configuration options: [xxxxx Drive] [3M-ST380817AS] [ATAPI CD-ROM] or [Disabled]

## 4.6.2 Boot Settings Configuration

BIOS SETUP UTILITY	
Boot	
<b>Boot Settings Configuration</b>	
Quick Boot	[Enabled]
Full Screen Logo	[Enabled]
AddOn ROM Display Mode	[Force BIOS]
Bootup Num-Lock	[On]
PS/2 Mouse Support	[Auto]
Wait For 'F1' If Error	[Enabled]
Hit 'DEL' Message Display	[Enabled]
Interrupt 19 Capture	[Disabled]

Allows BIOS to skip certain tests while booting. This will decrease the time needed to boot the system.

### Quick Boot [Enabled]

Enabling this item allows the BIOS to skip some power on self tests (POST) while booting to decrease the time needed to boot the system. When set to [Disabled], BIOS performs all the POST items.

Configuration options: [Disabled] [Enabled]

### Full Screen Logo [Enabled]

Allows you to enable or disable the full screen logo display feature. Configuration options: [Disabled] [Enabled]



Set this item to [Enabled] to use the ASUS MyLogo™ feature.

### Add On ROM Display Mode [Force BIOS]

Sets the display mode for option ROM.

Configuration options: [Force BIOS] [Keep Current]

### Bootup Num-Lock [On]

Allows you to select the power-on state for the NumLock.

Configuration options: [Off] [On]

### PS/2 Mouse Support [Auto]

Allows you to enable or disable support for PS/2 mouse.

Configuration options: [Disabled] [Enabled] [Auto]

### Wait for 'F1' If Error [Enabled]

When set to Enabled, the system waits for the F1 key to be pressed when error occurs. Configuration options: [Disabled] [Enabled]

### Hit 'DEL' Message Display [Enabled]

When set to Enabled, the system displays the message "Press DEL to run Setup" during POST. Configuration options: [Disabled] [Enabled]

## Interrupt 19 Capture [Disabled]

When set to [Enabled], this function allows the option ROMs to trap Interrupt 19. Configuration options: [Disabled] [Enabled]

### 4.6.3 Security

The Security menu items allow you to change the system security settings. Select an item then press <Enter> to display the configuration options.

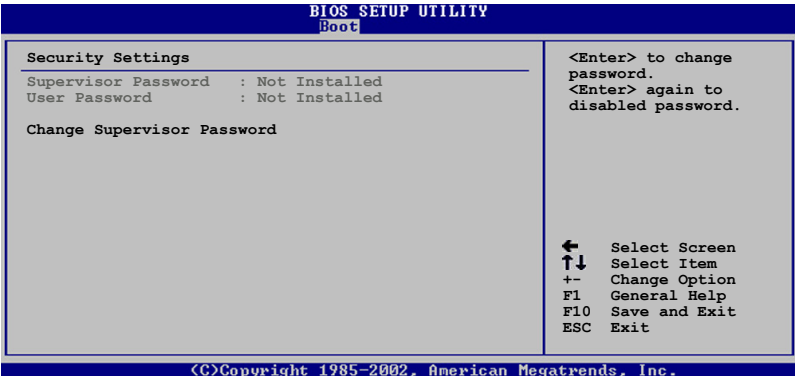

### Change Supervisor Password

Select this item to set or change the supervisor password. The Supervisor Password item on top of the screen shows the default Not Installed. After you set a password, this item shows Installed.

To set a Supervisor Password:

1. Select the Change Supervisor Password item, then press <Enter>.
2. From the password box, type a password composed of at least six letters and/or numbers, then press <Enter>.
3. Confirm the password when prompted.

The message "Password Installed" appears after you successfully set your password.

To change the supervisor password, follow the same steps as in setting a user password.

To clear the supervisor password, select the Change Supervisor Password then press <Enter>. The message "Password Uninstalled" appears.



If you forget your BIOS password, you can clear it by erasing the CMOS Real Time Clock (RTC) RAM. See section "2.6 Jumpers" for information on how to erase the RTC RAM.

After you have set a supervisor password, the other items appear to allow you to change other security settings.

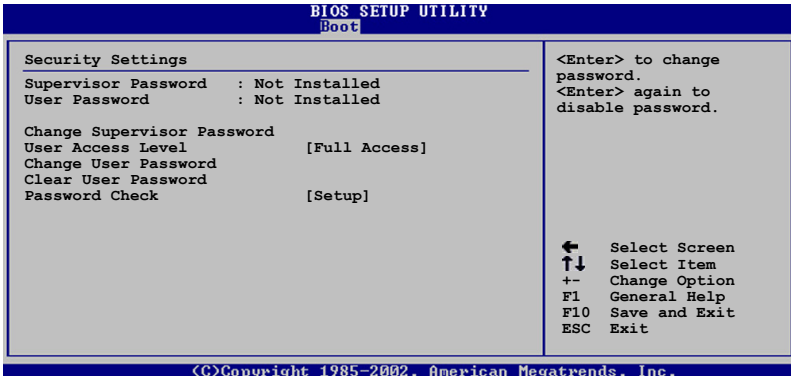

### User Access Level [Full Access]

This item allows you to select the access restriction to the Setup items. Configuration options: [No Access] [View Only] [Limited] [Full Access]

No Access prevents user access to the Setup utility.

View Only allows access but does not allow change to any field.

Limited allows changes only to selected fields, such as Date and Time.

Full Access allows viewing and changing all the fields in the Setup utility.

### Change User Password

Select this item to set or change the user password. The User Password item on top of the screen shows the default Not Installed. After you set a password, this item shows Installed.

To set a User Password:

1. Select the Change User Password item and press <Enter>.
2. On the password box that appears, type a password composed of at least six letters and/or numbers, then press <Enter>.
3. Confirm the password when prompted.

The message "Password Installed" appears after you set your password successfully.

To change the user password, follow the same steps as in setting a user password.

### **Clear User Password**

Select this item to clear the user password.

### **Password Check [Setup]**

When set to [Setup], BIOS checks for user password when accessing the Setup utility. When set to [Always], BIOS checks for user password both when accessing Setup and booting the system.

Configuration options: [Setup] [Always]

## 4.7 Exit menu

The Exit menu items allow you to load the optimal or failsafe default values for the BIOS items, and save or discard your changes to the BIOS items.

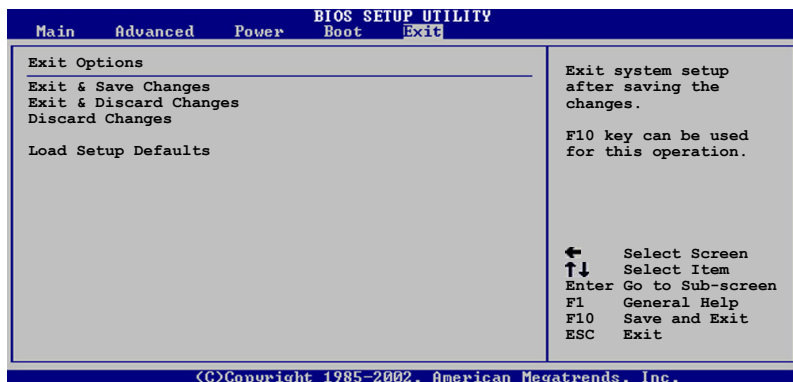

Pressing <Esc> does not immediately exit this menu. Select one of the options from this menu or <F10> from the legend bar to exit.

### Exit & Save Changes

Once you are finished making your selections, choose this option from the Exit menu to ensure the values you selected are saved to the CMOS RAM. An onboard backup battery sustains the CMOS RAM so it stays on even when the computer is turned off. When you select this option, a confirmation window appears. Select <OK> to save the changes and exit.



If you attempt to exit the Setup program without saving your changes, the program prompts you with a message asking if you want to save your changes before exiting. Press <Enter> to save the changes while exiting.

### Exit & Discard Changes

Select this option only if you do not want to save the changes that you made to the Setup program. If you made changes to fields other than System Date, System Time, and Password, the BIOS asks for a confirmation before exiting.

### Discard Changes

Allows you to discard the selections you made and restore the previously saved values. After selecting this option, a confirmation appears. Select <OK> to discard any changes and load the previously saved values.

## **Load Setup Defaults**

Allows you to load the default values for each of the parameters on the Setup menus. When you select this option or if you press <F5>, a confirmation window appears. Select <OK> to load the default values. Select Exit & Save Changes or make other changes before saving the values to the non-volatile RAM.-





This chapter describes the contents of the support CD that comes with the motherboard package.

# 5 Software support

5.1	Installing an operating system .....	5-1
5.2	Support CD information .....	5-1
5.3	ASUS MyLogo™ .....	5-6

## 5.1 Installing an operating system

This motherboard supports Windows® 2000/2003 Server/XP/64-bit XP/Vista operating systems (OS). Always install the latest OS version and corresponding updates to maximize the features of your hardware.



- Motherboard settings and hardware options vary. Use the setup procedures presented in this chapter for reference only. Refer to your OS documentation for detailed information.
- Make sure that you install Windows® 2000 Service Pack 4 or the Windows® XP Service Pack2 or later versions before installing the drivers for better compatibility and system stability.

## 5.2 Support CD information

The support CD that came with the motherboard package contains the drivers, and utilities that you can install to avail all motherboard features.



The contents of the support CD are subject to change at any time without notice. Visit the ASUS website ([www.asus.com](http://www.asus.com)) for updates.

### 5.2.1 Running the support CD

Place the support CD to the optical drive. The CD automatically displays the Drivers menu if Autorun is enabled in your computer.

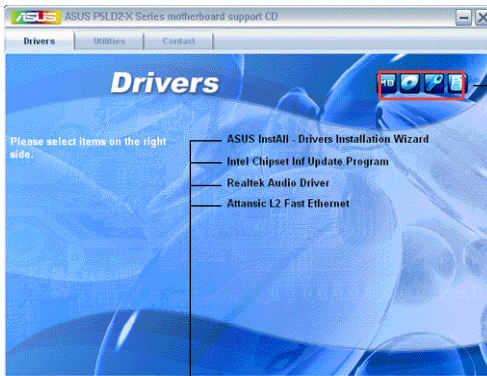

Click an icon to display support CD/motherboard information

Click an item to install



If Autorun is NOT enabled in your computer, browse the contents of the support CD to locate the file ASSETUP.EXE from the BIN folder. Double-click the ASSETUP.EXE to run the CD.

## 5.2.2 Drivers menu

The drivers menu shows the available device drivers if the system detects installed devices. Install the necessary drivers to activate the devices.



### **ASUS InstALL - Drivers Installation Wizard**

Installs the ASUS InstALL - Drivers Installation Wizard.

### **Intel Chipset Inf Update Program**

Installs the Intel Chipset Inf Update Program.

### **Realtek Audio Driver**

Install the Realtek Audio Driver.

### **Attansic L2 Fast Ethernet**

Installs the Attansic L2 Fast Ethernet.

## 5.2.3 Utilities menu

The Utilities menu shows the applications and other software that the motherboard supports.

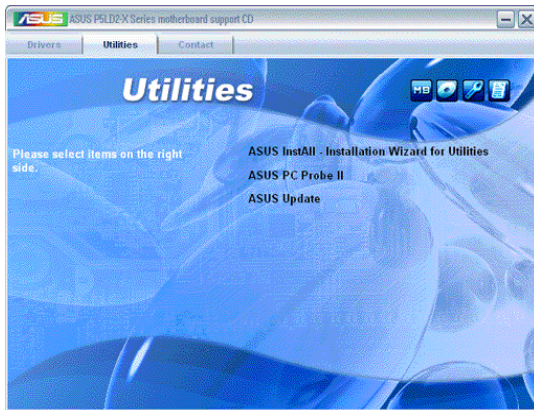

### ASUS InstAll - Installation Wizard for Utilities

This wizard guides you in installing the utilities.

### ASUS PC Probe II

This smart utility monitors the fan speed, CPU temperature, and system voltages, and alerts you of any detected problems. This utility helps you keep your computer in healthy operating condition.

### ASUS Update

Allows you to download the latest version of the BIOS from the ASUS website.



Before using the ASUS Update, make sure that you have an Internet connection so you can connect to the ASUS website.

## 5.2.4 ASUS Contact information

Click the Contact tab to display the ASUS contact information. You can also find this information on the inside front cover of this user guide.

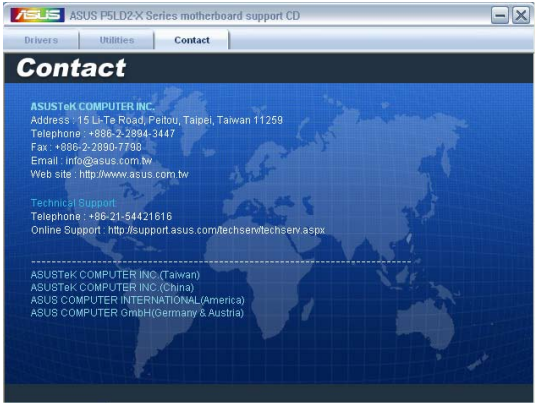

## 5.2.5 Other information

The icons on the top right corner of the screen give additional information on the motherboard and the contents of the support CD. Click an icon to display the specified information.

### Motherboard Info

Displays the general specifications of the motherboard.

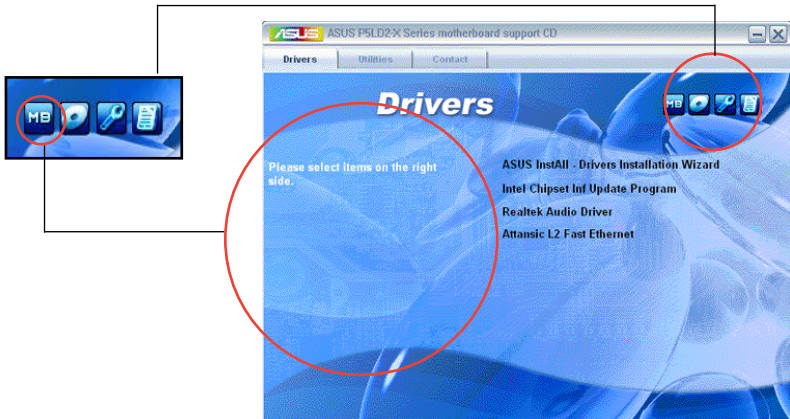

## Browse this CD

Displays the support CD contents in graphical format.

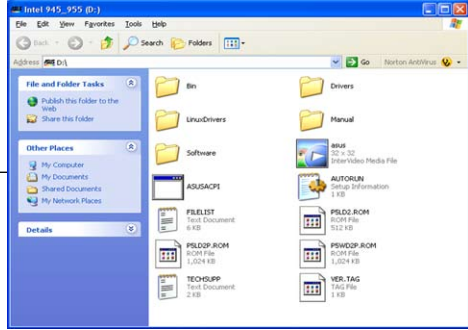
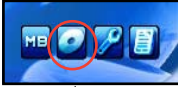

## Technical support Form

Displays the ASUS Technical Support Request Form that you have to fill out when requesting technical support.

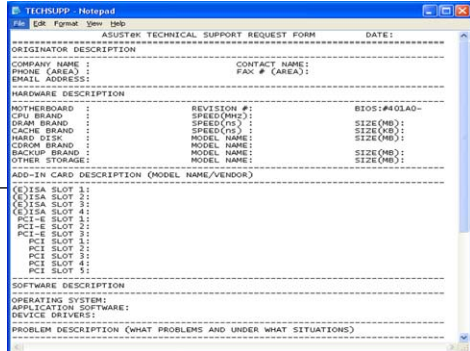

```
ASUSTEK TECHNICAL SUPPORT REQUEST FORM DATE:
-----
COMPANY NAME: CONTACT NAME:
PHONE (AREA): FAX # (AREA):
EMAIL ADDRESS:
HARDWARE DESCRIPTION
MOTHERBOARD : REVISION #: BIOS:#401A0-
CPU BRAND : SPEED(MHZ): SIZE(MB):
DRAM BRAND : SPEED(M/S) : SIZE(KB):
CACHE BRAND : SPEED(M/S) : SIZE(KB):
HARD DISK : MODEL NAME: SIZE(MB):
CDROM BRAND : MODEL NAME: SIZE(MB):
BACKUP BRAND : MODEL NAME: SIZE(MB):
OTHER STORAGE : MODEL NAME: SIZE(MB):
ADD-IN CARD DESCRIPTION (MODEL NAME/VENDOR)
-----
(C)ISA SLOT 1:
(C)ISA SLOT 2:
(C)ISA SLOT 3:
(C)ISA SLOT 4:
PCI-E SLOT 1:
PCI-E SLOT 2:
PCI-E SLOT 3:
PCI SLOT 1:
PCI SLOT 2:
PCI SLOT 3:
PCI SLOT 4:
PCI SLOT 5:
SOFTWARE DESCRIPTION
-----
OPERATING SYSTEM:
APPLICATION SOFTWARE:
DEVICE DRIVERS:
PROBLEM DESCRIPTION (WHAT PROBLEMS AND UNDER WHAT SITUATIONS)
```

## Filelist

Displays the contents of the support CD and a brief description of each in text format.



```
File list for the included support software for Intel 945_955 Series motherboard
-----
File Name      Description
-----
-Drivers
--Audio
--Realtek      -Realtek ALC880/882 Audio driver V5.10.0.1122 For Windows 2000/XP/2003.
--Sd_blt       -Realtek ALC880/882 Audio driver V5.10.0.1116 For 64bit XP/2003.
-Chipset
--Intel        -Intel(R) Chipset software installation utility v5.0.0.1019 For Windows 2000/XP/200
--Intel(R)     -Intel(R) Matrix Storage Manager Installation Utility v5.0.0.1032 For Windows 2000/
-LAN
--SO3
--net5000
--VCT          -Marvell Yukon gigabit Ethernet Driver v7.24.1.3 for Windows 2000/XP/2003(WHQ)
--VCT_package -Marvell VCT package V5.1.1.3 For 2000/XP/2003
--VCT_64bit    -Marvell VCT package V5.1.1.3 For 64bit XP/2003.
--net         -Marvell UCI driver for 64bit v2.00.
--Client_32    -Marvell Yukon Client 32 driver v7.05.
--net         -Marvell 805.002 driver V7.06.
--Network      -Marvell Yukon Network 4.0 driver V7.03.
--net         -Marvell Yukon Network 3.1.0 driver v7.03.
--net         -Marvell SCC firmware 7.1.0 driver and oemutils 8.0.
--sd_blt       -Marvell Yukon gigabit Ethernet driver v7.3.1.3 beta for Windows 64bit XP/2003.
--Teloa        -Intel(R) Teloa Ethernet driver V6.0.8.0 for Windows 2000/XP/2003.
-IT8211
--SATA         -IT8211 ATA RAID Controller driver and Application v5.3.1.9 for Windows 2000/XP(WHQ)
--SATA         -IT8211 ATA RAID Controller driver V5.3.1.95 For Windows 64bit XP/2003.
-SATA
--S11332      -silicon image Serial ATA Raid 5 driver V5.2.2.0 and utility for for XP/2k/2003.
--RAID_1_driver -Silicon Image S11 3132 SATA RAID driver V5.2.1.0 For XP/2k/2003.
--RAID_driver
-Manual        -user guide PDF file.
--Software
--Acrobat      -Adobe Acrobat Reader v5.0.
```

## 5.3 ASUS MyLogo™

The ASUS MyLogo™ utility lets you customize the boot logo. The boot logo is the image that appears on screen during the Power-On Self-Tests (POST). The ASUS MyLogo™ is automatically installed when you install the ASUS Update utility from the support CD. See section “5.2.3 Utilities menu” for details.



- Before using the ASUS MyLogo™, use the AFUDOS utility to make a copy of your original BIOS file, or obtain the latest BIOS version from the ASUS website. See section “4.1.2 AFUDOS utility”.
- Make sure that the BIOS item Full Screen Logo is set to [Enabled] if you wish to use ASUS MyLogo. See section “4.6.2 Boot Settings Configuration”.
- You can create your own boot logo image in GIF, JPG, or BMP file formats.



To launch the ASUS MyLogo™:

1. Launch the ASUS Update utility. Refer to section “4.1.5 ASUS Update utility” for details.
2. Select Options from the drop down menu, then click Next.
3. Check the option Launch MyLogo to replace system boot logo before flashing BIOS, then click Next.
4. Select Update BIOS from a file from the drop down menu, then click Next.
5. When prompted, locate the new BIOS file, then click Next. The ASUS MyLogo window appears.
6. From the left window pane, select the folder that contains the image you intend to use as your boot logo.



7. When the logo images appear on the right window pane, select an image to enlarge by clicking on it.



8. Adjust the boot image to your desired size by selecting a value on the Ratio box.



9. When the screen returns to the ASUS Update utility, flash the original BIOS to load the new boot logo.
10. After flashing the BIOS, restart the computer to display the new boot logo during POST.

The Appendix describes the CPU features that the motherboard supports.

# Appendix A CPU features

## Chapter summary



A.1	Enhanced Intel SpeedStep® Technology (EIST) .....	A-1
A.2	Intel® Hyper-Threading Technology .....	A-2

# A.1 Enhanced Intel SpeedStep® Technology (EIST)



- The motherboard comes with a BIOS file that supports EIST. You can download the latest BIOS file from the ASUS website ([www.asus.com/support/download/](http://www.asus.com/support/download/)) if you need to update the BIOS. See Chapter 4 for details.
- Visit [www.intel.com](http://www.intel.com) for more information on the EIST feature.

## A.1.1 System requirements

Before using EIST, check your system if it meets the following requirements:

- Intel® Pentium® 4 processor with EIST support
- BIOS file with EIST support
- Operating system with EIST support (Windows® XP SP2/Windows® Server 2003 SP1/Linux 2.6 kernel or later versions)

## A.1.2 Using the EIST

To use the EIST feature:

1. Turn on the computer, then enter the BIOS Setup.
2. Go to the Advanced Menu, highlight CPU Configuration, then press <Enter>.
3. Set the Intel(R) SpeedStep Technology item to [Enabled], then press <Enter>. See page 4-20 for details.
4. Press <F10> to save your changes and exit the BIOS setup.
5. After the computer restarts, right click on a blank space on the desktop, then select Properties from the pop-up menu.
6. When the Display Properties window appears, click the Screen Saver tab.
7. Click the Power button on the Monitor power section to open the Power Options Properties window.

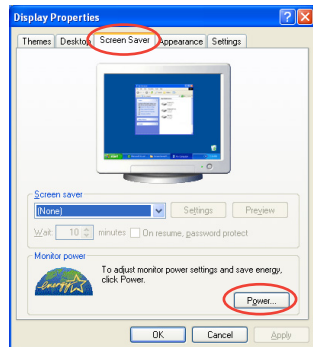

8. On the Power schemes section, click  , then select any option **except** Home/Office Desktop or Always On.
9. Click **Apply**, then click **OK**.
10. Close the Display Properties window. After you adjust the power scheme, the CPU internal frequency slightly decreases when the CPU loading is low.

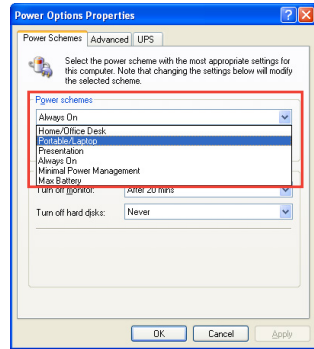

The screen displays and procedures may vary depending on the operating system.

## A.2 Intel® Hyper-Threading Technology



- The motherboard supports Intel® Pentium® 4 LGA775 processors with Hyper-Threading Technology.
- Hyper-Threading Technology is supported under Windows® XP/2003 Server and Linux 2.4.x (kernel) and later versions only. Under Linux, use the Hyper-Threading compiler to compile the code. If you are using any other operating systems, disable the Hyper-Threading Technology item in the BIOS to ensure system stability and performance.
- Installing Windows® XP Service Pack 1 or later version is recommended.
- Make sure to enable the Hyper-Threading Technology item in BIOS before installing a supported operating system.
- For more information on Hyper-Threading Technology, visit [www.intel.com/info/hyperthreading](http://www.intel.com/info/hyperthreading).

### Using the Hyper-Threading Technology

To use the Hyper-Threading Technology:

1. Install an Intel® Pentium® 4 LGA775 CPU that supports Hyper-Threading Technology.
2. Power up the system and enter the BIOS Setup. Under the Advanced Menu, make sure that the item Hyper-Threading Technology is set to [Enabled]. See page 4-20 for details.  
The BIOS item appears only if you installed a CPU that supports Hyper-Threading Technology.
3. Restart the computer.