

Z7S WS

Motherboard



E3465

First Edition V1

February 2008

Copyright © 2008 ASUSTeK COMPUTER INC. All Rights Reserved.

No part of this manual, including the products and software described in it, may be reproduced, transmitted, transcribed, stored in a retrieval system, or translated into any language in any form or by any means, except documentation kept by the purchaser for backup purposes, without the express written permission of ASUSTeK COMPUTER INC. ("ASUS").

Product warranty or service will not be extended if: (1) the product is repaired, modified or altered, unless such repair, modification or alteration is authorized in writing by ASUS; or (2) the serial number of the product is defaced or missing.

ASUS PROVIDES THIS MANUAL "AS IS" WITHOUT WARRANTY OF ANY KIND, EITHER EXPRESS OR IMPLIED, INCLUDING BUT NOT LIMITED TO THE IMPLIED WARRANTIES OR CONDITIONS OF MERCHANTABILITY OR FITNESS FOR A PARTICULAR PURPOSE. IN NO EVENT SHALL ASUS, ITS DIRECTORS, OFFICERS, EMPLOYEES OR AGENTS BE LIABLE FOR ANY INDIRECT, SPECIAL, INCIDENTAL, OR CONSEQUENTIAL DAMAGES (INCLUDING DAMAGES FOR LOSS OF PROFITS, LOSS OF BUSINESS, LOSS OF USE OR DATA, INTERRUPTION OF BUSINESS AND THE LIKE), EVEN IF ASUS HAS BEEN ADVISED OF THE POSSIBILITY OF SUCH DAMAGES ARISING FROM ANY DEFECT OR ERROR IN THIS MANUAL OR PRODUCT.

SPECIFICATIONS AND INFORMATION CONTAINED IN THIS MANUAL ARE FURNISHED FOR INFORMATIONAL USE ONLY, AND ARE SUBJECT TO CHANGE AT ANY TIME WITHOUT NOTICE, AND SHOULD NOT BE CONSTRUED AS A COMMITMENT BY ASUS. ASUS ASSUMES NO RESPONSIBILITY OR LIABILITY FOR ANY ERRORS OR INACCURACIES THAT MAY APPEAR IN THIS MANUAL, INCLUDING THE PRODUCTS AND SOFTWARE DESCRIBED IN IT.

Products and corporate names appearing in this manual may or may not be registered trademarks or copyrights of their respective companies, and are used only for identification or explanation and to the owners' benefit, without intent to infringe.

Contents

Contents	iii
Notices	vii
Safety information	viii
About this guide	ix
Z7S WS specifications summary	xi
Chapter 1: Product introduction	
1.1 Welcome!	1-1
1.2 Package contents	1-1
1.3 Special features	1-2
1.3.1 Product highlights	1-2
1.3.2 Innovative ASUS features	1-4
Chapter 2: Hardware information	
2.1 Before you proceed	2-1
2.2 Motherboard overview	2-2
2.2.1 Placement direction	2-2
2.2.2 Screw holes	2-2
2.2.3 Support kits for the motherboard	2-3
2.2.4 Motherboard layout	2-6
2.2.5 Audio card layout	2-6
2.2.6 Layout contents	2-7
2.3 Central Processing Unit (CPU)	2-9
2.3.1 Installing the CPU	2-9
2.3.2 Installing the CPU heatsink and fan	2-12
2.4 System memory	2-14
2.4.1 Overview	2-14
2.4.2 Memory configurations	2-14
2.4.3 Memory sparing technology	2-16
2.4.4 Installing a DIMM	2-17
2.4.5 Removing a DIMM	2-17
2.4.6 Installing the MemCool FB-DIMM fan (optional)	2-18
2.5 Expansion slots	2-20
2.5.1 Installing an expansion card	2-20
2.5.2 Configuring an expansion card	2-20
2.5.3 Interrupt assignments	2-21

Contents

- 2.5.4. PCI Express x1 MIO slot..... 2-21
- 2.5.5. PCI Express 2.0 x16 slots (red) 2-21
- 2.5.6. Universal PCI Express x16 slot (white)..... 2-21
- 2.5.7. PCI/PCI-X slots 2-22
- 2.6 Jumpers 2-23**
- 2.7 Switches..... 2-25**
- 2.8 Audio card installation 2-26**
- 2.9 Connectors 2-27**
 - 2.9.1 Rear panel connectors..... 2-27
 - 2.9.2 Internal connectors 2-29
- 2.10 G.P. Diagnosis card installation..... 2-40**
 - 2.10.1 G.P. Diagnosis card layout..... 2-40
 - 2.10.2 Installing G.P. Diagnosis card 2-40
 - 2.10.3 G.P. Diagnosis card check codes..... 2-41

- Chapter 3: Powering up**
 - 3.1 Starting up for the first time..... 3-1**
 - 3.2 Turning off the computer..... 3-2**
 - 3.2.1 Using the OS shut down function..... 3-2
 - 3.2.2 Using the dual function power switch..... 3-2

- Chapter 4: BIOS setup**
 - 4.1 Managing and updating your BIOS 4-1**
 - 4.1.1 ASUS Update utility 4-1
 - 4.1.2 Creating a bootable floppy disk..... 4-4
 - 4.1.3 ASUS EZ Flash 2 utility..... 4-5
 - 4.1.4 AFUDOS utility..... 4-6
 - 4.1.5 ASUS CrashFree BIOS 3 utility 4-8
 - 4.2 BIOS setup program 4-9**
 - 4.2.1 BIOS menu screen..... 4-10
 - 4.2.2 Menu bar..... 4-10
 - 4.2.3 Navigation keys..... 4-10
 - 4.2.4 Menu items 4-11
 - 4.2.5 Sub-menu items..... 4-11
 - 4.2.6 Configuration fields 4-11
 - 4.2.7 Pop-up window 4-11

Contents

4.2.8	Scroll bar	4-11
4.2.9	General help	4-11
4.3	Main menu	4-12
4.3.1	System Date	4-12
4.3.2	System Time	4-12
4.3.3	Legacy Diskette A	4-12
4.3.4	Language	4-12
4.3.5	Primary / Secondary / Third IDE Master / Slave	4-13
4.3.6	Storage Configuration	4-14
4.3.7	System Information	4-16
4.4	Advanced menu	4-17
4.4.1	Jumpless Configuration	4-17
4.4.2	Ai Net 2	4-18
4.4.3	CPU Configuration	4-18
4.4.4	Onboard Devices Configuration	4-20
4.4.5	PCIPnP	4-22
4.4.6	USB Configuration	4-23
4.4.7	Trusted Computing.....	4-24
4.5	Power menu.....	4-25
4.5.1	Suspend Mode.....	4-25
4.5.2	Repost Video on S3 Resume.....	4-25
4.5.3	ACPI 2.0 Support	4-25
4.5.4	ACPI APIC Support.....	4-25
4.5.5	APM Configuration.....	4-26
4.5.6	Hardware Monitor	4-27
4.5.7	PSMI IPMI FRU	4-28
4.6	Boot menu	4-29
4.6.1	Boot Device Priority	4-29
4.6.2	Boot Settings Configuration	4-30
4.6.3	Security	4-31
4.7	Tools menu	4-33
4.7.1	ASUS EZ Flash 2.....	4-33
4.7.2	ASUS O.C. Profile.....	4-34
4.8	Exit menu.....	4-35

Contents

Chapter 5: Software support

5.1	Installing an operating system	5-1
5.2	Support DVD information	5-1
5.2.1	Running the support DVD	5-1
5.2.2	Drivers menu.....	5-2
5.2.3	Utilities menu	5-3
5.2.4	Make Disk menu	5-5
5.2.5	Manual menu	5-6
5.2.6	ASUS Contact information	5-6
5.2.7	Other information	5-7
5.3	Software information	5-9
5.3.1	ASUS MyLogo2™	5-9
5.3.2	AI NET2	5-11
5.3.3	ASUS PC Probe II.....	5-12
5.3.4	ASUS AI Nap	5-18
5.3.5	Audio configurations	5-19
5.4	RAID configurations	5-23
5.4.1	RAID definitions	5-23
5.4.2	Installing Serial ATA hard disks	5-24
5.4.3	Intel® RAID configurations.....	5-24
5.4.4	JMicron® RAID Configuration	5-33
5.5	Creating a RAID driver disk.....	5-41
5.5.1	Creating a RAID driver disk without entering the OS....	5-41
5.5.2	Creating a RAID/SATA driver disk in Windows®	5-41

Appendix: CPU features

A.1	Intel® EM64T.....	A-1
	Using the Intel® EM64T feature.....	A-1
A.2	Enhanced Intel SpeedStep® Technology (EIST).....	A-1
A.2.1	System requirements.....	A-1
A.2.2	Using the EIST.....	A-2

Notices

Federal Communications Commission Statement

This device complies with Part 15 of the FCC Rules. Operation is subject to the following two conditions:

- This device may not cause harmful interference, and
- This device must accept any interference received including interference that may cause undesired operation.

This equipment has been tested and found to comply with the limits for a Class B digital device, pursuant to Part 15 of the FCC Rules. These limits are designed to provide reasonable protection against harmful interference in a residential installation. This equipment generates, uses and can radiate radio frequency energy and, if not installed and used in accordance with manufacturer's instructions, may cause harmful interference to radio communications. However, there is no guarantee that interference will not occur in a particular installation. If this equipment does cause harmful interference to radio or television reception, which can be determined by turning the equipment off and on, the user is encouraged to try to correct the interference by one or more of the following measures:

- Reorient or relocate the receiving antenna.
- Increase the separation between the equipment and receiver.
- Connect the equipment to an outlet on a circuit different from that to which the receiver is connected.
- Consult the dealer or an experienced radio/TV technician for help.



The use of shielded cables for connection of the monitor to the graphics card is required to assure compliance with FCC regulations. Changes or modifications to this unit not expressly approved by the party responsible for compliance could void the user's authority to operate this equipment.

Canadian Department of Communications Statement

This digital apparatus does not exceed the Class B limits for radio noise emissions from digital apparatus set out in the Radio Interference Regulations of the Canadian Department of Communications.

This class B digital apparatus complies with Canadian ICES-003.

Safety information

Electrical safety

- To prevent electrical shock hazard, disconnect the power cable from the electrical outlet before relocating the system.
- When adding or removing devices to or from the system, ensure that the power cables for the devices are unplugged before the signal cables are connected. If possible, disconnect all power cables from the existing system before you add a device.
- Before connecting or removing signal cables from the motherboard, ensure that all power cables are unplugged.
- Seek professional assistance before using an adapter or extension cord. These devices could interrupt the grounding circuit.
- Make sure that your power supply is set to the correct voltage in your area. If you are not sure about the voltage of the electrical outlet you are using, contact your local power company.
- If the power supply is broken, do not try to fix it by yourself. Contact a qualified service technician or your retailer.

Operation safety

- Before installing the motherboard and adding devices on it, carefully read all the manuals that came with the package.
- Before using the product, make sure all cables are correctly connected and the power cables are not damaged. If you detect any damage, contact your dealer immediately.
- To avoid short circuits, keep paper clips, screws, and staples away from connectors, slots, sockets and circuitry.
- Avoid dust, humidity, and temperature extremes. Do not place the product in any area where it may become wet.
- Place the product on a stable surface.
- If you encounter technical problems with the product, contact a qualified service technician or your retailer.



This symbol of the crossed out wheeled bin indicates that the product (electrical, electronic equipment and mercury-containing button cell battery) should not be placed in municipal waste. Check local regulations for disposal of electronic products.

About this guide

This user guide contains the information you need when installing and configuring the motherboard.

How this guide is organized

This user guide contains the following parts:

- **Chapter 1: Product introduction**
This chapter describes the features of the motherboard and the new technologies it supports.
- **Chapter 2: Hardware information**
This chapter lists the hardware setup procedures that you have to perform when installing system components. It includes description of the switches, jumpers, and connectors on the motherboard.
- **Chapter 3: Powering up**
This chapter describes the power up sequence and ways of shutting down the system.
- **Chapter 4: BIOS setup**
This chapter tells how to change system settings through the BIOS Setup menus. Detailed descriptions of the BIOS parameters are also provided.
- **Chapter 5: Software support**
This chapter provides instructions for setting up, creating, and configuring RAID sets using the available utilities.
- **Appendix: Reference information**
This appendix includes additional information that you may refer to when configuring the motherboard.

Where to find more information

Refer to the following sources for additional information and for product and software updates.

1. **ASUS websites**
The ASUS website provides updated information on ASUS hardware and software products. Refer to the ASUS contact information.
2. **Optional documentation**
Your product package may include optional documentation, such as warranty flyers, that may have been added by your dealer. These documents are not part of the standard package.

Conventions used in this guide

To make sure that you perform certain tasks properly, take note of the following symbols used throughout this manual.



DANGER/WARNING: Information to prevent injury to yourself when trying to complete a task.



CAUTION: Information to prevent damage to the components when trying to complete a task.



IMPORTANT: Instructions that you **MUST** follow to complete a task.



NOTE: Tips and additional information to help you complete a task.

Typography

Bold text

Indicates a menu or an item to select.

Italics

Used to emphasize a word or a phrase.

<Key>

Keys enclosed in the less-than and greater-than sign means that you must press the enclosed key.

Example: <Enter> means that you must press the Enter or Return key.

<Key1>+<Key2>+<Key3>

If you must press two or more keys simultaneously, the key names are connected with a plus sign (+).

Example: <Ctrl>+<Alt>+<D>

Command

Means that you must type the command exactly as shown.

Example: At the DOS prompt, type the command line:

```
afudos /iz7SWS.ROM
```

Z7S WS specifications summary

CPU	Dual LGA771 sockets for Dual-Core Intel® Xeon™ processors 5100/5200 sequences and Quad-Core Intel® Xeon™ processor 5300/5400 sequence Supports Intel® Extended Memory 64Technology (EM64T), EIST, VT, XD, and TM/TM2
Chipset	MCH: Intel® Seaburg ICH: Intel® ESB2E
System Bus	1600 / 1333 / 1066 MHz
Memory	Quad-channel memory architecture 6 x 240-pin FB-DIMM sockets support registered ECC fully buffered DDR2 800 / 667 / 533 memory modules with Advanced Memory Buffer (AMB chip) Supports 512 MB up to 24 GB system memory Supports memory sparing technology.
Expansion Slots	1 x PCI Express™ x1 MIO slot 2 x PCI Express™ 2.0 x16 slots (x16 link) 1 x PCI-X 133/100 MHz/64bit/3.3V slot 1 x PCI 33 MHz/32-bit/5V slot 1 x Universal PCI Express™ x16 slot (x8 link)
Storage	Intel® ESB2E ICH <ul style="list-style-type: none"> - 1 x Ultra DMA 100/66/33 devices - 6 x SATA II (3.0 Gb/s) - Intel® Matrix Storage with RAID 0, 1, and 5 (S/W) configuration JMicron® JMB363 SATA controller <ul style="list-style-type: none"> - 2 x External SATA 3 Gb/s ports (SATA On-the-Go) - Supports SATA RAID 0, 1, and JBOD configuration
LAN	2 x Marvell® 88E8056 Gigabit LAN controllers <ul style="list-style-type: none"> - Supports teaming function
High Definition audio	Realtek® 888S 8-channel High-Definition Audio CODEC <ul style="list-style-type: none"> - Supports Jack-Sensing, Multi-streaming, and Jack-Retasking Technology - Coaxial / Optical S/PDIF out ports at back I/O - ASUS Noise Filter
IEEE 1394	VIA 6308S controller supports 2 x IEEE 1394a ports (one at midboard; one at back panel)
USB	Supports up to 8 USB 2.0 / 1.1 ports (3 at mid-board, 5 at back panel)

(continued on the next page)

Z7S WS specifications summary

AI Lifestyle Unique Features	<p>ASUS Workstation Features:</p> <ul style="list-style-type: none"> - G.P. Diagnosis card - ASUS SASsaby cards support (optional) <p>ASUS Quiet Thermal Solution:</p> <ul style="list-style-type: none"> - ASUS Fanless Design - ASUS Q-Fan 2 <p>ASUS EZ DIY:</p> <ul style="list-style-type: none"> - ASUS Q-Connector - ASUS O.C. Profile - ASUS CrashFree BIOS 3 - ASUS EZ Flash 2
BIOS features	AMI BIOS, 8 Mb FWH, Green, PnP, DMI2.0a, ACPI 2.0a, SMBIOS 2.3, WfM2.0
Rear panel	<p>1 x PS/2 keyboard port (purple)</p> <p>2 x External Serial ATA port</p> <p>5 x USB 2.0 ports</p> <p>1 x IEEE 1394a</p> <p>2 x LAN (RJ-45) ports</p>
Internal connectors	<p>1 x Floppy disk drive connector</p> <p>1 x IDE connector</p> <p>6 x Serial ATA connectors</p> <p>1 x Hard disk activity LED connector</p> <p>1 x USB header supports two additional USB ports</p> <p>1 x USB connector</p> <p>1 x Serial port connector (10-1 pin COM2)</p> <p>1 x Power supply SMBus connector</p> <p>1 x 24-pin ATX power connector</p> <p>1 x 8-pin ATX +12 V power connector</p> <p>1 x 4-pin +12V power connector</p> <p>1 x System panel connector (20-pin PANEL1)</p> <p>2 x CPU fan connector with PWM control</p> <p>4 x Chassis fan connectors with Q-fan 2 control</p> <p>1 x FB DIMM fan connector</p> <p>1 x Power fan connector</p> <p>1 x IEEE1394a connector</p> <p>1 x COM connector</p> <p>1 x TPM connector</p> <p>1 x Chassis intrusion connector</p>
Power requirement	SSI power supply (with 24-pin/8-pin/4-pin 12V plugs) for LGA771-socket Intel® Xeon processors

(continued on the next page)

Z7S WS specifications summary

Support DVD contents	Drivers ASUS PC Probe II ASUS Update Utility ASUS AI Suite Anti-virus software Adobe Acrobat Reader ASUS Flash Utility under DOS
Manageability	WOL by PME, WOR by PME, PXE, AI NET 2, Chassis Intrusion, BIOS flash utility under DOS
Other Features	ASUS AI Booster utility ASUS MyLogo 2 ASUS C.P.R. (CPU Parameter Recall) Multi-language BIOS
Form factor	CEB form factor: 12 in x 10.5 in (30.5 cm x 26.67 cm)

*Specifications are subject to change without notice.

This chapter describes the motherboard features and the new technologies it supports.

1 Product introduction

Chapter summary

1

1.1	Welcome!	1-1
1.2	Package contents.....	1-1
1.3	Special features.....	1-2

1.1 Welcome!

Thank you for buying an ASUS® Z7S WS series motherboard!

The motherboard delivers a host of new features and latest technologies, making it another standout in the long line of ASUS quality motherboards!

Before you start installing the motherboard, and hardware devices on it, check the items in your package with the list below.

1.2 Package contents

Check your motherboard package for the following items.

Motherboard	ASUS Z7S WS
I/O modules	1 x 2-port USB module 1 x 1-port IEEE 1394a module 1 x COM port module
Cables	Serial ATA signal cable for 6 devices Serial ATA power cable for 6 devices 1 x Ultra DMA 100/66/33 cable 1 x Floppy disk drive cable
Accessories	I/O shield 1 x ASUS Q-Connector Kit (USB, 1394, system panel; Retail version only) 2 x CPU Fan Plate G.P. Diagnosis Card (Retail version only) MIO Audio Card (Retail version only)
Application DVD	ASUS motherboard support DVD
Documentation	User guide



If any of the above items is damaged or missing, contact your retailer.

1.3 Special features

1.3.1 Product highlights

Latest processor technology

The motherboard comes with two LGA-771 sockets that support Dual-Core and Quad-Core Intel® Xeon™ processors with 1600/1333/1066 MHz Front Side Bus (FSB). Dual-core processors contain two physical CPU cores to meet demands for more powerful processing. Intel® Xeon™ processors incorporate the Intel® Extended Memory 64-bit Technology, enabling the support for 64-bit operation system, such as 64-bit Windows® and Linux. See page 2-9 for details.

Intel® Seaburg and Intel® ESB2E chipset

The Intel® Seaburg Memory Controller Hub (MCH) and the Intel® ESB2E provide the vital interfaces for the motherboard. The MCH provides two channels for processor, quad-channel FB-DIMM memory support, and two PCI Express 2.0 interfaces. The Intel® ESB2E is a new generation server class I/O controller hub that provides the interface for PCI 2.3, PCI Express, and PCIX.

Intel® EM64T

The motherboard supports Intel processors with the Intel® EM64T (Extended Memory 64 Technology). The Intel® EM64T feature allows your computer to run on 64-bit operating systems and access larger amounts of system memory for faster and more efficient computing.

Enhanced Intel SpeedStep® Technology (EIST)

The Enhanced Intel SpeedStep® Technology (EIST) intelligently manages the CPU resources by automatically adjusting the CPU voltage and core frequency depending on the CPU loading and system speed or power requirement.

FB-DIMM memory support

This motherboard supports fully buffered DIMMs (FB-DIMMs), the latest memory solution that extends memory capacity and provide high-speed, high-density system memory performance. FB-DIMMs use Advanced Memory Buffer (AMB) chips that transmit signals between the memory modules and controllers with improved signal integrity and reduced errors. See page 2-14 for details.

PCIe 2.0

This motherboard supports the latest PCIe 2.0 device for twice the current speed and bandwidth. This enhances system performance while still providing backward compatibility to PCIe 1.0 devices. See page 2-21 for details.

Dual Gigabit LAN solution



The integrated dual Gigabit LAN design allows a PC to serve as a network gateway for managing traffic between two separate networks. This capability ensures rapid transfer of data from WAN to LAN without any added arbitration or latency. See page 2-27 for details.

Serial ATA 3.0 Gb/s technology and SATA-On-The-Go



This motherboard supports the next-generation hard drives based on the Serial ATA (SATA) 3Gb/s storage specification, delivering enhanced scalability and doubling the bus bandwidth for high-speed data retrieval and saves. The external SATA port located at the back I/O provides smart setup and hot-plug functions. Easily backup photos, videos and other entertainment contents to external devices. See pages 2-27 and 2-31 for details.

IEEE 1394a support



The IEEE 1394a interface provides high speed digital interface for audio/video appliances such as digital television, digital video camcorders, storage peripherals & other PC portable devices. See page 2-27 for details.

G.P. Diagnosis card



Bundled with Z7S WS motherboard (retail version), the G.P. Diagnosis card assists users in system checking by effortlessly and quickly providing precise system checks right after they switch on their PCs. See page 2-40 for details.

ASUS SASsaby cards support



This motherboard is fully compatible with ASUS SASsaby cards (optional). Faster, safer and more stable, SAS will provide users with a better choice for storage expansion and upgrade needs. See page 2-22 for details.

S/PDIF digital sound ready



This motherboard provides convenient connectivity to external home theater audio systems via coaxial and optical S/PDIF-out (SONY-PHILIPS Digital Interface) jacks. It allows to transfer digital audio without converting to analog format and keeps the best signal quality. See page 2-28 for details.

Temperature, fan, and voltage monitoring

The CPU temperature is monitored by the ASIC WINBOND C.S W83793G chip to prevent overheating and damage. The system fan rotations per minute (RPM) is monitored for timely failure detection. The chip monitors the voltage levels to ensure stable supply of current for critical components. See page 4-28 for details.

1.3.2 Innovative ASUS features

CrashFree BIOS 3



This feature allows you to restore the original BIOS data from the support CD in case when the BIOS codes and data are corrupted. This protection eliminates the need to buy a replacement ROM chip. See page 4-8 for details.

ASUS MemCool FB-DIMM Fan Kit (optional)

With this optional fan kit, the platform gets optimal performance and the best possible FB-DIMM thermal environment. See page 2-18 for details.

This chapter lists the hardware setup procedures that you have to perform when installing system components. It includes description of the jumpers and connectors on the motherboard.

Hardware information



2.1	Before you proceed	2-1
2.2	Motherboard overview.....	2-2
2.3	Central Processing Unit (CPU)	2-9
2.4	System memory	2-14
2.5	Expansion slots.....	2-20
2.6	Jumpers	2-23
2.7	Switches.....	2-25
2.8	Audio card installation	2-26
2.9	Connectors	2-27
2.10	G.P. Diagnosis card installation.....	2-40

2.1 Before you proceed

Take note of the following precautions before you install motherboard components or change any motherboard settings.



- Unplug the power cord from the wall socket before touching any component.
- Use a grounded wrist strap or touch a safely grounded object or a metal object, such as the power supply case, before handling components to avoid damaging them due to static electricity.
- Hold components by the edges to avoid touching the ICs on them.
- Whenever you uninstall any component, place it on a grounded antistatic pad or in the bag that came with the component.
- Before you install or remove any component, ensure that the power supply is switched off or the power cord is detached from the power supply. Failure to do so may cause severe damage to the motherboard, peripherals, and/or components.

Onboard LED

The motherboard comes with a standby power LED. The green LED lights up to indicate that the system is ON, in sleep mode, or in soft-off mode. This is a reminder that you should shut down the system and unplug the power cable before removing or plugging in any motherboard component. The illustration below shows the location of the onboard LED

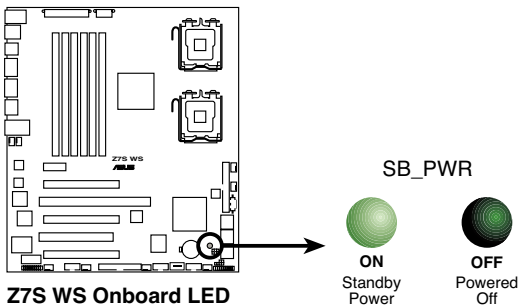

2.2 Motherboard overview

Before you install the motherboard, study the configuration of your chassis to ensure that the motherboard fits into it.

To optimize the motherboard features, we highly recommend that you install it in an SSI CEB 1.1 compliant chassis.



Make sure to unplug the chassis power cord before installing or removing the motherboard. Failure to do so can cause you physical injury and damage motherboard components!

2.2.1 Placement direction

When installing the motherboard, make sure that you place it into the chassis in the correct orientation. The edge with external ports goes to the rear part of the chassis as indicated in the image below.

2.2.2 Screw holes

Place eight (8) screws into the holes indicated by circles to secure the motherboard to the chassis.



DO NOT overtighten the screws! Doing so can damage the motherboard.

Place this side towards the rear of the chassis

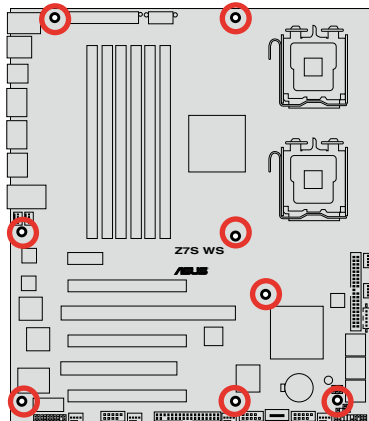

2.2.3 Support kits for the motherboard

For additional protection from motherboard breakage due to the weight of the CPU heatsinks, your motherboard package comes with CEK springs that you can use as weight support. Install the CEK springs before installing the motherboard.



If your chassis is SSI CEB 1.1 compliant, we recommend that you use the CEK springs; otherwise, use the support plates kit.

Each CEK spring has four hooks to match the designated holes around the CPU area.

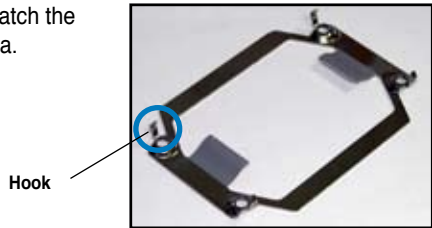

To install the CEK spring:

1. Locate the CPU heatsink holes on the motherboard.

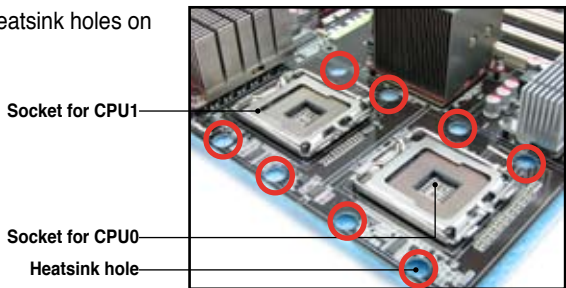

2. Position the CEK spring underneath the motherboard, then match the CEK spring hooks to the CPU0 heatsink holes.

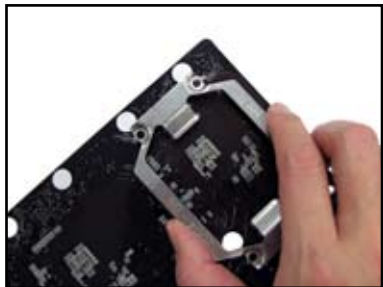

3. Press the upper spring hooks inward, then insert to the upper CPU heatsink holes until they snap in place.

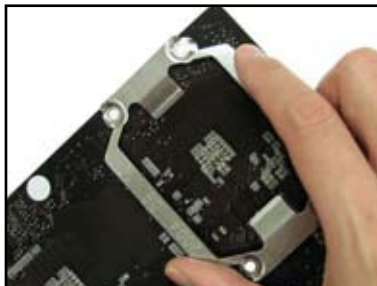

4. Press the lower spring clips inward, then insert to the lower CPU heatsink holes until they snap in place.



5. If you installed a second CPU, repeat steps 2 to 4 to install the CEK spring to the CPU1 heatsink holes. The CEK springs appear as shown when installed.

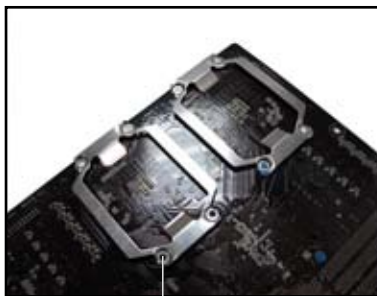

CEK spring screw hole

6. Before installing the motherboard into the chassis, locate the standoffs that should match the eight (8) CEK spring screw holes.

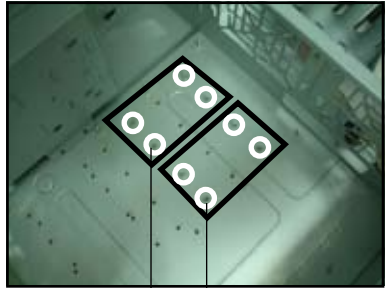

Standoffs for CPU0

Standoffs for CPU1

7. Install the motherboard with the external I/O ports toward the chassis rear panel. The CPU sockets should be right on top of their respective standoffs.

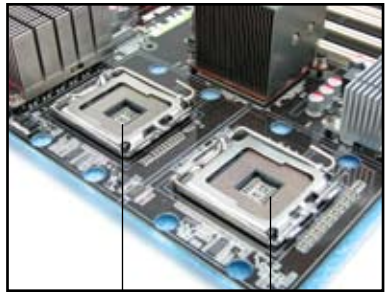

Socket for CPU1 Socket for CPU0



Make sure that the standoffs perfectly match the CEK spring screw holes; otherwise, you can not install the CPU heatsinks properly.

8. Secure the motherboard with eight (8) screws. Refer to section **2.2.2 Screw holes** for illustration.

2.2.4 Motherboard layout

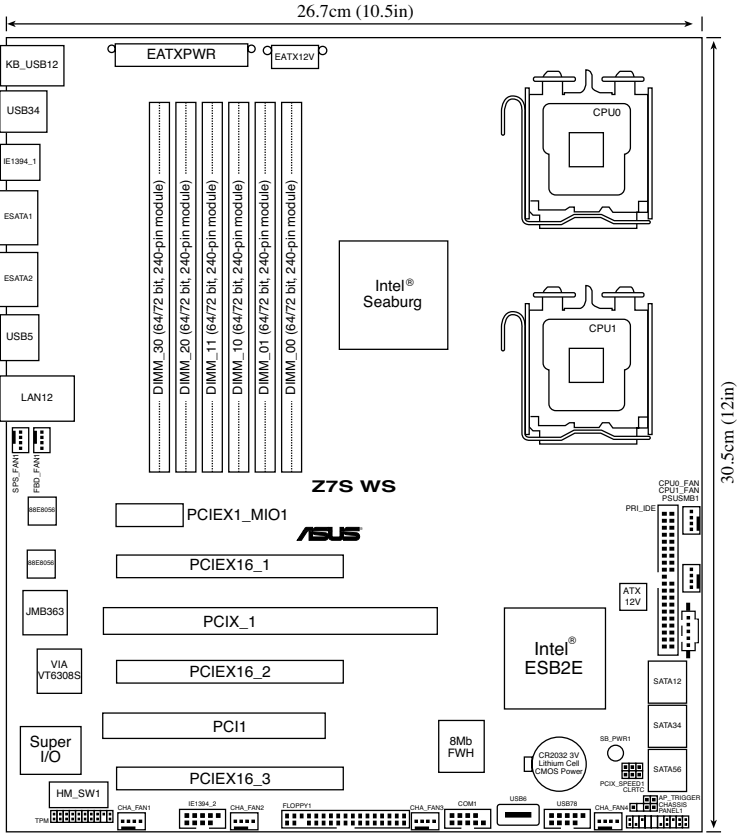

2.2.5 Audio card layout

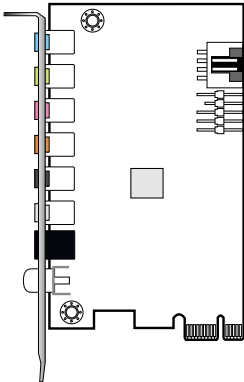

2.2.6 Layout contents

Slots/Socket		Page
1.	CPU sockets	2-9
2.	FB-DIMM sockets	2-14
3.	PCI Express x1 MIO slot	2-21
4.	PCI Express 2.0 x16 slots (red)	2-21
5.	Universal PCI Express x16 slot (white)	2-21
6.	PCI/PCI-X slots	2-22

Jumpers		Page
1.	Clear RTC RAM (CLRRTC1)	2-23
2.	PCI-X speed setting (3-pin PCIX_SPEED1)	2-24

Switches		Page
Fan Switches		2-25

Rear panel connectors		Page
1.	PS/2 keyboard port (purple)	2-27
2.	USB 2.0 ports 1 and 2	2-27
3.	USB 2.0 ports 3 and 4	2-27
4.	IEEE 1394a port	2-27
5.	External SATA port 1	2-27
6.	External SATA port 2	2-27
7.	USB 2.0 port 5	2-27
8.	LAN (RJ-45) ports 1 and 2	2-27
9.	Line In Port (light blue)	2-28
10.	Line Out port (lime)	2-28
11.	Microphone port (pink)	2-28
12.	Center/Subwoofer port (orange)	2-28
13.	Rear Speaker Out port (black)	2-28
14.	Side Speaker Out port (gray)	2-28
15.	Optical S/PDIF Out port	2-28
16.	Coaxial S/PDIF Out port	2-28

Internal connectors		Page
1.	Floppy disk drive connector (34-1 pin FLOPPY1)	2-29
2.	IDE connector (40-1 pin PRI_IDE1)	2-30
3.	Serial ATA connectors (7-pin SATA1-6)	2-31
4.	USB connectors (4-pin USB6, 10-1 pin USB78)	2-32
5.	Serial port connectors (10-1 pin COM1)	2-33
6.	CPU and system fan connectors (4-pin SPS_FAN1, FBD_FAN1, CPU0_FAN, CPU1_FAN, CHA_FAN1-4)	2-33
7.	Power supply SMBus connector (5-pin PSUSMB1)	2-34
8.	Chassis intrusion connector (4-1 pin CHASSIS)	2-34
9.	SSI power connectors (24-pin EATXPWR, 8-pin EAX12V, 4-pin ATX12V)	2-35
10.	TPM connector (20-1 pin TPM) [Optional]	2-36
11.	System panel connector (20-1 pin PANEL)	2-37
12.	Front panel audio connector (10-1 pin AAFP)	2-38
13.	Optical drive audio connector (4-pin CD)	2-38
14.	Q-Connector (system panel)	2-39

2.3 Central Processing Unit (CPU)

The motherboard comes with a surface mount LGA771 socket designed for the Intel® Xeon® Quad/Dual Core processor.



- Your boxed Intel® Xeon® LGA771 processor package should come with installation instructions for the CPU and heatsink. If the instructions in this section do not match the CPU documentation, follow the latter.
- Upon purchase of the motherboard, make sure that the PnP cap is on the socket and the socket contacts are not bent. Contact your retailer immediately if the PnP cap is missing, or if you see any damage to the PnP cap/socket contacts/motherboard components. ASUS will shoulder the cost of repair only if the damage is shipment/transit-related.
- Keep the cap after installing the motherboard. ASUS will process Return Merchandise Authorization (RMA) requests only if the motherboard comes with the cap on the LGA771 socket.
- The product warranty does not cover damage to the socket contacts resulting from incorrect CPU installation/removal, or misplacement/loss/incorrect removal of the PnP cap.

2.3.1 Installing the CPU

To install a CPU:

1. Locate the CPU socket on the motherboard.

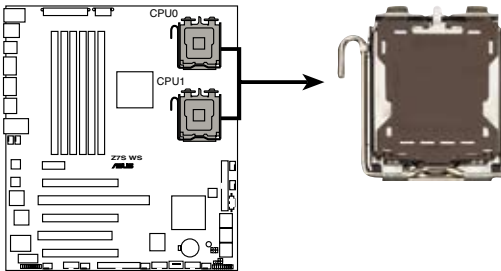

Z7S WS CPU LGA771



Before installing the CPU, make sure that the socket box is facing towards you and the load lever is on your left.

- 2. Press the load lever with your thumb (A), then move it to the left (B) until it is released from the retention tab.

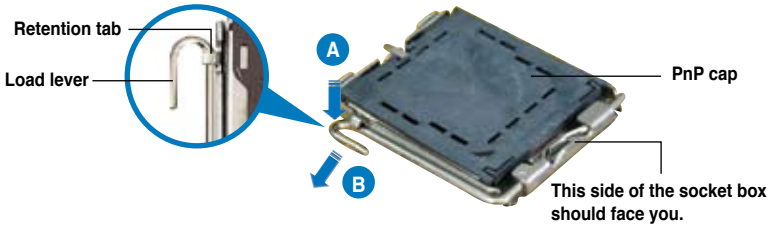

To prevent damage to the socket pins, do not remove the PnP cap unless you are installing a CPU.

- 3. Lift the load lever in the direction of the arrow to a 135° angle.

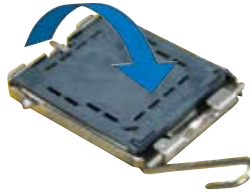

- 4. Lift the load plate with your thumb and forefinger to a 100° angle (A), then push the PnP cap from the load plate window to remove (B).

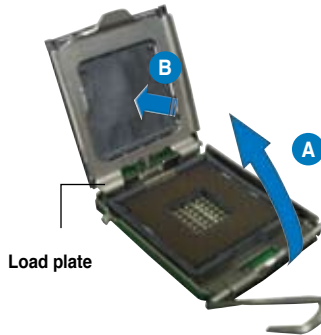

- 5. Position the CPU over the socket, making sure that the gold triangle is on the bottom-left corner of the socket. The socket alignment key should fit into the CPU notch.

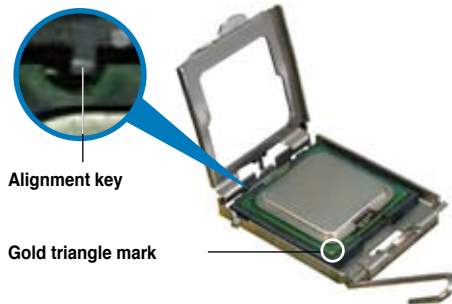

6. Close the load plate (A), then push the load lever (B) until it snaps into the retention tab.

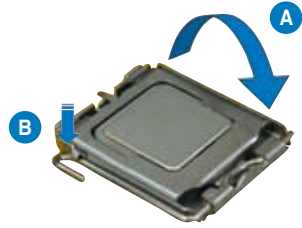

The CPU fits in only one correct orientation. **DO NOT** force the CPU into the socket to prevent bending the connectors on the socket and damaging the CPU!

2.3.2 Installing the CPU heatsink and fan

The Intel® Xeon™ processors require an Intel certified heatsink and fan assembly to ensure optimum thermal condition and performance.

When you buy a boxed Intel CPU, the package includes the heatsink, fan, retention brackets, screws, thermal grease, installation manual, and other items that are necessary for CPU installation.



- Make sure that you have applied the thermal grease to the top of the CPU before installing the heatsink and fan.
- Refer to the installation manual that came with the CPU package for details on heatsink/fan assembly and installation.

CPU heatsink (top view)



CPU heatsink (bottom view)

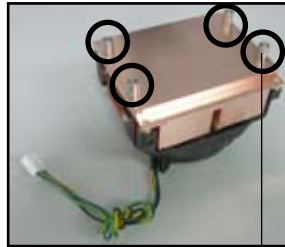

Heatsink screw

To install the CPU heatsink and fan:

1. Place the heatsink on top of the installed CPU, making sure that the four screws on the heatsink align with the nuts on the support plate.

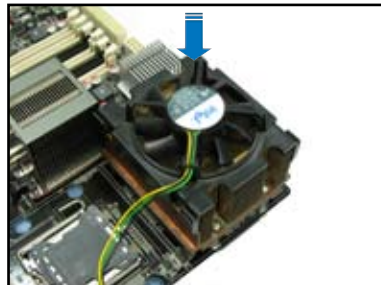

2. Use a Phillips screwdriver to tighten the four heatsink screws in a diagonal sequence.

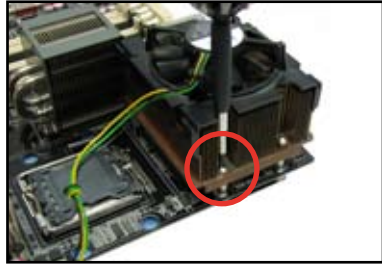

3. Connect the fan cable to the 4-pin connector labeled CPU0_FAN.

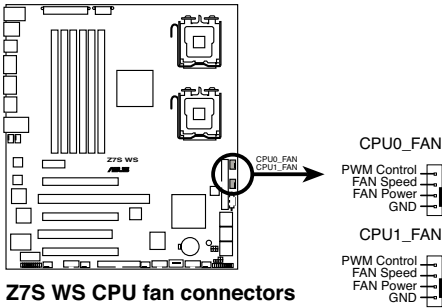

DO NOT forget to connect the CPU fan cable! Hardware monitoring errors may occur if you fail to plug this connector.

4. Repeat steps 1 to 3 to install the other heatsink if you have installed a second CPU, then connect the fan cable to the 4-pin connector labeled CPU1_FAN.

2.4 System memory

2.4.1 Overview

The motherboard comes with six fully-buffered DIMM (FB-DIMM) sockets to support 240-pin FB-DIMM modules. An FB-DIMM module has a different pin-out from DDR2 DIMMs so you cannot install DDR2 DIMMs on an FB-DIMM socket. Note that an FB-DIMM socket has an Advanced Memory Buffer (AMB) chip that allows memory-to-CPU connection at gigabit speed.

The figure illustrates the location of the FB-DIMM sockets:

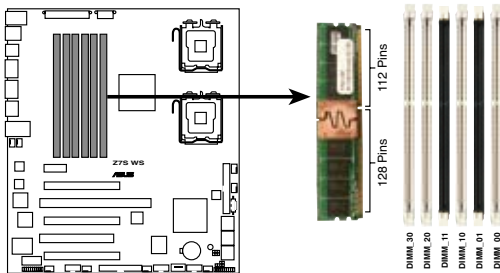

Z7S WS 240-pin DDR2 FB-DIMM sockets

2.4.2 Memory configurations

You may install 256 MB, 512 MB, 1 GB, 2 GB, and 4 GB registered ECC FB-DIMMs into the DIMM sockets.



- For optimum compatibility, we recommend that you obtain memory modules from the same vendor. Refer to the Qualified Vendors List on the ASUS web site.
- This motherboard does not support memory modules made up of 128 Mb chips or double-rank x16 memory modules.
- If you are installing only one memory module, install into the white socket labeled DIMM_00. Installing into any other socket will not work.

Rank population

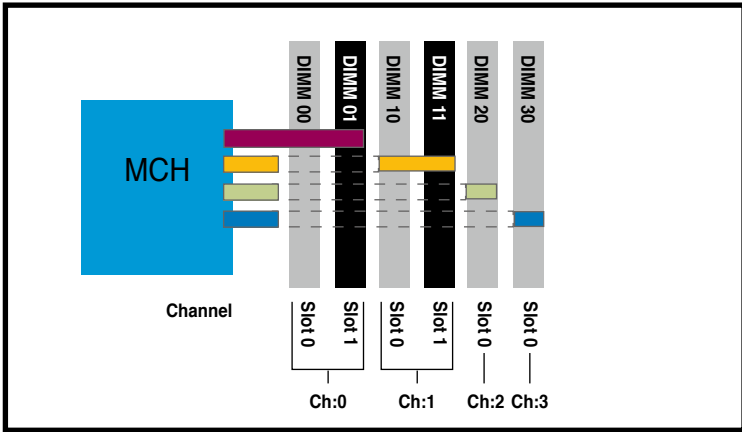

DIMM installation reference table

No. of DIMMs	Slot(s) to use
1	DIMM_00
2	DIMM_00 + DIMM_01, or DIMM_00 + DIMM_10
4	DIMM_00 + DIMM_10 + DIMM_20 + DIMM_30, or DIMM_00 + DIMM_01 + DIMM_10 + DIMM_11
6	DIMM_00 + DIMM_01 + DIMM_10 + DIMM_11 + DIMM_20 + DIMM_30



- DIMMs in pair means two DIMMs with the same configuration.
- For better performance, same configuration DIMMs should be installed on the same slot number for each channel. For example, you may install the same type of DIMMs in DIMM_00, DIMM_10, DIMM_20, and DIMM_30.

2.4.3 Memory sparing technology

The Intel® Seaburg chipset supports the memory sparing technology. Refer to the below sections:

Memory Sparing :

At configuration time, a DIMM rank is set aside to replace a defective DIMM rank. When the error rate for a failing DIMM rank reaches a pre-determined threshold, the memory sparing function will issue an interrupt and initiate a spare copy. At the completion of the copy, the failing DIMM rank is disabled and the “spared” DIMM rank will be used in its place.



-
- The DIMM rank with the largest size will be assigned as spare rank. Data can only be copied from a smaller sized rank to a larger sized one.
 - A DIMM can contain only one or two ranks. To support sparing function, a DIMM channel should contain at least two ranks.
 - When sparing function is enabled, the usable memory size will reduce then size of the spare ranks.
-

2.4.4 Installing a DIMM



Make sure to unplug the power supply before adding or removing DIMMs or other system components. Failure to do so may cause severe damage to both the motherboard and the components.

To install a DIMM:

1. Unlock a DIMM socket by pressing the retaining clips outward.
2. Align a DIMM on the socket such that the notch on the DIMM matches the break on the socket.
3. Firmly insert the DIMM into the socket until the retaining clips snap back in place and the DIMM is properly seated.

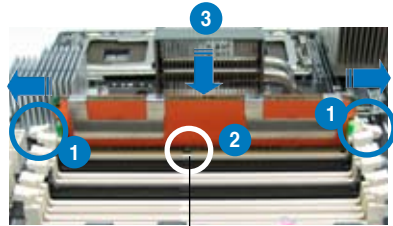

DDR2 FB-DIMM notch



- A FB-DIMM is keyed with a notch so that it fits in only one direction. Do not force a DIMM into a socket to avoid damaging the DIMM.
- The FB-DIMM sockets do not support DDR DIMMs. DO NOT install DDR DIMMs to the FB-DIMM sockets.

2.4.5 Removing a DIMM

To remove a DIMM:

1. Simultaneously press the retaining clips outward to unlock the DIMM.



Support the DIMM lightly with your fingers when pressing the retaining clips. The DIMM might get damaged when it flips out with extra force.

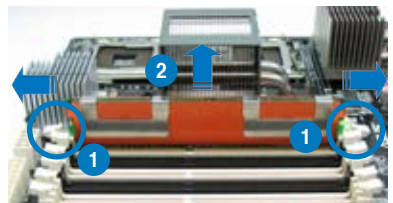

2. Remove the DIMM from the socket.

2.4.6 Installing the MemCool FB-DIMM fan (optional)

The FB-DIMMs generate heat during continued operation. To ensure optimum thermal condition and performance, install the optional MemCool FB-DIMM fan.

To install the optional FB-DIMM fan:

1. Locate the three FB-DIMM fan holes on the motherboard.

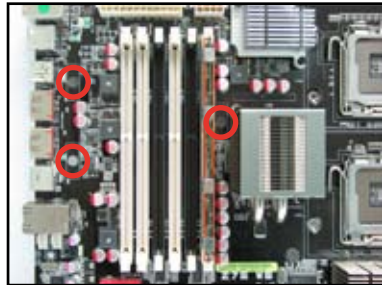

2. Disengage the fan top cover from the fan base. You can do this by firmly gripping the top cover by the clamps to release the hooks, then pull up the top cover carefully until it separates from the fan base.



DO NOT remove the fan from the fan base.

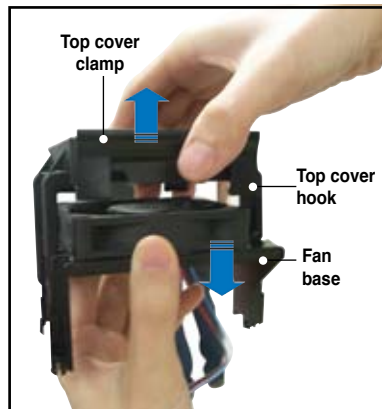

3. Position the fan base over the DIMMs, and insert the fan base legs into the FB-DIMM holes until the legs are securely in place.

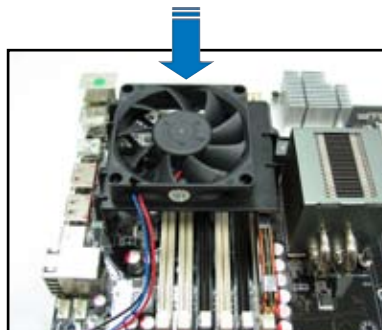

4. Position top cover over the fan base. Insert the top cover legs into the slot on the fan base legs. Push down carefully until the legs are securely in place and the top cover hooks snap in place.

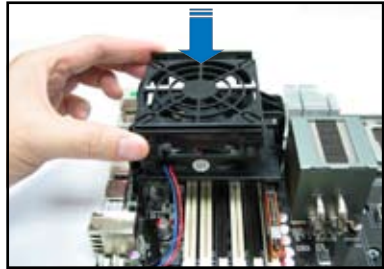

Make sure the cables pass through the notch on the fan base as shown.

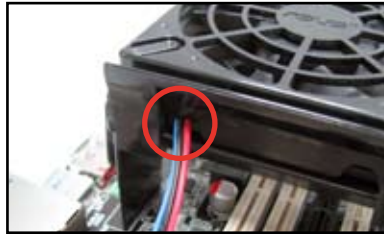

5. Connect the fan cable to the 4-pin connector labeled FBD_FAN1.

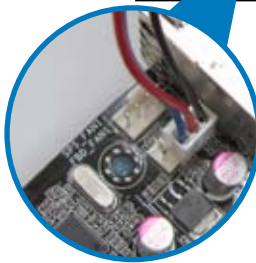
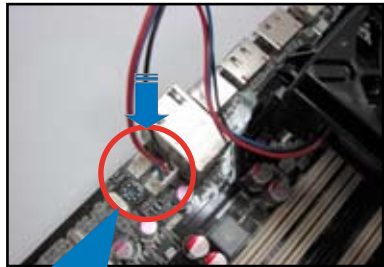

2.5 Expansion slots

In the future, you may need to install expansion cards. The following sub-sections describe the slots and the expansion cards that they support.



Make sure to unplug the power cord before adding or removing expansion cards. Failure to do so may cause you physical injury and damage motherboard components.

2.5.1 Installing an expansion card

To install an expansion card:

1. Before installing the expansion card, read the documentation that came with it and make the necessary hardware settings for the card.
2. Remove the system unit cover (if your motherboard is already installed in a chassis).
3. Remove the bracket opposite the slot that you intend to use. Keep the screw for later use.
4. Align the card connector with the slot and press firmly until the card is completely seated on the slot.
5. Secure the card to the chassis with the screw you removed earlier.
6. Replace the system cover.

2.5.2 Configuring an expansion card

After installing the expansion card, configure the it by adjusting the software settings.

1. Turn on the system and change the necessary BIOS settings, if any. See Chapter 4 for information on BIOS setup.
2. Assign an IRQ to the card. Refer to the tables on the next page.
3. Install the software drivers for the expansion card.



When using PCI cards on shared slots, ensure that the drivers support "Share IRQ" or that the cards do not need IRQ assignments. Otherwise, conflicts will arise between the two PCI groups, making the system unstable and the card inoperable.

2.5.3 Interrupt assignments

IRQ	Priority	Standard function
0	1	System timer
1	2	Keyboard controller
2	–	Re-direct to IRQ#9
3	11	IRQ holder for PCI steering*
4	12	Communications port (COM1)*
5	13	IRQ holder for PCI steering*
6	14	Floppy disk controller
7	15	IRQ holder for PCI steering*
8	3	System CMOS/Real Time Clock
9	4	IRQ holder for PCI steering*
10	5	IRQ holder for PCI steering*
11	6	IRQ holder for PCI steering*
12	7	PS/2 compatible mouse port*
13	8	Numeric data processor
14	9	IRQ holder for PCI steering*
15	10	IRQ holder for PCI steering*

* These IRQs are usually available for ISA or PCI devices.

2.5.4. PCI Express x1 MIO slot

This motherboard supports PCI Express x1 audio cards, network cards, SCSI cards and other cards that comply with the PCI Express specifications. This slot also supports the MIO (Media Input Output) function. Install the bundled audio card on this slot only, otherwise the audio card may not work properly. Refer to the figure on the next page for the location of the slot.

2.5.5 PCI Express 2.0 x16 slots (red)

This motherboard has two PCI Express 2.0 x16 slots that support PCI Express 2.0 x16 graphic cards complying with the PCI Express specifications. Refer to the figure on the next page for the location of the slots.

2.5.6 Universal PCI Express x16 slot (white)

This motherboard also supports one Universal PCI Express x16 slot with a maximum speed of x8 link. The operating frequency of this slot change depending on the type of PCI Express card you install. Refer to the figure on the next page for the location of the slot.

2.5.7 PCI/PCI-X slots

The PCI/PCI-X slots support cards such as a LAN card, SCSI card, USB card, and other cards that comply with PCI 2.3 and PCI-X 1.0 specifications. Refer to the figure below for the location of the slots.

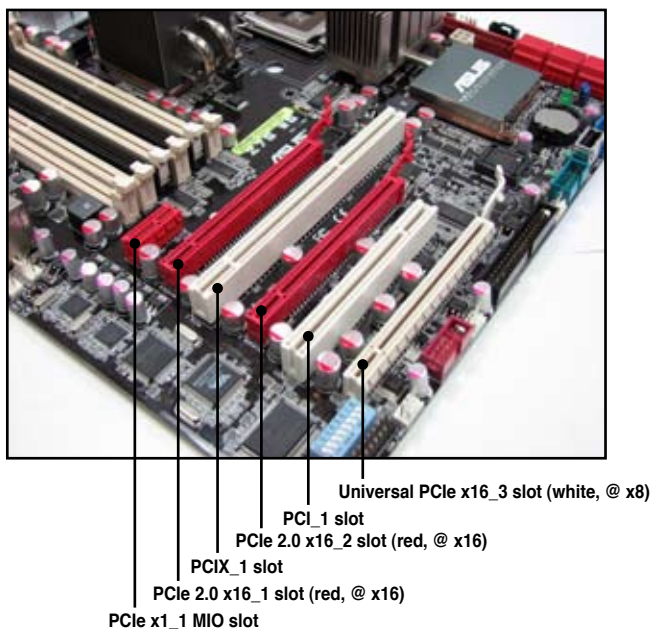

This motherboard supports the ASUS SASsaby cards (optional) for SAS Hard disk drive support. For SASsaby M, install the card to the two PCIe 2.0 x16 slots (red) or the universal PCIe x16 slot (white). For SASsaby 1064E, install the card to the universal PCIe x16 slot (white) only.

2.6 Jumpers

1. Clear RTC RAM (CLRRTC)

This jumper allows you to clear the Real Time Clock (RTC) RAM in CMOS. You can clear the CMOS memory of date, time, and system setup parameters by erasing the CMOS RTC RAM data. The onboard button cell battery powers the RAM data in CMOS, which include system setup information such as system passwords.

To erase the RTC RAM:

1. Turn OFF the computer and unplug the power cord.
2. Move the jumper cap from pins 1-2 (default) to pins 2-3. Keep the cap on pins 2-3 for about 5~10 seconds, then move the cap back to pins 1-2.
3. Plug the power cord and turn ON the computer.
4. Hold down the key during the boot process and enter BIOS setup to re-enter data.



Except when clearing the RTC RAM, never remove the cap on CLRRTC jumper default position. Removing the cap will cause system boot failure!



If the steps above do not help, remove the onboard battery and move the jumper again to clear the CMOS RTC RAM data. After the CMOS clearance, reinstall the battery.

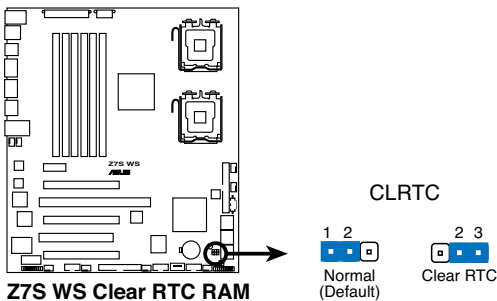

- You do not need to clear the RTC when the system hangs due to overclocking. For system failure due to overclocking, use the C.P.R. (CPU Parameter Recall) feature. Shut down and reboot the system so the BIOS can automatically reset parameter settings to default values.
- Due to the chipset limitation, AC power off is required prior using C.P.R. function. You must turn off and on the power supply or unplug and plug the power cord before reboot the system.

2. PCI-X Speed setting (3-pin PCIX_SPEED1)

This jumper allows you to set the PCI-X slot's maximum frequency capability.

The jumper cap on pins 1-2: 133 MHz capability for the PCI-X slot.

The jumper cap on pins 2-3: 100 MHz capability for the PCI-X slot.

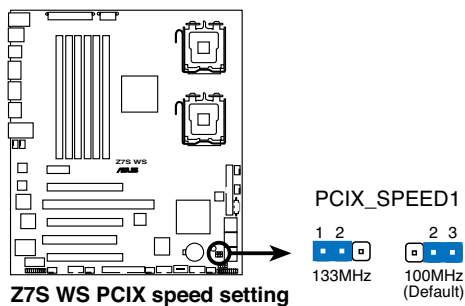

2.7 Switches

Fan switches (HM_SW1)

This switch allows you to set up the fan connections. Set the switch to ON if you are using a 4-pin fan (PWM fan) cable plug, or to OFF if you are using a 3-pin (PC fan) plug.

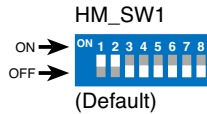
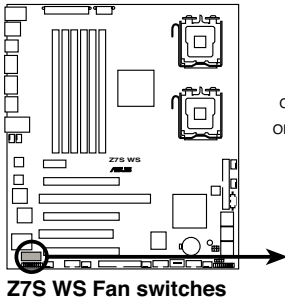

ON:4-PIN FAN
OFF:3-PIN FAN
SW1_CPU0_FAN
SW2_CPU1_FAN
SW3_CHA_FAN1
SW4_CHA_FAN2
SW5_CHA_FAN3
SW6_CHA_FAN4
SW7_SPS_FAN1
SW8_x



- If you use a 4-pin fan but set the Fan switch for a 3-pin fan, the fan you installed may not work.
- If you use a 3-pin fan but set the Fan switch for a 4-pin fan, the fan control will not work and the fan you installed will always run at full speed.

2.8 Audio card installation

1. Take out the Audio card from the package.



2. Locate the PCI Express x1 MIO slot on the motherboard.

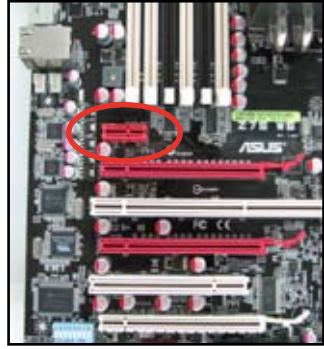

3. Align the card connector with the slot and press firmly until the card sits on the slot completely.

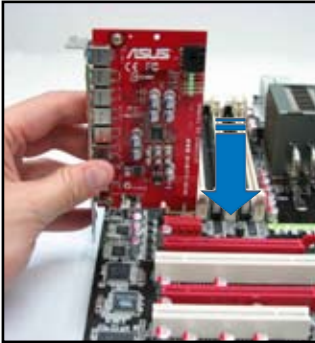

4. The photo below shows the audio card installed on the motherboard.



2.9 Connectors

2.9.1 Rear panel connectors

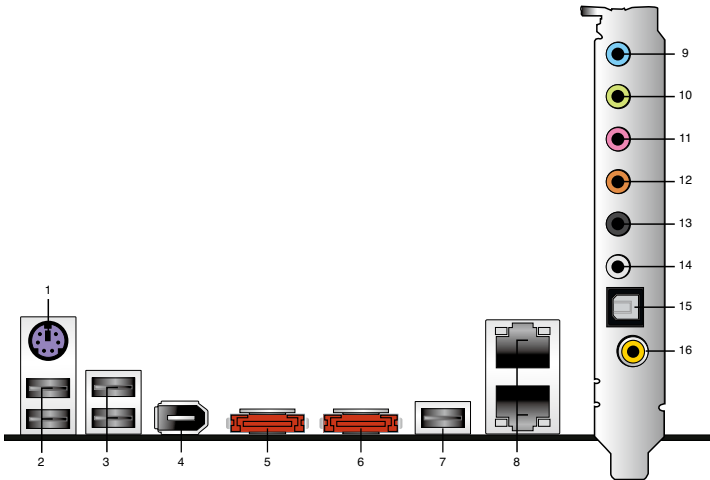

1. **PS/2 keyboard port (purple).** This port is for a PS/2 keyboard.
2. **USB 2.0 ports 1 and 2.** These two 4-pin Universal Serial Bus (USB) ports are available for connecting USB 2.0 devices.
3. **USB 2.0 ports 3 and 4.** These two 4-pin Universal Serial Bus (USB) ports are available for connecting USB 2.0 devices.
4. **IEEE1394a port.** This 6-pin IEEE 1394a port provides high-speed connectivity for audio/video devices, storage peripherals, PCs, or portable devices.
5. **External SATA port 1.** This port connects to an external Serial ATA hard disk drive. To configure a RAID 0, 1, or JBOD set, install two external Serial ATA hard disk drives to this port and to external SATA port 2.
6. **External SATA port 2.** This port connect to an external Serial ATA hard disk drive. To configure a RAID 0, 1, or JBOD set, install two external Serial ATA hard disk drives to this port and to external SATA port 1.
7. **USB 2.0 port 5.** This 4-pin Universal Serial Bus (USB) port is available for connecting USB 2.0 devices.
8. **LAN (RJ-45) port 1 and 2.** Supported by Marvell® Gigabit LAN controller, these ports allow Gigabit connection to a Local Area Network (LAN) through a network hub. Refer to the table on the next page for the LAN port LED indications.

LAN port LED indications

Activity/Link LED		Speed LED	
Status	Description	Status	Description
OFF	No link	OFF	10 Mbps connection
ORANGE	Linked	ORANGE	100 Mbps connection
BLINKING	Data activity	GREEN	1 Gbps connection

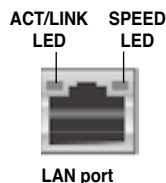

9. **Line In port (light blue).** This port connects the tape, CD, DVD player, or other audio sources.
10. **Line Out port (lime).** This port connects a headphone or a speaker. In 4-channel, 6-channel, and 8-channel configuration, the function of this port becomes Front Speaker Out.
11. **Microphone port (pink).** This port connects a microphone.
12. **Center/Subwoofer port (orange).** This port connects the center/subwoofer speakers.
13. **Rear Speaker Out port (black).** This port connects the rear speakers in a 4-channel, 6-channel, or 8-channel audio configuration.
14. **Side Speaker Out port (gray).** This port connects the side speakers in an 8-channel audio configuration.



Refer to the audio configuration table below for the function of the audio ports in 2, 4, 6, or 8-channel configuration.

Audio 2, 4, 6, or 8-channel configuration

Port	Headset 2-channel	4-channel	6-channel	8-channel
Light Blue	Line In	Line In	Line In	Line In
Lime	Line Out	Front Speaker Out	Front Speaker Out	Front Speaker Out
Pink	Mic In	Mic In	Mic In	Mic In
Orange	–	–	Center/Subwoofer	Center/Subwoofer
Black	–	Rear Speaker Out	Rear Speaker Ou	Rear Speaker Out
Gray	–	–	–	Side Speaker Out

15. **Optical S/PDIF Out port.** This port connects an external audio output device via an optical S/PDIF cable.
16. **Coaxial S/PDIF Out port.** This port connects an external audio output device via a coaxial S/PDIF cable.

2.9.2 Internal connectors

1. Floppy disk drive connector (34-1 pin FLOPPY1)

This connector is for the provided floppy disk drive (FDD) signal cable. Insert one end of the cable to this connector, then connect the other end to the signal connector at the back of the floppy disk drive.



Pin 5 on the connector is removed to prevent incorrect cable connection when using a FDD cable with a covered Pin 5.

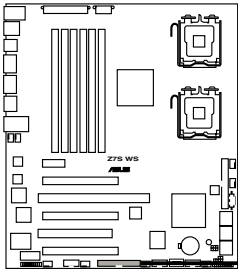

Z7S WS Floppy disk drive connector



NOTE: Orient the red markings on the floppy ribbon cable to PIN 1.

2. IDE connector (40-1 pin PRI_IDE)

The onboard IDE connector is for the Ultra DMA 100/66/33 signal cable. There are three connectors on each Ultra DMA 100/66/33 signal cable: blue, black, and gray. Connect the blue connector to the motherboard's IDE connector, then select one of the following modes to configure your device.

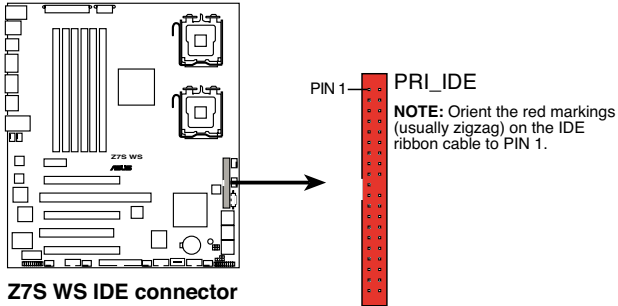

	Drive jumper setting	Mode of device(s)	Cable connector
Single device	Cable-Select or Master	-	Black
Two devices	Cable-Select	Master	Black
		Slave	Gray
	Master	Master	Black or gray
Slave	Slave		



- Pin 20 on the IDE connector is removed to match the covered hole on the Ultra DMA cable connector. This prevents incorrect insertion when you connect the IDE cable.
- Use the 80-conductor IDE cable for Ultra DMA 100/66/33 IDE devices.



If any device jumper is set as "Cable-Select," make sure all other device jumpers have the same setting.

3. Serial ATA connectors (7-pin SATA1-6)

These connectors are for the Serial ATA signal cables for Serial ATA hard disk drives.

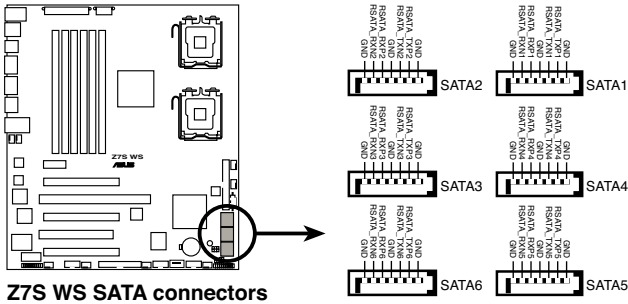

- SATA 5-6 connectors support AHCI mode and RAID mode only. Make sure to install the AHCI driver or RAID driver in the bundled support DVD before connecting devices to SATA 5-6 connectors. Otherwise, the devices will not work.
- When using the connectors in Standard IDE mode, connect the primary (boot) hard disk drive to the SATA1 connector. Refer to the table below for the recommended SATA hard disk drive connections.
- These connectors are set to Standard IDE mode by default. In Standard IDE mode, you can connect Serial ATA boot/data hard drives to these connectors. If you intend to create a Serial ATA RAID set using these connectors, set the **Configure SATA as** item in the BIOS to [RAID]. See section 4.3.6 Storage Configuration for details.
- Before creating a RAID set, refer to 5.4.3 Intel RAID configurations or the manual bundled in the motherboard support DVD.

Serial ATA hard disk drive connection

Connector	Color	Setting	Use
SATA 1	Red	Primary Master	Boot disk
SATA 2	Red	Secondary Master	Boot/Data disk
SATA 3	Red	Primary Slave	Data disk
SATA 4	Red	Secondary Slave	Data disk



Connect the right-angle side of SATA signal cable to SATA device. Or you may connect the right-angle side of SATA cable to the onboard SATA port to avoid mechanical conflict with huge graphics cards.

right angle side

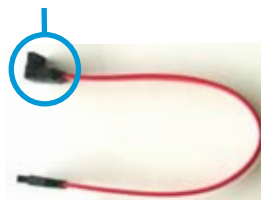

4. USB connectors (4-pin USB6, 10-1 pin USB78)

These connectors are for USB 2.0 ports. Connect the USB module cable to these connectors, then install the module to a slot opening at the back of the system chassis. This USB connector complies with USB 2.0 specification that supports up to 480 Mbps connection speed.

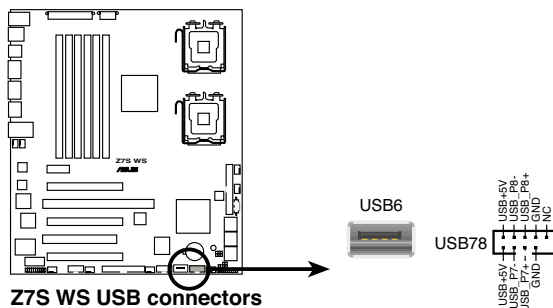

The USB port module is purchased separately.



Never connect a 1394 cable to the USB connectors. Doing so will damage the motherboard!



You can connect the USB cable to ASUS Q-Connector (USB, blue) first, and then install the Q-Connector (USB) to the USB connector onboard.

5. Serial port connector (10-1 pin COM1)

This connector is for a serial (COM) port. Connect the serial port module cable to this connector, then install the module to a slot opening at the back of the system chassis.

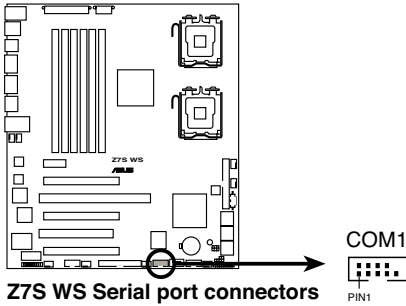

The serial port module is purchased separately.

6. CPU and system fan connectors (4-pin SPS_FAN1, FBD_FAN1, CPU0_FAN, CPU1_FAN, CHA_FAN1-4)

The fan connectors support cooling fans of 350 mA ~ 740 mA (8.88 W max.) or a total of 3.15 A ~ 6.66 A (53.28 W max.) at +12V. Connect the fan cables to the fan connectors on the motherboard, making sure that the black wire of each cable matches the ground pin of the connector.



DO NOT forget to connect the fan cables to the fan connectors. Insufficient air flow inside the system may damage the motherboard components. These are not jumpers! DO NOT place jumper caps on the fan connectors!

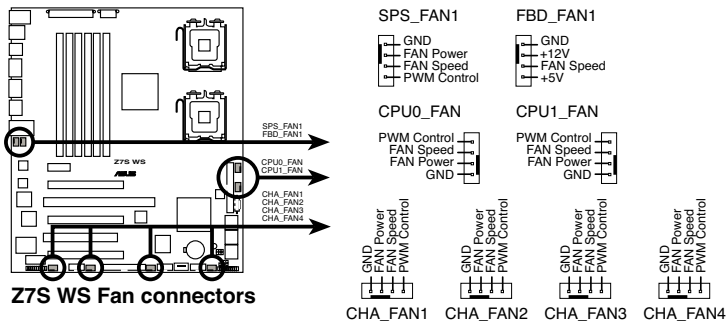

7. Power supply SMBus connector (5-pin PSUSMB1)

This connector is for the power supply SMB cable, if your power supply supports the SMBus function.

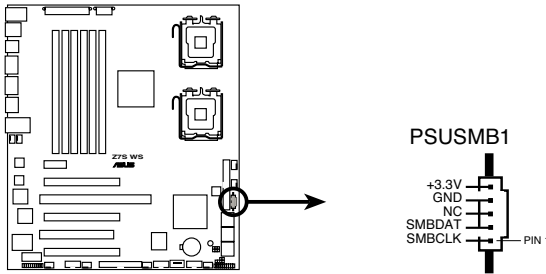

Z7S WS Power supply SMBus connector

8. Chassis intrusion connector (4-1 pin CHASSIS)

This connector is for a chassis-mounted intrusion detection sensor or switch. Connect one end of the chassis intrusion sensor or switch cable to this connector. The chassis intrusion sensor or switch sends a high-level signal to this connector when a chassis component is removed or replaced. The signal is then generated as a chassis intrusion event.

By default, the pin labeled “Chassis Signal” and “Ground” are shorted with a jumper cap. Remove the jumper caps only when you intend to use the chassis intrusion detection feature.

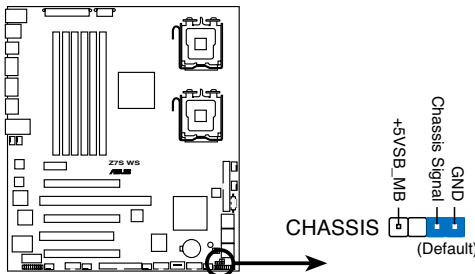

Z7S WS Chassis intrusion connector

9. SSI power connectors (24-pin EATXPWR, 8-pin EATX12V, 4-pin ATX12V)

These connectors are for SSI power supply plugs. The power supply plugs are designed to fit these connectors in only one orientation. Find the proper orientation and push down firmly until the connectors completely fit.

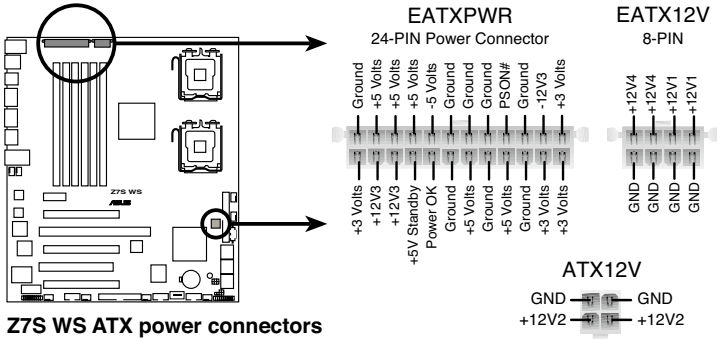

Z7S WS ATX power connectors



- For a fully configured system, we recommend that you use a power supply unit (PSU) that complies with ATX 12 V Specification 2.0 (or later version) and provides a minimum power of 600 W.
- Do not forget to connect the 8-pin EATX12V power plug; otherwise, the system will not boot.
- If you install only one CPU on the CPU0 socket, you can connect only the EATXPWR and EATX12V power connectors to boot the system.
- Use of a PSU with a higher power output is recommended when configuring a system with more power-consuming devices. The system may become unstable or may not boot up if the power is inadequate.
- If you want to use two high-end PCI Express x16 cards, use a PSU with 600W power or above to ensure the system stability.
- If you are uncertain about the minimum power supply requirement for your system, refer to the **Recommended Power Supply Wattage Calculator** at <http://support.asus.com/PowerSupplyCalculator/PSCalculator.aspx?SLanguage=en-us> for details.

10. TPM connector (20-1 pin TPM) [Optional]

This connector supports a Trusted Platform Module (TPM) system, which can securely store keys, digital certificates, passwords, and data. A TPM system also helps enhance network security, protects digital identities, and ensures platform integrity.

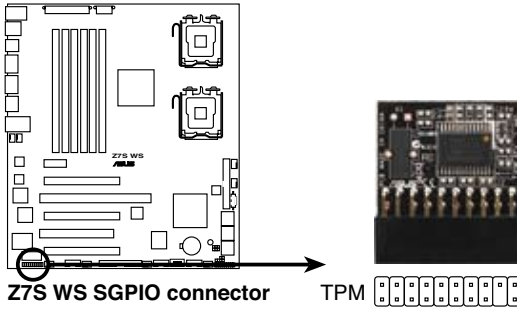

11. System panel connector (20-pin PANEL)

This connector supports several chassis-mounted functions.



The system panel connector is color-coded for easy connection.

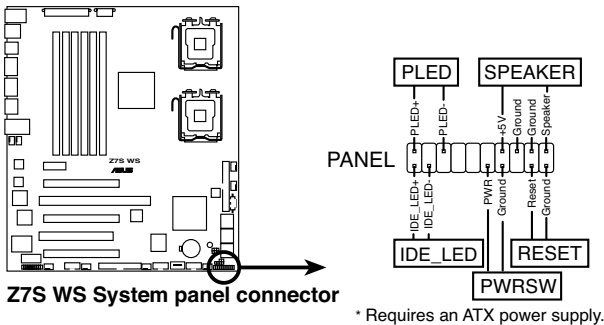

- **System power LED (Green 3-pin PLED)**
This 3-pin connector is for the system power LED. Connect the chassis power LED cable to this connector. The system power LED lights up when you turn on the system power, and blinks when the system is in sleep mode.
- **System warning speaker (Orange 4-pin SPEAKER)**
This 4-pin connector is for the chassis-mounted system warning speaker. The speaker allows you to hear system beeps and warnings.
- **Hard disk drive activity LED (Red 2-pin IDE_LED)**
This 2-pin connector is for the HDD Activity LED. Connect the HDD Activity LED cable to this connector. The IDE LED lights up or flashes when data is read from or written to the HDD.
- **ATX power button/soft-off button (Green 2-pin PWRSW)**
This connector is for the system power button. Pressing the power button turns the system on or puts the system in sleep or soft-off mode depending on the BIOS settings. Pressing the power switch for more than four seconds while the system is ON turns the system OFF.
- **Reset button (Blue 2-pin RESET)**
This 2-pin connector is for the chassis-mounted reset button for system reboot without turning off the system power.

12. Front panel audio connector (10-1 pin AAFP)

This connector is for a chassis-mounted front panel audio I/O module that supports either HD Audio or legacy AC`97 audio standard. Connect one end of the front panel audio I/O module cable to this connector.

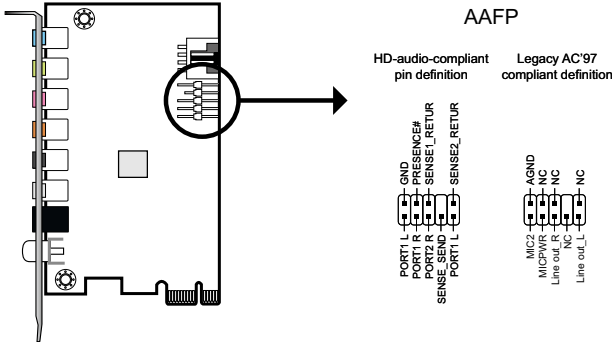

Z7S WS Analog front panel connector



- We recommend that you connect a high-definition front panel audio module to this connector to avail of the motherboard's high-definition audio capability.
- By default, this connector is set to [AC97]. If you want to connect an HD front panel audio module to this connector, set the **Front Panel Support Type** item in the BIOS setup to [Azalia]. See section 4.4.4 **Onboard Devices Configuration** for details.

13. Optical drive audio connector (4-pin CD)

These connectors allow you to receive stereo audio input from sound sources such as a CD-ROM, TV tuner, or MPEG card.

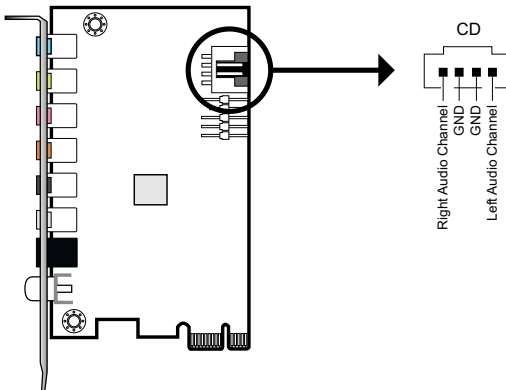

Z7S WS Internal audio connector

14. Q-Connector (system panel)

You can use ASUS Q-Connector to connect / disconnect chassis front panel cables by only a few steps. Directions below shows how to install ASUS Q-Connector.

Step1.

Connect correct front panel to ASUS Q-Connector first. You can refer to the marking on Q-Connector itself to know the detail pin definition.

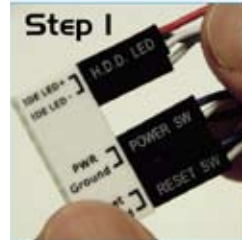

Step2.

Properly install the ASUS Q-Connector to the System panel connector.



Step3.

Front panel functions are enabled.



2.10 G.P. Diagnosis card installation

2.10.1 G.P. Diagnosis card layout

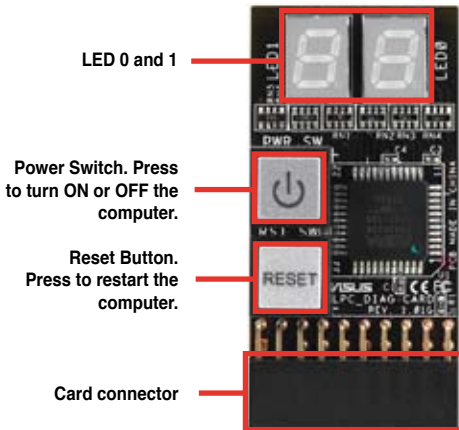

2.10.2 Installing G.P. Diagnosis card



Make sure to turn off the power supply unit before installing the diagnosis card to avoid electrical shock hazard.

1. Locate the **TPM connector (20-1 pin TPM)** on the motherboard (Refer to page 2-36 for exact connector location).

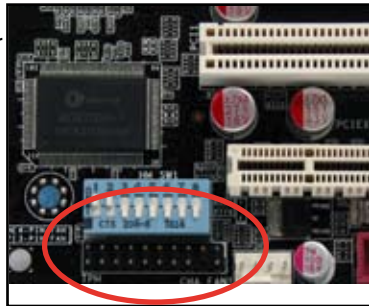

2. With the LEDs of the diagnosis card facing to the DIMM sockets, align the card connector with the TPM connector and press firmly until the card sits on the connector completely.

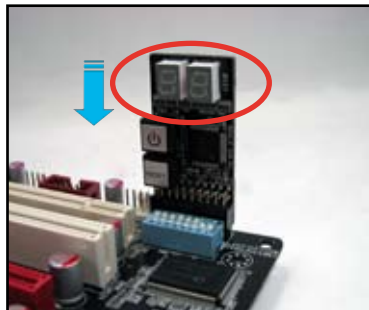

3. You may also install the G.P. Diagnosis card via a bundled 90-degree TPM adaptor for a more flexible application.

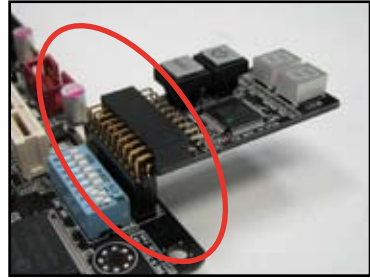

2.10.3 G.P. Diagnosis card check codes

D0	Initiate chip	75	Detect IDE
D1	Enable IO device for bootlock	78	Initiate option ROM
D2	Check and wake up system	85	Show post error
D3	Prepare system for memory detection and sizing	87	Enter BIOS setup
		A4	BIOS boot menu
D4	Memory test	AC	OS in PIC mode
D5	Copy BIOS from ROM to RAM	AA	OS in APIC mode
C0	Early CPU initiation	01	S1
C5	Wake up AP	03	S3
0A	Initiate KBC8042	04	S4
0B	Detect PS2 mouse	05	S5
0C	Detect PS2 keyboard	10	Resume from S1
38	USB initiation	30	Resume from S3
52	Display USB devices	40	Resume from S4
2A	Initiate VGA BIOS	00	Leave BIOS and pass control to OS

This chapter describes the power up sequence, and ways of shutting down the system.

Powering up **3**

3.1	Starting up for the first time.....	3-1
3.2	Turning off the computer.....	3-2

3.1 Starting up for the first time

1. After making all the connections, replace the system case cover.
2. Be sure that all switches are off.
3. Connect the power cord to the power connector at the back of the system chassis.
4. Connect the power cord to a power outlet that is equipped with a surge protector.
5. Turn on the devices in the following order:
 - a. Monitor
 - b. External SCSI devices (starting with the last device on the chain)
 - c. System power
6. After applying power, the system power LED on the system front panel case lights up. For systems with ATX power supplies, the system LED lights up when you press the ATX power button. If your monitor complies with “green” standards or if it has a “power standby” feature, the monitor LED may light up or switch between orange and green after the system LED turns on.

The system then runs the power-on self tests or POST. While the tests are running, the BIOS beeps (see BIOS beep codes table below) or additional messages appear on the screen. If you do not see anything within 30 seconds from the time you turned on the power, the system may have failed a power-on test. Check the jumper settings and connections or call your retailer for assistance.

AMI BIOS beep codes

BIOS Beep	Description
One short beep	VGA detected Quick boot set to disabled No keyboard detected
One continuous beep followed by two short beeps then a pause (repeated)	No memory detected
One continuous beep followed by three short beeps	No VGA detected
One continuous beep followed by four short beeps	Hardware component failure

7. At power on, hold down the <Delete> key to enter the BIOS Setup. Follow the instructions in Chapter 4.

3.2 Turning off the computer

3.2.1 Using the OS shut down function

If you are using Windows® XP:

1. Click the **Start** button then select **Turn Off** Computer.
2. Click the **Turn Off** button to shut down the computer.
3. The power supply should turn off after Windows® shuts down.

If you are using Windows® Vista:

1. Click the **Start** button then select **ShutDown**.
2. The power supply should turn off after Windows® shuts down.

3.2.2 Using the dual function power switch

While the system is ON, pressing the power switch for less than four seconds puts the system to sleep mode or to soft-off mode, depending on the BIOS setting. Pressing the power switch for more than four seconds lets the system enter the soft-off mode regardless of the BIOS setting. Refer to section **4.6 Power Menu** in Chapter 4 for details.

This chapter tells how to change the system settings through the BIOS Setup menus. Detailed descriptions of the BIOS parameters are also provided.

BIOS setup 4

4.1	Managing and updating your BIOS	4-1
4.2	BIOS setup program	4-9
4.3	Main menu	4-12
4.4	Advanced menu	4-17
4.5	Server menu	4-25
4.6	Security menu	4-29
4.7	Boot menu	4-33
4.8	Exit menu	4-35

4.1 Managing and updating your BIOS

The following utilities allow you to manage and update the motherboard Basic Input/Output System (BIOS) setup.

1. **ASUS Update** (Updates the BIOS in Windows® environment.)
2. **ASUS EZ Flash 2** (Updates the BIOS using a floppy disk or USB flash disk.)
3. **ASUS AFUDOS** (Updates the BIOS using a bootable floppy disk.)
4. **ASUS CrashFree BIOS 3** (Updates the BIOS using a bootable floppy disk, USB flash disk or the motherboard support DVD when the BIOS file fails or gets corrupted.)

Refer to the corresponding sections for details on these utilities.



Save a copy of the original motherboard BIOS file to a bootable floppy disk or USB flash disk in case you need to restore the BIOS in the future. Copy the original motherboard BIOS using the ASUS Update or AFUDOS utilities.

4.1.1 ASUS Update utility

The ASUS Update is a utility that allows you to manage, save, and update the motherboard BIOS in Windows® environment. The ASUS Update utility allows you to:

- Save the current BIOS file
- Download the latest BIOS file from the Internet
- Update the BIOS from an updated BIOS file
- Update the BIOS directly from the Internet, and
- View the BIOS version information.

This utility is available in the support DVD that comes with the motherboard package.



ASUS Update requires an Internet connection either through a network or an Internet Service Provider (ISP).

Installing ASUS Update

To install ASUS Update:

1. Place the support DVD in the optical drive. The Drivers menu appears.
2. Click the Utilities tab, then click Install ASUS Update VX.XX.XX.
3. The ASUS Update utility is copied to your system.



Quit all Windows® applications before you update the BIOS using this utility.

Updating the BIOS through the Internet

To update the BIOS through the Internet:

1. Launch the ASUS Update utility from the Windows® desktop by clicking **Start > Programs > ASUS > ASUSUpdate > ASUSUpdate**. The ASUS Update main window appears.

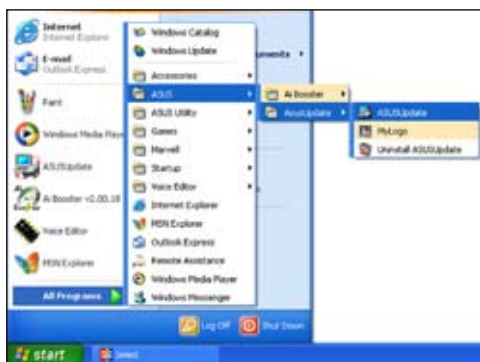

2. Select **Update BIOS** from the Internet option from the drop-down menu, then click **Next**.
3. Select the ASUS FTP site nearest you to avoid network traffic, or click **Auto Select**. Click **Next**.

- From the FTP site, select the BIOS version that you wish to download. Click **Next**.
- Follow the screen instructions to complete the update process.



The ASUS Update utility is capable of updating itself through the Internet. Always update the utility to avail all its features.



Updating the BIOS through a BIOS file

To update the BIOS through a BIOS file:

- Launch the ASUS Update utility from the Windows® desktop by clicking **Start > Programs > ASUS > ASUSUpdate > ASUSUpdate**. The ASUS Update main window appears.
- Select Update BIOS from a file option from the drop-down menu, then click **Next**.



- Locate the BIOS file from the Open window.
- Follow the screen instructions to complete the update process.

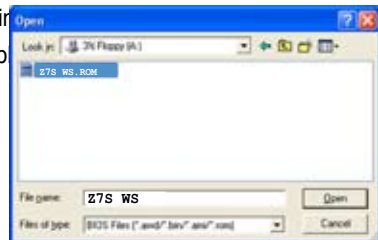

4.1.2 Creating a bootable floppy disk

1. Do either one of the following to create a bootable floppy disk.

DOS environment

- a. Insert a 1.44MB floppy disk into the drive.
- b. At the DOS prompt, type `format a: /s` then press <Enter>.

Windows® XP environment

- a. Insert a 1.44 MB floppy disk to the floppy disk drive.
- b. Click **Start** from the Windows® desktop, then select **My Computer**.
- c. Select the 3 1/2 Floppy Drive icon.
- d. Click File from the menu, then select **Format**. A **Format 3 1/2 Floppy Disk** window appears.
- e. Select **Create an MS-DOS startup disk** from the format options field, then click **Start**.

Windows® Vista environment

- a. Insert a formatted, high density 1.44 MB floppy disk to the floppy disk drive.
 - b. Click  from the Windows® desktop, then select **Computer**.
 - c. Right-click **Floppy Disk Drive** then click **Format** to display the **Format 3 1/2 Floppy** dialog box .
 - d. Select the **Create an MS-DOS startup disk** check box.
 - e. Click **Start**.
2. Copy the original or the latest motherboard BIOS file to the bootable floppy disk.

4.1.3 ASUS EZ Flash 2 utility

The ASUS EZ Flash 2 feature allows you to update the BIOS without having to go through the long process of booting from a floppy disk and using a DOS-based utility. The EZ Flash 2 utility is built in the BIOS chip so it is accessible by pressing <Alt> + <F2> during the Power-On Self Tests (POST).

To update the BIOS using EZ Flash 2:

1. Visit the ASUS website (www.asus.com) to download the latest BIOS file for the motherboard.
2. Save the BIOS file to a floppy disk or a USB flash disk, then restart the system.
3. You can launch the EZ Flash 2 by two methods.
 - (1) Insert the floppy disk / USB flash disk that contains the BIOS file to the floppy disk drive or the USB port.
Press <Alt> + <F2> during POST to display the following.

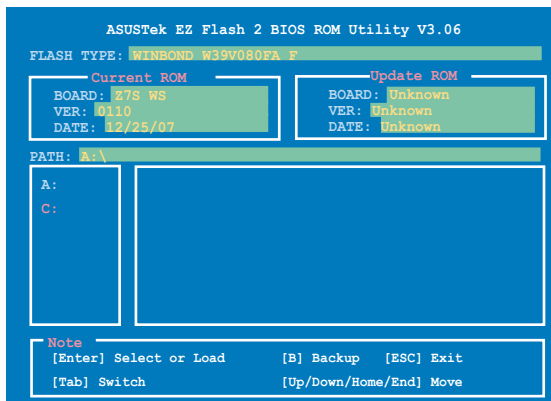

- (2) Enter BIOS setup program. Go to the **Tools** menu to select **EZ Flash 2** and press <Enter> to enable it.
You can switch between drives by pressing <Tab> before the correct file is found. Then press <Enter>.
4. When the correct BIOS file is found, EZ Flash 2 performs the BIOS update process and automatically reboots the system when done.



- This function can support devices such as a USB flash disk or a floppy disk with FAT 32/16 format and single partition only.
- Do not shut down or reset the system while updating the BIOS to prevent system boot failure!

4.1.4 AFUDOS utility

The AFUDOS utility allows you to update the BIOS file in DOS environment using a bootable floppy disk with the updated BIOS file. This utility also allows you to copy the current BIOS file that you can use as backup when the BIOS fails or gets corrupted during the updating process.

Copying the current BIOS

To copy the current BIOS file using the AFUDOS utility:



- Make sure that the floppy disk is not write-protected and has at least 1024KB free space to save the file.
- The succeeding BIOS screens are for reference only. The actual BIOS screen displays may not be same as shown.

1. Copy the AFUDOS utility (afudos.exe) from the motherboard support DVD to the bootable floppy disk you created earlier.
2. Boot the system in DOS mode, then at the prompt type:

```
afudos /o[filename]
```

where the [filename] is any user-assigned filename not more than eight alphanumeric characters for the main filename and three alphanumeric characters for the extension name.

```
A:\>afudos /oOLDBIOS1.rom
```

Main filename Extension name

3. Press <Enter>. The utility copies the current BIOS file to the floppy disk.

```
A:\>afudos /oOLDBIOS1.rom
AMI Firmware Update Utility - Version 1.19(ASUS V2.07(03.11.24BB))
Copyright (C) 2002 American Megatrends, Inc. All rights reserved.
  Reading flash ..... done
  Write to file..... ok
A:\>
```

The utility returns to the DOS prompt after copying the current BIOS file.

Updating the BIOS file

To update the BIOS file using the AFUDOS utility:

1. Visit the ASUS website (www.asus.com) and download the latest BIOS file for the motherboard. Save the BIOS file to a bootable floppy disk.



Write the BIOS filename on a piece of paper. You need to type the exact BIOS filename at the DOS prompt.

2. Copy the AFUDOS utility (afudos.exe) from the motherboard support DVD to the bootable floppy disk you created earlier.
3. Boot the system in DOS mode, then at the prompt type:
`afudos /i[filename]`

where [filename] is the latest or the original BIOS file on the bootable floppy disk.

```
A:\>afudos /Z7SWS.ROM
```

4. The utility verifies the file and starts updating the BIOS.

```
A:\>afudos /iZ7SWS.ROM
AMI Firmware Update Utility - Version 1.19 (ASUS V2.07 (03.11.24BB))
Copyright (C) 2002 American Megatrends, Inc. All rights reserved.

WARNING!! Do not turn off power during flash BIOS
Reading file ..... done
Reading flash ..... done

Advance Check .....
Erasing flash ..... done
Writing flash ..... 0x0008CC00 (9%)
```



Do not shut down or reset the system while updating the BIOS to prevent system boot failure!

5. The utility returns to the DOS prompt after the BIOS update process is completed. Reboot the system from the hard disk drive.

```
A:\>afudos /iZ7SWS.ROM
AMI Firmware Update Utility - Version 1.19 (ASUS V2.07 (03.11.24BB))
Copyright (C) 2002 American Megatrends, Inc. All rights reserved.

WARNING!! Do not turn off power during flash BIOS
Reading file ..... done
Reading flash ..... done

Advance Check .....
Erasing flash ..... done
Writing flash ..... done
Verifying flash .... done

Please restart your computer

A:\>
```

4.1.5 ASUS CrashFree BIOS 3 utility

The ASUS CrashFree BIOS 3 is an auto recovery tool that allows you to restore the BIOS file when it fails or gets corrupted during the updating process. You can update a corrupted BIOS file using the motherboard support DVD or the USB flash disk that contains the updated BIOS file.



Prepare the motherboard support DVD, the floppy disk or the USB flash disk containing the updated motherboard BIOS before using this utility.

Recovering the BIOS from the support DVD

To recover the BIOS from the support DVD:

1. Turn on the system.
2. Insert the motherboard support DVD to the optical drive.
3. The utility displays the following message and automatically checks the DVD for the BIOS file.

```
Bad BIOS checksum. Starting BIOS recovery...
Checking for floppy...
```

When found, the utility reads the BIOS file and starts flashing the corrupted BIOS file.

```
Bad BIOS checksum. Starting BIOS recovery...
Checking for floppy...
Floppy found!
Reading file "Z7SWS.ROM". Completed.
Start flashing...
```

4. Restart the system after the utility completes the updating process.

Recovering the BIOS from the USB flash disk

To recover the BIOS from the USB flash disk:

1. Insert the USB flash disk that contains the BIOS file to the USB port.
2. Turn on the system.
3. The utility will automatically checks the devices for the BIOS file. When found, the utility reads the BIOS file and starts flashing the corrupted BIOS file.
4. Restart the system after the utility completes the updating process.



-
- Only the USB flash disk with FAT 32/16 format and single partition can support ASUS CrashFree BIOS 3. The device size should be smaller than 8GB.
 - DO NOT shut down or reset the system while updating the BIOS! Doing so can cause system boot failure!
-

4.2 BIOS setup program

This motherboard supports a programmable Low-Pin Count (LPC) chip that you can update using the provided utility described in section **4.1 Managing and updating your BIOS**.

Use the BIOS Setup program when you are installing a motherboard, reconfiguring your system, or prompted to “Run Setup.” This section explains how to configure your system using this utility.

Even if you are not prompted to use the Setup program, you can change the configuration of your computer in the future. For example, you can enable the security password feature or change the power management settings. This requires you to reconfigure your system using the BIOS Setup program so that the computer can recognize these changes and record them in the CMOS RAM of the LPC chip.

The LPC chip on the motherboard stores the Setup utility. When you start up the computer, the system provides you with the opportunity to run this program. Press during the Power-On Self-Test (POST) to enter the Setup utility; otherwise, POST continues with its test routines.

If you wish to enter Setup after POST, restart the system by pressing <Ctrl+Alt+Delete>, or by pressing the reset button on the system chassis. You can also restart by turning the system off and then back on. Do this last option only if the first two failed.

The Setup program is designed to make it as easy to use as possible. Being a menu-driven program, it lets you scroll through the various sub-menus and make your selections from the available options using the navigation keys.



-
- The default BIOS settings for this motherboard apply for most conditions to ensure optimum performance. If the system becomes unstable after changing any BIOS settings, load the default settings to ensure system compatibility and stability. Select the Load Setup Defaults item under the Exit Menu. See section **4.8 Exit Menu**.
 - The BIOS setup screens shown in this section are for reference purposes only, and may not exactly match what you see on your screen.
 - Visit the ASUS website (www.asus.com) to download the latest BIOS file for this motherboard.
-

4.2.1 BIOS menu screen

The screenshot shows the BIOS Setup Utility menu. At the top is a blue menu bar with the title 'BIOS SETUP UTILITY' and six items: 'Main', 'Advanced', 'Power', 'Boot', 'Tools', and 'Exit'. The 'Main' item is highlighted. Below the menu bar is a grey area containing several sections. On the left, there are 'Sub-menu items' such as 'System Time', 'System Date', 'Legacy Diskette A', and 'Language'. In the center, there are 'Configuration fields' showing values like '[17:41:19]', '[Mon 01/14/2008]', '[1.44M, 3.5 in.]', and '[English]'. On the right, there is 'General help' text explaining navigation keys like [ENTER], [TAB], [SHIFT-TAB], [F1], [F10], and [ESC]. At the bottom of the screen, there is a footer with the text 'v02.61 (C) Copyright 1985-2007, American Megatrends, Inc.'. Labels with lines pointing to these elements are: 'Menu items' (pointing to the menu bar), 'Menu bar' (pointing to the bar itself), 'Configuration fields' (pointing to the time/date fields), 'General help' (pointing to the help text), 'Sub-menu items' (pointing to the left column), and 'Navigation keys' (pointing to the help text).

4.2.2 Menu bar

The menu bar on top of the screen has the following main items:

- Main** For changing the basic system configuration
- Advanced** For changing the advanced system settings
- Power** For changing the advanced power management (APM) configuration
- Boot** For changing the system boot configuration
- Tools** For configuring options for special functions
- Exit** For selecting the exit options and loading default settings

To select an item on the menu bar, press the right or left arrow key on the keyboard until the desired item is highlighted.

4.2.3 Navigation keys

At the bottom right corner of a menu screen are the navigation keys for that particular menu. Use the navigation keys to select items in the menu and change the settings.



Some of the navigation keys differ from one screen to another.

4.2.4 Menu items

The highlighted item on the menu bar displays the specific items for that menu. For example, selecting **Main** shows the Main menu items.

The other items (Advanced, Power, Boot, and Exit) on the menu bar have their respective menu items.

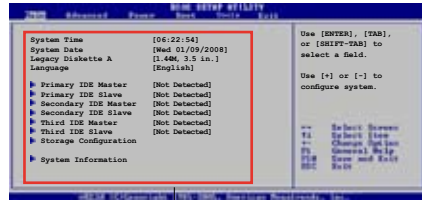

Main menu items

4.2.5 Sub-menu items

A solid triangle before each item on any menu screen means that the item has a sub-menu. To display the sub-menu, select the item and press <Enter>.

4.2.6 Configuration fields

These fields show the values for the menu items. If an item is user-configurable, you can change the value of the field opposite the item. You cannot select an item that is not user-configurable.

A configurable field is enclosed in brackets, and is highlighted when selected. To change the value of a field, select it then press <Enter> to display a list of options. Refer to “4.2.7 Pop-up window.”

4.2.7 Pop-up window

Select a menu item then press <Enter> to display a pop-up window with the configuration options for that item.

4.2.8 Scroll bar

A scroll bar appears on the right side of a menu screen when there are items that do not fit on the screen. Press the Up/Down arrow keys or <Page Up> /<Page Down> keys to display the other items on the screen.

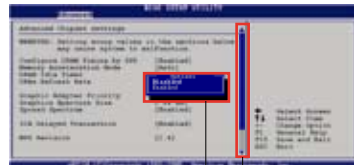

Pop-up window

Scroll bar

4.2.9 General help

At the top right corner of the menu screen is a brief description of the selected item.

4.3 Main menu

When you enter the BIOS Setup program, the **Main** menu screen appears, giving you an overview of the basic system information.



Refer to section **4.2.1 BIOS menu screen** for information on the menu screen items and how to navigate through them.

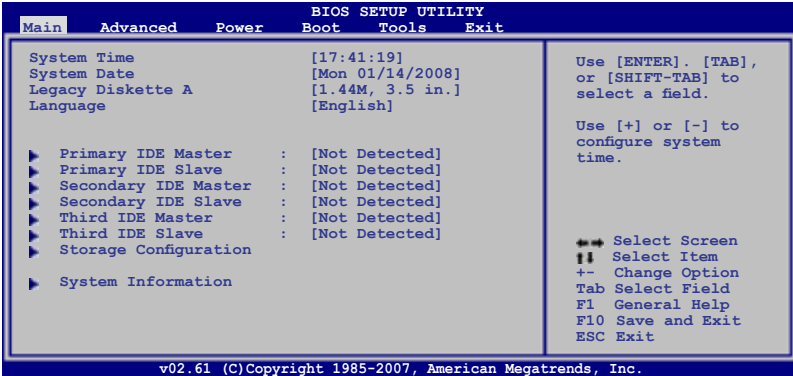

4.3.1 System Date [Day xx/xx/xxxx]

Allows you to set the system date.

4.3.2 System Time [xx:xx:xx]

Allows you to set the system time.

4.3.3 Legacy Diskette A [1.44M, 3.5 in.]

Sets the type of floppy drive installed.

Configuration options: [Disabled] [720K , 3.5 in.] [1.44M, 3.5 in.]

4.3.4 Language [English]

Allows you to choose the BIOS language version from the options.

Configuration options: [Japanese] [Français] [German] [English]

4.3.5 Primary / Secondary / Third IDE Master / Slave

The BIOS automatically detects the connected IDE devices. There is a separate sub-menu for each IDE device. Select a device item, then press <Enter> to display the IDE device information.

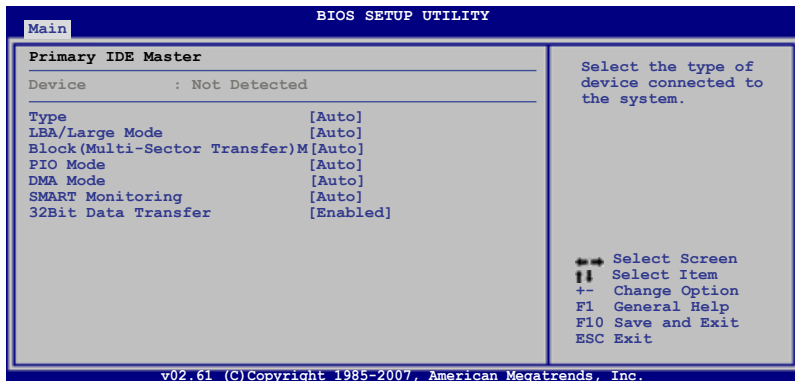

The BIOS automatically detects the values opposite the dimmed items (Device, Vendor, Size, LBA Mode, Block Mode, PIO Mode, Async DMA, Ultra DMA, and SMART monitoring). These values are not user-configurable. These items show N/A if no IDE device is installed in the system.

Type [Auto]

Selects the type of IDE drive. Setting to [Auto] allows automatic selection of the appropriate IDE device type. Select [CDROM] if you are specifically configuring a CD-ROM drive. Select [ARMD] (ATAPI Removable Media Device) if your device is either a ZIP, LS-120, or MO drive.

Configuration options: [Not Installed] [Auto] [CDROM] [ARMD]

LBA/Large Mode [Auto]

Enables or disables the LBA mode. Setting to [Auto] enables the LBA mode if the device supports this mode, and if the device was not previously formatted with LBA mode disabled.

Configuration options: [Disabled] [Auto]

Block (Multi-sector Transfer) [Auto]

Enables or disables data multi-sectors transfers. When set to [Auto], the data transfer from and to the device occurs multiple sectors at a time if the device supports multi-sector transfer feature. When set to [Disabled], the data transfer from and to the device occurs one sector at a time.

Configuration options: [Disabled] [Auto]

PIO Mode [Auto]

Selects the PIO mode. Configuration options: [Auto] [0] [1] [2] [3] [4]

DMA Mode [Auto]

Selects the DMA mode.

Configuration options: [Auto] [SWDMA0] [SWDMA1] [SWDMA2] [MWDMA0] [MWDMA1] [MWDMA2] [UDMA0] [UDMA1] [UDMA2] [UDMA3] [UDMA4] [UDMA5] [UDMA6]

SMART Monitoring [Auto]

Sets the Smart Monitoring, Analysis, and Reporting Technology.

Configuration options: [Auto] [Disabled] [Enabled]

32Bit Data Transfer [Disabled]

Enables or disables 32-bit data transfer.

Configuration options: [Disabled] [Enabled]

4.3.6 Storage Configuration

The items in this menu allow you to set or change the configurations for the IDE devices installed in the system. Select an item then press <Enter> if you wish to configure the item.

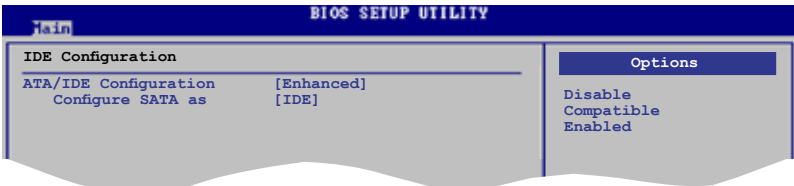

ATA/IDE Configuration [Enhanced]

Allows you to select the IDE Configuration.

Configuration options: [Disabled] [Compatible] [Enhanced]

Legacy IDE Channels [SATA Pri, PATA Sec]

This sub-item appears only when you set the **ATA/IDE Configuration** item to [Compatible] and allows you to set the legacy IDE channels mode.

Configuration options: [SATA Only] [PATA Pri, SATA Sec] [SATA Pri, PATA Sec] [PATA Only]



- When set to [PATA Pri, SATA Sec], SATA port 1 and 3 will be disabled, and SATA port 2 and 4 will be enabled as Secondary Master and Secondary Slave respectively.
- When set to [SATA Pri, PATA Sec,] SATA port 2 and 4 will be disabled, and SATA port 1 and 3 will be enabled as Secondary Master and Secondary Slave respectively.

Configure SATA as [IDE]

This sub-item appears only when you set the **ATA/IDE Configuration** item to [Enhanced] and allows you to set the SATA configuration.

Configuration options: [IDE] [RAID] [AHCI]



- If you want to use the Serial ATA hard disk drives as Parallel ATA physical storage devices, keep the default setting [IDE].
- When set to [IDE] mode, SATA port 1 will serve as Primary Master, SATA port 3 will serve as Primary Slave, SATA port 2 will serve as Secondary Master, and SATA port 4 will serve as Secondary Slave. SATA port 5 and 6 will be disabled.
- If you want the Serial ATA hard disk drives to use the Advanced Host Controller Interface (AHCI), set this item to [AHCI]. The AHCI allows the onboard storage driver to enable advanced Serial ATA features that increases storage performance on random workloads by allowing the drive to internally optimize the order of commands.
- If you want to create a RAID 0, RAID 1, RAID 5, RAID 10, or the Intel® Matrix Storage Technology configuration from the Serial ATA hard disk drives, set this item to [RAID].

AHCI Configuration

This menu is the section for AHCI configuration. It appears only when you set the item ATA/IDE Configuration from the sub-menu of IDE Configuration to [AHCI].

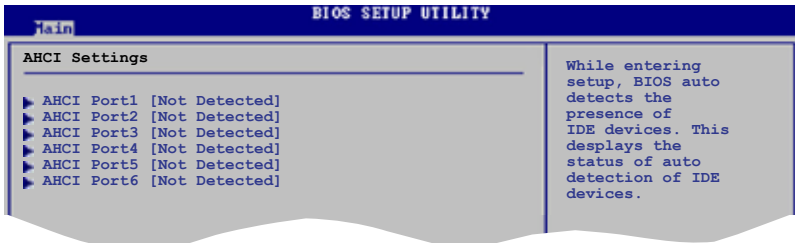

AHCI Port1~6 [XXXX]

Displays the status of auto-detection of SATA devices.

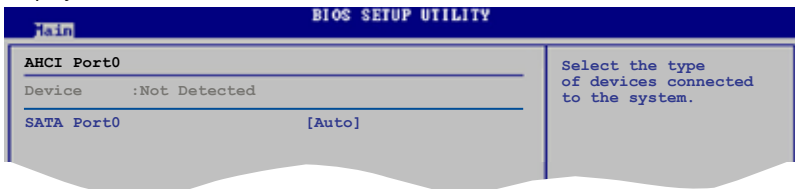

SATA Port0 [Auto]

Allows you to select the type of device connected to the system.

Configuration options: [Auto] [Not Installed]

4.3.7 System Information

This menu gives you an overview of the general system specifications. The BIOS automatically detects the items in this menu.

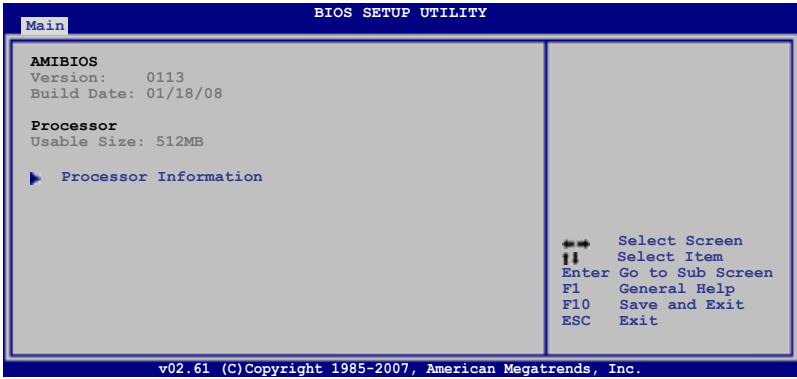

AMI BIOS

Displays the auto-detected BIOS information.

System Memory

Displays the auto-detected total system memory.

Processor Information

Displays the auto-detected CPU specification.

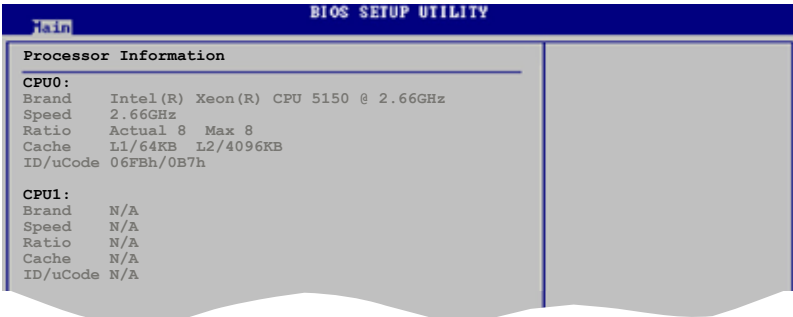

4.4 Advanced menu

The Advanced menu items allow you to change the settings for the CPU and other system devices.



Take caution when changing the settings of the Advanced menu items. Incorrect field values can cause the system to malfunction.



The configuration options for the Advanced menu items vary depending on the CPU and DIMMs you install on the motherboard.

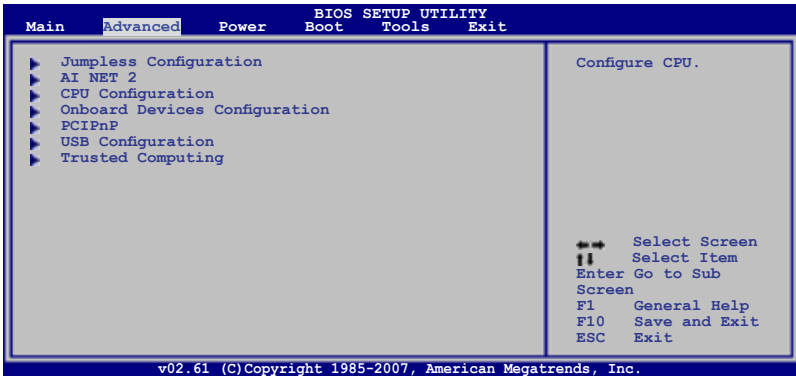

4.4.1 Jumpless Configuration

This menu allows you to select the advanced voltage settings.

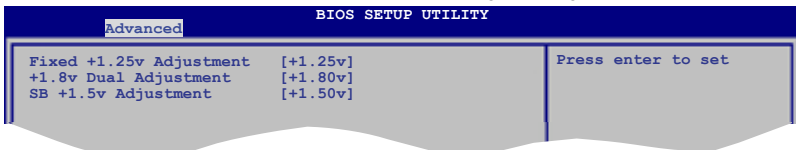

Fixed +1.25v Adjustment [+1.25v]

Allows you to set the North Bridge voltage.

Configuration options: [+1.40v] [+1.35v] [+1.30v] [+1.25v]

+1.8v Dual Adjustment [+1.80v]

Allows you to set the DRAM voltage.

Configuration options: [+1.90v] [+1.86v] [+1.83v] [+1.80v]

SB +1.5v Adjustment [+1.50v]

Allows you to set the the South Bridge voltage.

Configuration options: [+1.50v] [+1.55v] [+1.60v] [+1.65v]

4.4.2 Ai Net 2

This menu displays the status of the Local Area Network (LAN) cables connected to the LAN (RJ-45) ports.

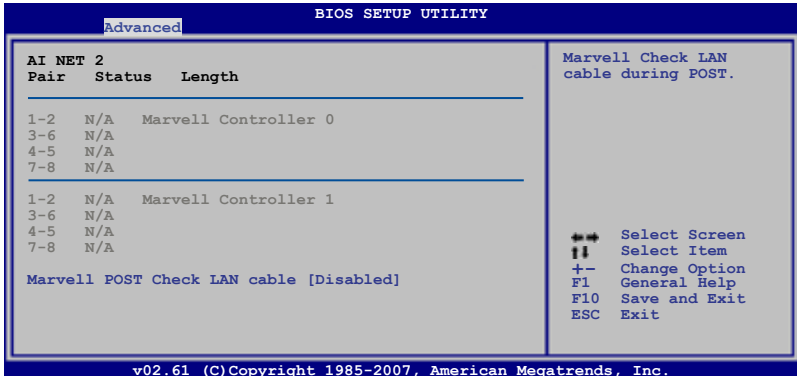

Marvell POST Check LAN cable [Disabled]

Allows you to enable or disable LAN cable check during POST. When enabled, the menu reports the cable faults or shorts, and displays the point (length) where the faults or shorts are detected. Configuration options: [Disabled] [Enabled]

4.4.3 CPU Configuration

The items in this menu show the CPU-related information that the BIOS automatically detects.

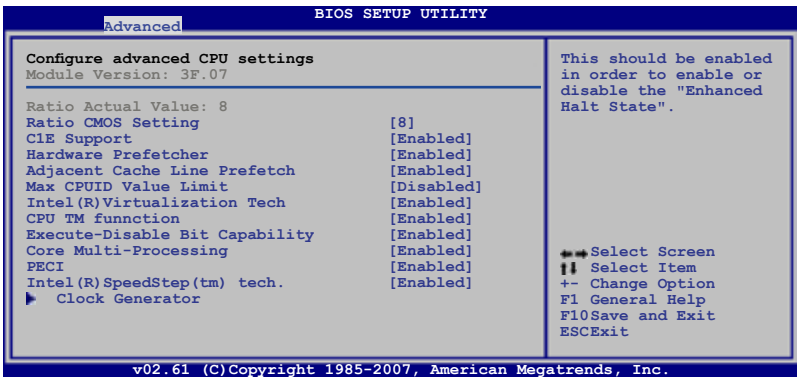

Ratio CMOS Setting [8]

This item allows you to set the ratio between CPU Core Clock and FSB Frequency. The value is adjusted by typing the desired values using the numeric keypad and press the <Enter> key. You can also use the <+> and <-> keys to adjust the value. If an invalid ratio is set in CMOS, then actual and setpoint values may differ.

C1E Support [Enabled]

Allows you to enable or disable the Enhanced Halt State support.

Configuration options: [Disabled] [Enabled]

Hardware Prefetcher [Enabled]

Allows you to enable or disable the Hardware Prefetcher Function.

Configuration options: [Disabled] [Enabled]

Adjacent Cache Line Prefetch [Enabled]

Allows you to enable or disable the Adjacent Cache Line Prefetch Function.

Configuration options: [Disabled] [Enabled]

Max CPUID Value Limit [Disabled]

Setting this item to [Enabled] allows legacy operating systems to boot even without support for CPUs with extended CPUID functions.

Configuration options: [Disabled] [Enabled]

Intel(R) Virtualization Technology [Enabled]

The Intel® Virtualization Technology allows a hardware platform to run multiple operating systems separately and simultaneously, enabling one system to virtually function as several systems.

Configuration options: [Disabled] [Enabled]

CPU TM function [Enabled]

This function enables the overheated CPU to throttle the clock speed to cool down.

Configuration options: [Disabled] [Enabled]

Execute-Disable Bit Capability [Enabled]

Allows you to enable or disable the No-Execution Page Protection Technology.

Setting this item to [Disabled] forces the XD feature flag to always return to zero (0).

Configuration options: [Disabled] [Enabled]

Core Multi-Processing [Enabled]

Allows you to enable or disable one execution core of the CPU.

Configuration options: [Disabled] [Enabled]

PECI [Enabled]

Allows you to enable or disable the Platform Environment control Interface (PECI) function. Configuration options: [Enabled] [Disabled]

Intel (R) SpeedStep (tm) tech. [Enabled]

When set to [Disabled], the CPU runs at its default speed. When set to [Enabled], the CPU speed is controlled by the operating system.

Configuration options: [Disabled] [Enabled]

Clock Generator

This menu allows you to select the Clock Generator mode.



Clock Mode Select [Auto]

This item allows you to select the Clock Generator mode.

Configuration options: [Auto] [Manual]



The following two sub-items appear only when you set the Clock Mode Select item to [Manual].

CPU Frequency Setting [333]

Displays the frequency sent by the clock generator to the system bus and PCI bus. The value of this item is auto-detected by the BIOS. Use the <+> and <-> keys to adjust the CPU frequency. You can also type the desire CPU frequency using the numeric keypad. The values range from 333 to 500.

Spread Spectrum [+/-0.3%]

Allows BIOS to set clock spread spectrum for EMI control.

Configuration options: [Disabled] [+/-0.1%] [+/-0.2%] [+/-0.3%] [+/-0.4%] [+/-0.5%] [+/-0.6%] [+/-0.7%] [+/-0.8%] [+/-0.9%] [+/-1.0%]

4.4.4 Onboard Devices Configuration

The Onboard Devices Configuration menu allows you to change the onboard devices settings. Select an item then press <Enter> to display the sub-menu.

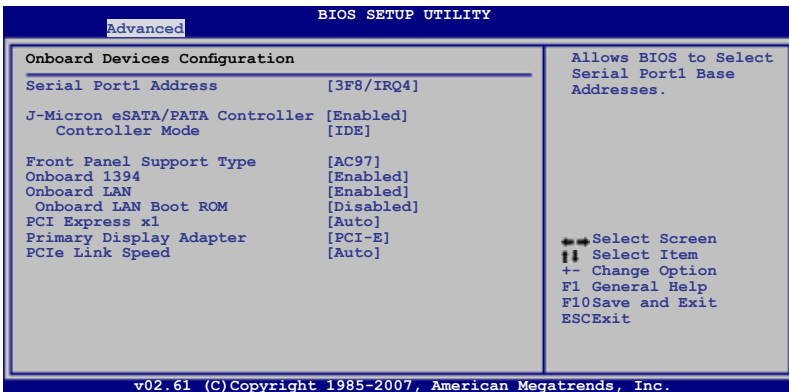

Serial Port1 Address [3F8/IRQ4]

Allows you to select the Serial Port1 base address.

Configuration options: [Disabled] [3F8/IRQ4] [2F8/IRQ3] [3E8/IRQ4] [2E8/IRQ3]

J-Micro eSATA/PATA Controller [Enabled]

Allows you to enable or disable the J-Micro eSATA/PATA controller.

Configuration options: [Enabled] [Disabled]

Controller Mode [IDE]

This sub-item appears only when you set the **J-Micro eSATA/PATA Controller** item to [Enabled] and allows you to select the J-Micro eSATA/PATA controller mode.

Configuration options: [RAID] [IDE] [AHCI]

Front Panel Support Type [AC97]

This item allows you to set the front panel audio connector (AAFP) mode to legacy AC'97 or high-definition audio depending on the audio standard that the front panel audio module supports.

Configuration options: [AC97] [Azalia]

Onboard 1394 [Enabled]

Allows you to enable or disable the onboard IEEE 1394 controller.

Configuration options: [Enabled] [Disabled]

Onboard LAN [Enabled]

Allows you to hide or active the onboard LAN.

Configuration options: [Disabled] [Enabled]

Onboard LAN Boot ROM [Disabled]

Allows you to configure the onboard LAN Boot ROM.

Configuration options: [Disabled] [Enabled]

PCI Express x1 [Auto]

Allows you to enable or disable the onboard PCI Express x1 slot.

Configuration options: [Auto] [Disabled]

Primary Display Adapter [PCI-E]

Allows you to select the graphics controller as the primary boot device.

Configuration options: [PCI-E] [PCI]

PCIe Link Speed [Auto]

Allows you to select the PCI Express link speed.

Configuration option: [Auto] [PCIe Gen1]

4.4.5 PCIPnP

The PCIPnP menu items allow you to change the advanced settings for PCI/PnP devices. The menu includes setting IRQ and DMA channel resources for either PCI/PnP or legacy ISA devices, and setting the memory size block for legacy ISA devices.



Take caution when changing the settings of the PCI PnP menu items. Incorrect field values can cause the system to malfunction.

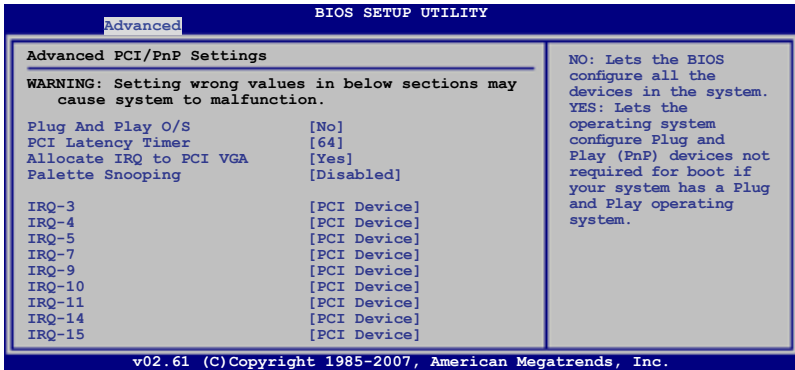

Plug And Play O/S [No]

When set to [No], BIOS configures all the devices in the system. When set to [Yes] and if you install a Plug and Play operating system, the operating system configures the Plug and Play devices not required for boot. Configuration options: [No] [Yes]

PCI Latency Timer [64]

Allows you to select the value in units of PCI clocks for the PCI device latency timer register. Configuration options: [32] [64] [96] [128] [160] [192] [224] [248]

Allocate IRQ to PCI VGA [Yes]

When set to [Yes], BIOS assigns an IRQ to PCI VGA card if the card requests for an IRQ. When set to [No], BIOS does not assign an IRQ to the PCI VGA card even if requested. Configuration options: [No] [Yes]

Palette Snooping [Disabled]

When set to [Enabled], the palette snooping feature informs the PCI devices that an ISA graphics device is installed in the system so that the latter can function correctly. Configuration options: [Disabled] [Enabled]

IRQ-xx [PCI Device]

When set to [PCI Device], the specific IRQ is free for use of PCI/PnP devices. When set to [Reserved], the IRQ is reserved for legacy ISA devices. Configuration options: [PCI Device] [Reserved]

4.4.6 USB Configuration

The items in this menu allows you to change the USB-related features. Select an item then press <Enter> to display the configuration options.

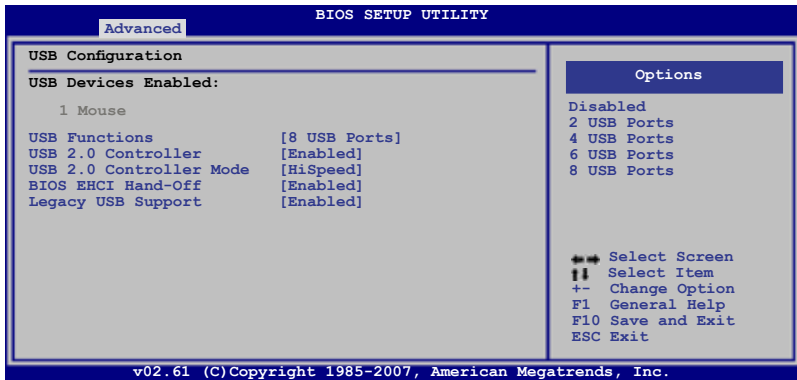

USB Functions [8 USB Ports]

Allows you to enable a specific number of USB ports or disable the USB function. Configuration options: [Disabled] [2 USB Ports] [4 USB Ports] [6 USB Ports] [8 USB Ports]



The **USB 2.0 Controller** item, **USB 2.0 Controller Mode** item and **Legacy USB Support** item appear only when you set the **USB Functions** item to [2 USB Ports], [4 USB Ports], [6 USB Ports], or [8 USB Ports].

USB 2.0 Controller [Enabled]

Allows you to enable or disable the USB 2.0 controller. Configuration options: [Enabled] [Disabled]

USB2.0 Controller mode [HiSpeed]

Appears only when you set the **USB 2.0 Controller** item to [Enabled] and allows you to select the USB2.0 controller mode. Configuration options: [HiSpeed] [FullSpeed]

BIOS EHCI Hand-Off [Enabled]

Allows you to enable or disable the BIOS EHCI Hand-Off support function. Configuration options: [Disabled] [Enabled]

Legacy USB Support [Enabled]

Allows you to enable or disable support for legacy USB. The [Auto] option disables legacy support if there is no USB device connected. Configuration options: [Disabled] [Enabled] [Auto]

4.4.7 Trusted Computing

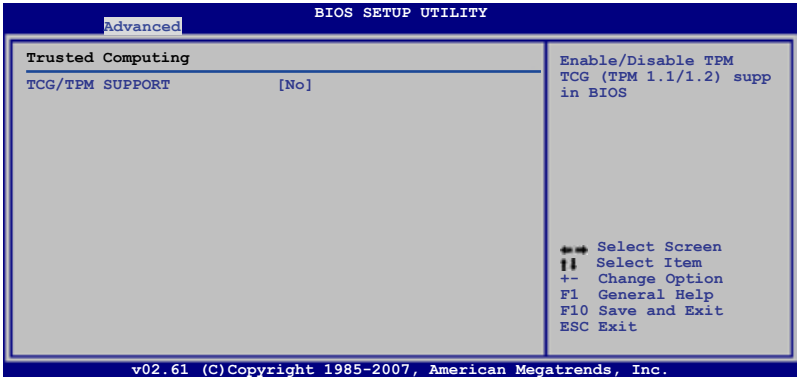

TCG/TPM SUPPORT [No]

Allows you to set the TCG/TPM SUPPORT.

Configuration options: [No] [Yes]

4.5 Power menu

The Power menu items allow you to change the settings for the Advanced Power Management (APM). Select an item then press <Enter> to display the configuration options.

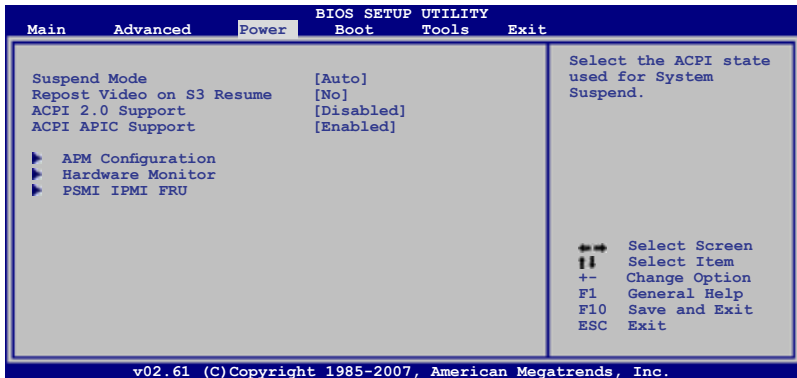

4.5.1 Suspend Mode [Auto]

Allows you to select the Advanced Configuration and Power Interface (ACPI) state to be used for system suspend.

Configuration options: [S1 (POS) only] [S3 only] [Auto]

4.5.2 Repost Video on S3 Resume [No]

Determines whether to invoke VGA BIOS POST on S3/STR resume.

Configuration options: [No] [Yes]

4.5.3 ACPI 2.0 Support [Disabled]

Add additional tables as per ACPI 2.0 specifications.

Configuration options: [Disabled] [Enabled]

4.5.4 ACPI APIC Support [Enabled]

Allows you to enable or disable the Advanced Configuration and Power Interface (ACPI) support in the Advanced Programmable Interrupt Controller (APIC). When set to [Enabled], the ACPI APIC table pointer is included in the RSDT pointer list.

Configuration options: [Disabled] [Enabled]

4.5.5 APM Configuration

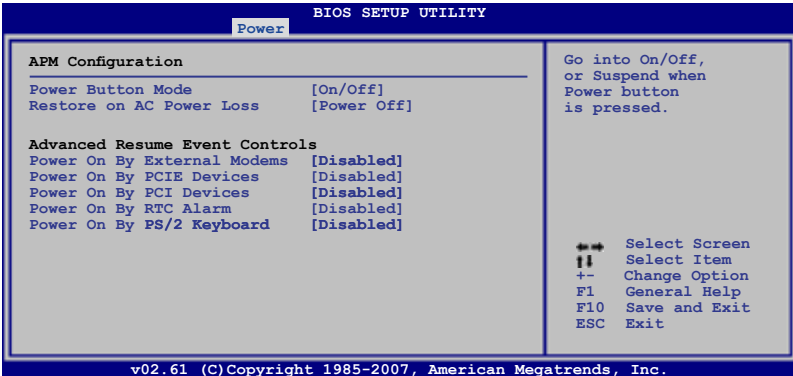

Power Button Mode [On/Off]

When set to [On/Off], the system shuts down while pressing the Power button. When set to [Suspend], the system goes suspend while pressing the Power button. Configuration options: [On/Off] [Suspend]

Restore on AC Power Loss [Power Off]

When set to [Power Off], the system goes into off state after an AC power loss. When set to [Power On], the system goes on after an AC power loss. When set to [Last State], the system goes into either off or on state, whatever the system state was before the AC power loss. Configuration options: [Power Off] [Power On] [Last State]

Power On By External Modems [Disabled]

This allows either settings of [Enabled] or [Disabled] for powering up the computer when the external modem receives a call while the computer is in Soft-off mode. Configuration options: [Disabled] [Enabled]



The computer cannot receive or transmit data until the computer and applications are fully running. Thus, connection cannot be made on the first try. Turning an external modem off and then back on while the computer is off causes an initialization string that turns the system power on.

Power On By PCIE Devices [Disabled]

Allows you to enable or disable the PCIE devices to generate a wake event. Configuration options: [Disabled] [Enabled]

Power On By PCI Devices [Disabled]

Allows you to enable or disable the PME to wake up from S5 by PCI devices. Configuration options: [Disabled] [Enabled]

Power On By RTC Alarm [Disabled]

Allows you to enable or disable RTC to generate a wake event. When this item is set to [Enabled], the items RTC Alarm Date/ RTC Alarm Hour/ RTC Alarm Minute/ RTC Alarm Second will become user-configurable with set values.

Configuration options: [Disabled] [Enabled]

Power On By PS/2 Keyboard [Disabled]

Allows you to disable the Power On by PS/2 keyboard function or set specific keys on the PS/2 keyboard to turn on the system. This feature requires an ATX power supply that provides at least 1A on the +5VSB lead.

Configuration options: [Disabled] [Space Bar] [Power Key] [Ctrl-Esc]

4.5.6 Hardware Monitor

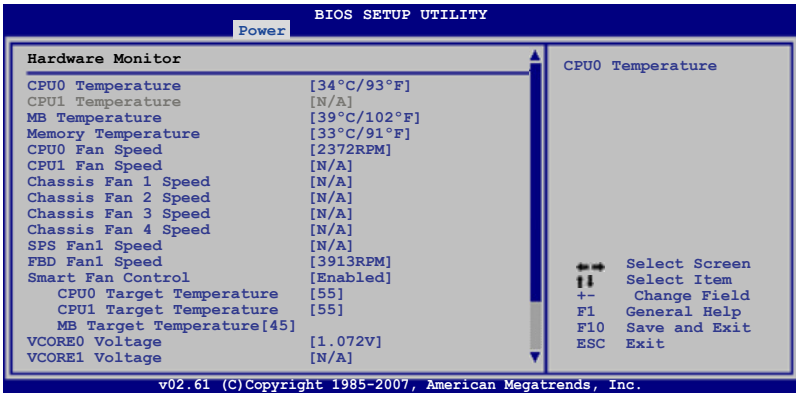

Scroll down to display the following items:

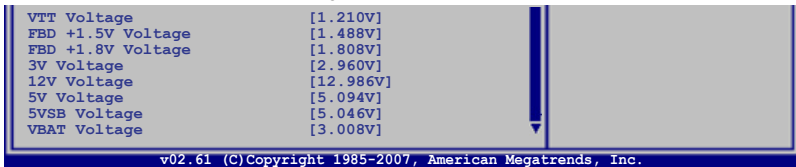

CPU0/1 Temperature [xxx°C/xxx°F]

MB Temperature [xxx°C/xxx°F]

Memory Temperature [xxx°C/xxx°F]

The onboard hardware monitor automatically detects and displays the CPU(s), motherboard and memory temperatures. Select [Ignored] if you do not wish to display the detected temperatures.

CPU0/1 Fan Speed [xxxxRPM] or [Ignored] / [N/A]

The onboard hardware monitor automatically detects and displays the CPU fan(s) speed in rotations per minute (RPM). If the fan is not connected to the motherboard, the field shows [N/A].

Chassis Fan1/2/3/4 Speed [xxxxRPM] or [Ignored] / [N/A]

SPS Fan1 Speed [xxxxRPM] or [Ignored] / [N/A]

FBD Fan1 Speed [xxxxRPM] or [Ignored] / [N/A]

The onboard hardware monitor automatically detects and displays the chassis , SPS, and FBD fan speed in rotations per minute (RPM). If the fan is not connected to the motherboard, the field shows [N/A].

Smart Fan Control [Enabled]

Allows you to enable or disable the Smart Fan Control.

Configuration options: [Disabled] [Enabled]

CPU0/1 Target Temperature [55]

CPU fan 0 or 1 will operate at the maximum speed when CPU 0 or 1 reaches this target temperature.

Configuration options: [50] ~ [70]

MB Target Temperature [45]

System fan will operate at the maximum speed when system reaches this target temperature.

Configuration options: [35] ~ [55]

VCORE0/1 Voltage, VTT Voltage, FBD +1.5V Voltage, FBD +1.8V Voltage, 3V Voltage, 12V Voltage, 5V Voltage, 5VSB Voltage, VBAT Voltage

The onboard hardware monitor automatically detects the voltage output through the onboard voltage regulators. Select [Ignored] if you do not want to detect these items.

4.5.7 PSMI IPMI FRU

Shows the product information.

4.6 Boot menu

The Boot menu items allow you to change the system boot options. Select an item then press <Enter> to display the sub-menu.

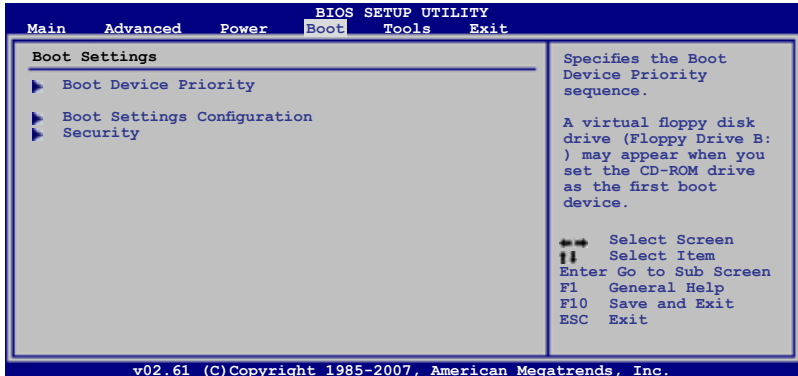

4.6.1 Boot Device Priority

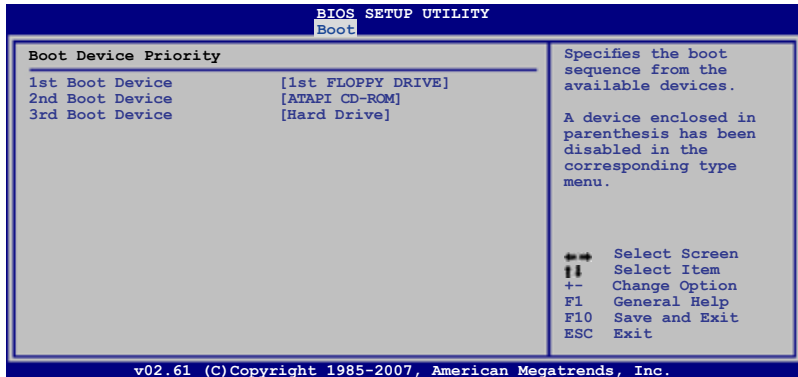

1st ~ xxth Boot Device [xxx Drive]

These items specify the boot device priority sequence from the available devices. The number of device items that appears on the screen depends on the number of devices installed in the system.

Configuration options: [1st FLOPPY DRIVE] [Hard Drive] [ATAPI CD-ROM] [Disabled]

4.6.2 Boot Settings Configuration

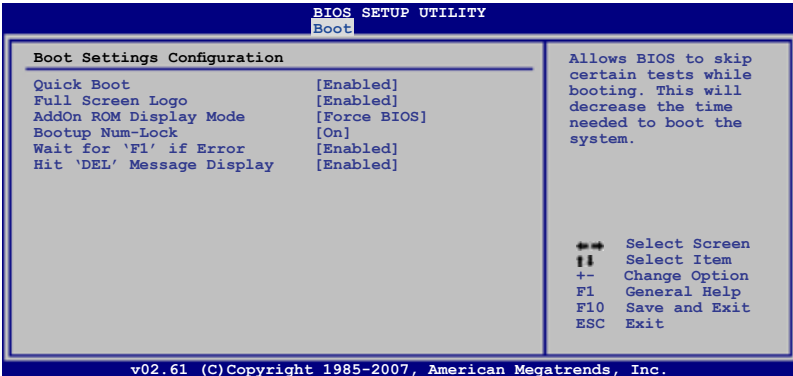

Quick Boot [Enabled]

Enabling this item allows the BIOS to skip some power on self tests (POST) while booting to decrease the time needed to boot the system. When set to [Disabled], BIOS performs all the POST items.

Configuration options: [Disabled] [Enabled]

Full Screen Logo [Enabled]

This allows you to enable or disable the full screen logo display feature.

Configuration options: [Disabled] [Enabled]



Set this item to [Enabled] to use the ASUS MyLogo2™ feature.

AddOn ROM Display Mode [Force BIOS]

Sets the display mode for option ROM.

Configuration options: [Force BIOS] [Keep Current]

Bootup Num-Lock [On]

Allows you to select the power-on state for the NumLock.

Configuration options: [Off] [On]

Wait for 'F1' If Error [Enabled]

When set to [Enabled], the system waits for the <F1> key to be pressed when error occurs.

Configuration options: [Disabled] [Enabled]

Hit 'DEL' Message Display [Enabled]

When set to [Enabled], the system displays the message "Press DEL to run Setup" during POST.

Configuration options: [Disabled] [Enabled]

4.6.3 Security

The Security menu items allow you to change the system security settings. Select an item then press <Enter> to display the configuration options.

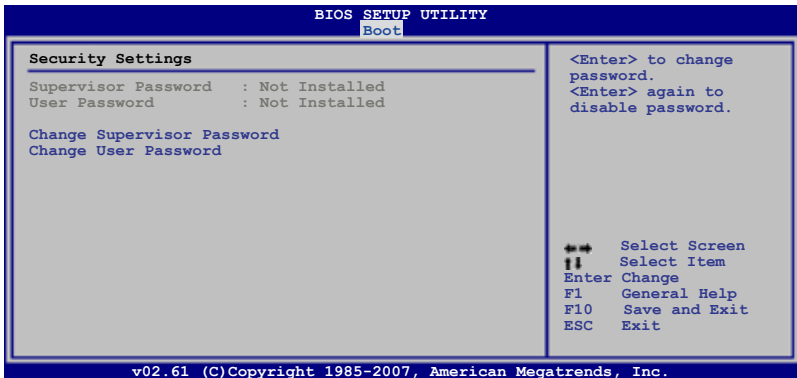

Change Supervisor Password

Select this item to set or change the supervisor password. The Supervisor Password item on top of the screen shows the default Not Installed. After you set a password, this item shows Installed.

To set a Supervisor Password:

1. Select the **Change Supervisor Password** item and press <Enter>.
2. From the password box, type a password composed of at least six letters and/or numbers, then press <Enter>.
3. Confirm the password when prompted.

The message "Password Installed" appears after you successfully set your password.

To change the supervisor password, follow the same steps as in setting a user password.

To clear the supervisor password, select the **Change Supervisor Password** item then press <Enter>. The message "Password Uninstalled" appears.



If you forget your BIOS password, you can clear it by erasing the CMOS Real Time Clock (RTC) RAM. See section **2.6 Jumper** for information on how to erase the RTC RAM.

After you have set a supervisor password, the other items appear to allow you to change other security settings.

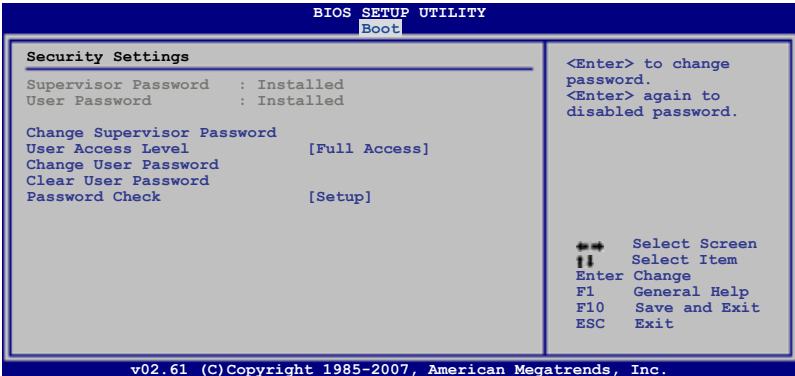

User Access Level [Full Access]

This item allows you to select the access restriction to the Setup items.

Configuration options: [No Access] [View Only] [Limited] [Full Access]

[No Access] prevents user access to the Setup utility.

[View Only] allows access but does not allow change to any field.

[Limited] allows changes only to selected fields, such as Date and Time.

[Full Access] allows viewing and changing all the fields in the Setup utility.

Change User Password

Select this item to set or change the user password. The **User Password** item on top of the screen shows the default **Not Installed**. After you set a password, this item shows **Installed**.

To set a User Password:

1. Select the **Change User Password** item and press <Enter>.
2. On the password box that appears, type a password composed of at least six letters and/or numbers, then press <Enter>.
3. Confirm the password when prompted.

The message "Password Installed" appears after you set your password successfully.

To change the user password, follow the same steps as in setting a user password.

Clear User Password

Select this item to clear the user password.

Password Check [Setup]

When set to [Setup], BIOS checks for user password when accessing the Setup utility. When set to [Always], BIOS checks for user password both when accessing Setup and booting the system. Configuration options: [Setup] [Always]

4.7 Tools menu

The Tools menu items allow you to configure options for special functions. Select an item then press <Enter> to display the sub-menu.



4.7.1 ASUS EZ Flash 2

Allows you to run ASUS EZ Flash 2. When you press <Enter>, a confirmation message appears. Use the left/right arrow key to select between [Yes] or [No], then press <Enter> to confirm your choice. Please see section 4.1.3 **ASUS EZ Flash 2 utility** for details.

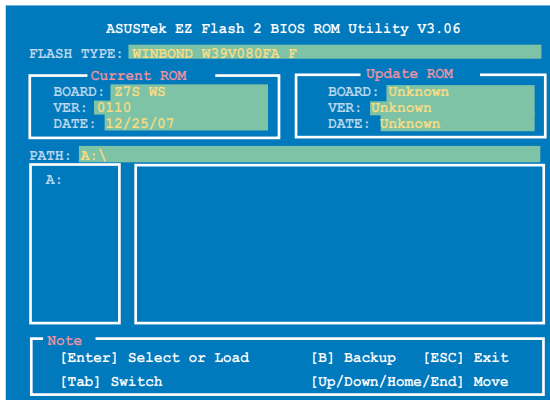

4.7.2 ASUS O.C. Profile

This item allows you to store or load multiple BIOS settings.

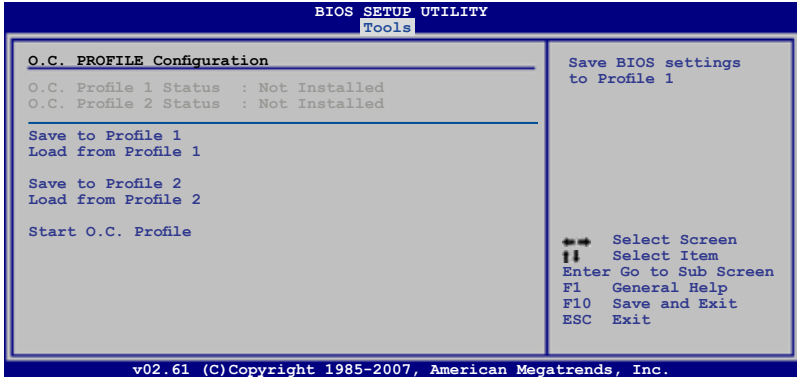

Save to Profile 1/2

Allows you to save the current BIOS file to the BIOS Flash. Press <Enter> to save the file.

Load from Profile 1/2

Allows you to load the previous BIOS settings saved in the BIOS Flash. Press <Enter> to load the file.

Start O.C. Profile

Allows you to run the utility to save and load CMOS. Press <Enter> to run the utility.

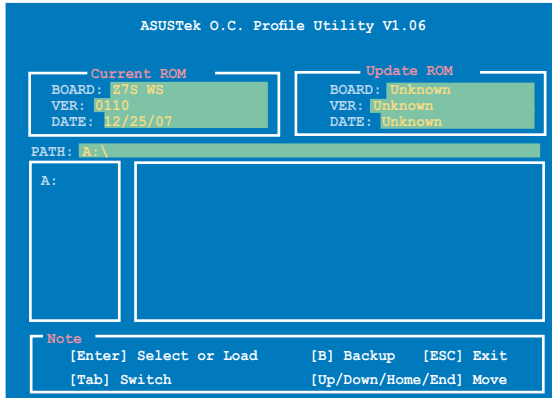

- This function can support devices such as a USB flash disk or a floppy disk with FAT 32/16 format and single partition only.
- DO NOT shut down or reset the system while updating the BIOS to prevent the system boot failure!

4.8 Exit menu

The Exit menu items allow you to load the optimal or failsafe default values for the BIOS items, and save or discard your changes to the BIOS items.

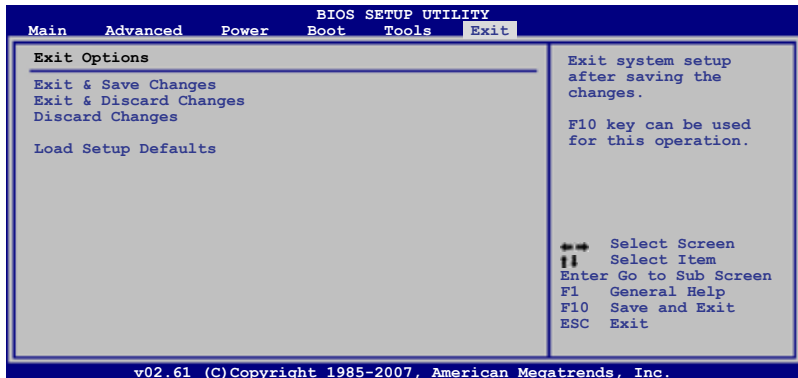

Pressing <Esc> does not immediately exit this menu. Select one of the options from this menu or <F10> from the legend bar to exit.

Exit & Save Changes

Once you are finished making your selections, choose this option from the Exit menu to ensure the values you selected are saved to the CMOS RAM. An onboard backup battery sustains the CMOS RAM so it stays on even when the PC is turned off. When you select this option, a confirmation window appears. Select Ok to save changes and exit.



If you attempt to exit the Setup program without saving your changes, the program prompts you with a message asking if you want to save your changes before exiting. Press <Enter> to save the changes while exiting.

Exit & Discard Changes

Select this option only if you do not want to save the changes that you made to the Setup program. If you made changes to fields other than System Date, System Time, and Password, the BIOS asks for a confirmation before exiting.

Discard Changes

This option allows you to discard the selections you made and restore the previously saved values. After selecting this option, a confirmation appears. Select Ok to discard any changes and load the previously saved values.

Load Setup Defaults

This option allows you to load the default values for each of the parameters on the Setup menus. When you select this option or if you press <F5>, a confirmation window appears. Select Ok to load default values. Select Exit & Save Changes or make other changes before saving the values to the non-volatile RAM.

This chapter describes the contents of the support CD that comes with the motherboard package.

5 Software support

5.1	Installing an operating system	5-1
5.2	Support DVD information	5-1
5.3	Software information	5-9
5.4	RAID configurations	5-23
5.5	Creating a RAID driver disk.....	5-41

5.1 Installing an operating system

This motherboard supports Windows® XP/64-bit XP/Vista/64-bit Vista operating systems (OS). Always install the latest OS version and corresponding updates to maximize the features of your hardware.



- Motherboard settings and hardware options vary. Use the setup procedures presented in this chapter for reference only. Refer to your OS documentation for detailed information.
- Make sure that you install Windows® XP Service Pack 2 or later versions before installing the drivers for better compatibility and system stability.

5.2 Support DVD information

The support DVD that came with the motherboard package contains the drivers, software applications, and utilities that you can install to avail all motherboard features.



The contents of the support DVD are subject to change at any time without notice. Visit the ASUS website(www.asus.com) for updates.

5.2.1 Running the support DVD

Place the support DVD to the optical drive. The DVD automatically displays the Drivers menu if Autorun is enabled in your computer.



Click an icon to display support DVD/motherboard information

Click an item to install



If Autorun is NOT enabled in your computer, browse the contents of the support DVD to locate the file ASSETUP.EXE from the BIN folder. Double-click the ASSETUP.EXE to run the DVD.

5.2.2 Drivers menu

The drivers menu shows the available device drivers if the system detects installed devices. Install the necessary drivers to activate the devices.



ASUS InstAll - Installation Wizard for Drivers

Installs all of the drivers through the Installation Wizard.

Intel Chipset Inf Update Program

Installs the Intel® chipset Inf update program.

Realtek Audio Driver

Installs the Realtek® ALC 888S audio driver and application.

JMicron JMB36X Controller Driver

Installs the JMicron® JMB36X Serial ATA RAID controller driver.

Marvell Yukon Gigabit Ethernet Driver

Installs the Marvell® Gigabit Ethernet LAN driver.

USB 2.0 Driver

Installs the Universal Serial Bus 2.0 (USB 2.0) driver.

5.2.3 Utilities menu

The Utilities menu shows the applications and other software that the motherboard supports.



Click to display the next page



Click to return to the previous page

ASUS InstAll - Installation Wizard for Utilities

Installs all of the utilities through the Installation Wizard.

Marvell Yukon VCT Application

Installs the Marvell® Yukon Virtual Cable Tester (VCT) Application.

Marvell Yukon CPA Application

Installs the Marvell® Yukon CPA Application.

ASUS PC Probe II

This smart utility monitors the fan speed, CPU temperature, and system voltages, and alerts you of any detected problems. This utility helps you keep your computer in healthy operating condition.

ASUS AI Nap

ASUS AI Nap lets users instantly turn on/off the PC without terminating the tasks.

ASUS Update

Allows you to download the latest version of the BIOS from the ASUS website.



Before using the ASUS Update, make sure that you have an Internet connection so you can connect to the ASUS website.

Adobe Acrobat Reader V7.0

Installs the Adobe® Acrobat® Reader that allows you to open, view, and print documents in Portable Document Format (PDF).

Microsoft DirectX 9.0c

Installs the Microsoft® DirectX 9.0 driver. The Microsoft DirectX® 9.0 is a multimedia technology that enhances computer graphics and sound. DirectX® improves the multimedia features of your computer so you can enjoy watching TV and movies, capturing videos, or playing games in your computer. Visit the Microsoft website (www.microsoft.com) for updates.

WinDVD Copy5 Trial

Installs the InterVideo DVD Copy5 trial version.

InterVideo MediaOne Gallery

Installs the media library and all-in-one software.

Ulead PhotoImpact 12 SE

Installs the PhotoImpact image editing software.

CyberLink PowerBackup

Installs CyberLink PowerBackup to back up and restore your data easily.

Corel Snapfire Plus SE

Installs Corel Snapfire Plus SE.

Anti-Virus Utility

The anti-virus application detects and protects your computer from viruses that destroys data.

5.2.4 Make Disk menu

The Make Disk menu contains items to create Intel® ESB2 AHCI / RAID driver disk / JMicron® JMB36X SATA / RAID driver disk.



Intel(R) ESB2 AHCI/RAID 32bit/64bit Driver

Allows you to create an Intel® ESB2 AHCI/RAID driver disk for a 32/64-bit system.

JMicron JMB36X 32bit/64bit SATA/RAID Driver

Allows you to create a JMicron® JMB36X SATA/RAID driver disk for a 32/64-bit system.

5.2.5 Manual menu

The Manual menu contains a list of supplementary user manuals. Click an item to open the folder of the user manual.



Most user manual files are in Portable Document Format (PDF). Install the Adobe® Acrobat® Reader from the Utilities tab before opening a user manual file.



5.2.6 ASUS Contact information

Click the Contact tab to display the ASUS contact information. You can also find this information on the inside front cover of this user guide.

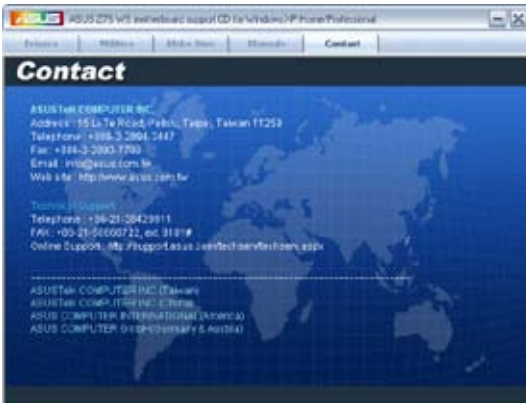

7. When the logo images appear on the right window pane, select an image to enlarge by clicking on it.

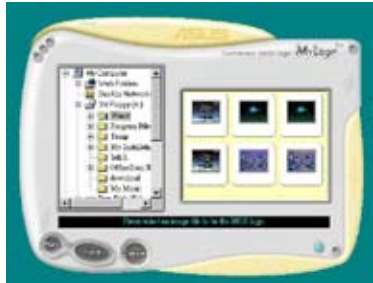

8. Adjust the boot image to your desired size by selecting a value on the Ratio box.



9. When the screen returns to the ASUS Update utility, flash the original BIOS to load the new boot logo.
10. After flashing the BIOS, restart the computer to display the new boot logo during POST.

5.3.2 AI NET2

The AI NET2 features the Marvell® Virtual Cable Tester™ (VCT). VCT is a cable diagnostic utility that reports LAN cable faults and shorts using the Time Domain Reflectometry (TDR) technology. The VCT detects and reports open and shorted cables, impedance mismatches, pair swaps, pair polarity problems, and pair skew problems of up to 64 ns at one meter accuracy.

The VCT feature reduces networking and support costs through a highly manageable and controlled network system. This utility can be incorporated in the network systems software for ideal field support as well as development diagnostics.

Using the Virtual Cable Tester™

To use the the Marvell® Virtual Cable Tester™ utility:

1. Launch the VCT utility from the Windows® desktop by clicking **Start > All Programs > Marvell > Virtual Cable Tester**.
2. Click **Virtual Cable Tester** from the menu to display the screen below.

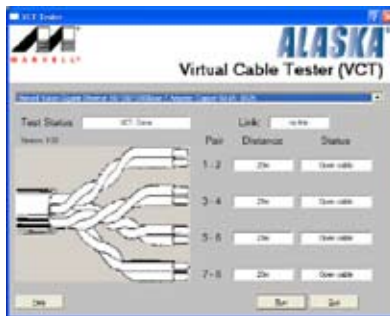

3. Click the **Run** button to perform a cable test.



- The VCT utility only tests Ethernet cables connected to Gigabit LAN port(s).
- The Run button on the Virtual Cable Tester™ main window is disabled if no problem is detected on the LAN cable(s) connected to the LAN port(s).
- If you want the system to check the status of the LAN cable before entering the OS, enable the item Post Check LAN Cable in the BIOS Setup.

5.3.3 ASUS PC Probe II

PC Probe II is a utility that monitors the computer's vital components, and detects and alerts you of any problem with these components. PC Probe II senses fan rotations, CPU temperature, and system voltages, among others. Because PC Probe II is software-based, you can start monitoring your computer the moment you turn it on. With this utility, you are assured that your computer is always at a healthy operating condition.

Installing PC Probe II

To install PC Probe II on your computer:

1. Place the Support DVD to the optical drive. The Drivers installation tab appears if your computer has an enabled Autorun feature.



If Autorun is not enabled in your computer, browse the contents of the Support DVD to locate the setup.exe file from the ASUS PC Probe II folder. Double-click the setup.exe file to start installation.

2. Click the Utilities tab, then click ASUS PC Probe II.
3. Follow the screen instructions to complete installation.

Launching PC Probe II

You can launch the PC Probe II right after installation or anytime from the Windows® desktop.

To launch the PC Probe II from the Windows® desktop, click **Start > All Programs > ASUS > PC Probe II > PC Probe II v1.xx.xx**. The PC Probe II main window appears.

After launching the application, the PC Probe II icon appears in the Windows® taskbar. Click this icon to close or restore the application.









Using PC Probe II

Main window

The PC Probe II main window allows you to view the current status of your system and change the utility configuration. By default, the main window displays the Preference section. You can close or restore the Preference section by clicking on the triangle on the main window right handle.



Click to close the Preference panel

Button	Function
	Opens the Configuration window
	Opens the Report window
	Opens the Desktop Management Interface window
	Opens the Peripheral Component Interconnect window
	Opens the Windows Management Instrumentation window
	Opens the hard disk drive, memory, CPU usage window
	Shows/Hides the Preference section
	Minimizes the application
	Closes the application

Sensor alert

When a system sensor detects a problem, the main window right handle turns red, as the illustrations below show.



When displayed, the monitor panel for that sensor also turns red. Refer to the Monitor panels section for details.

Preference

You can customize the application using the Preference section in the main window. Click the box before each preference to activate or deactivate.

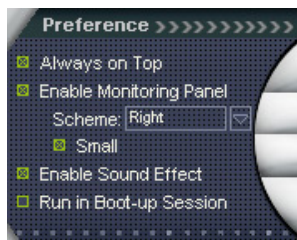

Hardware monitor panels

The hardware monitor panels display the current value of a system sensor such as fan rotation, CPU temperature, and voltages.

The hardware monitor panels come in two display modes: hexagonal (large) and rectangular (small). When you check the Enable Monitoring Panel option from the Preference section, the monitor panels appear on your computer's desktop.



Large display

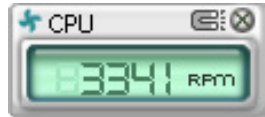

Small display

Changing the monitor panels position

To change the position of the monitor panels in the desktop, click the arrow down button of the Scheme options, then select another position from the list box. Click **OK** when finished.





Moving the monitor panels

All monitor panels move together using a magnetic effect. If you want to detach a monitor panel from the group, click the horseshoe magnet icon. You can now move or reposition the panel independently.



Adjusting the sensor threshold value

You can adjust the sensor threshold value in the monitor panel by clicking the  or  buttons. You can also adjust the threshold values using the Config window.

You cannot adjust the sensor threshold values in a small monitoring panel.

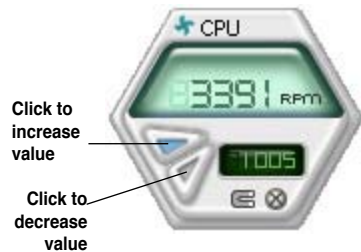

Monitoring sensor alert

The monitor panel turns red when a component value exceeds or is lower than the threshold value. Refer to the illustrations below.



Large display



Small display

WMI browser

Click **WMI** to display the WMI (Windows Management Instrumentation) browser. This browser displays various Windows® management information. Click an item from the left panel to display on the right panel. Click the plus sign (+) before WMI Information to display the available information.



You can enlarge or reduce the browser size by dragging the bottom right corner of the browser.

DMI browser

Click **DMI** to display the DMI (Desktop Management Interface) browser. This browser displays various desktop and system information. Click the plus sign (+) before DMI Information to display the available information.



PCI browser

Click **PCI** to display the PCI (Peripheral Component Interconnect) browser. This browser provides information on the PCI devices installed on your system. Click the plus sign (+) before the PCI Information item to display available information.

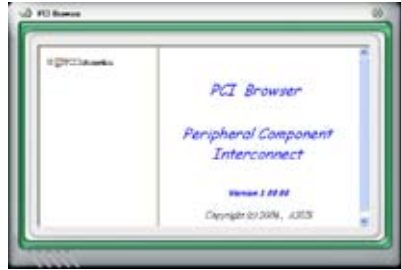

Usage

The Usage browser displays real-time information on the CPU, hard disk drive space, and memory usage. Click **USAGE** to display the Usage browser.

CPU usage

The CPU tab displays real-time CPU usage in line graph representation. If the CPU has an enabled Hyper-Threading, two separate line graphs display the operation of the two logical processors.



Hard disk drive space usage

The Hard Disk tab displays the used and available hard disk drive space. The left panel of the tab lists all logical drives. Click a hard disk drive to display the information on the right panel. The pie chart at the bottom of the window represents the used (blue) and the available HDD (pink).



Memory usage

The Memory tab shows both used and available physical memory. The pie chart at the bottom of the window represents the used (blue) and the available physical memory.



Configuring PC Probe II

Click  to view and adjust the sensor threshold values.

The Config window has two tabs: Sensor/Threshold and Preference. The Sensor/Threshold tab enables you to activate the sensors or to adjust the sensor threshold values. The Preference tab allows you to customize sensor alerts, or change the temperature scale.

The screenshot shows the 'Config' window with the 'Sensor/Threshold' tab selected. It features a table with columns for 'Enabled', 'Sensor Name', 'Normal Value', 'Current Value', and 'Threshold'. Below the table are buttons for 'Default', 'Apply', 'Cancel', 'Save As', and 'Load'. Lines connect these buttons to descriptive text below the window.

Enabled	Sensor Name	Normal Value	Current Value	Threshold
<input checked="" type="checkbox"/>	CPU		43	80 °C
<input checked="" type="checkbox"/>	MB		34	45 °C

Buttons: Default, Apply, Cancel, Save As, Load

Annotations:

- Default: Loads the default threshold values for each sensor
- Apply: Applies your changes
- Cancel: Cancels or ignores your changes
- Save As: Saves your configuration
- Load: Loads your saved configuration

5.3.4 ASUS AI Nap

This feature allows you to minimize the power consumption of your computer whenever you are away. Enable this feature for minimum power consumption and a quieter system operation.

After installing AI Suite from the bundled Support DVD, you can launch the utility by double-clicking the AI Suite icon on the Windows OS taskbar and click the AI Nap button on the AI Suite main window.

Click **Yes** on the confirmation screen.

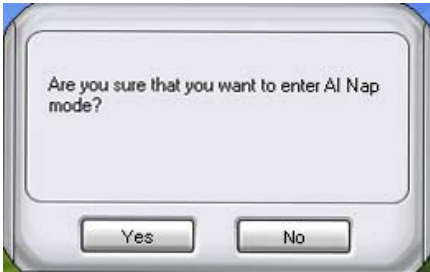

To exit AI Nap mode, press the system power or mouse button then click **Yes** on the confirmation screen.

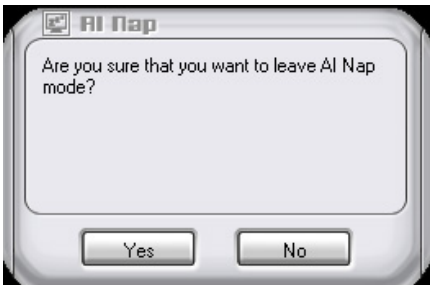

To switch the power button functions from AI Nap to shutting down, just right click the **AI Suite** icon on the OS taskbar, select **AI Nap** and click **Use power button**. Unclick the the item to switch the function back.

5.3.5 Audio configurations

The Realtek® ALC888 audio CODEC provides 8-channel audio capability to deliver the ultimate audio experience on your computer. The software provides Jack-Sensing function, S/PDIF Out support, and interrupt capability. The ALC888 also includes the Realtek® proprietary UAJ® (Universal Audio Jack) technology for all audio ports, eliminating cable connection errors and giving users plug and play convenience.

Follow the installation wizard to install the Realtek® Audio Driver from the support DVD that came with the motherboard package.

If the Realtek audio software is correctly installed, you will find the Realtek HD Audio Manager icon on the taskbar.

From the taskbar, double-click on the SoundEffect icon to display the Realtek HD Audio Manager.



Realtek HD Audio Manager



Information

Click the information button () to display information about the audio driver version, DirectX version, audio controller, audio codec, and language setting.



Minimize

Click the minimize button () to minimize the window.

Exit

Click the exit button () to exit the Realtek HD Audio Manager.

Configuration options

Click any of the tabs in this area to configure your audio settings.

Sound Effect

The Realtek® ALC888 Audio CODEC allows you to set your listening environment, adjust the equalizer, set the karaoke, or select pre-programmed equalizer settings for your listening pleasure.

To set the sound effect options:

1. From the Realtek HD Audio Manager, click the Sound Effect tab.
2. Click the shortcut buttons or the drop-down menus for options on changing the acoustic environment, adjust the equalizer, or set the karaoke to your desired settings.
3. Click  to effect the Sound Effect settings and exit.



Mixer

The Mixer option allows you to configure audio output (playback) volume and audio input (record) volume.

To set the mixer options:

1. From the Realtek HD Audio Manager, click the Mixer tab.
2. Turn the volume buttons to adjust the Playback and/or Record volume.



The Mixer option activates voice input from all channels by default. Make sure to set all channels to mute (M) if you do not want voice input.

3. Make adjustments to Wave, SW Synth, Front, Rear, Subwoofer, CD volume, Mic volume, Line Volume, and Stereo mix by clicking the control tabs and dragging them up and down until you get the desired levels.
4. Click **OK** to effect the Mixer settings and exit.

Audio I/O

The Audio I/O option allows you to configure your input/output settings.

To set the Audio I/O options:

1. From the Realtek HD Audio Manager, click the Audio I/O tab.
2. Click the drop-down menu to select the channel configuration.
3. The control settings window displays the status of connected devices. Click **X** for analog and digital options.
4. Click <OK> to effect the Audio I/O settings and exit



Microphone

The Microphone option allows you configure your input/output settings and to check if your audio devices are connected properly.

To set the Microphone options:

1. From the Realtek HD Audio Manager, click the Microphone tab.
2. Click the **Noise Suppression** option button to reduce the static background noise when recording.
3. Click the **Acoustic Echo Cancellation** option button to reduce the echo from the front speakers when recording.
4. Click  to effect the Microphone settings and exit.



3D Audio Demo

The 3D Audio Demo option gives you a demonstration of the 3D audio feature.

To start the 3D Audio Demo:

1. From the Realtek HD Audio Manager, click the 3D Audio Demo tab.
2. Click the option buttons to change the sound, moving path, or environment settings.
3. Click  to test your settings.
4. Click  to effect the 3D Audio Demo settings and exit.



5.4 RAID configurations

The motherboard comes with two RAID controllers that allow you to configure Serial ATA hard disk drives as RAID sets.

- The **Intel® ESB2E Southbridge RAID** includes a high performance SATA RAID controller that supports RAID 0, 1, and 5 for six independent Serial ATA channels.
- The **JMicron® JMB363 RAID** includes a high performance SATA RAID controller that supports RAID 0, 1, and JBOD for two external Serial ATA channels.

5.4.1 RAID definitions

RAID 0 (Data striping) optimizes two identical hard disk drives to read and write data in parallel, interleaved stacks. Two hard disks perform the same work as a single drive but at a sustained data transfer rate, double that of a single disk alone, thus improving data access and storage. Use of two new identical hard disk drives is required for this setup.

RAID 1 (Data mirroring) copies and maintains an identical image of data from one drive to a second drive. If one drive fails, the disk array management software directs all applications to the surviving drive as it contains a complete copy of the data in the other drive. This RAID configuration provides data protection and increases fault tolerance to the entire system. Use two new drives or use an existing drive and a new drive for this setup. The new drive must be of the same size or larger than the existing drive.

RAID 5 stripes both data and parity information across three or more hard disk drives. Among the advantages of RAID 5 configuration include better HDD performance, fault tolerance, and higher storage capacity. The RAID 5 configuration is best suited for transaction processing, relational database applications, enterprise resource planning, and other business systems. Use a minimum of three identical hard disk drives for this setup.

JBOD (Spanning) stands for Just a Bunch of Disks and refers to hard disk drives that are not yet configured as a RAID set. This configuration stores the same data redundantly on multiple disks that appear as a single disk on the operating system. Spanning does not deliver any advantage over using separate disks independently and does not provide fault tolerance or other RAID performance benefits.

Intel® Matrix Storage. The Intel® Matrix Storage technology supported by the ESB2E chip allows you to create a RAID 0, RAID 1, and RAID 5 function to improve both system performance and data safety. You can also combine two RAID sets to get higher performance, capacity, or fault tolerance provided by the difference RAID function. For example, RAID 0 and RAID 1 set can be created by using only two identical hard disk drives.



If you want to boot the system from a hard disk drive included in a created RAID set, copy first the RAID driver from the support DVD to a floppy disk before you install an operating system to the selected hard disk drive. Refer to section 5.5 **Creating a RAID driver disk** for details.

5.4.2 Installing Serial ATA hard disks

The motherboard supports Serial ATA hard disk drives. For optimal performance, install identical drives of the same model and capacity when creating a disk array.

To install the SATA hard disks for a RAID configuration:

1. Install the SATA hard disks into the drive bays.
2. Connect the SATA signal cables.
3. Connect a SATA power cable to the power connector on each drive.

5.4.3 Intel® RAID configurations

This motherboard supports RAID 0, RAID 1, RAID 5, and Intel® Matrix Storage configurations for Serial ATA hard disks drives through the Intel® ESB2E Southbridge chip.

Setting the RAID item in BIOS

You must set the RAID item in the BIOS Setup before you can create a RAID set(s). To do this:

1. Enter the BIOS Setup during POST.
2. Go to the Main Menu, select **Storage Configuration**, then press <Enter>.
3. Select the item **Configure SATA as**, then press <Enter> to display the configuration options.
4. Select **RAID** from the **Configure SATA as** item options, then press <Enter>.
5. Save your changes, then exit the BIOS Setup.



See Chapter 4 for details on entering and navigating through the BIOS Setup.

Intel® Matrix Storage Manager Option ROM Utility

The Intel® Matrix Storage Manager Option ROM utility allows you to create RAID 0, RAID 1, and RAID 5 set(s) from Serial ATA hard disk drives that are connected to the Serial ATA connectors supported by the Southbridge.

To enter the Intel® Matrix Storage Manager Option ROM utility:

1. Install all the Serial ATA hard disk drives.
2. Turn on the system.
3. During POST, press <Ctrl+I> to display the utility main menu.

```
Intel(R) Matrix Storage Manager Option ROM v5.0.0.1032 ICH7R wRAID5
Copyright(C) 2003-05 Intel Corporation. All Rights Reserved.

----- [ MAIN MENU ] -----
1. Create RAID Volume
2. Delete RAID Volume
3. Reset Disks to Non-RAID
4. Exit

----- [ DISK/VOLUME INFORMATION ] -----

RAID Volumes:
None defined.

Physical Disks:
Port Drive Model          Serial #          Size          Type/Status (Vol ID)
0  XXXXXXXXXXXX          XXXXXXXX          XX.XXGB      Non-RAID Disk
1  XXXXXXXXXXXX          XXXXXXXX          XX.XXGB      Non-RAID Disk
2  XXXXXXXXXXXX          XXXXXXXX          XX.XXGB      Non-RAID Disk
3  XXXXXXXXXXXX          XXXXXXXX          XX.XXGB      Non-RAID Disk

[↑↓]-Select          [ESC]-Exit          [ENTER]-Select Menu
```

The navigation keys at the bottom of the screen allow you to move through the menus and select the menu options.



The RAID BIOS setup screens shown in this section are for reference only and may not exactly match the items on your screen.

Creating a RAID 0 set (striped)

To create a RAID 0 set:

1. From the utility main menu, select 1. Create RAID Volume, then press <Enter>. This screen appears.

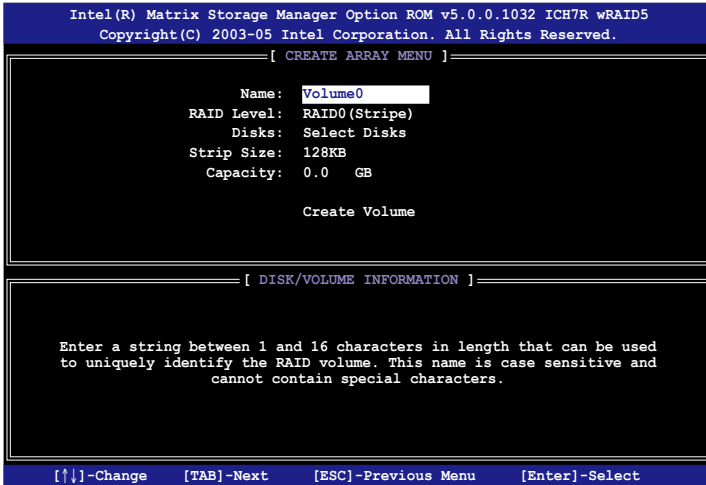

2. Enter a name for the RAID 0 set, then press <Enter>.
3. When the RAID Level item is highlighted, press the up/down arrow key to select RAID 0(Stripe), then press <Enter>.
4. When the Disks item is highlighted, press <Enter> to select the hard disk drives to configure as RAID. This pop-up screen appears.

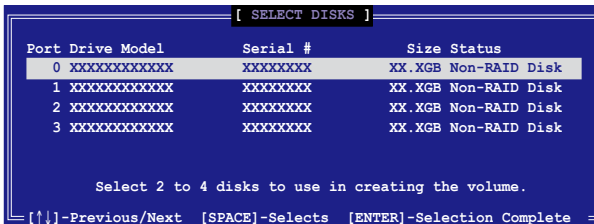

5. Use the up/down arrow key to highlight a drive, then press <Space> to select. A small triangle marks the selected drive. Press <Enter> after completing your selection.

6. Use the up/down arrow key to select the stripe size for the RAID 0 array, then press <Enter>. The available stripe size values range from 4 KB to 128 KB. The default stripe size is 128 KB.



TIP: We recommend a lower stripe size for server systems, and a higher stripe size for multimedia computer systems used mainly for audio and video editing.

7. Key in the RAID volume capacity that you want, then press <Enter>. The default value indicates the maximum allowed capacity.
8. Press <Enter> when the Create Volume item is highlighted. This warning message appears.

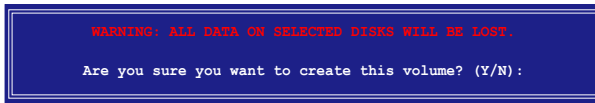

9. Press <Y> to create the RAID volume and return to the main menu, or <N> to go back to the Create Volume menu.

Creating a RAID 1 set (mirrored)

To create a RAID 1 set:

1. From the utility main menu, select 1. Create RAID Volume, then press <Enter>. This screen appears.

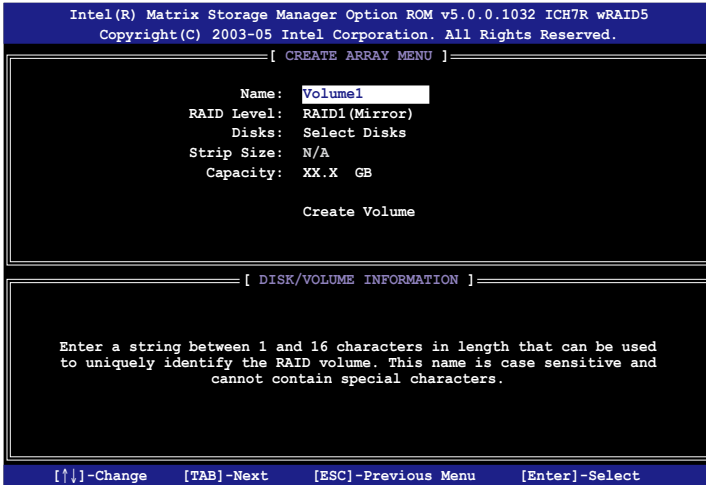

2. Enter a name for the RAID 1 set, then press <Enter>.
3. When the RAID Level item is highlighted, press the up/down arrow key to select RAID 1(Mirror), then press <Enter>.
4. When the Capacity item is highlighted, key in the RAID volume capacity that you want, then press <Enter>. The default value indicates the maximum allowed capacity.
5. Press <Enter> when the Create Volume item is highlighted. This warning message appears.

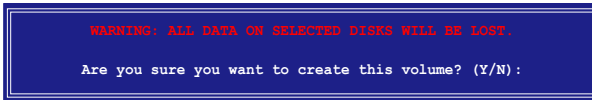

6. Press <Y> to create the RAID volume and return to main menu or <N> to go back to Create Volume menu.

Creating a RAID 5 set (parity)

To create a RAID 5 set:

1. From the utility main menu, select 1. Create RAID Volume, then press <Enter>. This screen appears.

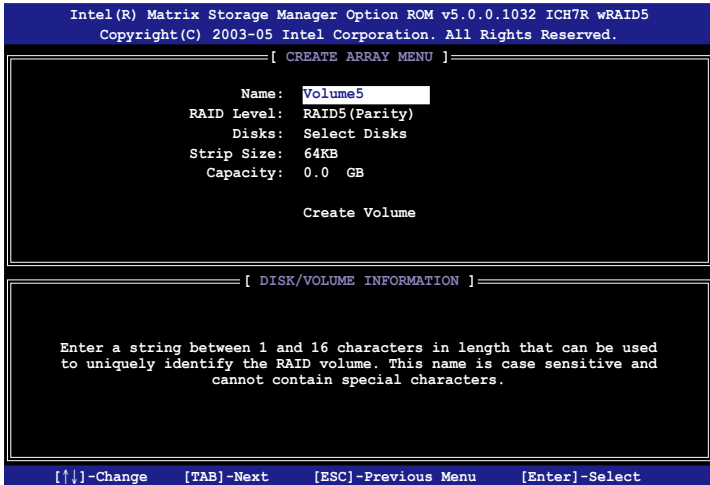

2. Enter a name for the RAID 5 set, then press <Enter>.
3. When the RAID Level item is highlighted, press the up/down arrow key to select RAID 5(Parity), then press <Enter>.
4. The Disks item is highlighted, press <Enter> to select the hard disk drives to configure as RAID. The following pop-up screen appears.

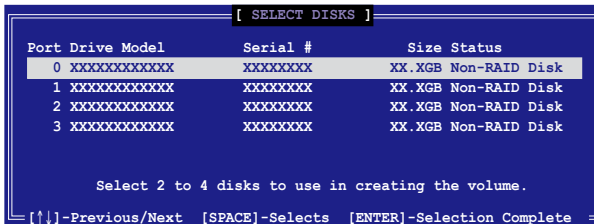

5. Use the up/down arrow key to highlight the drive you want to set, then press <Space> to select. A small triangle marks the selected drive. Press <Enter> after completing your selection.
6. When the Stripe Size item is highlighted, press the up/down arrow key to select the stripe size for the RAID 5 array, then press <Enter>. The available stripe size values range from 4 KB to 128 KB. The default stripe size is 64 KB.



TIP: We recommend a lower stripe size for server systems, and a higher stripe size for multimedia computer systems used mainly for audio and video editing.

7. Key in the RAID volume capacity that you want, then press <Enter> when the Capacity item is highlighted. The default value indicates the maximum allowed capacity.
8. Press <Enter> when the Create Volume item is highlighted. This warning message appears.

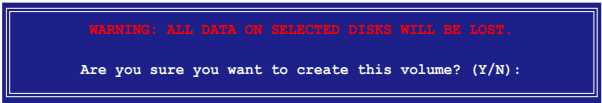

9. Press <Y> to create the RAID volume and return to the main menu or <N> to go back to the Create Volume menu.

Deleting a RAID set



Take caution when deleting a RAID set. You will lose all data on the hard disk drives when you delete a RAID set.

To delete a RAID set:

1. From the utility main menu, select 2. Delete RAID Volume, then press <Enter> to display this screen.

```
Intel(R) Matrix Storage Manager Option ROM v5.0.0.1032 ICH7R wRAID5
Copyright(C) 2003-05 Intel Corporation. All Rights Reserved.

[ DELETE VOLUME MENU ]

Name          Level          Drives      Capacity   Status   Bootable
Volume0       RAIDX(XXXXX)  X           XXX.XGB   Normal  Yes

[ HELP ]

Deleting a volume will destroy the volume data on the drive(s) and
cause any member disks to become available as non-RAID disks.

WARNING: EXISTING DATA WITHIN THIS VOLUME WILL BE LOST AND NON-RECOVERABLE.

[↑↓]-Select      [ESC]-Previous Menu  [Del]-Delete Volume
```

2. Use the up/down arrow key to select the RAID set you want to delete, then press . This window appears.

```
[ DELETE VOLUME VERIFICATION ]

ALL DATA IN THE VOLUME WILL BE LOST!

Are you sure you want to delete volume "VolumeX"? (Y/N):
```

3. Press <Y> to delete the RAID set and return to the utility main menu; otherwise, press <N> to return to the Delete Volume menu.

Resetting Disks to Non-RAID



Take caution before you reset a RAID volume HDD to non-RAID. Resetting a RAID volume HDD deletes all internal RAID structure on the drive.

To reset a RAID set hard disk drive:

1. From the utility main menu, select 3. Reset Disks to Non-RAID, then press <Enter> to display this screen.

```
[ RESET RAID DATA ]

Resetting RAID data will remove internal RAID structures
from the selected RAID disks. By removing these structures,
the drive will revert back to a non-RAID disk.

WARNING: Resetting a disk causes all data on the disk to be lost.

Port Drive Model          Serial #          Size Status
-----
0 XXXXXXXXXXXXX          XXXXXXXX         XX.XGB Member Disk
1 XXXXXXXXXXXXX          XXXXXXXX         XX.XGB Member Disk

Select the disks that should be reset.

[↑,↓]-Previous/Next [SPACE]-Selects [ENTER]-Selection Complete
```

2. Use the up/down arrow key to highlight the RAID set drive you want to reset, then press <Space> to select.
3. Press <Enter> to reset the RAID set drive. A confirmation message appears.
4. Press <Y> to reset the drive or press <N> to return to the utility main menu.

5.4.4 JMicron® RAID Configuration

The JMicron® Serial ATA controller allows you to configure RAID 0, RAID 1 and JBOD sets on the external Serial ATA hard disk drives.

Before creating a RAID set

Prepare the following items:

1. Two SATA HDDs, preferably with the same model and capacity.
2. A write-enabled floppy disk (Windows XP). A write-enabled floppy disk or a USB flash disk drive (Windows Vista)
3. Microsoft® Windows® OS installation disk (Windows XP)
4. Motherboard support CD with JMB363 driver

Complete the following steps before you create a RAID set:

1. Install the two external Serial ATA hard disk drives on your system.
2. Set the **Controller Mode** item in the BIOS to [RAID]. See section **4.4.4 Onboard Device Configuration** for details.

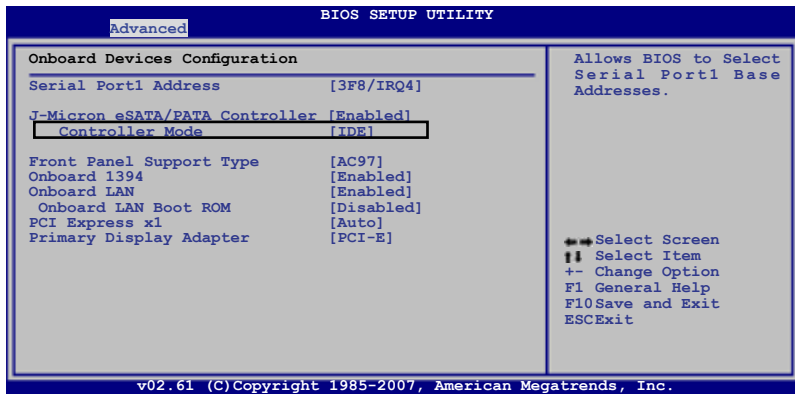

3. Enter the JMB363 RAID BIOS utility to set up your RAID configuration.
4. Create a JMB363 RAID driver disk for Windows® OS installation. See section **5.5 Creating a RAID driver disk** for details.
5. Install the JMB363 driver after the Windows® OS had been installed.



Always install the JMB363 driver before creating RAID sets.

Entering the JMB363 RAID BIOS utility

1. During POST, press <Ctrl-J> to enter the JMB363 RAID BIOS menu.

```
JMicron Technology Corp. PCI-to-SATA II/IDE RAID Controller BIOS v0.97
Copyright (C) 2004-2005 JMicron Technology      http://www. jmicron.com

HDD0 : HDS722516VLSA80                          164 GB Non-RAID
HDD1 : HDS722516DLA380                          164 GB Non-RAID

Press <Ctrl-J> to enter RAID Setup Utility...
```

2. The main JMB363 RAID BIOS menu appears.
3. Use the arrow keys to move the color bar and navigate through the items.

```
JMicron Technology Corp. PCI-to-SATA II/IDE RAID Controller BIOS v0.97

[Main Menu]
Create RAID Disk Drive
Delete RAID Disk Drive
Revert HDD to Non-RAID
Solve Mirror Conflict
Rebuild Mirror Drive
Save and Exit Setup
Exit Without Saving

[Hard Disk Drive List]
Model Name      Capacity  Type/Status
HDD0: HDS722516VLSA80  164 GB  Non-RAID
HDD1: HDS722516DLA380  164 GB  Non-RAID

[RAID Disk Drive List]

[<--> TAB]-Switch Window  [↑↓]-Select Item  [ENTER]-Action  [ESC]-Exit
```

Creating a RAID set

1. In the main JMB363 RAID BIOS menu, highlight Create RAID Disk Drive using the up/down arrow key then press <Enter>.

```
[Main Menu]
Create RAID Disk Drive
Delete RAID Disk Drive
Revert HDD to Non-RAID
Solve Mirror Conflict
Rebuild Mirror Drive
Save and Exit Setup
Exit Without Saving
```

- When the Level item is highlighted, use the up/down arrow key to select the RAID set that you want to create.



- When the Disks item is highlighted, use the up/down arrow key to highlight an HDD that you want to belong to the RAID set, then press the space bar to confirm selection. Repeat the process until the HDDs are selected.

A selected HDD shows a ► sign before it.

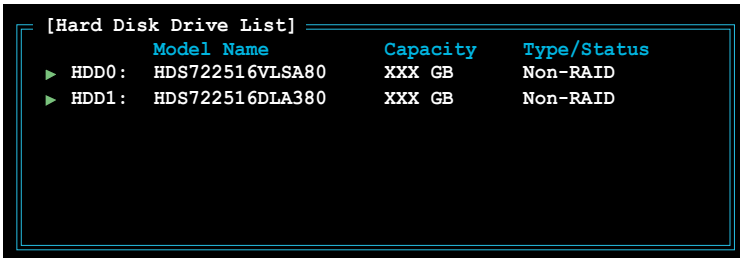

- Key in the RAID volume capacity. Use the up/down arrow to choose the block size. The default value indicates the maximum allowed capacity.



- When done, press <Enter> to confirm the creation of the RAID set. A dialogue box appears to confirm the action. Press <Y> to confirm; otherwise, press <N>.

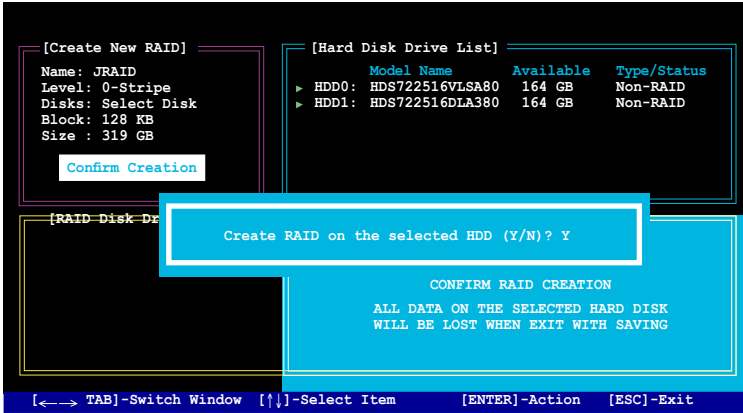

Pressing <Y> deletes all the data in the HDDs.

- The following screen appears, displaying the relevant information about the RAID set you created.

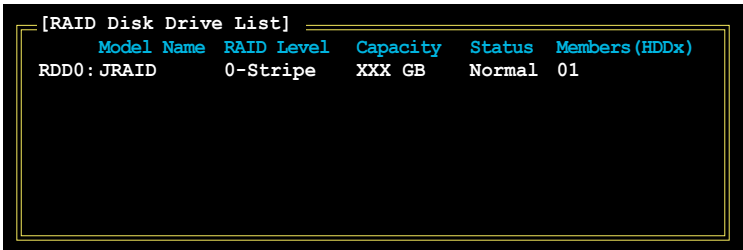

Deleting a RAID set

1. In the main JMB363 RAID BIOS menu, highlight Delete RAID Disk Drive using the up/down arrow key then press <Enter>.

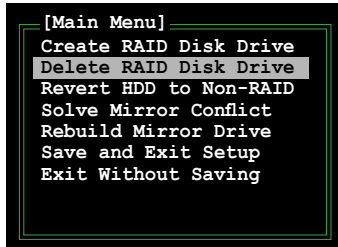

2. Use the space bar to select the RAID set you want to delete. A selected set shows a ► sign before it. Press the key to delete the set.
3. A dialogue box appears to confirm the action. Press <Y> to confirm; otherwise, press <N>.

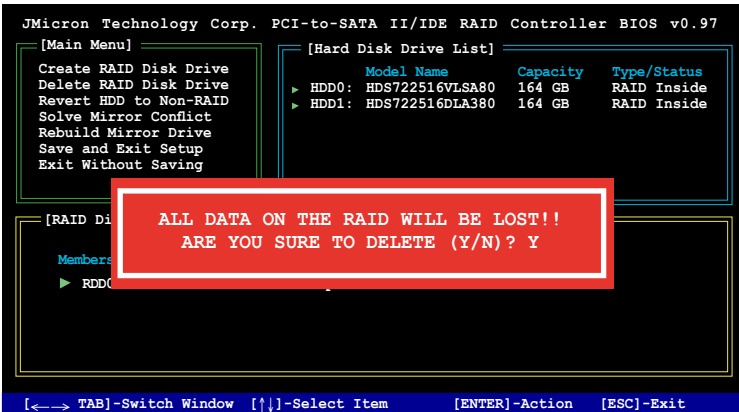

Pressing <Y> deletes all the data in the HDDs.

Resetting disks to non-RAID



- An HDD that has been previously configured as part of another RAID set in another platform is called a broken RAID HDD. When you install a broken RAID HDD, you cannot select this HDD when configuring a RAID set through the JMB363 utility.
- If you still want to use this broken RAID HDD as part of the RAID set configured through the JMB363, you may do so by resetting the disk to non-RAID. You will, however, lose all data and previous RAID configurations.

To reset disks to non-RAID:

1. In the main JMB363 RAID BIOS menu, highlight Revert HDD to non-RAID using the up/down arrow key then press <Enter>.

```
[Main Menu]
Create RAID Disk Drive
Delete RAID Disk Drive
Revert HDD to Non-RAID
Solve Mirror Conflict
Rebuild Mirror Drive
Save and Exit Setup
Exit Without Saving
```

2. Use the space bar to select the HDD that you want to reset to non-RAID. A selected HDD shows a ► sign before it.
3. A dialogue box appears to confirm the action. Press <Y> to confirm; otherwise, press <N>.



Pressing <Y> deletes all the data in the HDD.

Solving a Mirror conflict

A Mirror conflict occurs when both disks in a RAID 1 (Mirror) configuration are unplugged from the system in turn, then plugged in again. Since both disks contain exactly the same data, the system will be unable to determine which of the two is the source drive. This option allows you to set the source drive and rebuild the Mirror drive according to the contents of the source drive.

To solve a Mirror conflict:

1. In the main JMB363 RAID BIOS menu, highlight Solve Mirror Conflict using the up/down arrow key then press <Enter>.

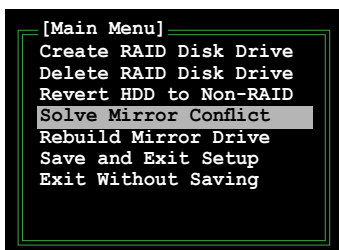

2. Use the space bar to select the HDD that you want to set as source drive. The selected HDD shows a ► sign before it.
3. Using the <TAB>, move to the RAID Disk Drive List menu and highlight the RAID set that you want to rebuild. Press to begin rebuilding the Mirror configuration.

A status bar at the bottom of the screen shows the progress of the rebuilding.

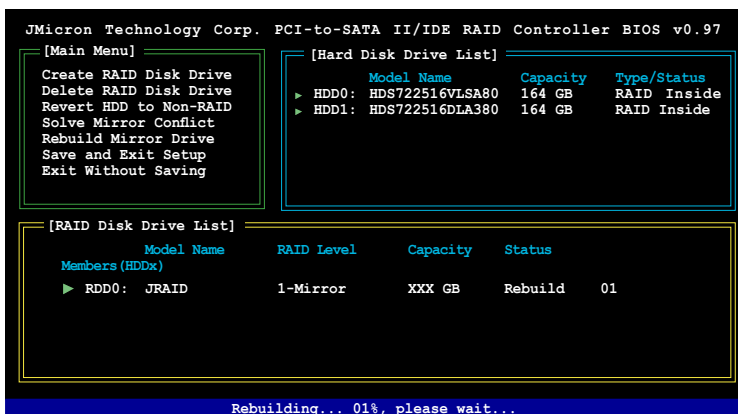

Rebuilding a Mirror Drive

When one of the disks in a RAID 1 (Mirror) configuration is unplugged from the system, then plugged in again, a dialogue box appears to ask you to rebuild the Mirror drive. Press <Y> to confirm; otherwise, press <N>.

This option allows you to rebuild the Mirror drive later and synchronize the data between two hard disks.

To rebuild a Mirror drive:

1. In the main JMB363 RAID BIOS menu, highlight Rebuild Mirror Drive using the up/down arrow key then press <Enter>.

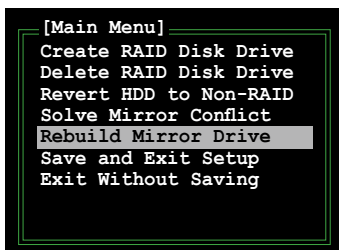

2. Using the <TAB>, move to the RAID Disk Drive List menu and highlight the RAID set that you want to rebuild. Press to begin rebuilding the Mirror configuration.

A status bar at the bottom of the screen shows the progress of the rebuilding.

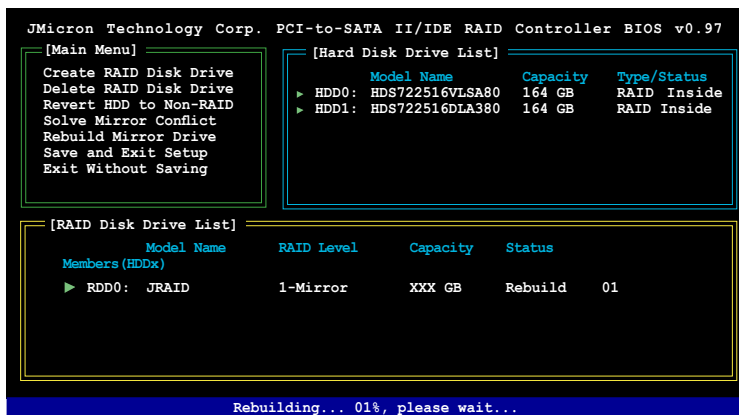

Saving the settings and exiting setup

When you have finished, highlight Save & Exit Setup using the up/down arrow key then press <Enter> to save the current RAID configuration and exit the JMB363 RAID BIOS utility.

A dialogue box appears to confirm the action. Press <Y> to confirm; otherwise, press <N> to return to the JMB RAID BIOS menu.

5.5 Creating a RAID driver disk

A floppy disk with the RAID driver is required when installing Windows® XP operating system on a hard disk drive that is included in a RAID set. For Windows® Vista operating system, use either a floppy disk or a USB device with the RAID driver.

5.5.1 Creating a RAID driver disk without entering the OS

To create a RAID/SATA driver disk without entering the OS:

1. Boot your computer.
2. Press during POST to enter the BIOS setup utility.
3. Set the optical drive as the primary boot device.
4. Insert the support DVD into the optical drive.
5. Save changes and exit BIOS.
6. Press any key when the system prompts “Press any key to boot from the optical drive.”
7. When the menu appears, press <1> to create a RAID driver disk.
8. Insert a formatted floppy disk into the floppy drive then press <Enter>.
9. Follow succeeding screen instructions to complete the process.

5.5.2 Creating a RAID/SATA driver disk in Windows®

To create a RAID driver disk in Windows® environment:

1. Start Windows®.
2. Place the motherboard support DVD into the optical drive.
3. Go to the **Make Disk** menu, then select the RAID driver disk you wish to create:
 - Click **Intel(R) ESB2 AHCI/RAID 32bit/64bit Driver** to create an Intel® ESB2E AHCI/RAID driver disk for a 32bit/64bit system.
 - Click **JMicron JMB36X 32bit/64bit SATA/RAID Driver** to create a JMicron® JMB36X driver disk for a 32bit/64-bit system.
4. Insert a floppy disk/USB device into the floppy disk drive/USB port.
5. Follow succeeding screen instructions to complete the process.



Write-protect the floppy disk to avoid computer virus infection.

To install the RAID driver in Windows® XP:

1. During the OS installation, the system prompts you to press the F6 key to install third-party SCSI or RAID driver.
2. Press <F6> then insert the floppy disk with RAID driver into the floppy disk drive.
3. Follow the succeeding screen instructions to complete the installation.

To install the RAID driver in Windows® Vista:

1. Insert the floppy disk/USB device with RAID driver into the floppy disk drive/USB port.
2. During the OS installation, select **Intel ESB2E**.
3. Follow the succeeding screen instructions to complete the installation.

The Appendix describes the CPU features and technologies that the motherboard supports.

CPU features



Chapter summary



A.1	Intel® EM64T.....	A-1
A.2	Enhanced Intel SpeedStep® Technology (EIST).....	A-1

A.1 Intel® EM64T



- The motherboard is fully compatible with Intel® LGA771 processors running on 32-bit operating systems.
- The motherboard comes with a BIOS file that supports EM64T. You can download the latest BIOS file from the ASUS website (www.asus.com/support/download/) if you need to update the BIOS file. See Chapter 4 for details.
- Visit www.intel.com for more information on the EM64T feature.
- Visit www.microsoft.com for more information on Windows® 64-bit OS.

Using the Intel® EM64T feature

To use the Intel® EM64T feature:

1. Install an Intel® CPU that supports the Intel® EM64T.
2. Install a 64-bit operating system (Windows® Vista 64-bit Edition or Windows® XP Professional x64 Edition).
3. Install the 64-bit drivers for the motherboard components and devices from the support DVD.
4. Install the 64-bit drivers for expansion cards or add-on devices, if any.



Refer to the expansion card or add-on device(s) documentation, or visit the related website, to verify if the card/device supports a 64-bit system.

A.2 Enhanced Intel SpeedStep® Technology (EIST)



- The motherboard comes with a BIOS file that supports EIST. You can download the latest BIOS file from the ASUS website (www.asus.com/support/download/) if you need to update the BIOS. See Chapter 4 for details.
- Visit www.intel.com for more information on the EIST feature.

A.2.1 System requirements

Before using EIST, check your system if it meets the following requirements:

- Intel® processor with EIST support
- BIOS file with EIST support
- Operating system with EIST support (Windows® Vista, Windows® XP SP2/ Linux 2.6 kernel or later versions)

A.2.2 Using the EIST

To use the EIST feature:

1. Turn on the computer, then enter the BIOS Setup.
2. Go to the Advanced Menu, highlight CPU Configuration, then press <Enter>.
3. Set the Intel(R) SpeedStep Technology item to [Automatic], then press <Enter>.
4. Press <F10> to save your changes and exit the BIOS setup.
5. After the computer restarts, right click on a blank space on the desktop, then select Properties from the pop-up menu.
6. When the Display Properties window appears, click the Screen Saver tab.
7. Click the Power button on the Monitor power section to open the Power Options Properties window.

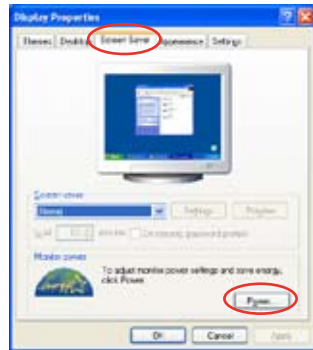

8. On the Power schemes section, click , then select any option except Home/Office Desktop or Always On.
9. Click Apply, then click OK.
10. Close the Display Properties window.

After you adjust the power scheme, the CPU internal frequency slightly decreases when the CPU loading is low.

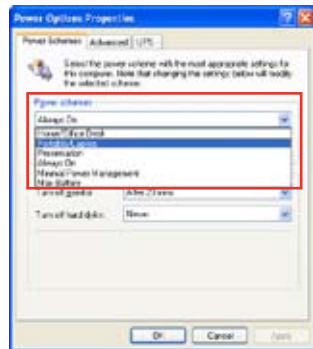

The screen displays and procedures may vary depending on the operating system.