

M3A32-MVP
Deluxe *Series*

ASUS[®]

Motherboard

E3455

Second Edition V2

October 2007

Copyright © 2007 ASUSTeK COMPUTER INC. All Rights Reserved.

No part of this manual, including the products and software described in it, may be reproduced, transmitted, transcribed, stored in a retrieval system, or translated into any language in any form or by any means, except documentation kept by the purchaser for backup purposes, without the express written permission of ASUSTeK COMPUTER INC. ("ASUS").

Product warranty or service will not be extended if: (1) the product is repaired, modified or altered, unless such repair, modification or alteration is authorized in writing by ASUS; or (2) the serial number of the product is defaced or missing.

ASUS PROVIDES THIS MANUAL "AS IS" WITHOUT WARRANTY OF ANY KIND, EITHER EXPRESS OR IMPLIED, INCLUDING BUT NOT LIMITED TO THE IMPLIED WARRANTIES OR CONDITIONS OF MERCHANTABILITY OR FITNESS FOR A PARTICULAR PURPOSE. IN NO EVENT SHALL ASUS, ITS DIRECTORS, OFFICERS, EMPLOYEES OR AGENTS BE LIABLE FOR ANY INDIRECT, SPECIAL, INCIDENTAL, OR CONSEQUENTIAL DAMAGES (INCLUDING DAMAGES FOR LOSS OF PROFITS, LOSS OF BUSINESS, LOSS OF USE OR DATA, INTERRUPTION OF BUSINESS AND THE LIKE), EVEN IF ASUS HAS BEEN ADVISED OF THE POSSIBILITY OF SUCH DAMAGES ARISING FROM ANY DEFECT OR ERROR IN THIS MANUAL OR PRODUCT.

SPECIFICATIONS AND INFORMATION CONTAINED IN THIS MANUAL ARE FURNISHED FOR INFORMATIONAL USE ONLY, AND ARE SUBJECT TO CHANGE AT ANY TIME WITHOUT NOTICE, AND SHOULD NOT BE CONSTRUED AS A COMMITMENT BY ASUS. ASUS ASSUMES NO RESPONSIBILITY OR LIABILITY FOR ANY ERRORS OR INACCURACIES THAT MAY APPEAR IN THIS MANUAL, INCLUDING THE PRODUCTS AND SOFTWARE DESCRIBED IN IT.

Products and corporate names appearing in this manual may or may not be registered trademarks or copyrights of their respective companies, and are used only for identification or explanation and to the owners' benefit, without intent to infringe.

Contents

Contents	iii
Notices	viii
Safety information	ix
About this guide	x
M3A32-MVP Deluxe Series specifications summary	xii
Chapter 1: Product introduction	
1.1 Welcome!	1-1
1.2 Package contents	1-1
1.3 Special features	1-2
1.3.1 Product highlights	1-2
1.3.2 ASUS AI Lifestyle unique features	1-5
1.3.3 ASUS intelligent performance and overclocking features	1-8
Chapter 2: Hardware information	
2.1 Before you proceed	2-1
2.2 Motherboard overview	2-2
2.2.1 Placement direction	2-2
2.2.2 Screw holes	2-2
2.2.3 Motherboard layout	2-3
2.2.4 Layout contents	2-4
2.3 Central Processing Unit (CPU)	2-6
2.3.1 Installing the CPU	2-6
2.3.2 Installing the heatsink and fan	2-8
2.3.3 Installing the optional fans	2-11
2.4 System memory	2-12
2.4.1 Overview	2-12
2.4.2 Memory configurations	2-13
2.4.3 Installing a DIMM	2-17
2.4.4 Removing a DIMM	2-17
2.4.5 Installing ASUS Cool Mempipe	2-18
2.5 Expansion slots	2-20
2.5.1 Installing an expansion card	2-20
2.5.2 Configuring an expansion card	2-20
2.5.3 Interrupt assignments	2-21
2.5.4 PCI slots	2-22

Contents

2.5.5	Four PCI Express x16 slots	2-22
2.6	Jumper	2-24
2.7	Connectors	2-25
2.7.1	Rear panel connectors	2-25
2.7.2	Internal connectors	2-28
Chapter 3: Powering up		
3.1	Starting up for the first time.....	3-1
3.2	Turning off the computer.....	3-2
3.2.1	Using the OS shut down function.....	3-2
3.2.2	Using the dual function power switch.....	3-2
Chapter 4: BIOS setup		
4.1	Managing and updating your BIOS	4-1
4.1.1	ASUS Update utility	4-1
4.1.2	Creating a bootable floppy disk.....	4-4
4.1.3	ASUS EZ Flash 2 utility.....	4-5
4.1.4	AFUDOS utility.....	4-6
4.1.5	ASUS CrashFree BIOS 3 utility	4-8
4.2	BIOS setup program	4-9
4.2.1	BIOS menu screen.....	4-10
4.2.2	Menu bar.....	4-10
4.2.3	Navigation keys.....	4-10
4.2.4	Menu items	4-11
4.2.5	Sub-menu items.....	4-11
4.2.6	Configuration fields	4-11
4.2.7	Pop-up window	4-11
4.2.8	Scroll bar.....	4-11
4.2.9	General help	4-11
4.3	Main menu	4-12
4.3.1	System Time	4-12
4.3.2	System Date	4-12
4.3.3	Legacy Diskette A	4-12
4.3.4	Language	4-12
4.3.5	Primary IDE Master/Slave; SATA1~4.....	4-13
4.3.6	Storage Configuration	4-14

Contents

4.3.7	System Information	4-15
4.4	Advanced menu	4-16
4.4.1	Jumperfree Configuration	4-16
4.4.2	AI Net 2	4-21
4.4.3	CPU Configuration	4-22
4.4.4	Chipset	4-23
4.4.5	Onboard Devices Configuration	4-25
4.4.6	PCI PnP	4-26
4.4.7	USB Configuration	4-27
4.5	Power menu.....	4-28
4.5.1	Suspend Mode	4-28
4.5.2	Repost Video on S3 Resume.....	4-29
4.5.3	ACPI 2.0 Support	4-29
4.5.4	ACPI APIC Support	4-29
4.5.5	APM Configuration	4-29
4.5.6	Hardware Monitor	4-31
4.6	Boot menu	4-32
4.6.1	Boot Device Priority	4-32
4.6.2	Boot Settings Configuration	4-33
4.6.3	Security	4-34
4.7	Tools menu	4-36
4.7.1	ASUS EZ Flash 2.....	4-36
4.7.2	ASUS O.C. Profile.....	4-37
4.8	Exit menu.....	4-38
 Chapter 5: Software support		
5.1	Installing an operating system	5-1
5.2	Support DVD information	5-1
5.2.1	Running the support DVD	5-1
5.2.2	Drivers menu	5-2
5.2.3	Utilities menu	5-3
5.2.4	Make Disk menu	5-5
5.2.5	Manual menu	5-6
5.2.6	ASUS Contact information.....	5-6
5.2.7	Other information	5-7
5.3	Software information	5-9

Contents

- 5.3.1 ASUS MyLogo2™ 5-9
- 5.3.2 Cool 'n' Quiet!™ Technology.....5-11
- 5.3.3 AI Audio 2 (SoundMAX® High Definition Audio utility) ... 5-13
- 5.3.4 ASUS PC Probe II..... 5-22
- 5.3.5 ASUS AI Suite..... 5-28
- 5.3.6 ASUS AI Gear 2..... 5-30
- 5.3.7 ASUS AI Nap 5-31
- 5.3.8 ASUS AI N.O.S. 5-32
- 5.3.9 ASUS Q-Fan 2..... 5-33
- 5.3.10 ASUS AI Booster..... 5-34
- 5.3.11 AMD OverDrive (AOD) 5-35
- 5.4 RAID configurations 5-36**
 - 5.4.1 RAID definitions 5-36
 - 5.4.2 Installing Serial ATA hard disks 5-37
 - 5.4.3 AMD® RAID configurations..... 5-37
 - 5.4.4 Marvell® RAID configurations..... 5-43
- 5.5 Creating a RAID driver disk..... 5-49**
 - 5.5.1 Creating a RAID driver disk without entering the OS.... 5-49
 - 5.5.2 Creating a RAID/SATA driver disk in Windows® 5-49
- Chapter 6: ATI® CrossFire™ technology support**
 - 6.1 Overview 6-1**
 - 6.1.1 Requirements..... 6-1
 - 6.1.2 Before you begin..... 6-1
 - 6.2 Installing CrossFire™ graphics cards 6-2**
 - 6.3 Software information 6-5**
 - 6.3.1 Installing the device drivers..... 6-5
 - 6.3.2 Using the Catalyst™ Control Center 6-7

Notices

Federal Communications Commission Statement

This device complies with Part 15 of the FCC Rules. Operation is subject to the following two conditions:

- This device may not cause harmful interference, and
- This device must accept any interference received including interference that may cause undesired operation.

This equipment has been tested and found to comply with the limits for a Class B digital device, pursuant to Part 15 of the FCC Rules. These limits are designed to provide reasonable protection against harmful interference in a residential installation. This equipment generates, uses and can radiate radio frequency energy and, if not installed and used in accordance with manufacturer's instructions, may cause harmful interference to radio communications. However, there is no guarantee that interference will not occur in a particular installation. If this equipment does cause harmful interference to radio or television reception, which can be determined by turning the equipment off and on, the user is encouraged to try to correct the interference by one or more of the following measures:

- Reorient or relocate the receiving antenna.
- Increase the separation between the equipment and receiver.
- Connect the equipment to an outlet on a circuit different from that to which the receiver is connected.
- Consult the dealer or an experienced radio/TV technician for help.



The use of shielded cables for connection of the monitor to the graphics card is required to assure compliance with FCC regulations. Changes or modifications to this unit not expressly approved by the party responsible for compliance could void the user's authority to operate this equipment.

Canadian Department of Communications Statement

This digital apparatus does not exceed the Class B limits for radio noise emissions from digital apparatus set out in the Radio Interference Regulations of the Canadian Department of Communications.

This class B digital apparatus complies with Canadian ICES-003.

Safety information

Electrical safety

- To prevent electrical shock hazard, disconnect the power cable from the electrical outlet before relocating the system.
- When adding or removing devices to or from the system, ensure that the power cables for the devices are unplugged before the signal cables are connected. If possible, disconnect all power cables from the existing system before you add a device.
- Before connecting or removing signal cables from the motherboard, ensure that all power cables are unplugged.
- Seek professional assistance before using an adapter or extension cord. These devices could interrupt the grounding circuit.
- Make sure that your power supply is set to the correct voltage in your area. If you are not sure about the voltage of the electrical outlet you are using, contact your local power company.
- If the power supply is broken, do not try to fix it by yourself. Contact a qualified service technician or your retailer.

Operation safety

- Before installing the motherboard and adding devices on it, carefully read all the manuals that came with the package.
- Before using the product, make sure all cables are correctly connected and the power cables are not damaged. If you detect any damage, contact your dealer immediately.
- To avoid short circuits, keep paper clips, screws, and staples away from connectors, slots, sockets and circuitry.
- Avoid dust, humidity, and temperature extremes. Do not place the product in any area where it may become wet.
- Place the product on a stable surface.
- If you encounter technical problems with the product, contact a qualified service technician or your retailer.



This symbol of the crossed out wheeled bin indicates that the product (electrical, electronic equipment, and mercury-containing button cell battery) should not be placed in municipal waste. Check local regulations for disposal of electronic products.

About this guide

This user guide contains the information you need when installing and configuring the motherboard.

How this guide is organized

This guide contains the following parts:

- **Chapter 1: Product introduction**
This chapter describes the features of the motherboard and the new technology it supports.
- **Chapter 2: Hardware information**
This chapter lists the hardware setup procedures that you have to perform when installing system components. It includes description of the switches, jumpers, and connectors on the motherboard.
- **Chapter 3: Powering up**
This chapter describes the power up sequence and ways of shutting down the system.
- **Chapter 4: BIOS setup**
This chapter tells how to change system settings through the BIOS Setup menu. Detailed descriptions of the BIOS parameters are also provided.
- **Chapter 5: Software support**
This chapter describes the contents of the support DVD that comes with the motherboard package and the software.
- **Chapter 6: ATI CrossFire™ support**
This chapter describes the ATI CrossFire™ feature and shows the graphics card installation procedures.

Where to find more information

Refer to the following sources for additional information and for product and software updates.

1. **ASUS websites**
The ASUS website provides updated information on ASUS hardware and software products. Refer to the ASUS contact information.
2. **Optional documentation**
Your product package may include optional documentation, such as warranty flyers, that may have been added by your dealer. These documents are not part of the standard package.

Conventions used in this guide

To make sure that you perform certain tasks properly, take note of the following symbols used throughout this manual.



DANGER/WARNING: Information to prevent injury to yourself when trying to complete a task.



CAUTION: Information to prevent damage to the components when trying to complete a task.



IMPORTANT: Instructions that you **MUST** follow to complete a task.



NOTE: Tips and additional information to help you complete a task.

Typography

Bold text

Indicates a menu or an item to select.

Italics

Used to emphasize a word or a phrase.

<Key>

Keys enclosed in the less-than and greater-than sign means that you must press the enclosed key.

Example: <Enter> means that you must press the Enter or Return key.

<Key1+Key2+Key3>

If you must press two or more keys simultaneously, the key names are linked with a plus sign (+).

Example: <Ctrl+Alt+D>

Command

Means that you must type the command exactly as shown, then supply the required item or value enclosed in brackets.

Example: At the DOS prompt, type the command line:

afudos /iM3A32MVP.ROM

M3A32-MVP Deluxe Series

specifications summary

CPU	AMD® Socket AM2+ Phenom™ FX / Phenom X4 / Phenom X2 / Athlon™ 64 X2 / Sempron™ processor AMD® Socket AM2 Athlon 64 X2 / Athlon 64 FX / Athlon 64 / Sempron processor AMD LIVE!™ Ready
Chipset	AMD 790FX / SB600
System bus	Up to 5200 MT/s; HyperTransport™ 3.0 interface for AM2+ CPU 2000 / 1600 MT/s for AM2 CPU
Memory	Dual-channel memory architecture <ul style="list-style-type: none"> - 4 x 240-pin DIMM sockets support unbuffered ECC/non-ECC DDR2 1066*/800/667/533 MHz memory modules - Supports up to 8 GB system memory <p>*DDR2 1066 is supported by some of the AM2+ CPUs only. Refer to www.asus.com for the supported CPU models and the Memory QVL (Qualified Vendors Lists).</p>
Expansion slots	4 x PCIe x16 slots with ATI CrossFireX™ support (@ dual x16, triple x16 / x8 / x8, or quad x8 modes) 2 x PCI 2.2 slots Support PCIe 2.0/1.0 architecture
CrossFireX™	Supports ATI CrossFireX™ graphics cards
Storage	Southbridge: <ul style="list-style-type: none"> - 4 x SATA 3.0 Gb/s connectors support RAID 0, RAID1, and RAID 0+1 - 1 x Ultra DMA 133/100/66 <p>Marvell® 6121 and 6111 PATA and SATA controller</p> <ul style="list-style-type: none"> - 2 x Serial ATA 3.0 Gb/s connectors support RAID 0 and RAID1 - 1 x External SATA 3.0 Gb/s on the rear panel (SATA-On-The-Go)
LAN	Marvell® PCIe Gigabit LAN controllers featuring AI NET 2
Wireless LAN (WiFi-AP Edition only)	ASUS WiFi-AP Solo 54 Mbps IEEE 802.11g and backwards compatible with 11 Mbps IEEE 802.11b <ul style="list-style-type: none"> - Software Access Point mode - Station mode: Infrastructure mode and Ad-Hoc mode

(continued on the next page)

M3A32-MVP Deluxe Series

specifications summary

High Definition audio	ADI® AD1988B 8-channel High Definition audio CODEC <ul style="list-style-type: none"> - Supports Jack-Detection, Enumeration, Multi-Streaming, and Jack-Retasking - Coaxial/Optical S/PDIF Out ports at back I/O
IEEE 1394	2 x IEEE 1394a connectors (1 at mid-board; 1 on the rear panel)
USB	10 x USB 2.0 ports (4 at mid-board; 6 on the rear panel)
ASUS AI Lifestyle unique features	ASUS Quiet Thermal Solution: <ul style="list-style-type: none"> - ASUS Fanless Design: Cool Mempipe solution (<i>WiFi-AP Edition only</i>) - ASUS AI Gear 2 - ASUS 8+2 Phase Power Design - ASUS AI Nap - ASUS Fanless Design: Heat-pipe solution & Stack Cool 2 - ASUS Q-Fan 2 ASUS Crystal Sound <ul style="list-style-type: none"> - ASUS Noise Filter - ASUS AI Audio 2 ASUS EZ DIY <ul style="list-style-type: none"> - ASUS Q-Shield - ASUS Q-Connector - ASUS O.C. Profile - ASUS CrashFree BIOS 3 - ASUS EZ Flash 2
Other features	ASUS MyLogo 2™ Multi-language BIOS
ASUS exclusive overclocking features	Intelligent overclocking tools: <ul style="list-style-type: none"> - AI NOS™ (Non-delay Overclocking System) - AI Overclocking (intelligent CPU frequency tuner) - ASUS AI Booster utility Precision Tweaker 2: <ul style="list-style-type: none"> - vCore: Adjustable CPU voltage at 0.0125V increment - vDIMM: 35-step DRAM voltage control - vChipset: 16-step Chipset voltage control SFS (Stepless Frequency Selection): <ul style="list-style-type: none"> - FSB tuning from 100 MHz up to 600 MHz at 1 MHz increment - Memory tuning from 533 MHz up to 1066 MHz - PCI Express frequency tuning from 100 MHz to 150 MHz at 1 MHz increment Overclocking protection: <ul style="list-style-type: none"> - ASUS C.P.R. (CPU Parameter Recall)

(continued on the next page)

M3A32-MVP Deluxe Series

specifications summary

Rear panel I/O ports	<ul style="list-style-type: none"> 1 x PS/2 keyboard port (purple) 1 x S/PDIF Out (Coaxial + Optical) 1 x External SATA 1 x IEEE 1394a port 1 x LAN (RJ-45) 6 x USB 2.0/1.1 1 x WiFi-AP Solo antenna jack (<i>WiFi-AP Edition only</i>) 8-channel audio I/O
Internal I/O connectors	<ul style="list-style-type: none"> 2 x USB connectors support additional 4 USB ports 1 x Floppy disk drive connector 1 x COM connector 1 x IDE connector 6 x SATA connectors 1 x CPU Fan connector 2 x Chassis Fan connector 1 x Power Fan connector 1 x IEEE1394a connector Front panel audio connector 1 x Azalia Digital Header 1 x S/PDIF Out Header Chassis Intrusion connector CD audio in 24-pin ATX Power connector 1 x 8-pin ATX 12V Power connector System Panel (Q-Connector)
BIOS features	<ul style="list-style-type: none"> 8 Mb Flash ROM, Award BIOS, PnP, DMI 2.0, WfM2.0, SM BIOS 2.3, ACPI 2.0a, Multi-language BIOS, ASUS EZ Flash 2, ASUS CrashFree BIOS 3
Manageability	<ul style="list-style-type: none"> WfM 2.0, DMI 2.0, WOL by PME, WOR by PME, PXE
Support DVD contents	<ul style="list-style-type: none"> Drivers ASUS AI Suite ASUS PC Probe II ASUS Update AI Booster Anti-virus Utility (OEM version)
Form factor	<ul style="list-style-type: none"> ATX form factor: 12 in x 9.6 in (30.5 cm x 24.5 cm)

*Specifications are subject to change without notice.

This chapter describes the motherboard features and the new technologies it supports.

1 Product introduction

Chapter summary



- 1.1 Welcome! 1-1
- 1.2 Package contents..... 1-1
- 1.3 Special features..... 1-2

1.1 Welcome!

Thank you for buying an ASUS® M3A32-MVP Deluxe Series motherboard!

The motherboard delivers a host of new features and latest technologies, making it another standout in the long line of ASUS quality motherboards!

Before you start installing the motherboard, and hardware devices on it, check the items in your package with the list below.

1.2 Package contents

Check your motherboard package for the following items.

Motherboard	ASUS M3A32-MVP Deluxe Series
I/O modules	1 x Multi-functional module (1-port IEEE 1394a module and 2-port USB 2.0 module)
Cables	ASUS CrossFire™ bridge cables 1 x Serial ATA power cable for 2 devices 6 x Serial ATA signal cables 1 x Ultra DMA 133/100/66 cable 1 x Floppy disk drive cable
Accessories	ASUS Cool Mempipe (<i>WiFi-AP Edition Only</i>) ASUS Q-Shield 1 x ASUS Q-Connector Kit (USB, 1394, system panel; Retail version only) 1 x WiFi-AP Solo Antenna (<i>WiFi-AP Edition Only</i>) Optional fan for Water-Cooling or Passive-cooling only
Application DVD	ASUS motherboard support DVD
Documentation	User guide WiFi-AP Solo user guide (<i>WiFi-AP Edition Only</i>)



If any of the above items is damaged or missing, contact your retailer.

1.3 Special features

1.3.1 Product highlights

Green ASUS



This motherboard and its packaging comply with the European Union's Restriction on the use of Hazardous Substances (RoHS). This is in line with the ASUS vision of creating environment-friendly and recyclable products/packaging to safeguard consumers' health while minimizing the impact on the environment.

AMD® Socket AM2+ Phenom™ FX / Phenom X4 / Phenom X2 / Athlon™ 64 X2 / Sempron™ CPU support



This motherboard supports AMD® Socket AM2+ multi-core processors with unique L3 cache and delivers better overclocking capabilities with less power consumption. It features dual-channel DDR2 1066 memory support and accelerates data transfer rate up to 5200MT/s via HyperTransport™ 3.0 based system bus. See page 2-6 for details.

HyperTransport™ 3.0 support



HyperTransport™ 3.0 technology provides 2.6 times more bandwidth than HyperTransport™ 1.0, radically improving system efficiency to create a smoother, faster computing environment.

AMD® Socket AM2 Athlon™ 64 X2 / Athlon™ 64 FX / Athlon™ 64 / Sempron™ CPU support



This motherboard supports AMD® Socket AM2 single-core Athlon™ 64 / Sempron™ and dual-core Athlon™ 64 X2 / Athlon™ 64 FX processors with 2MB / 1MB / 512KB L2 cache based on 64-bit architecture. It features 2000 / 1600 MT/s HyperTransport™-based system bus, dual-channel un-buffered DDR2 800 memory support, and AMD® Cool 'n' Quiet™ Technology. See page 2-6 for details.

AMD 790FX Chipset



AMD 790FX Chipset is designed to support up to 5200MT/s HyperTransport™ 3.0 (HT 3.0) interface speed and quad PCI Express™ 2.0 x16 graphics. It is optimized with AMD®'s latest AM2+ and multi-core CPUs to provide excellent system performance and overclocking capabilities.

Native DDR2 1066 support



This motherboard is the first AMD® platform with native DDR2 1066 support. It provides faster data transfer rate and more bandwidth to increase memory computing efficiency, enhancing system performance in 3D graphics and other memory demanding applications. See page 2-12 for details.



DDR2 1066 is supported by some of the AM2+ CPUs only. Refer to www.asus.com for the supported CPU models.

ATI CrossFireX™ Technology



ATI's CrossFireX™ boosts image quality along with rendering speed, eliminating the need to scale down screen resolution to get high quality images. CrossFireX™ allows higher antialiasing, anisotropic filtering, shading, and texture settings. Adjust your display configurations, experiment with the advanced 3D settings, and check the effects with a real-time 3D-rendered previews within ATI Catalyst™ Control Center.

PCIe 2.0 support



This motherboard supports the latest PCIe 2.0 devices for double speed and bandwidth which enhances system performance. See page 2-22 for details.

Multi-VGA support



This motherboard is ready to support Quad-CrossFire™, the most advanced graphics standard that provides higher frame rates for superb graphics performance. It also provides full x16 dual lanes or triple VGA support. See page 2-22 for details.

Serial ATA 3.0 Gb/s technology and SATA-On-The-Go



This motherboard supports the next-generation hard disk drives based on the Serial ATA (SATA) 3Gb/s storage specifications, delivering enhanced scalability and doubling the bus bandwidth for high-speed data retrieval and save. The external SATA port located at the back I/O provides smart setup and hot-plug functions, enabling easy backup of media files to external devices. See pages 2-26 and 2-29 for details.

Dual RAID solution



The onboard RAID controllers provide the motherboard with dual-RAID functionality that allows you to select the best RAID solution using Serial ATA devices. The AMD® SB600 chipset incorporates four Serial ATA connectors with high performance RAID 0, 1, and 0+1 functions. The Marvell® controller provides another two Serial ATA connectors for RAID 0 and RAID 1 functions. See pages 2-29 and 2-31 for details.

IEEE 1394a support



The IEEE 1394a interface provides high speed digital interface for audio/video appliances such as digital television, digital video camcorders, storage peripherals, and other PC portable devices. See pages 2-25 and 2-32 for details.

S/PDIF digital sound ready



This motherboard provides convenient connectivity to external home theater audio systems via coaxial and optical S/PDIF (SONY-PHILIPS Digital Interface) Out jacks. It allows digital audio transferring without converting it to analog format, and therefore well preserves signal quality. See page 2-37 for details.

WiFi-AP Solo (WiFi-AP Edition only)



WiFi-AP Solo allows a new level of versatility for your PC and helps create a complete wireless home network in either AP or wireless client mode. Users will be able to play LAN games, connect to the Internet, access and share printers, and use Skype from anywhere within range. WiFi-AP Solo provides these functions even when the PC is in sleep mode, so users can use Skype as a replacement for tradition long distance telephone service. Since WiFi-AP Solo is onboard, users can save the cost of an extra WiFi-AP.

High Definition Audio



Enjoy high-end sound quality on your PC! The onboard 8-channel HD audio (High Definition Audio, previously codenamed Azalia) CODEC enables high-quality 192KHz/24-bit audio output that simultaneously sends different audio streams to different destinations. You can now talk to your partners on the headphones while playing multi-channel network games. See pages 2-25 and 2-26 for details.

1.3.2 ASUS AI Lifestyle unique features



ASUS Quiet Thermal Solution

ASUS Quiet Thermal solution makes system more stable and enhances the overclocking capability.

ASUS Cool Mempipe (WiFi-AP Edition only)



ASUS Cool Mempipe supports unparalleled memory overclocking via innovative thermal solutions. By lowering the memory and system temperatures, the Cool Mempipe contributes to a stable computing environment. See pages 2-18 and 2-19 for details.



ASUS Cool Mempipe supports the thermal dissipation of memory modules on DIMM_A1 and DIMM_B1 sockets only.

AI Gear 2



AI Gear 2 allows you to choose from profiles to adjust CPU frequency and vCore voltage, minimizing system noise and saving CPU power consumption at most. You can real-time change the mode under operating system to suit your needs. See page 5-30 for details.

AI Nap



With AI Nap, the system can continue running at minimum power and noise when you are temporarily away. To wake the system and return to the OS environment, simply click the mouse or press a key. See page 5-31 for details.

8+2 Phase Power Design



ASUS 8+2 Phase Power Design, with independent power to vital components, ultimately enhances memory performance and ensures quick response and stability of CPU under heavy loading or overclocking modes.

Fanless Design–Stack Cool 2



ASUS Stack Cool 2 is a fan-less and zero-noise cooling solution that lowers the temperature of critical heat generating components. The motherboard uses a special design on the printed circuit board (PCB) to dissipate heat these critical components generate.

Fanless Design–Heat-pipe



The Heat Pipe design effectively directs the heat generated by the chipsets to the heatsink near the back IO ports, where it can be carried away by existing airflow from CPU fan or bundled optional fan. The purpose of the innovative heat pipe design on this motherboard is that the groundbreaking fanless design does not have lifetime problems as a chipset fan does. Furthermore, it provides options for users to install side-flow fan or passive cooler. The Heat Pipe design is the most reliable fanless thermal solution to date.



DO NOT uninstall the heat-pipe by yourself. Doing so may bend the tubing and affect the heat dissipation performance.

Q-Fan 2



ASUS Q-Fan2 technology intelligently adjusts both CPU fan and chassis fan speeds according to system loading to ensure quiet, cool and efficient operation. See page 4-31 and 5-33 for details.

ASUS Crystal Sound

This feature can enhance speech-centric applications like Skype, online game, video conference and recording.

Noise Filter



This feature detects repetitive and stationary noises (non-voice signals) like computer fans, air conditioners, and other background noises then eliminates it in the incoming audio stream while recording. See page 5-21 for details.

AI Audio 2



AI Audio 2 creates a virtual center channel that expands the overall sound field without introducing a picket fencing effect. Preserving the dialogue or solo performances with downmixing from multi-channels allows you to experience true-to-life high quality audio. Refer to pages 5-13 for details.

ASUS EZ DIY

ASUS EZ DIY feature collection provides you easy ways to install computer components, update the BIOS or back up your favorite settings.

ASUS Q-Shield



The specially designed ASUS Q-Shield does without the usual “fingers”—making it convenient and easy to install. With better electric conductivity, it ideally protects your motherboard against static electricity and shields it against Electronic Magnetic Interference (EMI).

ASUS Q-Connector



ASUS Q-Connector allows you to easily connect or disconnect the chassis front panel cables to the motherboard. This unique module eliminates the trouble of connecting the system panel cables one at a time and avoiding wrong cable connections. See page 2-39 for details.

ASUS O.C. Profile



The motherboard features the ASUS O.C. Profile that allows users to conveniently store or load multiple BIOS settings. The BIOS settings can be stored in the CMOS or a separate file, giving users freedom to share and distribute their favorite settings. See page 4-37 for details.

ASUS CrashFree BIOS 3



ASUS CrashFree BIOS 3 allows users to restore corrupted BIOS data from a USB flash disk containing the BIOS file. See page 4-8 for details.

ASUS EZ Flash 2



ASUS EZ Flash 2 is a user-friendly BIOS update utility. Simply press the predefined hotkey to launch the utility and update the BIOS without entering the OS. Update your BIOS easily without preparing a bootable diskette or using an OS-based flash utility. See pages 4-5 and 4-36 for details.

Smart Support CD



This feature provides a checklist that allows the user to know which drivers are already installed, as well as those that are not. When using ASUS PC Probe II, you can easily monitor the critical components of the computer.

ASUS MyLogo 2™



This feature allows you to convert your favorite photo into a 256-color boot logo for a more colorful and vivid image on your screen. See pages 4-33 and 5-9 for details.

ASUS Multi-language BIOS

The multi-language BIOS allows you to select the language of your choice from the available options. The localized BIOS setup menu helps you configure your system easier and faster. See page 4-12 for details.

1.3.3 ASUS intelligent performance and overclocking features

Precision Tweaker 2

Precision Tweaker 2 allows the user to adjust the northbridge voltage, southbridge voltage, and DRAM voltage in 0.02V steps to achieve the most precise settings for the ultimate customized overclocking configuration.

AI NOS™ (Non-Delay Overclocking System)

The patented ASUS Non-delay Overclocking System™ (AI NOS™) technology auto-detects the CPU loading and dynamically overclocks the CPU speed when needed. Unlike other dynamic overclocking techniques, AI NOS™ reacts much faster to satisfy your need for speed. See page 5-32 for details.

AI Booster

The ASUS AI Booster allows you to overclock the CPU speed in Windows environment without the hassle of booting the BIOS. See page 5-34 for details.

C.P.R. (CPU Parameter Recall)

The C.P.R. feature of the motherboard BIOS allows automatic re-setting to the BIOS default settings in case the system hangs due to overclocking. When the system hangs due to overclocking, C.P.R. eliminates the need to open the system chassis and clear the RTC data. Simply shut down and reboot the system, and the BIOS automatically restores the CPU default setting for each parameter.

This chapter lists the hardware setup procedures that you have to perform when installing system components. It includes description of the jumpers and connectors on the motherboard.

Hardware information

A large, light gray, stylized number '2' is positioned behind the word 'Hardware' in the title.

2.1	Before you proceed	2-1
2.2	Motherboard overview.....	2-2
2.3	Central Processing Unit (CPU)	2-6
2.4	System memory	2-12
2.5	Expansion slots.....	2-20
2.6	Jumper	2-24
2.7	Connectors	2-25

2.1 Before you proceed

Take note of the following precautions before you install motherboard components or change any motherboard settings.



- Unplug the power cord from the wall socket before touching any component.
- Use a grounded wrist strap or touch a safely grounded object or to a metal object, such as the power supply case, before handling components to avoid damaging them due to static electricity.
- Hold components by the edges to avoid touching the ICs on them.
- Whenever you uninstall any component, place it on a grounded antistatic pad or in the bag that came with the component.
- Before you install or remove any component, ensure that the ATX power supply is switched off or the power cord is detached from the power supply. Failure to do so may cause severe damage to the motherboard, peripherals, and/or components.

Onboard LED

The motherboard comes with a standby power LED. The green LED lights up to indicate that the system is ON, in sleep mode, or in soft-off mode. This is a reminder that you should shut down the system and unplug the power cable before removing or plugging in any motherboard component. The illustration below shows the location of the onboard LED.

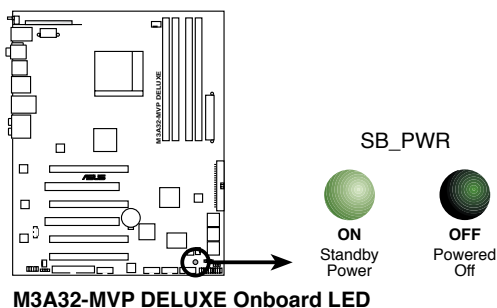

2.2 Motherboard overview

Before you install the motherboard, study the configuration of your chassis to ensure that the motherboard fits into it.



Make sure to unplug the power cord before installing or removing the motherboard. Failure to do so can cause you physical injury and damage motherboard components.

2.2.1 Placement direction

When installing the motherboard, make sure that you place it into the chassis in the correct orientation. The edge with external ports goes to the rear part of the chassis as indicated in the image below.

2.2.2 Screw holes

Place nine (9) screws into the holes indicated by circles to secure the motherboard to the chassis.



Do not overtighten the screws! Doing so can damage the motherboard.

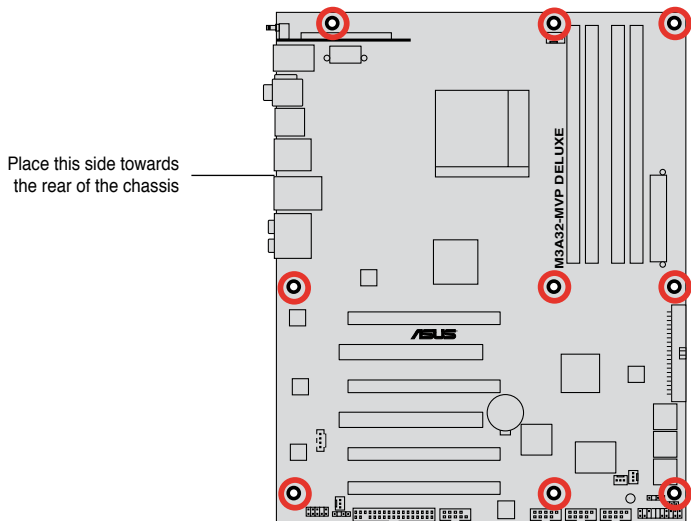

2.2.3 Motherboard layout

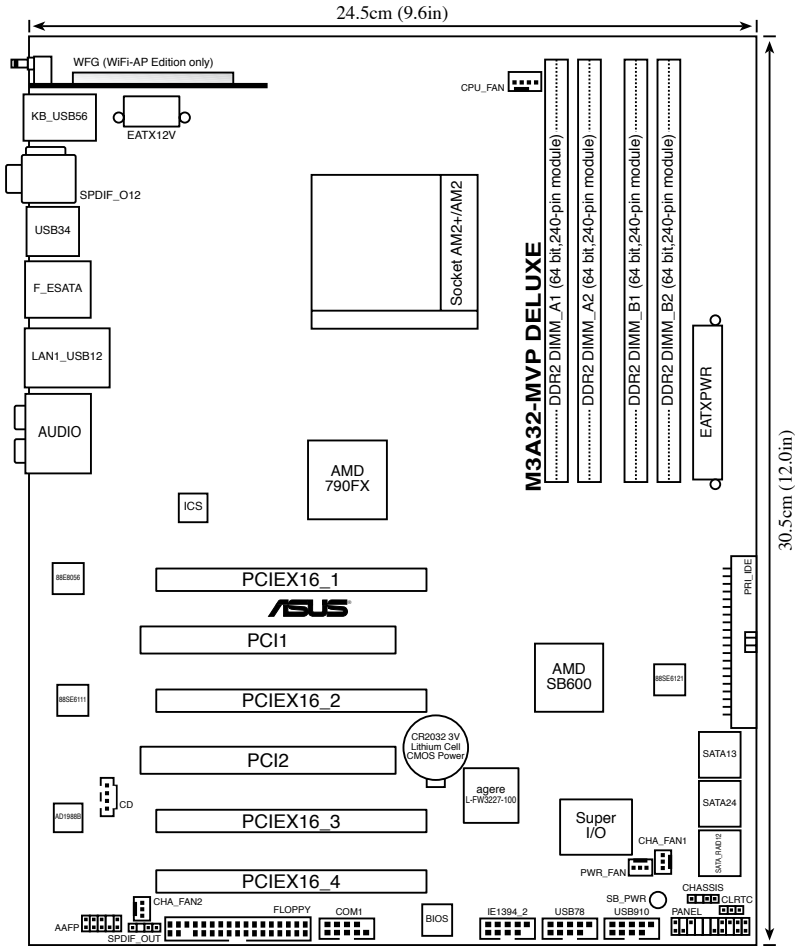

Refer to **2.7 Connectors** for more information about rear panel connectors and internal connectors.

2.2.4 Layout contents

Slots		Page
1.	DDR2 DIMM slots	2-12
2.	PCI slots	2-22
3.	PCI Express x16 slots	2-22

Jumper		Page
1.	Clear RTC RAM (3-pin CLRTC)	2-24

Rear panel connectors		Page
1.	PS/2 keyboard port (purple)	2-25
2.	Coaxial S/PDIF Out port	2-25
3.	IEEE 1394a port	2-25
4.	LAN (RJ-45) port.	2-25
5.	Center/Subwoofer port (orange)	2-25
6.	Rear Speaker Out port (black)	2-25
7.	Line In port (light blue)	2-25
8.	Line Out port (lime)	2-25
9.	Microphone port (pink)	2-25
10.	Side Speaker Out port (gray)	2-25
11.	USB 2.0 ports 1 and 2	2-26
12.	External SATA port	2-26
13.	USB 2.0 ports 3 and 4	2-26
14.	Optical S/PDIF Out port	2-26
15.	USB 2.0 ports 5 and 6	2-26
16.	Wireless LAN port (<i>WiFi-AP Edition only</i>)	2-27
17.	Wireless LAN Activity LED (<i>WiFi-AP Edition only</i>)	2-27

Internal connectors		Page
1.	Floppy disk drive connector (34-1 pin FLOPPY)	2-28
2.	IDE connector (40-1 pin PRI_IDE)	2-28
3.	AMD® SB600 Serial ATA connectors (7-pin SATA1 [red]; SATA2 [black]; SATA3 [red]; SATA4 [black])	2-29
4.	Marvell® 6121 Serial ATA RAID connectors (7-pin SATA_RAID1 [black]; SATA_RAID2 [black])	2-31
5.	USB connectors (10-1 pin USB78; USB910)	2-32
6.	IEEE 1394a port connector (10-1 pin IE1394_2)	2-32
7.	CPU, chassis, power, and power fan connectors (4-pin CPU_FAN; 3-pin CHA_FAN1; 3-pin CHA_FAN2; 3-pin PWR_FAN)	2-33
8.	Chassis intrusion connector (4-1 pin CHASSIS)	2-34
9.	ATX power connectors (24-pin EATXPWR; 8-pin ATX12V)	2-34
10.	Front panel audio connector (10-1 pin AAFP)	2-35
11.	Optical drive audio connector (4-pin CD)	2-36
12.	Serial port connector (10-1 pin COM1)	2-36
13.	Digital audio connector (4-1 pin SPDIF_OUT)	2-37
14.	System panel connector (20-8-pin PANEL) <ul style="list-style-type: none"> • System power LED (2-pin PLED) • Hard disk drive activity LED (2-pin IDE_LED) • System warning speaker (4-pin SPEAKER) • ATX power button/soft-off button (2-pin PWRSW) • Reset button (2-pin RESET) 	2-38

2.3 Central Processing Unit (CPU)

The motherboard comes with an AM2+/AM2 socket designed for AMD® Socket AM2+ Phenom™ FX / Phenom X4 / Phenom X2 / Athlon™ 64 X2 / Sempron™ processor or for Socket AM2 Athlon 64 X2 / Athlon 64 FX / Athlon 64 / Sempron processor.



The AM2+/AM2 socket has a different pinout from the 940-pin socket designed for the AMD Opteron processor. Make sure you use a CPU designed for the AM2+/AM2 socket. The CPU fits in only one correct orientation. DO NOT force the CPU into the socket to prevent bending the connectors on the socket and damaging the CPU!

2.3.1 Installing the CPU

To install a CPU:

1. Locate the CPU socket on the motherboard.

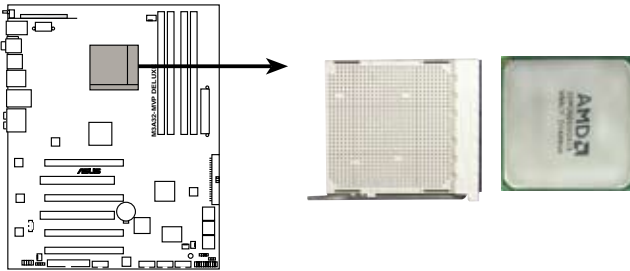

M3A32-MVP DELUXE CPU Socket AM2+/AM2

2. Unlock the socket by pressing the lever sideways, then lift it up to a 90° angle.

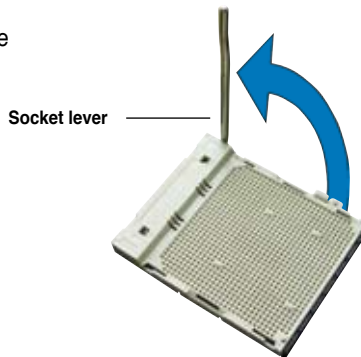

Make sure that the socket lever is lifted up to a 90° angle; otherwise, the CPU will not fit in completely.

3. Position the CPU above the socket such that the CPU corner with the gold triangle matches the socket corner with a small triangle.
4. Carefully insert the CPU into the socket until it fits in place.

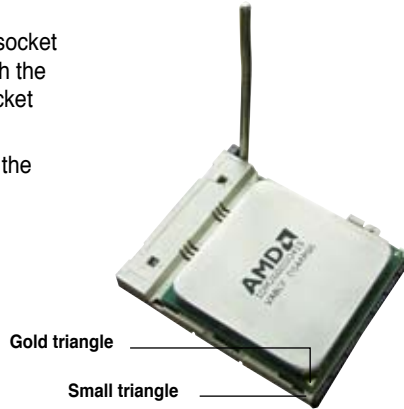

5. When the CPU is in place, push down the socket lever to secure the CPU. The lever clicks on the side tab to indicate that it is locked.
6. Install a CPU heatsink and fan following the instructions that came with the heatsink package.



2.3.2 Installing the heatsink and fan

The AMD® Phenom™ FX / Phenom X4 / Phenom X2 / Athlon™ 64 X2 / Athlon 64 FX / Athlon 64 / Sempron™ processor requires a specially designed heatsink and fan assembly to ensure optimum thermal condition and performance.



Make sure that you use only AMD-certified heatsink and fan assembly.

To install the CPU heatsink and fan:

1. Place the heatsink on top of the installed CPU, making sure that the heatsink fits properly on the retention module base.



- The retention module base is already installed on the motherboard upon purchase.
 - You do not have to remove the retention module base when installing the CPU or installing other motherboard components.
 - If you purchased a separate CPU heatsink and fan assembly, make sure that a Thermal Interface Material is properly applied to the CPU heatsink or CPU before you install the heatsink and fan assembly.
-

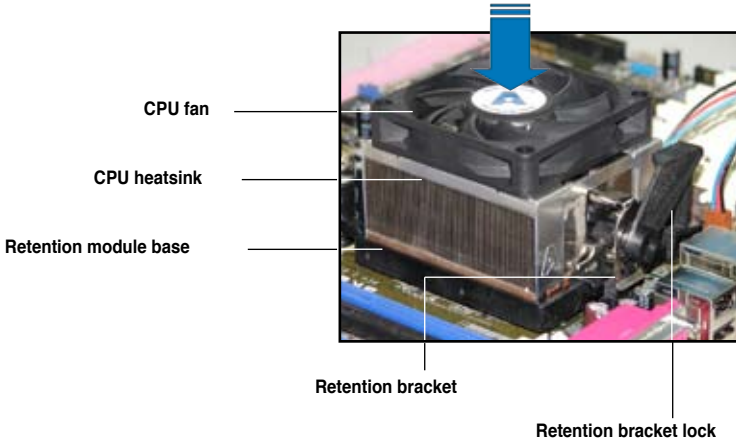

Your boxed CPU heatsink and fan assembly should come with installation instructions for the CPU, heatsink, and the retention mechanism. If the instructions in this section do not match the CPU documentation, follow the latter.

2. Attach one end of the retention bracket to the retention module base.

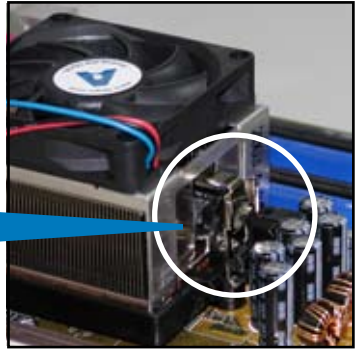

3. Align the other end of the retention bracket (near the retention bracket lock) to the retention module base. A clicking sound denotes that the retention bracket is in place.



Make sure that the fan and heatsink assembly perfectly fits the retention mechanism module base, otherwise you cannot snap the retention bracket in place.



4. Push down the retention bracket lock on the retention mechanism to secure the heatsink and fan to the module base.

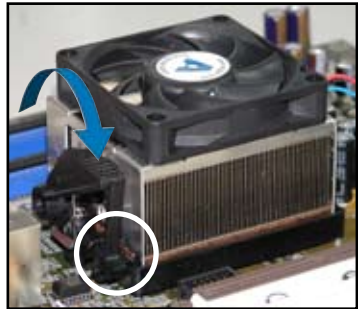

5. When the fan and heatsink assembly is in place, connect the CPU fan cable to the connector on the motherboard labeled CPU_FAN.

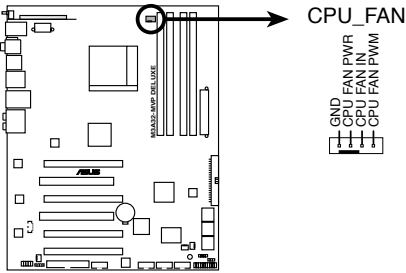

M3A32-MVP DELUXE CPU fan connector



-
- Do not forget to connect the CPU fan connector! Hardware monitoring errors can occur if you fail to plug this connector.
 - This connector is backward compatible with old 3-pin CPU fan.
-

2.3.3 Installing the optional fans



Install the optional fan only if you are using a passive cooler or a water cooler. Installing the optional fan with an active CPU cooler will interfere with the airflow and destabilize the system.

1. Position the fan above the pipe and heatsink assembly.
2. Fit the fan to the grooved edge of the heatsink.

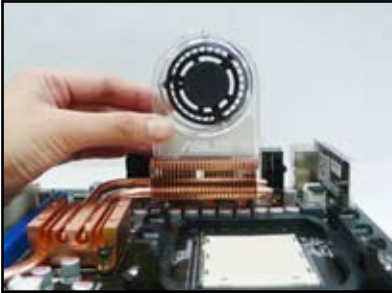

3. Carefully push down the fan until it snugly fits the heatsink, then connect the fan cable.
4. The photo shows the fan installed on the motherboard.

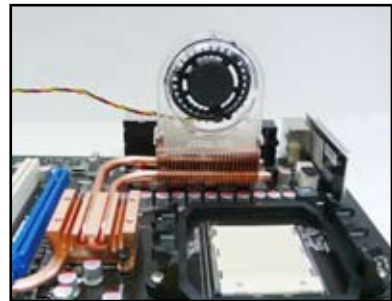
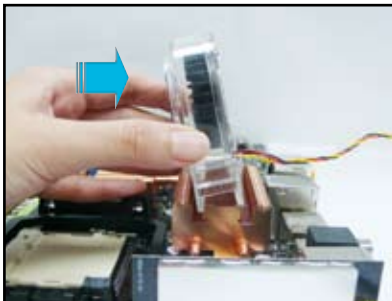

- Plug the optional fan cable to the CHA_FAN1/2 connector on the motherboard.
- Make sure the optional fan is installed correctly to prevent damage to the fan and motherboard components.

2.4 System memory

2.4.1 Overview

The motherboard comes with four Double Data Rate 2 (DDR2) Dual Inline Memory Modules (DIMM) sockets.

The figure illustrates the location of the DDR2 DIMM sockets:

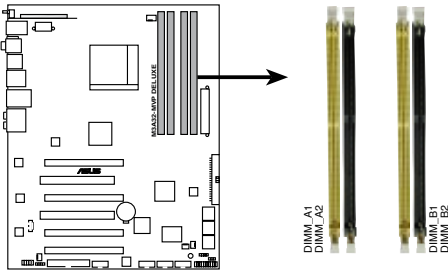

M3A32-MVP DELUXE 240-pin DDR2 DIMM sockets

Channel	Sockets
Channel A	DIMM_A1 and DIMM_A2
Channel B	DIMM_B1 and DIMM_B2

2.4.2 Memory configurations

You may install 256 MB, 512 MB, 1 GB, and 2 GB unbuffered ECC and non-ECC DDR2 DIMMs into the DIMM sockets.

Recommended Memory Configurations

Mode	Sockets			
	DIMM_A1 (yellow)	DIMM_A2 (black)	DIMM_B1 (yellow)	DIMM_B2 (black)
Single-Channel	–	–	Populated	–
	Populated	–	–	–
Dual-channel (1)	Populated	–	Populated	–
Dual-channel (2)	Populated	Populated	Populated	Populated



- You may install varying memory sizes in Channel A and Channel B. The system maps the total size of the lower-sized channel for the dual-channel configuration. Any excess memory from the higher-sized channel is then mapped for single-channel operation.
- Always install DIMMs with the same CAS latency. For optimum compatibility, it is recommended that you obtain memory modules from the same vendor.
- If you install four 1 GB memory modules, the system may only recognize less than 3GB because the address space is reserved for other critical functions. This limitation appears on Windows® XP/Vista 32-bit operation system which does not support Physical Address Extension (PAE).
- If you install Windows® XP/Vista 32-bit operation system, a total memory of less than 3GB is recommended.
- This motherboard does not support memory modules made up of 128 Mb chips.

M3A32-MVP Deluxe Series

Motherboard Qualified Vendors Lists (QVL)

DDR2-800MHz capability for AM2 CPU

Size	Vendor	Chip No.	SS/ DS	Part No.	DIMM support		
					A*	B*	C*
512MB	KINGSTON	K4T51083QC	SS	KVR800D2N5/512	•	•	•
1024MB	KINGSTON	Heat-Sink Package	DS	KHX6400D2LL/1G	•	•	•
1024MB	KINGSTON	Heat-Sink Package	SS	KHX6400D2LLK2/1GN	•	•	•
1024MB	KINGSTON	V59C1512804QBF25	DS	KVR800D2N5/1G	•	•	•
1024MB	KINGSTON	Heat-Sink Package	SS	KHX6400D2ULK2/1G	•	•	•
2048MB	KINGSTON	Heat-Sink Package	DS	KHX6400D2ULK2/2G	•	•	•
512MB	Qimonda	HYB18T512800BF25F	SS	HYS64T64000HU-25F-B		•	•
1024MB	Qimonda	HYB18T512800BF25F	DS	HYS64T128020HU-25F-B	•	•	•
512MB	Hynix	HY5PS12821CFP-S5	SS	HYP564U64CP8-S5			•
1024MB	Hynix	HY5PS12821CFP-S5	DS	HYP512U64CP8-S5		•	
512MB	MICRON	D9GKX	SS	MT8HTF6464AY-80ED4	•	•	•
1024MB	MICRON	D9GKX	DS	MT16HTF12864AY-80ED4	•	•	•
512MB	CORSAIR	Heat-Sink Package	SS	CM2X512A-6400	•	•	•
1024MB	CORSAIR	Heat-Sink Package	DS	CM2X1024-6400C4	•	•	•
512MB	Crucial	Heat-Sink Package	SS	BL6464AA804.8FD	•	•	•
1024MB	Crucial	Heat-Sink Package	DS	BL12864AL804.16FD3		•	•
1024MB	Crucial	Heat-Sink Package	DS	BL12864AA804.16FD3	•	•	•
512MB	Apacer	Heat-Sink Package	DS	AHU512E800C5K1C		•	
512MB	A-DATA	AD26908A8A-25EG	SS	M20AD6G3H3160G1E53	•	•	•
1024MB	A-DATA	AD26908A8A-25EG	DS	M20AD6G3J4170I1E58	•	•	•
512MB	KINGMAX	KK48FEIBF-HJK-25A	SS	KLDC28F-A8K15			•
1024MB	KINGMAX	KK48FEIBF-HJK-25A	DS	KLDD48F-ABK15	•	•	
512MB	Transcend	HY5PS12821CFP-S5	SS	TS64MLQ64V8J			•
1024MB	Transcend	HY5PS12821CFP-S5	DS	TS128MLQ64V8J		•	
512MB	Super Talent	Heat-Sink Package	SS	T800UA12C4	•	•	•
1024MB	Super Talent	Heat-Sink Package	DS	T800UB1GC4	•	•	
512MB	NANYA	NT5TU64M8BE-25C	SS	NT512T64U880BY-25C		•	•
1024MB	NANYA	NT5TU64M8BE-25C	DS	NT1GT64U880BY-25C	•	•	•
512MB	PSC	A3R12E3HEF641B9A05	SS	AL6E8E63B8E1K	•	•	•
1024MB	PSC	A3R12E3HEF641B9A05	DS	AL7E8E63B-8E1K	•	•	
1024MB	Elixir	N2TU51280BE-25C	DS	M2Y1G64TU8HB0B-25C		•	



- A*: Supports one module inserted in any slot as Single-channel memory configuration.
- B*: Supports one pair of modules inserted into either the yellow slots or the black slots as one pair of Dual-channel memory configuration.
- C*: Supports 4 modules inserted into both the yellow and black slots as two pairs of Dual-channel memory configuration.



Visit the ASUS website for the latest DDR2-1066/800/667/533MHz QVL.

M3A32-MVP Deluxe Series

Motherboard Qualified Vendors Lists (QVL)

DDR2-667MHz capability for AM2 CPU

Size	Vendor	Chip No.	SS/ DS	Part No.	DIMM support		
					A*	B*	C*
512MB	KINGSTON	D6408TEBGL3U	SS	KVR667D2N5/512	•	•	•
256MB	KINGSTON	HYB18T256800AF3S	SS	KVR667D2N5/256	•	•	•
256MB	KINGSTON	6SBI2D9DCG	SS	KVR667D2N5/256	•	•	•
2048MB	KINGSTON	E1108AB-6E-E	DS	KVR667D2N5/2G	•	•	•
256MB	Qimonda	HYB18T512160BF-3S	SS	HYS64T32000HU-3S-B		•	•
512MB	Qimonda	HYB18T512800BF3S	SS	HYS64T64000HU-3S-B	•	•	•
1024MB	Qimonda	HYB18T512800BF3S	DS	HYS64T12800HU-3S-B	•	•	
256MB	SAMSUNG	K4T51163QC-ZCE6	SS	M378T3354C20-CE6	•	•	•
512MB	SAMSUNG	ZCE6K4T51083QC	SS	M378T6553C20-CE6	•	•	•
256MB	SAMSUNG	K4T51163QC-ZCE6	SS	M378T3354C23-CE6		•	•
512MB	SAMSUNG	K4T51083QC	SS	M378T6553C23-CE6	•	•	•
1024MB	SAMSUNG	ZCE6K4T51083QC	DS	M378T2953C23-CE6		•	•
512MB	SAMSUNG	K4T51163QE-ZCE6	DS	M378T3354E23-CE6	•	•	•
256MB	SAMSUNG	K4T51083QE	SS	M378T6553E23-CE6	•	•	•
1024MB	SAMSUNG	K4T51083QE	DS	M378T2953E23-CE6	•	•	•
256MB	Hynix	HY5PS121621CFP-Y5	SS	HYMP532U64CP8-Y5	•	•	•
1024MB	Hynix	HY5PS12821CFP-Y5	DS	HYMP512U64CP8-Y5	•	•	•
256MB	CORSAIR	MIII00605	SS	VS256MB667D2	•	•	•
512MB	CORSAIR	64M8CFEG	SS	V512M16667D2	•	•	•
1024MB	CORSAIR	64M8CFEG	DS	V51GB667D2	•	•	•
256MB	ELPIDA	E2508AB-6E-E	SS	EBE25UC8ABFA-6E-E	•	•	•
512MB	A-DATA	AD29608A8A-3EG	SS	M2OAD5G3H316611C52	•	•	•
1024MB	A-DATA	AD29608A8A-3EG	DS	M2OAD5G3I417611C52	•	•	•
2048MB	A-DATA	NT5TU128M8BJ-3C	DS	M2ONY5H3J417011C5Z	•	•	•
512MB	crucial	Heat-Sink Package	SS	BL6464AA663.8FD	•		
1024MB	crucial	Heat-Sink Package	DS	BL12864AA663.16FD	•	•	•
1024MB	crucial	Heat-Sink Package	DS	BL12864AL664.16FD	•	•	•
512MB	Apacer	AM4B5708GQJS7E0628F	SS	AU512E667C5KBGC	•	•	•
1024MB	Apacer	AM4B5708GQJS7E	DS	AU01GE667C5KBGC	•	•	•
512MB	Transcend	K4T51083QE	SS	TS64MLQ64V6J	•		
1024MB	Transcend	K4T51083QE	DS	TS128MLQ64V6J		•	•
256MB	Kingmax	N2TU51216AG-3C	SS	KLCB66F-36KH5	•	•	•
512MB	Kingmax	KKEA88B4LAUG-29DX	SS	KLCC28F-A8KB5	•	•	•
1024MB	Kingmax	KKEA88B4LAUG-29DX	DS	KLCD48F-A8KB5		•	•
512MB	Super Talent	Heat-Sink Package	SS	T6UA512C5	•	•	
1024MB	Super Talent	Heat-Sink Package	DS	T6UB1GC5	•	•	
2048MB	NANYA	NT5TU128M8BJ-3C	DS	NT2GT64UH80JY-3C	•	•	•
512MB	NANYA	NT5TU64M8BE-3C	SS	NT512T64UH80BY-3C	•	•	•
512MB	PSC	A3R12E3GEF637BLC5N	SS	AL6E8E63B-6E1K	•	•	•
1024MB	PSC	A3R12E3GEF637BLC5N	DS	AL7E8E63B-6E1K	•	•	•
512MB	TwinMOS	TMM6208G8M30C	SS	8D-23JK5M2ETP	•		

M3A32-MVP Deluxe Series Motherboard Qualified Vendors Lists (QVL) DDR2-533MHz capability for AM2 CPU

Size	Vendor	Chip No.	SS/ DS	Part No.	DIMM support		
					A*	B*	C*
512MB	KINGSTON	HYB18T512800AF37	SS	KVR533D2N4/512	•	•	•
1024MB	KINGSTON	D6408TPAGGL3U	DS	KVR533D2N4/1G	•	•	
2048MB	KINGSTON	E1108AB-6E-E	DS	KVR533D2N4/2G	•	•	
512MB	Qimonda	HYB18T512800BF37	SS	HYS64T64000HU-3.7-B	•	•	•
1024MB	Qimonda	HYB18T512800BF37	DS	HYS64T128020HU-3.7-B	•	•	
256MB	SAMSUNG	K4T51163QC-ZCD5	SS	M378T3354CZ3-CD5	•	•	•
512MB	SAMSUNG	ZCD5K4T51083QC	SS	M378T6553CZ3-CD5	•	•	
1024MB	SAMSUNG	ZCD5K4T51083QC	DS	M378T2953CZ3-CD5	•	•	
256MB	Hynix	HY5PS121621CFP-C4	SS	HYMP532U64CP6-C4	•	•	•
1024MB	Hynix	HY5PS12821CFP-C4	DS	HYMP512U64CP8-C4	•	•	
256MB	CORSAIR	32M16CEDG	SS	VS256MB533D2	•	•	•
1024MB	CORSAIR	64M8CEDG	DS	VS1GB533D2	•	•	
512MB	ELPIDA	E5108AB-5C-E	SS	EBE51UD8ABFA-5C-E	•	•	
512MB	KINGMAX	E5108AE-5C-E	SS	KLBC28F-A8EB4	•	•	•
512MB	KINGMAX	KKEA88E4AAK-37	SS	KLBC28F-A8KE4	•	•	•
1024MB	KINGMAX	5MB22D9DCN	DS	KLBD48F-A8ME4		•	
512MB	Apacer	AM4B5708GQJS5D	SS	AU512E533C4KBGC	•	•	•
1024MB	Apacer	AM4B5708GQJS5D	DS	AU01GE533C4KBGC	•	•	
512MB	Super Talent	Heat-Sink Package	SS	T5UA512C4	•	•	
1024MB	Super Talent	Heat-Sink Package	DS	T5UB1GB4C4	•	•	

2.4.3 Installing a DIMM



Unplug the power supply before adding or removing DIMMs or other system components. Failure to do so can cause severe damage to both the motherboard and the components.

To install a DIMM:

1. Unlock a DIMM socket by pressing the retaining clips outward.
2. Align a DIMM on the socket such that the notch on the DIMM matches the break on the socket.
3. Firmly insert the DIMM into the socket until the retaining clips snap back in place and the DIMM is properly seated.

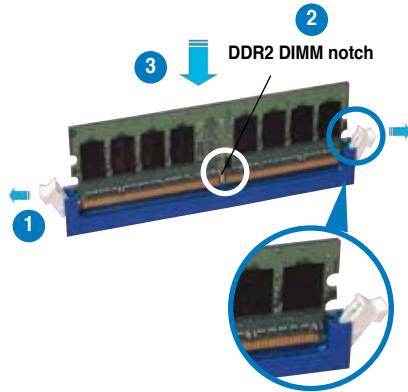

Unlocked retaining clip



- A DDR2 DIMM is keyed with a notch so that it fits in only one direction. Do not force a DIMM into a socket to avoid damaging the DIMM.
- The DDR2 DIMM sockets do not support DDR DIMMs. DO not install DDR DIMMs to the DDR2 DIMM sockets.

2.4.4 Removing a DIMM

To remove a DIMM:

1. Simultaneously press the retaining clips outward to unlock the DIMM.



Support the DIMM lightly with your fingers when pressing the retaining clips. The DIMM might get damaged when it flips out with extra force.

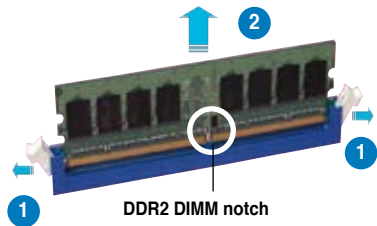

2. Remove the DIMM from the socket.

2.4.5 Installing ASUS Cool Mempipe

Install ASUS Cool Mempipe to your motherboard to achieve excellent thermal dissipation for your memory modules.

To install ASUS Cool Mempipe:

1. Secure the motherboard to your chassis with nine screws.
2. Install memory modules to sockets DIMM_A1/B1 first.



3. Loosen the four nuts to part the heat spreaders.
4. Remove the four pieces of protective film on the heat spreaders.

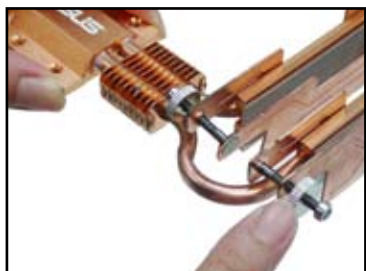

5. Align the Cool Mempipe with the northbridge heatsink and ensure the memory modules are located between the heat spreaders.
6. Fasten the Cool Mempipe to the northbridge heatsink with four screws.



7. Adjust the heatpipe until the heat spreaders contact the memory modules.

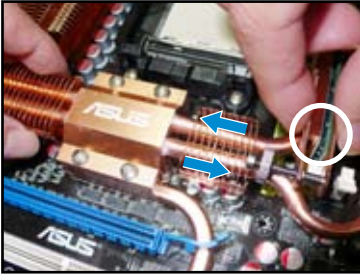

8. Firmly press the heat spreaders against the memory modules.

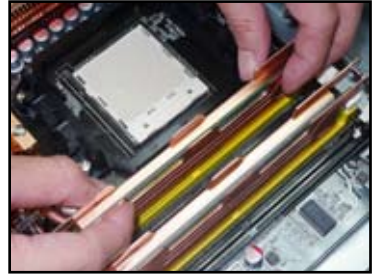

9. Hold the heat spreaders and secure the four nuts. DO NOT overtighten the nuts.

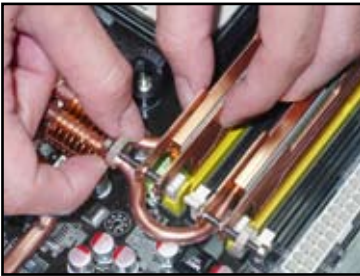

10. Install another two memory modules to sockets DIMM_A2/ B2 if necessary.

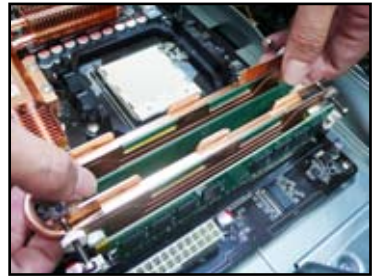

Install memory modules to sockets DIMM_A2 and DIMM_B2 after the completion of Cool Mempoise installation.

2.5 Expansion slots

In the future, you may need to install expansion cards. The following sub-sections describe the slots and the expansion cards that they support.



Make sure to unplug the power cord before adding or removing expansion cards. Failure to do so may cause you physical injury and damage motherboard components.

2.5.1 Installing an expansion card

To install an expansion card:

1. Before installing the expansion card, read the documentation that came with it and make the necessary hardware settings for the card.
2. Remove the system unit cover (if your motherboard is already installed in a chassis).
3. Remove the bracket opposite the slot that you intend to use. Keep the screw for later use.
4. Align the card connector with the slot and press firmly until the card is completely seated on the slot.
5. Secure the card to the chassis with the screw you removed earlier.
6. Replace the system cover.

2.5.2 Configuring an expansion card

After installing the expansion card, configure the it by adjusting the software settings.

1. Turn on the system and change the necessary BIOS settings, if any. See Chapter 4 for information on BIOS setup.
2. Assign an IRQ to the card. Refer to the tables on the next page.
3. Install the software drivers for the expansion card.



When using PCI cards on shared slots, ensure that the drivers support “Share IRQ” or that the cards do not need IRQ assignments; otherwise, conflicts will arise between the two PCI groups, making the system unstable and the card inoperable.

2.5.3 Interrupt assignments

Standard interrupt assignments

IRQ	Priority	Standard function
0	1	System Timer
1	2	Keyboard Controller
2	–	Redirect to IRQ#9
4	12	Communications Port (COM1)*
5	13	IRQ Holder for PCI Steering*
6	14	Floppy Disk Controller
7	15	Reserved
8	3	System CMOS/Real Time Clock
9	4	IRQ Holder for PCI Steering*
10	5	IRQ Holder for PCI Steering*
11	6	IRQ Holder for PCI Steering*
12	7	Reserved
13	8	Numeric Data Processor
14	9	Primary IDE Channel

* These IRQs are usually available for ISA or PCI devices.

IRQ assignments for this motherboard

	A	B	C	D	E	F	G	H
PCIe x16_1	shared	shared	shared	shared	–	–	–	–
PCIe x16_2	shared	shared	shared	shared	–	–	–	–
PCIe x16_3	shared	shared	shared	shared	–	–	–	–
PCIe x16_4	shared	shared	shared	shared	–	–	–	–
USB 1.0 controller 1	–	–	–	shared	–	–	–	–
USB 1.0 controller 2	–	–	–	shared	–	–	–	–
USB 1.0 controller 3	–	–	–	shared	–	–	–	–
USB 1.0 controller 4	–	–	–	shared	–	–	–	–
USB 2.0 controller	–	–	–	shared	–	–	–	–
HD audio	shared	–	–	–	–	–	–	–
Onboard SATA	–	–	–	–	–	shared	–	–

2.5.4 PCI slots

The PCI slots support cards such as a LAN card, SCSI card, USB card, and other cards that comply with PCI specifications. Refer to the figure below for the location of the slots.

2.5.5 Four PCI Express x16 slots

This motherboard supports four ATI CrossFireX™ PCI Express x16 graphics cards that comply with the PCI Express specifications. With four graphics cards installed, the motherboard can enable quad-display. Refer to the figure below for the location of the slots.

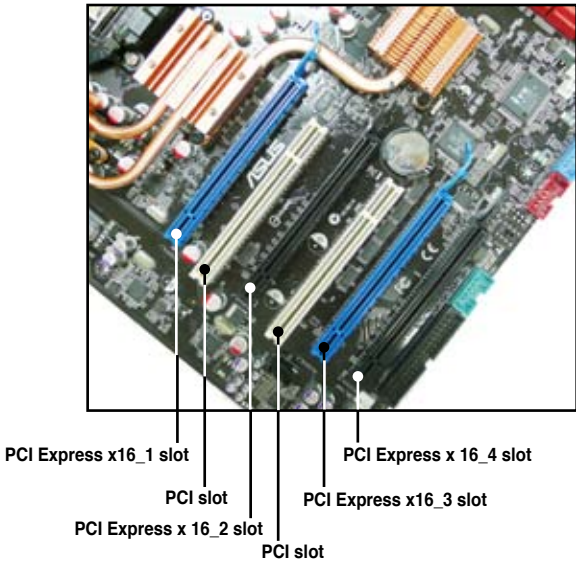

Primary PCI Express x16 slots

The primary PCI Express x16 slots support PCI Express x16 graphics cards that comply with the PCI Express specifications.

Universal PCI Express x16 slots (max. x8 mode)

This motherboard also supports universal PCI Express x16 slots with a maximum speed of 8 GB/s. The operating frequency of this slot changes, depending on the type of PCI Express card you install. Refer to the table below for details.



If you install multiple VGA cards, we recommend that you plug the rear chassis fan cable to the motherboard connector labeled CHA_FAN1/2 for better thermal environment. See page 2-34 for the connector location.

VGA configuration	PCI Express operating mode			
	PClex16_1	PClex16_2	PClex16_3	PClex16_4
Single VGA/PCIe card	x16	x1	x16	x1
Dual VGA/PCIe card	x16	x1	x16	x1
Triple VGA/PCIe card	x16	x1	x8	x8
	x8	x8	x16	x1
Quad VGA card	x8	x8	x8	x8



- When using one VGA card and a x4 PCIe card at the same time, install them to the blue slots.
- If you install two VGA cards to the blue slots and use other x4 PCIe cards simultaneously, the x4 PCIe cards will downgrade to x1 mode for optimum VGA performance. You may reassign PCIe width in BIOS settings. Refer to page 4-24 for details.

2.6 Jumper

Clear RTC RAM (3-pin CLRRTC)

This jumper allows you to clear the Real Time Clock (RTC) RAM in CMOS. You can clear the CMOS memory of date, time, and system setup parameters by erasing the CMOS RTC RAM data. The onboard button cell battery powers the RAM data in CMOS, which include system setup information such as system passwords.

To erase the RTC RAM:

1. Turn OFF the computer and unplug the power cord.
2. Remove the onboard battery.
3. Move the jumper cap from pins 1-2 (default) to pins 2-3. Keep the cap on pins 2-3 for about 5~10 seconds, then move the cap back to pins 1-2.
4. Reinstall the battery.
5. Plug the power cord and turn ON the computer.
6. Hold down the key during the boot process and enter BIOS setup to re-enter data.



Except when clearing the RTC RAM, never remove the cap on CLRRTC jumper default position. Removing the cap will cause system boot failure!

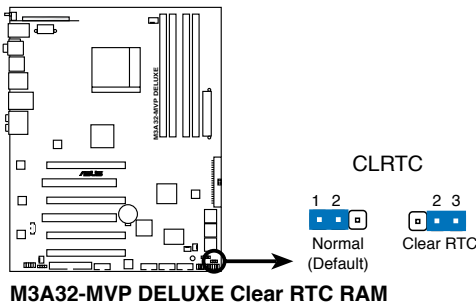

- You do not need to clear the RTC when the system hangs due to overclocking. For system failure due to overclocking, use the C.P.R. (CPU Parameter Recall) feature. Shut down and reboot the system so the BIOS can automatically reset parameter settings to default values.
 - Due to the chipset limitation, AC power off is required prior using C.P.R. function. You must turn off and on the power supply or unplug and plug the power cord before reboot the system.
-

2.7 Connectors

2.7.1 Rear panel connectors

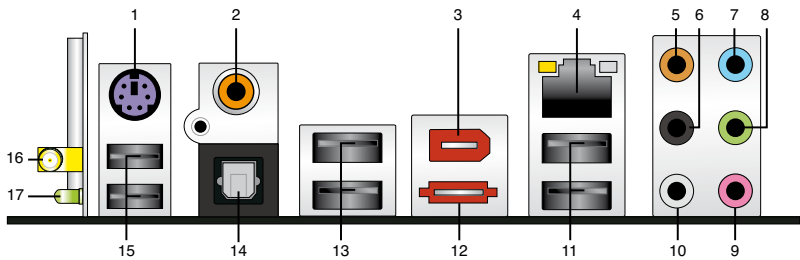

1. **PS/2 keyboard port (purple).** This port is for a PS/2 keyboard.
2. **Coaxial S/PDIF Out port.** This port connects an external audio output device via a coaxial S/PDIF cable.
3. **IEEE 1394a port.** This 6-pin IEEE 1394a port provides high-speed connectivity for audio/video devices, storage peripherals, PCs, or portable devices.
4. **LAN (RJ-45) port.** Supported by Marvell® 88E1116 Gigabit LAN controller, this port allows Gigabit connection to a Local Area Network (LAN) through a network hub. Refer to the table below for the LAN port LED indications.

LAN port LED indications

Activity/Link LED		Speed LED	
Status	Description	Status	Description
OFF	No link	OFF	10 Mbps connection
ORANGE	Linked	ORANGE	100 Mbps connection
BLINKING	Data activity	GREEN	1 Gbps connection

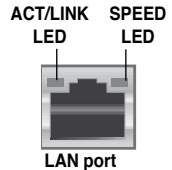

5. **Center/Subwoofer port (orange).** This port connects the center/subwoofer speakers.
6. **Rear Speaker Out port (black).** This port connects the rear speakers in a 4-channel, 6-channel, or 8-channel audio configuration.
7. **Line In port (light blue).** This port connects the tape, CD, DVD player, or other audio sources.
8. **Line Out port (lime).** This port connects a headphone or a speaker. In 4-channel, 6-channel, and 8-channel configuration, the function of this port becomes Front Speaker Out.
9. **Microphone port (pink).** This port connects a microphone.
10. **Side Speaker Out port (gray).** This port connects the side speakers in an 8-channel audio configuration.



Refer to the audio configuration table below for the function of the audio ports in 2, 4, 6, or 8-channel configuration.

Audio 2, 4, 6, or 8-channel configuration

Port	Headset 2-channel	4-channel	6-channel	8-channel
Light Blue	Line In	Line In	Line In	Line In
Lime	Line Out	Front Speaker Out	Front Speaker Out	Front Speaker Out
Pink	Mic In	Mic In	Mic In	Mic In
Orange	–	–	Center/Subwoofer	Center/Subwoofer
Black	–	Rear Speaker Out	Rear Speaker Ou	Rear Speaker Out
Gray	–	–	–	Side Speaker Out

- USB 2.0 ports 1 and 2.** These 4-pin Universal Serial Bus (USB) ports are available for connecting USB 2.0 devices.
- External SATA port.** This port connects an external Serial ATA hard disk drive.



The external SATA port supports external Serial ATA 3.0 Gb/s devices. Longer cables support higher power requirements to deliver signal up to two meters away, and enables improved hot-swap function.



DO NOT insert a different connector to this port.

- USB 2.0 ports 3 and 4.** These 4-pin Universal Serial Bus (USB) ports are available for connecting USB 2.0 devices.
- Optical S/PDIF Out port.** This port connects an external audio output device via an optical S/PDIF cable.
- USB 2.0 ports 5 and 6.** These 4-pin Universal Serial Bus (USB) ports are available for connecting USB 2.0 devices.

For WiFi-AP Edition Only:

Refer to the WiFi-AP Solo user guide for detailed settings.

- 16. Wireless LAN port.** This port is on the onboard wireless LAN module that allows you to set up a wireless network and exchange information with other wireless devices without tagging cables and wires. Connect the moveable omni-directional antenna to this port.
- 17. Wireless LAN Activity LED.** The wireless module comes with an activity LED.

2.7.2 Internal connectors

1. Floppy disk drive connector (34-1 pin FLOPPY)

This connector is for the provided floppy disk drive (FDD) signal cable. Insert one end of the cable to this connector, then connect the other end to the signal connector at the back of the floppy disk drive.



Pin 5 on the connector is removed to prevent incorrect cable connection when using a FDD cable with a covered Pin 5.

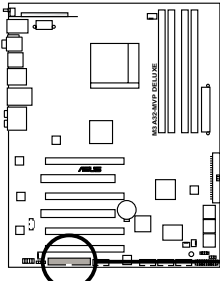

M3A32-MVP DELUXE
Floppy disk drive connector

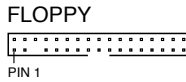

NOTE: Orient the red markings on the floppy ribbon cable to PIN 1.

2. IDE connector (40-1 pin PRI_IDE)

The onboard IDE connector is for the Ultra DMA 133/100/66 signal cable. There are three connectors on each Ultra DMA 133/100/66 signal cable: blue, black, and gray. Connect the blue connector to the motherboard's IDE connector, then select one of the following modes to configure your device.

	Drive jumper setting	Mode of device(s)	Cable connector
Single device	Cable-Select or Master	–	Black
Two devices	Cable-Select	Master	Black
		Slave	Gray
	Master	Master	Black or gray
	Slave	Slave	



- Pin 20 on the IDE connector is removed to match the covered hole on the Ultra DMA cable connector. This prevents incorrect insertion when you connect the IDE cable.
- Use the 80-conductor IDE cable for Ultra DMA 100/66 IDE devices.



If any device jumper is set as "Cable-Select," make sure all other device jumpers have the same setting.

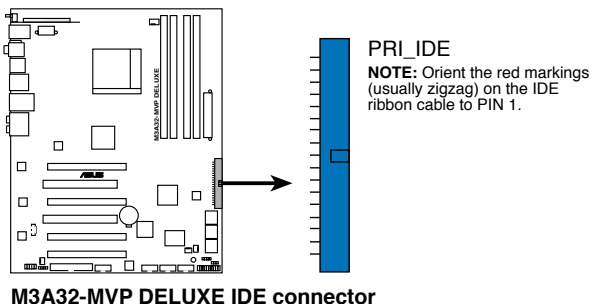

3. AMD® SB600 Southbridge Serial ATA connectors (7-pin SATA1 [red]; SATA2 [black]; SATA3 [red]; SATA4 [black])

These connectors are for the Serial ATA signal cables for Serial ATA hard disk and optical disk drives.

If you install SATA hard disk drives to the SATA1/2/3/4 connectors, you can create a RAID 0, RAID 1, or RAID 0+1 configuration through the onboard AMD® SB600 controller.



- These connectors are set to [IDE] by default. If you intend to create a Serial ATA RAID set using these connectors, set the **Onchip SATA Type** item in the BIOS to [RAID]. See section 4.3.6 **Storage Configuration** for details.
- Before creating a RAID set, refer to **5.4 RAID Configurations** or the manual bundled in the motherboard support DVD.

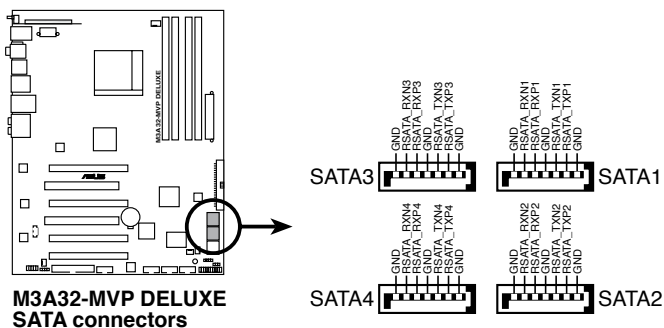



- You must install the Windows® XP Service Pack 1 before using Serial ATA hard disk drives. The Serial ATA RAID feature (RAID 0 and RAID 1) is available only if you are using Windows® XP or later version.
- When using the connectors in Native IDE mode, connect the primary (boot) hard disk drive to the SATA1/3 connector. Refer to the table below for the recommended SATA hard disk drive connections.

Serial ATA hard disk drive connection

Connector	Color	Setting	Use
SATA 1/3	Red	Master	Boot disk
SATA 2/4	Black	Slave	Data disk



Connect the right-angle side of SATA signal cable to SATA device. Or you may connect the right-angle side of SATA cable to the onboard SATA port to avoid mechanical conflict with huge graphics cards.

right angle side

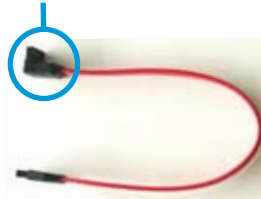

4. Marvell® 6121 Serial ATA RAID connector (7-pin SATA_RAID1/2)

This connector is for a Serial ATA signal cable that supports a Serial ATA hard disk drive. To configure RAID 0 or RAID 1, install two internal Serial ATA hard disk drives to the SATA_RAID1/2 connectors.



The **Marvell IDE/RAID function** item in BIOS is set to [IDE] by default. Setting this item to [RAID] allows you to use the connectors to build a RAID set. See section 4.4.5 **Onboard Devices Configuration** for details.

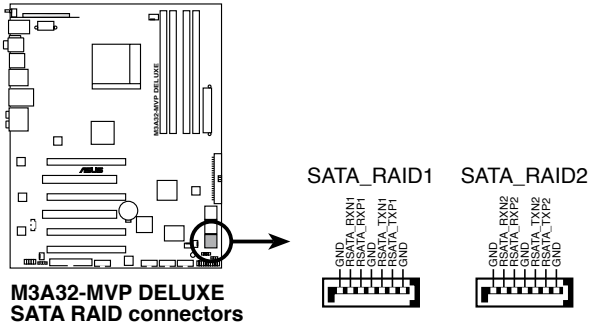

Before creating a RAID set using Serial ATA hard disks, make sure that you have connected the Serial ATA signal cables and installed Serial ATA hard disk drives; otherwise, you cannot enter the Marvell RAID BIOS Configuration utility and SATA BIOS setup during POST.

5. USB connectors (10-1 pin USB 78; USB910)

These connectors are for USB 2.0 ports. Connect the USB module cable to any of these connectors, then install the module to a slot opening at the back of the system chassis. These USB connectors comply with USB 2.0 specification that supports up to 480 Mbps connection speed.

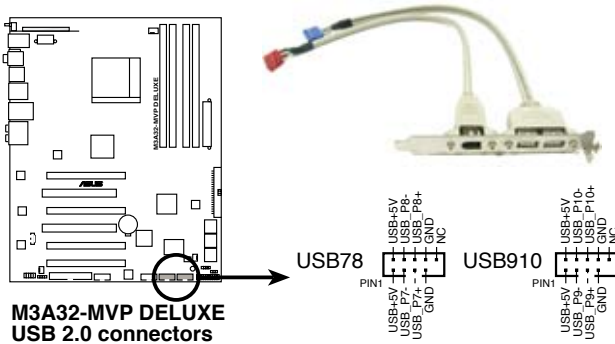

Never connect a 1394 cable to the USB connectors. Doing so will damage the motherboard!



You can connect the front panel USB cable to the ASUS Q-Connector (USB, blue) first, and then install the Q-Connector (USB) to the USB connector onboard if your chassis supports front panel USB ports.

6. IEEE 1394a port connector (10-1 pin IE1394_2)

This connector is for a IEEE 1394a port. Connect the IEEE 1394a module cable to this connector, then install the module to a slot opening at the back of the system chassis.

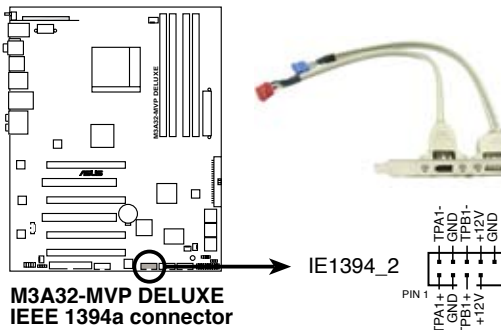



Never connect a USB cable to the IEEE 1394a connector. Doing so will damage the motherboard!



You can connect the front panel 1394 cable to the ASUS Q-Connector (1394, red) first, and then install the Q-Connector (1394) to the 1394 connector onboard if your chassis supports front panel 1394 ports.

7. CPU, chassis, and power fan connectors (4-pin CPU_FAN; 3-pin CHA_FAN1; 3-pin CHA_FAN2; 3-pin PWR_FAN)

The fan connectors support cooling fans of 350 mA~2000 mA (24 W max.) or a total of 1 A~7 A (84 W max.) at +12V. Connect the fan cables to the fan connectors on the motherboard, making sure that the black wire of each cable matches the ground pin of the connector.



Do not forget to connect the fan cables to the fan connectors. Insufficient air flow inside the system may damage the motherboard components. These are not jumpers! Do not place jumper caps on the fan connectors!

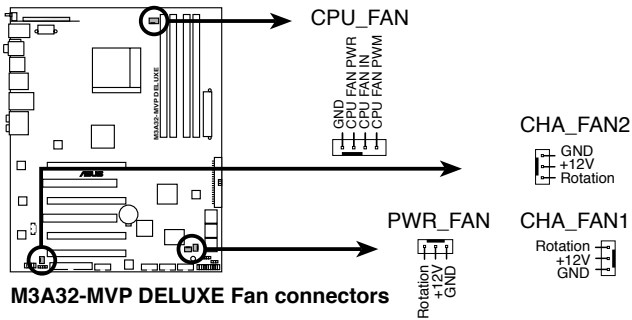

- Only the CPU_FAN and CHA_FAN 1 connectors support the ASUS Q FAN2 feature.
- If you install two VGA cards, we recommend that you plug the rear chassis fan cable to the motherboard connector labeled CHA_FAN1 or CHA_FAN2 for better thermal environment.

8. Chassis intrusion connector (4-1 pin CHASSIS)

This connector is for a chassis-mounted intrusion detection sensor or switch. Connect one end of the chassis intrusion sensor or switch cable to this connector. The chassis intrusion sensor or switch sends a high-level signal to this connector when a chassis component is removed or replaced. The signal is then generated as a chassis intrusion event.

By default , the pin labeled “Chassis Signal” and “Ground” are shorted with a jumper cap. Remove the jumper caps only when you intend to use the chassis intrusion detection feature.

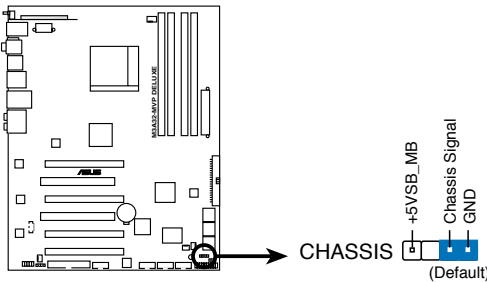

M3A32-MVP DELUXE
Chassis intrusion connector

9. ATX power connectors (24-pin EATXPWR; 8-pin ATX12V)

These connectors are for ATX power supply plugs. The power supply plugs are designed to fit these connectors in only one orientation. Find the proper orientation and push down firmly until the connectors completely fit.

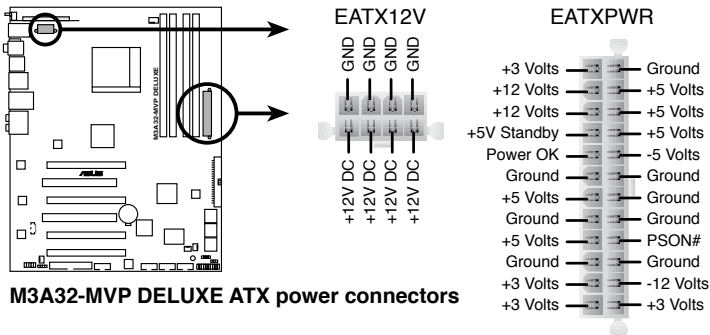

M3A32-MVP DELUXE ATX power connectors



- For a fully configured system, we recommend that you use a power supply unit (PSU) that complies with ATX 12 V Specification 2.0 (or later version) and provides a minimum power of 600 W.
- Do not forget to connect the 8-pin ATX +12 V power plug; otherwise, the system will not boot.
- Use of a PSU with a higher power output is recommended when configuring a system with more power-consuming devices. The system may become unstable or may not boot up if the power is inadequate.
- If you are uncertain about the minimum power supply requirement for your system, refer to the **Recommended Power Supply Wattage Calculator** at <http://support.asus.com/PowerSupplyCalculator/PSCalculator.aspx?SLanguage=en-us> for details.
- The ATX 12 V Specification 2.0-compliant (500W) PSU has been tested to support the motherboard power requirements with the following configuration:
CPU: AMD FX-62
Memory 1024 MB DDR2-800 (x4)
Graphics card: PCI Express x16 NVIDIA 7900GTX
Serial ATA device: SATA hard disk drive (x2)
Optical drives: DVD-RW

10. Front panel audio connector (10-1 pin AAFP)

This connector is for a chassis-mounted front panel audio I/O module that supports either HD Audio or legacy AC '97 audio standard. Connect one end of the front panel audio I/O module cable to this connector.

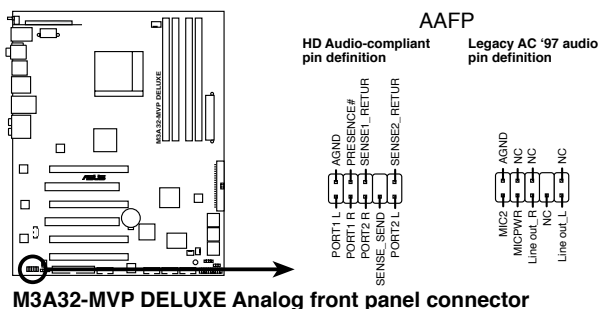

- We recommend that you connect a high-definition front panel audio module to this connector to avail of the motherboard's high-definition audio capability.
- If you want to connect a high-definition front panel audio module to this connector, set the **Front Panel Support Type** item in the BIOS setup to **[HD Audio]**; if you want to connect an AC'97 front panel audio module to this connector, set the item to **[AC97]**. By default, this connector is set to **[HD Audio]**. See section 4.4.5 **Onboard Devices Configuration** for details.

11. Optical drive audio connector (4-pin CD)

These connectors allow you to receive stereo audio input from sound sources such as a CD-ROM, TV tuner, or MPEG card.

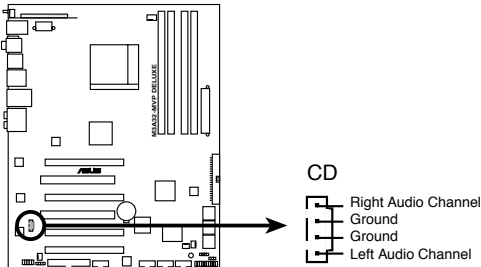

M3A32-MVP DELUXE Internal audio connector

12. Serial port connector (10-1 pin COM1)

This connector is for a serial (COM) port. Connect the serial port module cable to this connector, then install the module to a slot opening at the back of the system chassis.

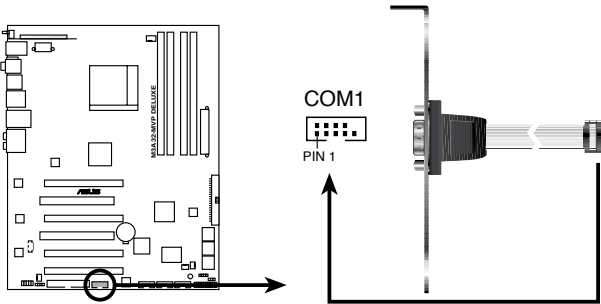

M3A32-MVP DELUXE COM port connector



The COM module is purchased separately.

13. Digital audio connector (4-1 pin SPDIF_OUT)

This connector is for an additional Sony/Philips Digital Interface (S/PDIF) port(s). Connect the S/PDIF Out module cable to this connector, then install the module to a slot opening at the back of the system chassis.

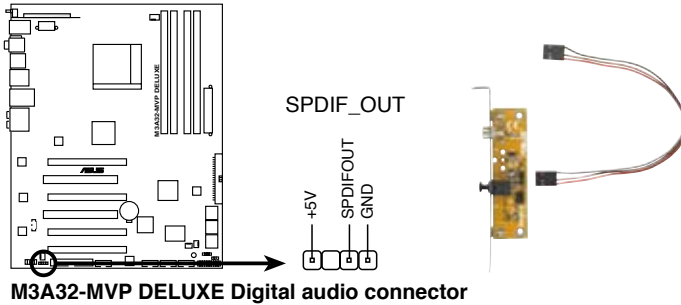

The S/PDIF module is purchased separately.

14. System panel connector (20-8 pin PANEL)

This connector supports several chassis-mounted functions.

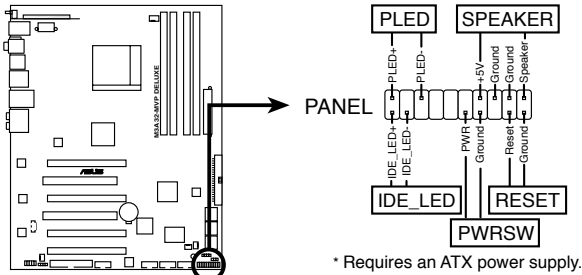

M3A32-MVP DELUXE System panel connector

- **System power LED (2-pin PLED)**

This 2-pin connector is for the system power LED. Connect the chassis power LED cable to this connector. The system power LED lights up when you turn on the system power, and blinks when the system is in sleep mode.

- **Hard disk drive activity LED (2-pin IDE_LED)**

This 2-pin connector is for the HDD Activity LED. Connect the HDD Activity LED cable to this connector. The IDE LED lights up or flashes when data is read from or written to the HDD.

- **System warning speaker (4-pin SPEAKER)**

This 4-pin connector is for the chassis-mounted system warning speaker. The speaker allows you to hear system beeps and warnings.

- **ATX power button/soft-off button (2-pin PWRSR)**

This connector is for the system power button. Pressing the power button turns the system on or puts the system in sleep or soft-off mode depending on the BIOS settings. Pressing the power switch for more than four seconds while the system is ON turns the system OFF.

- **Reset button (2-pin RESET)**

This 2-pin connector is for the chassis-mounted reset button for system reboot without turning off the system power.

ASUS Q-Connector (system panel)

You can use the ASUS Q-Connector to connect/disconnect chassis front panel cables in a few steps. Refer to the instructions below to install the ASUS Q-Connector.

1. Connect the front panel cables to the ASUS Q-Connector.

Refer to the labels on the Q-Connector to know the detailed pin definitions, then match them to the respective front panel cable labels.

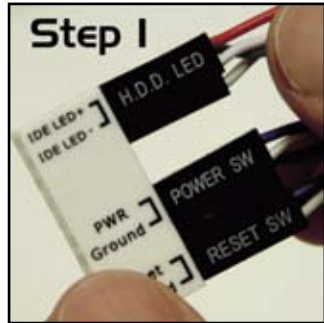

2. Install the ASUS Q-Connector to the system panel connector, making sure the orientation matches the labels on the motherboard.

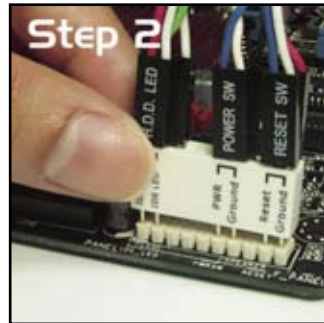

3. The front panel functions are now enabled. The figure shows the Q-Connector properly installed on the motherboard.

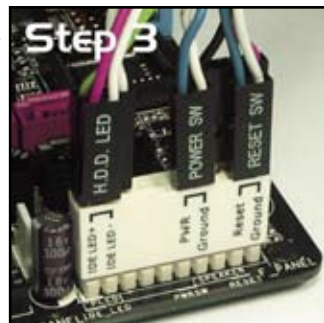

This chapter describes the power up sequence, the vocal POST messages, and ways of shutting down the system.

Powering up **3**

Chapter summary

3

3.1	Starting up for the first time.....	3-1
3.2	Turning off the computer.....	3-2

3.1 Starting up for the first time

1. After making all the connections, replace the system case cover.
2. Be sure that all switches are off.
3. Connect the power cord to the power connector at the back of the system chassis.
4. Connect the power cord to a power outlet that is equipped with a surge protector.
5. Turn on the devices in the following order:
 - a. Monitor
 - b. External SCSI devices (starting with the last device on the chain)
 - c. System power
6. After applying power, the system power LED on the system front panel case lights up. For systems with ATX power supplies, the system LED lights up when you press the ATX power button. If your monitor complies with “green” standards or if it has a “power standby” feature, the monitor LED may light up or switch between orange and green after the system LED turns on.

The system then runs the power-on self tests or POST. While the tests are running, the BIOS beeps (see BIOS beep codes table below) or additional messages appear on the screen. If you do not see anything within 30 seconds from the time you turned on the power, the system may have failed a power-on test. Check the jumper settings and connections or call your retailer for assistance.
7. At power on, hold down the <Delete> key to enter the BIOS Setup. Follow the instructions in Chapter 4.

3.2 Turning off the computer

3.2.1 Using the OS shut down function

If you are using Windows® XP:

1. Click the **Start** button then select **Turn Off Computer**.
2. Click the **Turn Off** button to shut down the computer.
3. The power supply should turn off after Windows® shuts down.

If you are using Windows® Vista™:

1. Click the **Start** button then select **ShutDown**.
2. The power supply should turn off after Windows® shuts down.

3.2.2 Using the dual function power switch

While the system is ON, pressing the power switch for less than four seconds puts the system to sleep mode or to soft-off mode, depending on the BIOS setting. Pressing the power switch for more than four seconds lets the system enter the soft-off mode regardless of the BIOS setting. Refer to section “4.5 Power Menu” in Chapter 4 for details.

This chapter tells how to change the system settings through the BIOS Setup menus. Detailed descriptions of the BIOS parameters are also provided.

BIOS setup **4**

4.1	Managing and updating your BIOS	4-1
4.2	BIOS setup program	4-9
4.3	Main menu	4-12
4.4	Advanced menu	4-16
4.5	Power menu.....	4-28
4.6	Boot menu	4-32
4.7	Tools menu	4-36
4.8	Exit menu	4-38

4.1 Managing and updating your BIOS

The following utilities allow you to manage and update the motherboard Basic Input/Output System (BIOS) setup.

1. **ASUS Update** (Updates the BIOS in Windows® environment.)
2. **ASUS EZ Flash 2** (Updates the BIOS using a floppy disk or USB flash disk.)
3. **ASUS AFUDOS** (Updates the BIOS using a bootable floppy disk.)
4. **ASUS CrashFree BIOS 3** (Updates the BIOS using a bootable floppy disk, USB flash disk or the motherboard support DVD when the BIOS file fails or gets corrupted.)

Refer to the corresponding sections for details on these utilities.



Save a copy of the original motherboard BIOS file to a bootable floppy disk or USB flash disk in case you need to restore the BIOS in the future. Copy the original motherboard BIOS using the ASUS Update or AFUDOS utilities.

4.1.1 ASUS Update utility

The ASUS Update is a utility that allows you to manage, save, and update the motherboard BIOS in Windows® environment. The ASUS Update utility allows you to:

- Save the current BIOS file
- Download the latest BIOS file from the Internet
- Update the BIOS from an updated BIOS file
- Update the BIOS directly from the Internet, and
- View the BIOS version information.

This utility is available in the support DVD that comes with the motherboard package.



ASUS Update requires an Internet connection either through a network or an Internet Service Provider (ISP).

Installing ASUS Update

To install ASUS Update:

1. Place the support DVD in the optical drive. The Drivers menu appears.
2. Click the **Utilities** tab, then click **Install ASUS Update**.
3. The ASUS Update utility is copied to your system.



Quit all Windows® applications before you update the BIOS using this utility.

Updating the BIOS through the Internet

To update the BIOS through the Internet:

1. Launch the ASUS Update utility from the Windows® desktop by clicking **Start > Programs > ASUS > ASUSUpdate > ASUSUpdate**. The ASUS Update main window appears.

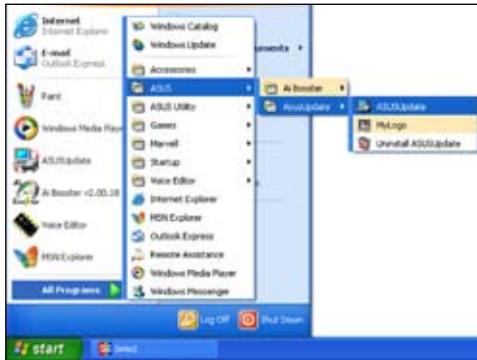

2. Select **Update BIOS** from the Internet option from the drop-down menu, then click **Next**.



3. Select the ASUS FTP site nearest you to avoid network traffic, or click **Auto Select**. Click **Next**.

- From the FTP site, select the BIOS version that you wish to download. Click **Next**.
- Follow the screen instructions to complete the update process.



The ASUS Update utility is capable of updating itself through the Internet. Always update the utility to avail all its features.



Updating the BIOS through a BIOS file

To update the BIOS through a BIOS file:

- Launch the ASUS Update utility from the Windows® desktop by clicking **Start > Programs > ASUS > ASUSUpdate > ASUSUpdate**. The ASUS Update main window appears.
- Select Update BIOS from a file option from the drop-down menu, then click **Next**.



- Locate the BIOS file from the Open window, then click **Open**.
- Follow the screen instructions to complete the update process.

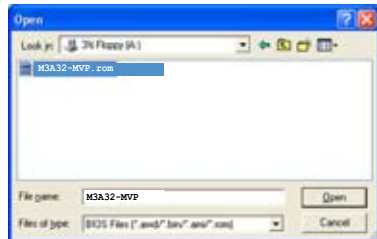

4.1.2 Creating a bootable floppy disk

1. Do either one of the following to create a bootable floppy disk.

DOS environment

- a. Insert a 1.44MB floppy disk into the drive.
- b. At the DOS prompt, type `format a: /s` then press <Enter>.

Windows® XP environment

- a. Insert a 1.44 MB floppy disk to the floppy disk drive.
 - b. Click **Start** from the Windows® desktop, then select **My Computer**.
 - c. Select the 3 1/2 Floppy Drive icon.
 - d. Click File from the menu, then select **Format**. A **Format 3 1/2 Floppy Disk** window appears.
 - e. Select **Create an MS-DOS startup disk** from the format options field, then click **Start**.
2. Copy the original or the latest motherboard BIOS file to the bootable floppy disk.

4.1.3 ASUS EZ Flash 2 utility

The ASUS EZ Flash 2 feature allows you to update the BIOS without having to go through the long process of booting from a floppy disk and using a DOS-based utility. The EZ Flash 2 utility is built-in the BIOS chip so it is accessible by pressing <Alt> + <F2> during the Power-On Self Tests (POST).

To update the BIOS using EZ Flash 2:

1. Visit the ASUS website (www.asus.com) to download the latest BIOS file for the motherboard.
2. Save the BIOS file to a floppy disk or a USB flash disk, then restart the system.
3. You can launch the EZ Flash 2 by two methods.
 - (1) Insert the floppy disk / USB flash disk that contains the BIOS file to the floppy disk drive or the USB port.

Press <Alt> + <F2> during POST to display the following.

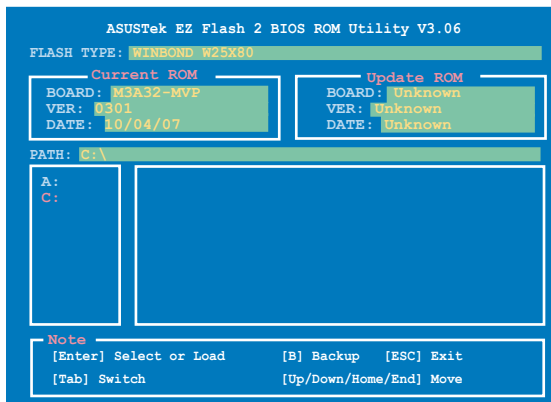

- (2) Enter BIOS setup program. Go to the **Tools** menu to select **EZ Flash2** and press <Enter> to enable it.
You can switch between drives by pressing <Tab> before the correct file is found. Then press <Enter>.
4. When the correct BIOS file is found, EZ Flash 2 performs the BIOS update process and automatically reboots the system when done.



- This function can support devices such as USB flash disk, or floppy disk with **FAT 32/16** format and single partition only.
- Do not shut down or reset the system while updating the BIOS to prevent system boot failure!

4.1.4 AFUDOS utility

The AFUDOS utility allows you to update the BIOS file in DOS environment using a bootable floppy disk with the updated BIOS file. This utility also allows you to copy the current BIOS file that you can use as backup when the BIOS fails or gets corrupted during the updating process.

Copying the current BIOS

To copy the current BIOS file using the AFUDOS utility:



- Make sure that the floppy disk is not write-protected and has at least 1024KB free space to save the file.
- The succeeding BIOS screens are for reference only. The actual BIOS screen displays may not be same as shown.

1. Copy the AFUDOS utility (afudos.exe) from the motherboard support DVD to the bootable floppy disk you created earlier.
2. Boot the system in DOS mode, then at the prompt type:

```
afudos /o[filename]
```

where the [filename] is any user-assigned filename not more than eight alphanumeric characters for the main filename and three alphanumeric characters for the extension name.

```
A:\>afudos /oOLDBIOS1.rom
```

Main filename Extension name

3. Press <Enter>. The utility copies the current BIOS file to the floppy disk.

```
A:\>afudos /oOLDBIOS1.rom
AMI Firmware Update Utility - Version 1.19(ASUS V2.07(03.11.24BB))
Copyright (C) 2002 American Megatrends, Inc. All rights reserved.
  Reading flash ..... done
  Write to file..... ok
A:\>
```

The utility returns to the DOS prompt after copying the current BIOS file.

Updating the BIOS file

To update the BIOS file using the AFUDOS utility:

1. Visit the ASUS website (www.asus.com) and download the latest BIOS file for the motherboard. Save the BIOS file to a bootable floppy disk.



Write the BIOS filename on a piece of paper. You need to type the exact BIOS filename at the DOS prompt.

2. Copy the AFUDOS utility (afudos.exe) from the motherboard support DVD to the bootable floppy disk you created earlier.
3. Boot the system in DOS mode, then at the prompt type:

afudos /i [filename]

where [filename] is the latest or the original BIOS file on the bootable floppy disk.

```
A:\>afudos /iM3A32-MVP.ROM
```

4. The utility verifies the file and starts updating the BIOS.

```
A:\>afudos /iM3A32-MVP.ROM
AMI Firmware Update Utility - Version 1.19 (ASUS V2.07 (03.11.24BB))
Copyright (C) 2002 American Megatrends, Inc. All rights reserved.

WARNING!! Do not turn off power during flash BIOS
Reading file ..... done
Reading flash ..... done

Advance Check .....
Erasing flash ..... done
Writing flash ..... 0x0008CC00 (9%)
```



Do not shut down or reset the system while updating the BIOS to prevent system boot failure!

5. The utility returns to the DOS prompt after the BIOS update process is completed. Reboot the system from the hard disk drive.

```
A:\>afudos /iM3A32-MVP.ROM
AMI Firmware Update Utility - Version 1.19 (ASUS V2.07 (03.11.24BB))
Copyright (C) 2002 American Megatrends, Inc. All rights reserved.

WARNING!! Do not turn off power during flash BIOS
Reading file ..... done
Reading flash ..... done

Advance Check .....
Erasing flash ..... done
Writing flash ..... done
Verifying flash .... done

Please restart your computer

A:\>
```

4.1.5 ASUS CrashFree BIOS 3 utility

The ASUS CrashFree BIOS 3 is an auto recovery tool that allows you to restore the BIOS file when it fails or gets corrupted during the updating process. You can update a corrupted BIOS file using the motherboard support DVD, the floppy disk, or the USB flash disk that contains the updated BIOS file.



- Prepare the motherboard support DVD, the floppy disk or the USB flash disk containing the updated motherboard BIOS before using this utility.
- If your display receives no signal during the BIOS updating process, the system will beep when it is searching for a device that contains the BIOS file. The beep stops when such device is found and the updating process begins. You will hear four beeps when the updating process is completed, and the display will return after the system reboots.

Recovering the BIOS from the support DVD

To recover the BIOS from the support DVD:

1. Turn on the system.
2. Insert the motherboard support DVD to the optical drive.
3. The utility displays the following message and automatically checks the DVD for the BIOS file.

```
Bad BIOS checksum. Starting BIOS recovery...
Checking for floppy...
```

When found, the utility reads the BIOS file and starts flashing the corrupted BIOS file.

```
Bad BIOS checksum. Starting BIOS recovery...
Checking for floppy...
Floppy found!
Reading file "M3A32-MVP.ROM". Completed.
Start flashing...
```

4. Restart the system after the utility completes the updating process.

Recovering the BIOS from the USB flash disk

To recover the BIOS from the USB flash disk:

1. Insert the USB flash disk that contains BIOS file to the USB port.
2. Turn on the system.
3. The utility will automatically checks the devices for the BIOS file. When found, the utility reads the BIOS file and starts flashing the corrupted BIOS file.
4. Restart the system after the utility completes the updating process.



- Only the USB flash disk with FAT 32/16 format and single partition can support ASUS CrashFree BIOS 3. The device size should be smaller than 8GB.
- DO NOT shut down or reset the system while updating the BIOS! Doing so can cause system boot failure!

4.2 BIOS setup program

This motherboard supports a programmable Serial Peripheral Interface (SPI) chip that you can update using the provided utility described in section “4.1 Managing and updating your BIOS.”

Use the BIOS Setup program when you are installing a motherboard, reconfiguring your system, or prompted to “Run Setup.” This section explains how to configure your system using this utility.

Even if you are not prompted to use the Setup program, you can change the configuration of your computer in the future. For example, you can enable the security password feature or change the power management settings. This requires you to reconfigure your system using the BIOS Setup program so that the computer can recognize these changes and record them in the CMOS RAM of the SPI chip.

The SPI chip on the motherboard stores the Setup utility. When you start up the computer, the system provides you with the opportunity to run this program. Press during the Power-On Self-Test (POST) to enter the Setup utility; otherwise, POST continues with its test routines.

If you wish to enter Setup after POST, restart the system by pressing <Ctrl+Alt+Delete>, or by pressing the reset button on the system chassis. You can also restart by turning the system off and then back on. Do this last option only if the first two failed.

The Setup program is designed to make it as easy to use as possible. Being a menu-driven program, it lets you scroll through the various sub-menus and make your selections from the available options using the navigation keys.



-
- The default BIOS settings for this motherboard apply for most conditions to ensure optimum performance. If the system becomes unstable after changing any BIOS settings, load the default settings to ensure system compatibility and stability. Select the **Load Setups Default** item under the Exit Menu. See section **4.8 Exit Menu**.
 - The BIOS setup screens shown in this section are for reference purposes only, and may not exactly match what you see on your screen.
 - Visit the ASUS website (www.asus.com) to download the latest BIOS file for this motherboard.
-

4.2.1 BIOS menu screen

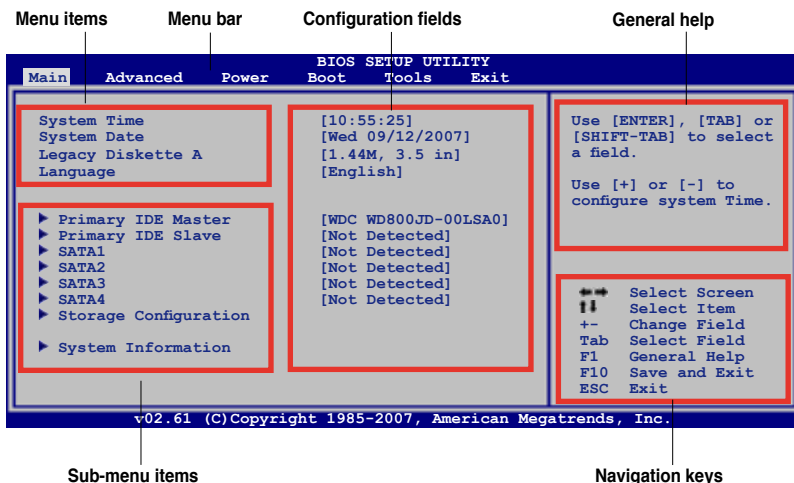

4.2.2 Menu bar

The menu bar on top of the screen has the following main items:

- Main** For changing the basic system configuration
- Advanced** For changing the advanced system settings
- Power** For changing the advanced power management (APM) configuration
- Boot** For changing the system boot configuration
- Tools** For Configuring options for special functions
- Exit** For selecting the exit options and loading default settings.

To select an item on the menu bar, press the right or left arrow key on the keyboard until the desired item is highlighted.

4.2.3 Navigation keys

At the bottom right corner of a menu screen are the navigation keys for that particular menu. Use the navigation keys to select items in the menu and change the settings.



Some of the navigation keys differ from one screen to another.

4.3 Main menu

When you enter the BIOS Setup program, the Main menu screen appears, giving you an overview of the basic system information.



Refer to section 4.2.1 **BIOS menu screen** for information on the menu screen items and how to navigate through them.

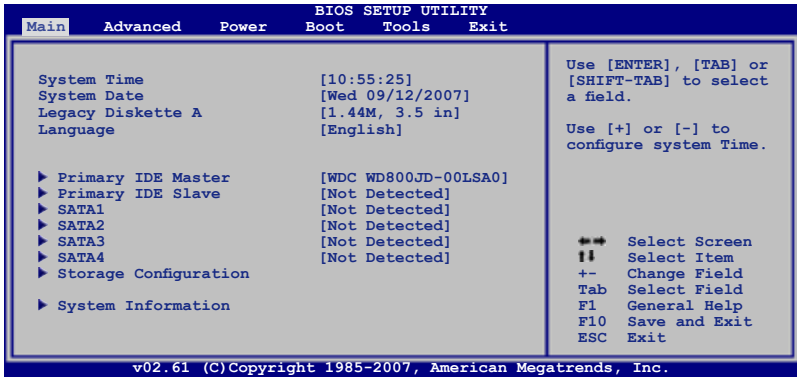

4.3.1 System Time [xx:xx:xx]

Allows you to set the system time.

4.3.2 System Date [Day xx/xx/xxxx]

Allows you to set the system date.

4.3.3 Legacy Diskette A [1.44M, 3.5 in.]

Sets the type of floppy drive installed.

Configuration options: [Disabled] [720K, 3.5 in.] [1.44M, 3.5 in.]

4.3.4 Language [English]

Allows you to select the display language for the BIOS setup screen.

Configuration options: [Chinese(BIG5)] [Chinese(GB)] [Japanese] [Français] [German] [English]

4.3.5 Primary IDE Master/Slave; SATA1~4

While entering Setup, the BIOS automatically detects the presence of IDE devices. There is a separate sub-menu for each IDE device. Select a device item then press <Enter> to display the IDE device information.

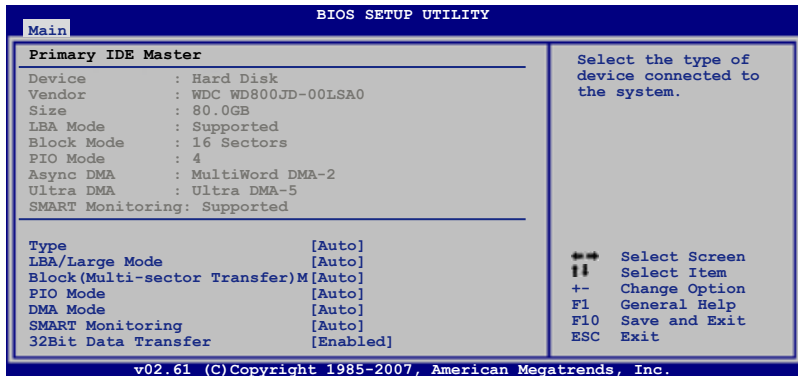

The BIOS automatically detects the values opposite the dimmed items (Device, Vendor, Size, LBA Mode, Block Mode, PIO Mode, Async DMA, Ultra DMA, and SMART monitoring). These values are not user-configurable. These items show N/A if no IDE device is installed in the system.

Type [Auto]

Selects the type of IDE drive. Setting to [Auto] allows automatic selection of the appropriate IDE device type. Select [CDROM] if you are specifically configuring a CD-ROM drive. Select [ARMD] (ATAPI Removable Media Device) if your device is either a ZIP, LS-120, or MO drive.

Configuration options: [Not Installed] [Auto] [CDROM] [ARMD]



This item appears in **Primary IDE Master/Slave** only.

LBA/Large Mode [Auto]

Enables or disables the LBA mode. Setting to [Auto] enables the LBA mode if the device supports this mode, and if the device was not previously formatted with LBA mode disabled. Configuration options: [Disabled] [Auto]

Block (Multi-sector Transfer) M [Auto]

Enables or disables data multi-sectors transfers. When set to [Auto], the data transfer from and to the device occurs multiple sectors at a time if the device supports multi-sector transfer feature. When set to [Disabled], the data transfer from and to the device occurs one sector at a time.

Configuration options: [Disabled] [Auto]

PIO Mode [Auto]

Selects the PIO mode.

Configuration options: [Auto] [0] [1] [2] [3] [4]

DMA Mode [Auto]

Selects the DMA mode. Configuration options: [Auto] [SWDMA0] [SWDMA1] [SWDMA2] [MWDMA0] [MWDMA1] [MWDMA2] [UDMA0] [UDMA1] [UDMA2] [UDMA3] [UDMA4] [UDMA5]

SMART Monitoring [Auto]

Sets the Smart Monitoring, Analysis, and Reporting Technology.

Configuration options: [Auto] [Disabled] [Enabled]

32Bit Data Transfer [Disabled]

Enables or disables 32-bit data transfer.

Configuration options: [Disabled] [Enabled]

4.3.6 Storage Configuration

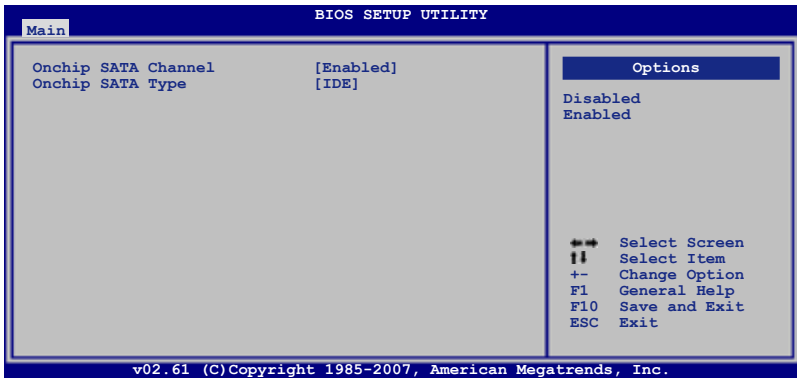

Onchip SATA Channel [Enabled]

Enables or disables the onchip SATA channel.

Configuration options: [Disabled] [Enabled]



The following item appears only when you enable **Onchip SATA Channel**.

Onchip SATA Type [IDE]

Sets the configuration for the Serial ATA connectors supported by the Southbridge chip.

The AHCI allows the onboard storage driver to enable advanced Serial ATA features that increases storage performance on random workloads by allowing the drive to internally optimize the order of commands.

If you want to create a RAID 0, RAID1, or RAID 0+1 configuration from the Serial ATA hard disk drives, set this item to [RAID].

If you want to use the Serial ATA hard disk drives as Parallel ATA physical storage devices, keep the default setting [IDE].

If you want the Serial ATA hard disk drives to use the Advanced Host Controller Interface (AHCI), set this item to [AHCI].

4.3.7 System Information

This menu gives you an overview of the general system specifications. The BIOS automatically detects the items in this menu.

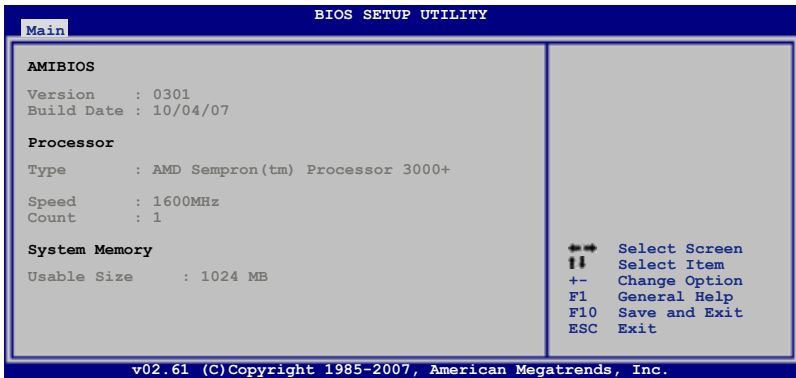

AMI BIOS

Displays the auto-detected BIOS information.

Processor

Displays the auto-detected CPU specification.

System Memory

Displays the auto-detected system memory.

4.4 Advanced menu

The Advanced menu items allow you to change the settings for the CPU and other system devices.



Take caution when changing the settings of the Advanced menu items. Incorrect field values can cause the system to malfunction.

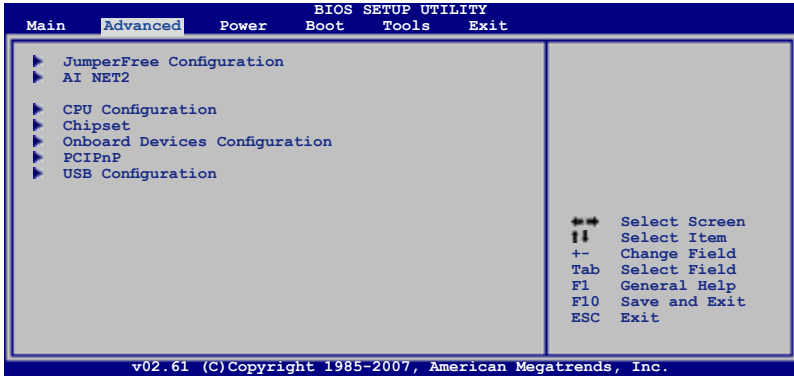

4.4.1 Jumperfree Configuration

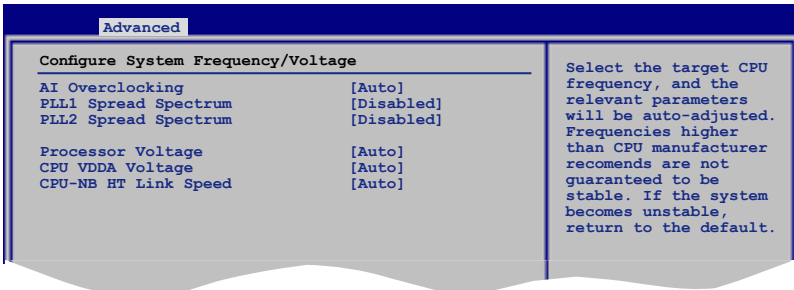

AI Overclocking [Auto]

Allows selection of CPU overclocking options to achieve desired CPU internal frequency. Select any one of the preset overclocking configuration options:

Manual Allows you to individually set overclocking parameters.

Auto Loads the optimal settings for the system.

Standard Loads the standard settings for the system.



Some of the following items appear when you set **AI Overclocking** to [Manual], or [Standard]. The items vary depending on which option you select.

FSB Frequency [XXX]

Displays the frequency sent by the clock generator to the system bus and PCI bus. Use the <+> and <-> keys to adjust the FSB frequency. You can also type the desired FSB frequency using the numeric keypad. The values range from 200 to 600. Refer to the table below for the correct Front Side Bus and CPU External Frequency settings.

PCIE Frequency [XXX]

Use the <+> and <-> keys to adjust the PCIE frequency. You can also type the desired PCIE frequency using the numeric keypad. The values range from 100 to 150.

PLL1 Spread Spectrum [Disabled]

Configuration options: [Disabled] [Enabled]

PLL2 Spread Spectrum [Disabled]

Configuration options: [Disabled] [Enabled]

Processor Frequency Multiplier [Auto]

This item is not configurable.

Processor Voltage [Auto]

You can enter the desired processor voltage using the numeric keypad. The values range from 0.8000V to 1.7125V with a 0.0125V interval.



Refer to the CPU documentation before setting the CPU Vcore voltage. Setting a high VCore voltage may damage the CPU permanently, and setting a low VCore voltage may make the system unstable.

CPU VDDA Voltage [Auto]

Allows you to select the CPU VDDA voltage.

Configuration options: [Auto] [2.50V] [2.6V] [2.7V] [2.8V]

CPU-NB HT Link Speed [Auto]

Allows you to set the CPU-Northbridge link speed.

Configuration options: [200 MHz] [400 MHz] [600 MHz] [800 MHz] [1 GHz] [Auto]



The configuration options may vary depending on your CPU model.

DDR Voltage [Auto]

You can enter the desired DDR2 voltage using the numeric keypad. The values range from 1.80V to 2.50V with a 0.02V interval.



Refer to the DDR2 documentation before adjusting the memory voltage. Setting a very high memory voltage may damage the memory module(s)!

Northbridge Voltage [Auto]

Allows you to set the Northbridge voltage. The following three items appear when you set **Northbridge Voltage** to [Manual]. Configuration options: [Auto] [Manual]

HyperTransport Voltage [Auto]

Configuration options: [Auto] [1.20V] [1.30V] [1.40V] [1.50V]

Core/PCIe Voltage [Auto]

You can enter the desired Core/PCIe voltage using the numeric keypad. The values range from 1.10V to 1.40V with a 0.02V interval.

NB PCIe PLL [Auto]

Configuration options: [Auto] [1.8V] [1.9V] [2.0V] [2.1V]

Southbridge Voltage [Auto]

You can enter the desired Southbridge voltage using the numeric keypad. The values range from 1.20V to 1.40V with a 0.02V interval.



- Setting **Processor Voltage**, **DDR Voltage**, **Core/PCIe Voltage** and **Southbridge Voltage** to a high level may damage the CPU, memory module, and chipset permanently. Proceed with caution.
- Some values of the items mentioned above are labeled in different color, indicating the risk levels of high voltage settings. Refer to the table below for details.
- The system may require better cooling system to work stably under high voltage settings.

	Blue	Yellow	Pink	Red
Processor Voltage	0.8000V~ 1.6000V	N/A	N/A	1.6125V~ 1.7250V
DDR Voltage	1.80V~1.98V	2.00V~2.18V	2.20V~2.38V	2.40V~2.50V
Core/PCIe Voltage	1.10V~1.28V	N/A	N/A	1.30V~1.40V
Southbridge Voltage	1.20V~1.28V	N/A	N/A	1.30V~1.40V

AMD Auto Xpress [Auto]

AMD recommends that you enable this item to improve platform performance.
Configuration options: [Auto] [Disabled] [Enabled]

Memory Configuration

Advanced	
Memory Configuration	
Bank Interleaving	[Auto]
Channel Interleaving	[Auto]
MemClk Tristate C3/ATLVID	[Disabled]
Memory Hole Remapping	[Enabled]
Unganged Mode support	[Enabled]
Power Down Enable	[Enabled]
Power Down Mode	[Channel]
Read Delay	[Auto]
DCQ Bypass Maximum	[Auto]
Enable Bank Memory Interleaving.	

Bank Interleaving [Auto]

Configuration options: [Disabled] [Auto]

Channel Interleaving [Auto]

Configuration options: [Disabled] [Auto] [Address buts 6] [Address bits 12]
[Hash*, XOR of Address bits [20:16, 6]]
[Hash*, XOR of Address bits [20:16, 9]]

MemClk Tristate C3/ATLVID [Disabled]

Configuration options: [Disabled] [Enabled]

Memory Hole Remapping [Enabled]

Configuration options: [Disabled] [Enabled]

Unganged Mode Support [Enabled]

Configuration options: [Disabled] [Enabled]

Power Down Enable [Enabled]

Enables or disables the DDR power down mode.

Configuration options: [Disabled] [Enabled]

Power Down Mode [Channel]

Allows you to set the DDR power down mode. This item appears only when you enable the previous item. Configuration options: [Channel] [Chip Select]

Read Delay [Auto]

Configuration options: [Auto] [0.5 Memory CLKs] [1.0 Memory CLKs] [1.5 Memory CLKs] [2.0 Memory CLKs] [2.5 Memory CLKs] [3.0 Memory CLKs] [3.5 Memory CLKs] [4.0 Memory CLKs]

DCQ Bypass Maximum [Auto]

Configuration options: [Auto] [0x] [1x] [2x]~[14x] [15x]

DRAM Timing Configuration

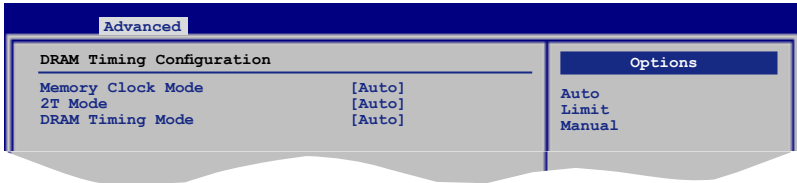

Memory Clock Mode [Auto]

Configuration options: [Auto] [Limit] [Manual]

Memclock Value [200 MHz]

This item appears when you set the previous item to [Limit] or [Manual].

Configuration options: [200 MHz] [266 MHz] [333 MHz] [400 MHz]

2T Mode [Auto]

Configuration options: [Auto] [Disabled] [Enabled]

DRAM Timing Mode [Auto]

Configuration options: [Auto] [DCT 0]

AI Clock Skew for Channel A [Auto]

Configuration options: [Auto] [Advance 900ps] [Advance 750ps] [Advance 600ps] [Advance 450ps] [Advance 300ps] [Advance 150ps] [Normal] [Delay 150ps] [Delay 300ps] [Delay 450ps] [Delay 600ps] [Delay 750ps] [Delay 900ps]

Current Clock Skew [Advance450ps]

This item shows the current clock skew for channel A.

AI Clock Skew for Channel B [Auto]

Configuration options: [Auto] [Advance 900ps] [Advance 750ps] [Advance 600ps] [Advance 450ps] [Advance 300ps] [Advance 150ps] [Normal] [Delay 150ps] [Delay 300ps] [Delay 450ps] [Delay 600ps] [Delay 750ps] [Delay 900ps]

Current Clock Skew [Advance450ps]

This item shows the current clock skew for channel B.

4.4.2 AI Net 2

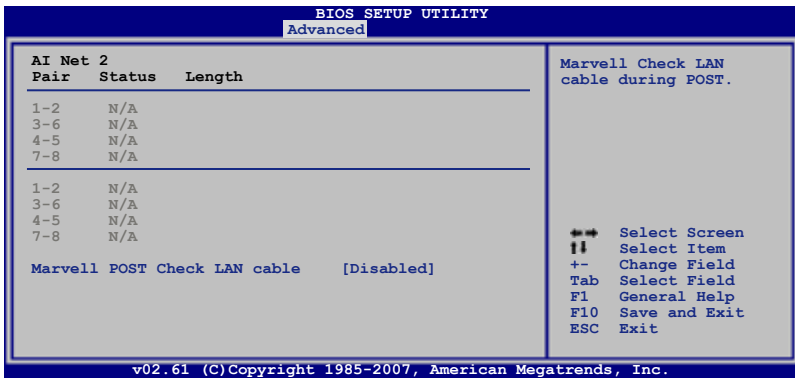

Marvell POST Check LAN Cable [Disabled]

Enables or disables checking of the LAN cable during the Power-On Self-Test (POST). Configuration options: [Disabled] [Enabled]

4.4.3 CPU Configuration

The items in this menu show the CPU-related information that the BIOS automatically detects.

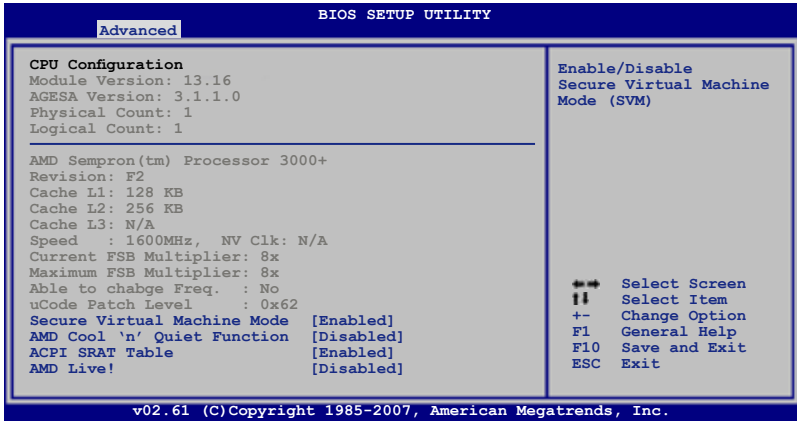

Secure Virtual Machine Mode [Enabled]

Enables or disables the Secure Virtual Machine mode.
Configuration options: [Disabled] [Enabled]

AMD Cool 'n' Quiet Function [Disabled]

Enables or disables the AMD Cool 'n' Quiet technology.
Configuration options: [Disabled] [Enabled]

ACPI SRAT Table [Enabled]

Enables or disables the building of ACPI SRAT table.
Configuration options: [Disabled] [Enabled]

AMD Live! [Disabled]

Enables or disables the AMD® Live! Technology.
Configuration options: [Disabled] [Enabled]

4.4.4 Chipset

The Chipset menu allows you to change the advanced chipset settings. Select an item then press <Enter> to display the sub-menu.



PCI Express Configuration

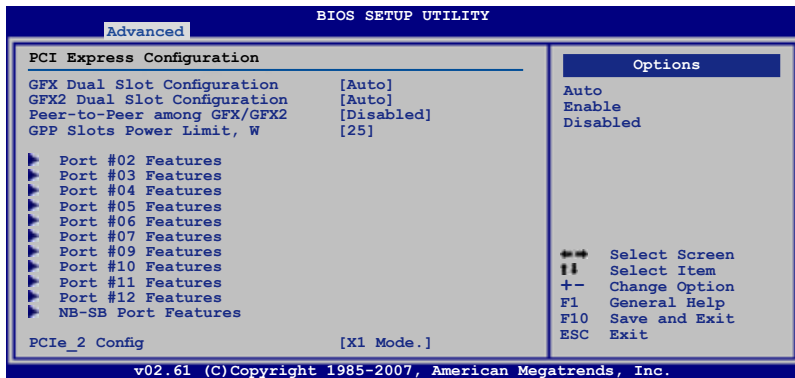

GFX Dual Slot Configuration [Auto]

Configuration options: [Auto] [Enable] [Disabled]

GFX2 Dual Slot Configuration [Auto]

Configuration options: [Auto] [Enable] [Disabled]

Peer-to-Peer among GFX/GFX2 [Disabled]

Configuration options: [Enable] [Disabled]

GPP Slots Power Limit, W [25]

Use the <+> and <-> keys to change the value or type the desired value using the numeric keypad. The values range from 0 to 255.

Port #02/03/11/12 Features

Gen2 High Speed Mode [Disabled]

Configuration options: [Disabled] [Software Switch] [Autonomous Switch]

Link ASPM [Disabled]

Configuration options: [Disabled] [L0s] [L1] [L0s & L1]

Link Width [Auto]

Configuration options: [Auto] [x1 Mode] [x2] [x4] [x8 Mode]

Slot Power Limit, W [75]

Use the <+> and <-> keys to change the value or type the desired value using the numeric keypad. The values range from 0 to 255.

Port #04/05/06/07/09/10 Features

Gen2 High Speed Mode [Disabled]

Configuration options: [Disabled] [Software Switch] [Autonomous Switch]

Link ASPM [Disabled]

Configuration options: [Disabled] [L0s] [L1] [L0s & L1]

NB-SB Port Features

NB-SB link ASPM [Disabled]

Configuration options: [Disabled] [L1]

NP NB-SB VC1 Traffic Support [Disabled]

Configuration options: [Enabled] [Disabled]

PCIe 2/PCIe 4 Config [X1 Mode.]

Configuration options: [X1 Mode.] [X8 Mode.]



- This item appears only when you install PCIe x4 cards to the PCIEX16_2/4 slots.
- When you set this item to [X8 Mode], the PCIEX16_2/4 slots share width with the PCIEX16_1/3 slots.

Hyper Transport Configuration

The screenshot shows the BIOS Setup Utility interface. At the top, it says "BIOS SETUP UTILITY" and "Advanced". The main window is titled "Hyper Transport Configuration" and contains the following settings:

Option	Value
Isochronous Flow-Control Mode	[Disabled]
HT Link Tristate	[Disabled]
UnitID Clumping	[Disabled]
2x LCLK Mode	[Disabled]

To the right of the settings is an "Options" menu with the following items:

- Disabled
- Enable

At the bottom right of the screen, there is a legend for navigation keys:

- Select Screen
- ↑↓ Select Item
- +/- Change Option
- F1 General Help
- F10 Save and Exit
- ESC Exit

At the very bottom of the screen, it says "v02.61 (C) Copyright 1985-2007, American Megatrends, Inc."

Isochronous Flow-Control Mode [Disabled]

Configuration options: [Disabled] [Enable]

HT Link Tristate [Disabled]

Configuration options: [Disabled] [CAD/CTL] [CAD/CTL/CLK]

UnitID Clumping [Disabled]

Configuration options: [Disabled] [UnitID 2/3] [UnitID B/C] [UnitID 2/3&B/C]

2x LCLK Mode [Disabled]

Configuration options: [Disabled] [Enable]

4.4.5 Onboard Devices Configuration

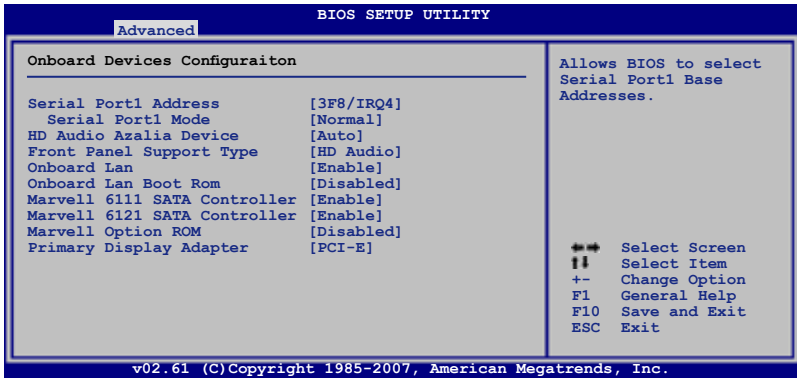

Serial Port1 Address [3F8/IRQ4]

Allows you to select the Serial Port1 base address.

Configuration options: [Disabled] [3F8/IRQ4] [2F8/IRQ3] [3E8/IRQ4] [2E8/IRQ3]

Serial Port1 Mode [Normal]

This item does not show if you disable the **Serial Port1 Address** item.

Configuration options: [Normal] [IrDA] [ASK IR]

HD Audio Azalia Device [Auto]

Allows you to enable or disable the High Definition Audio. The following item appears only when you set this item to [Auto].

Configuration options: [Auto] [Disabled]

Front Panel Support Type [HD Audio]

Allows you to set the front panel audio connector (AAFP) mode to legacy AC'97 or high-definition audio depending on the audio standard that the front panel audio module supports. Configuration options: [AC97] [HD Audio]

Onboard Lan [Enable]

Configuration options: [Enable] [Disabled]

Onboard Lan Boot Rom [Disabled]

This item appears only when you enable the previous item.

Configuration options: [Enable] [Disabled]

Marvell 6111 SATA Controller [Enable]

Configuration options: [Enable] [Disabled]

Marvell 6121 SATA Controller [Enable]

Configuration options: [Enable] [Disabled]

Marvell 6121 Option Rom [Disabled]

This item appears when you enable **Marvell 6121 SATA Controller**.

Configuration options: [Enable] [Disabled]

Marvell IDE/RAID function [IDE]

This item appears when you enable **Marvell 6121 Option Rom**.

If you want to create a RAID 0, RAID 1, or RAID 0+1 configuration from the Serial ATA hard disk drives, set this item to [RAID].

If you want to use the Serial ATA hard disk drives as Parallel ATA physical storage devices, keep the default setting [IDE].

Primary Display Adapter [PCI-E]

Allows you to select which graphics controller to use as the primary boot device.

Configuration options: [PCI-E] [PCI]

4.4.6 PCI PnP

The PCI PnP menu items allow you to change the advanced settings for PCI/PnP devices.



Take caution when changing the settings of the PCI PnP menu items. Incorrect field values can cause the system to malfunction.

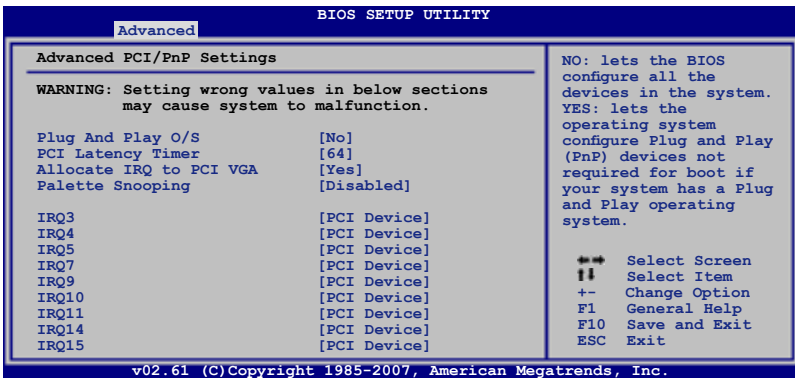

Plug And Play O/S [No]

When set to [No], BIOS configures all the devices in the system. When set to [Yes] and if you install a Plug and Play operating system, the operating system configures the Plug and Play devices not required for boot.

Configuration options: [No] [Yes]

PCI Latency Timer [64]

Configuration options: [32] [64] [96] [128] [160] [192] [224] [248]

Allocate IRQ to PCI VGA [Yes]

Configuration options: [Yes] [No]

Palette Snooping [Disabled]

Configuration options: [Disabled] [Enabled]

IRQ3/4/5/7/9/10/11/14/15 [PCI Device]

Configuration options: [PCI Device] [Reserved]

4.4.7 USB Configuration

The items in this menu allows you to change the USB-related features. Select an item then press <Enter> to display the configuration options.

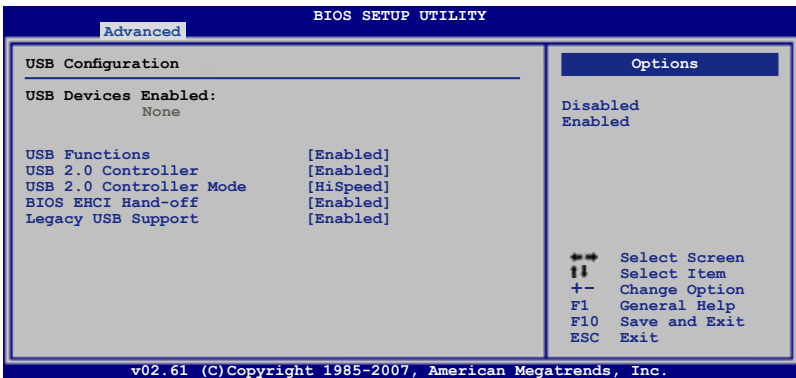

The **USB Devices Enabled** item shows the auto-detected values. If no USB device is detected, the item shows None.

USB Functions [Enabled]

Allows you to enable or disable the USB functions.

Configuration options: [Disabled] [Enabled]



The following item appears only when you set **USB Functions** to [Enabled].

USB 2.0 Controller [Enabled]

Allows you to enable or disable the USB 2.0 controller.

Configuration options: [Enabled] [Disabled]

USB 2.0 Controller Mode [HiSpeed]

Allows you to set the USB 2.0 controller mode to HiSpeed (480 Mbps) or FullSpeed (12 Mbps). Configuration options: [FullSpeed] [HiSpeed]

BIOS EHCI Hand-off [Enabled]

Allows you to enable the support for operating systems without an EHCI hand-off feature. Configuration options: [Disabled] [Enabled]

Legacy USB Support [Enabled]

Allows you to enable or disable the support for legacy USB devices. Setting to [Auto] allows the system to detect the presence of USB devices at startup. If detected, the USB controller legacy mode is enabled. If no USB device is detected, the legacy USB support is disabled.

Configuration options: [Disabled] [Enabled] [Auto]

4.5 Power menu

The Power menu items allow you to change the settings for the Advanced Power Management (APM). Select an item then press <Enter> to display the configuration options.

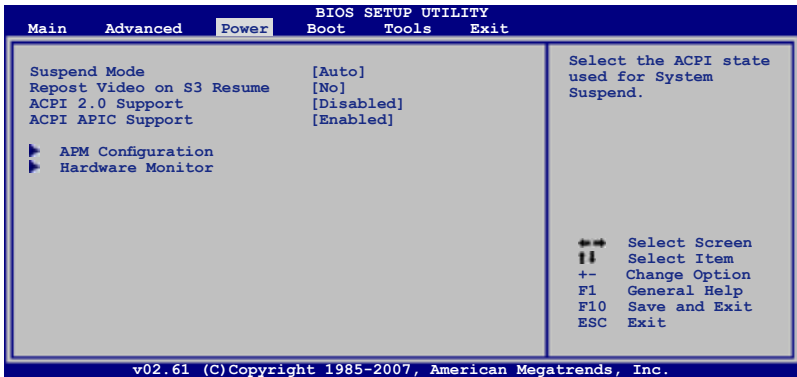

4.5.1 Suspend Mode [Auto]

Allows you to select the Advanced Configuration and Power Interface (ACPI) state to be used for system suspend.

Configuration options: [S1 (POS) Only] [S3 Only] [Auto]

4.5.2 Repost Video on S3 Resume [No]

Determines whether to invoke VGA BIOS POST on S3/STR resume.

Configuration options: [No] [Yes]

4.5.3 ACPI 2.0 Support [Disabled]

Allows you to enable or disable the Advanced Configuration and Power Interface (ACPI) 2.0 support. Configuration options: [Disabled] [Enabled]

4.5.4 ACPI APIC Support [Enabled]

Allows you to enable or disable the Advanced Configuration and Power Interface (ACPI) support in the Advanced Programmable Interrupt Controller (APIC). When set to Enabled, the ACPI APIC table pointer is included in the RSDT pointer list.

Configuration options: [Disabled] [Enabled]

4.5.5 APM Configuration

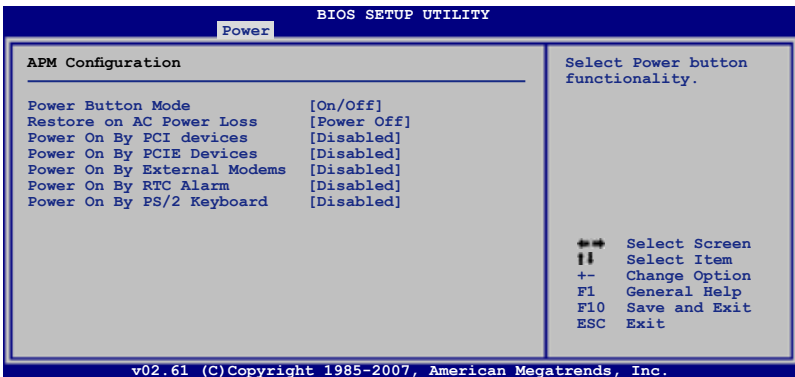

Power Button Mode [On/Off]

Allows you to set the power button function.

Configuration options: [On/Off] [Suspend]

Restore On AC Power Loss [Power Off]

When set to Power Off, the system goes into off state after an AC power loss.

When set to Power On, the system goes on after an AC power loss. When set to Last State, the system goes into either off or on state, whatever the system state was before the AC power loss.

Configuration options: [Power Off] [Power On] [Last State]

Power On By PCI Devices [Disabled]

Allows you to enable or disable the PME to wake up from S5 by PCI devices.
Configuration options: [Disabled] [Enabled]

Power On By PCIE Devices [Disabled]

Allows you to enable or disable the PCIE devices to generate a wake event.
Configuration options: [Disabled] [Enabled]

Power On By External Modems [Disabled]

When set to [Enabled], this item allows you to power on the computer in Soft-off mode with an external modem. Configuration options: [Disabled] [Enabled]



When a computer is off, turning an external modem off and then on causes an initialization string that turns on the computer.

Power On By RTC Alarm [Disabled]

Allows you to enable or disable RTC to generate a wake event. When this item is set to Enabled, the items RTC Alarm Date/ RTC Alarm Hour/ RTC Alarm Minute/ RTC Alarm Second will become user-configurable with set values.
Configuration options: [Disabled] [Enabled]

Power On By PS/2 Keyboard [Disabled]

Allows you to disable the Power On by PS/2 keyboard function or set specific keys on the PS/2 keyboard to turn on the system. This feature requires an ATX power supply that provides at least 1A on the +5VSB lead.
Configuration options: [Disabled] [Space Bar] [Power Key] [Ctrl-Esc]

4.5.6 Hardware Monitor

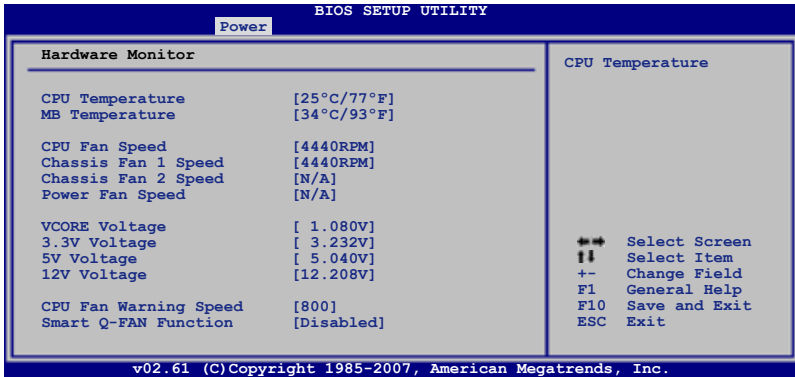

CPU Temperature [xxx°C/xxx°F]

MB Temperature [xxx°C/xxx°F]

The onboard hardware monitor automatically detects and displays the motherboard and CPU temperatures. Select [Ignored] if you do not wish to display the detected temperatures.

CPU Fan/ Chassis Fan 1 and 2/Power Fan Speed [xxxxRPM] or [Ignored] / [N/A]

The onboard hardware monitor automatically detects and displays the fan speed in rotations per minute (RPM). If the fan is not connected to the motherboard, the field shows N/A.

Vcore Voltage, 3.3V Voltage, 5V Voltage, 12V Voltage

The onboard hardware monitor automatically detects the voltage output through the onboard voltage regulators. Select [Ignored] if you do not want to detect this item.

CPU Fan Warning Speed [800]

Allows you to set the CPU fan warning speed.

Configuration options: [Disabled] [800] [1200] [1600]

Smart Q-FAN Function [Disabled]

Enables or disables the Smart Q-Fan function.

Configuration options: [Disabled] [Enabled]



The **Q-Fan Profile** item appears when you enable **Smart Q-Fan Function**.

Q-Fan Profile [Optimal]

Allows you to set the appropriate performance level of the CPU Q-Fan. When set to [Optimal], the CPU fan automatically adjusts depending on the CPU temperature. Set this item to [Silent Mode] to minimize fan speed for quiet CPU fan operation, or [Performance Mode] to achieve maximum CPU fan speed. Configuration options: [Optimal] [Silent Mode] [Performance Mode]

4.6 Boot menu

The Boot menu items allow you to change the system boot options. Select an item then press <Enter> to display the sub-menu.

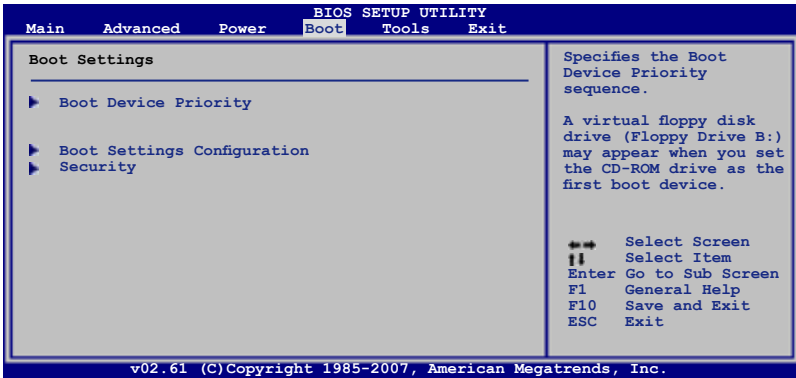

4.6.1 Boot Device Priority

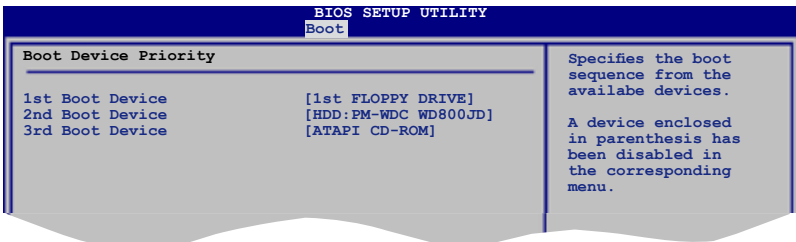

1st ~ xxth Boot Device [xxx Drive]

These items specify the boot device priority sequence from the available devices. The number of device items that appears on the screen depends on the number of devices installed in the system.

Configuration options: [xxx Drive] [Disabled]

4.6.2 Boot Settings Configuration

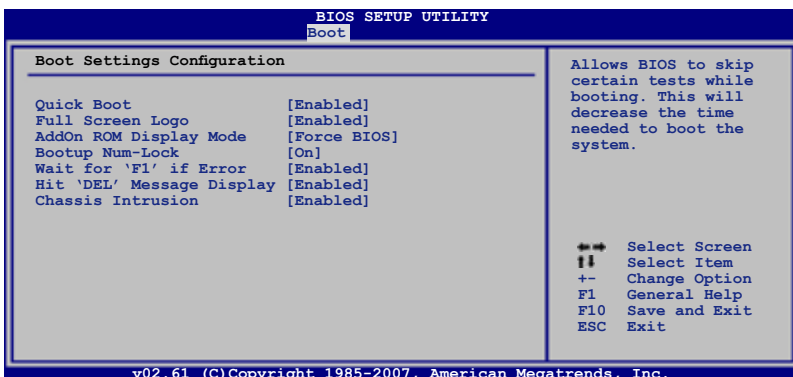

Quick Boot [Enabled]

Enabling this item allows the BIOS to skip some power on self tests (POST) while booting to decrease the time needed to boot the system. When set to [Disabled], BIOS performs all the POST items.

Configuration options: [Disabled] [Enabled]

Full Screen Logo [Enabled]

This allows you to enable or disable the full screen logo display feature.

Configuration options: [Disabled] [Enabled]



Set this item to [Enabled] to use the ASUS MyLogo 2™ feature.

AddOn ROM Display Mode [Force BIOS]

Sets the display mode for option ROM.

Configuration options: [Force BIOS] [Keep Current]

Bootup Num-Lock [On]

Allows you to select the power-on state for the NumLock.

Configuration options: [Off] [On]

Wait for 'F1' If Error [Enabled]

When set to Enabled, the system waits for the F1 key to be pressed when error occurs. Configuration options: [Disabled] [Enabled]

Hit 'DEL' Message Display [Enabled]

When set to Enabled, the system displays the message "Press DEL to run Setup" during POST. Configuration options: [Disabled] [Enabled]

Chassis Intrusion [Enabled]

Configuration options: [Disabled] [Enabled]

4.6.3 Security

The Security menu items allow you to change the system security settings. Select an item then press <Enter> to display the configuration options.

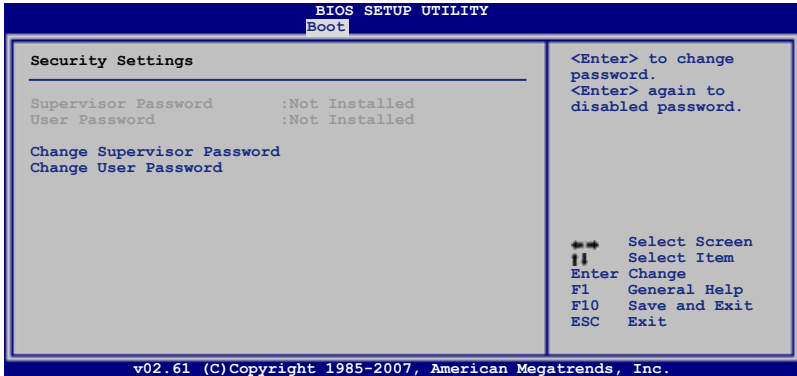

Change Supervisor Password

Select this item to set or change the supervisor password. The Supervisor Password item on top of the screen shows the default Not Installed. After you set a password, this item shows Installed.

To set a Supervisor Password:

1. Select the Change Supervisor Password item and press <Enter>.
2. From the password box, type a password composed of at least six letters and/or numbers, then press <Enter>.
3. Confirm the password when prompted.

The message "Password Installed" appears after you successfully set your password.

To change the supervisor password, follow the same steps as in setting a user password.

To clear the supervisor password, select the Change Supervisor Password then press <Enter>. The message "Password Uninstalled" appears.



If you forget your BIOS password, you can clear it by erasing the CMOS Real Time Clock (RTC) RAM. See section 2.6 Jumper for information on how to erase the RTC RAM.

After you have set a supervisor password, the other items appear to allow you to change other security settings.

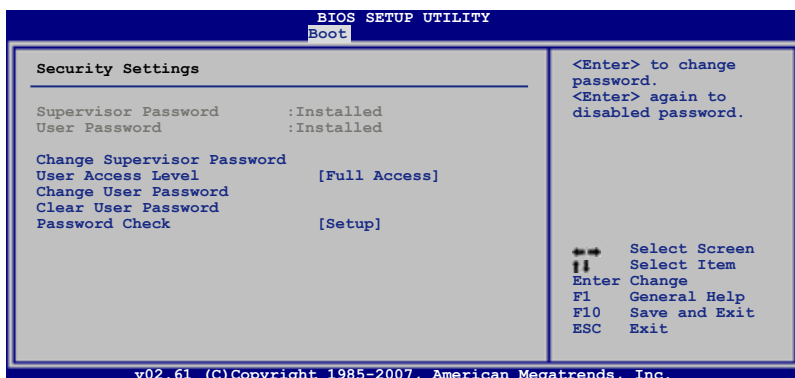

User Access Level [Full Access]

This item allows you to select the access restriction to the Setup items.

Configuration options: [No Access] [View Only] [Limited] [Full Access]

No Access prevents user access to the Setup utility.

View Only allows access but does not allow change to any field.

Limited allows changes only to selected fields, such as Date and Time.

Full Access allows viewing and changing all the fields in the Setup utility.

Change User Password

Select this item to set or change the user password. The User Password item on top of the screen shows the default Not Installed. After you set a password, this item shows Installed.

To set a User Password:

1. Select the Change User Password item and press <Enter>.
2. On the password box that appears, type a password composed of at least six letters and/or numbers, then press <Enter>.
3. Confirm the password when prompted.

The message "Password Installed" appears after you set your password successfully.

To change the user password, follow the same steps as in setting a user password.

Clear User Password

Select this item to clear the user password.

Password Check [Setup]

When set to [Setup], BIOS checks for user password when accessing the Setup utility. When set to [Always], BIOS checks for user password both when accessing Setup and booting the system.

Configuration options: [Setup] [Always]

4.7 Tools menu

The Tools menu items allow you to configure options for special functions. Select an item then press <Enter> to display the sub-menu.

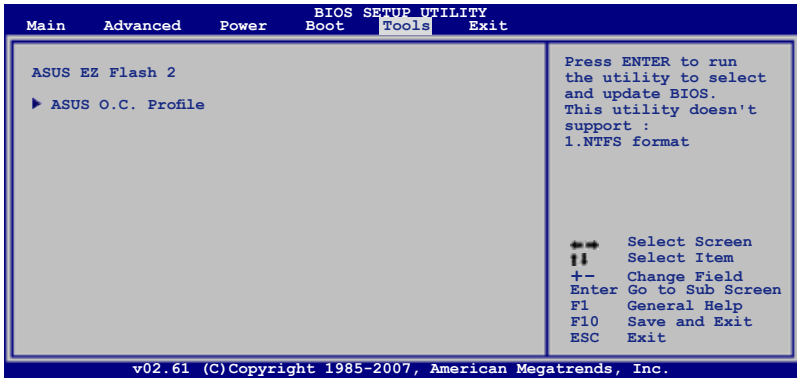

4.7.1 ASUS EZ Flash 2

Allows you to run ASUS EZ Flash 2. When you press <Enter>, a confirmation message appears. Use the left/right arrow key to select between [Yes] or [No], then press <Enter> to confirm your choice. Please see section 4.1.3 for details.

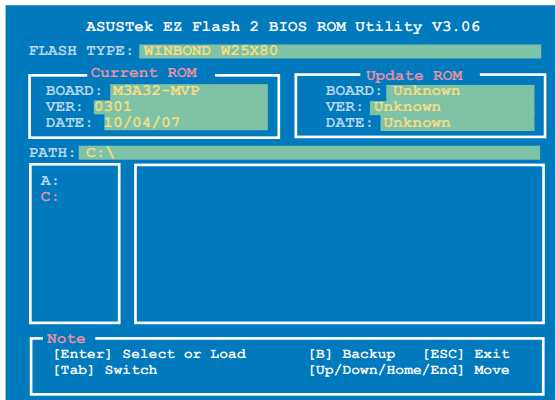

4.7.2 ASUS O.C. Profile

This item allows you to store or load multiple BIOS settings.

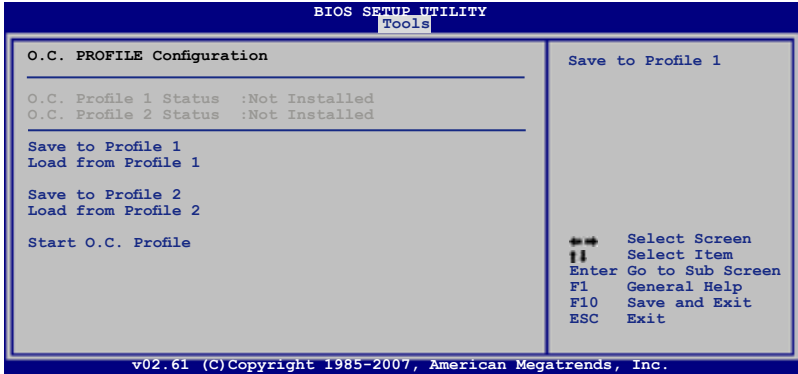

Save to Profile 1/2

Allows you to save the current BIOS file to the BIOS Flash. Press <Enter> to save the file.

Load from Profile 1/2

Allows you to load the previous BIOS settings saved in the BIOS Flash. Press <Enter> to load the file.

Start O.C. Profile

Allows you to run the utility to save and load CMOS. Press <Enter> to run the utility.

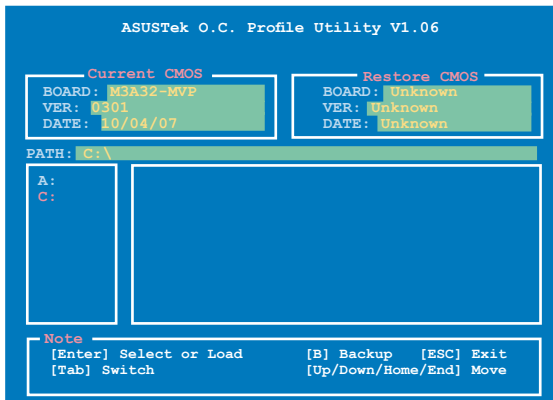

- This function can support devices such as USB flash disk or floppy disk with FAT 32/16 format and single partition only.
- DO NOT shut down or reset the system while updating the BIOS to prevent the system boot failure!

4.8 Exit menu

The Exit menu items allow you to load the optimal or failsafe default values for the BIOS items, and save or discard your changes to the BIOS items.

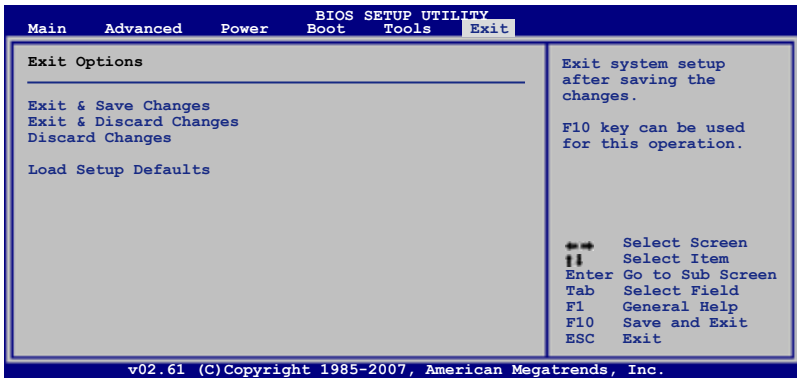

Pressing <Esc> does not immediately exit this menu. Select one of the options from this menu or <F10> from the legend bar to exit.

Exit & Save Changes

Once you are finished making your selections, choose this option from the Exit menu to ensure the values you selected are saved to the CMOS RAM. An onboard backup battery sustains the CMOS RAM so it stays on even when the PC is turned off. When you select this option, a confirmation window appears. Select YES to save changes and exit.



If you attempt to exit the Setup program without saving your changes, the program prompts you with a message asking if you want to save your changes before exiting. Press <Enter> to save the changes while exiting.

Exit & Discard Changes

Select this option only if you do not want to save the changes that you made to the Setup program. If you made changes to fields other than System Date, System Time, and Password, the BIOS asks for a confirmation before exiting.

Discard Changes

This option allows you to discard the selections you made and restore the previously saved values. After selecting this option, a confirmation appears. Select YES to discard any changes and load the previously saved values.

Load Setup Defaults

This option allows you to load the default values for each of the parameters on the Setup menus. When you select this option or if you press <F5>, a confirmation window appears. Select YES to load default values. Select Exit & Save Changes or make other changes before saving the values to the non-volatile RAM.

This chapter describes the contents of the support DVD that comes with the motherboard package.

5 Software support

- 5.1 Installing an operating system 5-1**
- 5.2 Support DVD information 5-1**
- 5.3 Software informtion 5-9**
- 5.4 RAID configurations 5-36**
- 5.5 Creating a RAID driver disk..... 5-49**

5.1 Installing an operating system

This motherboard supports Windows® XP/64-bit XP/Vista/64-bit Vista operating systems (OS). Always install the latest OS version and corresponding updates to maximize the features of your hardware.



- Motherboard settings and hardware options vary. Use the setup procedures presented in this chapter for reference only. Refer to your OS documentation for detailed information.
- Make sure that you install Windows® 2000 Service Pack 4 or the Windows® XP Service Pack 2 or later versions before installing the drivers for better compatibility and system stability.

5.2 Support DVD information

The support DVD that came with the motherboard package contains the drivers, software applications, and utilities that you can install to avail all motherboard features.



The contents of the support DVD are subject to change at any time without notice. Visit the ASUS website(www.asus.com) for updates.

5.2.1 Running the support DVD

Place the support DVD to the optical drive. The DVD automatically displays the Drivers menu if Autorun is enabled in your computer.



Click an icon to display support DVD/motherboard information

Click an item to install



If Autorun is NOT enabled in your computer, browse the contents of the support DVD to locate the file ASSETUP.EXE from the BIN folder. Double-click the ASSETUP.EXE to run the DVD.

5.2.2 Drivers menu

The drivers menu shows the available device drivers if the system detects installed devices. Install the necessary drivers to activate the devices.



ASUS InstAll - Drivers Installation Wizard

Installs all of the drivers through the installation wizard.

AMD Cool 'n' Quiet Driver

Installs the AMD Cool 'n' Quiet™ technology driver.

AMD Chipset Program Driver

Installs the AMD® chipset drivers for the AMD 790FX chipset.

SoundMAX ADI Audio Driver

Installs the SoundMAX® ADI audio driver and application.

Marvell 61xx SATA RAID Controller Driver

Installs the Marvell® Serial ATA RAID controller driver.

ASUS WiFi-AP Solo (*WiFi-AP Edition only*)

Installs the ASUS WiFi-AP Solo driver.

USB 2.0 Driver

Installs the Universal Serial Bus 2.0 (USB 2.0) driver.

5.2.3 Utilities menu

The Utilities menu shows the applications and other software that the motherboard supports.



Click to display the next screen



Click to display the previous screen

ASUS InstAll - Installation Wizard for Utilities

Installs all of the utilities through the installation wizard.

AMD OverDrive Utility (AOD)

Installs the AMD® OverDrive™ utility.

ASUS Cool 'n' Quiet Utility

Installs the ASUS Cool 'n' Quiet™ software.

ASUS Update

The ASUS Update utility allows you to update the motherboard BIOS in Windows® environment. This utility requires an Internet connection either through a network or an Internet Service Provider (ISP).



Before using the ASUS Update, make sure that you have an Internet connection so that you can connect to the ASUS website.

ASUS PC Probe II

This smart utility monitors the fan speed, CPU temperature, and system voltages, and alerts you of any detected problems. This utility helps you keep your computer in healthy operating condition.

ASUS AI Suite

Installs the ASUS AI Suite.

Marvell Yukon VCT Application

Installs the Marvell® Yukon VCT applications.

Adobe Reader V7.0

Installs the Adobe® Acrobat® Reader that allows you to open, view, and print documents in Portable Document Format (PDF).

Microsoft DirectX 9.0c

Installs the Microsoft® DirectX 9.0c driver. The Microsoft DirectX® 9.0c is a multimedia technology that enhances computer graphics and sound. DirectX® improves the multimedia features of your computer so you can enjoy watching TV and movies, capturing videos, or playing games in your computer. Visit the Microsoft website (www.microsoft.com) for updates.

Anti-Virus Utility

The anti-virus application scans, identifies, and removes computer viruses. View the online help for detailed information.

Anti-Virus Utility Download

Installs to update your anti-virus utility version.

InterVideo MediaOne Gallery

Installs the InterVideo MediaOne Gallery software.

DVD Copy5 Trial

Installs the WinDVD Copy5 Trial version.

Ulead PhotoImpact 12 SE

Installs the Ulead PhotoImpact 12 SE software.

CyberLink PowerBackup

Installs the CyberLink PowerBackup software.

Corel Snapfire Plus SE

Installs the Corel Snapfire Plus SE software.

5.2.4 Make Disk menu

The Make Disk menu contains items to create the NVIDIA® nForce™ 590-SLI or Silicon Image SATA/RAID driver disk.



Make ATI RAID/AHCI x86_x64_WinXP Driver

Allows you to create an ATI RAID/AHCI driver disk for Windows®XP.

Make ATI RAID/AHCI Vista Driver

Allows you to create an ATI RAID/AHCI driver disk for Windows® Vista™.

Marvell 61xx 32/64bit SATA RAID Driver

Allows you to create a Marvell 6121 SATA RAID driver disk for a 32/64-bit system.

5.2.5 Manual menu

The Manual menu contains a list of supplementary user manuals. Click an item to open the folder of the user manual.



Most user manual files are in Portable Document Format (PDF). Install the Adobe® Acrobat® Reader from the Utilities menu before opening a user manual file.



5.2.6 ASUS Contact information

Click the Contact tab to display the ASUS contact information. You can also find this information on the inside front cover of this user guide.



5.2.7 Other information

The icons on the top right corner of the screen give additional information on the motherboard and the contents of the support DVD. Click an icon to display the specified information.

Motherboard Info

Displays the general specifications of the motherboard.



Browse this DVD

Displays the support DVD contents in graphical format.



Technical support Form

Displays the ASUS Technical Support Request Form that you have to fill out when requesting technical support.



Filelist

Displays the contents of the support DVD and a brief description of each in text format.

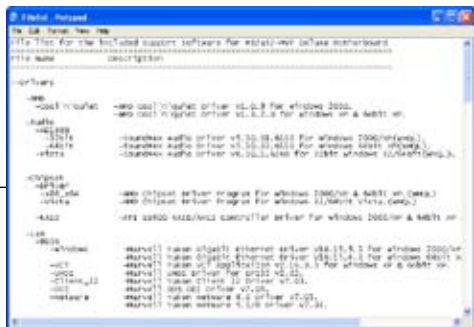

5.3 Software information

Most of the applications in the support DVD have wizards that will conveniently guide you through the installation. View the online help or readme file that came with the software application for more information.

5.3.1 ASUS MyLogo2™

The ASUS MyLogo2™ utility lets you customize the boot logo. The boot logo is the image that appears on screen during the Power-On Self-Tests (POST). The ASUS MyLogo2™ is automatically installed when you install the ASUS Update utility from the support DVD. See section “5.2.3 Utilities menu” for details.



- Before using the ASUS MyLogo2™, use the AFUDOS utility to make a copy of your original BIOS file, or obtain the latest BIOS version from the ASUS website. See section 4.1.4 **AFUDOS utility**.
- Make sure that the BIOS item Full Screen Logo is set to [Enabled] if you wish to use ASUS MyLogo2. See section 4.6.2 **Boot Settings Configuration**.
- You can create your own boot logo image in GIF, or BMP file formats.
- The file size should be smaller than 150 K.

To launch the ASUS MyLogo2™:

1. Launch the ASUS Update utility. Refer to section “4.1.1 ASUS Update utility” for details.
2. Select **Options** from the drop down menu, then click **Next**.
3. Check the option **Launch MyLogo** to replace system boot logo before flashing BIOS, then click **Next**.
4. Select **Update BIOS** from a file from the drop down menu, then click **Next**.
5. When prompted, locate the new BIOS file, then click **Next**. The ASUS MyLogo window appears.
6. From the left window pane, select the folder that contains the image you intend to use as your boot logo.

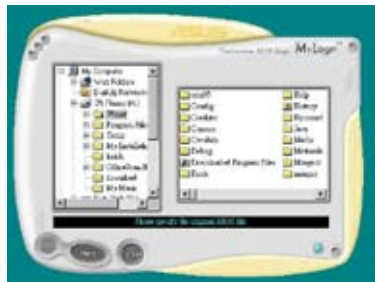

7. When the logo images appear on the right window pane, select an image to enlarge by clicking on it.

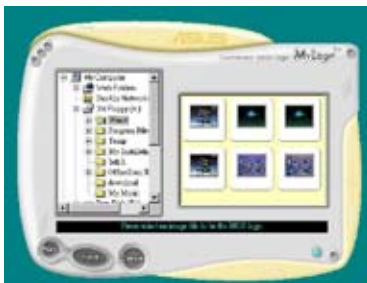

8. Adjust the boot image to your desired size by selecting a value on the Ratio box.



9. When the screen returns to the ASUS Update utility, flash the original BIOS to load the new boot logo.
10. After flashing the BIOS, restart the computer to display the new boot logo during POST.

5.3.2 Cool 'n' Quiet!™ Technology

The motherboard supports the AMD Cool 'n' Quiet!™ Technology that dynamically and automatically change the CPU speed, voltage, and amount of power depending on the task the CPU performs.

Enabling Cool 'n' Quiet!™ Technology

To enable Cool 'n' Quiet!™ Technology:

1. Turn on the system and enter BIOS by pressing the key during the Power On Self-Tests (POST).
2. Go to **Advanced > CPU Configuration > AMD Cool 'n'Quiet function** and set it to [Enabled]. See section “4.4 Advanced Menu.”
3. Save your changes and exit BIOS Setup.
4. Reboot your computer and set your Power Option Properties depending on your operating system.

Windows® 2000/XP

1. From the Windows® 2000/XP operating system, click **Start**. Select **Settings > Control Panel**.
2. Make sure the Control Panel is set to Classic View.
3. Double-click the **Display** icon in the Control Panel then select the Screen Saver tab.
4. Click the **Power** button. The following dialogue box appears.
5. From the Power schemes combo list box, select **Minimal Power Management**.
6. Click **OK** to effect settings.

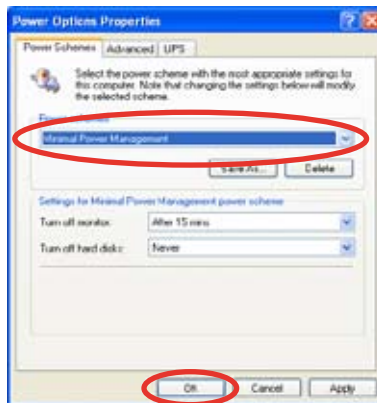



- Make sure to install the AMD Cool 'n' Quiet!™ driver and application before using this feature.
- The AMD Cool 'n' Quiet!™ technology feature works only with the AMD heatsink and fan assembly with monitor chip
- If you purchased a separate heatsink and fan package, use the ASUS Q-Fan technology feature to automatically adjust the CPU fan speed according to your system loading.

Launching the Cool 'n' Quiet!™ software

The motherboard support DVD includes the Cool 'n' Quiet!™ software that enables you to view your system's real-time CPU Frequency and voltage.



Make sure to install the Cool 'n' Quiet!™ software from the motherboard support DVD. Refer to section **5.2.3 Utilities menu** for details.

To launch the Cool 'n' Quiet!™ program:

1. If you are using Windows® 2000, click the Start button. Select **Programs > ASUS > Cool & Quiet > Cool & Quiet**.
2. If you are using Windows® XP, click the Start button. Select **All Programs > ASUS > Cool & Quiet > Cool & Quiet**.
3. The Cool 'n' Quiet!™ technology screen appears and displays the current CPU Frequency and CPU Voltage.

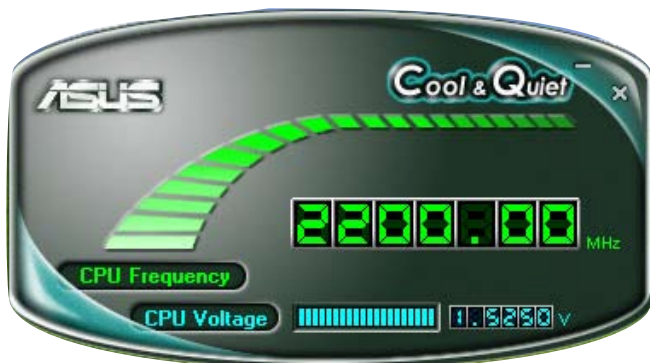

5.3.3 AI Audio 2 (SoundMAX® High Definition Audio utility)

The ADI AD1988 High Definition Audio CODEC provides 8-channel audio capability through the SoundMAX® audio utility with AudioESP™ software to deliver the ultimate audio experience on your PC. The software implements high quality audio synthesis/rendering, 3D sound positioning, and advanced voice-input technologies.

Follow the installation wizard to install the ADI AD1988 Audio Driver from the support DVD that comes with the motherboard package to activate the SoundMAX® audio utility.



You must use 4-channel, 6-channel or 8-channel speakers for this setup.

If the SoundMAX® audio utility is correctly installed, you will find the SoundMAX®/ SoundMAX® BlackHawk icon on the taskbar.



A. SoundMAX BlackHawk (AI Audio 2)

If you are using Windows Vista™ operating system, from the taskbar, double-click on the SoundMAX® BlackHawk icon to display the SoundMAX® control panel.



Enabling AI Audio 2

Click the power button  to activate digital signal processing. AI Audio 2, with the new SoundMAX® BlackHawk by Sonic Focus, brings you more multimedia enjoyment.

Fidelity Compensation

After you click the power button, the utility will compensate for the fidelity lost in the compression process and make the audio output quasi-original when reverting the compressed audio streams back to the uncompressed condition.

Sound Field Expansion

AI Audio 2 also expands the stereophonic sound field to a multi-channel one with realistic front and rear environment.

Surround Virtualization

Activating this function virtualizes surround sound with the vocal clarity added for use with stereo speakers or headphones.



SoundMAX BlackHawk (AI Audio2) is available only under the Windows® Vista™ operating system.

Playback Settings

To configure the playback settings, click the **Playback** button on the control panel. You can adjust the volume of the **Speakers** and **SPDIF Interface** or mute the audio.

Preset settings

Click and expand the drop-down menu to select your preferred Digital Signal Processing (DSP) preset. Move the sliders to customize the values of **Voice Clarity**, **Dynamics**, **Brilliance**, and **Deep Bass** of each preset. Click Save to save the changes to the current preset. Or, click **Reset** to discard the changes and restore the preset to the factory defaults.



Surround settings

Allows you to change the settings of the stereo speakers. Move the sliders to change the listener position or adjust the center channel volume. Press the **Test Speakers** button to perform speaker test.



Port settings

Click this port settings tab to display the rear panel ports configuration for the speakers or rear panel digital port configuration for the SPDIF interface.



Recording Settings

To change the recording settings, click the **Recording** button on the control panel. You can adjust the speaker delay of **Microphone** or **Line In** by moving the slider rightward or leftward.

Record testing

Click the tab to perform test recording and play the test sample through the speakers or the SPDIF interface.

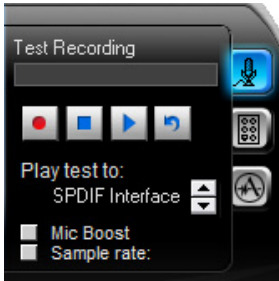

Port settings

Click the tab to display the rear panel ports for Microphone or Line In.



ANDREA settings

Allows you to select an enhanced microphone input features, including **No Filtering**, **Speakerphone**, **Voice Recording**, and **Directional Beam**.

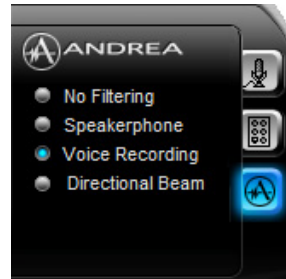

More Settings

Click  for the further configurations.

Equalizer

Allows you to configure and customize all the DSP presets frequencies.



Speakers

Allows you to adjust the **Speaker Trim** and **Speaker Delay**.



Bass

Allows you to do the Bass management.



Preferences

Displays the preference options for this utility, version information, AudioESP, etc.



B. SoundMAX

If you are using Windows XP operating system, from the taskbar, double-click on the SoundMAX® icon to display the SoundMAX® Control Panel.



Audio Setup Wizard

By clicking the  icon from the SoundMAX® control panel, you can easily configure your audio settings. Simply follow the succeeding screen instructions and begin enjoying High Definition Audio.



Jack configuration

This screen helps you configure your computer's audio ports, depending on the audio devices you have installed.



Adjust speaker volume

This screen helps you adjust speaker volume. Click the **Test** button to hear the changes you have made.



Adjust microphone volume

This screen helps you adjust microphone volume. You will be asked to read pre-written text to allow the AudioWizard to adjust the volume as you speak.



Audio preferences



Click the  icon to go to the Preferences page. This page allows you to change various audio settings.

General options

Click the General tab to choose your playback and recording devices, enable/disable the AudioESP™ feature, and enable/disable digital output.

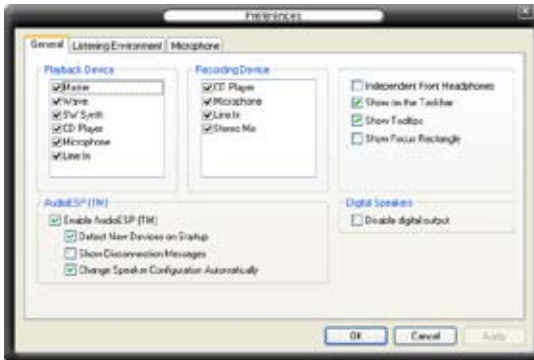

Listening Environment options

Click the Listening Environment tab to set up your speaker, acoustic environment, and enable/disable the Virtual Theater Surround function.

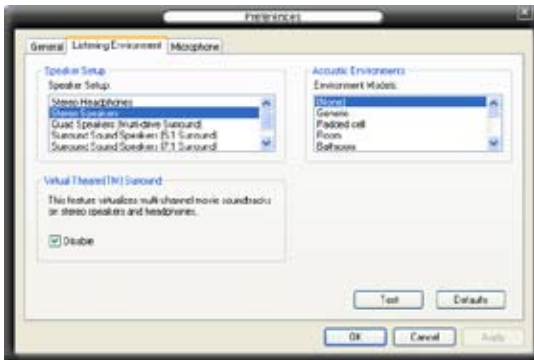

Microphone options

Click the Microphone tab allows you to optimize your microphone input settings.



Enhanced Microphone Features

Noise Filtering

Enables Noise Filter function. Detects repetitive and stationary noises like computer fans, air conditioners, and other background noises then eliminates it in the incoming audio stream while recording. You can enable it for a better recording quality.

Directional Array

Receives only the sound coming from the reception cone and eliminates interferences including neighboring speakers and reverberations. You can enable it to transit clearer sound during on-line games, MSN, or Skype.

Speaker Phone

Advanced de-reverberation techniques can help to reduce echo and minimize its effect on the speech engine. You can enable it when you have conference call to reduce echoes in the other side.



- The directional Array and Speaker Phone are purchased separately and function only when working with the ASUS Array Mic.
- If you are using Windows Vista, you have to manually enable the directional Array and Speaker Phone function. Go to **Control panel > Sound**. Click the **Recording** tab on the top and select **Microphone**. Click the **Microphone Enhancement** tab and check **Array Mic**.



5.3.4 ASUS PC Probe II

PC Probe II is a utility that monitors the computer's vital components, and detects and alerts you of any problem with these components. PC Probe II senses fan rotations, CPU temperature, and system voltages, among others. Because PC Probe II is software-based, you can start monitoring your computer the moment you turn it on. With this utility, you are assured that your computer is always at a healthy operating condition. Refer to page 1-9 for the OS that supports this utility.

Installing PC Probe II

To install PC Probe II on your computer:

1. Place the support DVD to the optical drive. The Drivers installation tab appears if your computer has an enabled Autorun feature.



If Autorun is not enabled in your computer, browse the contents of the support DVD to locate the setup.exe file from the ASUS PC Probe II folder. Double-click the **setup.exe** file to start installation.

2. Click the **Utilities** tab, then click **ASUS PC Probe II**.
3. Follow the screen instructions to complete installation.

Launching PC Probe II

You can launch the PC Probe II right after installation or anytime from the Windows® desktop.

To launch the PC Probe II from the Windows® desktop, click **Start > All Programs > ASUS > PC Probe II > PC Probe II v1.xx.xx**. The PC Probe II main window appears.

After launching the application, the PC Probe II icon appears in the Windows® taskbar. Click this icon to close or restore the application.









Using PC Probe II

Main window

The PC Probe II main window allows you to view the current status of your system and change the utility configuration. By default, the main window displays the Preference section. You can close or restore the Preference section by clicking on the triangle on the main window right handle.



Click to close the Preference panel

Button	Function
	Opens the Configuration window
	Opens the Report window
	Opens the Desktop Management Interface window
	Opens the Peripheral Component Interconnect window
	Opens the Windows Management Instrumentation window
	Opens the hard disk drive, memory, CPU usage window
	Shows/Hides the Preference section
	Minimizes the application
	Closes the application

Sensor alert

When a system sensor detects a problem, the main window right handle turns red, as the illustrations below show.



When displayed, the monitor panel for that sensor also turns red. Refer to the Monitor panels section for details.

Preference

You can customize the application using the Preference section in the main window. Click the box before each preference to activate or deactivate.

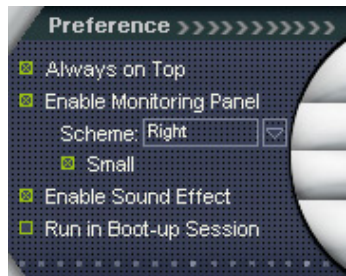

Hardware monitor panels

The hardware monitor panels display the current value of a system sensor such as fan rotation, CPU temperature, and voltages.

The hardware monitor panels come in two display modes: hexagonal (large) and rectangular (small). When you check the Enable Monitoring Panel option from the Preference section, the monitor panels appear on your computer's desktop.



Large display



Small display

Changing the monitor panels position

To change the position of the monitor panels in the desktop, click the arrow down button of the Scheme options, then select another position from the list box. Click OK when finished.



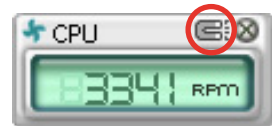

Moving the monitor panels

All monitor panels move together using a magnetic effect. If you want to detach a monitor panel from the group, click the horseshoe magnet icon. You can now move or reposition the panel independently.



Adjusting the sensor threshold value

You can adjust the sensor threshold value in the monitor panel by clicking the  or  buttons. You can also adjust the threshold values using the Config window.

You cannot adjust the sensor threshold values in a small monitoring panel.

Click to increase value

Click to decrease value



Monitoring sensor alert

The monitor panel turns red when a component value exceeds or is lower than the threshold value. Refer to the illustrations below.



Large display



Small display

WMI browser

Click **WMI** to display the WMI (Windows Management Instrumentation) browser. This browser displays various Windows® management information. Click an item from the left panel to display on the right panel. Click the plus sign (+) before WMI Information to display the available information.



You can enlarge or reduce the browser size by dragging the bottom right corner of the browser.

DMI browser

Click **DMI** to display the DMI (Desktop Management Interface) browser. This browser displays various desktop and system information. Click the plus sign (+) before DMI Information to display the available information.



PCI browser

Click **PCI** to display the PCI (Peripheral Component Interconnect) browser. This browser provides information on the PCI devices installed on your system. Click the plus sign (+) before the PCI Information item to display available information.

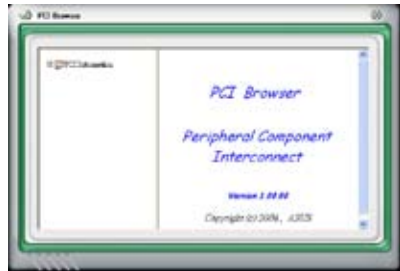

Usage

The Usage browser displays real-time information on the CPU, hard disk drive space, and memory usage. Click **USAGE** to display the Usage browser.

CPU usage

The CPU tab displays real-time CPU usage in line graph representation. If the CPU has an enabled Hyper-Threading, two separate line graphs display the operation of the two logical processors.



Hard disk drive space usage

The Hard Disk tab displays the used and available hard disk drive space. The left panel of the tab lists all logical drives. Click a hard disk drive to display the information on the right panel. The pie chart at the bottom of the window represents the used (blue) and the available HDD



Memory usage

The Memory tab shows both used and available physical memory. The pie chart at the bottom of the window represents the used (blue) and the available physical memory.



Configuring PC Probe II

Click **CONFIG** to view and adjust the sensor threshold values.

The Config window has two tabs: Sensor/Threshold and Preference. The Sensor/Threshold tab enables you to activate the sensors or to adjust the sensor threshold values. The Preference tab allows you to customize sensor alerts, or change the temperature scale.



Loads the default threshold values for each sensor

Applies your changes

Cancels or ignores your changes

Loads your saved configuration

Saves your configuration

5.3.5 ASUS AI Suite

ASUS AI Suite allows you to launch AI Gear 2, AI N.O.S., AI Booster, AI Nap, and Q-Fan 2 utilities easily.

Installing AI Suite

To install AI Suite on your computer:

1. Place the support CD to the optical drive. The Drivers installation tab appears if your computer has an enabled Autorun feature.
2. Click the Utilities tab, then click **AI Suite**.
3. Follow the screen instructions to complete installation.

Launching AI Suite

You can launch the AI Suite right after installation or anytime from the Windows® desktop.

To launch the AI Suite from the Windows® desktop, click **Start > All Programs > ASUS > AI Suite > AI Suite v1.xx.xx**. The AI Suite main window appears.

After launching the application, the AI Suite icon appears in the Windows® taskbar. Click this icon to close or restore the application.

Using AI Suite

Click the AI N.O.S., AI Gear 2, AI Nap, AI Booster, or Q-Fan 2 icon to launch the utility, or click the Normal icon to restore the system to normal state.

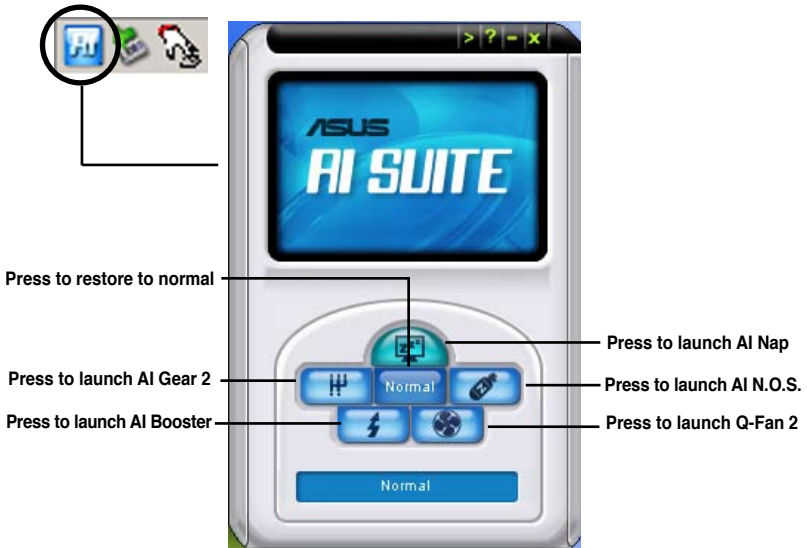

Other feature buttons

Click  on right corner of the main window to open the monitor window.

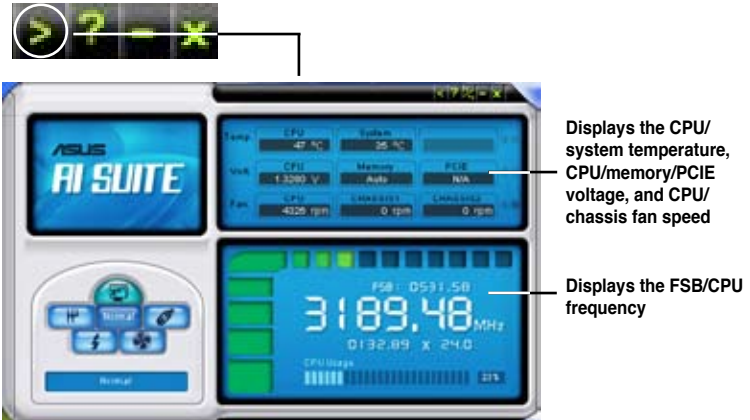

Click  on right corner of the expanded window to switch the temperature from degrees Centigrade to degrees Fahrenheit.



5.3.6 ASUS AI Gear 2

ASUS AI Gear 2 provides four system performance options that allows you to select the best performance setting for your computing needs. This easy-to-use utility adjusts the processor frequency and vCore voltage to minimize system noise and power consumption.

After installing AI Suite from the bundled support CD, you can launch AI Gear 2 by double-clicking the AI Suite icon on your Windows OS taskbar and then click the AI Gear 2 button on the AI Suite main window.

Shift the gear to the performance setting that you like.

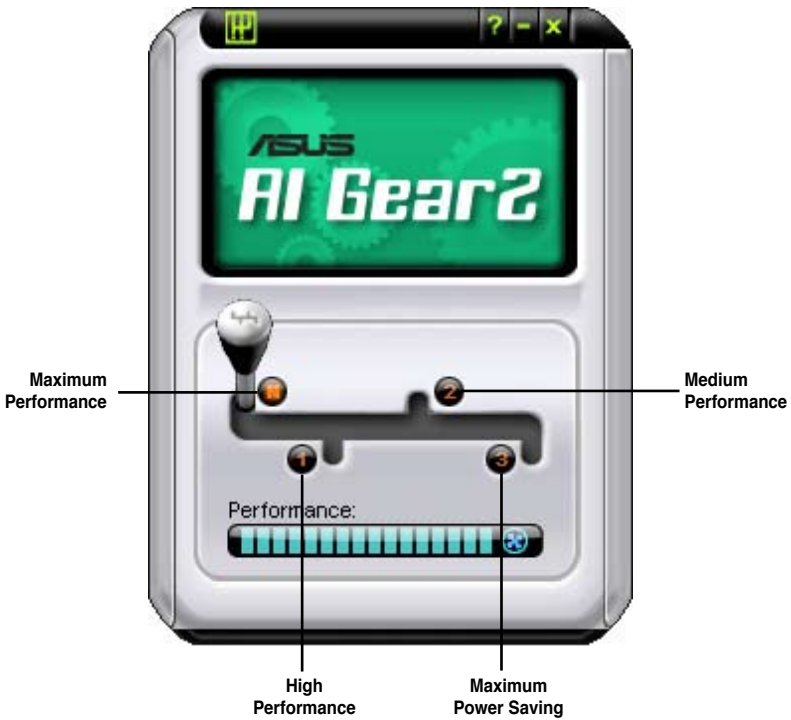

5.3.7 ASUS AI Nap

This feature allows you to minimize the power consumption of your computer whenever you are away. Enable this feature for minimum power consumption and a more quiet system operation.

After installing AI Suite from the bundled support CD, you can launch the utility by double-clicking the AI Suite icon on the Windows OS taskbar and click the AI Nap button on the AI Suite main window.

Click **Yes** on the confirmation screen.

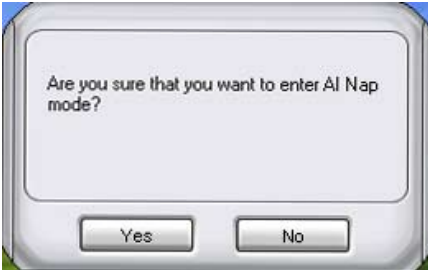

To exit AI Nap mode, press the system power or mouse button then click **Yes** on the confirmation screen.

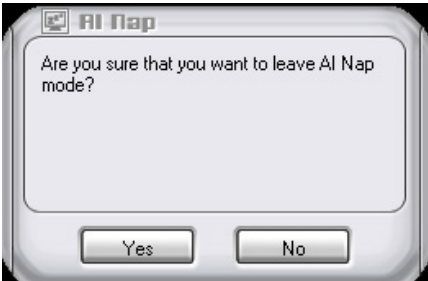

To switch the power button functions from AI Nap to shutting down, just right click the **AI Suite** icon on the OS taskbar, select **AI Nap** and click **Use power button**. Unclick the the item to switch the function back.

5.3.8 ASUS AI N.O.S.

This ASUS Non-delay Overclocking System feature intelligently determines the system load and automatically boosts the performance for the most demanding tasks.

After installing AI Suite from the bundled support CD, you can launch the utility by double-clicking the AI Suite icon on the Windows OS taskbar and click the AI N.O.S. button on the AI Suite main window.

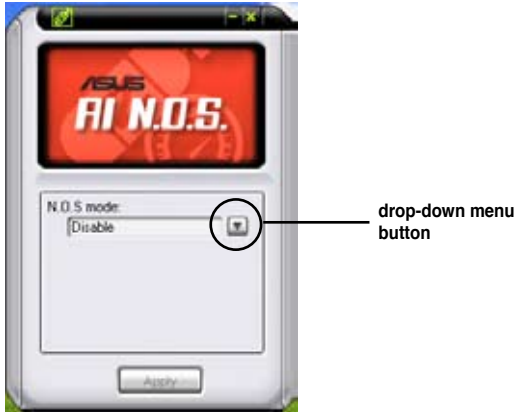

Click the drop-down menu button and select **Disable** or **Manual**.

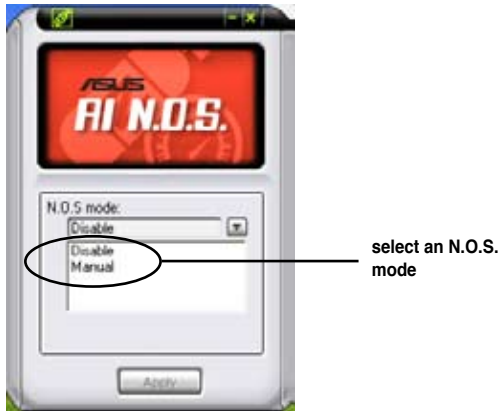

Click **Apply** at the bottom to save the configuration.

5.3.9 ASUS Q-Fan 2

This ASUS Q-Fan 2 Control feature allows you to set the appropriate performance level of the CPU Q-Fan 2 or the Chassis Q-Fan 2 for more efficient system operation. After enabling the Q-Fan 2 function, the fans can be set to automatically adjust depending on the temperature, to decrease fan speed, or to achieve the maximum fan speed.

After installing AI Suite from the bundled support CD, you can launch the utility by double-clicking the AI Suite icon on the Windows® OS taskbar and click the Q-Fan 2 button on the AI Suite main window.

Click the drop-down menu button and display the fan names. Select **CPU Q-Fan 2** or **CHASSIS Q-Fan 2**. Click the box of **Enable Q-Fan 2** to activate this function.



Profile list appears after clicking the **Enable Q-Fan 2** box. Click the drop-down list button and select a profile. **Optimal** mode makes the fans adjust speed with the temperature; **Silent** mode minimizes fan speed for quiet fan operation; **Performance** mode boosts the fan to achieve maximal fan speed for the best cooling effect.

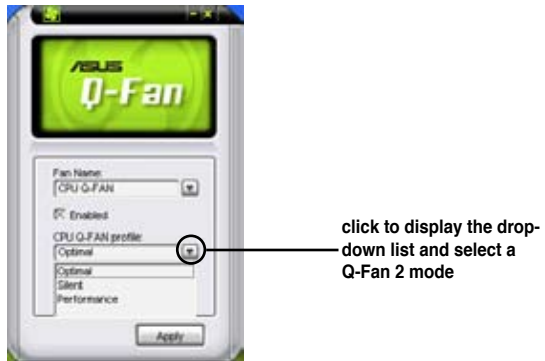

Click **Apply** at the bottom to save the setup.

5.3.10 ASUS AI Booster

The ASUS AI Booster application allows you to overclock the CPU speed in Windows® environment without the hassle of booting the BIOS.

After installing AI Suite from the bundled support CD, you can launch the utility by double-clicking the AI Suite icon on the Windows® OS taskbar and click the AI Booster button on the AI Suite main window.



The options on the taskbar allow you to use the default settings, adjust CPU/ Memory/PCI-E frequency manually, or create and apply your personal overclocking configurations.

5.3.11 AMD OverDrive (AOD)

The AMD® OverDrive™ utility allows you to configure system and overclocking settings in Windows® environment. These configurations will not be saved to BIOS after the system reboots.



5.4 RAID configurations

The motherboard comes with two RAID controllers that allow you to configure Serial ATA hard disk drives as RAID sets.

- **AMD SB600 Southbridge RAID** includes a high performance SATA RAID controller that supports RAID 0, RAID 1, and RAID 0+1 for four independent SATA channels.
- **Marvell® 6121 RAID** includes a high performance SATA RAID controller that supports RAID 0 and RAID 1 for two independent SATA channels.

5.4.1 RAID definitions

RAID 0 (*Data striping*) optimizes two identical hard disk drives to read and write data in parallel, interleaved stacks. Two hard disks perform the same work as a single drive but at a sustained data transfer rate, double that of a single disk alone, thus improving data access and storage. Use of two new identical hard disk drives is required for this setup.

RAID 1 (*Data mirroring*) copies and maintains an identical image of data from one drive to a second drive. If one drive fails, the disk array management software directs all applications to the surviving drive as it contains a complete copy of the data in the other drive. This RAID configuration provides data protection and increases fault tolerance to the entire system. Use two new drives or use an existing drive and a new drive for this setup. The new drive must be of the same size or larger than the existing drive.

RAID 0+1 is data striping and data mirroring combined without parity (redundancy data) having to be calculated and written. With the RAID 0+1 configuration you get all the benefits of both RAID 0 and RAID 1 configurations. Use four new hard disk drives or use an existing drive and three new drives for this setup.



If you want to boot the system from a hard disk drive included in a RAID set, copy first the RAID driver from the support DVD to a floppy disk/USB device before you install an operating system to a selected hard disk drive. Refer to section **5.6 Creating a RAID driver disk** for details.

5.4.2 Installing Serial ATA hard disks

The motherboard supports Serial ATA hard disk drives. For optimal performance, install identical drives of the same model and capacity when creating a disk array.

To install the SATA hard disks for a RAID configuration:

1. Install the SATA hard disks into the drive bays.
2. Connect the SATA signal cables.
3. Connect a SATA power cable to the power connector on each drive.

5.4.3 AMD[®] RAID configurations

This motherboard supports RAID 0, RAID 1, RAID 0+1 configurations for Serial ATA hard disks drives through the AMD SB600 Southbridge chip.

Setting the RAID item in BIOS

You must set the RAID item in the BIOS Setup before you can create a RAID set(s). To do this:

1. Install the internal Serial ATA hard disk drives to the SATA connectors labeled **SATA_1/2/3/4**.
2. Boot up your computer, and press during POST to enter the BIOS setup.
3. In the Main Menu, go to **Storage Configuration**, and set the **OnChip SATA Type** item to [RAID].
3. Press <F10> to save the changes and exit.



The RAID BIOS setup screens shown in this section are for reference only, and may not exactly match the items on your screen.

AMD® FastBuild™ Utility

To enter the AMD® FastBuild™ utility:

1. Boot up your computer.
2. Press <Ctrl+F> during POST to display the main menu of the utility.

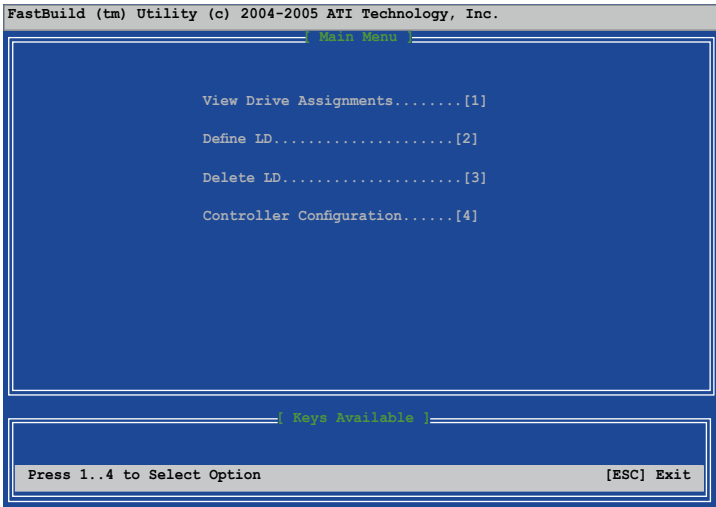

The Main Menu above allows you to select an operation to perform. The Main Menu options include:

- **View Drive Assignments:** shows the status of the hard disk drives.
- **Define LD:** creates a RAID 0, RAID 1, or RAID 0+1 configuration.
- **Delete LD:** deletes a selected RAID set and partition.
- **Controller Configuration:** Shows the system resources configuration.

Press <1>, <2>, <3>, or <4> to enter the option you need; press <ESC> to exit the utility.

Creating a RAID 0 configuration

To create a RAID 0 set:

1. In the Main Menu, press <F2> to enter the “Define LD” function.
2. Press <Enter>, and the following screen appears.

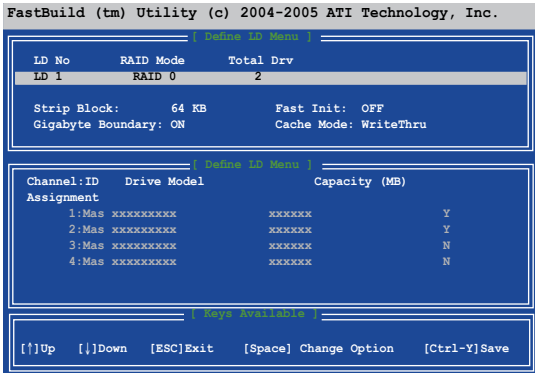

3. Highlight the **LD1** item and press <Space> to select **RAID 0**.
4. Move to the **Assignment** item by using the down arrow key and set **Y** to any two of the drives.
5. Press <Ctrl+Y> to save the setting. The utility prompts the following messages:

```
Press Ctrl-Y if you are sure to erase MBR! Press any other
key to ignore this option...
```

Press <Ctrl+Y> to erase MBR or press any key to continue.

```
Press Ctrl-Y to Modify Array Capacity or press any other key
to use maximum capacity...
```

Press <Ctrl+Y> to key in the desired capacity or press any key to continue.

6. The utility displays the following screen.

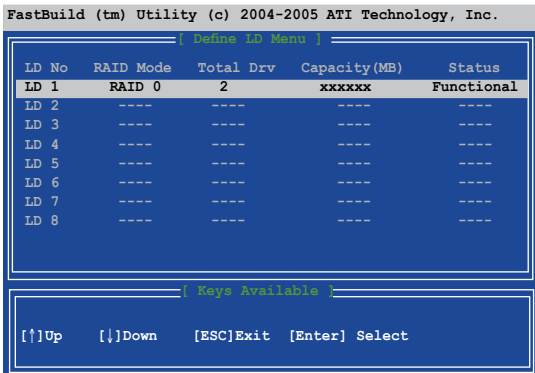

Creating a RAID 1 configuration

To create a RAID 1 set:

1. In the Main Menu, press <2> to enter the “Define LD” function.
2. Press <Enter>, and the following screen appears.

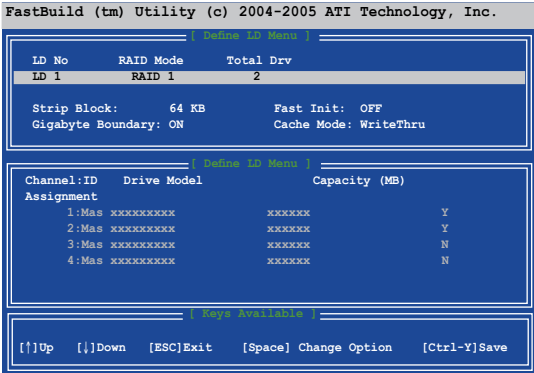

3. Highlight the **LD1** item and press <Space> to select **RAID 1**.
4. Move to the **Assignment** item by using the down arrow key and set **Y** to any two of the drives.
5. Press <Ctrl+Y> to save the setting. The utility prompts the following messages:

```
Press Ctrl-Y if you are sure to erase MBR! Press any other
key to ignore this option...
```

Press <Ctrl+Y> to erase MBR or press any key to continue.

```
Press Ctrl-Y to Modify Array Capacity or press any other key
to use maximum capacity...
```

Press <Ctrl+Y> to key in the desired capacity or press any key to continue.

6. The utility displays the following screen.

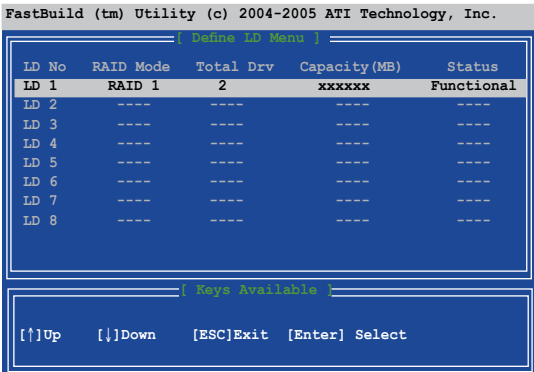

Creating a RAID 0+1 configuration

To create a RAID 0+1 set:

1. In the Main Menu, press <F2> to enter the “Define LD” function.
2. Press <Enter>, and the following screen appears.

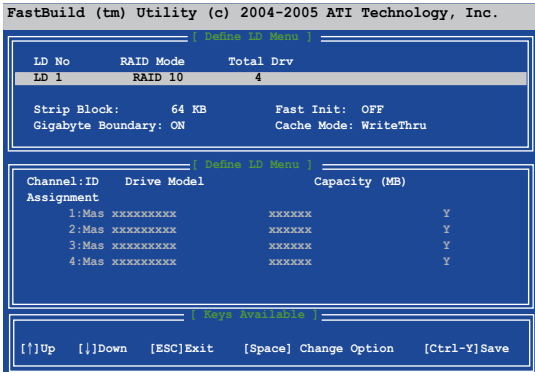

3. Highlight the **LD1** item and press <Space> to select **RAID 10**.
4. Move to the **Assignment** item by using the down arrow key and set **Y** to any four of the drives.
5. Press <Ctrl+Y> to save the setting. The utility prompts the following messages:

```
Press Ctrl-Y if you are sure to erase MBR! Press any other
key to ignore this option...
```

Press <Ctrl+Y> to erase MBR or press any key to continue.

```
Press Ctrl-Y to Modify Array Capacity or press any other key
to use maximum capacity...
```

Press <Ctrl+Y> to key in the desired capacity or press any key to continue.

6. The utility displays the following screen.

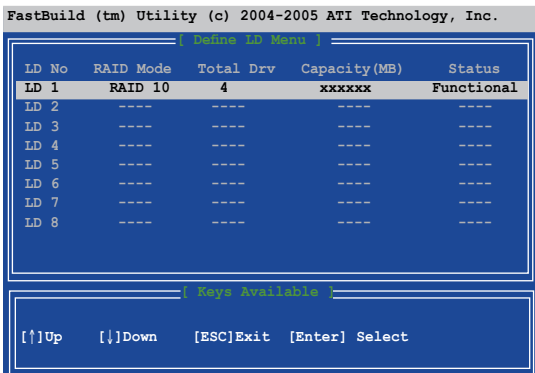

Deleting a RAID configuration

To create a RAID set:

1. In the Main Menu, press <3> to enter the “Delete LD” function.
2. Select the RAID item you want to delete and press or <Alt+D>.

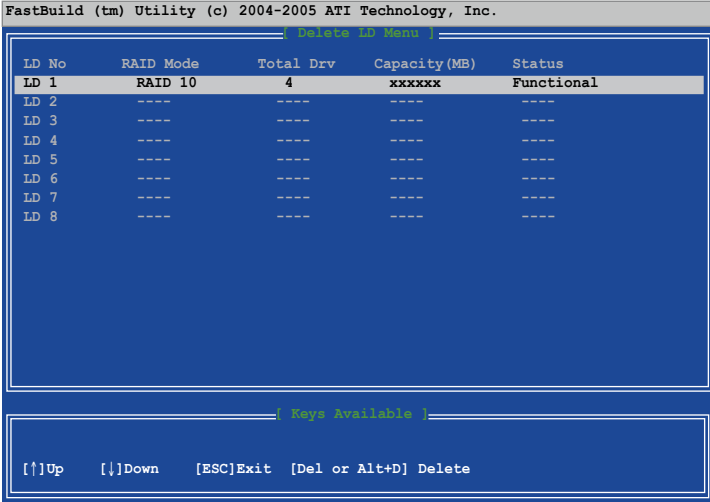

5.4.4 Marvell® RAID configurations

The Marvell® 6121 Serial ATA controller allows you to configure RAID 0 and RAID 1 sets on the Serial ATA hard disk drives.

Setting the RAID item in BIOS

You must set the RAID item in the BIOS Setup before you can create a RAID set(s). To do this:

1. Install two internal Serial ATA hard disk drives to the SATA connectors labeled **SATA_RAID1/2**.
2. Boot up your computer, and press during POST to enter the BIOS setup.
3. In the Advanced Menu, go to **Onboard Devices Configuration**, and enable both **Marvell 6121 SATA Controller** and **Marvell Option ROM**.
4. Set **Marvell IDE/RAID function** to [RAID].

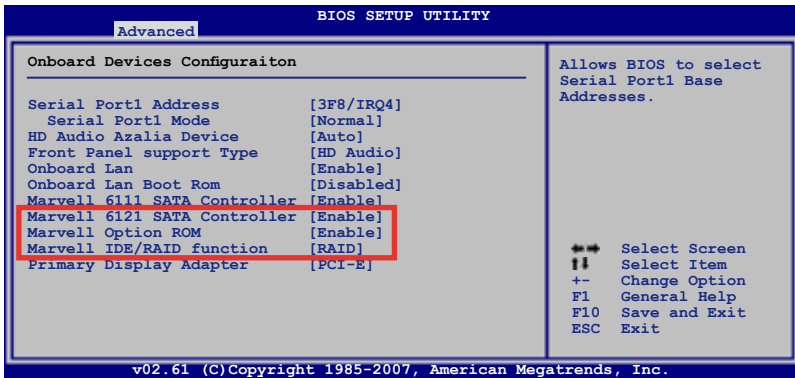

3. Press <F10> to save the changes and exit.



The RAID BIOS setup screens shown in this section are for reference only, and may not exactly match the items on your screen.

Marvell® RAID BIOS Configuration utility

To enter the Marvell® RAID BIOS Configuration utility:

1. Boot up your computer.
2. During POST, press <Ctrl> + <M> to enter the utility main menu.

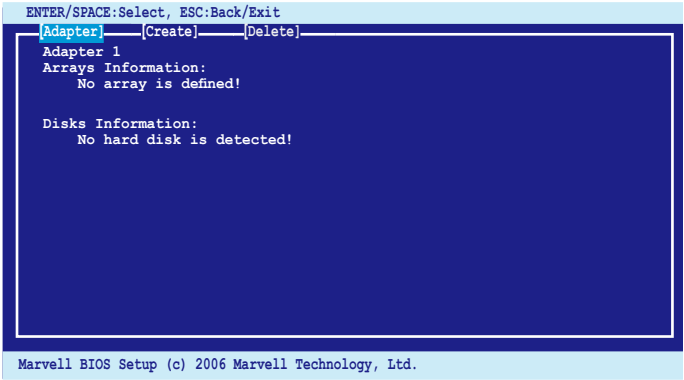

3. Highlight **Adapter** and press <Enter>. Select **Adapter 2** for RAID configuration.

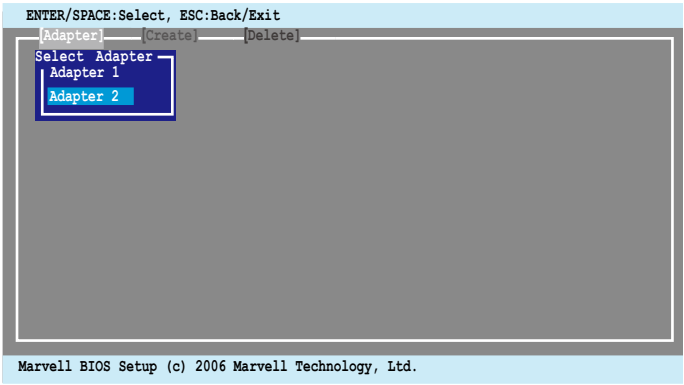

Creating a RAID 0 or RAID 1 set

To create a RAID set:

1. From the utility menu bar, highlight **Create** on the top.

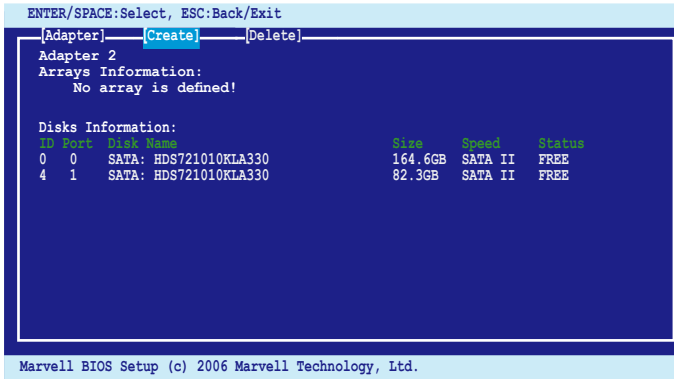

2. Press <Enter>. The screen shows the disks you can add to make up the RAID set. Use the arrow key to select a disk and press <Enter> or <Space> to include this disk in the array.

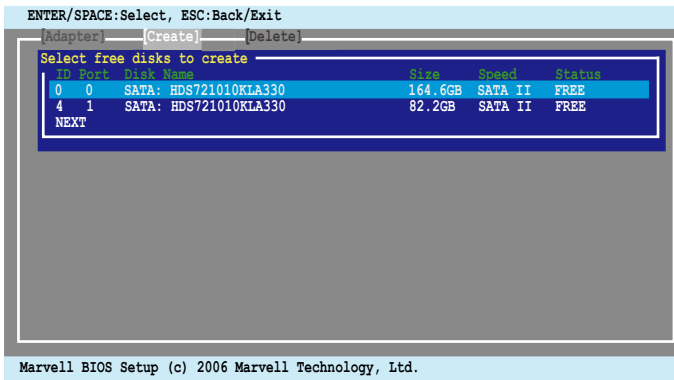

3. After you have selected the desired disks, select **NEXT** to create array.

4. The "Create Array" screen appears.

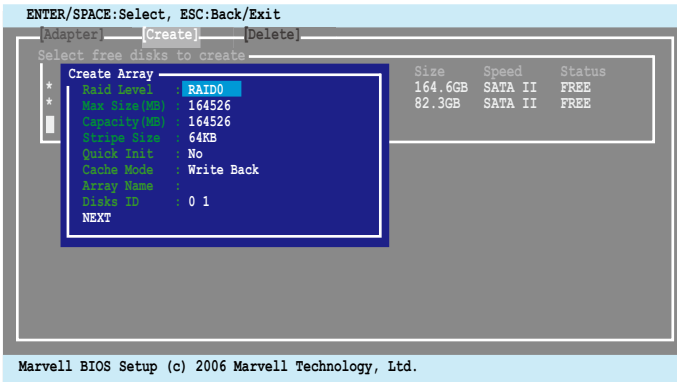

5. Use the arrow key to select the **Raid Level** item and press <Enter> to display the available RAID set. Select a RAID set and press <Enter> to create.

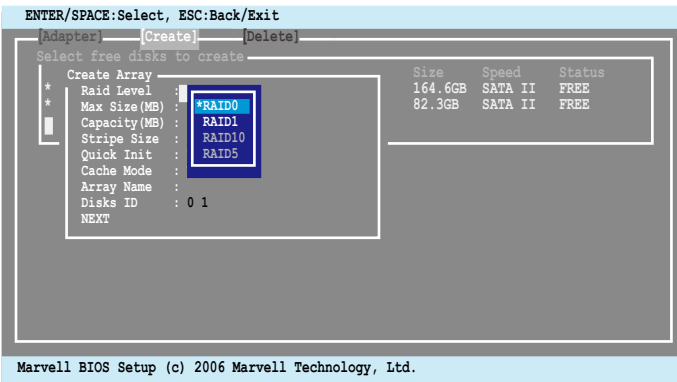

- The available RAID sets vary with the number of disks you select. The RAID sets that you are not allowed to create are grayed out.
- We recommend that you keep the default values of the items other than Raid Level in the Create Array screen.

6. A confirmation screen appears. Press <Y> to confirm the array creation.

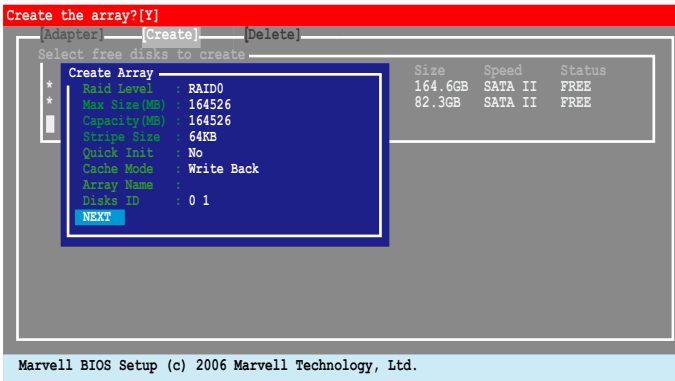

7. The newly created array appears in Arrays Information.

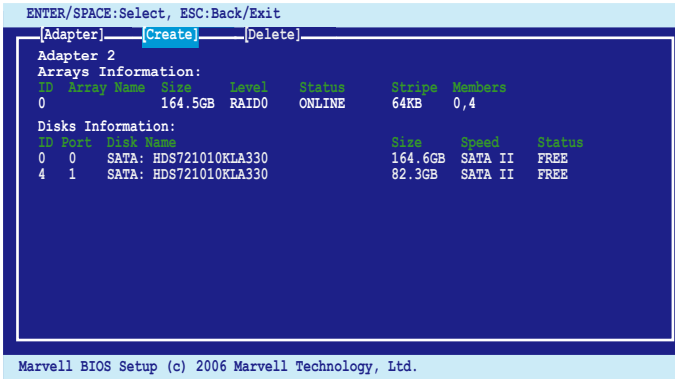

Deleting an array

To delete a RAID set:

1. From the utility menu bar, select **Delete** on the top and press <Enter>. The "Delete array" screen appears.

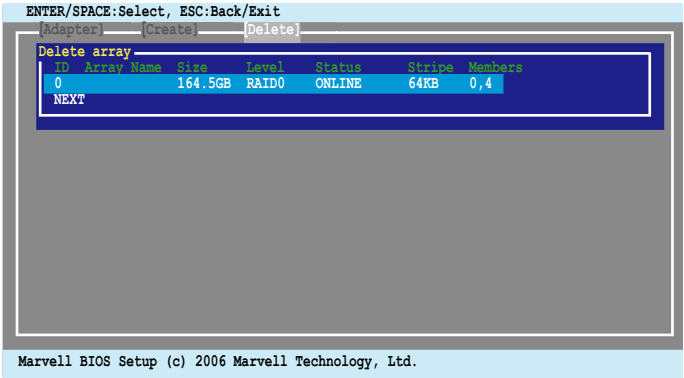

2. Select a desired array to delete and select **NEXT**. Press <Y> after the confirmation screen appears.

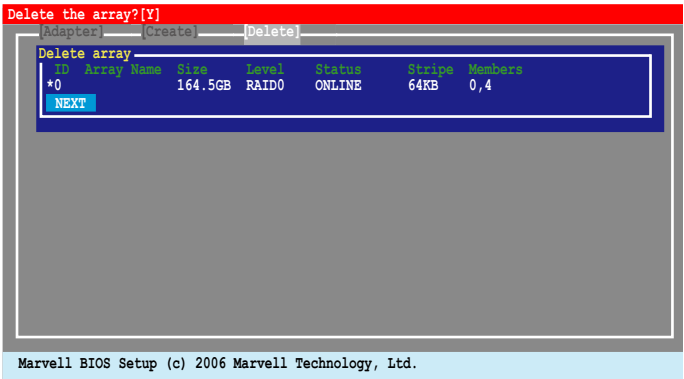

3. Press <Y> again to confirm and delete the selected array.



You cannot recover lost data if you delete an array. Make sure you back up important data before deleting an array.

5.5 Creating a RAID driver disk

A floppy disk with the RAID driver is required when installing Windows® XP operating system on a hard disk drive that is included in a RAID set. For Windows® Vista™ operating system, use either a floppy disk or a USB device with the RAID driver.

5.5.1 Creating a RAID driver disk without entering the OS

To create a RAID/SATA driver disk without entering the OS:

1. Boot your computer.
2. Press during POST to enter the BIOS setup utility.
3. Set the optical drive as the primary boot device.
4. Insert the support CD into the optical drive.
5. Save changes and exit BIOS.
6. Press any key when the system prompts “Press any key to boot from the optical drive.”
7. When the menu appears, press <1> to create a RAID driver disk.
8. Insert a formatted floppy disk into the floppy drive then press <Enter>.
9. Follow succeeding screen instructions to complete the process.

5.5.2 Creating a RAID/SATA driver disk in Windows®

To create a RAID driver disk in Windows®:

1. Start Windows®.
2. Place the motherboard support DVD into the optical drive.
3. Go to the Make Disk menu, then click **Make ATI RAID WinXP/Vista Driver** to create an SB 600 RAID driver disk or the **Marvell 61xx 32/64bit SATA RAID Driver** to create a Marvell® 6121 RAID driver disk.
4. Insert a floppy disk/USB device into the floppy disk drive/USB port.
5. Follow succeeding screen instructions to complete the process.



Write-protect the floppy disk to avoid computer virus infection.

To install the RAID driver in Windows® XP:

1. During the OS installation, the system prompts you to press the F6 key to install third-party SCSI or RAID driver.
2. Press <F6> then insert the floppy disk with RAID driver into the floppy disk drive.
3. When prompted to select the SCSI adapter to install, make sure you select **SB 600** and **Marvell 6121**.
4. Follow the succeeding screen instructions to complete the installation.

To install the RAID driver in Windows® Vista™:

1. Insert the floppy disk/USB device with RAID driver into the floppy disk drive/USB port.
2. During the OS installation, select **SB 600** and **Marvell 6121**.
3. Follow the succeeding screen instructions to complete the installation.

This chapter tells how to install ATI®
CrossFire™ graphics cards to avail of
ATI's Multi-Video Processing technology.

ATI® CrossFire™ technology support

Chapter summary

6.1	Overview	6-1
6.2	Installing CrossFire™ graphics cards	6-2
6.3	Software information	6-5

6.1 Overview

The motherboard supports the ATI® CrossFire™ technology that allows you to install multi-graphics processing units (GPU) graphics cards. Follow the installation procedures in this section.

6.1.1 Requirements

- CrossFire™ Edition graphics card (Master)
- CrossFire™-ready graphics card (Slave)
- CrossFire™-ready motherboard, such as the ASUS M3A32-MVP Deluxe Series motherboard.
- Make sure that your power supply unit (PSU) can provide at least the minimum power required by your system. See “9. ATX power connectors” on page 2-34 for details.



-
- Visit the ATI website or download the Radeon® X850 Crossfire™ Edition User's Guide from the support CD for detailed hardware requirements and installation procedures.
 - The ATI CrossFire™ technology supports only the following operating systems:
 - Windows® XP 32-bit (Home or Professional) with Service Pack 2 (SP2)
 - Windows® XP Professional 64-bit Edition.
 - Make sure that your graphics card driver supports the ATI® CrossFire™ Technology. Download the latest driver from the ATI website (www.amd.com).
 - The maximum resolution of Radeon™ X850 CrossFire™ Edition is 1600 x 1200 at 65 MHz when you use DVI output.
-

6.1.2 Before you begin

Uninstall other graphics card drivers in your system

To uninstall other graphics card drivers:

1. Close all current applications.
2. Go to Control Panel > Add/Remove Programs.
3. Select your current graphics card driver/s.
4. Select **Add/Remove**.
5. Restart your system.

6.2 Installing CrossFire™ graphics cards



Before installing a CrossFire™ system, refer to the user guide that came with the ATI® CrossFire™ Edition graphics card.

To install the graphics cards:

1. Prepare one CrossFire™ Edition (Master) graphics card and one CrossFire™-ready (Slave) graphics card.

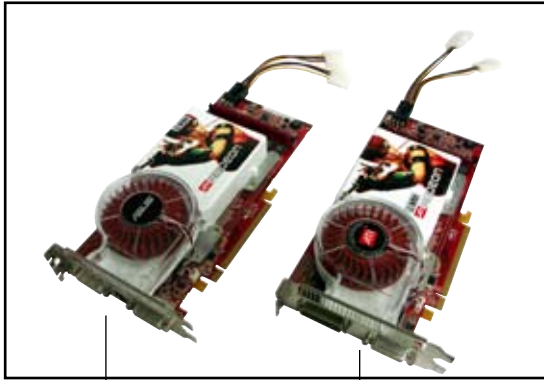

Slave graphics card

Master graphics card

2. Insert the CrossFire™ Edition (Master) graphics card into the PCI Express x16 blue slot. Make sure that the card is properly seated on the slot.

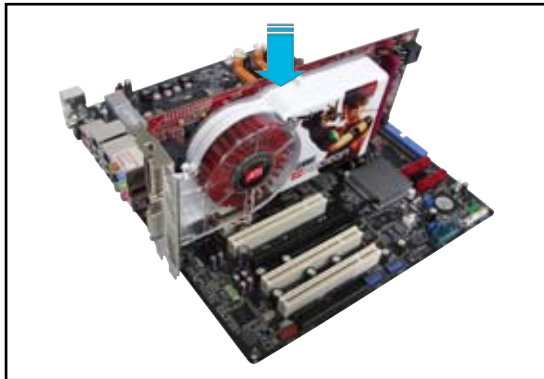

3. Insert the CrossFire™-ready (Slave) graphics card into the PCI Express x16 black slot. Make sure that the card is properly seated on the slot.

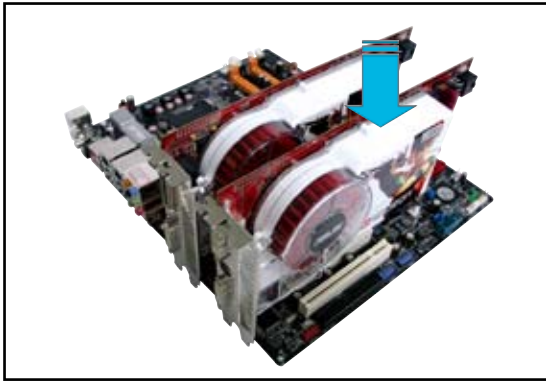

4. Connect an auxiliary power source from the power supply to the graphics cards.

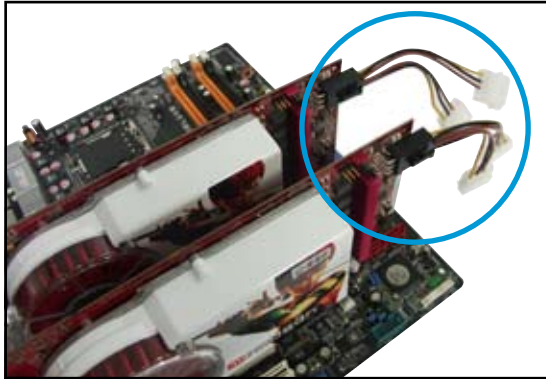

5. Connect one end of the external cable to the Master graphics card.

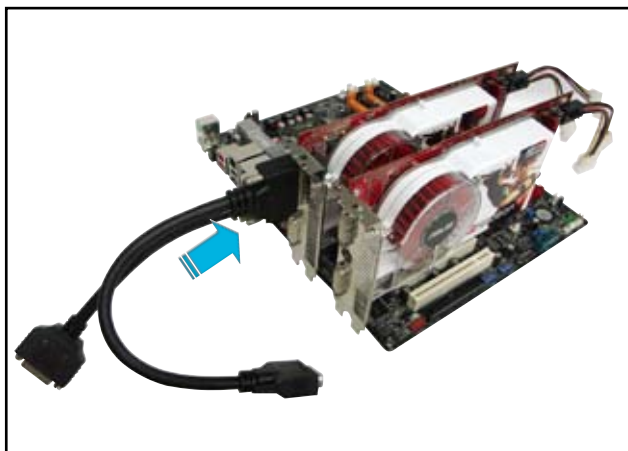

6. Connect the other end of the external cable to the Slave graphics card.
7. Connect the loose end to the corresponding port on your monitor.

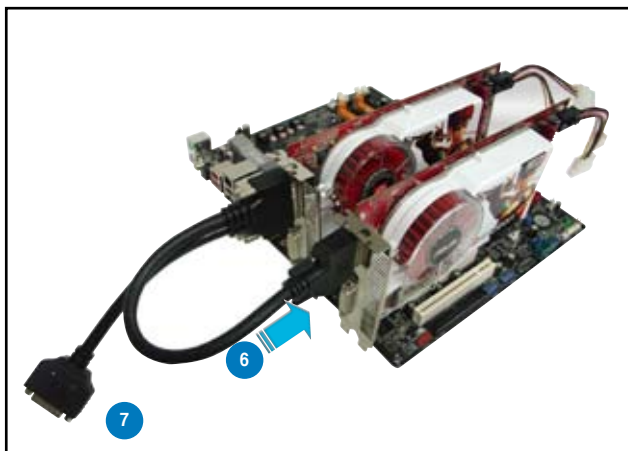

6.3 Software information

6.3.1 Installing the device drivers

Refer to the documentation that came with your graphics card package to install the device drivers.



The ATI CrossFire™ technology supports only the following operating systems:

- Windows® XP 32-bit (Home or Professional) with Service Pack 2 (SP2)
- Windows® XP Professional 64-bit Edition.

1. Turn on your system and log in with administrator rights.
2. Windows® auto-detects the CrossFire™ graphics cards and displays the Found New Hardware Wizard window. Click **Cancel**.
3. Place the CrossFire™ installation CD in your optical drive and install drivers from the opening menu.



4. Click **Next** to continue from the installation window that appears.

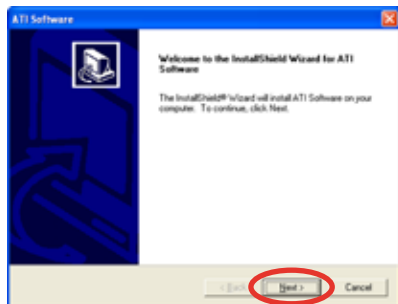

5. Read the License Agreement, then click **Yes**.



6. Select the components that you want to install, then click **Next**.

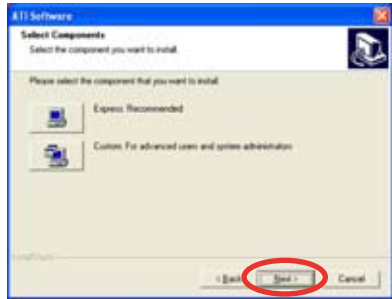

- Select Express to install the HydraVision™ multi-monitor and desktop management software, as well as the AMD driver.
- Select Custom to individually choose desired software components.

Setup prepares the installation wizard that will guide you to setup process.



Windows automatically configures the ATI Catalyst Control Center. The status windows indicates the progress of the installation.

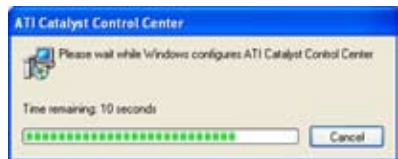

7. The Setup Complete window appears, indicating that the driver files have been copied to your computer. Click **Yes** to restart your computer now or **No** to restart later
8. Click **Finish**.

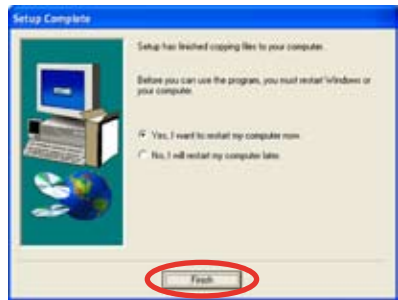

6.3.2 Using the Catalyst™ Control Center

The Catalyst™ Control Center allows you to access display features of the ATI hardware and software you installed. Use this application to adjust your graphic settings, enable/disable connected devices, and change your desktop orientation.

Launching the Catalyst™ Control Center

There are several ways to launch the Catalyst™ Control Center:

- On the Windows® task bar, click **Start > ATI Catalyst™ Control Center > Catalyst™ Control Center**.
- Double-click on the Catalyst™ Control Center desktop shortcut.



- On the Windows® task bar, double-click on the Catalyst™ Control Center icon.



The Catalyst™ Control Center Dialog Box

View

The Catalyst™ Control Center provides two views:

- **Standard** - simple view with wizards for beginners



- **Advance** - allows advanced users to access and configure the complete features of the software



Set to **Advance** view to enable the CrossFire™ function.

To enable CrossFire™:

1. Set the view to **Advance**.
2. Click the Crossfire™ item in Graphics Settings.
3. In the CrossFire™ Settings dialog, tick the box opposite **Enable CrossFire™**.
4. Click **OK** to effect the setting.



Hotkeys

Click the **Hotkeys** tab on the Catalyst™ Control Center to access the Hotkeys Manager, which allows you to create key combinations as shortcuts for performing certain functions quickly.



Profiles

Click the **Profiles** tab on the Catalyst™ Control Center to access the Profiles Manager, which allows you to create customized environments for your desktop, video, and 3D applications.



Preferences

Click the **Preferences** tab on the Catalyst™ Control Center to select a language, restore defaults, change skins, or enable/disable the System Tray icon.



Help

Click the **Help** tab on the Catalyst™ Control Center to access the online help system, generate a Problem Report, and get the Catalyst™ Control Center version information.



