

P5B-VM DO

Motherboard



E2869

First Edition V1
October 2006

Copyright © 2006 ASUSTeK COMPUTER INC. All Rights Reserved.

No part of this manual, including the products and software described in it, may be reproduced, transmitted, transcribed, stored in a retrieval system, or translated into any language in any form or by any means, except documentation kept by the purchaser for backup purposes, without the express written permission of ASUSTeK COMPUTER INC. ("ASUS").

Product warranty or service will not be extended if: (1) the product is repaired, modified or altered, unless such repair, modification of alteration is authorized in writing by ASUS; or (2) the serial number of the product is defaced or missing.

ASUS PROVIDES THIS MANUAL "AS IS" WITHOUT WARRANTY OF ANY KIND, EITHER EXPRESS OR IMPLIED, INCLUDING BUT NOT LIMITED TO THE IMPLIED WARRANTIES OR CONDITIONS OF MERCHANTABILITY OR FITNESS FOR A PARTICULAR PURPOSE. IN NO EVENT SHALL ASUS, ITS DIRECTORS, OFFICERS, EMPLOYEES OR AGENTS BE LIABLE FOR ANY INDIRECT, SPECIAL, INCIDENTAL, OR CONSEQUENTIAL DAMAGES (INCLUDING DAMAGES FOR LOSS OF PROFITS, LOSS OF BUSINESS, LOSS OF USE OR DATA, INTERRUPTION OF BUSINESS AND THE LIKE), EVEN IF ASUS HAS BEEN ADVISED OF THE POSSIBILITY OF SUCH DAMAGES ARISING FROM ANY DEFECT OR ERROR IN THIS MANUAL OR PRODUCT.

SPECIFICATIONS AND INFORMATION CONTAINED IN THIS MANUAL ARE FURNISHED FOR INFORMATIONAL USE ONLY, AND ARE SUBJECT TO CHANGE AT ANY TIME WITHOUT NOTICE, AND SHOULD NOT BE CONSTRUED AS A COMMITMENT BY ASUS. ASUS ASSUMES NO RESPONSIBILITY OR LIABILITY FOR ANY ERRORS OR INACCURACIES THAT MAY APPEAR IN THIS MANUAL, INCLUDING THE PRODUCTS AND SOFTWARE DESCRIBED IN IT.

Products and corporate names appearing in this manual may or may not be registered trademarks or copyrights of their respective companies, and are used only for identification or explanation and to the owners' benefit, without intent to infringe.

Contents

Notices.....	vi
Safety information	vii
P5B-VM DO specifications summary	x

Chapter 1: Product introduction

1.1	Welcome!	1-2
1.2	Package contents	1-2
1.3	Special features	1-2
1.3.1	Product highlights	1-2
1.3.2	ASUS Features	1-4
1.3.3	ASUS Special Features	1-5
1.3.4	ASUS Intelligent Overclocking Features.....	1-5
1.4	Before you proceed	1-6
1.5	Motherboard overview	1-7
1.5.1	Placement direction	1-7
1.5.2	Screw holes	1-7
1.5.3	Motherboard layout.....	1-8
1.5.4	Layout contents.....	1-9
1.6	Central Processing Unit (CPU)	1-11
1.6.1	Installing the CPU	1-12
1.6.2	Installing the CPU heatsink and fan	1-14
1.6.3	Uninstalling the CPU heatsink and fan	1-16
1.7	System memory	1-18
1.7.1	Overview	1-18
1.7.2	Memory configurations.....	1-18
1.7.3	Installing a DIMM	1-23
1.7.4	Removing a DIMM	1-23
1.8	Expansion slots	1-24
1.8.1	Installing an expansion card	1-24
1.8.2	Configuring an expansion card	1-24
1.8.3	Interrupt assignments	1-25
1.8.4	PCI slots.....	1-27
1.8.5	PCI Express x4 slot.....	1-27
1.8.6	PCI Express x16 slot.....	1-27

Contents

1.9	Jumpers	1-28
1.10	Connectors	1-30
1.10.1	Rear panel connectors	1-30
1.10.2	Internal connectors	1-32
Chapter 2: BIOS setup		
2.1	Managing and updating your BIOS	2-2
2.1.1	Creating a bootable floppy disk	2-2
2.1.2	ASUS EZ Flash 2 utility	2-3
2.1.3	AFUDOS utility	2-4
2.1.4	ASUS CrashFree BIOS 3 utility	2-6
2.1.5	ASUS Update utility	2-8
2.2	BIOS setup program	2-11
2.2.1	BIOS menu screen	2-12
2.2.2	Menu bar	2-12
2.2.3	Navigation keys	2-12
2.2.4	Menu items	2-13
2.2.5	Sub-menu items	2-13
2.2.6	Configuration fields	2-13
2.2.7	Pop-up window	2-13
2.2.8	Scroll bar	2-13
2.2.9	General help	2-13
2.3	Main menu	2-14
2.3.1	System Time	2-14
2.3.2	System Date	2-14
2.3.3	Legacy Diskette A	2-14
2.3.4	SATA1-6	2-15
2.3.5	IDE Configuration	2-16
2.3.6	System Information	2-17
2.4	Advanced menu	2-18
2.4.1	Jumperfree Configuration	2-18
2.4.2	USB Configuration	2-20
2.4.3	TPM Configuration	2-21
2.4.4	CPU Configuration	2-22
2.4.5	Chipset	2-24

Contents

2.4.6	Onboard Devices Configuration	2-27
2.4.7	PCI PnP	2-29
2.5	Power menu	2-30
2.5.1	Suspend Mode [Auto]	2-30
2.5.2	Repost Video on S3 Resume [No]	2-30
2.5.3	ACPI 2.0 Support [ACPI v1.0]	2-30
2.5.4	ACPI APIC Support [Enabled]	2-30
2.5.5	APM Configuration	2-31
2.5.6	Hardware Monitor	2-32
2.6	Boot menu	2-33
2.6.1	Boot Device Priority	2-33
2.6.2	Boot Settings Configuration	2-34
2.6.3	Security	2-35
2.7	Tools menu	2-37
2.7.1	ASUS EZ Flash 2	2-37
2.8	Exit menu	2-38

Chapter 3: Software support

3.1	Installing an operating system	3-2
3.2	Support CD information	3-2
3.2.1	Running the support CD	3-2
3.2.2	Drivers menu	3-3
3.2.3	Utilities menu	3-4
3.2.4	Make disk menu	3-5
3.2.5	Manuals menu	3-6
3.2.6	ASUS Contact information	3-6
3.2.7	Other information	3-7

Notices

Federal Communications Commission Statement

This device complies with Part 15 of the FCC Rules. Operation is subject to the following two conditions:

- This device may not cause harmful interference, and
- This device must accept any interference received including interference that may cause undesired operation.

This equipment has been tested and found to comply with the limits for a Class B digital device, pursuant to Part 15 of the FCC Rules. These limits are designed to provide reasonable protection against harmful interference in a residential installation. This equipment generates, uses and can radiate radio frequency energy and, if not installed and used in accordance with manufacturer's instructions, may cause harmful interference to radio communications. However, there is no guarantee that interference will not occur in a particular installation. If this equipment does cause harmful interference to radio or television reception, which can be determined by turning the equipment off and on, the user is encouraged to try to correct the interference by one or more of the following measures:

- Reorient or relocate the receiving antenna.
- Increase the separation between the equipment and receiver.
- Connect the equipment to an outlet on a circuit different from that to which the receiver is connected.
- Consult the dealer or an experienced radio/TV technician for help.



The use of shielded cables for connection of the monitor to the graphics card is required to assure compliance with FCC regulations. Changes or modifications to this unit not expressly approved by the party responsible for compliance could void the user's authority to operate this equipment.

Canadian Department of Communications Statement

This digital apparatus does not exceed the Class B limits for radio noise emissions from digital apparatus set out in the Radio Interference Regulations of the Canadian Department of Communications.

This class B digital apparatus complies with Canadian ICES-003.

Safety information

Electrical safety

- To prevent electrical shock hazard, disconnect the power cable from the electrical outlet before relocating the system.
- When adding or removing devices to or from the system, ensure that the power cables for the devices are unplugged before the signal cables are connected. If possible, disconnect all power cables from the existing system before you add a device.
- Before connecting or removing signal cables from the motherboard, ensure that all power cables are unplugged.
- Seek professional assistance before using an adapter or extension cord. These devices could interrupt the grounding circuit.
- Make sure that your power supply is set to the correct voltage in your area. If you are not sure about the voltage of the electrical outlet you are using, contact your local power company.
- If the power supply is broken, do not try to fix it by yourself. Contact a qualified service technician or your retailer.

Operation safety

- Before installing the motherboard and adding devices on it, carefully read all the manuals that came with the package.
- Before using the product, make sure all cables are correctly connected and the power cables are not damaged. If you detect any damage, contact your dealer immediately.
- To avoid short circuits, keep paper clips, screws, and staples away from connectors, slots, sockets and circuitry.
- Avoid dust, humidity, and temperature extremes. Do not place the product in any area where it may become wet.
- Place the product on a stable surface.
- If you encounter technical problems with the product, contact a qualified service technician or your retailer.

About this guide

This user guide contains the information you need when installing and configuring the motherboard.

How this guide is organized

This manual contains the following parts:

- **Chapter 1: Product introduction**
This chapter describes the features of the motherboard and the new technology it supports. It also lists the hardware setup procedures that you have to perform when installing system components. It includes description of the jumpers and connectors on the motherboard.
- **Chapter 2: BIOS setup**
This chapter tells how to change system settings through the BIOS Setup menus. Detailed descriptions of the BIOS parameters are also provided.
- **Chapter 3: Software support**
This chapter describes the contents of the support CD that comes with the motherboard package.

Where to find more information

Refer to the following sources for additional information and for product and software updates.

1. **ASUS websites**
The ASUS website provides updated information on ASUS hardware and software products. Refer to the ASUS contact information.
2. **Optional documentation**
Your product package may include optional documentation, such as warranty flyers, that may have been added by your dealer. These documents are not part of the standard package.

Conventions used in this guide

To make sure that you perform certain tasks properly, take note of the following symbols used throughout this manual.



DANGER/WARNING: Information to prevent injury to yourself when trying to complete a task.



CAUTION: Information to prevent damage to the components when trying to complete a task.



IMPORTANT: Instructions that you **MUST** follow to complete a task.



NOTE: Tips and additional information to help you complete a task.

Typography

Bold text

Indicates a menu or an item to select.

Italics

Used to emphasize a word or a phrase.

<Key>

Keys enclosed in the less-than and greater-than sign means that you must press the enclosed key.

Example: <Enter> means that you must press the Enter or Return key.

<Key1>+<Key2>+<Key3> If you must press two or more keys simultaneously, the key names are linked with a plus sign (+).

Example: <Ctrl+Alt+D>

Command

Means that you must type the command exactly as shown, then supply the required item or value enclosed in brackets.

Example: At the DOS prompt, type the command line:

```
afudos /i [filename]
```

```
afudos /iP5BVMDA.ROM
```

P5B-VM D0 specifications summary

CPU	LGA775 socket for Intel® Quad-core / Core™2 Extreme/ Core™2 Duo / Pentium® D / Pentium® 4 / Celeron® D processor Compatible with Intel® 05B/05A/06 processors Intel® Hyper-Threading Technology ready * Refer to www.asus.com for Intel CPU support list
Chipset	Intel® Q965 / ICH8DO with Intel® Active Management Technology
System Bus	1066 / 800 / 533 MHz
Memory	4 x DIMM, max. 8GB, DDR2 800 / 667 / 533 MHz, non-ECC, un-buffered memory Dual channel memory architecture * Refer to www.asus.com or user manual for Memory QVL (Qualified Vendors Lists)
Expansion Slots	1 x PCI-E x16 slot 1 x PCI-E x4 slot 2 x PCI slots
VGA	Intel® Graphics Media Accelerator 3000 (Intel® GMA 3000) integrated High Definition Video Processing with max. resolutions to Max resolution to 2048 x 1536 bpp (@75Hz) Max. shared memory of 256MB Support Microsoft® DX 9, OpenGL 1.4, Pixel Shader 2.0
Storage	Southbridge <ul style="list-style-type: none"> - 6 x SATA 3.0 Gb/s ports - Intel® Matrix Storage Technology supports RAID 0, 1, 5, and 10 JMicron® JMB363 PATA and SATA controller <ul style="list-style-type: none"> - 1 x UltraDMA 133/100/66/33 for up to 2 PATA devices - 1 x Internal SATA 3.0 Gb/s port - 1 x External SATA 3.0 Gb/s port (SATA On-the-Go) - Support SATA RAID 0, 1 and JBOD (by 1 x External SATA & 1 x Internal SATA)
LAN	Intel® 82566DM PCI-E Gigabit Ethernet Controller
Audio	ADI® AD 1988 8-channel High Definition Audio CODEC <ul style="list-style-type: none"> - Support Jack-Sensing, Enumeration, Multi-streaming and Jack-Retasking - S/PDIF_OUT interface - ASUS Noise Filter
IEEE 1394	TI® 1394a controller supports 2 x IEEE 1394a ports (one at midboard; one at back panel)

(continued on the next page)

P5B-VM DO specifications summary

USB	10 x USB 2.0 ports (6 ports at mid-board, 4 ports at back panel)
ASUS Features	ASUS Quiet Thermal Solution: <ul style="list-style-type: none"> - ASUS Advanced Q-Fan ASUS Crystal Sound <ul style="list-style-type: none"> - Noise Filter ASUS EZ DIY: <ul style="list-style-type: none"> - ASUS Q-Connector - ASUS CrashFree BIOS 3 - ASUS EZ Flash 2
Other Features	ASUS MyLogo 2 ASUS C.P.R. (CPU Parameter Recall)
Back Panel I/O Ports	1 x PS/2 keyboard port 1 x PS/2 mouse port 1 x Parallel port 1 x External Serial ATA port 1 x VGA port 1 x IEEE 1394a connector 1 x RJ45 port 4 x USB 2.0/1.1 ports 8-channel Audio I/O ports
Internal Connectors	3 x USB 2.0 connectors support additional 6 USB ports 1 x Floppy disk drive connector 1 x IDE connector for two devices 1 x COM connector 1 x TPM connector 7 x Serial ATA connectors 1 x CPU Fan connector 2 x Chassis Fan connectors 1 x Power Fan connector 1 x IEEE1394a connector Front panel audio connector 1 x Azalia Digital Header 1 x S/PDIF Out Header Chassis intrusion connector CD audio in 24-pin ATX Power connector 1 x 4-pin ATX 12 V Power connector System panel connector

(continued on the next page)

P5B-VM DO specifications summary

BIOS Features	16 Mb Flash ROM, AMI BIOS, PnP, DMI 2.0, WfM2.0, SM BIOS 2.3, ACPI 2.0a, ASUS EZ Flash 2, ASUS CrashFree BIOS 3
Manageability	WfM 2.0, DMI 2.0, WOL by PME, WOR by PME, PXE, RPL
Support CD Contents	Drivers ASUS PC Probe II ASUS Update Anti-virus software (OEM version)
Form Factor	uATX form factor: 9.6" x 9.6" (24.4 cm x 24.4 cm)

*Specifications are subject to change without notice.

This chapter describes the motherboard features and the new technologies it supports.

1 Product introduction

1.1 Welcome!

Thank you for buying an ASUS® P5B-VM DO motherboard!

The motherboard delivers a host of new features and latest technologies, making it another standout in the long line of ASUS quality motherboards!

Before you start installing the motherboard, and hardware devices on it, check the items in your package with the list below.

1.2 Package contents

Check your motherboard package for the following items.

Motherboard	ASUS P5B-VM DO
Cables	Serial ATA power and signal cable for 2 devices 1 x Ultra DMA 133/100/66 cable 1 x Floppy disk drive cable
Accessories	I/O shield 1 x ASUS Q-Connector Kit (USB, 1394, system panel; Retail version only)
Application CD	ASUS motherboard support CD
Documentation	User guide



If any of the above items is damaged or missing, contact your retailer.

1.3 Special features

1.3.1 Product highlights

Green ASUS



This motherboard and its packaging comply with the European Union's Restriction on the use of Hazardous Substances (RoHS). This is in line with the ASUS vision of creating environment-friendly and recyclable products/packaging to safeguard consumers' health while minimizing the impact on the environment.

Intel® Core™2 Processor Ready



This motherboard supports the latest Intel® Core™2 processor in the LGA775 package. With the new Intel® Core™ microarchitecture technology and 1066/800/533 MHz FSB, Intel® Core™2 processor is one of the most powerful and energy efficient CPU in the world.

Intel® Q965 Express Chipset



The Intel® Q965 Express Chipset provides all business with more effective costs management, safer computing environment, and deploys more responsive PCs. It features the integrated graphics engine, Intel® Graphics Media Accelerator 3000, and Intel® Active Management Technology, both of which provide advancements in manageability, graphics, stability, data protection, and optimizations to support the most advanced business operating systems.

Intel® vPro™ Technology



The Intel® vPro™ Technology allows IT organizations to remotely manage corporate PCs, even when they are powered off or with non-functional operating systems. It features the Intel® Active Management Technology and offers IT organizations a lighter-weight form of virtualization to audit all Intel® AMT-based platforms in a network environment. PCs with Intel® vPro™ Technology allow IT departments to remotely retrieve assets and hardware/software inventories, contain security threats, resolve system problems, and increase the uptime of desktops with lower maintenance costs. To enable the Intel® vPro™ Technology, first enable the related vPro™ Technology settings. See page 2-26 for details.

DDR2 memory support



The motherboard supports DDR2 memory that features data transfer rates of 800/667/533 MHz to meet the higher bandwidth requirements of the latest 3D graphics, multimedia, and Internet applications. The dual-channel DDR2 architecture doubles the bandwidth of your system memory to boost system performance, eliminating bottlenecks with peak bandwidths of up to 12.8 GB/s. Without restriction to the memory size across the two channels, the motherboard allows you to install DIMMs with different memory size and enjoy dual-channel feature at the same time. See page 1-18 for details.

Serial ATA 3.0 Gb/s technology and SATA on the go



This motherboard supports the next-generation hard drives based on the Serial ATA (SATA) 3Gb/s storage specification, delivering enhanced scalability and doubling the bus bandwidth for high-speed data retrieval and saves. The external SATA port located at the back I/O provides smart setup and hot-plug functions. Easily backup photos, videos and other entertainment contents to external devices. See page 1-30 and 1-34 for details.

IEEE 1394a support



The IEEE 1394a interface provides high speed digital interface for audio/video appliances such as digital television, digital video camcorders, storage peripherals & other PC portable devices. See page 1-30 and 1-34 for details.

Dual RAID solution

The Intel® ICH8DO chipset incorporates six Serial ATA connectors with high performance RAID 0, 1, 5 and 10 functions. The JMicron controller provides another two Serial ATA connectors for RAID 0, 1, and JBOD functions. Making this motherboard an ideal solution to enhance hard disk performance and data back up protection without the cost of add-on cards. See page 1-34 and 1-35 for details.

S/PDIF digital sound ready

The motherboard supports the S/PDIF-out (SONY-PHILIPS Digital Interface) function through the S/PDIF interface at mid-board. It allows to transfer digital audio without converting to analog format and keeps the best signal quality. See pages 1-32 for details.

High Definition Audio

Enjoy high-end sound quality on your PC! The onboard 8-channel HD audio (High Definition Audio, previously codenamed Azalia) CODEC enables high-quality 192KHz/24-bit audio output, jack-sensing feature, retasking functions and multi-streaming technology that simultaneously sends different audio streams to different destinations. You can now talk to your partners on the headphone while playing multi-channel network games. See page 1-38 for details.

1.3.2 ASUS Features

ASUS Quiet Thermal Solution

ASUS Quiet Thermal solution makes system more stable and enhances the overclocking capability.

ASUS Advanced Q-Fan

The ASUS advanced Q-Fan technology on P5B Series is powered by Intel Quiet System Technology; It makes the change of fan speed more smoothly. It's better in fan use, and efficiently reduces the noise caused by fans' abruptly speeding up. Moreover, Advanced Q-Fan has a better control over a constant temperature system environment. See page 2-32 for details.

ASUS Crystal Sound

This feature can enhance speech-centric applications like Skype, online game, video conference and recording.

Noise Filter

This feature detects repetitive and stationary noises (non-voice signals) like computer fans, air conditioners, and other background noises then eliminates it in the incoming audio stream while recording.

ASUS EZ DIY

ASUS EZ DIY feature collection provides you easy ways to install computer components, update the BIOS or back up your favorite settings.

ASUS Q-Connector



ASUS Q-Connector allows you to easily connect or disconnect the chassis front panel cables to the motherboard. This unique module eliminates the trouble of connecting the system panel cables one at a time and avoiding wrong cable connections. See page 1-41 for details.

ASUS CrashFree BIOS 3



The ASUS CrashFree BIOS 3 allows users to restore corrupted BIOS data from a USB flash disk containing the BIOS file. See page 2-6 for details.

ASUS EZ Flash 2



EZ Flash 2 is a user-friendly BIOS update utility. Simply press the predefined hotkey to launch the utility and update the BIOS without entering the OS. Update your BIOS easily without preparing a bootable diskette or using an OS-based flash utility. See page 2-3 for details.

1.3.3 ASUS Special Features

ASUS MyLogo2™



This feature allows you to convert your favorite photo into a 256-color boot logo for a more colorful and vivid image on your screen. See page 2-34 for details.

1.3.4 ASUS Intelligent Overclocking Features

C.P.R. (CPU Parameter Recall)



The C.P.R. feature of the motherboard BIOS allows automatic re-setting to the BIOS default settings in case the system hangs due to overclocking. When the system hangs due to overclocking, C.P.R. eliminates the need to open the system chassis and clear the RTC data. Simply shut down and reboot the system, and the BIOS automatically restores the CPU default setting for each parameter.



Due to chipset behavior, AC power off is required prior to using C.P.R. function.

1.4 Before you proceed

Take note of the following precautions before you install motherboard components or change any motherboard settings.



- Unplug the power cord from the wall socket before touching any component.
- Use a grounded wrist strap or touch a safely grounded object or a metal object, such as the power supply case, before handling components to avoid damaging them due to static electricity.
- Hold components by the edges to avoid touching the ICs on them.
- Whenever you uninstall any component, place it on a grounded antistatic pad or in the bag that came with the component.
- Before you install or remove any component, ensure that the ATX power supply is switched off or the power cord is detached from the power supply. Failure to do so may cause severe damage to the motherboard, peripherals, and/or components.

Onboard LED

The motherboard comes with a standby power LED that lights up to indicate that the system is ON, in sleep mode, or in soft-off mode. This is a reminder that you should shut down the system and unplug the power cable before removing or plugging in any motherboard component. The illustration below shows the location of the onboard LED.

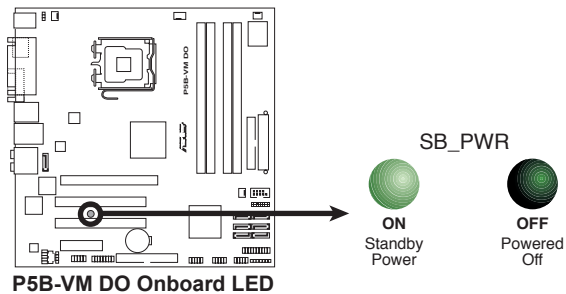

1.5 Motherboard overview

Before you install the motherboard, study the configuration of your chassis to ensure that the motherboard fits into it.



Make sure to unplug the power cord before installing or removing the motherboard. Failure to do so can cause you physical injury and damage motherboard components.

1.5.1 Placement direction

When installing the motherboard, make sure that you place it into the chassis in the correct orientation. The edge with external ports goes to the rear part of the chassis as indicated in the image below.

1.5.2 Screw holes

Place eight (8) screws into the holes indicated by circles to secure the motherboard to the chassis.



Do not overtighten the screws! Doing so can damage the motherboard.

Place this side towards the rear of the chassis

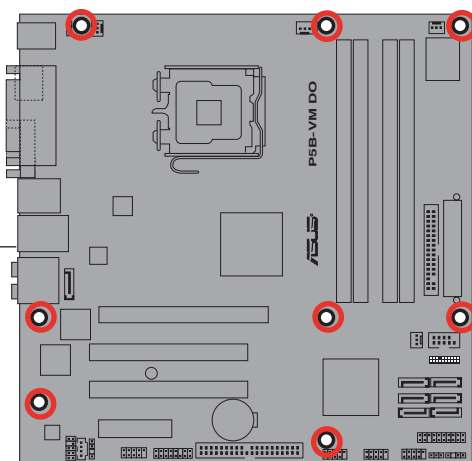

1.5.3 Motherboard layout

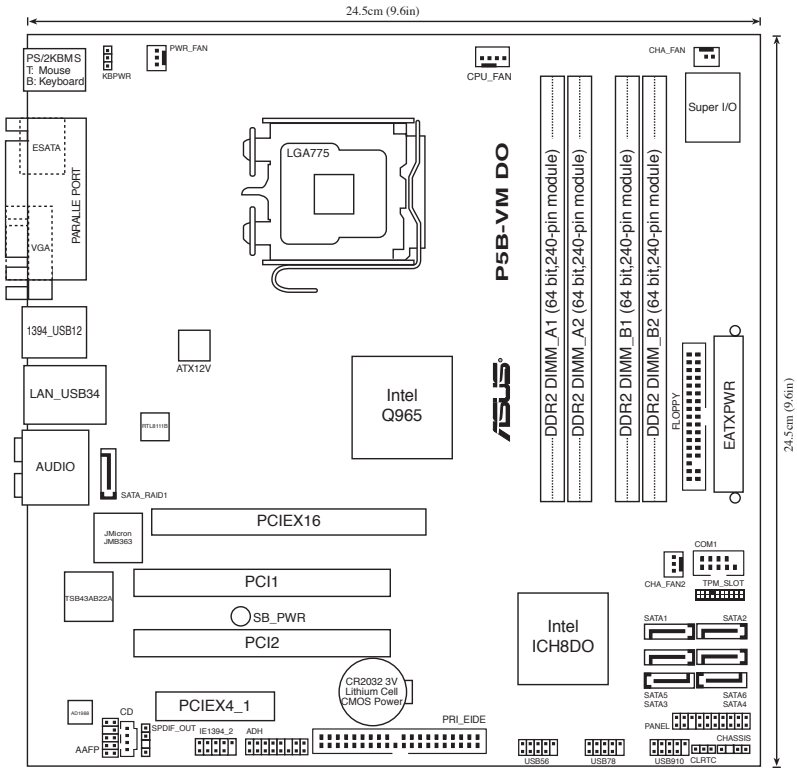

Refer to **1.10 Connectors** for more information about rear panel connectors and internal connectors.

1.5.4 Layout contents

Slots		Page
1.	DDR2 DIMM slots	1-18
2.	PCI slots	1-27
3.	PCI Express x 4 slot	1-27
4.	PCI Express x16 slot	1-27

Jumper		Page
1.	Clear RTC RAM (3-pin CLRTC)	1-28
2.	Keyboard power (3-pin KBPWR)	1-29

Rear panel connectors		Page
1.	PS/2 mouse port (green)	1-30
2.	Parallel port	1-30
3.	IEEE 1394a port	1-30
4.	LAN (RJ-45) port	1-30
5.	Rear Speaker Out port (black)	1-30
6.	Center/Subwoofer port (orange)	1-30
7.	Line In port (light blue)	1-30
8.	Line Out port (lime)	1-30
9.	Microphone port (pink)	1-30
10.	Side Speaker Out port (gray)	1-30
11.	USB 2.0 ports 1 and 2	1-31
12.	USB 2.0 ports 3 and 4	1-31
13.	VGA port	1-31
14.	External SATA port	1-31
15.	PS/2 keyboard port (purple)	1-31

Internal connectors		Page
1.	Floppy disk drive connector (34-1 pin FLOPPY)	1-32
2.	Digital Audio connector (4-1 pin SPDIF_OUT)	1-32
3.	IDE connector (40-1 pin PRI_IDE)	1-33
4.	ICH8DO Serial ATA connectors (7-pin SATA1 [red], SATA2 [red], SATA3 [red], SATA4 [red], SATA5 [black], SATA6 [black])	1-34
5.	IEEE 1394a port connector (10-1 pin IE1394_2)	1-34
6.	JMicron® JMB363 Serial ATA RAID connector (7-pin SATA_RAID1)	1-35
7.	TPM connector (20-1 pin TPM_SLOT)	1-35
8.	USB connectors (10-1 pin USB56, USB 78, USB910)	1-36
9.	Optical drive audio connector (4-pin CD)	1-36
10.	CPU, chassis, and power fan connectors (4-pin CPU_FAN, 3-pin CHA_FAN, 3-pin CHA_FAN2, 3-pin PWR_FAN)	1-37
11.	Serial port connector (10-1 pin COM1)	1-37
12.	Chassis intrusion connector (4-1 pin CHASSIS)	1-38
13.	Front panel audio connector (10-1 pin AAFP)	1-38
14.	ATX power connectors (24-pin EATXPWR, 4-pin EATX12V)	1-39
15.	System panel connector (20-8-pin PANEL) <ul style="list-style-type: none"> • System power LED (2-pin PLED) • Hard disk drive activity LED (2-pin IDE_LED) • System warning speaker (4-pin SPEAKER) • ATX power button/soft-off button (2-pin PWRSW) • Reset button (2-pin RESET) 	1-40

1.6 Central Processing Unit (CPU)

The motherboard comes with a surface mount LGA775 socket designed for the Intel® Core™2 Extreme/Core™2 Duo/Pentium® D/Pentium® 4 and Celeron® D processors.



-
- Make sure the AC power is off before you install the CPU.
 - If installing a dual-core CPU, connect the chassis fan cable to the CHA_FAN connector to ensure system stability.
-



-
- Upon purchase of the motherboard, make sure that the PnP cap is on the socket and the socket contacts are not bent. Contact your retailer immediately if the PnP cap is missing, or if you see any damage to the PnP cap/socket contacts/motherboard components. ASUS will shoulder the cost of repair only if the damage is shipment/transit-related.
 - Keep the cap after installing the motherboard. ASUS will process Return Merchandise Authorization (RMA) requests only if the motherboard comes with the cap on the LGA775 socket.
 - The product warranty does not cover damage to the socket contacts resulting from incorrect CPU installation/removal, or misplacement/loss/incorrect removal of the PnP cap.
-

1.6.1 Installing the CPU

To install a CPU:

1. Locate the CPU socket on the motherboard.

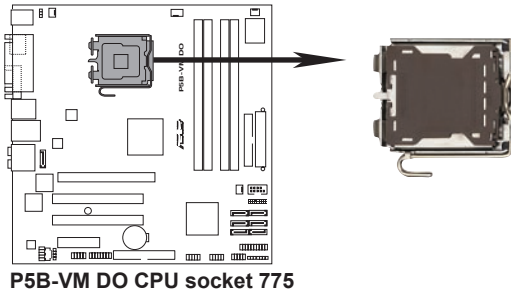

Before installing the CPU, make sure that the cam box is facing towards you and the load lever is on your left.

2. Press the load lever with your thumb (A), then move it to the left (B) until it is released from the retention tab.

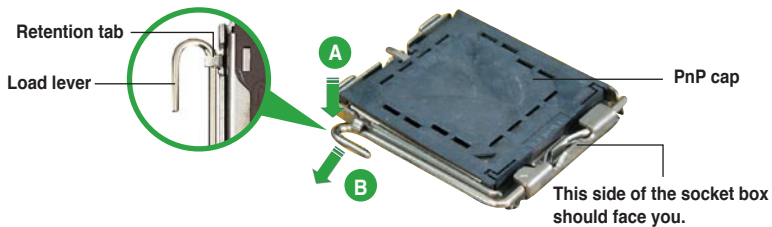

To prevent damage to the socket pins, do not remove the PnP cap unless you are installing a CPU.

3. Lift the load lever in the direction of the arrow to a 135° angle.

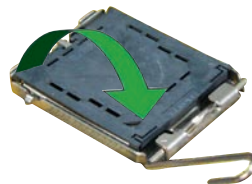

- Lift the load plate with your thumb and forefinger to a 100° angle (A), then push the PnP cap from the load plate window to remove (B).

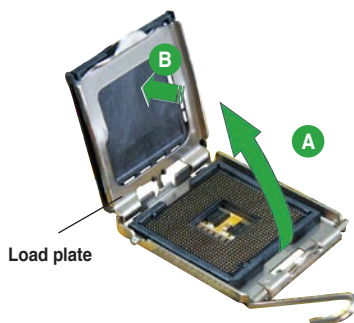

- Position the CPU over the socket, making sure that the gold triangle is on the bottom-left corner of the socket then fit the socket alignment key into the CPU notch.

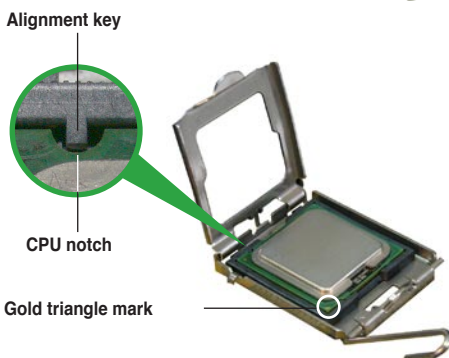

The CPU fits in only one correct orientation. DO NOT force the CPU into the socket to prevent bending the connectors on the socket and damaging the CPU!

- Close the load plate (A), then push the load lever (B) until it snaps into the retention tab.
- If installing a dual-core CPU, connect the chassis fan cable to the CHA_FAN1 connector to ensure system stability.



The motherboard supports Intel® LGA775 processors with the Intel® Enhanced Memory 64 Technology (EM64T), Enhanced Intel SpeedStep® Technology (EIST), and Hyper-Threading Technology.

1.6.2 Installing the CPU heatsink and fan

The Intel® LGA775 processor requires a specially designed heatsink and fan assembly to ensure optimum thermal condition and performance.



- When you buy a boxed Intel® processor, the package includes the CPU fan and heatsink assembly. If you buy a CPU separately, make sure that you use only Intel®-certified multi-directional heatsink and fan.
- Your Intel® LGA775 heatsink and fan assembly comes in a push-pin design and requires no tool to install.
- If you purchased a separate CPU heatsink and fan assembly, make sure that you have properly applied Thermal Interface Material to the CPU heatsink or CPU before you install the heatsink and fan assembly.



Make sure that you have installed the motherboard to the chassis before you install the CPU fan and heatsink assembly.

To install the CPU heatsink and fan:

1. Place the heatsink on top of the installed CPU, making sure that the four fasteners match the holes on the motherboard.



Orient the heatsink and fan assembly such that the CPU fan cable is closest to the CPU fan connector.



Motherboard hole

Fastener

Narrow end
of the groove



Make sure to orient each fastener with the narrow end of the groove pointing outward. (The photo shows the groove shaded for emphasis.)

2. Push down two fasteners at a time in a diagonal sequence to secure the heatsink and fan assembly in place.

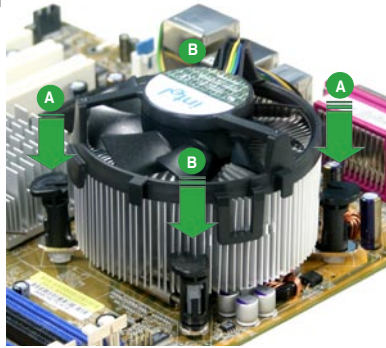
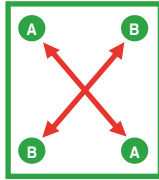

3. Connect the CPU fan cable to the connector on the motherboard labeled CPU_FAN.

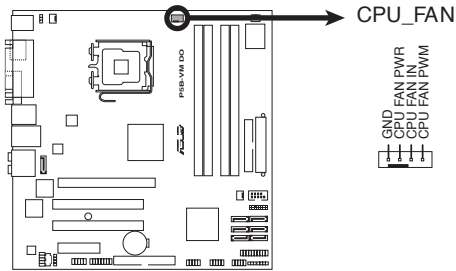

P5B-VM DO CPU Fan Connector



Do not forget to connect the CPU fan connector! Hardware monitoring errors can occur if you fail to plug this connector.

1.6.3 Uninstalling the CPU heatsink and fan

To uninstall the CPU heatsink and fan:

1. Disconnect the CPU fan cable from the connector on the motherboard.
2. Rotate each fastener counterclockwise.



3. Pull up two fasteners at a time in a diagonal sequence to disengage the heatsink and fan assembly from the motherboard.

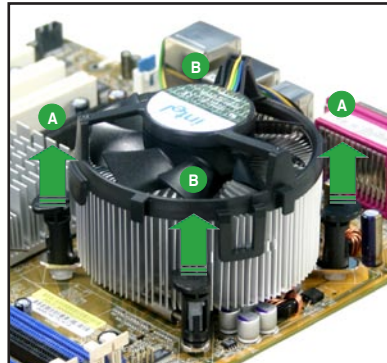
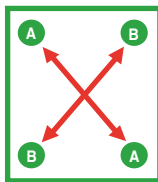

4. Carefully remove the heatsink and fan assembly from the motherboard.

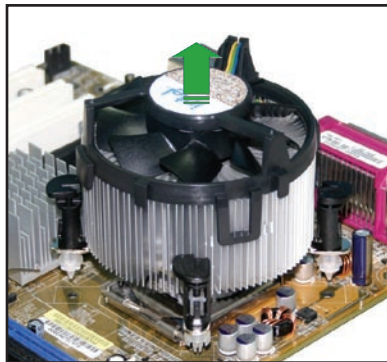

5. Rotate each fastener clockwise to ensure correct orientation when reinstalling.

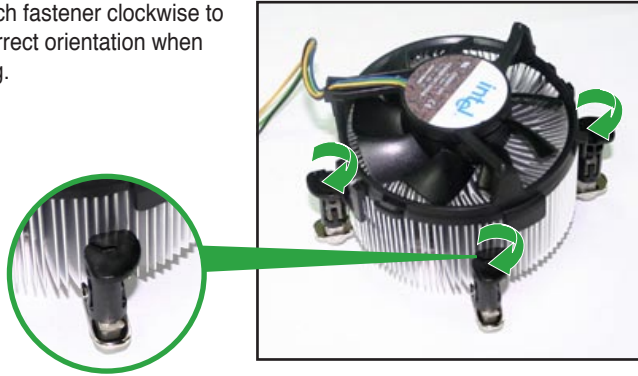

Narrow end of the groove



The narrow end of the groove should point outward after resetting. (The photo shows the groove shaded for emphasis.)

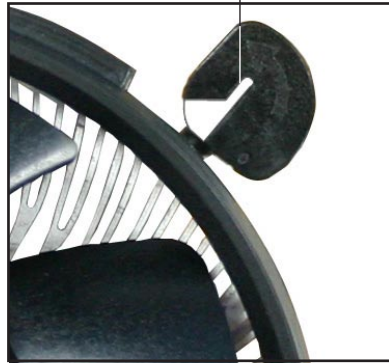

Refer to the documentation in the boxed or stand-alone CPU fan package for detailed information on CPU fan installation.

1.7 System memory

1.7.1 Overview

The motherboard comes with four Double Data Rate 2 (DDR2) Dual Inline Memory Modules (DIMM) sockets.

A DDR2 module has the same physical dimensions as a DDR DIMM but has a 240-pin footprint compared to the 184-pin DDR DIMM. DDR2 DIMMs are notched differently to prevent installation on a DDR DIMM socket.

The figure illustrates the location of the DDR2 DIMM sockets:

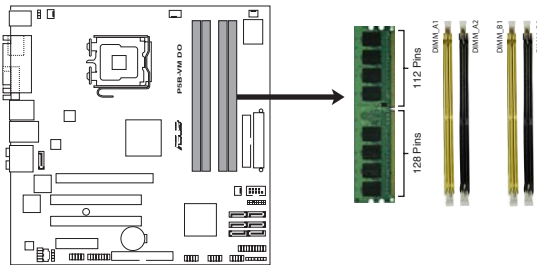

P5B-VM DO 240-pin DDR2 DIMM socket

Channel	Sockets
Channel A	DIMM_A1 and DIMM_A2
Channel B	DIMM_B1 and DIMM_B2



Install at least a memory module in DIMM_A1 or DIMM_A2 slot to support the Intel® Quiet System Technology and for optimum performance. Otherwise, system will halt.

1.7.2 Memory configurations

You may install 256 MB, 512 MB, 1 GB, and 2 GB unbuffered non-ECC DDR2 DIMMs into the DIMM sockets.



-
- You may install varying memory sizes in Channel A and Channel B. The system maps the total size of the lower-sized channel for the dual-channel configuration. Any excess memory from the higher-sized channel is then mapped for single-channel operation.
 - Always install DIMMs with the same CAS latency. For optimum compatibility, it is recommended that you obtain memory modules from the same vendor.
 - If you install four 1 or 2GB memory modules, the system may only recognize less than 3GB because the address space is reserved for other critical functions. This limitation appears on Windows® XP 32-bit operation system which does not support Physical Address Extension (PAE).
 - If you install Windows® XP 32-bit operation system, a total memory of less than 3GB is recommended.
 - This motherboard does not support memory modules made up of 128 Mb chips or double sided x16 memory modules.
-



Notes on memory limitations

- Due to chipset limitation, this motherboard can only support up to 8 GB on the operating systems listed below. You may install a maximum of 2 GB DIMMs on each slot, but only DDR2-533 and DDR2-667 2 GB density modules are available for this configuration.

32-bit	64-bit
Windows 2000 Advanced Server	Windows XP Professional x64 Edition

- Some old-version DDR2-800/667 DIMMs may not match Intel®'s On-Die-Termination (ODT) requirement and will automatically downgrade to run at DDR2-533. If this happens, contact your memory vendor to check the ODT value.
 - Due to chipset limitation, DDR2-800 with CL=4 will be downgraded to run at DDR2-667 by default setting. If you want to operate with lower latency, adjust the memory timing manually.
 - Due to chipset limitation, DDR2-667 with CL=3 will be downgraded to run at DDR2-533 by default setting. If you want to operate with lower latency, adjust the memory timing manually.
 - The total memory may have 8MB reduction under Single Channel mode, and 16MB reduction under Dual Channel mode because the address space is reserved for the Intel® vPro™ Technology and the Intel® Quiet System Technology.
-

P5B-VM DO Motherboard Qualified Vendors Lists (QVL)

DDR2-800MHz capability

Size	Vendor	Chip No.	SS/ DS	Part No.	DIMM support		
					A	B	C
512MB	KINGSTON	K4T51083QC	SS	KVR800D2N5/512	*	*	*
1024MB	KINGSTON	K4T51083QC	DS	KVR800D2N5/1G	*	*	*
1024MB	KINGSTON	Heat-Sink Package	DS	KHX6400D2LL/1G	*		
1024MB	KINGSTON	Heat-Sink Package	SS	KHX6400D2LLK2/1GN	*	*	*
2048MB	KINGSTON	Heat-Sink Package	DS	KHX6400D2K2/2G	*	*	*
512MB	Qimonda	HYB18T256800AF25F	DS	HYS64T64020HU-25F-A	*	*	*
256MB	Qimonda	HYB18T512160BF-25F	SS	HYS64T32000HU-25F-B	*	*	*
512MB	Qimonda	HYB18T512800BF25F	SS	HYS64T64000HU-25F-B	*	*	*
1024MB	Qimonda	HYB18T512800BF25F	DS	HYS64T128020HU-25F-B	*	*	*
512MB	SAMSUNG	EDD339XX	SS	M378T6553CZ3-CE7	*	*	*
256MB	SAMSUNG	K4T51163QC-ZCE7	SS	M378T3354CZ3-CE7	*	*	*
512MB	SAMSUNG	ZCE7K4T51083QC	SS	M378T6553CZ3-CE7	*	*	*
1024MB	SAMSUNG	ZCE7K4T51083QC	DS	M378T2953CZ3-CE7	*	*	*
512MB	Hynix	HY5PS12821BFP-S5	SS	HYMP564U64BP8-S5	*	*	*
1024MB	Hynix	HY5PS12821BFP-S5	DS	HYMP512U64BP8-S5	*	*	
512MB	MICRON	5JAIIZ9DQQ	SS	MT8HTF6464AY-80EA3	*	*	*
1024MB	MICRON	5JAIIZ9DQQ	DS	MT16HTF12864AY-80EA3	*	*	*
512MB	MICRON	5ZD22D9GKX	SS	MT8HTF6464AY-80ED4	*	*	*
1024MB	MICRON	5ZD22D9GKX	DS	MT16HTF12864AY-80ED4	*	*	
512MB	MICRON	6CD22D9GKX	SS	MT8HTF6464AY-80ED4	*	*	*
1024MB	MICRON	6CD22D9GKX	DS	MT16HTF12864AY-80ED4	*	*	*
1024MB	CORSAIR	Heat-Sink Package	DS	CM2X1024-6400C4	*	*	*
1024MB	ELPIDA	E1108AB-8E-E(ECC)	SS	EBE10EE8ABFA-8E-E	*	*	*
2048MB	ELPIDA	E1108AB-8E-E(ECC)	DS	EBE21EE8ABFA-8E-E	*		
512MB	A-DATA	N/A	SS	M20AD6G3H3160J1E52	*	*	*
512MB	A-DATA	AD29608A8A-25EG	SS	M20AD6G3H3160I1E5E	*	*	
512MB	Crucial	Heat-Sink Package	SS	BL6464AA804.8FD	*	*	*
1024MB	Crucial	Heat-Sink Package	DS	BL12864AA804.16FD	*	*	*
512MB	Apacer	Heat-Sink Package	SS	AHU512E800C5K1C	*	*	*
1024MB	Apacer	Heat-Sink Package	DS	AHU01GE800C5K1C	*	*	*
512MB	Transcend	K4T51083QC	SS	TS64MLQ64V8J	*	*	*

P5B-VM DO Motherboard Qualified Vendors Lists (QVL)

DDR2-667MHz capability

Size	Vendor	Chip No.	SS/ DS	Part No.	DIMM support		
					A	B	C
512MB	KINGSTON	E5108AE-6E-E	SS	KVR667D2N5/512	*	*	*
1024MB	KINGSTON	E5108AE-6E-E	DS	KVR667D2N5/1G	*	*	*
512MB	KINGSTON	E5108AE-6E-E	SS	KVR667D2E5/512	*	*	*
256MB	KINGSTON	HYB18T256800AF3	SS	KVR667D2N5/256	*	*	*
512MB	KINGSTON	D6408TEBGGGL3U	SS	KVR667D2N5/512	*	*	*
1024MB	KINGSTON	D6408TEBGGGL3U	DS	KVR667D2N5/1G	*	*	*
256MB	KINGSTON	HYB18T256800AF3S	SS	KVR667D2N5/256	*	*	*
256MB	Qimonda	HYB18T512160AF-3S	SS	HYS64T32000HU-3S-A	*	*	*
512MB	Qimonda	HYB18T512800AF3S	SS	HYS64T64000HU-3S-A	*	*	*
256MB	Qimonda	HYB18T256800AF3S(ECC)	SS	HYS72T32000HU-3S-A	*	*	*
512MB	Qimonda	HYB18T512800AF3S(ECC)	SS	HYS72T64000HU-3S-A	*	*	*
1024MB	Qimonda	HYB18T512800AF3S(ECC)	DS	HYS72T128020HU-3S-A	*	*	*
512MB	Qimonda	HYB18T512800BF3S(ECC)	SS	HYS72T64000HU-3S-B	*	*	*
1024MB	Qimonda	HYB18T512800BF3S(ECC)	DS	HYS72T128020HU-3S-B	*	*	*
256MB	Qimonda	HYB18T512160BF-3S	SS	HYS64T32000HU-3S-B	*	*	*
512MB	Qimonda	HYB18T512800BF3S	SS	HYS64T64000HU-3S-B	*	*	*
1024MB	Qimonda	HYB18T512800BF3S	DS	HYS64T128020HU-3S-B	*	*	*
256MB	SAMSUNG	K4T51163QC-ZCE6	SS	M378T3354CZ0-CE6	*	*	*
512MB	SAMSUNG	ZCE6K4T51083QC	SS	M378T6553CZ0-CE6	*	*	*
1024MB	SAMSUNG	ZCE6K4T51083QC	DS	M378T2953CZ0-CE6	*	*	*
1024MB	SAMSUNG	ZCE6K4T51083QC	DS	M378T2953CZ3-CE6	*	*	*
512MB	Hynix	HY5PS12821AFP-Y5	SS	HYMP564U64AP8-Y5	*	*	*
1024MB	Hynix	HY5PS1G831FP-Y5(ECC)	SS	HYMP112U72P8-Y5	*	*	*
512MB	Hynix	HY5PS12821AFP-Y5(ECC)	SS	HYMP564U72AP8-Y5	*	*	*
1024MB	Hynix	HY5PS12821AFP-Y5(ECC)	DS	HYMP512U72AP8-Y5	*	*	*
512MB	Hynix	HY5PS12821AFP-Y4	SS	HYMP564U64AP8-Y4	*	*	*
512MB	Hynix	HY5PS12821AFP-Y4(ECC)	SS	HYMP564U72AP8-Y4	*	*	*
256MB	CORSAIR	M1100605	SS	VS256MB667D2	*	*	*
512MB	CORSAIR	64M8CFEG	SS	VS512MB667D2	*	*	*
1024MB	CORSAIR	64M8CFEG	DS	VS1GB667D2	*	*	*
256MB	ELPIDA	E2508AB-6E-E	SS	EBE25UC8ABFA-6E-E	*	*	*
512MB	ELPIDA	E5108AE-6E-E	SS	EBE51UD8AEFA-6E-E	*	*	*
512MB	A-DATA	AD29608A8A-3EG	SS	M20AD5G3H31661C52	*	*	*
1024MB	A-DATA	AD29608A8A-3EG	DS	M20AD5G3I41761C52	*	*	*
1024MB	crucial	Heat-Sink Package	DS	BL12864AA663.16FD	*	*	*
1024MB	crucial	Heat-Sink Package	DS	BL12864AL664.16FD	*	*	*
512MB	Apacer	AM4B5708GQJS7E	SS	AU512E667C5KBGC	*	*	*
1024MB	Apacer	AM4B5708GQJS7E	DS	AU01GE667C5KBGC	*	*	*
512MB	Apacer	AM4B5708PJS7E	SS	AU512E667C5KBGC	*	*	*
512MB	Apacer	AM4B5708GQJS7E	SS	AU512E667C5KBGC	*	*	*
1024MB	Apacer	N/A	DS	AU01GE667C5KBGC	*	*	*
512MB	Kingmax	KKEA88B4LAUG-29DX	SS	KLCC28F-A8KB5	*	*	*
1024MB	Kingmax	KKEA88B4LAUG-29DX	DS	KLCD48F-A8KB5	*	*	*
512MB	Transcend	E5108AE-6E-E	SS	TS84MLQ64V6J	*	*	*
1024MB	Transcend	E5108AE-6E-E	DS	TS128MLQ64V6J	*	*	*
512MB	Transcend	J12Q3AB-6	SS	JM367Q643A-6	*	*	*
1024MB	Transcend	J12Q3AB-6	DS	JM388Q643A-6	*	*	*

P5B-VM DO Motherboard Qualified Vendors Lists (QVL)

DDR2-553 MHz capability

Size	Vendor	Chip No.	SS/ DS	Part No.	DIMM support		
					A	B	C
256MB	KINGSTON	E5116AF-5C-E	SS	KVR533D2N4/256	*	*	*
512MB	KINGSTON	HYB18T512800AF37	SS	KVR533D2N4/512	*	*	*
1024MB	KINGSTON	5YDID9GCT	DS	KVR533D2N4/1G	*	*	*
256MB	Qimonda	HYB18T512160AF-3.7	SS	HYS64T32000HU-3.7-A	*	*	*
512MB	Qimonda	HYB18T512800AF37	SS	HYS64T64000HU-3.7-A	*	*	*
1024MB	Qimonda	HYB18T512800AF37	DS	HYS64T128020HU-3.7-A	*	*	*
256MB	Qimonda	HYB18T512160BF-3.7	SS	HYS64T32000HU-3.7-B	*	*	*
512MB	Qimonda	HYB18T512800BF37	SS	HYS64T64000HU-3.7-B	*	*	*
1024MB	Qimonda	HYB18T512800BF37	DS	HYS64T128020HU-3.7-B	*	*	*
256MB	Qimonda	HYB18T256800AF37(ECC)	SS	HYS72T32000HU-3.7-A	*	*	*
1024MB	Qimonda	HYB18T512800AF37(ECC)	DS	HYS72T128020HU-3.7-A	*	*	*
512MB	SAMSUNG	ZCD5K4T51083QC	SS	M378T6553CZ3-CD5	*	*	*
1024MB	SAMSUNG	ZCD5K4T51083QC	DS	M378T2953CZ3-CD5	*	*	*
512MB	Hynix	HY5PS12821F-C4	SS	HYMP564U648-C4	*	*	*
1024MB	Hynix	HY5PS12821F-C4	DS	HYMP512U648-C4	*	*	*
1024MB	Hynix	HY5PS12821F-C4(ECC)	DS	HYMP512U728-C4	*	*	*
512MB	Hynix	HY5PS12821FP-C4(ECC)	SS	HYMP564U728-C4	*	*	*
512MB	Hynix	HY5PS12821AFP-C3	SS	HYMP564U64AP8-C3	*	*	*
1024MB	Hynix	HY5PS12821AFP-C3	DS	HYMP512U64AP8-C3	*	*	*
1024MB	CORSAIR	64M8CEDG	DS	VS1GB533D2	*	*	*
512MB	ELPIDA	E5108AB-5C-E	SS	EBE51UD8ABFA-5C-E	*	*	*
512MB	KINGMAX	E5108AE-5C-E	SS	KLBC28F-A8EB4	*	*	*
1024MB	KINGMAX	E5108AE-5C-E	DS	KLBD48F-A8EB4	*	*	*
512MB	KINGMAX	KKEA88E4AAK-37	SS	KLBC28F-A8KE4	*	*	*
1024MB	KINGMAX	5MB22D9DCN	DS	KLBD48F-A8ME4	*	*	*

SS - Single-sided DS - Double-sided

DIMM support:

- A - Supports one module inserted into either slot in Single-channel memory configuration.
- B - Supports one pair of modules inserted into either the yellow slots or the black slots as one pair of Dual-channel memory configuration.
- C - Supports four modules inserted into both the yellow and black slots as two pairs of Dual-channel memory configuration.



Visit the ASUS website for the latest DDR2-800/667/533 MHz QVL.

1.7.3 Installing a DIMM



Unplug the power supply before adding or removing DIMMs or other system components. Failure to do so can cause severe damage to both the motherboard and the components.

To install a DIMM:

1. Unlock a DIMM socket by pressing the retaining clips outward.
2. Align a DIMM on the socket such that the notch on the DIMM matches the break on the socket.
3. Firmly insert the DIMM into the socket until the retaining clips snap back in place and the DIMM is properly seated.

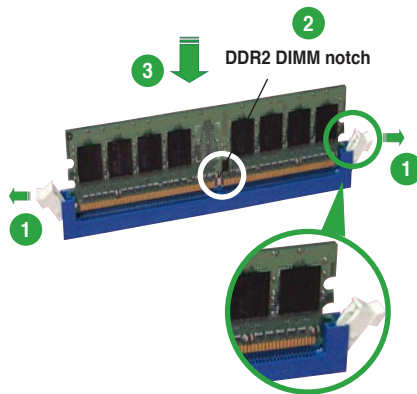

Unlocked retaining clip



- A DDR2 DIMM is keyed with a notch so that it fits in only one direction. Do not force a DIMM into a socket to avoid damaging the DIMM.
- The DDR2 DIMM sockets do not support DDR DIMMs. Do not install DDR DIMMs to the DDR2 DIMM sockets.

1.7.4 Removing a DIMM

To remove a DIMM:

1. Simultaneously press the retaining clips outward to unlock the DIMM.



Support the DIMM lightly with your fingers when pressing the retaining clips. The DIMM might get damaged when it flips out with extra force.

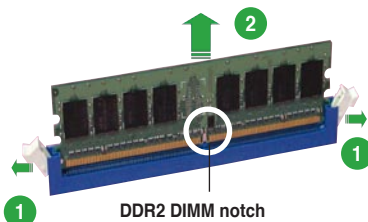

2. Remove the DIMM from the socket.

1.8 Expansion slots

In the future, you may need to install expansion cards. The following sub-sections describe the slots and the expansion cards that they support.



Make sure to unplug the power cord before adding or removing expansion cards. Failure to do so may cause you physical injury and damage motherboard components.

1.8.1 Installing an expansion card

To install an expansion card:

1. Before installing the expansion card, read the documentation that came with it and make the necessary hardware settings for the card.
2. Remove the system unit cover (if your motherboard is already installed in a chassis).
3. Remove the bracket opposite the slot that you intend to use. Keep the screw for later use.
4. Align the card connector with the slot and press firmly until the card is completely seated on the slot.
5. Secure the card to the chassis with the screw you removed earlier.
6. Replace the system cover.

1.8.2 Configuring an expansion card

After installing the expansion card, configure it by adjusting the software settings.

1. Turn on the system and change the necessary BIOS settings, if any. See Chapter 2 for information on BIOS setup.
2. Assign an IRQ to the card. Refer to the tables on the next page.
3. Install the software drivers for the expansion card.



When using PCI cards on shared slots, ensure that the drivers support “Share IRQ” or that the cards do not need IRQ assignments. Otherwise, conflicts will arise between the two PCI groups, making the system unstable and the card inoperable. Refer to the table on the next page for details.

1.8.3 Interrupt assignments

Standard interrupt assignments

IRQ	Priority	Standard function
0	1	System Timer
1	2	Keyboard Controller
2	–	Redirect to IRQ#9
3	11	IRQ holder for PCI steering*
4	12	Communications Port (COM1)*
5	13	IRQ holder for PCI steering*
6	14	Floppy Disk Controller
7	15	Printer Port (LPT1)*
8	3	System CMOS/Real Time Clock
9	4	IRQ holder for PCI steering*
10	5	IRQ holder for PCI steering*
11	6	IRQ holder for PCI steering*
12	7	PS/2 Compatible Mouse Port*
13	8	Numeric Data Processor
14	9	Primary IDE Channel
15	10	Secondary IDE Channel

* These IRQs are usually available for ISA or PCI devices.

IRQ assignments for this motherboard

	A	B	C	D	E	F	G	H
PCI Slot 1	shared	—	—	—	—	—	—	—
PCI Slot 2	—	shared	—	—	—	—	—	—
PCIe x 16_1	shared	—	—	—	—	—	—	—
PCIe x 4_1	shared	—	—	—	—	—	—	—
Onboard ESATA, SATA_RAID	shared	—	—	—	—	shared	—	—
Onboard PRI_IDE	shared	—	—	—	—	—	—	—
Onboard HD Audio (AD1988)	—	—	—	—	—	—	shared	—
Onboard GbEthernet (82566DM)	—	shared	—	—	—	—	—	—
USB 2.0 EHCI#1	—	—	—	—	—	—	—	shared
USB 2.0 EHCI#2	—	—	—	—	—	—	shared	—
USB12 UHCI#1	—	—	—	—	—	—	—	shared
USB34 UHCI#2	—	—	—	shared	—	—	—	—
USB56 UHCI#3	—	—	shared	—	—	—	—	—
USB78 UHCI#4	shared	—	—	—	—	—	—	—
USB910 UHCI#5	shared	—	—	—	—	—	—	—
SATA1/2/5/6 (ICH8DO)	—	—	shared	—	—	—	—	—
SATA3/4 (ICH8DO)	—	—	—	shared	—	—	—	—
IDE-R controller	—	—	shared	—	—	—	—	—
KT controller	—	shared	—	—	—	—	—	—

1.8.4 PCI slots

The PCI slots support cards such as a LAN card, SCSI card, USB card, and other cards that comply with PCI specifications. The figure shows a LAN card installed on a PCI slot.

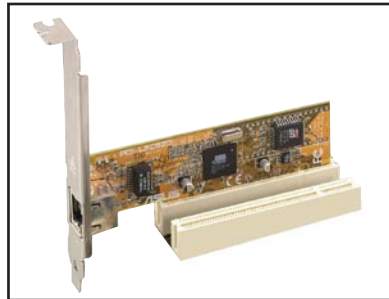

1.8.5 PCI Express x4 slot

This motherboard supports PCI Express x4 network cards, SCSI cards and other cards that comply with the PCI Express specifications. The following figure shows a network card installed on the PCI Express x4 slot.

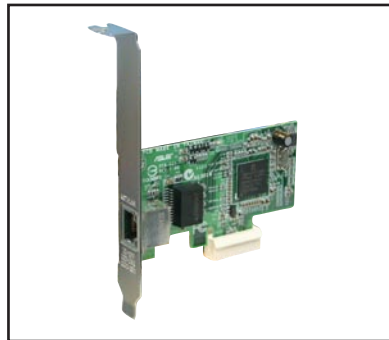

1.8.6 PCI Express x16 slot

This motherboard supports PCI Express x16 graphic cards that comply with the PCI Express specifications. The figure shows a graphics card installed on the PCI Express x16 slot.

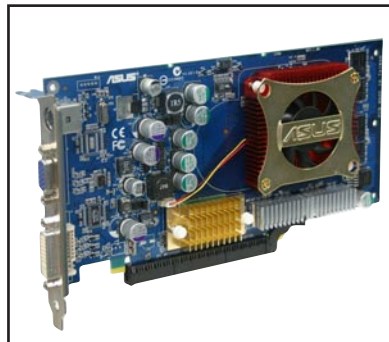

1.9 Jumper

1. Clear RTC RAM (CLRRTC)

This jumper allows you to clear the Real Time Clock (RTC) RAM in CMOS. You can clear the CMOS memory of date, time, and system setup parameters by erasing the CMOS RTC RAM data. The onboard button cell battery powers the RAM data in CMOS, which include system setup information such as system passwords.

To erase the RTC RAM:

1. Turn OFF the computer and unplug the power cord.
2. Remove the onboard battery.
3. Move the jumper cap from pins 1-2 (default) to pins 2-3. Keep the cap on pins 2-3 for about 5~10 seconds, then move the cap back to pins 1-2.
4. Reinstall the battery.
5. Plug the power cord and turn ON the computer.
6. Hold down the key during the boot process and enter BIOS setup to re-enter data.



Except when clearing the RTC RAM, never remove the cap on CLRRTC jumper default position. Removing the cap will cause system boot failure!

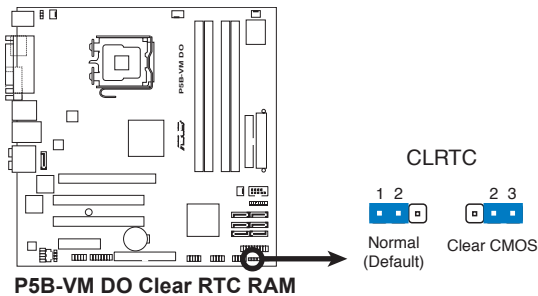

- You do not need to clear the RTC when the system hangs due to overclocking. For system failure due to overclocking, use the C.P.R. (CPU Parameter Recall) feature. Shut down and reboot the system so the BIOS can automatically reset parameter settings to default values.
- Due to the chipset limitation, AC power off is required prior using C.P.R. function. You must turn off and on the power supply or unplug and plug the power cord before reboot the system.

2. Keyboard power (3-pin KBPWR)

This jumper allows you to enable or disable the keyboard wake-up feature. Set this jumper to pins 2-3 (+5VSB) to wake up the computer when you press a key on the keyboard (the default is the Space Bar). This feature requires an ATX power supply that can supply at least 1A on the +5VSB lead, and a corresponding setting in the BIOS.

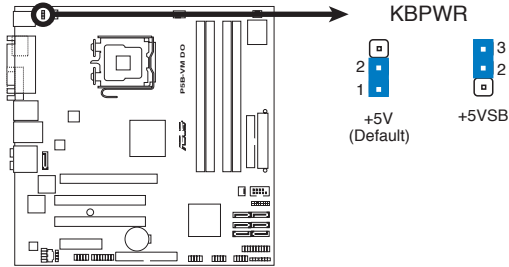

P5B-VM DO Keyboard Power Setting

1.10 Connectors

1.10.1 Rear panel connectors

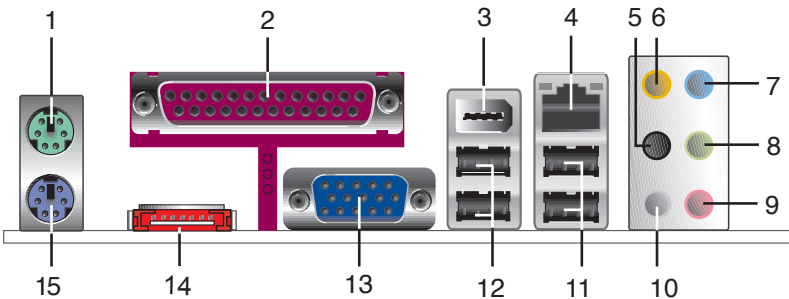

1. **PS/2 mouse port (green).** This port is for a PS/2 mouse.
2. **Parallel port.** This 25-pin port connects a parallel printer, a scanner, or other devices.
3. **IEEE 1394a port.** This 6-pin IEEE 1394a port provides high-speed connectivity for audio/video devices, storage peripherals, PCs, or portable devices.
4. **LAN (RJ-45) port.** Supported by Realtek® Gigabit LAN controller, this port allows Gigabit connection to a Local Area Network (LAN) through a network hub. Refer to the table below for the LAN port LED indications.

LAN port LED indications

Activity/Link Speed LED			
Status	Description	Status	Description
OFF	No link	OFF	10 Mbps connection
ORANGE	Linked	ORANGE	100 Mbps connection
BLINKING	Data activity	GREEN	1 Gbps connection

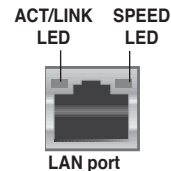

5. **Rear Speaker Out port (black).** This port connects the rear speakers in a 4-channel, 6-channel, or 8-channel audio configuration.
6. **Center/Subwoofer port (orange).** This port connects the center/subwoofer speakers.
7. **Line In port (light blue).** This port connects the tape, CD, DVD player, or other audio sources.
8. **Line Out port (lime).** This port connects a headphone or a speaker. In 4-channel, 6-channel, and 8-channel configuration, the function of this port becomes Front Speaker Out.
9. **Microphone port (pink).** This port connects a microphone.
10. **Side Speaker Out port (gray).** This port connects the side speakers in an 8-channel audio configuration.



Refer to the audio configuration table below for the function of the audio ports in 2, 4, 6, or 8-channel configuration.

Audio 2, 4, 6, or 8-channel configuration

Port	Headset 2-channel	4-channel	6-channel	8-channel
Light Blue	Line In	Line In	Line In	Line In
Lime	Line Out	Front Speaker Out	Front Speaker Out	Front Speaker Out
Pink	Mic In	Mic In	Mic In	Mic In
Orange	–	–	Center/Subwoofer	Center/Subwoofer
Black	–	Rear Speaker Out	Rear Speaker Out	Rear Speaker Out
Gray	–	–	–	Side Speaker Out

- USB 2.0 ports 1 and 2.** These two 4-pin Universal Serial Bus (USB) ports are available for connecting USB 2.0 devices.
- USB 2.0 ports 3 and 4.** These two 4-pin Universal Serial Bus (USB) ports are available for connecting USB 2.0 devices.
- VGA port.** This port is for a VGA monitor or other VGA-compatible devices.
- External SATA port.** This port connects to an external Serial ATA hard disk drive. To configure a RAID 0, a RAID 1, or a JBOD set, install an external Serial ATA hard disk drive and an internal Serial ATA hard disk drive to the SATA connector labeled SATA_RAID or SATA_RAID1.



The external SATA port supports external Serial ATA 3.0 Gb/s devices. Longer cables support higher power requirements to deliver signal up to two meters away, and enables improved hot-swap function.



- Before creating a RAID set using Serial ATA hard disks, make sure that you have connected the Serial ATA signal cable and installed Serial ATA hard disk drives; otherwise, you cannot enter the JMicron RAID utility and SATA BIOS setup during POST.
- If you intend to create a RAID configuration using this connector, set the **JMicron SATA Controller Mode** item in the BIOS to [RAID]. See section “2.4.6 Onboard Device Configuration” for details.



- DO NOT insert a different connector to this port.
- DO NOT unplug the external Serial ATA box when a RAID 0 or JBOD is configured.

- PS/2 keyboard port (purple).** This port is for a PS/2 keyboard.

1.10.2 Internal connectors

1. Floppy disk drive connector (34-1 pin FLOPPY)

This connector is for the provided floppy disk drive (FDD) signal cable. Insert one end of the cable to this connector, then connect the other end to the signal connector at the back of the floppy disk drive.



Pin 5 on the connector is removed to prevent incorrect cable connection when using a FDD cable with a covered Pin 5.

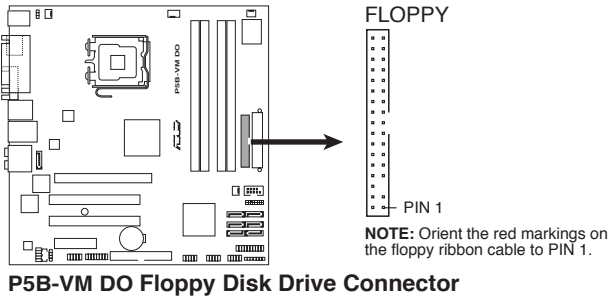

2. Digital Audio connector (4-1 pin SPDIF_OUT)

This connector is for the S/PDIF audio module to allow digital sound output. Connect one end of the S/PDIF audio cable to this connector and the other end to the S/PDIF module.

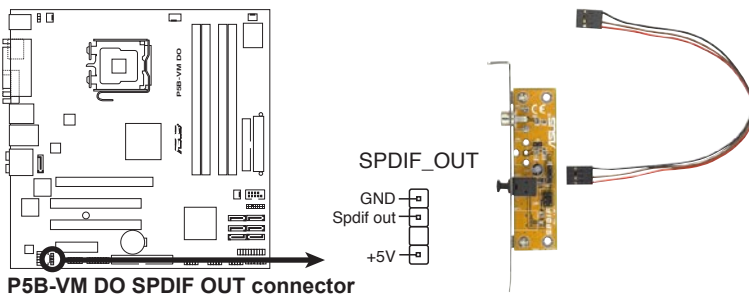

The S/PDIF out module is purchased separately.

3. IDE connector (40-1 pin PRI_EIDE)

The onboard IDE connector is for the Ultra DMA 133/100/66 signal cable. There are three connectors on each Ultra DMA 133/100/66 signal cable: blue, black, and gray. Connect the blue connector to the motherboard's IDE connector, then select one of the following modes to configure your device.

	Drive jumper setting	Mode of device(s)	Cable connector
Single device	Cable-Select or Master	-	Black
Two devices	Cable-Select	Master	Black
		Slave	Gray
	Master	Master	Black or gray
	Slave	Slave	



- Pin 20 on the IDE connector is removed to match the covered hole on the Ultra DMA cable connector. This prevents incorrect insertion when you connect the IDE cable.
- Use the 80-conductor IDE cable for Ultra DMA 133/100/66 IDE devices.



If any device jumper is set as "Cable-Select," make sure all other device jumpers have the same setting.

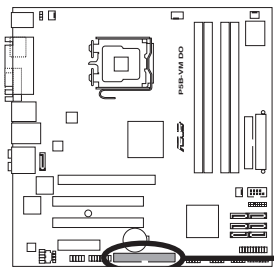

P5B-VM DO IDE connector

PRI_EIDE



PIN1

NOTE: Orient the red markings (usually zigzag) on the ID ribbon cable to PIN 1.

4. **ICH8DO Serial ATA connectors (7-pin SATA1 [red], SATA2 [red], SATA3 [red], SATA4 [red], SATA5 [black], SATA6 [black])**

These connectors are for the Serial ATA signal cables for Serial ATA hard disk drives.

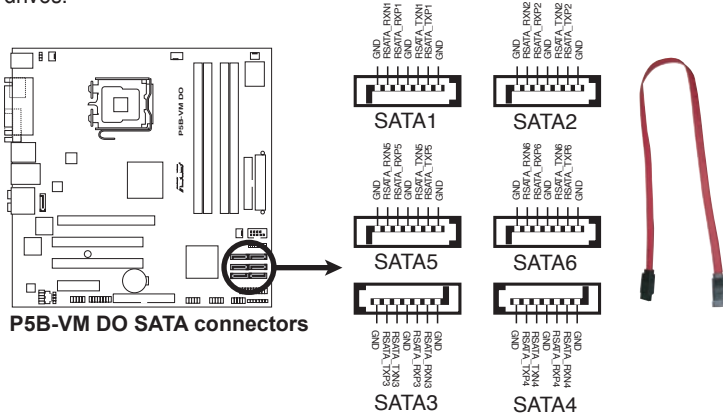

Connect the right-angle side of SATA signal cable to SATA device. Or you may connect the right-angle side of SATA cable to the onboard SATA port to avoid mechanical conflict with huge graphics cards.

right angle side

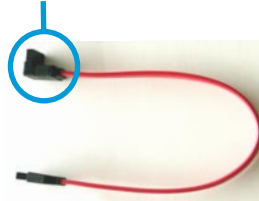

5. **IEEE 1394a port connector (10-1 pin IE1394_2)**

This connector is for a IEEE 1394a port. Connect the IEEE 1394a module cable to this connector, then install the module to a slot opening at the back of the system chassis.

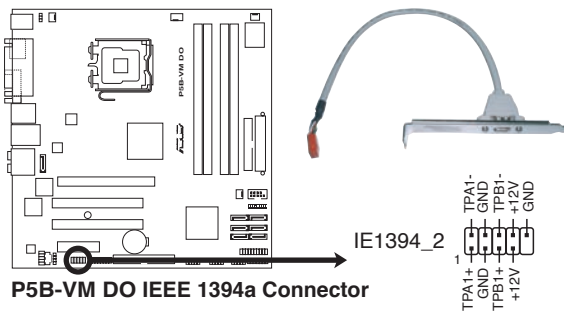

The IEEE 1394a module is purchased separately.

6. JMicron JMB363® Serial ATA RAID connector (7-pin SATA_RAID1)

This connector is for a Serial ATA signal cable. This connector supports a Serial ATA hard disk drive, which you can combine with an external Serial ATA hard disk drive to configure for RAID via the onboard Serial ATA RAID controller.



The **JMicron controller mode** item in the BIOS is set to [BASIC] by default. When set to [RAID], this item allows you to use the connectors to build a RAID set. See section “2.4.6 Onboard Device Configuration” for details.

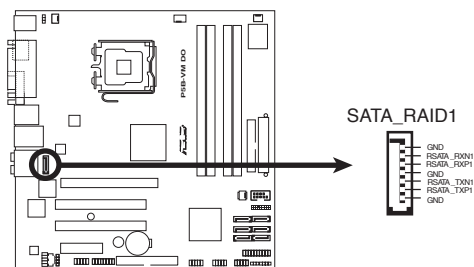

P5B-VM DO SATA RAID connector



Before creating a RAID set using Serial ATA hard disks, make sure that you have connected the Serial ATA signal cables and installed Serial ATA hard disk drives; otherwise, you cannot enter the JMicron® JMB363 RAID utility and SATA BIOS setup during POST.

7. TPM connector (20-1 pin TPM_SLOT)

This connector supports a Trusted Platform Module (TPM) system, which can securely store keys, digital certificates, passwords, and data. A TPM system also helps enhance network security, protects digital identities, and ensures platform integrity. See section “2.4.3 TPM Configuration” for details.

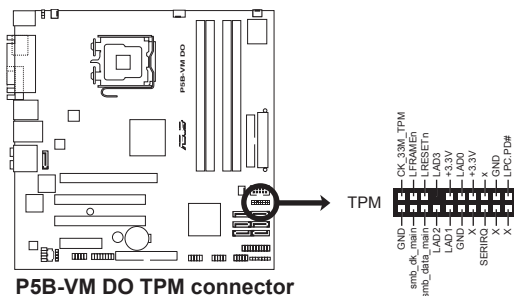

P5B-VM DO TPM connector

8. USB connectors (10-1 pin USB56, USB 78, USB910)

These connectors are for USB 2.0 ports. Connect the USB module cable to any of these connectors, then install the module to a slot opening at the back of the system chassis. These USB connectors comply with USB 2.0 specification that supports up to 480 Mbps connection speed.

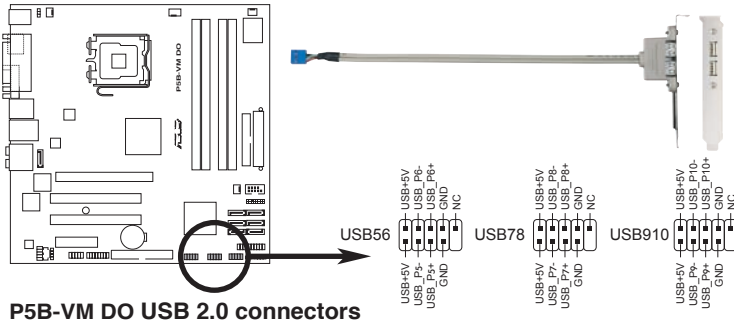

Never connect a 1394 cable to the USB connectors. Doing so will damage the motherboard!



You can connect the USB cable to ASUS Q-Connector (USB, blue) first, and then install the Q-Connector (USB) to the USB connector onboard.



The USB module is purchased separately.

9. Optical drive audio connector (4-pin CD)

These connectors allow you to receive stereo audio input from sound sources such as a CD-ROM, TV tuner, or MPEG card.

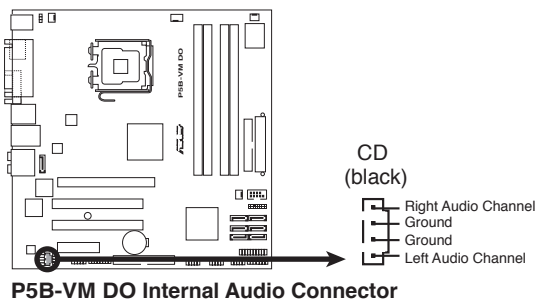

10. CPU, chassis, and power fan connectors (4-pin CPU_FAN, 3-pin CHA_FAN, 3-pin CHA_FAN2, 3-pin PWR_FAN)

The fan connectors support cooling fans of 350 mA ~ 2000 mA (24 W max.) or a total of 1 A ~ 7 A (84 W max.) at +12V. Connect the fan cables to the fan connectors on the motherboard, making sure that the black wire of each cable matches the ground pin of the connector.



Do not forget to connect the fan cables to the fan connectors. Insufficient air flow inside the system may damage the motherboard components. These are not jumpers! Do not place jumper caps on the fan connectors!

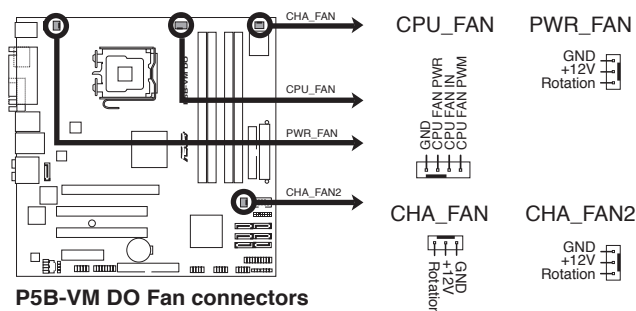

Only the CPU-FAN and CHA-FAN connectors support the ASUS Advanced Q-Fan feature.

11. Serial port connector (10-1 pin COM1)

This connector is for a serial (COM) port. Connect the serial port module cable to this connector, then install the module to a slot opening at the back of the system chassis.

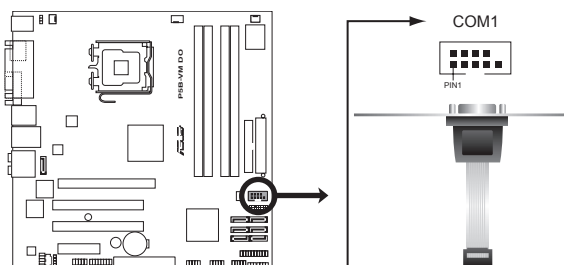

The COM module is purchased separately.

12. Chassis intrusion connector (4-1 pin CHASSIS)

This connector is for a chassis-mounted intrusion detection sensor or switch. Connect one end of the chassis intrusion sensor or switch cable to this connector. The chassis intrusion sensor or switch sends a high-level signal to this connector when a chassis component is removed or replaced. The signal is then generated as a chassis intrusion event.

By default, the pin labeled “Chassis Signal” and “Ground” are shorted with a jumper cap. Remove the jumper caps only when you intend to use the chassis intrusion detection feature.

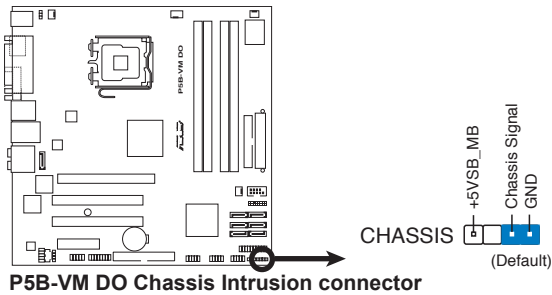

13. Front panel audio connector (10-1 pin AAFP)

This connector is for a chassis-mounted front panel audio I/O module that supports either HD Audio or legacy AC'97 audio standard. Connect one end of the front panel audio I/O module cable to this connector.

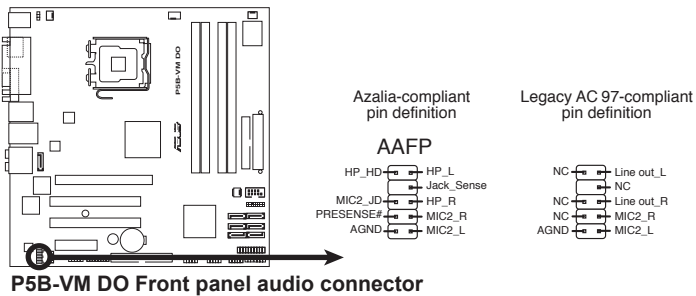

- We recommend that you connect a high-definition front panel audio module to this connector to avail of the motherboard's high-definition audio capability.
- By default, this connector is set to [HD Audio]. If you want to connect a AC'97 front panel audio module to this connector, set the **Front Panel Support Type** item in the BIOS setup to [AC97]. See section 2.4.6 Onboard Device Configuration for details.

14. ATX power connectors (24-pin EATXPWR, 4-pin EATX12V)

These connectors are for ATX power supply plugs. The power supply plugs are designed to fit these connectors in only one orientation. Find the proper orientation and push down firmly until the connectors completely fit.

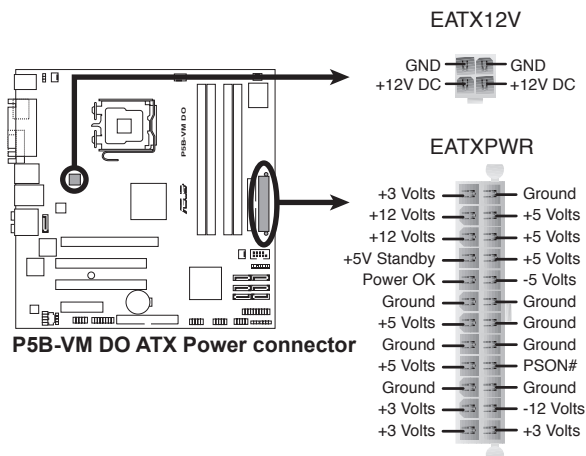

- For a fully configured system, we recommend that you use a power supply unit (PSU) that complies with ATX 12 V Specification 2.0 (or later version) and provides a minimum power of 400 W.
- Do not forget to connect the 4-pin EATX12V power plug; otherwise, the system will not boot.
- Use of a PSU with a higher power output is recommended when configuring a system with more power-consuming devices. The system may become unstable or may not boot up if the power is inadequate.
- The ATX 12 V Specification 2.0-compliant (400W) PSU has been tested to support the motherboard power requirements with the following configuration:
CPU: Intel® Pentium® Extreme 3.73GHz
Memory: 512 MB DDR2 (x4)
Graphics card: ASUS EAX1900XT
Parallel ATA device: IDE hard disk drive
Serial ATA device: SATA hard disk drive (x2)
Optical drive: DVD-RW

15. System panel connector (20-8 pin PANEL)

This connector supports several chassis-mounted functions.

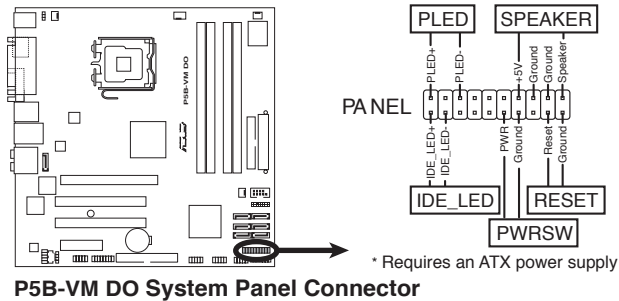

- **System power LED (2-pin PLED)**

This 2-pin connector is for the system power LED. Connect the chassis power LED cable to this connector. The system power LED lights up when you turn on the system power, and blinks when the system is in sleep mode.

- **Hard disk drive activity LED (2-pin IDE_LED)**

This 2-pin connector is for the HDD Activity LED. Connect the HDD Activity LED cable to this connector. The IDE LED lights up or flashes when data is read from or written to the HDD.

- **System warning speaker (4-pin SPEAKER)**

This 4-pin connector is for the chassis-mounted system warning speaker. The speaker allows you to hear system beeps and warnings.

- **ATX power button/soft-off button (2-pin PWRSW)**

This connector is for the system power button. Pressing the power button turns the system on or puts the system in sleep or soft-off mode depending on the BIOS settings. Pressing the power switch for more than four seconds while the system is ON turns the system OFF.

- **Reset button (2-pin RESET)**

This 2-pin connector is for the chassis-mounted reset button for system reboot without turning off the system power.

Q-Connector (system panel)

ASUS Q-Connector allows you to easily to connect the chassis front panel cables to the motherboard. Perform these steps to install ASUS Q-Connector.

Step1.

Connect the front panel cables to their respective connectors on the ASUS Q-Connector. Refer to the labels on the Q-Connector for proper connection and pin definition.

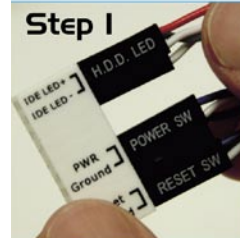

Step2.

Carefully connect the ASUS Q-Connector to the System panel connector.



The ASUS Q-Connector fits only in one orientation; if it doesn't fit, try reversing it.

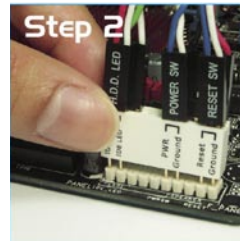

Step3.

When installed, the Q-connector appears as shown.

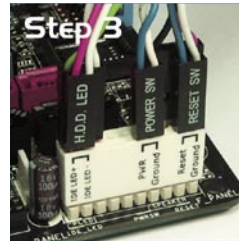

This chapter tells how to change the system settings through the BIOS Setup menus. Detailed descriptions of the BIOS parameters are also provided.

BIOS setup **2**

2.1 Managing and updating your BIOS

The following utilities allow you to manage and update the motherboard Basic Input/Output System (BIOS) setup.

1. **ASUS EZ Flash 2** (Updates the BIOS using a floppy disk or USB flash disk.)
2. **ASUS AFUDOS** (Updates the BIOS in DOS mode using a bootable floppy disk.)
3. **ASUS CrashFree BIOS 3** (Updates the BIOS using a bootable floppy, USB Flash disk, or the motherboard support CD when the BIOS file fails or gets corrupted.)
4. **ASUS Update** (Updates the BIOS in Windows® environment.)

Refer to the corresponding sections for details on these utilities.



Save a copy of the original motherboard BIOS file to a bootable floppy disk or a USB flash disk in case you need to restore the BIOS in the future. Copy the original motherboard BIOS using the ASUS Update or AFUDOS utilities.

2.1.1 Creating a bootable floppy disk

1. Do either one of the following to create a bootable floppy disk.

DOS environment

- a. Insert a 1.44MB floppy disk into the drive.
- b. At the DOS prompt, type `format a: /s` then press <Enter>.

Windows® XP environment

- a. Insert a 1.44 MB floppy disk to the floppy disk drive.
- b. Click **Start** from the Windows® desktop, then select **My Computer**.
- c. Select the 3 1/2 Floppy Drive icon.
- d. Click **File** from the menu, then select **Format. A Format 3 1/2 Floppy Disk** window appears.
- e. Select **Create an MS-DOS startup disk** from the format options field, then click **Start**.

Windows® 2000 environment

To create a set of boot disks for Windows® 2000:

- a. Insert a formatted, high density 1.44 MB floppy disk into the drive.
- b. Insert the Windows® 2000 CD to the optical drive.
- c. Click **Start**, then select **Run**.
- d. From the Open field, type
`D:\bootdisk\makeboot a:`
assuming that D: is your optical drive.
- e. Press <Enter>, then follow screen instructions to continue.

2. Copy the original or the latest motherboard BIOS file to the bootable floppy disk.

2.1.2 ASUS EZ Flash 2 utility

The ASUS EZ Flash 2 feature allows you to update the BIOS without having to go through the long process of booting from a floppy disk and using a DOS-based utility. The EZ Flash 2 utility is built-in the BIOS chip so it is accessible by pressing <Alt> + <F2> during the Power-On Self-Test (POST).

To update the BIOS using EZ Flash 2:

1. Visit the ASUS website (www.asus.com) to download the latest BIOS file for the motherboard.
2. Save the BIOS file to a floppy disk or a USB flash disk, then restart the system.
3. You can launch the EZ Flash 2 by two methods.
 - (1) Insert the floppy disk / USB flash disk that contains the BIOS file to the floppy disk drive or the USB port.

Press <Alt> + <F2> during POST to display the following.

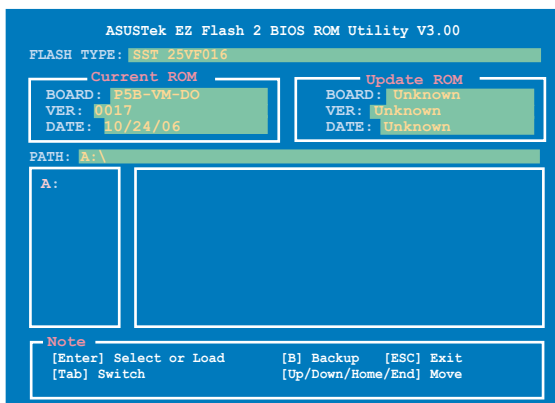

- (2) Enter BIOS setup program. Go to the **Tools** menu to select **EZ Flash2** and press <Enter> to enable it.
You can switch between drives by pressing <Tab> before the correct file is found. Then press <Enter>.
4. When the correct BIOS file is found, EZ Flash 2 performs the BIOS update process and automatically reboots the system when done.



- This function can support devices such as USB flash disk, or floppy disk with **FAT 32/16** format only.
- Do not shut down or reset the system while updating the BIOS to prevent system boot failure!



- This function can support devices such as USB flash disk, or floppy disk with **FAT 32/16** format only.
- Do not shut down or reset the system while updating the BIOS to prevent system boot failure!

2.1.3 AFUDOS utility

The AFUDOS utility allows you to update the BIOS file in DOS environment using a bootable floppy disk with the updated BIOS file. This utility also allows you to copy the current BIOS file that you can use as backup when the BIOS fails or gets corrupted during the updating process.

Copying the current BIOS

To copy the current BIOS file using the AFUDOS utility:



- Make sure that the floppy disk is not write-protected and has at least 1024KB free space to save the file.
- The succeeding BIOS screens are for reference only. The actual BIOS screen displays may not be same as shown.

1. Copy the AFUDOS utility (afudos.exe) from the motherboard support CD to the bootable floppy disk you created earlier.
2. Boot the system in DOS mode, then at the prompt type:

```
afudos /o[filename]
```

where the [filename] is any user-assigned filename not more than eight alphanumeric characters for the main filename and three alphanumeric characters for the extension name.

```
A:\>afudos /oOLDBIOS1.rom
```

Main filename Extension name

3. Press <Enter>. The utility copies the current BIOS file to the floppy disk.

```
A:\>afudos /oOLDBIOS1.rom
AMI Firmware Update Utility - Version 1.19 (ASUS V2.07 (03.11.24BB))
Copyright (C) 2002 American Megatrends, Inc. All rights reserved.
Reading flash ..... done
Write to file..... ok
A:\>
```

The utility returns to the DOS prompt after copying the current BIOS file.

Updating the BIOS file

To update the BIOS file using the AFUDOS utility:

1. Visit the ASUS website (www.asus.com) and download the latest BIOS file for the motherboard. Save the BIOS file to a bootable floppy disk.



Write the BIOS filename on a piece of paper. You need to type the exact BIOS filename at the DOS prompt.

2. Copy the AFUDOS utility (`afudos.exe`) from the motherboard support CD to the bootable floppy disk you created earlier.
3. Boot the system in DOS mode, then at the prompt type:

```
afudos /i [filename]
```

where [filename] is the latest or the original BIOS file on the bootable floppy disk.

```
A:\>afudos /iP5BVMDA.ROM
```

4. The utility verifies the file and starts updating the BIOS.

```
A:\>afudos /iP5BVMDA.ROM
AMI Firmware Update Utility - Version 1.19 (ASUS V2.07(03.11.24BB))
Copyright (C) 2002 American Megatrends, Inc. All rights reserved.

WARNING!! Do not turn off power during flash BIOS
Reading file ..... done
Reading flash ..... done

Advance Check .....
Erasing flash ..... done
Writing flash ..... 0x0008CC00 (9%)
```



Do not shut down or reset the system while updating the BIOS to prevent system boot failure!

5. The utility returns to the DOS prompt after the BIOS update process is completed. Reboot the system from the hard disk drive.

```
A:\>afudos /iP5BVMDA.ROM
AMI Firmware Update Utility - Version 1.19 (ASUS V2.07(03.11.24BB))
Copyright (C) 2002 American Megatrends, Inc. All rights reserved.

WARNING!! Do not turn off power during flash BIOS
Reading file ..... done
Reading flash ..... done

Advance Check .....
Erasing flash ..... done
Writing flash ..... done
Verifying flash .... done

Please restart your computer

A:\>
```

2.1.4 ASUS CrashFree BIOS 3 utility

The ASUS CrashFree BIOS 3 is an auto recovery tool that allows you to restore the BIOS file when it fails or gets corrupted during the updating process. You can update a corrupted BIOS file using the motherboard support CD, the USB flash disk, or the floppy disk that contains the updated BIOS file.



- Prepare the motherboard support CD, the USB flash disk, or the floppy disk containing the updated motherboard BIOS before using this utility.
- Make sure that you rename the original or updated BIOS file in the floppy disk or the USB flash disk to **P5BVMDA.ROM**.

If your display monitor is connected to the onboard VGA connector, the display monitor will turn-off and the system will beep once while CrashFree BIOS 3 starts updating your system. The system will beep once again while the process is finished, and the display will return after the system restarts.

Recovering the BIOS from a floppy disk

To recover the BIOS from a floppy disk:

1. Turn on the system.
2. Insert the floppy disk with the original or updated BIOS file to the floppy disk drive.
3. The utility displays the following message and automatically checks the floppy disk for the original or updated BIOS file.

```
Bad BIOS checksum. Starting BIOS recovery...
Checking for floppy...
```

When found, the utility reads the BIOS file and starts flashing the corrupted BIOS file.

```
Bad BIOS checksum. Starting BIOS recovery...
Checking for floppy...
Floppy found!
Reading file "P5BVMDA.ROM". Completed.
Start flashing...
```

4. Restart the system after the utility completes the updating process.

Recovering the BIOS from the support CD

To recover the BIOS from the support CD:

1. Remove any floppy disk from the floppy disk drive, then turn on the system.
2. Insert the support CD to the optical drive.
3. The utility displays the following message and automatically checks the floppy disk for the original or updated BIOS file.

```
Bad BIOS checksum. Starting BIOS recovery...  
Checking for floppy...
```

When no floppy disk is found, the utility automatically checks the optical drive for the original or updated BIOS file. The utility then updates the corrupted BIOS file.

```
Bad BIOS checksum. Starting BIOS recovery...  
Checking for floppy...  
Floppy not found!  
Checking for CD-ROM...  
CD-ROM found!  
Reading file "P5BVMDA.ROM". Completed.  
Start flashing...
```

4. Restart the system after the utility completes the updating process.

Recovering the BIOS from the USB flash disk

To recover the BIOS from the USB flash disk:

1. Insert the USB flash disk that contains BIOS file to the USB port.
2. Turn on the system.
3. The utility will automatically checks the devices for the BIOS file when found, the utility reads the BIOS file and starts flashing the corrupted BIOS file.
4. Restart the system after the utility completes the updating process.



The recovered BIOS may not be the latest BIOS version for this motherboard. Visit the ASUS website (www.asus.com) to download the latest BIOS file.



-
- Only the USB flash disk with FAT 32/16 format and single partition can support ASUS CrashFree BIOS 3. The device size should be smaller than 8GB.
 - DO NOT shut down or reset the system while updating the BIOS! Doing so can cause system boot failure!
-

2.1.5 ASUS Update utility

The ASUS Update is a utility that allows you to manage, save, and update the motherboard BIOS in Windows® environment. The ASUS Update utility allows you to:

- Save the current BIOS file
- Download the latest BIOS file from the Internet
- Update the BIOS from an updated BIOS file
- Update the BIOS directly from the Internet, and
- View the BIOS version information.

This utility is available in the support CD that comes with the motherboard package.



ASUS Update requires an Internet connection either through a network or an Internet Service Provider (ISP).

Installing ASUS Update

To install ASUS Update:

1. Place the support CD in the optical drive. The **Drivers** menu appears.
2. Click the **Utilities** tab, then click **Install ASUS Update**. See page 3-4 for the **Utilities** screen menu.
3. The ASUS Update utility is copied to your system.



Quit all Windows® applications before you update the BIOS using this utility.

Updating the BIOS through the Internet

To update the BIOS through the Internet:

1. Launch the ASUS Update utility from the Windows® desktop by clicking **Start > Programs > ASUS > ASUSUpdate > ASUSUpdate**. The ASUS Update main window appears.

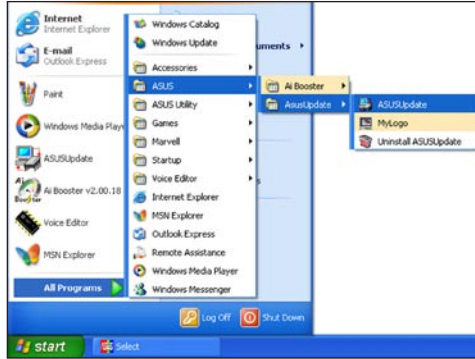

2. Select **Update BIOS from the Internet** option from the drop-down menu, then click **Next**.



3. Select the ASUS FTP site nearest you to avoid network traffic, or click **Auto Select**. Click **Next**.

- From the FTP site, select the BIOS version that you wish to download. Click **Next**.
- Follow the screen instructions to complete the update process.



The ASUS Update utility is capable of updating itself through the Internet. Always update the utility to avail all its features.



Updating the BIOS through a BIOS file

To update the BIOS through a BIOS file:

- Launch the ASUS Update utility from the Windows® desktop by clicking **Start > Programs > ASUS > ASUSUpdate > ASUSUpdate**. The ASUS Update main window appears.
- Select **Update BIOS from a file** option from the drop-down menu, then click **Next**.

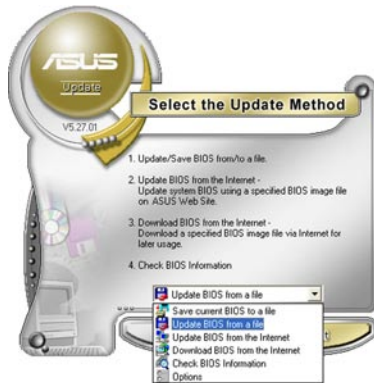

- Locate the BIOS file from the **Open** window, then click **Open**.
- Follow the screen instructions to complete the update process.

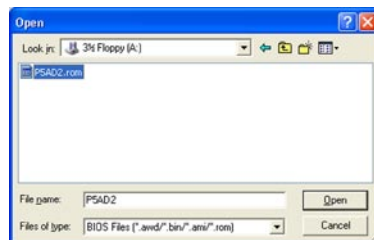

2.2 BIOS setup program

This motherboard supports a programmable firmware chip that you can update using the provided utility described in section “2.1 Managing and updating your BIOS.”

Use the BIOS Setup program when you are installing a motherboard, reconfiguring your system, or prompted to “Run Setup.” This section explains how to configure your system using this utility.

Even if you are not prompted to use the Setup program, you can change the configuration of your computer in the future. For example, you can enable the security password feature or change the power management settings. This requires you to reconfigure your system using the BIOS Setup program so that the computer can recognize these changes and record them in the CMOS RAM of the SPI chip.

The firmware chip on the motherboard stores the Setup utility. When you start up the computer, the system provides you with the opportunity to run this program. Press during the Power-On Self-Test (POST) to enter the Setup utility; otherwise, POST continues with its test routines.

If you wish to enter Setup after POST, reboot the system by doing any of the following procedures:

- Restart using the OS standard shut-down procedure.
- Press <Ctrl>+<Alt>+ simultaneously.
- Press the reset button on the system chassis.
- Press the power button to turn the system off then back on.



Using the **power button**, **reset button**, or the <Ctrl>+<Alt>+ keys to force reset from a running operating system can cause damage to your data or system. We recommend to always shut-down the system properly from the operating system.

The Setup program is designed to make it as easy to use as possible. Being a menu-driven program, it lets you scroll through the various sub-menus and make your selections from the available options using the navigation keys.



-
- The default BIOS settings for this motherboard apply for most conditions to ensure optimum performance. If the system becomes unstable after changing any BIOS settings, load the default settings to ensure system compatibility and stability. Select the **Load Setup Defaults** item under the Exit Menu. See section “2.8 Exit Menu.”
 - The BIOS setup screens shown in this section are for reference purposes only, and may not exactly match what you see on your screen.
 - Visit the ASUS website (www.asus.com) to download the latest BIOS file for this motherboard.
-

2.2.1 BIOS menu screen

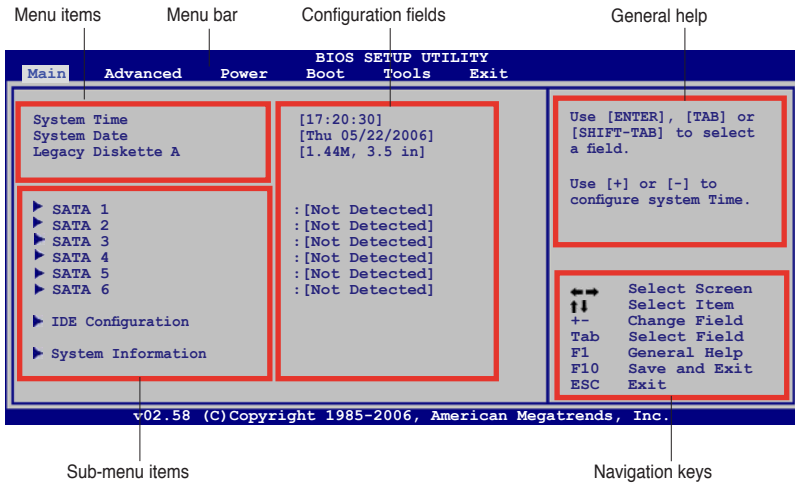

2.2.2 Menu bar

The menu bar on top of the screen has the following main items:

Main	For changing the basic system configuration
Advanced	For changing the advanced system settings
Power	For changing the advanced power management (APM) configuration
Boot	For changing the system boot configuration
Tools	For configuring options for special functions
Exit	For selecting the exit options and loading default settings

To select an item on the menu bar, press the right or left arrow key on the keyboard until the desired item is highlighted.

2.2.3 Navigation keys

At the bottom right corner of a menu screen are the navigation keys for that particular menu. Use the navigation keys to select items in the menu and change the settings.



Some of the navigation keys differ from one screen to another.

2.2.4 Menu items

The highlighted item on the menu bar displays the specific items for that menu. For example, selecting Main shows the Main menu items.

The other items (Advanced, Power, Boot, Tool, and Exit) on the menu bar have their respective menu items.

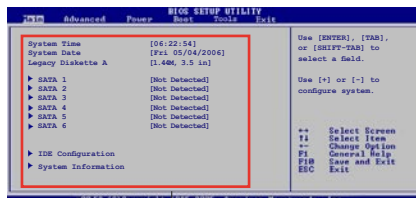

Main menu items

2.2.5 Sub-menu items

A solid triangle before each item on any menu screen means that the item has a sub-menu. To display the sub-menu, select the item and press <Enter>.

2.2.6 Configuration fields

These fields show the values for the menu items. If an item is user-configurable, you can change the value of the field opposite the item. You cannot select an item that is not user-configurable.

A configurable field is enclosed in brackets, and is highlighted when selected. To change the value of a field, select it then press <Enter> to display a list of options. Refer to “2.2.7 Pop-up window.”

2.2.7 Pop-up window

Select a menu item then press <Enter> to display a pop-up window with the configuration options for that item.

2.2.8 Scroll bar

A scroll bar appears on the right side of a menu screen when there are items that do not fit on the screen. Press the Up/Down arrow keys or <Page Up> / <Page Down> keys to display the other items on the screen.

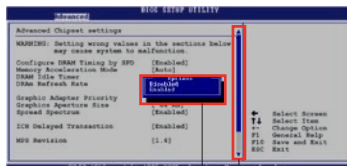

Pop-up window

Scroll bar

2.2.9 General help

At the top right corner of the menu screen is a brief description of the selected item.

2.3 Main menu

When you enter the BIOS Setup program, the Main menu screen appears, giving you an overview of the basic system information.



Refer to section “2.2.1 BIOS menu screen” for information on the menu screen items and how to navigate through them.

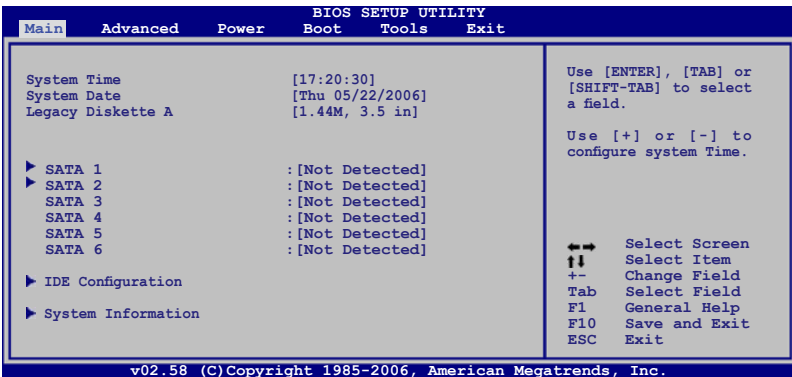

2.3.1 System Time [xx:xx:xx]

Allows you to set the system time.

2.3.2 System Date [Day xx/xx/xxxx]

Allows you to set the system date.

2.3.3 Legacy Diskette A [1.44M, 3.5 in.]

Sets the type of floppy drive installed.

Configuration options: [Disabled] [360K, 5.25 in.] [1.2M, 5.25 in.] [720K, 3.5 in.] [1.44M, 3.5 in.] [2.88M, 3.5 in.]

2.3.4 SATA1-6

While entering Setup, the BIOS automatically detects the presence of IDE devices. There is a separate sub-menu for each IDE device. Select a device item then press <Enter> to display the IDE device information.

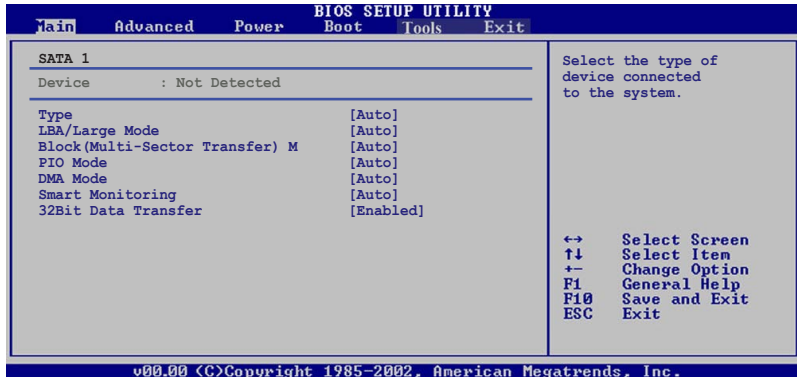

The BIOS automatically detects the values opposite the dimmed items (Device, Vendor, Size, LBA Mode, Block Mode, PIO Mode, Async DMA, Ultra DMA, and SMART monitoring). These values are not user-configurable. These items show N/A if no IDE device is installed in the system.

Type [Auto]

Selects the type of IDE drive. Setting to Auto allows automatic selection of the appropriate IDE device type. Select CDROM if you are specifically configuring a CD-ROM drive. Select ARMD (ATAPI Removable Media Device) if your device is either a ZIP, LS-120, or MO drive.

Configuration options: [Not Installed] [Auto] [CDROM] [ARMD]

LBA/Large Mode [Auto]

Enables or disables the LBA mode. Setting to Auto enables the LBA mode if the device supports this mode, and if the device was not previously formatted with LBA mode disabled. Configuration options: [Disabled] [Auto]

Block (Multi-Sector Transfer) M [Auto]

Enables or disables data multi-sectors transfers. When set to Auto, the data transfer from and to the device occurs multiple sectors at a time if the device supports multi-sector transfer feature. When set to [Disabled], the data transfer from and to the device occurs one sector at a time.

Configuration options: [Disabled] [Auto]

PIO Mode [Auto]

Selects the PIO mode. Configuration options: [Auto] [0] [1] [2] [3] [4]

DMA Mode [Auto]

Selects the DMA mode. Configuration options: [Auto] [SWDMA0] [SWDMA1] [SWDMA2] [MWDMA0] [MWDMA1] [MWDMA2] [UDMA0] [UDMA1] [UDMA2] [UDMA3] [UDMA4] [UDMA5]

SMART Monitoring [Auto]

Sets the Smart Monitoring, Analysis, and Reporting Technology. Configuration options: [Auto] [Disabled] [Enabled]

32Bit Data Transfer [Enabled]

Enables or disables 32-bit data transfer. Configuration options: [Disabled] [Enabled]

2.3.5 IDE Configuration

The items in this menu allow you to set or change the configurations for the IDE devices installed in the system. Select an item then press <Enter> if you wish to configure the item.

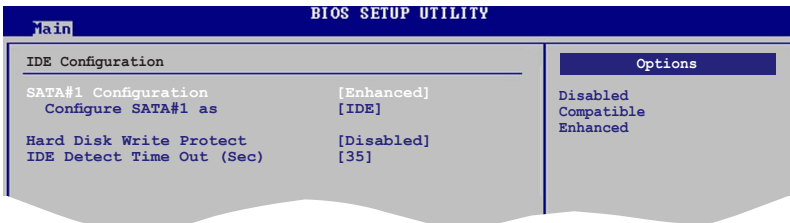

SATA Configuration [Enhanced]

Configuration options: [Disabled] [Compatible] [Enhanced]

Configure SATA#1 As [IDE]

Sets the configuration for the Serial ATA connectors supported by the Southbridge chip.

The AHCI allows the onboard storage driver to enable advanced Serial ATA features that increases storage performance on random workloads by allowing the drive to internally optimize the order of commands.

If you want to create a RAID 0, RAID 1, RAID 5, RAID 10, or the Intel® Matrix Storage Technology configuration from the Serial ATA hard disk drives, set this item to [RAID].

If you want to use the Serial ATA hard disk drives as Parallel ATA physical storage devices, keep the default setting [IDE].

If you want the Serial ATA hard disk drives to use the Advanced Host Controller Interface (AHCI), set this item to [AHCI].

Hard Disk Write Protect [Disabled]

Allows you to enable to disable the hard disk write protection. This will be effective only if device is accessed through BIOS.

Configuration options: [Disabled] [Enabled]

IDE Detect Time Out [35]

Selects the time out value for detecting ATA/ATAPI devices.

Configuration options: [0] [5] [10] [15] [20] [25] [30] [35]

2.3.6 System Information

This menu gives you an overview of the general system specifications. The BIOS automatically detects the items in this menu.

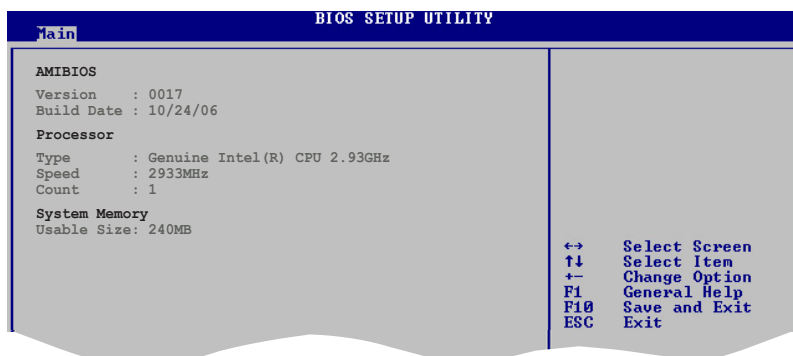

AMI BIOS

Displays the auto-detected BIOS information

Processor

Displays the auto-detected CPU specification

System Memory

Displays the auto-detected system memory

2.4 Advanced menu

The Advanced menu items allow you to change the settings for the CPU and other system devices.



Take caution when changing the settings of the Advanced menu items. Incorrect field values can cause the system to malfunction.

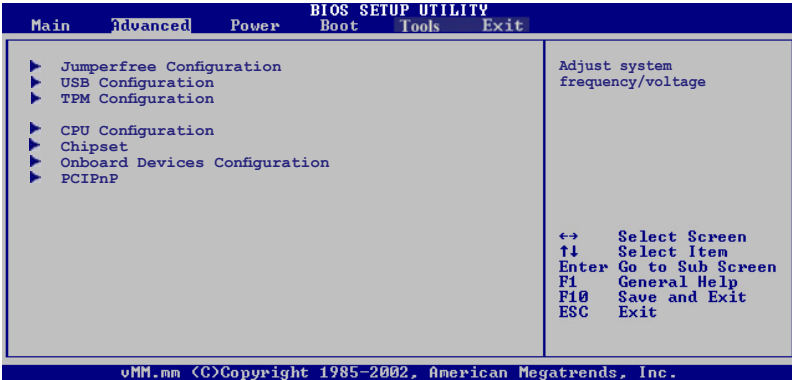

2.4.1 Jumperfree Configuration

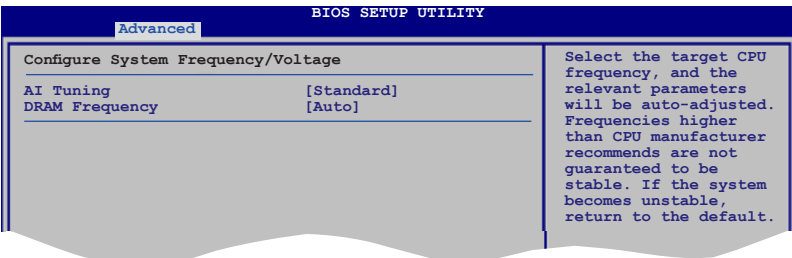

AI Tuning [Standard]

Allows selection of CPU frequency and auto adjustment of relevant parameters. Frequencies higher than CPU manufacturer recommends are not guaranteed to be stable. If the system becomes unstable, return to the default.

Configuration options: [Manual] [Standard]



The following items appear only when the AI Tuning item is set to [Manual].

CPU Frequency [xxx]

Displays the frequency sent by the clock generator to the system bus and PCI bus. The value of this item is auto-detected by the BIOS. Use the <=> and <-> keys to adjust the CPU frequency. You can also type the desired CPU frequency using the numeric keypad. The values range from 100 to 400. Refer to the table below for the correct Front Side Bus and CPU External Frequency settings.

FSB/CPU External Frequency Synchronization

Front Side Bus	CPU External Frequency
FSB 1066	266 MHz
FSB 800	200 MHz
FSB 533	133 MHz

DRAM Frequency [Auto]

Allows you to set the DDR2 operating frequency.

Configuration options:

Available DRAM frequency options in various FSB settings

FSB	Configuration options					
	Auto	DDR2-533	DDR2-667	DDR2-800	DDR2-889*	DDR2-1067*
FSB 1066	•	•	•	•	•	•
FSB 800	•	•	•	•		

* Provided for overclocking purpose only.



Selecting a very high DRAM frequency may cause the system to become unstable! If this happens, revert to the default setting.

Spread Spectrum [Auto]

Allows you to enable or disable the clock generator spread spectrum.

Configuration options: [Disabled] [Enabled] [Auto]

CPU VCore Voltage [Auto]

Allows selection of the CPU VCore voltage. The configuration options vary depending on the CPU installed. Setting to Auto allows the BIOS to detect the VCore voltage of the CPU installed.

Configuration options: [1.6000V] [1.5875V] [1.5750V] [1.5625V] [1.5500V] [1.5375V] [1.5250V] [1.5125V] [1.5000V] [1.4875V] [1.4750V] [1.4625V] [1.4500V] [1.4375V] [1.4250V] [1.4125V] [1.4000V] [1.3875V] [1.3750V] [1.3625V] [1.3500V] [1.3375V] [1.3250V] [1.3125V] [1.3000V]



Refer to the CPU documentation before setting the CPU VCore voltage. A very high Vcore voltage can severely damage the CPU!

2.4.2 USB Configuration

The items in this menu allow you to change the USB-related features. Select an item then press <Enter> to display the configuration options.

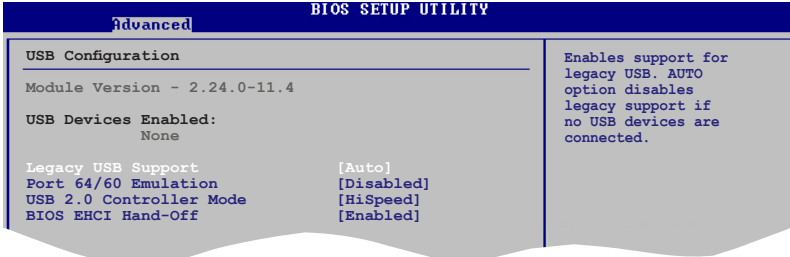

The Module Version and USB Devices Enabled items show the auto-detected values. If no USB device is detected, the item shows None.

Legacy USB Support [Auto]

Allows you to enable or disable support for USB devices on legacy operating systems (OS). Setting to Auto allows the system to detect the presence of USB devices at startup. If detected, the USB controller legacy mode is enabled. If no USB device is detected, the legacy USB support is disabled.

Configuration options: [Disabled] [Enabled] [Auto]

Port 64/60 Emulation [Disabled]

Allows you to disable or enable the I/O port 60h/64h emulation support. This should be enabled for the complete USB keyboard legacy support for non-USB aware OSes. Configuration options: [Disabled] [Enabled]

USB 2.0 Controller Mode [HiSpeed]

Allows you to configure the USB 2.0 controller in HiSpeed (480 Mbps) or Full Speed (12 Mbps). Configuration options: [FullSpeed] [HiSpeed]

BIOS EHCI Hand-Off [Enabled]

Allows you to enable support for operating systems without an EHCI hand-off feature. Configuration options: [Disabled] [Enabled]

2.4.3 TPM Configuration

The items in this menu allow you to set the TPM (Trusted Platform Module) features. Select an item then press <Enter> to display the configuration options.

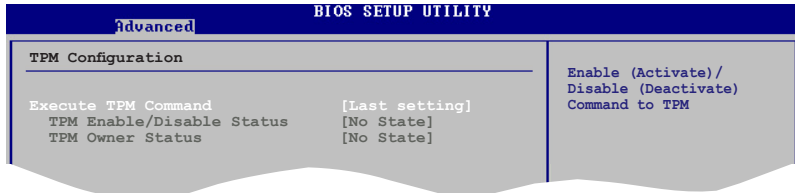

Execute TPM Command [Last setting]

Allows you to enable or disable the TPM security chip.
Configuration options: [Last setting] [Disabled] [Enabled]

TPM Enable / Disable Status [No State]

The item is not configurable.

TPM Owner Status [No State]

The item is not configurable.



To enable the TPM function, set the **Execute TPM Command** item to [Enabled] and then save the change (see "2.8 Exit menu" for details). After the system reboots, the TPM Configuration menu will change into the following one.

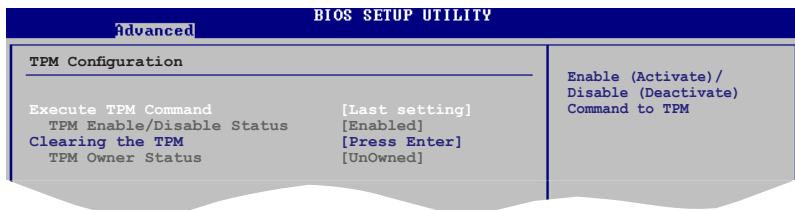

Clearing the TPM [Press Enter]

Allows you to clear the user information saved in the TPM security chip. When you press <Enter>, a warning message will appear to ask if you want to clear the user information in the security chip. Use the left/right arrow key to select between [Ok] and [Cancel], then press <Enter> to confirm your choice.



After you select [OK] to execute the **Clearing the TPM** function, the data saved in the TPM security chip will be cleared and can never be restored.

2.4.4 CPU Configuration

The items in this menu show the CPU-related information that the BIOS automatically detects.

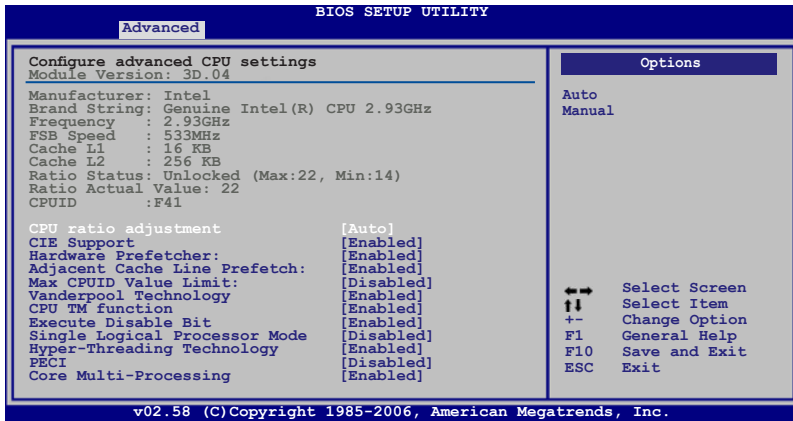

CPU ratio adjustment [Auto]

Configuration options: [Auto] [Manual]



The following item appears when the item **CPU ratio adjustment** is set to [Manual].

Ratio CMOS Setting: [xx]

Sets the ratio between CPU Core Clock and the FSB Frequency.

C1E Support [Enabled]

Allows you to enable or disable C1E Support.

Configuration options: [Enabled] [Disabled]

Hardware Prefetcher: [Enabled]

Allows you to enable or disable the Hardware Prefetcher Disable Feature.

Configuration options: [Disabled] [Enabled]

Adjacent Cache Line Prefetch: [Enabled]

Allows you to enable or disable the Adjacent Cache Line Prefetch Disable Feature.

Configuration options: [Disabled] [Enabled]

Max CPUID Value Limit [Disabled]

Setting this item to [Enabled] allows legacy operating systems to boot even without support for CPUs with extended CPUID functions.

Configuration options: [Disabled] [Enabled]

Vanderpool Technology [Enabled]

Configuration options: [Enabled] [Disabled]

CPU TM function [Enabled]

Configuration options: [Disabled] [Enabled]

Execute Disable Bit [Enabled]

Allows you to enable or disable the No-Execution Page Protection Technology. Setting this item to [Disabled] forces the XD feature flag to always return to zero (0). Configuration options: [Disabled] [Enabled]

Single Logical Processor Mode: [Disabled]

Configuration options: [Disabled] [Enabled]

Hyper-Threading Technology [Enabled]

Allows you to enable or disable the processor Hyper-Threading Technology. Configuration options: [Disabled] [Enabled]

PECI [Disabled]

Configuration options: [Disabled] [Enabled]

Core Multi-Processing [Enabled]

Configuration options: [Disabled] [Enabled]

2.4.5 Chipset

The Chipset menu allows you to change the advanced chipset settings. Select an item then press <Enter> to display the sub-menu.

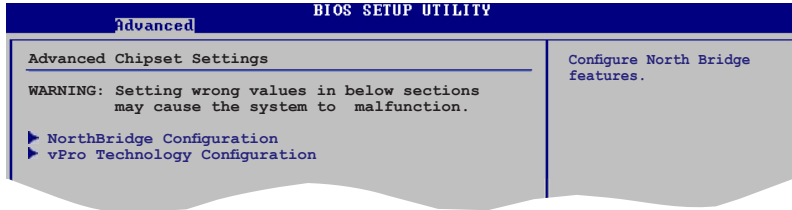

North Bridge Configuration

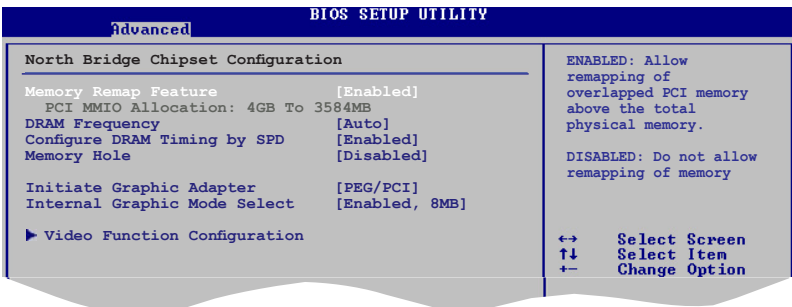

Memory Remap Feature [Enabled]

Allows you to enable or disable the remapping of the overlapped PCI memory above the total physical memory. Enable this option only when you install 64-bit operating system. Configuration options: [Disabled] [Enabled]

DRAM Frequency [Auto]

Allows you to set the DDR operating frequency.

Configuration options: [Auto] [533MHz] [667MHz] [800MHz] [1067MHz]

Configure DRAM Timing by SPD [Enabled]

When this item is enabled, the DRAM timing parameters are set according to the DRAM SPD (Serial Presence Detect). When disabled, you can manually set the DRAM timing parameters through the DRAM sub-items. The following sub-items appear when this item is set to [Disabled].

Configuration options: [Enabled] [Disabled]

DRAM CAS# Latency [5]

Controls the latency between the SDRAM read command and the time the data actually becomes available. Configuration options: [3] [4] [5] [6]

DRAM RAS# to CAS# Delay [6 DRAM Clocks]

Controls the latency between the DDR SDRAM active command and the read/write command.

Configuration options: [3 DRAM Clocks]~[6 DRAM Clocks]

DRAM RAS# Precharge [6DRAM Clocks]

Controls the idle clocks after issuing a precharge command to the DDR SDRAM. Configuration options: [3 DRAM Clocks]~[6 DRAM Clocks]

DRAM RAS# Activate to Precharge Delay [15 DRAM Clocks]

Configuration options: [9 DRAM Clocks]~[15 DRAM Clocks]

Memory Hole [Disabled]

Configuration options: [Disabled] [15MB-16MB]

Initiate Graphic Adapter [PEG/PCI]

Allows you to select the graphics controller as the primary boot device.

Configuration options: [IGD] [PCI/IGD] [PCI/PEG] [PEG/IGD] [PEG/PCI]

Internal Graphic Mode Select [Enabled, 8MB]

Allows you to select the amount of system memory used by the Internal graphics device. Configuration options: [Disabled] [Enabled, 1MB] [Enabled, 8MB]

Video Function Configuration

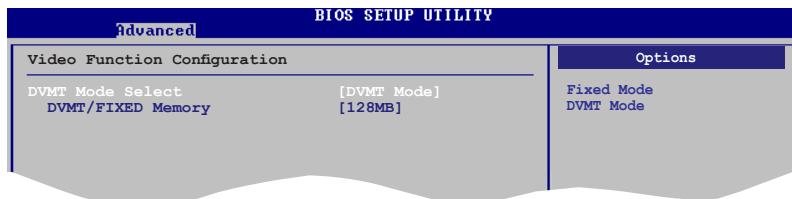

DVMT Mode Select [DVMT Mode]

Configuration options: [Fixed Mode] [DVMT Mode]

DVMT/FIXED Memory [128MB]

Configuration options: [128MB] [256MB] [Maximum DVMT]

vPro Technology Configuration

With the support of the Intel® vPro™ Technology, the items in this menu allow you to configure the Intel® Management Engine (ME) subsystem and enable the Intel® Active Management Technology. Select an item then press <Enter> to display the configuration options.



To enable the following functions, you must install the Intel® Management Engine Interface. See page 3-3 for details.

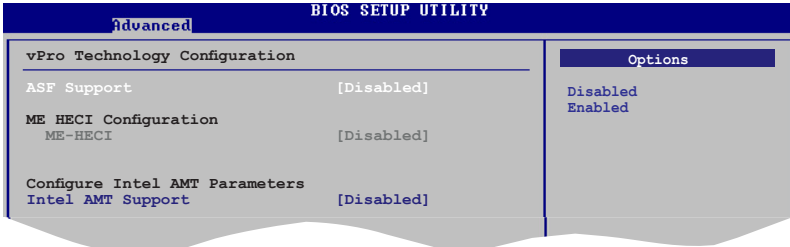

When the **Intel AMT Support** item is set to [Enabled], the vPro Technology Configuration menu will change into the following one.

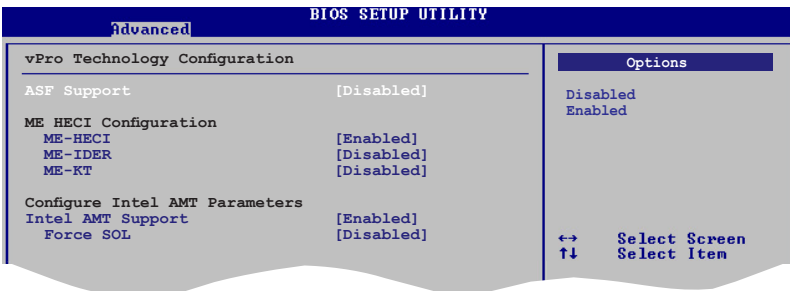

ASF Support [Disabled]

Allows you to enable or disable the Alert Standard Format (ASF).
Configuration options: [Disabled] [Enabled]

ME HECI Configuration

ME-HECI [Enabled]

When set to [Enabled], Host Embedded Communication Interface (HECI) provides an interface for the exchange of message between the host software and the ME firmware. Configuration options: [Disabled] [Enabled]

ME-IDER [Disabled]

Allows you to enable or disable the IDE Redirection interface by which the remote management console is able to direct the client PC to boot. Configuration options: [Disabled] [Enabled]

ME-KT [Disabled]

When set to [Enabled], the KT function helps redirect keyboard and POST message to the remote management console and thus facilitates the control of the client machine through the network.

Configuration options: [Disabled] [Enabled]

Configure Intel AMT Parameters

Intel AMT Support [Enabled]

Allows you to enable or disable the Intel® AMT (Active Management Technology). Configuration options: [Disabled] [Enabled]

Force SOL [Disabled]

When set to enabled, Serial Over LAN (SOL) capability allows you to remotely enter the client PC via LAN. Configuration options: [Disabled] [Enabled]



The Intel® Active Management Technology requires the Intel® AMT-enabled software. Also, the platform must be connected to a power source and an active LAN port.

2.4.6 Onboard Devices Configuration

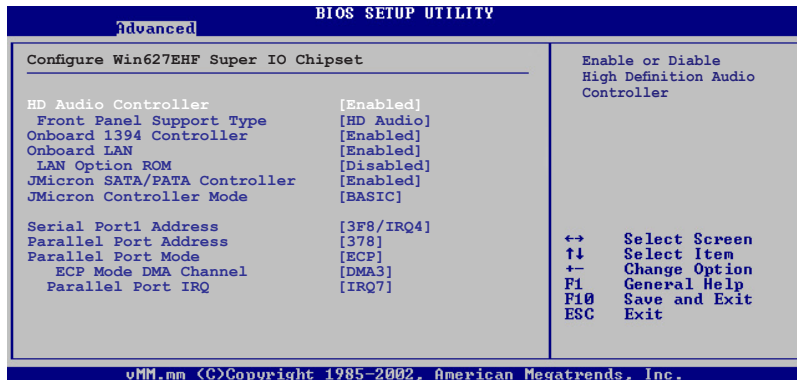

HD Audio Controller [Enabled]

Allows you to enable or disable the High Definition Audio Controller.

Configuration options: [Enabled] [Disabled]

Front Panel Support Type [HD Audio]

Allows you to set the front panel audio connector (AAFP) mode to legacy AC'97 or high-definition audio depending on the audio standard that the front panel audio module supports. Configuration options: [AC97] [HD Audio]

Onboard 1394 Cotroller [Enabled]

Allows you to enable or disable the onboard IEEE 1394 controller.

Configuration options: [Enabled] [Disabled]

Onboard LAN [Enabled]

Allows you to enable or disable the onboard LAN controller.

Configuration options: [Enabled] [Disabled]

LAN Option ROM [Disabled]

Configuration options: [Disabled] [Enabled]

JMicron SATA/PATA Controller [Enabled]

Allows you to enable or disable the JMicron SATA/PATA controller.

Configuration options: [Enabled] [Disabled]

JMicron Controller Mode [Basic]

Configuration options: [RAID] [BASIC] [AHCI]



Must load the JMB363 driver when creating RAID sets, even if all the drivers of the RAID sets are used as data drivers.

Serial Port1 Address [3F8/IRQ4]

Allows you to select the Serial Port1 base address.

Configuration options: [Disabled] [3F8/IRQ4][2F8/IRQ3] [3E8/IRQ4] [2E8/IRQ3]

Parallel Port Address [378]

Allows you to select the Parallel Port base addresses.

Configuration options: [Disabled] [378] [278] [3BC]

Parallel Port Mode [ECP]

Allows you to select the Parallel Port mode.

Configuration options: [Normal] [Bi-directional] [EPP] [ECP]

ECP Mode DMA Channel [DMA3]

Appears only when the Parallel Port Mode is set to [ECP]. This item allows you to set the Parallel Port ECP DMA.

Configuration options: [DMA0] [DMA1] [DMA3]

Parallel Port IRQ [IRQ7]

Configuration options: [IRQ5] [IRQ7]

2.4.7 PCI PnP

The PCI PnP menu items allow you to change the advanced settings for PCI/PnP devices. The menu includes setting IRQ and DMA channel resources for either PCI/PnP or legacy ISA devices, and setting the memory size block for legacy ISA devices.



Take caution when changing the settings of the PCI PnP menu items. Incorrect field values can cause the system to malfunction.

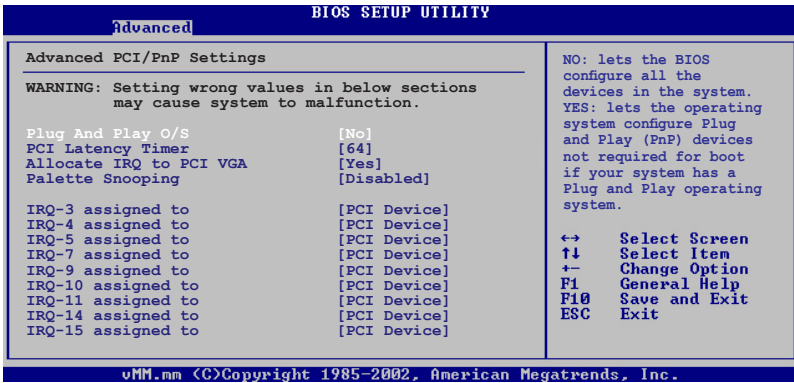

Plug and Play O/S [No]

When set to [No], BIOS configures all the devices in the system. When set to [Yes] and if you install a Plug and Play operating system, the operating system configures the Plug and Play devices not required for boot.

Configuration options: [No] [Yes]

PCI Latency Timer [64]

Allows you to select the value in units of PCI clocks for the PCI device latency timer register. Configuration options: [32] [64] [96] [128] [160] [192] [224] [248]

Allocate IRQ to PCI VGA [Yes]

When set to [Yes], BIOS assigns an IRQ to PCI VGA card if the card requests for an IRQ. When set to [No], BIOS does not assign an IRQ to the PCI VGA card even if requested. Configuration options: [Yes] [No]

Palette Snooping [Disabled]

When set to [Enabled], the palette snooping feature informs the PCI devices that an ISA graphics device is installed in the system so that the latter can function correctly. Configuration options: [Disabled] [Enabled]

IRQ-xx assigned to [PCI Device]

When set to [PCI Device], the specific IRQ is free for use of PCI/PnP devices. When set to [Reserved], the IRQ is reserved for legacy ISA devices. Configuration options: [PCI Device] [Reserved]

2.5 Power menu

The Power menu items allow you to change the settings for the Advanced Power Management (APM). Select an item then press <Enter> to display the configuration options.

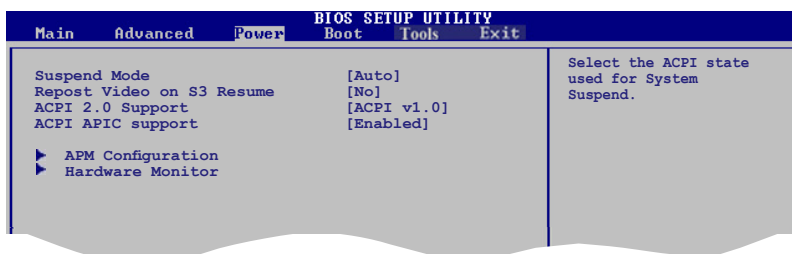

2.5.1 Suspend Mode [Auto]

Allows you to select the Advanced Configuration and Power Interface (ACPI) state to be used for system suspend. Configuration options: [S1(POS) Only] [S3 Only] [Auto]

2.5.2 Repost Video on S3 Resume [No]

Allows you to determine whether to invoke VGA BIOS POST on S3/STR resume. Configuration options: [No] [Yes]

2.5.3 ACPI 2.0 Support [ACPI v1.0]

Allows you to add more tables for Advanced Configuration and Power Interface (ACPI) 2.0 specifications. Configuration options: [ACPI v1.0] [ACPI v2.0] [ACPI v3.0]

2.5.4 ACPI APIC support [Enabled]

Allows you to enable or disable the Advanced Configuration and Power Interface (ACPI) support in the Application-Specific Integrated Circuit (ASIC). When set to Enabled, the ACPI APIC table pointer is included in the RSDT pointer list. Configuration options: [Disabled] [Enabled]

2.5.5 APM Configuration

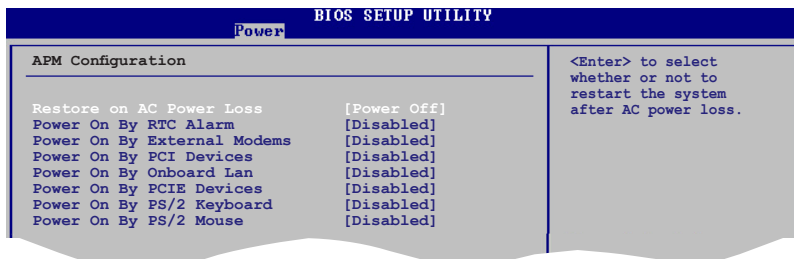

Restore on AC Power Loss [Power Off]

When set to [Power Off], the system goes into off state after an AC power loss.

When set to [Power On], the system goes on after an AC power loss. When set to [Last State], the system goes into either off or on state, whatever the system state was before the AC power loss.

Configuration options: [Power Off] [Power On] [Last State]

Power On By RTC Alarm [Disabled]

Allows you to enable or disable RTC to generate a wake event. When this item is set to [Enabled], the items RTC Alarm Date / RTC Alarm Hour / RTC Alarm Minute / RTC Alarm Second will become user-configurable with set values.

Configuration options: [Disabled] [Enabled]

Power On By External Modems [Disabled]

This allows either settings of [Enabled] or [Disabled] for powering up the computer when the external modem receives a call while the computer is in Soft-off mode.

Configuration options: [Disabled] [Enabled]



The computer cannot receive or transmit data until the computer and applications are fully running. Thus, connection cannot be made on the first try. Turning an external modem off and then back on while the computer is off causes an initialization string that turns the system power on.

Power On By PCI Devices [Disabled]

Allows you to enable or disable the PME to wake up from S5 by PCI devices.

Configuration options: [Disabled] [Enabled]

Power On By Onboard LAN [Disabled]

Allows you to enable or disable the onboard LAN to generate a wake event.

Configuration options: [Disabled] [Enabled]

Power On By PCIE Devices [Disabled]

Allows you to enable or disable the PCIE devices to generate a wake event.
Configuration options: [Disabled] [Enabled]

Power On By PS/2 Keyboard [Disabled]

Allows you to use specific keys on the keyboard to turn on the system. This feature requires an ATX power supply that provides at least 1A on the +5VSB lead.
Configuration options: [Disabled] [Space Bar] [Ctrl-Esc] [Power Key]

Power On By PS/2 Mouse [Disabled]

When set to [Enabled], this parameter allows you to use the PS/2 mouse to turn on the system. This feature requires an ATX power supply that provides at least 1A on the +5VSB lead. Configuration options: [Disabled] [Enabled]

2.5.6 Hardware Monitor

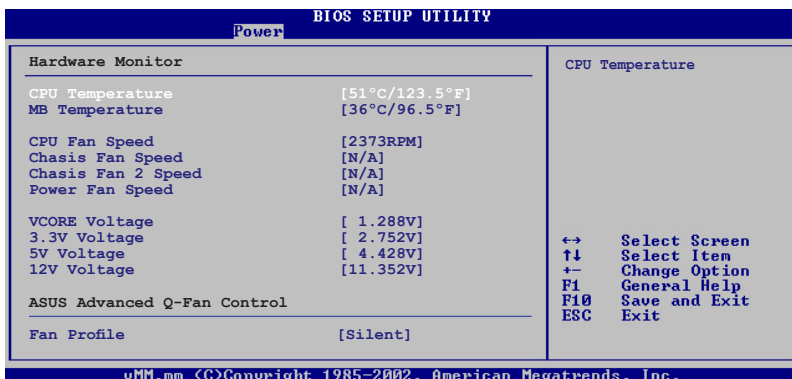

CPU Temperature [xxx°C/xxx°F]

MB Temperature [xxx°C/xxx°F]

The onboard hardware monitor automatically detects and displays the motherboard and CPU temperatures. Select [Ignored] if you do not wish to display the detected temperatures.

CPU Fan Speed [xxxxRPM] or [Ignored] / [N/A]

The onboard hardware monitor automatically detects and displays the CPU fan speed in rotations per minute (RPM). If the fan is not connected to the motherboard, the field shows N/A.

Chasis Fan/ Fan 2 Speed [xxxxRPM] or [Ignored] / [N/A]

The onboard hardware monitor automatically detects and displays the chassis fan speed in rotations per minute (RPM). If the fan is not connected to the motherboard, the field shows N/A.

Power Fan Speed [xxxxRPM] or [Ignored] / [N/A]

The onboard hardware monitor automatically detects and displays the chassis fan speed in rotations per minute (RPM). If the fan is not connected to the motherboard, the field shows N/A.

VCORE Voltage, 3.3V Voltage, 5V Voltage, 12V Voltage

The onboard hardware monitor automatically detects the voltage output through the onboard voltage regulators. Select [Ignored] if you do not wish to display these items.

ASUS Advanced Q-Fan Control [Silent]

Allows you to select the ASUS Advanced Q-Fan control.

Configuration options: [Disabled] [Performance] [Optimal] [Silent] [Ultra Silent]



The option of "Ultra Silent" is for Intel® Core™2 processors only.

2.6 Boot menu

The Boot menu items allow you to change the system boot options. Select an item then press <Enter> to display the sub-menu.

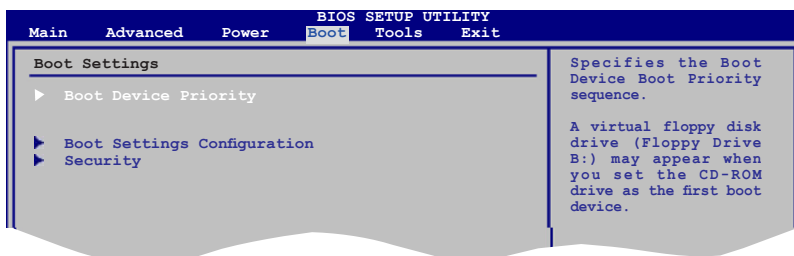

2.6.1 Boot Device Priority

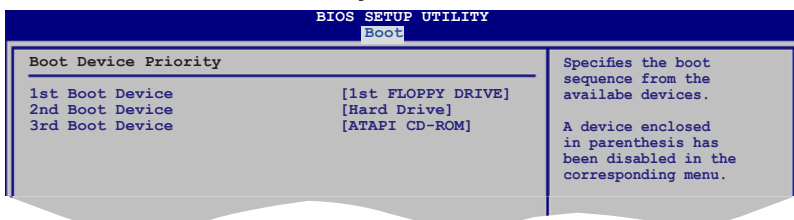

1st ~ xxth Boot Device [xxx Drive]

These items specify the boot device priority sequence from the available devices. The number of device items that appears on the screen depends on the number of devices installed in the system. Configuration options: [xxx Drive] [Disabled]

2.6.2 Boot Settings Configuration

BIOS SETUP UTILITY	
Boot	
Boot Settings Configuration	
Quick Boot	[Enabled]
Full Screen Logo	[Enabled]
AddOn ROM Display Mode	[Force BIOS]
Bootup Num-Lock	[On]
PS/2 Mouse Support	[Auto]
Wait For 'F1' If Error	[Enabled]
Hit 'DEL' Message Display	[Enabled]
Interrupt 19 Capture	[Disabled]

Allows BIOS to skip certain tests while booting. This will decrease the time needed to boot the system.

Quick Boot [Enabled]

Enabling this item allows the BIOS to skip some power on self tests (POST) while booting to decrease the time needed to boot the system. When set to [Disabled], BIOS performs all the POST items. Configuration options: [Disabled] [Enabled]

Full Screen Logo [Enabled]

This allows you to enable or disable the full screen logo display feature. Configuration options: [Disabled] [Enabled]



Set this item to [Enabled] to use the ASUS MyLogo2™ feature.

Add On ROM Display Mode [Force BIOS]

Sets the display mode for option ROM. Configuration options: [Force BIOS] [Keep Current]

Bootup Num-Lock [On]

Allows you to select the power-on state for the NumLock. Configuration options: [Off] [On]

PS/2 Mouse Support [Auto]

Allows you to enable or disable support for PS/2 mouse. Configuration options: [Disabled] [Enabled] [Auto]

Wait for 'F1' If Error [Enabled]

When set to Enabled, the system waits for the F1 key to be pressed when error occurs. Configuration options: [Disabled] [Enabled]

Hit 'DEL' Message Display [Enabled]

When set to Enabled, the system displays the message "Press DEL to run Setup" during POST. Configuration options: [Disabled] [Enabled]

Interrupt 19 Capture [Disabled]

When set to [Enabled], this function allows the option ROMs to trap Interrupt 19. Configuration options: [Disabled] [Enabled]

2.6.3 Security

The Security menu items allow you to change the system security settings. Select an item then press <Enter> to display the configuration options.

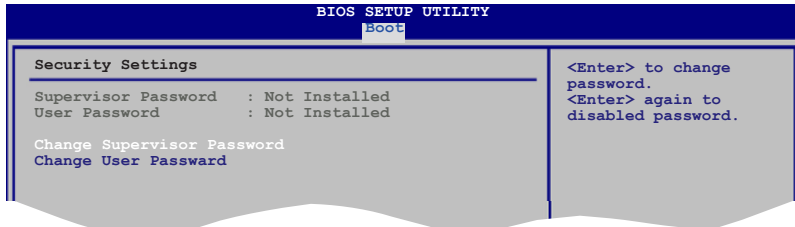

Change Supervisor Password

Select this item to set or change the supervisor password. The Supervisor Password item on top of the screen shows the default Not Installed. After you set a password, this item shows Installed.

To set a Supervisor Password:

1. Select the Change Supervisor Password item and press <Enter>.
2. From the password box, type a password composed of at least six letters and/or numbers, then press <Enter>.
3. Confirm the password when prompted.

The message "Password Installed" appears after you successfully set your password.

To change the supervisor password, follow the same steps as in setting a user password.

To clear the supervisor password, select the Change Supervisor Password then press <Enter>. The message "Password Uninstalled" appears.



If you forget your BIOS password, you can clear it by erasing the CMOS Real Time Clock (RTC) RAM. See section "1.9 Jumpers" for information on how to erase the RTC RAM.

After you have set a supervisor password, the other items appear to allow you to change other security settings.

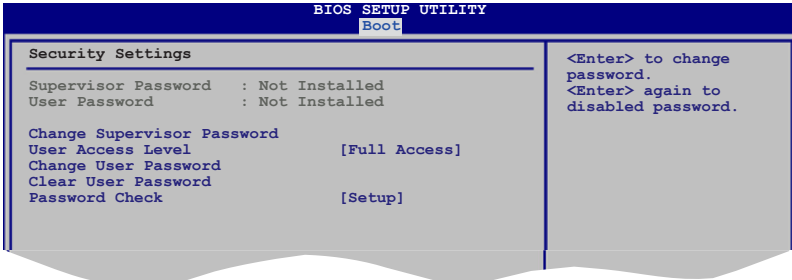

User Access Level [Full Access]

This item allows you to select the access restriction to the Setup items.
Configuration options: [No Access] [View Only] [Limited] [Full Access]

No Access prevents user access to the Setup utility.

View Only allows access but does not allow change to any field.

Limited allows changes only to selected fields, such as Date and Time.

Full Access allows viewing and changing all the fields in the Setup utility.

Change User Password

Select this item to set or change the user password. The User Password item on top of the screen shows the default Not Installed. After you set a password, this item shows Installed.

To set a User Password:

1. Select the Change User Password item and press <Enter>.
2. On the password box that appears, type a password composed of at least six letters and/or numbers, then press <Enter>.
3. Confirm the password when prompted.

The message "Password Installed" appears after you set your password successfully.

To change the user password, follow the same steps as in setting a user password.

Clear User Password

Select this item to clear the user password.

Password Check [Setup]

When set to [Setup], BIOS checks for user password when accessing the Setup utility. When set to [Always], BIOS checks for user password both when accessing Setup and booting the system. Configuration options: [Setup] [Always]

2.7 Tools menu

The Tools menu items allow you to configure options for special functions. Select an item then press <Enter> to display the sub-menu.



2.7.1 ASUS EZ Flash 2

Allows you to run ASUS EZ Flash 2. When you press <Enter>, a confirmation message appears. Use the left/right arrow key to select between [Yes] or [No], then press <Enter> to confirm your choice. Please see page 2-3, section 2.1.2 for details.

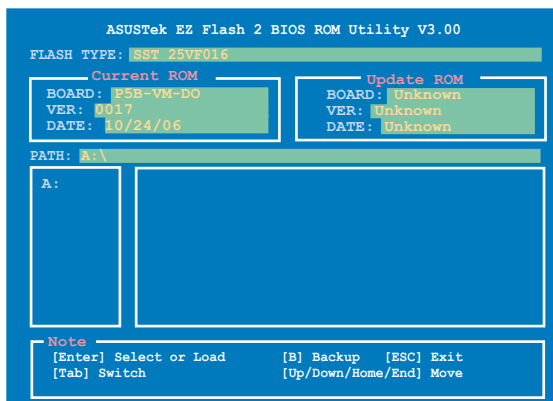

2.8 Exit menu

The Exit menu items allow you to load the optimal or failsafe default values for the BIOS items, and save or discard your changes to the BIOS items.

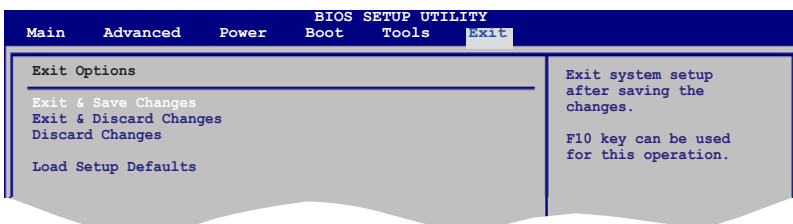

Pressing <Esc> does not immediately exit this menu. Select one of the options from this menu or <F10> from the legend bar to exit.

Exit & Save Changes

Once you are finished making your selections, choose this option from the Exit menu to ensure the values you selected are saved to the CMOS RAM. An onboard backup battery sustains the CMOS RAM so it stays on even when the PC is turned off. When you select this option, a confirmation window appears. Select **OK** to save changes and exit.



If you attempt to exit the Setup program without saving your changes, the program prompts you with a message asking if you want to save your changes before exiting. Press <Enter> to save the changes while exiting.

Exit & Discard Changes

Select this option only if you do not want to save the changes that you made to the Setup program. If you made changes to fields other than System Date, System Time, and Password, the BIOS asks for a confirmation before exiting.

Discard Changes

This option allows you to discard the selections you made and restore the previously saved values. After selecting this option, a confirmation appears. Select **OK** to discard any changes and load the previously saved values.

Load Setup Defaults

This option allows you to load the default values for each of the parameters on the Setup menus. When you select this option or if you press <F5>, a confirmation window appears. Select **OK** to load default values. Select **Exit & Save Changes** or make other changes before saving the values to the non-volatile RAM.

This chapter describes the contents of the support CD that comes with the motherboard package.

3 Software support

3.1 Installing an operating system

This motherboard supports Windows® 2000/XP/64-bit XP operating systems (OS). Always install the latest OS version and corresponding updates to maximize the features of your hardware.



- Motherboard settings and hardware options vary. Use the setup procedures presented in this chapter for reference only. Refer to your OS documentation for detailed information.
- Make sure that you install Windows® 2000 Service Pack 4 or the Windows® XP Service Pack2 or later versions before installing the drivers for better compatibility and system stability.

3.2 Support CD information

The support CD that came with the motherboard package contains the drivers, software applications, and utilities that you can install to avail all motherboard features.



The contents of the support CD are subject to change at any time without notice. Visit the ASUS website(www.asus.com) for updates.

3.2.1 Running the support CD

Place the support CD to the optical drive. The CD automatically displays the Drivers menu if Autorun is enabled in your computer.



Click an icon to display support CD/motherboard information

Click an item to install



If Autorun is NOT enabled in your computer, browse the contents of the support CD to locate the file ASSETUP.EXE from the BIN folder. Double-click the ASSETUP.EXE to run the CD.

3.2.2 Drivers menu

The drivers menu shows the available device drivers if the system detects installed devices. Install the necessary drivers to activate the devices.



ASUS InstAll-Drivers Installation Wizard

Installs the ASUS InstAll-Drivers installation wizard.

Intel Chipset Inf Update Program

Installs the Intel® chipset inf update program.

Intel Graphics Accelerator Driver

Installs the Intel® graphics accelerator driver.

SoundMAX AD1988A Audio Driver

Installs the SoundMAX® AD1988A audio driver and application.

JMicron JMB36X RAID Controller Driver

Installs the JMicron® JMB36X Serial ATA RAID controller driver.

Intel(R) Ethernet Driver

Installs the Intel® ethernet driver.

Intel(R) Management Engine Interface

Installs the Intel® management engine interface.

USB 2.0 Driver

Installs the USB 2.0 driver.

3.2.3 Utilities menu

The Utilities menu shows the applications and other software that the motherboard supports.

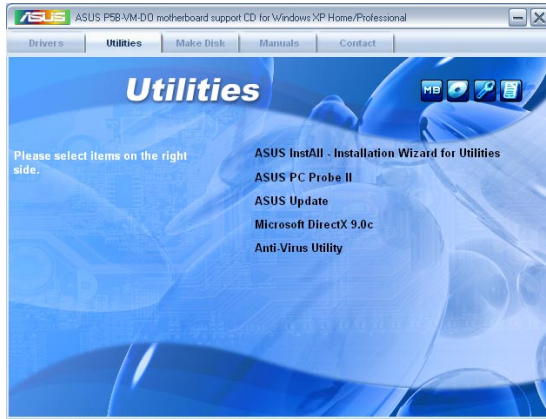

ASUS InstAll-Installation Wizard for Utilities

Install the ASUS InstAll-Installation Wizard.

ASUS PC Probe II

This smart utility monitors the fan speed, CPU temperature, and system voltages, and alerts you of any detected problems. This utility helps you keep your computer in healthy operating condition.

ASUS Update

The ASUS Update utility allows you to update the motherboard BIOS in Windows® environment. This utility requires an Internet connection either through a network or an Internet Service Provider (ISP)

Microsoft DirectX 9.0c

Installs the Microsoft® DirectX 9.0c driver. The Microsoft DirectX® 9.0c is a multimedia technology that enhances computer graphics and sound. DirectX® improves the multimedia features of your computer so you can enjoy watching TV and movies, capturing videos, or playing games in your computer. Visit the Microsoft website (www.microsoft.com) for updates.

Anti-Virus Utility

The anti-virus application scans, identifies, and removes computer viruses. View the online help for detailed information.

3.2.4 Make Disk menu

The Make Disk menu contains items to create JMicron® JMB36X or Intel® ICH8 RAID/AHCI driver disk.

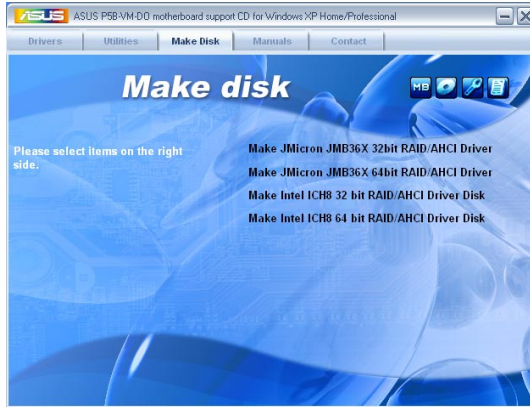

Make JMicron JMB36X 32/64bit RAID/AHCI Driver

Allows you to create a JMicron® JMB36X 32/64bit RAID/AHCI driver.

Make Intel® ICH8 32/64bit RAID/AHCI Driver

Allows you to create a Intel® ICH8 32/64bit RAID/AHCI driver disk.

3.2.5 Manuals menu

The Manuals menu contains a list of supplementary user manuals. Click an item to open the folder of the user manual.



Most user manual files are in Portable Document Format (PDF). Download the Adobe® Acrobat® Reader from www.adobe.com if you do not have one.

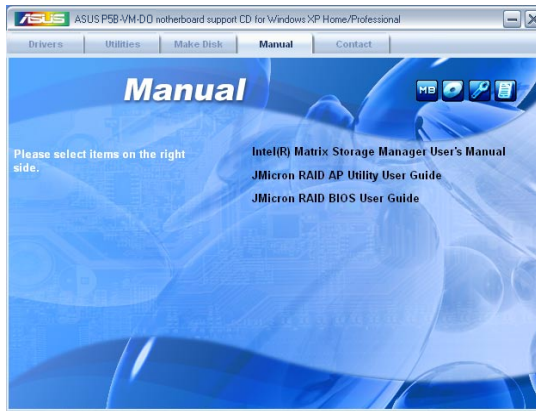

3.2.6 ASUS Contact information

Click the Contact tab to display the ASUS contact information. You can also find this information on the inside front cover of this user guide.

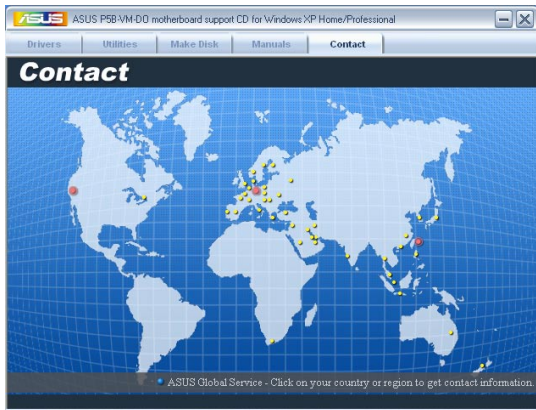

3.2.7 Other information

The icons on the top right corner of the screen give additional information on the motherboard and the contents of the support CD. Click an icon to display the specified information.

Motherboard Info

Displays the general specifications of the motherboard.

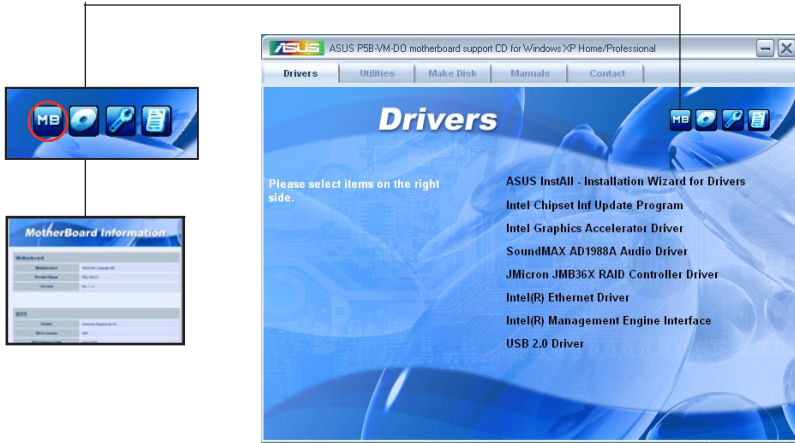

Browse this CD

Displays the support CD contents in graphical format.

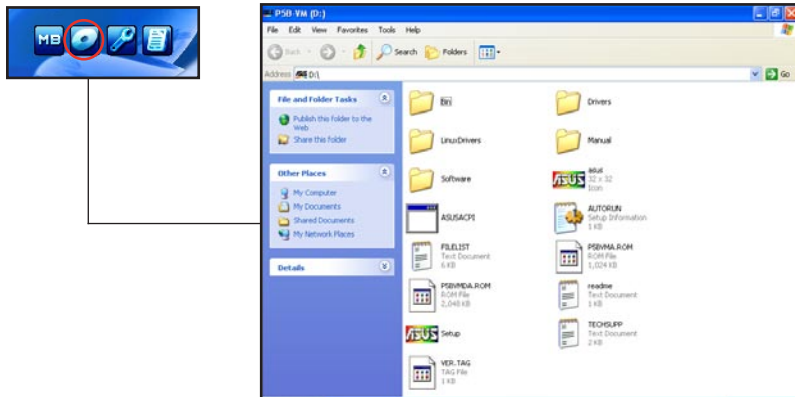

Technical support form

Displays the ASUS Technical Support Request Form that you have to fill out when requesting technical support.



ASUSTeK TECHNICAL SUPPORT REQUEST FORM

COMPANY NAME : _____ DATE: _____
ORIGINATOR DESCRIPTION: _____
PHONE (AREA) : _____ CONTACT NAME: _____
FAX # (AREA): _____
EMAIL ADDRESS: _____

HARDWARE DESCRIPTION

MOTHERBOARD :	REVISION #1:	BIOS:#402AA-
CPU BRAND :	SPEED(MHz):	
DRAM BRAND :	SPEED(M/s) :	SIZE(MB):
CACHE BRAND :	SPEED(M/s) :	SIZE(KB):
HARD DISK :	MODEL NAME:	SIZE(MB):
CDROM BRAND :	MODEL NAME:	SIZE(MB):
BACKUP BRAND :	MODEL NAME:	SIZE(MB):
OTHER STORAGE:		

ADD-IN CARD DESCRIPTION (MODEL NAME/VENDOR)

(E)ISA SLOT 1:	
(E)ISA SLOT 2:	
(E)ISA SLOT 3:	
(E)ISA SLOT 4:	
PCI-E SLOT 1:	
PCI-E SLOT 2:	
PCI-E SLOT 3:	
PCI SLOT 1:	
PCI SLOT 2:	
PCI SLOT 3:	
PCI SLOT 4:	
PCI SLOT 5:	

SOFTWARE DESCRIPTION

OPERATING SYSTEM: _____
APPLICATION SOFTWARE: _____

Filelist

Displays the contents of the support CD and a brief description of each in text format.



File list for the included support software for P5B-W motherboard

File Name	Description
-Drivers	
-Chipset	
-INF	-Intel(R) Chipset Software Installation Utility v8.0.1.1002 for windows 2000
-I8M	-Intel(R) Matrix Storage Manager driver v6.0.0.1022 for windows 2000/XP/2003
-vista	-Intel(R) Matrix Storage Manager driver v6.2.0.1009 for windows Vista.
-MakeDisk	-Make Intel ICH8 RAID Driver Disk for windows 2000/XP/2003 & 64bit XP/2003.
-vfw	
-quickresume	-Intel(R) quick resume technology driver v1.5.0.1026 for windows XP MCE 2005
-vfwsoftware	-Intel(R) Vfw(TM) software v1.5.147.13 for windows XP MCE 2005.
-VGA	
-32bit	-Intel(R) graphics Media Accelerator driver v8.14.10.4670 for windows 2000/XP
-64bit	-Intel(R) graphics Media Accelerator driver v8.14.10.4662 for windows 64bit windows
-Audio	
-32bit	-SoundMAX AD1988A Audio driver v5.10.01.4530 WHQL for windows 2000/XP/2003.
-64bit	-SoundMAX AD1988A Audio driver v5.10.01.4530 WHQL for windows 64bit XP/2003.
-vista	-SoundMAX AD1988A Audio driver v5.10.01.4560 for windows 32bit vista.
-LAN	
-Realtek	-Realtek RTL8111B 10/100/1000M LAN driver v5.618.0814.2006 for windows 2000/XP/2003
-Intel	-Intel(R) Ethernet driver v9.4.17.0 for windows 2000/XP/2003 and 64bit XP/2003
-RAID	
-3MB363	-3Micon 3MB36X RAID Controller driver v1.13.6.0 for windows 2000/XP/2003 an
-vista	-3Micon 3MB36X RAID Controller driver V1.15.1.0 (R1.15.02)for windows Vista
-Manual	
-3MB363	