

**M2N-LR
Series**

ASUS[®]

Motherboard

E2804

First Edition
September 2006

Copyright © 2006 ASUSTeK COMPUTER INC. All Rights Reserved.

No part of this manual, including the products and software described in it, may be reproduced, transmitted, transcribed, stored in a retrieval system, or translated into any language in any form or by any means, except documentation kept by the purchaser for backup purposes, without the express written permission of ASUSTeK COMPUTER INC. ("ASUS").

Product warranty or service will not be extended if: (1) the product is repaired, modified or altered, unless such repair, modification or alteration is authorized in writing by ASUS; or (2) the serial number of the product is defaced or missing.

ASUS PROVIDES THIS MANUAL "AS IS" WITHOUT WARRANTY OF ANY KIND, EITHER EXPRESS OR IMPLIED, INCLUDING BUT NOT LIMITED TO THE IMPLIED WARRANTIES OR CONDITIONS OF MERCHANTABILITY OR FITNESS FOR A PARTICULAR PURPOSE. IN NO EVENT SHALL ASUS, ITS DIRECTORS, OFFICERS, EMPLOYEES OR AGENTS BE LIABLE FOR ANY INDIRECT, SPECIAL, INCIDENTAL, OR CONSEQUENTIAL DAMAGES (INCLUDING DAMAGES FOR LOSS OF PROFITS, LOSS OF BUSINESS, LOSS OF USE OR DATA, INTERRUPTION OF BUSINESS AND THE LIKE), EVEN IF ASUS HAS BEEN ADVISED OF THE POSSIBILITY OF SUCH DAMAGES ARISING FROM ANY DEFECT OR ERROR IN THIS MANUAL OR PRODUCT.

SPECIFICATIONS AND INFORMATION CONTAINED IN THIS MANUAL ARE FURNISHED FOR INFORMATIONAL USE ONLY, AND ARE SUBJECT TO CHANGE AT ANY TIME WITHOUT NOTICE, AND SHOULD NOT BE CONSTRUED AS A COMMITMENT BY ASUS. ASUS ASSUMES NO RESPONSIBILITY OR LIABILITY FOR ANY ERRORS OR INACCURACIES THAT MAY APPEAR IN THIS MANUAL, INCLUDING THE PRODUCTS AND SOFTWARE DESCRIBED IN IT.

Products and corporate names appearing in this manual may or may not be registered trademarks or copyrights of their respective companies, and are used only for identification or explanation and to the owners' benefit, without intent to infringe.

Contents

Notices.....	vi
Safety information	vii
About this guide	viii
M2N-LR specifications summary	x

Chapter 1: Product introduction

1.1	Welcome!	1-1
1.2	Package contents.....	1-1
1.3	Special features.....	1-2
1.3.1	Product highlights	1-2
1.3.2	ASUS Special features	1-4

Chapter 2: Hardware information

2.1	Before you proceed	2-1
	Onboard LED	2-1
2.2	Motherboard overview.....	2-2
2.2.1	Placement direction	2-2
2.2.2	Screw holes	2-2
2.2.3	Motherboard layout.....	2-3
2.2.4	Layout contents.....	2-5
2.3	Central Processing Unit (CPU)	2-7
2.3.1	Installing the CPU	2-7
2.3.2	Installing the heatsink and fan	2-9
2.4	System memory	2-12
2.4.1	Overview	2-12
2.4.2	Memory configurations.....	2-12
2.4.3	Installing a DIMM	2-13
2.4.4	Removing a DIMM	2-13
2.5	Expansion slots.....	2-14
2.5.1	Installing an expansion card	2-14
2.5.2	Configuring an expansion card	2-14
2.5.3	Interrupt assignments	2-15
2.5.4	PCI Express x16 slot.....	2-15
2.5.5	PCI slot	2-16
2.5.6	ZCR slot.....	2-16

Contents

2.6	Jumpers	2-17
2.7	Connectors	2-21
2.7.1	Rear panel connectors.....	2-21
2.7.2	Internal connectors	2-22

Chapter 3: Powering up

3.1	Starting up for the first time.....	3-1
3.2	Powering off the computer.....	3-2
3.2.1	Using the OS shut down function.....	3-2
3.2.2	Using the dual function power switch.....	3-2

Chapter 4: BIOS setup

4.1	Managing and updating your BIOS	4-1
4.1.1	Creating a bootable floppy disk.....	4-1
4.1.2	AFUDOS utility.....	4-2
4.1.3	ASUS CrashFree BIOS 2 Utility.....	4-5
4.1.4	ASUS Update utility	4-7
4.2	BIOS setup program	4-10
4.2.1	BIOS menu screen.....	4-11
4.2.2	Menu bar.....	4-11
4.2.3	Navigation keys.....	4-12
4.2.4	Menu items	4-12
4.2.5	Sub-menu items.....	4-12
4.2.6	Configuration fields	4-12
4.2.7	Pop-up window	4-12
4.2.8	General help	4-12
4.3	Main menu	4-13
4.3.1	System Time	4-13
4.3.2	System Date	4-13
4.3.3	Legacy Diskette A	4-13
4.3.4	Primary IDE Master/SATA.....	4-14
4.3.5	IDE Configuration.....	4-15
4.3.6	System Information	4-17

Contents

4.4	Advanced menu	4-18
4.4.1	CPU Configuration	4-18
4.4.2	Chipset	4-19
4.4.3	Onboard Device Configuration.....	4-24
4.4.4	PCI PnP	4-26
4.4.5	MPS Configuration.....	4-27
4.4.6	USB Configuration	4-27
4.4.7	Remote Access Configuration.....	4-29
4.5	Power menu.....	4-31
4.5.1	ACPI APIC Support.....	4-31
4.5.2	ACPI MCFG Support	4-31
4.5.3	APM Configuration.....	4-32
4.5.4	Hardware Monitor	4-33
4.6	Boot menu	4-35
4.6.1	Boot Device Priority	4-35
4.6.2	Boot Settings Configuration	4-36
4.6.3	Security	4-37
4.7	Exit menu	4-39

Chapter 5: Software support

5.1	Installing an operating system	5-1
5.2	Support CD information	5-1
5.2.1	Running the support CD	5-1
5.2.2	Drivers menu.....	5-2
5.2.3	Management Software menu.....	5-3
5.2.4	Utilities menu	5-4
5.2.5	ASUS Contact information.....	5-5
5.2.6	Other information	5-5
5.3	Software information	5-7
5.3.1	Cool 'n' Quiet!™ Technology.....	5-7
5.4	RAID configurations	5-9
5.4.1	Installing hard disks	5-10
5.4.2	NVIDIA® MediaShield RAID configurations.....	5-11
5.5	Creating a RAID driver disk.....	5-18

Notices

Federal Communications Commission Statement

This device complies with Part 15 of the FCC Rules. Operation is subject to the following two conditions:

- This device may not cause harmful interference, and
- This device must accept any interference received including interference that may cause undesired operation.

This equipment has been tested and found to comply with the limits for a Class B digital device, pursuant to Part 15 of the FCC Rules. These limits are designed to provide reasonable protection against harmful interference in a residential installation. This equipment generates, uses and can radiate radio frequency energy and, if not installed and used in accordance with manufacturer's instructions, may cause harmful interference to radio communications. However, there is no guarantee that interference will not occur in a particular installation. If this equipment does cause harmful interference to radio or television reception, which can be determined by turning the equipment off and on, the user is encouraged to try to correct the interference by one or more of the following measures:

- Reorient or relocate the receiving antenna.
- Increase the separation between the equipment and receiver.
- Connect the equipment to an outlet on a circuit different from that to which the receiver is connected.
- Consult the dealer or an experienced radio/TV technician for help.



The use of shielded cables for connection of the monitor to the graphics card is required to assure compliance with FCC regulations. Changes or modifications to this unit not expressly approved by the party responsible for compliance could void the user's authority to operate this equipment.

Canadian Department of Communications Statement

This digital apparatus does not exceed the Class B limits for radio noise emissions from digital apparatus set out in the Radio Interference Regulations of the Canadian Department of Communications.

This class B digital apparatus complies with Canadian ICES-003.

Safety information

Electrical safety

- To prevent electrical shock hazard, disconnect the power cable from the electrical outlet before relocating the system.
- When adding or removing devices to or from the system, ensure that the power cables for the devices are unplugged before the signal cables are connected. If possible, disconnect all power cables from the existing system before you add a device.
- Before connecting or removing signal cables from the motherboard, ensure that all power cables are unplugged.
- Seek professional assistance before using an adapter or extension cord. These devices could interrupt the grounding circuit.
- Make sure that your power supply is set to the correct voltage in your area. If you are not sure about the voltage of the electrical outlet you are using, contact your local power company.
- If the power supply is broken, do not try to fix it by yourself. Contact a qualified service technician or your retailer.

Operation safety

- Before installing the motherboard and adding devices on it, carefully read all the manuals that came with the package.
- Before using the product, make sure all cables are correctly connected and the power cables are not damaged. If you detect any damage, contact your dealer immediately.
- To avoid short circuits, keep paper clips, screws, and staples away from connectors, slots, sockets and circuitry.
- Avoid dust, humidity, and temperature extremes. Do not place the product in any area where it may become wet.
- Place the product on a stable surface.
- If you encounter technical problems with the product, contact a qualified service technician or your retailer.



This symbol of the crossed out wheeled bin indicates that the product (electrical and electronic equipment) should not be placed in municipal waste. Check local regulations for disposal of electronic products.

About this guide

This user guide contains the information you need when installing and configuring the motherboard.

How this guide is organized

This guide contains the following parts:

- **Chapter 1: Product introduction**
This chapter describes the features of the motherboard and the new technology it supports.
- **Chapter 2: Hardware information**
This chapter lists the hardware setup procedures that you have to perform when installing system components. It includes description of the switches, jumpers, and connectors on the motherboard.
- **Chapter 3: Powering up**
This chapter describes the power up sequence and ways of shutting down the system.
- **Chapter 4: BIOS setup**
This chapter tells how to change system settings through the BIOS Setup menus. Detailed descriptions of the BIOS parameters are also provided.
- **Chapter 5: Software support**
This chapter describes the contents of the support CD that comes with the motherboard package.

Where to find more information

Refer to the following sources for additional information and for product and software updates.

1. **ASUS websites**
The ASUS website provides updated information on ASUS hardware and software products. Refer to the ASUS contact information.
2. **Optional documentation**
Your product package may include optional documentation, such as warranty flyers, that may have been added by your dealer. These documents are not part of the standard package.

Conventions used in this guide

To make sure that you perform certain tasks properly, take note of the following symbols used throughout this manual.



DANGER/WARNING: Information to prevent injury to yourself when trying to complete a task.



CAUTION: Information to prevent damage to the components when trying to complete a task.



IMPORTANT: Instructions that you **MUST** follow to complete a task.



NOTE: Tips and additional information to help you complete a task.

Typography

Bold text

Indicates a menu or an item to select.

Italics

Used to emphasize a word or a phrase.

<Key>

Keys enclosed in the less-than and greater-than sign means that you must press the enclosed key.

Example: <Enter> means that you must press the Enter or Return key.

<Key1>+<Key2>+<Key3>

If you must press two or more keys simultaneously, the key names are connected with a plus sign (+).

Example: <Ctrl>+<Alt>+<D>

Command

Means that you must type the command exactly as shown.

Example: At the DOS prompt, type the command line:

format a:

M2N-LR specifications summary

CPU	Socket AM2 for AMD Athlon™ 64 X2 /AMD Athlon™ 64 /AMD Athlon™ 64 FX/AMD Sempron™/AMD Opteron™ 64 X2 processors Supports AMD Cool 'n' Quiet™ Technology AMD64 architecture enables simultaneous 32-bit and 64-bit computing AMD Live!™ ready
Chipset	NVIDIA® nForce™ 570 SLI MCP (MCP55P)
System bus	2000 MT per second
Memory	Dual-channel memory architecture 4 x 240-pin DIMM sockets support unbuffered/ECC DDR2 800/667/533/400 MHz memory modules Supports up to 8 GB system memory
Expansion slots	1 x PCI Express™ x16 slots (x16 Link) 1 x PCI slot (33MHz/32-bit/3.3V) 2 x PCI-X slots
Storage	MCP55P supports: <ul style="list-style-type: none"> - 1 x IDE connector for up to two Ultra DMA 300/150/133/100 devices - 6 x Serial ATA 3.0 Gb/s connectors support six Serial ATA devices - RAID 0, RAID 1, RAID 5, RAID 10, and JBOD configurations spanning - RAID 0, RAID 1, RAID 10, RAID 5, and JBOD supported across Serial ATA drives via the onboard NVIDIA® MediaShield™ RAID controller Adaptec® AIC-8130 PCI-X SATA-II controller supports: <ul style="list-style-type: none"> - 4 x SATA-II 3Gb/s drives with RAID 0, RAID 1, RAID 10, and JBOD configurations - Zero-Channel RAID card (optional)
USB	2 x USB 2.0 ports (on the rear panel) 6 x USB 2.0 ports (mid-board)
DUAL LAN	Dual Onboard BCM5721 Gigabit PCI-E LAN controllers

(continued on the next page)

M2N-LR specifications summary

Internal connectors	<ul style="list-style-type: none"> 3 x USB 2.0 connectors support six additional USB 2.0 ports 1 x Floppy disk drive connector 1 x IDE connector for two devices 6 x Serial ATA connectors 10 x Serial ATA connectors (<i>M2N-LR/SATA model only</i>) 2 x CPU fan connectors 2 x Front fan connectors 2 x Rear fan connectors 1 x 24-pin ATX power connector 1 x 4-pin ATX 12 V power connector 1 x Power supply SMBus connector 1 x Serial port (COM2) 1 x SMBus header for back-plane 1 x auxiliary panel connector 1 x system panel connector
Rear panel	<ul style="list-style-type: none"> 1 x PS/2 keyboard port 1 x PS/2 mouse port 1 x Serial port (COM1) 2 x LAN (RJ-45) ports USB 2.0/1.1 ports 1 x Parallel port (LPT1) 1 x VGA port
Special features	<ul style="list-style-type: none"> ASUS CrashFree BIOS 2 (boot from CD-ROM) ASUS MyLogo2 ASUS EZ Flash
BIOS features	8 MB AMI BIOS, PnP, DMI 2.0, WfM2.0, SM BIOS 2.3
Manageability	WOL by PME, WOR by PME, Chassis intrusion, PXE
Power requirement	ATX power supply with 24-pin and 4-pin 12V plugs ATX 12V 2.0 compliant
Support CD contents	<ul style="list-style-type: none"> Device drivers ASUS Update Utility ASUS Server Web-Based Management (ASWM)
Form factor	ATX form factor: 12 in x 9.6 in (30.5 cm x 24.5 cm)

*Specifications are subject to change without notice.

This chapter describes the motherboard features and the new technologies it supports.

1 Product introduction

Chapter summary



- 1.1 Welcome! 1-1
- 1.2 Package contents..... 1-1
- 1.3 Special features..... 1-2

1.1 Welcome!

Thank you for buying an **ASUS® M2N-LR Series motherboard!**

The motherboard delivers a host of new features and latest technologies, making it another standout in the long line of ASUS quality motherboards!

Before you start installing the motherboard, and hardware devices on it, check the items in your package with the list below.

1.2 Package contents

Check your motherboard package for the following items.

Motherboard	ASUS M2N-LR Series motherboard
Cables	1 x Ultra DMA 133/100/66 cable 1 x Floppy disk drive cable <i>M2N-LR model:</i> 3 x Serial ATA power cables for six devices <i>M2N-LR/SATA model:</i> 5 x Serial ATA power cables for six devices
Accessories	I/O shield
Application CD	ASUS motherboard support CD
Documentation	User guide



If any of the above items is damaged or missing, contact your retailer.

1.3 Special features

1.3.1 Product highlights

Latest processor technology



The motherboard comes with a 940-pin AM2 socket that supports AMD Athlon™ 64 X2/AMD Athlon™ 64/AMD Athlon™ 64 FX/AMD Sempron™/AMD Opteron™ 64 X2 processors. With an integrated low-latency high-bandwidth memory controller and a highly scalable HyperTransport™ technology-based system bus, the motherboard provides a powerful platform for your diverse computing needs, increased office productivity, and enhanced digital media experience.

DDR2 memory support



The motherboard supports DDR2 memory that features data transfer rates of 800/667/533 MHz to meet the higher bandwidth requirements of the latest 3D graphics, multimedia, and Internet applications. The dual-channel DDR2 architecture doubles the bandwidth of your system memory to boost system performance, eliminating bottlenecks with peak bandwidths of up to 12.8 GB/s.

PCI Express™ interface



The motherboard fully supports PCI Express, the latest I/O interconnect technology that speeds up the PCI bus. PCI Express features point-to-point serial interconnections between devices and allows higher clockspeeds by carrying data in packets. This high speed interface is software compatible with existing PCI specifications.

Dual RAID solution



Onboard RAID controllers provide the motherboard with dual-RAID functionality that allows you to select the best RAID solution using IDE or Serial ATA devices.

The NVIDIA® nForce™ 570 SLI MCP (MCP55P) chipset allows RAID 0, RAID 1, RAID 5, RAID 10, and JBOD configurations for six SATA.

Serial ATA 3Gb/s technology



The motherboard supports the next-generation Serial ATA II 3.0 Gb/s technology through the Serial ATA interfaces and the NVIDIA® nForce™ 570 SLI MCP (MCP55P) chipset. The Serial ATA 3Gb/s specification provides twice the bandwidth of the current Serial ATA products. Additionally, Serial ATA allows for thinner, more flexible cables with lower pin count and reduced voltage required.

Zero Channel RAID (ZCR) solution (*M2N-LR/SATA model only*)

The motherboard supports the optional Zero Channel RAID card in PCI-X for a multi-RAID solution using Serial ATA 300 hard disk drives. The RAID 0 (striping), RAID 1 (mirroring), RAID 10, RAID 5, and JBOD provide a cost-effective, reliable and high-performance server system.

Dual RAID solution (*M2N-LR/SATA model only*)

Onboard RAID controllers provide the motherboard with dual-RAID functionality that allows you to select the best RAID solution using IDE or Serial ATA devices.

The NVIDIA® CK8-04 SLI allows RAID 0, RAID 1, RAID 0+1, JBOD, and RAID 5 configuration for four SATA.

The AIC 8130 controller supports four additional SATA connectors and allows RAID 0, RAID 1, RAID 10, and JBOD.

USB 2.0 technology

The motherboard implements the Universal Serial Bus (USB) 2.0 specification, dramatically increasing the connection speed from the 12 Mbps bandwidth on USB 1.1 to a fast 480 Mbps on USB 2.0. USB 2.0 is backward compatible with USB 1.1.



Dual Gigabit LAN solution

The motherboard comes with dual Gigabit LAN controllers to provide the total solution for your networking needs. These network controllers use the PCI Express segment to provide faster data bandwidth for your wired or wireless Internet, LAN, and file sharing requirements.

AMD Cool 'n' Quiet Technology

The motherboard supports the AMD Cool 'n' Quiet Technology, which monitors system operation and automatically adjusts CPU voltage and frequency for a cool and quiet operating environment.

1.3.2 ASUS Special features

CrashFree BIOS 2

This feature allows you to restore the original BIOS data from the support CD in case when the BIOS codes and data are corrupted. This protection eliminates the need to buy a replacement ROM chip.

ASUS MyLogo2™

This new feature present in the motherboard allows you to personalize and add style to your system with customizable boot logos.

This chapter lists the hardware setup procedures that you have to perform when installing system components. It includes description of the jumpers and connectors on the motherboard.

2 Hardware information

2.1	Before you proceed	2-1
2.2	Motherboard overview.....	2-2
2.3	Central Processing Unit (CPU)	2-7
2.4	System memory	2-12
2.5	Expansion slots.....	2-14
2.6	Jumpers	2-17
2.7	Connectors	2-21

2.1 Before you proceed

Take note of the following precautions before you install motherboard components or change any motherboard settings.



- Unplug the power cord from the wall socket before touching any component.
- Use a grounded wrist strap or touch a safely grounded object or to a metal object, such as the power supply case, before handling components to avoid damaging them due to static electricity.
- Hold components by the edges to avoid touching the ICs on them.
- Whenever you uninstall any component, place it on a grounded antistatic pad or in the bag that came with the component.
- Before you install or remove any component, ensure that the ATX power supply is switched off or the power cord is detached from the power supply. Failure to do so may cause severe damage to the motherboard, peripherals, and/or components.

Onboard LED

The motherboard comes with a standby power LED. The green LED lights up to indicate that the system is ON, in sleep mode, or in soft-off mode. This is a reminder that you should shut down the system and unplug the power cable before removing or plugging in any motherboard component. The illustration below shows the location of the onboard LED.

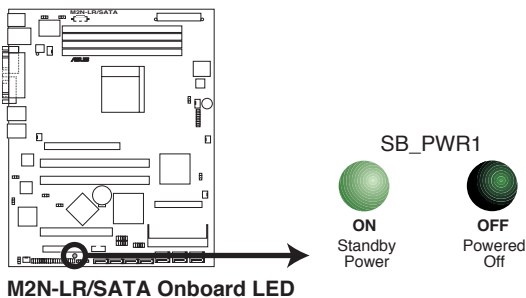

2.2 Motherboard overview

Before you install the motherboard, study the configuration of your chassis to ensure that the motherboard fits into it.



Make sure to unplug the power cord before installing or removing the motherboard. Failure to do so can cause you physical injury and damage motherboard components.

2.2.1 Placement direction

When installing the motherboard, make sure that you place it into the chassis in the correct orientation. The edge with external ports goes to the rear part of the chassis as indicated in the image below.

2.2.2 Screw holes

Place nine (9) screws into the holes indicated by circles to secure the motherboard to the chassis.



Do not overtighten the screws! Doing so can damage the motherboard.

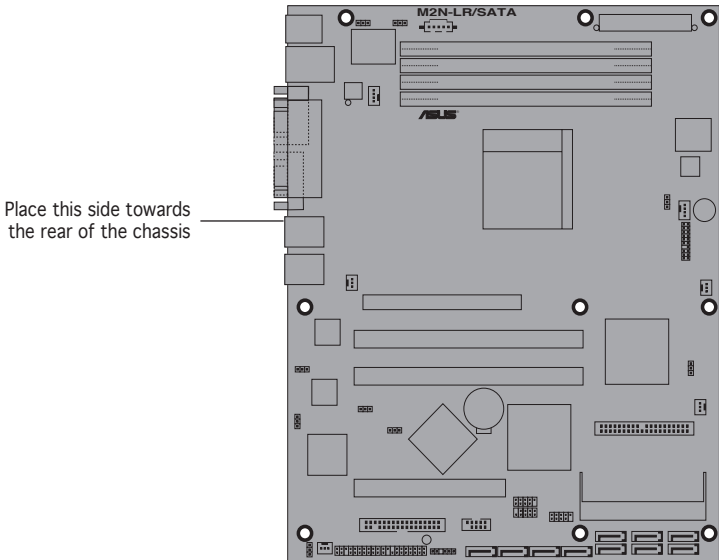

2.2.3 Motherboard layout

M2N-LR Model

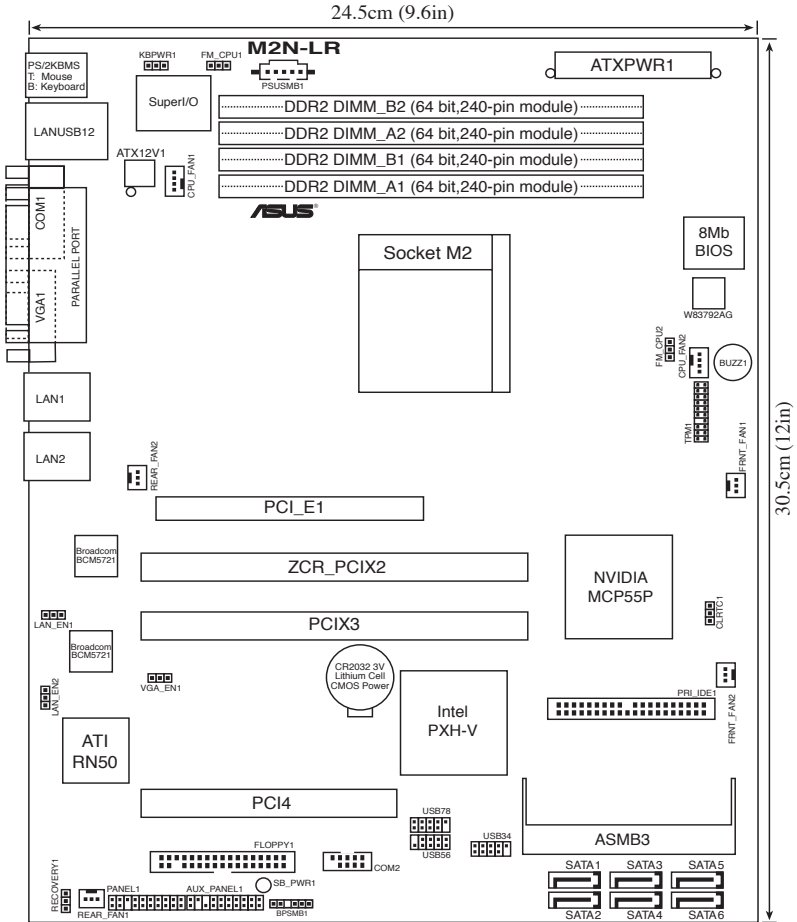

M2N-LR/SATA Model

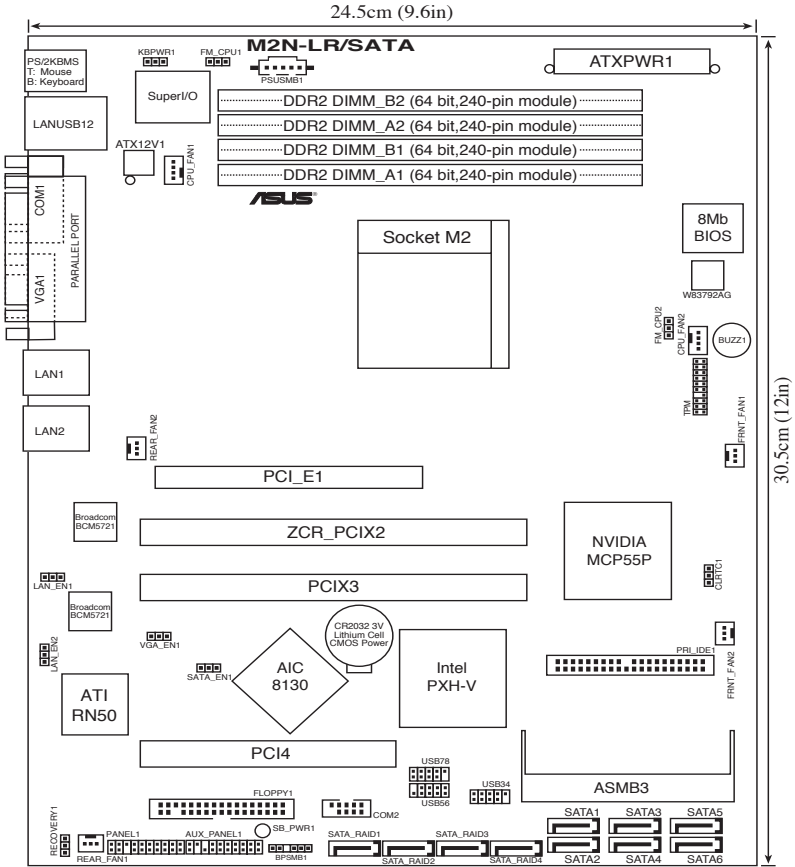

2.2.4 Layout contents

Slots	Page
1. CPU sockets	2-7
2. DDR2 DIMM sockets	2-12
3. PCI Express x16 slot	2-15
4. PCI slot	2-16
5. ZCR slot	2-16

Jumper	Page
1. Clear RTC RAM (CLRTC)	2-17
2. Keyboard power (3-pin KBPWR1)	2-18
3. Gigabit LAN controller setting (3-pin LAN_EN1, LAN_EN2)	2-18
4. VGA Graphics controller setting (3-pin VGA_EN1)	2-19
5. CPU fan pin selection (3-pin FM_CPU1, FM_CPU_2)	2-19
6. BIOS Recovery (3-pin RECOVERY1)	2-20
7. SATA controller setting (3-pin SATA_EN1)	2-20

Rear panel connectors	Page
1. PS/2 mouse port (green)	2-21
2. Parallel port	2-21
3. LAN 2 (RJ-45) port	2-21
4. LAN 1 (RJ-45) port	2-21
5. VGA port	2-21
6. Serial (COM1) port	2-21
7. USB 2.0 ports 1 and 2	2-21
8. PS/2 keyboard port (purple)	2-21

Internal connectors	Page
1. Floppy disk drive connector (34-1 pin FLOPPY)	2-22
2. IDE connector (40-pin PRI_IDE)	2-22
3. Serial ATA connectors (7-pin SATA1, SATA2, SATA3 SATA4, SATA5, SATA6)	2-23
4. CPU Front and Rear fan connectors (3-pin CPU_FAN1/2, FRONT_FAN1/2, REAR_FAN1/2)	2-23
5. Backplane SMBus connector (6-1 pin BPSMB1)	2-24
6. USB connector (10-pin USB34, USB56, USB78)	2-25
7. Serial port connector (10-1 pin COM2)	2-25
8. ATX power connectors (24-pin ATXPWR1, 4-pin ATX12V)	2-26
9. Power Supply SMBus connector (5-pin PSUSMB1)	2-26
10. System panel auxiliary connector (20-pin AUX_PANEL1)	2-27
11. System panel connector (20-pin PANEL1)	2-28

2.3 Central Processing Unit (CPU)

The motherboard comes with a 940-pin AM2 socket designed for the AMD Athlon™ 64/AMD Athlon™ 64 FX/AMD Athlon™ 64 X2 and AMD Sempron™ processors.



The AM2 socket has a different pin layout from the 940-pin socket designed for the AMD AM2 processor. Make sure you use a CPU is designed for the AM2 socket. The CPU fits in only one correct orientation. DO NOT force the CPU into the socket to prevent bending the connectors on the socket and damaging the CPU!

2.3.1 Installing the CPU

To install a CPU:

1. Locate the CPU socket on the motherboard.

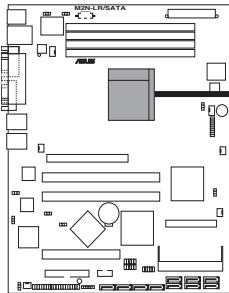

M2N-LR/SATA CPU Socket M2



2. Unlock the socket by pressing the lever sideways, then lift it up to a 90° angle.

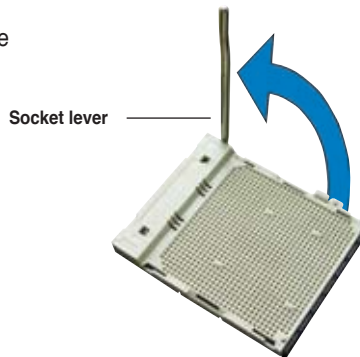

Make sure that the socket lever is lifted up to a 90° angle; otherwise, the CPU will not fit in completely.

3. Position the CPU above the socket such that the CPU corner with the gold triangle matches the socket corner with a small triangle.
4. Carefully insert the CPU into the socket until it fits in place.

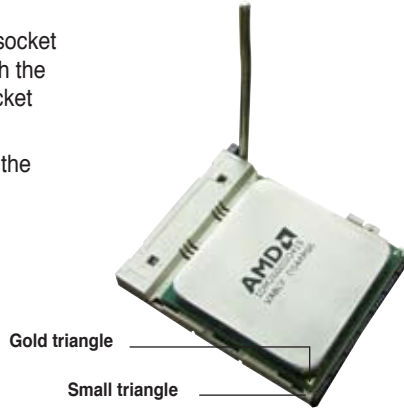

5. When the CPU is in place, push down the socket lever to secure the CPU. The lever clicks on the side tab to indicate that it is locked.
6. Install a CPU heatsink and fan following the instructions that came with the heatsink package.



2.3.2 Installing the heatsink and fan

The AMD Athlon™ 64/AMD Athlon™ 64 FX/AMD Athlon™ 64 X2 and AMD Sempron™ processors require a specially designed heatsink and fan assembly to ensure optimum thermal condition and performance.



Make sure that you use only AMD-certified heatsink and fan assembly.

To install the CPU heatsink and fan:

1. Place the heatsink on top of the installed CPU, making sure that the heatsink fits properly on the retention module base.



-
- The retention module base is already installed on the motherboard upon purchase.
 - You do not have to remove the retention module base when installing the CPU or installing other motherboard components.
 - If you purchased a separate CPU heatsink and fan assembly, make sure that a Thermal Interface Material is properly applied to the CPU heatsink or CPU before you install the heatsink and fan assembly.
-

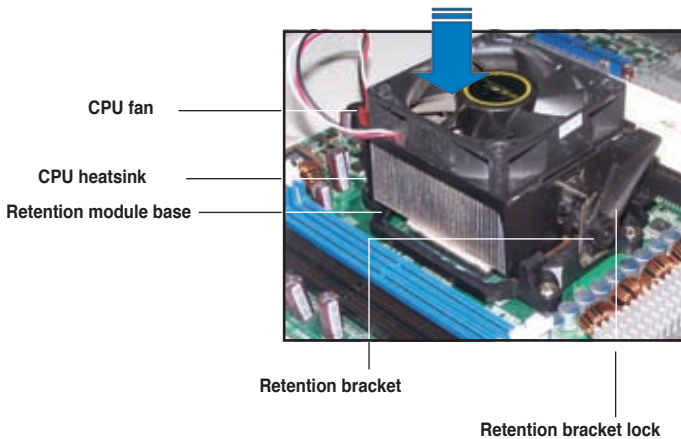

Your boxed CPU heatsink and fan assembly should come with installation instructions for the CPU, heatsink, and the retention mechanism. If the instructions in this section do not match the CPU documentation, follow the latter.

2. Attach one end of the retention bracket to the retention module base.

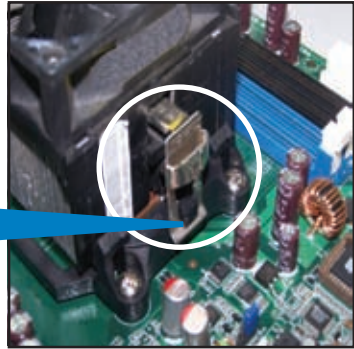

3. Align the other end of the retention bracket (near the retention bracket lock) to the retention module base. A clicking sound denotes that the retention bracket is in place.



Make sure that the fan and heatsink assembly perfectly fits the retention mechanism module base, otherwise you cannot snap the retention bracket in place.

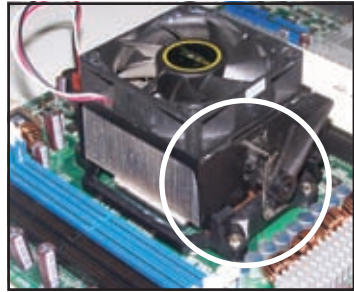

4. Push down the retention bracket lock on the retention mechanism to secure the heatsink and fan to the module base.

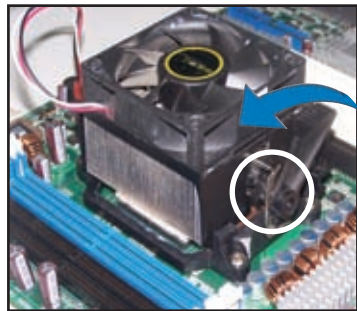

5. When the fan and heatsink assembly is in place, connect the CPU fan cable to the connector on the motherboard labeled CPU_FAN.

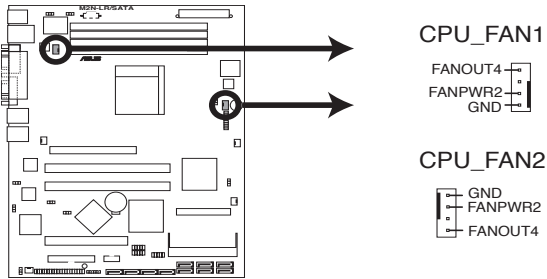

M2N-LR/SATA CPU Fan Connectors



- Do not forget to connect the CPU fan connector! Hardware monitoring errors can occur if you fail to plug this connector.
- This connector is backward compatible to the 3-pin CPU fan connector.

2.4 System memory

2.4.1 Overview

The motherboard comes with four Double Data Rate 2 (DDR2) Dual Inline Memory Modules (DIMM) sockets.

A DDR2 module has the same physical dimensions as a DDR DIMM but has a 240-pin footprint compared to the 184-pin DDR DIMM. DDR2 DIMMs are notched differently to prevent installation on a DDR DIMM socket.

The figure illustrates the location of the DDR2 DIMM sockets:

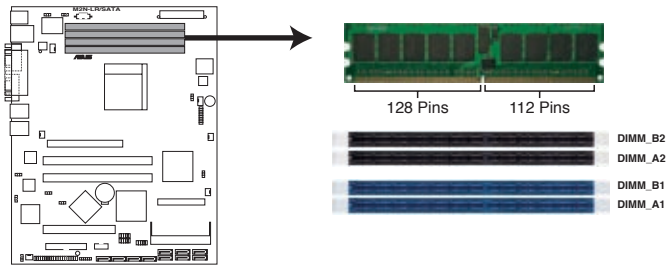

M2N-LR/SATA 240-pin DDR2 DIMM Sockets

Channel	Sockets
Channel A	DIMM_A1 and DIMM_A2
Channel B	DIMM_B1 and DIMM_B2

2.4.2 Memory configurations

You may install 64 MB, 128 MB, 256 MB, 512 MB, or 2 GB unbuffered ECC DDR2 DIMMs into the DIMM sockets using the memory configurations in this section.



- For dual-channel configuration, the total size of memory module(s) installed per channel must be the same for better performance (DIMM_A1+DIMM_A2=DIMM_B1+DIMM_B2).
- Due to chipset resource allocation, the system may detect less than 8 GB of system memory when you installed four 2 GB DDR2 memory modules.
- Always install DIMMs with the same CAS latency. For optimum compatibility, we recommend that you obtain memory modules from the same vendor. Refer to the DDR2 800 Qualified Vendors List at the ASUS web site.

2.4.3 Installing a DIMM



Unplug the power supply before adding or removing DIMMs or other system components. Failure to do so can cause severe damage to both the motherboard and the components.

To install a DIMM:

1. Unlock a DIMM socket by pressing the retaining clips outward.
2. Align a DIMM on the socket such that the notch on the DIMM matches the break on the socket.
3. Firmly insert the DIMM into the socket until the retaining clips snap back in place and the DIMM is properly seated.

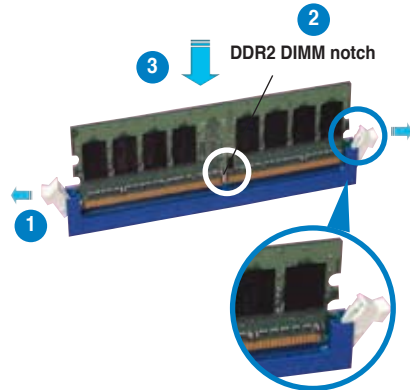

Unlocked retaining clip



- A DDR2 DIMM is keyed with a notch so that it fits in only one direction. Do not force a DIMM into a socket to avoid damaging the DIMM.
- The DDR2 DIMM sockets do not support DDR DIMMs. DO not install DDR DIMMs to the DDR2 DIMM sockets.

2.4.4 Removing a DIMM

To remove a DIMM:

1. Simultaneously press the retaining clips outward to unlock the DIMM.



Support the DIMM lightly with your fingers when pressing the retaining clips. The DIMM might get damaged when it flips out with extra force.

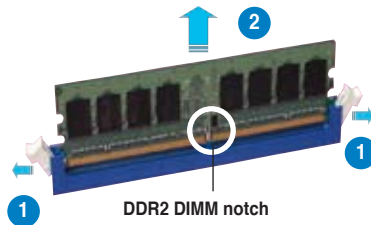

2. Remove the DIMM from the socket.

2.5 Expansion slots

In the future, you may need to install expansion cards. The following sub-sections describe the slots and the expansion cards that they support.



Make sure to unplug the power cord before adding or removing expansion cards. Failure to do so may cause you physical injury and damage motherboard components.

2.5.1 Installing an expansion card

To install an expansion card:

1. Before installing the expansion card, read the documentation that came with it and make the necessary hardware settings for the card.
2. Remove the system unit cover (if your motherboard is already installed in a chassis).
3. Remove the bracket opposite the slot that you intend to use. Keep the screw for later use.
4. Align the riser card connector with the slot and press firmly until the riser card is completely seated on the slot.
5. Align the card connector with the slot on the riser card and press firmly until the card is completely seated on the riser card slot.
6. Secure the card to the chassis with the screw you removed earlier.
7. Replace the system cover.

2.5.2 Configuring an expansion card

After installing the expansion card, configure it by adjusting the software settings.

1. Turn on the system and change the necessary BIOS settings, if any. See Chapter 4 for information on BIOS setup.
2. Assign an IRQ to the card. Refer to the tables on the next page.
3. Install the software drivers for the expansion card.

2.5.3 Interrupt assignments

Standard interrupt assignments

IRQ	Priority	Standard function
0	1	System Timer
1	2	Keyboard Controller
2	–	Redirect to IRQ#9
4	12	Communications Port (COM1)*
5	13	IRQ Holder for PCI Steering*
6	14	Floppy Disk Controller
7	15	Printer Port (LPT1)*
8	3	System CMOS/Real Time Clock
9	4	IRQ Holder for PCI Steering*
10	5	IRQ Holder for PCI Steering*
11	6	IRQ Holder for PCI Steering*
12	7	PS/2 Compatible Mouse Port*
13	8	Numeric Data Processor
14	9	Primary IDE Channel

* These IRQs are usually available for ISA or PCI devices.

2.5.4 PCI Express x16 slot

This motherboard supports a PCI Express x16 graphics card that comply with the PCI Express specifications. The figure shows a graphics card installed on the PCI Express x 16 slot.

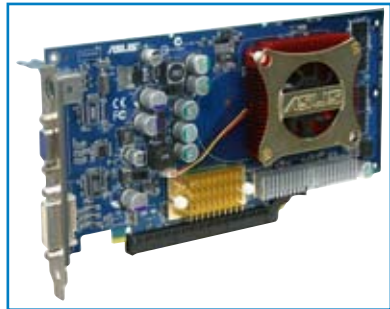

2.5.5 PCI slot

The PCI slot supports cards such as a LAN card, SCSI card, USB card, and other cards that comply with PCI specifications. The figure shows a LAN card installed on a PCI slot.



- Important note on M2N-LR:
When one PCI-X slot is populated, the PCI-X frequency is 133MHz. When both PCI-X slots are populated, the PCI-X frequency is 100MHz. Refer to table below for details.
- Important note on M2N-LR/SATA:
When one PCI-X slot is populated, the PCI-X frequency is 100MHz. When both PCI-X slots are populated, the PCI-X frequency is 66MHz. Refer to table below for details.

PCI-X Frequency

M2N-LR			M2N-LR/SATA		
PCI-X 1 slot (PCIX1)	PCI-X 2 slot (PCIX2)	Frequency	PCI-X 1 slot (PCIX1)	PCI-X 2 slot (PCIX2)	Frequency
populated	--	133MHz	populated	--	100MHz
--	populated	133MHz	--	populated	100MHz
populated	populated	100MHz	populated	populated	66MHz

2.5.6 ZCR slot (M2N-LR/SATA model only)

The 64-bit PCI-X slot (green) on the motherboard supports a Zero-Channel RAID card that allows RAID0, RAID1, RAID10, RAID5, and JBOD configurations.

2.6 Jumpers

1. Clear RTC RAM (CLRRTC)

This jumper allows you to clear the Real Time Clock (RTC) RAM in CMOS. You can clear the CMOS memory of date, time, and system setup parameters by erasing the CMOS RTC RAM data. The onboard button cell battery powers the RAM data in CMOS, which include system setup information such as system passwords.

To erase the RTC RAM:

1. Turn OFF the computer and unplug the power cord.
2. Remove the onboard battery.
3. Move the jumper cap from pins 1-2 (default) to pins 2-3. Keep the cap on pins 2-3 for about 5~10 seconds, then move the cap back to pins 1-2.
4. Reinstall the battery.
5. Plug the power cord and turn ON the computer.
6. Hold down the key during the boot process and enter BIOS setup to re-enter data.



Except when clearing the RTC RAM, never remove the cap on CLRRTC jumper default position. Removing the cap will cause system boot failure!

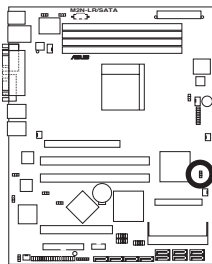

M2N-LR/SATA Clear RTC RAM

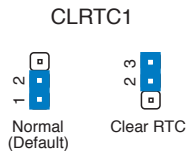

- Make sure to re-enter your previous BIOS settings after you clear the CMOS.
- You do not need to clear the RTC when the system hangs due to overclocking. For system failure due to overclocking, use the C.P.R. (CPU Parameter Recall) feature. Shut down and reboot the system so the BIOS can automatically reset parameter settings to default values.

2. Keyboard power (3-pin KBPWR1)

This jumper allows you to enable or disable the keyboard wake-up feature. Set this jumper to pins 2-3 (+5VSB) to wake up the computer when you press a key on the keyboard (the default is the Space Bar). This feature requires an ATX power supply that can supply at least 1A on the +5VSB lead, and a corresponding setting in the BIOS.

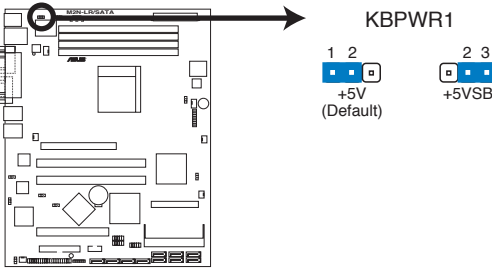

M2N-LR/SATA Keyboard Power Setting

3. Gigabit LAN controller setting (3-pin LAN_EN1, LAN_EN2)

These jumpers allow you to enable or disable the onboard Broadcom[®] BCM5721 Gigabit LAN controllers. The LAN_EN1 jumper controls the LAN1 port. The LAN_EN2 jumper controls the LAN2 port.

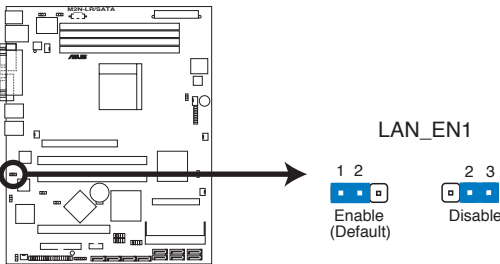

M2N-LR/SATA LAN_EN1 Setting

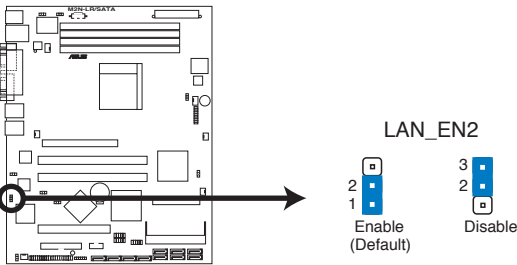

M2N-LR/SATA LAN_EN2 Setting

4. VGA Graphics controller setting (3-pin VGA_EN1)

This jumper allows you to enable or disable the onboard ATI ES1000 graphics controller.

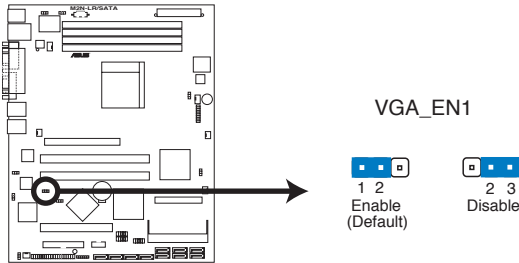

M2N-LR/SATA VGA Setting

5. CPU fan pin selection (3-pin FM_CPU1, FM_CPU2)

These jumpers allow you to connect either a 3-pin or 4-pin fan cable plug to the CPU fan connectors (CPU_FAN1, CPU_FAN2). Set these jumpers to pins 1-2 if you are using a 3-pin fan cable plug, or to pins 2-3 if you are using a 4-pin plug.

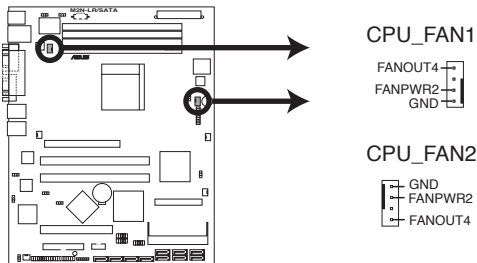

M2N-LR/SATA CPU Fan Connectors

6. BIOS Recovery (3-pin RECOVERY1)

This jumper allows you to recover your original BIOS from a floppy disk in case the BIOS codes and data are corrupted.

To recover the BIOS:

1. Turn OFF your computer and unplug the power cord.
2. Move the jumper cap from pins 2-3 (default) to pins 1-2.
3. Insert a floppy disk with the original or updated BIOS file.
4. Plug the power cord and turn ON the computer.
5. The system searches for the BIOS file in the floppy then reflashes the BIOS.
6. When finished, shut down your computer.
7. Replace the jumper cap from pins 1-2 to pins 2-3.
8. Reboot your computer.
9. Hold down the key during the boot process and enter BIOS setup to re-enter data.

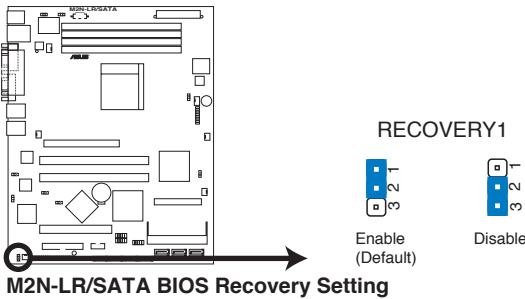

7. SATA controller setting (3-pin SATA_EN1)

(M2N-LR/SATA model only)

This jumper allows you to enable or disable the Adaptec® AIC-8130 SATA RAID controller.

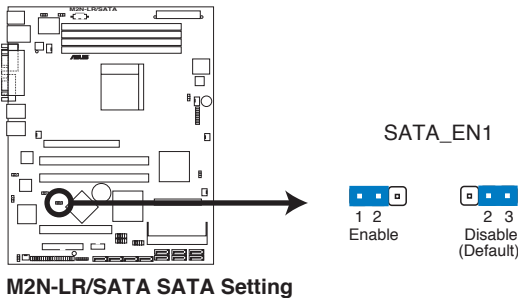

2.7 Connectors

2.7.1 Rear panel connectors

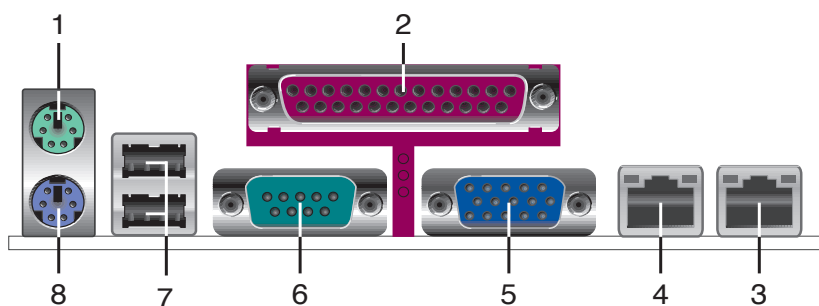

1. **PS/2 mouse port (green).** This port is for a PS/2 mouse.
2. **Parallel port.** This 25-pin port connects a parallel printer, a scanner, or other devices.
3. **LAN 2 (RJ-45) port.** Supported by the BROADCOM® BCM5721 Gigabit LAN controller, this port allows Gigabit connection to a Local Area Network (LAN) through a network hub. Refer to the table below for the LAN port LED indications.
4. **LAN 1 (RJ-45) port.** Supported by BROADCOM® BCM5721 Gigabit LAN controller, this port allows Gigabit connection to a Local Area Network (LAN) through a network hub. Refer to the table below for the LAN port LED indications.
5. **VGA port.** This port is for a VGA monitor or other VGA-compatible devices.
6. **Serial (COM1) port.** This 9-pin communication port is for pointing devices or other serial devices.
7. **USB 2.0 ports 1 and 2.** These 4-pin Universal Serial Bus (USB) ports are available for connecting USB 2.0 devices.
8. **PS/2 keyboard port (purple).** This port is for a PS/2 keyboard.

LAN port LED indications

Activity/Link Speed LED			
Status	Description	Status	Description
OFF	No link	OFF	10 Mbps connection
ORANGE	Linked	ORANGE	100 Mbps connection
BLINKING	Data activity	GREEN	1 Gbps connection

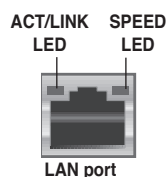

2.7.2 Internal connectors

1. Floppy disk drive connector (34-1 pin FLOPPY)

This connector is for the provided floppy disk drive (FDD) signal cable. Insert one end of the cable to this connector, then connect the other end to the signal connector at the back of the floppy disk drive.



Pin 5 on the connector is removed to prevent incorrect cable connection when using a FDD cable with a covered Pin 5.

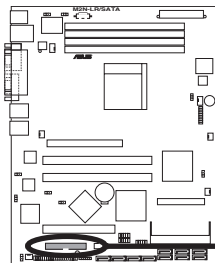

M2N-LR/SATA Floppy Disk Drive Connector



NOTE: Orient the red markings on the floppy ribbon cable to PIN 1.

2. IDE connector (40-1 pin PRI_IDE)

The onboard IDE connector is for the Ultra DMA 133/100/66 signal cable. There are three connectors on each Ultra DMA 133/100/66 signal cable: blue, black, and gray. Connect the blue connector to the motherboard's IDE connector, then select one of the following modes to configure your device.

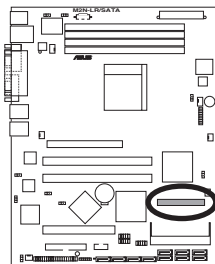

M2N-LR/SATA IDE Connector

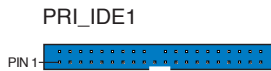

NOTE: Orient the red markings (usually zigzag) on the IDE ribbon cable to PIN 1.

	Drive jumper setting	Mode of device(s)	Cable connector
Single device	Cable-Select or Master	-	Black
Two devices	Cable-Select	Master	Black
		Slave	Gray
	Master	Master	Black or gray
	Slave	Slave	



- Pin 20 on the IDE connector is removed to match the covered hole on the Ultra DMA cable connector. This prevents incorrect insertion when you connect the IDE cable.
- Use the 80-conductor IDE cable for Ultra DMA 100/66 IDE devices.



If any device jumper is set as “Cable-Select,” make sure all other device jumpers have the same setting.

3. Serial ATA connectors (7-pin SATA1, SATA2, SATA3, SATA4, SATA5, SATA6)

Supported by the NVIDIA® nForce™ 570 SLI MCP (MCP55P) chipset, these connectors are for the Serial ATA signal cables for Serial ATA hard disk drives that allows up to 3Gb/s of data transfer rate.

If you installed Serial ATA hard disk drives, you can create a RAID 0, RAID 1, RAID 10, RAID 5, or JBOD configuration. Refer to Chapter 5 for details on how to set up the RAID configurations.



These connectors are set to SATA by default. In SATA mode, you can connect Serial ATA boot or data hard disk drives to these connectors. If you intent to create a Serial ATA RAID set using these connectors, enable the RAID function of each port from the nVIDIA RAID Setup sub-menu item in the BIOS. See section “4.4.7 Onboard Device Configuration” for details.

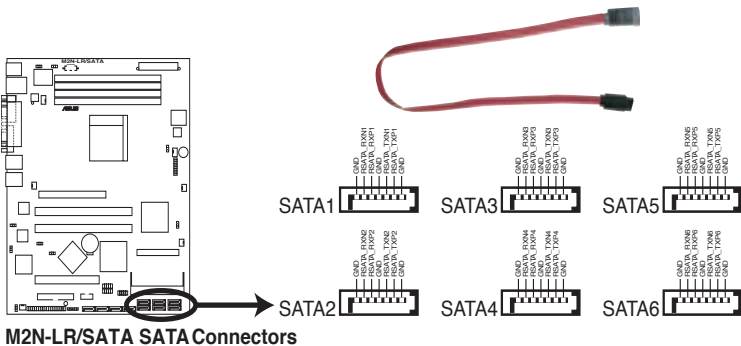

4. CPU, Front and Rear fan connectors (4-pin CPU_FAN1/2, 3-pin FRONT_FAN1/2, Rear_FAN1/2)

The fan connectors support cooling fans of 350mA~2000mA (24 W max.) or a total of 1A~3.48A (41.76 W max.) at +12V. Connect the fan cables to the fan connectors on the motherboard, making sure that the black wire of each cable matches the ground pin of the connector.



- Do not forget to connect the fan cables to the fan connectors. Lack of sufficient air flow inside the system may damage the motherboard components. These are not jumpers! DO NOT place jumper caps on the fan connectors!
- All fan features the ASUS Smart Fan technology.

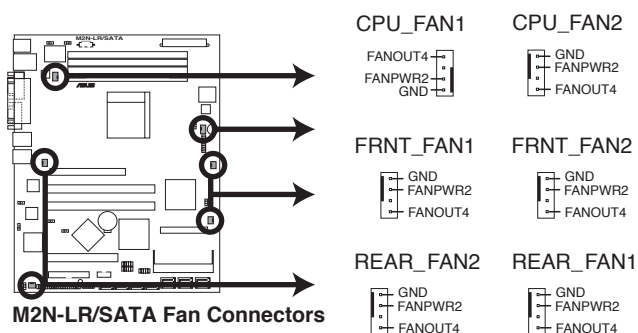

5. Backplane SMBus connector (6-1 pin BPSMB1)

This connector allows you to connect SMBus (System Management Bus) devices. Devices communicate with an SMBus host or other SMBus devices using the SMBus interface.

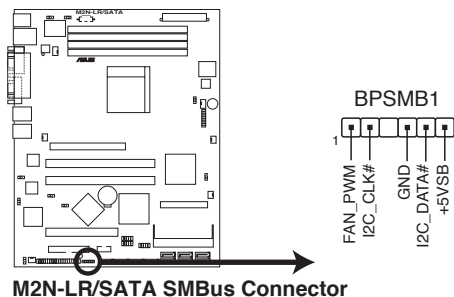

6. USB connector (10-1 pin USB34, USB56, USB78)

These connectors are for USB 2.0 ports. These connectors comply with the USB 2.0 specification that supports up to 480 Mbps connection speed.

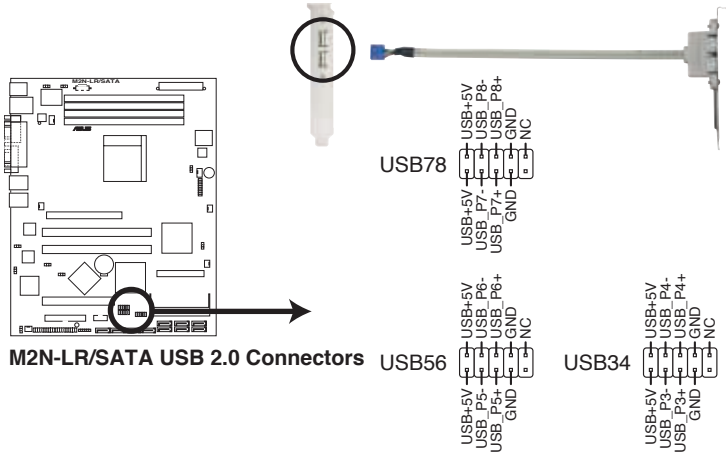

7. Serial port connector (10-1 pin COM2)

This connector is for a serial (COM) port. Connect the serial port module cable to this connector, then install the module to a slot opening at the back of the system chassis.

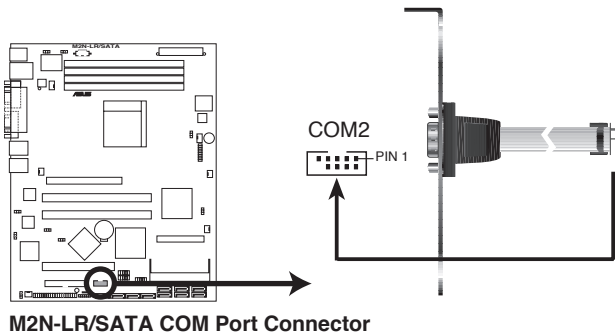

The COM2 serial port module cable is optional.

8. ATX power connectors (24-pin ATXPWR1,4-pin ATX12V)

These connectors are for an ATX power supply plugs. The power supply plugs are designed to fit these connectors in only one orientation. Find the proper orientation and push down firmly until the connectors completely fit.



- Do not forget to connect the 4-pin ATX +12 V power plug; otherwise, the system will not boot.
- Use of a PSU with a higher power output is recommended when configuring a system with more power-consuming devices. The system may become unstable or may not boot up if the power is inadequate.
- Make sure that your power supply unit (PSU) can provide at least the minimum power required by your system. See the table below for details.

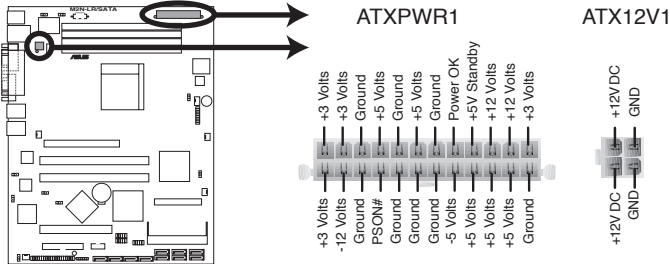

M2N-LR/SATA ATX Power Connector

9. Power Supply SMBus connector (5-pin PSUSMB1)

This connector allows you to connect SMBus (System Management Bus) devices to the power supply unit. Devices communicate with an SMBus host and/or other SMBus devices using the SMBus interface.

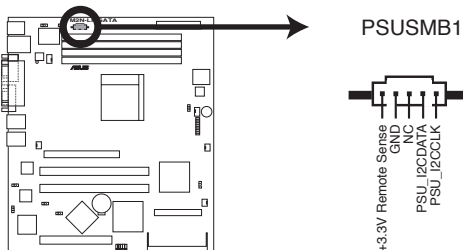

M2N-LR/SATA Power Supply SMBus Connector

10. System panel auxiliary connector (20-pin AUX_PANEL1)

This connector supports several server system functions.

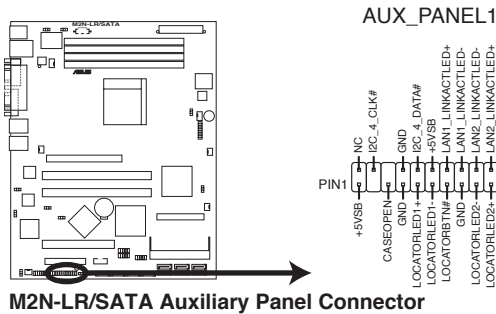

- **Chassis Intrusion connector (3-pin CASEOPEN)**
This lead is for a chassis with an intrusion detection feature. This requires an external detection mechanism such as a chassis intrusion sensor or microswitch. When you remove any chassis component, the sensor triggers and sends a high-level signal to this lead to record a chassis intrusion event.
- **LAN1 link activity LED (2-pin LAN1_LINKACTLED)**
This 2-pin connector is for the LAN1 Activity LED. Connect the LAN1 Activity LED cable to this connector. This LED blinks during a network activity and is always lit when linked.
- **LAN2 link activity LED (2-pin LAN2_LINKACTLED)**
This 2-pin connector is for the LAN2 Activity LED. Connect the LAN2 Activity LED cable to this connector. This LED blinks during a network activity and lights up when linked.
- **Locator LED 1 (2-pin LOCATORLED1)**
This 2-pin connector is for the Locator LED 1. Connect the Locator LED 1 cable to this connector. This LED lights up when the Locator button is pressed.
- **Locator LED 2 (2-pin LOCATORLED2)**
This 2-pin connector is for the Locator LED 2. Connect the Locator LED 2 cable to this connector.
- **Locator Button/Switch (2-pin LOCATORBTN)**
This connector is for the locator button. This button queries the state of the system locator.
- **Front Panel SMBus (6-1 pin)**
This connector allows you to connect SMBus (System Management Bus) devices to the system front panel. Devices communicate with an SMBus host and/or other SMBus devices using the SMBus interface.

11. System panel connector (20-pin PANEL1)

This connector supports several chassis-mounted functions.

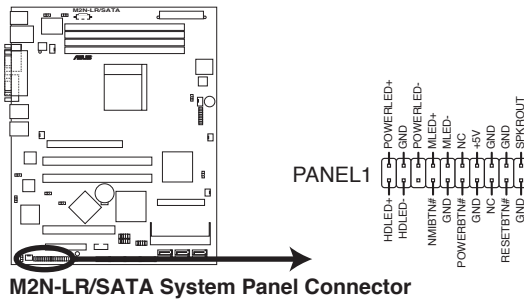

M2N-LR/SATA System Panel Connector



The system panel connector is color-coded for easy connection. Refer to the connector description below for details.

- **System power LED (Green 3-pin POWERLED)**
This 3-pin connector is for the system power LED. Connect the chassis power LED cable to this connector. The system power LED lights up when you turn on the system power, and blinks when the system is in sleep mode.
- **Hard disk drive activity (Red 2-pin HDDLED)**
This 2-pin connector is for the HDD Activity LED. Connect the HDD Activity LED cable to this connector. The IDE LED lights up or flashes when data is read from or written to the HDD.
If an optional SATA add-in card is installed, the read or write activities of any device connected to the SATA add-in card causes this LED to light up.
- **System warning speaker (Orange 4-pin SPKROUT)**
This 4-pin connector is for the chassis-mounted system warning speaker. The speaker allows you to hear system beeps and warnings.
- **Power/Soft-off button (Yellow 2-pin POWERBTN)**
This connector is for the system power button. Pressing the power button turns the system ON or puts the system in SLEEP or SOFT-OFF mode depending on the BIOS settings. Pressing the power switch for more than four seconds while the system is ON turns the system OFF.
- **Reset button (Blue 2-pin RESETBTN)**
This 2-pin connector is for the chassis-mounted reset button for system reboot without turning off the system power.

This chapter describes the power up sequence and ways of shutting down the system.

Powering up **3**

Chapter summary

3

3.1	Starting up for the first time.....	3-1
3.2	Powering off the computer.....	3-2

3.1 Starting up for the first time

1. After making all the connections, replace the system case cover.
2. Be sure that all switches are off.
3. Connect the power cord to the power connector at the back of the system chassis.
4. Connect the power cord to a power outlet that is equipped with a surge protector.
5. Turn on the devices in the following order:
 - a. Monitor
 - b. External SCSI devices (starting with the last device on the chain)
 - c. System power
6. After applying power, the system power LED on the system front panel case lights up. For systems with ATX power supplies, the system LED lights up when you press the ATX power button. If your monitor complies with “green” standards or if it has a “power standby” feature, the monitor LED may light up or switch between orange and green after the system LED turns on.

The system then runs the power-on self tests or POST. While the tests are running, the BIOS beeps or additional messages appear on the screen. If you do not see anything within 30 seconds from the time you turned on the power, the system may have failed a power-on test. Check the jumper settings and connections or call your retailer for assistance.
7. At power on, hold down the key to enter the BIOS Setup. Follow the instructions in Chapter 4.

3.2 Powering off the computer

3.2.1 Using the OS shut down function

If you are using Windows® 2000:

1. Click the Start button then click Shut Down...
2. Make sure that the Shut Down option button is selected, then click the OK button to shut down the computer.
3. The power supply should turn off after Windows® shuts down.

If you are using Windows® 2003:

1. Click the Start button then select Turn Off Computer.
2. Click the Turn Off button to shut down the computer.
3. The power supply should turn off after Windows® shuts down.

3.2.2 Using the dual function power switch

While the system is ON, pressing the power switch for less than four seconds puts the system to sleep mode or to soft-off mode, depending on the BIOS setting. Pressing the power switch for more than four seconds lets the system enter the soft-off mode regardless of the BIOS setting. Refer to section “4.5 Power Menu” in Chapter 4 for details.

This chapter tells how to change the system settings through the BIOS Setup menus. Detailed descriptions of the BIOS parameters are also provided.

BIOS setup 4

4.1	Managing and updating your BIOS	4-1
4.2	BIOS setup program	4-10
4.3	Main menu	4-13
4.4	Advanced menu	4-18
4.5	Power menu.....	4-31
4.6	Boot menu	4-35
4.7	Exit menu.....	4-39

4.1 Managing and updating your BIOS

The following utilities allow you to manage and update the motherboard Basic Input/Output System (BIOS) setup.

1. **ASUS AFUDOS** (Updates the BIOS in DOS mode using a bootable floppy disk.)
2. **ASUS CrashFree BIOS 2** (Updates the BIOS using a bootable floppy disk or the motherboard support CD when the BIOS file fails or gets corrupted.)
3. **ASUS Update** (Updates the BIOS in Windows® environment.)

Refer to the corresponding sections for details on these utilities.



Save a copy of the original motherboard BIOS file to a bootable floppy disk in case you need to restore the BIOS in the future. Copy the original motherboard BIOS using the ASUS Update or AFUDOS utilities.

4.1.1 Creating a bootable floppy disk

1. Do either one of the following to create a bootable floppy disk.
 - DOS environment
 - a. Insert a 1.44MB floppy disk into the drive.
 - b. At the DOS prompt, type **format A:/S** then press <Enter>.
 - Windows® XP environment
 - a. Insert a 1.44 MB floppy disk to the floppy disk drive.
 - b. Click **Start** from the Windows® desktop, then select **My Computer**.
 - c. Select the 3 1/2 Floppy Drive icon.
 - d. Click **File** from the menu, then select **Format. A Format 3 1/2 Floppy Disk** window appears.

Windows® 2000 environment

To create a set of boot disks for Windows® 2000:

- a. Insert a formatted, high density 1.44 MB floppy disk into the drive.
 - b. Insert the Windows® 2000 CD to the optical drive.
 - c. Click **Start**, then select **Run**.
 - d. In the Open field, type **D:\bootdisk\makeboot a:** assuming that D is your optical drive letter.
 - e. Press <Enter>, then follow screen instructions to continue.
2. Copy the original or the latest motherboard BIOS file to the bootable floppy disk.

4.1.2 AFUDOS utility

The AFUDOS utility allows you to update the BIOS file in DOS environment using a bootable floppy disk with the updated BIOS file. This utility also allows you to copy the current BIOS file that you can use as backup when the BIOS fails or gets corrupted during the updating process.

Copying the current BIOS

To copy the current BIOS file using the AFUDOS utility:



- Make sure that the floppy disk is not write-protected and has at least 1.1MB free space to save the file.
- The succeeding BIOS screens are for reference only. The actual BIOS screen displays may not be same as shown.

1. Copy the AFUDOS utility (afudos.exe) from the motherboard support CD to the bootable floppy disk you created earlier.
2. Boot the system in DOS mode, then at the prompt type:

afudos /o[filename]

where the [filename] is any user-assigned filename not more than eight alphanumeric characters for the main filename and three alphanumeric characters for the extension name.

```
A:\>afudos /oOLDBIOS1.rom
```

Main filename Extension name

3. Press <Enter>. The utility copies the current BIOS file to the floppy disk.

```
A:\>afudos /oOLDBIOS1.rom
AMI Firmware Update Utility - Version 1.19 (ASUS V2.07 (03.11.24BB))
Copyright (C) 2002 American Megatrends, Inc. All rights reserved.
  Reading flash ..... done
  Write to file..... ok
A:\>
```

The utility returns to the DOS prompt after copying the current BIOS file.

Updating the BIOS file

To update the BIOS file using the AFUDOS utility:

1. Visit the ASUS website (www.asus.com) and download the latest BIOS file for the motherboard. Save the BIOS file to a bootable floppy disk.



Write the BIOS filename on a piece of paper. You need to type the exact BIOS filename at the DOS prompt.

2. Copy the AFUDOS utility (afudos.exe) from the motherboard support CD to the bootable floppy disk you created earlier.
3. Boot the system in DOS mode, then at the prompt type:

afudos /i[filename]

where [filename] is the latest or the original BIOS file on the bootable floppy disk.

```
A:\>afudos /iM2N-LR.ROM
```

4. The utility verifies the file and starts updating the BIOS.

```
A:\>afudos /im2N-LR.ROM /pbnc
AMI Firmware Update Utility - Version 1.19(ASUS V2.07(03.11.24BB))
Copyright (C) 2002 American Megatrends, Inc. All rights reserved.

WARNING!! Do not turn off power during flash BIOS
Reading file ..... done
Reading flash ..... done

Advance Check .....
Erasing flash ..... done
Writing flash ..... 0x0008CC00 (9%)
```



Do not shut down or reset the system while updating the BIOS to prevent system boot failure!

5. The utility returns to the DOS prompt after the BIOS update process is completed. Reboot the system from the hard disk drive.

```
A:\>afudos /im2N-LR.ROM /pbnc
AMI Firmware Update Utility - Version 1.19(ASUS V2.07(03.11.24BB))
Copyright (C) 2002 American Megatrends, Inc. All rights reserved.

WARNING!! Do not turn off power during flash BIOS
Reading file ..... done
Reading flash ..... done

Advance Check .....
Erasing flash ..... done
Writing flash ..... done
Verifying flash .... done

Please restart your computer

A:\>
```

4.1.3 ASUS CrashFree BIOS 2 utility

The ASUS CrashFree BIOS 2 is an auto recovery tool that allows you to restore the BIOS file when it fails or gets corrupted during the updating process. You can update a corrupted BIOS file using the motherboard support CD or the floppy disk that contains the updated BIOS file.



- Prepare the motherboard support CD or the floppy disk containing the updated motherboard BIOS before using this utility.
- Make sure that you rename the original or updated BIOS file in the floppy disk to **M2N-LR.ROM** (*M2N-LR model*) or **M2N-LR-S.ROM** (*M2N-LR/SATA model*).

Recovering the BIOS from a floppy disk

To recover the BIOS from a floppy disk:

1. Turn on the system.
2. Insert the floppy disk with the original or updated BIOS file to the floppy disk drive.
3. The utility displays the following message and automatically checks the floppy disk for the original or updated BIOS file.

```
Bad BIOS checksum. Starting BIOS recovery...
Checking for floppy...
```

When found, the utility reads the BIOS file and starts flashing the corrupted BIOS file.

```
Bad BIOS checksum. Starting BIOS recovery...
Checking for floppy...
Floppy found!
Reading file "M2N-LR.ROM". Completed.
Start flashing...
```



DO NOT shut down or reset the system while updating the BIOS! Doing so can cause system boot failure!

4. Restart the system after the utility completes the updating process.

Recovering the BIOS from the support CD

To recover the BIOS from the support CD:

1. Remove any floppy disk from the floppy disk drive, then turn on the system.
2. Insert the support CD to the optical drive.
3. The utility displays the following message and automatically checks the floppy disk for the original or updated BIOS file.

```
Bad BIOS checksum. Starting BIOS recovery...
Checking for floppy...
```

When no floppy disk is found, the utility automatically checks the optical drive for the original or updated BIOS file. The utility then updates the corrupted BIOS file.

```
Bad BIOS checksum. Starting BIOS recovery...
Checking for floppy...
Floppy not found!
Checking for CD-ROM...
CD-ROM found!
Reading file "M2N-LR.ROM". Completed.
Start flashing...
```



DO NOT shut down or reset the system while updating the BIOS! Doing so can cause system boot failure!

4. Restart the system after the utility completes the updating process.



The recovered BIOS may not be the latest BIOS version for this motherboard. Visit the ASUS website (www.asus.com) to download the latest BIOS file.

4.1.4 ASUS Update utility

The ASUS Update is a utility that allows you to manage, save, and update the motherboard BIOS in Windows® environment. The ASUS Update utility allows you to:

- Save the current BIOS file
- Download the latest BIOS file from the Internet
- Update the BIOS from an updated BIOS file
- Update the BIOS directly from the Internet, and
- View the BIOS version information.

This utility is available in the support CD that comes with the motherboard package.



ASUS Update requires an Internet connection either through a network or an Internet Service Provider (ISP).

Installing ASUS Update

To install ASUS Update:

1. Place the support CD in the optical drive. The **Drivers** menu appears.
2. Click the **Utilities** tab, then click **Install ASUS Update VX.XX.XX**.
3. The ASUS Update utility is copied to your system.



Quit all Windows® applications before you update the BIOS using this utility.

Updating the BIOS through the Internet

To update the BIOS through the Internet:

1. Launch the ASUS Update utility from the Windows® desktop by clicking **Start > Programs > ASUS > ASUSUpdate > ASUSUpdate**. The ASUS Update main window appears.

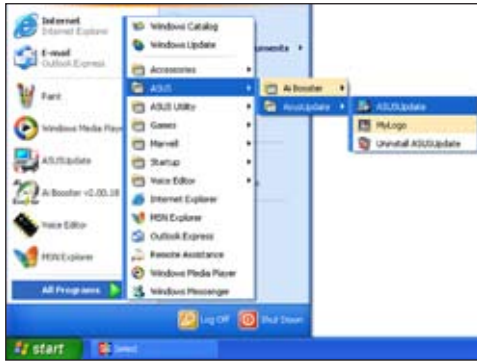

2. Select **Update BIOS from the Internet** option from the drop-down menu, then click **Next**.



3. Select the ASUS FTP site nearest you to avoid network traffic, or click **Auto Select**. Click **Next**.

- From the FTP site, select the BIOS version that you wish to download. Click **Next**.
- Follow the screen instructions to complete the update process.



The ASUS Update utility is capable of updating itself through the Internet. Always update the utility to avail all its features.



Updating the BIOS through a BIOS file

To update the BIOS through a BIOS file:

- Launch the ASUS Update utility from the Windows® desktop by clicking **Start > Programs > ASUS > ASUSUpdate > ASUSUpdate**. The ASUS Update main window appears.
- Select **Update BIOS from a file** option from the drop-down menu, then click **Next**.



- Locate the BIOS file from the **Open** window, then click **Save**.
- Follow the screen instructions to complete the update process.

4.2 BIOS setup program

This motherboard supports a programmable Low-Pin Count (LPC) chip that you can update using the provided utility described in section “4.1 Managing and updating your BIOS.”

Use the BIOS Setup program when you are installing a motherboard, reconfiguring your system, or prompted to “Run Setup.” This section explains how to configure your system using this utility.

Even if you are not prompted to use the Setup program, you can change the configuration of your computer in the future. For example, you can enable the security password feature or change the power management settings. This requires you to reconfigure your system using the BIOS Setup program so that the computer can recognize these changes and record them in the CMOS RAM of the LPC chip.

The LPC chip on the motherboard stores the Setup utility. When you start up the computer, the system provides you with the opportunity to run this program. Press during the Power-On Self-Test (POST) to enter the Setup utility; otherwise, POST continues with its test routines.

If you wish to enter Setup after POST, reboot the system by doing any of the following procedures:

- Restart using the OS standard shut-down procedure.
- Press <Ctrl>+<Alt>+ simultaneously.
- Press the reset button on the system chassis.
- Press the power button to turn the system off then back on.



Using the **power button**, **reset button**, or the <Ctrl>+<Alt>+ keys to force reset from a running operating system can cause damage to your data or system. We recommend to always shut-down the system properly from the operating system.

The Setup program is designed to make it as easy to use as possible. Being a menu-driven program, it lets you scroll through the various sub-menus and make your selections from the available options using the navigation keys.



-
- The default BIOS settings for this motherboard apply for most conditions to ensure optimum performance. If the system becomes unstable after changing any BIOS settings, load the default settings to ensure system compatibility and stability. Select the **Load Default Settings** item under the Exit Menu. See section “4.8 Exit Menu.”
 - The BIOS setup screens shown in this section are for reference purposes only, and may not exactly match what you see on your screen.
 - Visit the ASUS website (www.asus.com) to download the latest BIOS file for this motherboard.
-

4.2.1 BIOS menu screen

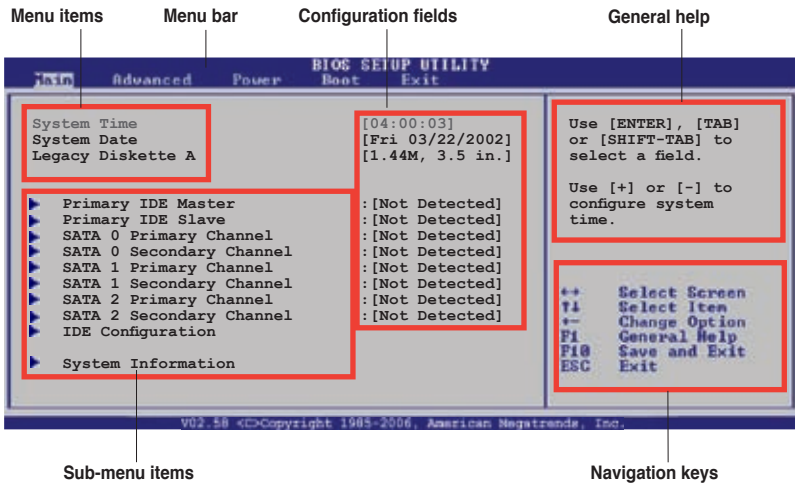

4.2.2 Menu bar

The menu bar on top of the screen has the following main items:

Main	Select to change basic system configurations
Advanced	Select to configure advanced system settings
Power	Select for advanced power management (APM) configurations
Boot	Select to change system boot configuration
Tools	Select to use various ASUS BIOS tools.
Exit	Select for the exit options and to load default BIOS settings

To select an item on the menu bar, press the right or left arrow key on the keyboard until the desired item is highlighted.



- The BIOS setup screens shown in this chapter are for reference purposes only, and may not exactly match what you see on your screen.
- Visit the ASUS website (www.asus.com) to download the latest BIOS information.

4.2.3 Navigation keys

At the bottom right corner of a menu screen are the navigation keys for that particular menu. Use the navigation keys to select items in the menu and change the settings.



Some of the navigation keys differ from one screen to another.

4.2.4 Menu items

The highlighted item on the menu bar displays the specific items for that menu. For example, selecting **Main** shows the Main menu items.

The other items (Advanced, Power, Boot, and Exit) on the menu bar have their respective menu items.

4.2.5 Sub-menu items

A solid triangle before each item on any menu screen means that the item has a sub-menu. To display the sub-menu, select the item and press <Enter>.

4.2.6 Configuration fields

These fields show the values for the menu items. If an item is user-configurable, you can change the value of the field opposite the item. You cannot select an item that is not user-configurable.

A configurable field is enclosed in brackets, and is highlighted when selected. To change the value of a field, select it then press <Enter> to display a list of options. Refer to “4.2.7 Pop-up window.”

4.2.7 Pop-up window

Select a menu item then press <Enter> to display a pop-up window with the configuration options for that item.

4.2.8 General help

At the top right corner of the menu screen is a brief description of the selected item.

4.3 Main menu

When you enter the BIOS Setup program, the Main menu screen appears, giving you an overview of the basic system information.



Refer to section “4.2.1 BIOS menu screen” for information on the menu screen items and how to navigate through them.



4.3.1 System Time [xx:xx:xx]

Allows you to set the system time.

4.3.2 System Date [Day xx/xx/yyyy]

Allows you to set the system date.

4.3.3 Legacy Diskette A [1.44M, 3.5 in.]

Sets the type of floppy drive installed.

Configuration options: [Disabled] [360K, 5.25 in.] [1.2M, 5.25 in.] [720K, 3.5 in.] [1.44M, 3.5 in.] [2.88M, 3.5 in.]

4.3.4 Primary IDE Master/Slave, SATA0 Primary/Secondary Channel, SATA1 Primary/Secondary Channel, SATA2 Primary/Secondary Channel

The BIOS automatically detects the connected IDE devices. There is a separate sub-menu for each IDE device. Select a device item, then press <Enter> to display the IDE device information.



The BIOS automatically detects the values opposite the dimmed items (Device, Vendor, Size, LBA Mode, Block Mode, PIO Mode, Async DMA, Ultra DMA, and SMART monitoring). These values are not user-configurable. These items show N/A if no IDE device is installed in the system.

Type [Auto]

Selects the type of IDE drive. Setting to [Auto] allows automatic selection of the appropriate IDE device type. Select [CDROM] if you are specifically configuring a CD-ROM drive. Select [ARMD] (ATAPI Removable Media Device) if your device is either a ZIP, LS-120, or MO drive.

Configuration options: [Not Installed] [Auto] [CDROM] [ARMD]

LBA/Large Mode [Auto]

Enables or disables the LBA mode. Setting to [Auto] enables the LBA mode if the device supports this mode, and if the device was not previously formatted with LBA mode disabled. Configuration options: [Disabled] [Auto]

Block (Multi-sector Transfer) [Auto]

Enables or disables data multi-sectors transfers. When set to [Auto], the data transfer from and to the device occurs multiple sectors at a time if the device supports multi-sector transfer feature. When set to [Disabled], the data transfer from and to the device occurs one sector at a time. Configuration options:

[Disabled] [Auto]

PIO Mode [Auto]

Selects the PIO mode.

Configuration options: [Auto] [0] [1] [2] [3] [4]

DMA Mode [Auto]

Selects the DMA mode.

Configuration options: [Auto] [SWDMA0] [SWDMA1] [SWDMA2] [MWDMA0] [MWDMA1] [MWDMA2] [UDMA0] [UDMA1] [UDMA2] [UDMA3] [UDMA4] [UDMA5]

SMART Monitoring [Auto]

Sets the Smart Monitoring, Analysis, and Reporting Technology. Configuration options: [Auto] [Disabled] [Enabled]

32Bit Data Transfer [Enabled]

Enables or disables 32-bit data transfer.

Configuration options: [Disabled] [Enabled]

4.3.5 IDE Configuration

The items in this menu allow you to set or change the configurations for the IDE devices installed in the system. Select an item then press <Enter> if you wish to configure the item.

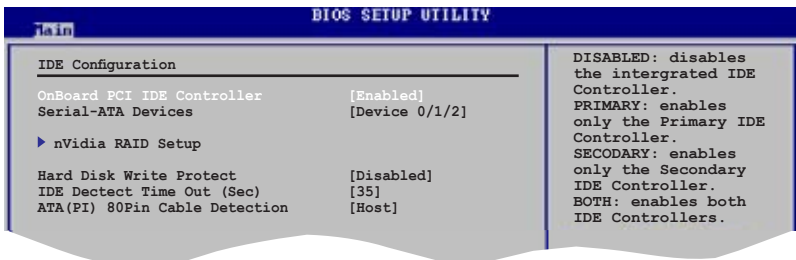

OnBoard PCI IDE Controller [Enabled]

Enables or disables primary IDE controllers.

Configuration options: [Disabled] [Enabled]

Serial-ATA Devices [Device 0/1/2]

Enables or disables the SATA0/1/2 IDE Interfaces.

Configuration options: [Disabled] [Device 0] [Device 0/1] [Device 0/1/2]

Hard Disk Write Protect [Disabled]

Enables or disables the device write protection. This will be effective only if device is accessed through BIOS. Configuration options: [Disabled] [Enabled]

IDE Detect Time Out [35]

Selects the time out value for detecting ATA/ATAPI devices. Configuration options: [0] [5] [10] [15] [20] [25] [30] [35]

ATA(PI) 80Pin Cable Detection [Host]

Selects the mechanism for detecting 80Pin ATA(PI) Cable. Configuration options: [Host & Device] [Host] [Device]

nVidia RAID Setup

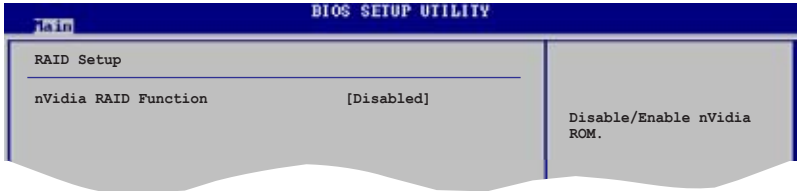

nVidia RAID Function [Disabled]

Enables or disables the NVIDIA® RAID function. Configuration options: [Disabled] [Enabled]



The following items appear when this item is Enabled.

SATA0 Primary Channel [Disabled]

Sets the SATA0 Primary Channel as RAID. Configuration options: [Disabled] [Enabled]

SATA0 Secondary Channel [Disabled]

Sets the SATA0 Secondary Channel as RAID. Configuration options: [Disabled] [Enabled]

SATA1 Primary Channel [Disabled]

Sets the SATA1 Primary Channel as RAID. Configuration options: [Disabled] [Enabled]

SATA1 Secondary Channel [Disabled]

Sets the SATA1 Secondary Channel as RAID. Configuration options: [Disabled] [Enabled]

SATA2 Primary Channel [Disabled]

Sets the SATA2 Primary Channel as RAID. Configuration options: [Disabled] [Enabled]

SATA2 Secondary Channel [Disabled]

Sets the SATA2 Secondary Channel as RAID.

Configuration options: [Disabled] [Enabled]

4.3.6 System Information

This menu gives you an overview of the general system specifications. The BIOS automatically detects the items in this menu.



AMI BIOS

Displays the auto-detected BIOS information

Processor

Displays the auto-detected CPU specification

System Memory

Displays the auto-detected system memory

4.4 Advanced menu

The Advanced menu items allow you to change the settings for the CPU and other system devices.



Take caution when changing the settings of the Advanced menu items. Incorrect field values can cause the system to malfunction.

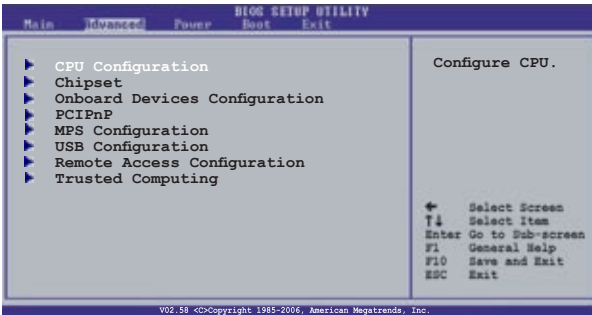

4.4.1 CPU Configuration

The items in this menu show the CPU-related information that the BIOS automatically detects.

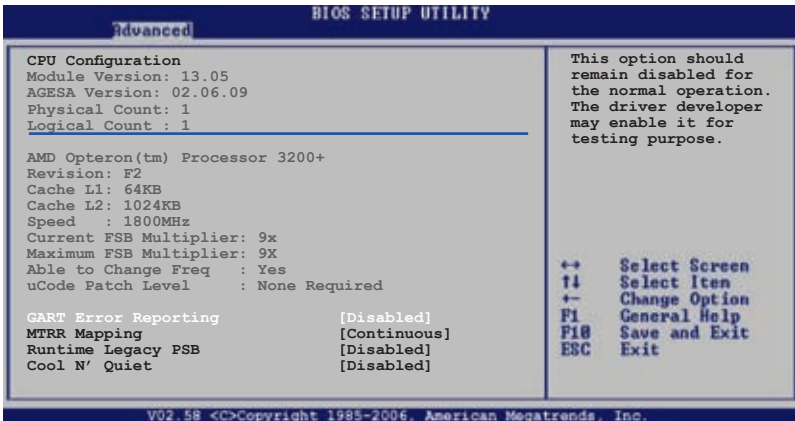

GART Error Reporting [Disabled]

Enables or disables the GART Error reporting feature.
Configuration options: [Disabled] [Enabled]

MTRR Mapping [Continuous]

Sets the method used for programming CPU MTRRs when 4GB or more memory is installed on the system. When set to Discrete, the BIOS leaves the PCI hole below the 4GB boundary undescribed. Set to Continuous to describe the PCI hole as non-cacheable.
Configuration options: [Continuous] [Discrete]

Runtime Legacy PSB [Disabled]

Enables or disables the generation of Power State Block for use of PowerNow™ driver in a single core system.
Configuration options: [Disabled] [Enabled]

AMD Cool 'n' Quiet Function [Disabled]

Enables or disables the AMD Cool 'n' Quiet technology.
Configuration options: [Disabled] [Enabled]

4.4.2 Chipset

The Chipset menu allows you to change the advanced chipset settings. Select an item then press <Enter> to display the sub-menu.

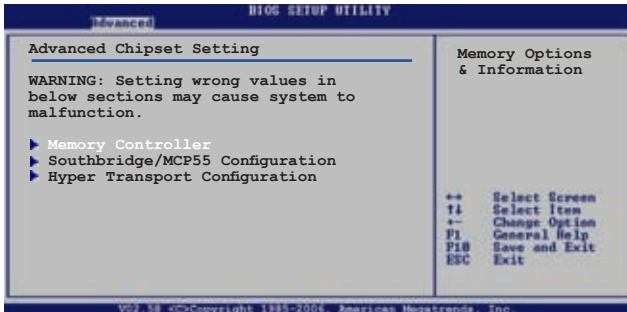

Memory Controller

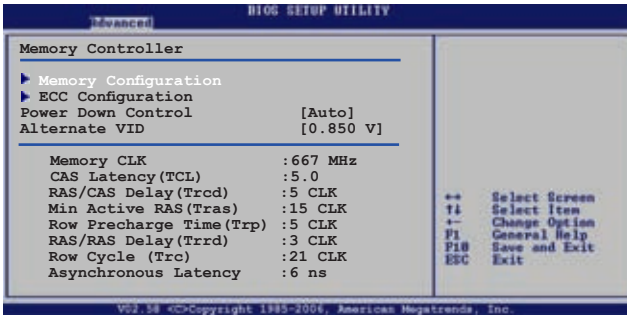

Memory Configuration

The memory configuration menu allows you to change the memory settings.

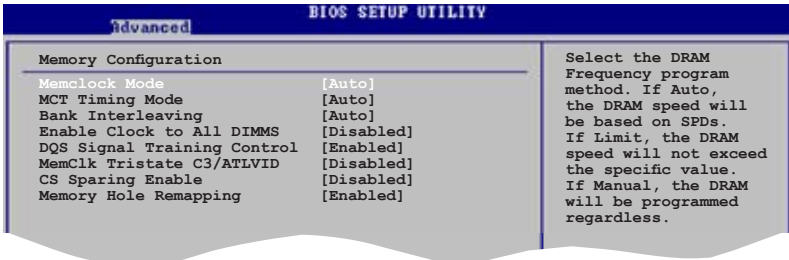

Memclock Mode [Auto]

Sets the memory clock mode.

Configuration options: [Auto] [Limit] [Manual]



The following item appears when the Memclock Mode is set to Limit or Manual.

Memclock Value [200 MHz]

Sets the memory clock mode limit.

Configuration options: [400 MHz] [533 MHz] [667 MHz] [800 MHz]

MCT Timing Mode [Auto]

Sets the MCT Timing Mode. Configuration options: [Auto] [Manual]

Bank Interleaving [Auto]

Allows you to enable the bank memory interleaving.

Configuration options: [Disabled] [Auto]

Enable Clock to All DIMMs [Disabled]

Configuration options: [Disabled] [Enabled]

DQS Signal Training Control [Enabled]

Enables or disables the DQS Signal Timing Training control.
Configuration options: [Disabled] [Enabled]

MemClk Tristate C3/ALTVID [Disabled]

Configuration options: [Disabled] [Enabled]

CS Sparing Enable [Disabled]

Configuration options: [Disabled] [Enabled]

Memory Hole Remapping [Enabled]

Enables or disables the memory remapping around memory hole.
Configuration options: [Disabled] [Enabled]

ECC Configuration

The ECC configuration menu allows you to change the ECC settings.

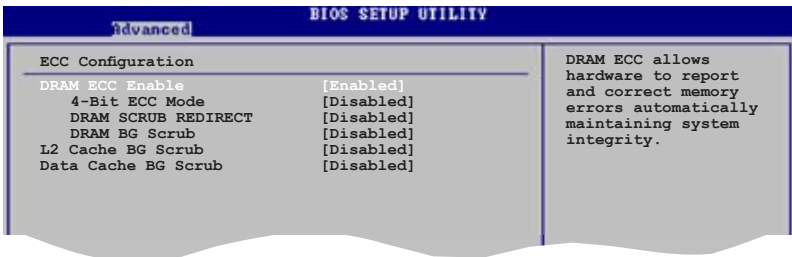

DRAM ECC Enable [Enabled]

Enables or disables the DRAM ECC that allows the hardware to report and correct memory errors automatically. Configuration options: [Disabled] [Enabled]

4-Bit ECC Mode (or ECC Chip Kill) [Disabled]

Enables or disables the ECC chip kill feature.
Configuration options: [Disabled] [Enabled]

DRAM SCRUB REDIRECT [Disabled]

Enables or disables the DRAM SCRUB REDIRECT feature that allows the system to correct the DRAM ECC errors immediately when they occur.
Configuration options: [Disabled] [Enabled]

DRAM BG SCRUB [Disabled]

Disables or sets the DRAM BG Scrub. Configuration options: [Disabled] [40ns] [80ns] [160ns] [320ns] [640ns] [1.28us] [2.56us] [5.12us] [10.2us] [20.5us] [41.0us] [81.9us] [163.8us] [327.7us] [655.4us]

L2 Cache BG Scrub [Disabled]

Disables or sets the L2 Cache BG Scrub. This item allows the cache RAM to be corrected when idle. Configuration options: [Disabled] [40ns] [80ns] [160na] [320ns] [640ns] [1.28us] [2.56us] [5.12us] [10.2us] [20.5us] [41.0us] [81.9us] [163.8us] [327.7us] [655.4us]

Data Cache BG Scrub [Disabled]

Disables or sets the Data Cache BG Scrub. This item allows the data cache BG Scrub RAM to be corrected when idle. Configuration options: [Disabled] [40ns] [80ns] [160na] [320ns] [640ns] [1.28us] [2.56us] [5.12us] [10.2us] [20.5us] [41.0us] [81.9us] [163.8us] [327.7us] [655.4us]

Power Down Control [Auto]

Allows the DIMMs to enter power down mode by deasserting the clock enable signal when DIMMs are not in use.

Configuration options: [Auto] [Disabled]

Alternate VID [0.850 V]

Allows you to specify the alternate VID in low power states.

Configuration options: [1.050 V] [1.025 V] [1.000 V] [0.975 V] [0.950 V] [0.925 V] [0.900 V] [0.875 V] [0.850 V] [0.825 V] [0.800 V]

SouthBridge / MCP55 Configuration

The SouthBridge Configuration menu allows you to change the SouthBridge settings.

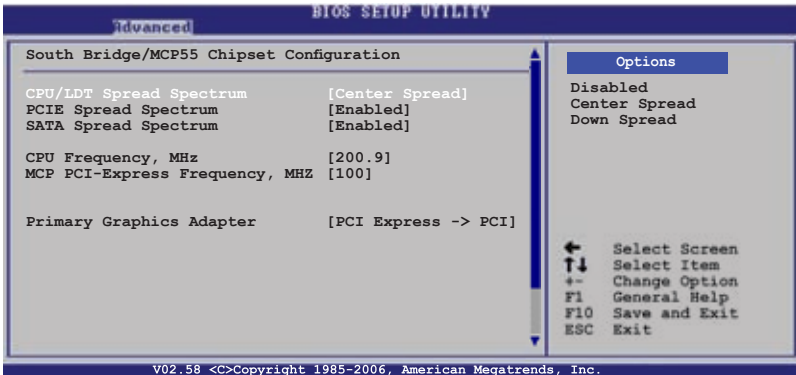

CPU/LTD Spread Spectrum [Disabled]

Sets or disables the processor or Lightning Data Transport (LTD) spread spectrum.

Configuration options: [Disabled] [Center Spread] [Down Spread]

PCI-Express Spread Spectrum [Enabled]

Enables or disables the PCI-Express spread spectrum.
Configuration options: [Disabled] [Enabled]

SATA Spread Spectrum [Enabled]

Enables or disables the SATA spread spectrum.
Configuration options: [Disabled] [Enabled]

CPU Frequency, MHz [200.9]

Allows you to set the CPU frequency.
Configuration options: [200.9] [201.0] [299.0] [300.0]

MCP PCI Express Frequency [100]

Allows you to set the PCI Express frequency.
Configuration options: [100] [101]...[145]

Primary Graphics Adapter [PCI Express -> PCI]

Allows you to select the primary graphics adapter.
Configuration options: [PCI Express -> PCI] [PCI -> PCI Express]

Hyper Transport Configuration

The sub-menu allows you to change the Hyper Transport settings.

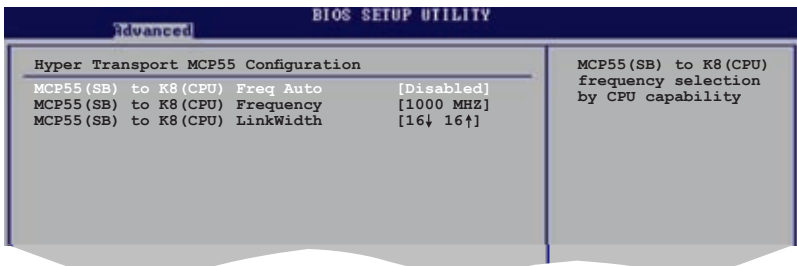

MCP55(SB) to K8(CPU) Freq Auto [Disabled]

Enables or disables the CPU to automatically adjust Hyper Transport frequency.
Configuration options: [Disabled] [Enabled]

MCP55(SB) to K8(CPU) Frequency [1000 MHz]

Allows you to set the Hyper Transport frequency. This item appears when you set the MCP55(SB) to K8(CPU) Freq Auto to Disabled.
Configuration options: [200 MHz] [400 MHz] [600 MHz] [800 MHz] [1000 MHz].

MCP55(SB) to K8(CPU) LinkWidth [16 ↑ 16 ↓]

Sets the Hyper Transport width.

Configuration options: [8 ↑ 8 ↓] [16 ↑ 16 ↓]

4.4.3 Onboard Devices Configuration

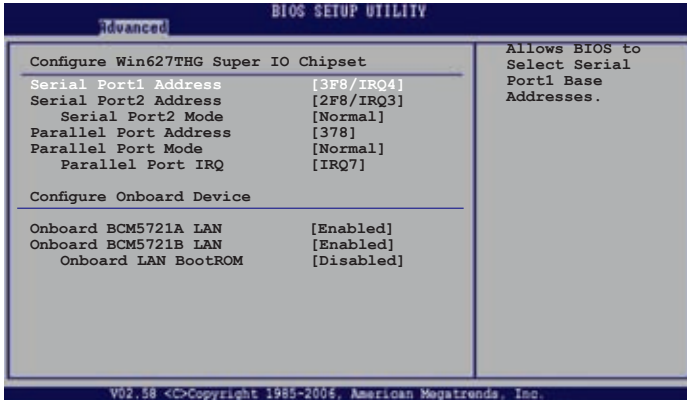

Serial Port1 Address [3F8/IRQ4]

Allows you to select the Serial Port1 base address.

Configuration options: [Disabled] [3F8/IRQ4] [3E8/IRQ4]

Serial Port2 Address [2F8/IRQ3]

Allows you to select the Serial Port2 base address.

Configuration options: [Disabled] [2F8/IRQ3] [2E8/IRQ3]

Serial Port2 Mode [Normal]

Allows you to set the BIOS selection mode for Serial Port2. Configuration options: [Normal] [IrDA][ASK IR]



The following items appear when the Serial Port2 Mode is set to IrDA or ASK IR.

IR I/O Pin Selec [SINB/SOUTB]

Allows you to select receiver or transmit pin for Serial Port2 (IR Mode).

Configuration options: [SINB/SOUTB] [IRRX/IRTX]

IR Duplex Mode [Half Duplex]

Allows you to select full or half duplex for Serial Port2 (IR Mode).

Configuration options: [Half Duplex] [Full Duplex]

Parallel Port Mode [Normal]

Allows you to select the Parallel Port mode.

Configuration options: [Normal] [EPP] [ECP] [EPP+ECP]

ECP Mode DMA Channel [DMA3]

Appears only when the Parallel Port Mode is set to [ECP] or [EPP+ECP].

This item allows you to set the Parallel Port ECP DMA. Configuration options: [DMA0] [DMA1] [DMA3]

EPP Version [1.9]

Appears only when the Parallel Port Mode is set to [EPP] or [EPP+ECP].

Configuration options: [1.9] [1.7]

Parallel Port IRQ [IRQ7]

Configuration options: [IRQ5] [IRQ7]controller.

Onboard BCM5721A LAN [Enabled]

Enable or disable the Onboard BCM5721LAN.

Configuration options: [Disabled] [Enabled]

Onboard LAN Boot ROM [Disabled]

Allows you to enable or disable the option ROM in the onboard LAN controller. Configuration options: [Disabled] [Enabled]

4.4.4 PCI PnP

The PCI PnP menu items allow you to change the advanced settings for PCI/PnP devices. The menu includes setting IRQ and DMA channel resources for either PCI/PnP or legacy ISA devices, and setting the memory size block for legacy ISA devices.



Take caution when changing the settings of the PCI PnP menu items. Incorrect field values can cause the system to malfunction.

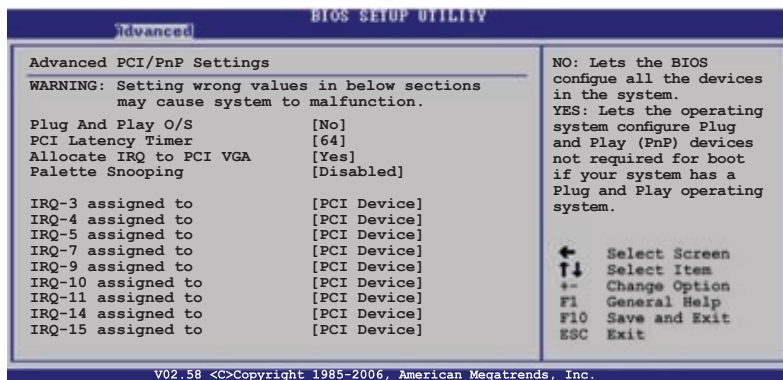

Plug And Play O/S [No]

When set to [No], BIOS configures all the devices in the system. When set to [Yes] and if you install a Plug and Play operating system, the operating system configures the Plug and Play devices not required for boot. Configuration options: [No] [Yes]

PCI Latency Timer [64]

Allows you to select the value in units of PCI clocks for the PCI device latency timer register. Configuration options: [32] [64] [96] [128] [160] [192] [224] [248]

Allocate IRQ to PCI VGA [Yes]

When set to [Yes], BIOS assigns an IRQ to PCI VGA card if the card requests for an IRQ. When set to [No], BIOS does not assign an IRQ to the PCI VGA card even if requested. Configuration options: [No] [Yes]

Palette Snooping [Disabled]

When set to [Enabled], the palette snooping feature informs the PCI devices that an ISA graphics device is installed in the system so that the latter can function correctly. Configuration options: [Disabled] [Enabled]

IRQ-xx assigned to [PCI Device]

When set to [PCI Device], the specific IRQ is free for use of PCI/PnP devices.
When set to [Reserved], the IRQ is reserved for legacy ISA devices. Configuration options: [PCI Device] [Reserved]

4.4.5 MPS Configuration

The items in this menu allows you to configure the Multi-Processor Table. Select an item then press <Enter> to display the configuration options.

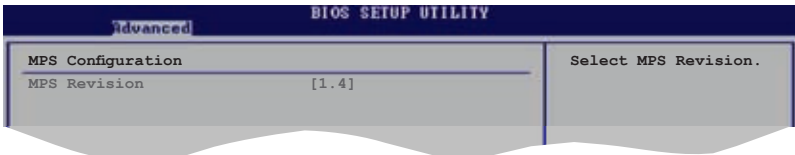

MPS Revision [1.4]

Allows you to select the multi-processor system revision.
Configuration options: [1.1] [1.4]

4.4.6 USB Configuration

The items in this menu allows you to change the USB-related features. Select an item then press <Enter> to display the configuration options.

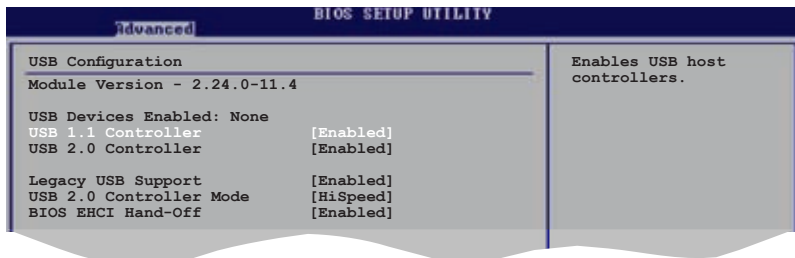



The Module Version and USB Devices Enabled items show the auto-detected values. If no USB device is detected, the USB Devices Enabled item shows None.

USB 1.1 Controller [Enabled]

Enables or disables the USB 1.1 Controller.

Configuration options: [Disabled] [Enabled]

USB 2.0 Controller [Enabled]

Enables or disables the USB 2.0 Controller.

Configuration options: [Disabled] [Enabled]

Legacy USB Support [Enabled]

Allows you to enable or disable support for legacy USB devices. Setting to [Auto] allows the system to detect the presence of USB devices at startup. If detected, the USB controller legacy mode is enabled. If no USB device is detected, the legacy USB support is disabled.

Configuration options: [Disabled] [Enabled] [Auto]

USB 2.0 Controller Mode [HiSpeed]

Allows you to set the USB 2.0 controller mode to HiSpeed (480 Mbps) or FullSpeed (12 Mbps). Configuration options: [HiSpeed] [FullSpeed]

BIOS EHCI Hand-Off [Enabled]

Enables or disables the BIOS EHCI hand-off feature.

Configuration options: [Enabled] [Disabled]

4.4.7 Remote Access Configuration

The items in this menu allows you to configure the Remote Access type and parameters.

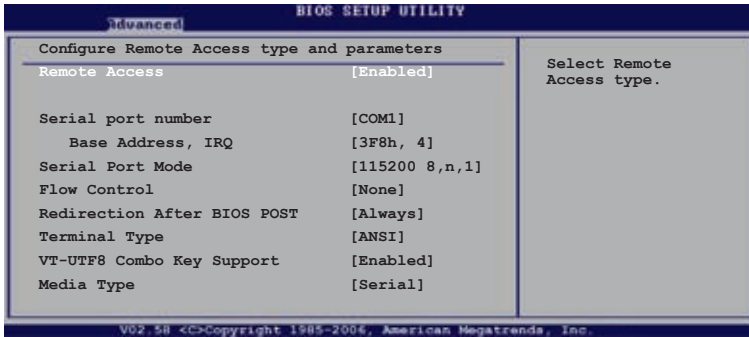

When enabled, the following Remote Access types and parameters appear.

Remote Access Type [Enabled]

Allows you to set the Remote Access Type.

Configuration options: [Disabled] [Enabled]

Serial port number [COM1]

Allows you to select the Serial Port for console redirection.

Configuration options: [COM1] [COM2]

Serial Port Mode [115200 8,n,1]

Allows you to select the Serial Port settings.

Configuration options: [115200 8,n,1] [57600 8,n,1] [38400 8,n,1] [19200 8,n,1] [09600 8,n,1]

Flow Control [None]

Allows you to select the Flow Control for console redirection.

Configuration options: [None] [Hardware] [Software]

Redirection After BIOS POST [Always]

When set to [Boot Loader], console redirection is active during POST and during Boot Loader. When set to [Always], redirection is always active. When set to [Disabled], redirection is turned off after POST.

Configuration options: [Disabled] [Boot Loader] [Always]

Terminal Type [ANSI]

Allows you to select the target terminal type.

Configuration options: [ANSI] [VT100] [VT-UTF8]

VT-UTF8 Combo Key Support [Enabled]

Allows you to enable or disable the VTF-UTF8 Combination Key Support for ANSI/VT100 terminals.

Configuration options: [Disabled] [Enabled]

Media Type [Serial]

Allows you to select the media for console redirection.

Configuration options: [Serial] [LAN] [Serial + LAN]

4.5 Power menu

The Power menu items allow you to change the settings for the ACPI and Advanced Power Management (APM) features. Select an item then press <Enter> to display the configuration options.



4.5.1 ACPI APIC Support [Enabled]

Allows you to enable or disable the Advanced Configuration and Power Interface (ACPI) support in the Application-Specific Integrated Circuit (ASIC). When set to Enabled, the ACPI APIC table pointer is included in the RSDT pointer list. Configuration options: [Disabled] [Enabled]



Do not change the ACPI APIC support after you have installed the operating system (OS), otherwise, a boot failure may occur.

4.5.2 ACPI MCFG Support [Enabled]

Allows you to enable or disable the Memory Mapped Configuration (MCFG) support. When set to Enabled, the MCFG table pointer is included in the RSDT pointer list. Configuration options: [Disabled] [Enabled]

4.5.3 APM Configuration

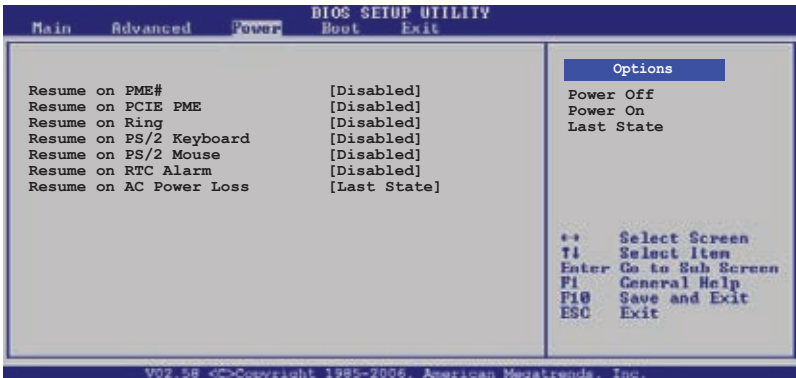

Resume on PME# [Disabled]

Enables or disables the PCI PME (PCI Device and Onboard LAN) to generate a wake event.

Configuration options: [Enabled] [Disabled]

Resume on PCIE PME [Disabled]

Enables or disables the PCI PME (PCI Device and Onboard LAN) to generate a wake event.

Configuration options: [Enabled] [Disabled]

Resume on Ring [Disabled]

Allows you to enable or disable the RI to generate a wake event.

Configuration options: [Enabled] [Disabled]

Resume on PS/2 Keyboard [Disabled]

Allows you to disable or enable the PS/2 Power-On by keyboard feature. This feature requires an ATX power supply that provides at least 1A on the +5VSB lead.

Configuration options: [Disabled] [Enabled]

Resume on PS/2 Mouse [Disabled]

When set to [Enabled], this parameter allows you to use the PS/2 mouse to turn on the system. This feature requires an ATX power supply that provides at least 1A on the +5VSB lead.

Configuration options: [Enabled] [Disabled]

Resume on RTC Alarm [Disabled]

Allows you to enable or disable RTC to generate a wake event. When this item is set to [Enabled], the items RTC Alarm Date, RTC Alarm Hour, RTC Alarm Minute, and RTC Alarm Second appear with set values.

Configuration options: [Enabled] [Disabled]

Resume on AC Power Loss [Disabled]

When set to Power Off, the system goes into off state after an AC power loss.

When set to Power On, the system goes on after an AC power loss. When set to Last State, the system goes into either off or on state, whatever the system state was before the AC power loss.

Configuration options: [Power Off] [Power On] [Last State]

4.5.4 Hardware Monitor

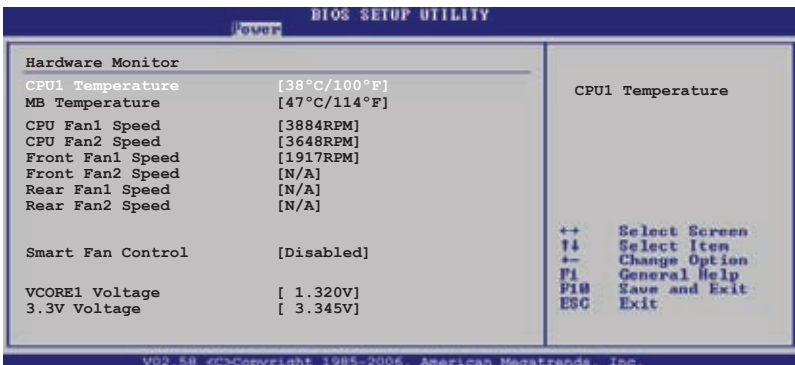

CPU1 [xxx°C/xxx°F]

MB Temperature [xxx°C/xxx°F]

The onboard hardware monitor automatically detects and displays the motherboard and CPU temperature. Select [Ignored] if you do not wish to display the detected temperatures.

CPU Fan1/Fan2 Speed [xxxxRPM] or [Ignored]

Front Fan1/Fan2 Speed [xxxxRPM] or [Ignored]

Rear Fan1/Fan2 Speed [xxxxRPM] or [Ignored]

The onboard hardware monitor automatically detects and displays the CPU, front, and rear fan speed in rotations per minute (RPM). If the fan is not connected to the motherboard, the field shows N/A. Select [Ignored] if you do not wish to display the detected temperatures.

Smart Fan Control [Enabled]

Allows you to enable or disable the ASUS Smart Fan feature that smartly adjusts the fan speeds for more efficient system operation. Configuration options:
[Disabled] [Enabled]

The **CPU Target Temperature** and **MB Target Temperature** items appear when you enabled the Smart Fan Control feature.

CPU Target Temperature [XXX]

MB Target Temperature [XXX]

Allows you to set the CPU and system threshold temperature before the Smart Fan Control is disabled.

VCORE1 Voltage, 3.3V Voltage, 5V Voltage, 5VSB Voltage, VBAT Voltage, 12V Voltage

The onboard hardware monitor automatically detects the voltage output through the onboard voltage regulators.

4.6 Boot menu

The Boot menu items allow you to change the system boot options. Select an item then press <Enter> to display the sub-menu.

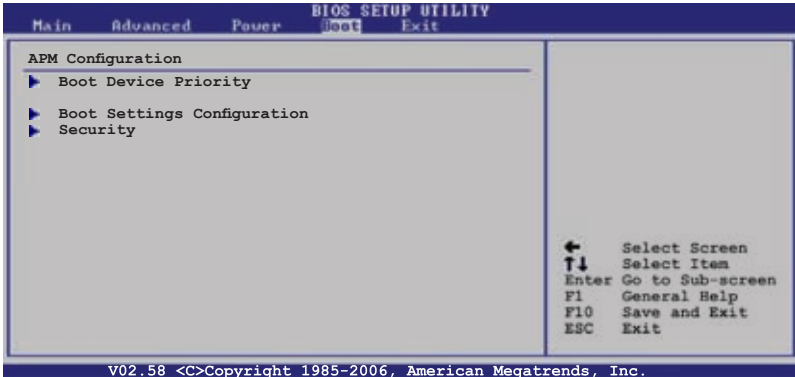

4.6.1 Boot Device Priority

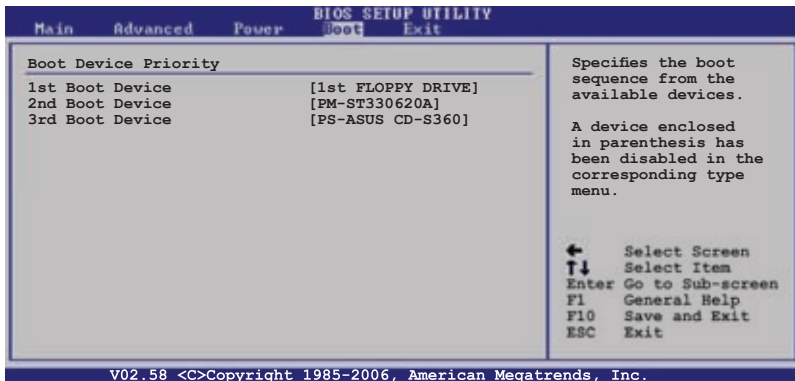

1st ~ xxth Boot Device [1st Floppy Drive]

These items specify the boot device priority sequence from the available devices. The number of device items that appears on the screen depends on the number of devices installed in the system.

Configuration options: [xxxxx Drive] [Disabled]

4.6.2 Boot Settings Configuration

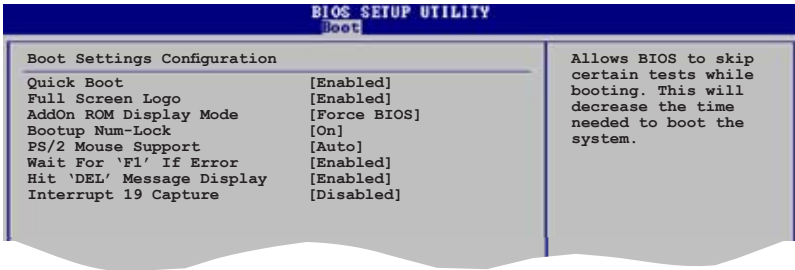

Quick Boot [Enabled]

Enabling this item allows the BIOS to skip some power on self tests (POST) while booting to decrease the time needed to boot the system. When set to [Disabled], BIOS performs all the POST items.

Configuration options: [Disabled] [Enabled]

Full Screen Logo [Enabled]

Allows you to enable or disable the full screen logo display feature. Configuration options: [Disabled] [Enabled]



Set this item to [Enabled] to use the ASUS MyLogo2™ feature.

Add On ROM Display Mode [Force BIOS]

Sets the display mode for option ROM.

Configuration options: [Force BIOS] [Keep Current]

Bootup Num-Lock [On]

Allows you to select the power-on state for the NumLock.

Configuration options: [Off] [On]

PS/2 Mouse Support [Auto]

Allows you to enable or disable support for PS/2 mouse.

Configuration options: [Disabled] [Enabled] [Auto]

Wait for 'F1' If Error [Enabled]

When set to Enabled, the system waits for the F1 key to be pressed when error occurs. Configuration options: [Disabled] [Enabled]

Hit 'DEL' Message Display [Enabled]

When set to Enabled, the system displays the message "Press DEL to run Setup" during POST. Configuration options: [Disabled] [Enabled]

Interrupt 19 Capture [Disabled]

When set to [Enabled], this function allows the option ROMs to trap Interrupt 19. Configuration options: [Disabled] [Enabled]

4.6.3 Security

The Security menu items allow you to change the system security settings. Select an item then press <Enter> to display the configuration options.

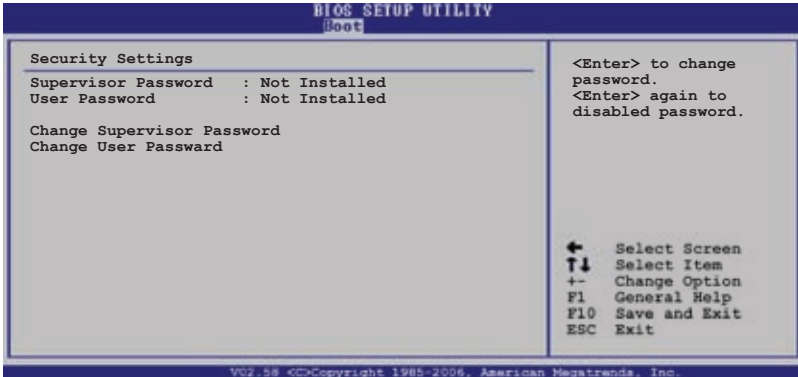

Change Supervisor Password

Select this item to set or change the supervisor password. The Supervisor Password item on top of the screen shows the default Not Installed. After you set a password, this item shows Installed.

To set a Supervisor Password:

1. Select the Change Supervisor Password item, then press <Enter>.
2. From the password box, type a password composed of at least six letters and/or numbers, then press <Enter>.
3. Confirm the password when prompted.

The message "Password Installed" appears after you successfully set your password.

To change the supervisor password, follow the same steps as in setting a user password.

To clear the supervisor password, select the Change Supervisor Password then press <Enter>. The message "Password Uninstalled" appears.



If you forget your BIOS password, you can clear it by erasing the CMOS Real Time Clock (RTC) RAM. See section "2.6 Jumpers" for information on how to erase the RTC RAM.

After you have set a supervisor password, the other items appear to allow you to change other security settings.

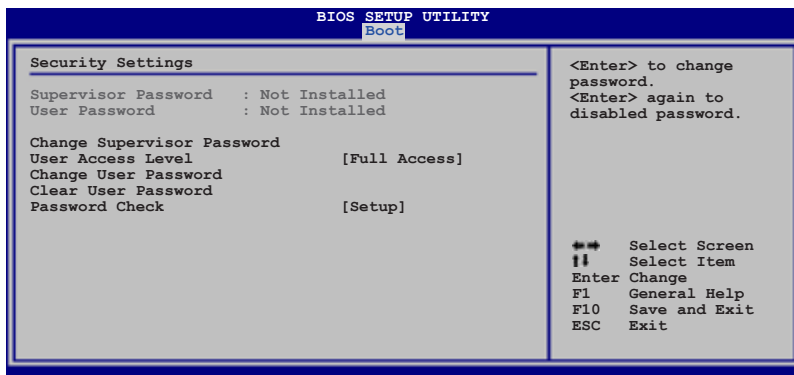

User Access Level [Full Access]

This item allows you to select the access restriction to the Setup items. Configuration options: [No Access] [View Only] [Limited] [Full Access]

No Access prevents user access to the Setup utility.

View Only allows access but does not allow change to any field.

Limited allows changes only to selected fields, such as Date and Time.

Full Access allows viewing and changing all the fields in the Setup utility.

Change User Password

Select this item to set or change the user password. The User Password item on top of the screen shows the default Not Installed. After you set a password, this item shows Installed.

To set a User Password:

1. Select the Change User Password item and press <Enter>.
2. On the password box that appears, type a password composed of at least six letters and/or numbers, then press <Enter>.
3. Confirm the password when prompted.

The message "Password Installed" appears after you set your password successfully.

To change the user password, follow the same steps as in setting a user password.

Clear User Password

Select this item to clear the user password.

Password Check [Setup]

When set to [Setup], BIOS checks for user password when accessing the Setup utility. When set to [Always], BIOS checks for user password both when accessing Setup and booting the system.

Configuration options: [Setup] [Always]

4.7 Exit menu

The Exit menu items allow you to load the optimal or failsafe default values for the BIOS items, and save or discard your changes to the BIOS items.

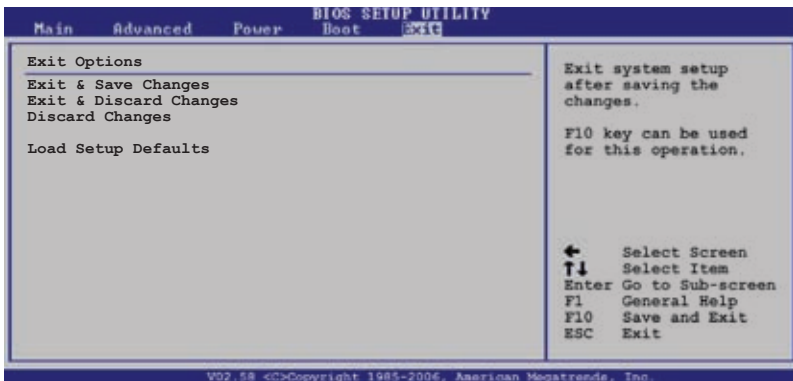

Pressing <Esc> does not immediately exit this menu. Select one of the options from this menu or <F10> from the legend bar to exit.

Exit & Save Changes

Once you are finished making your selections, choose this option from the Exit menu to ensure the values you selected are saved to the CMOS RAM. An onboard backup battery sustains the CMOS RAM so it stays on even when the computer is turned off. When you select this option, a confirmation window appears. Select **Ok** to save the changes and exit.



If you attempt to exit the Setup program without saving your changes, the program prompts you with a message asking if you want to save your changes before exiting. Press <Enter> to save the changes while exiting.

Exit & Discard Changes

Select this option only if you do not want to save the changes that you made to the Setup program. If you made changes to fields other than System Date, System Time, and Password, the BIOS asks for a confirmation before exiting.

Discard Changes

Allows you to discard the selections you made and restore the previously saved values. After selecting this option, a confirmation appears. Select **Ok** to discard any changes and load the previously saved values.

Load Setup Defaults

Allows you to load the default values for each of the parameters on the Setup menus. When you select this option or if you press <F5>, a confirmation window appears. Select **Ok** to load default values. Select **Exit & Save Changes** or make other changes before saving the values to the non-volatile RAM.

This chapter describes the contents of the support CD that comes with the motherboard package.

5 Software support

5.1	Installing an operating system	5-1
5.2	Support CD information	5-1
5.3	Software information	5-7
5.4	RAID configurations	5-9
5.5	Creating a RAID driver disk.....	5-18

5.1 Installing an operating system

This motherboard supports Windows® 2000, and Windows® 32/64-bit 2003 operating systems (OS). Always install the latest OS version and corresponding updates to maximize the features of your hardware.



- Motherboard settings and hardware options vary. Use the setup procedures presented in this chapter for reference only. Refer to your OS documentation for detailed information.
- Make sure that you install Windows® 2000 Service Pack 4 or the Windows® 32/64-bit 2003 before installing the drivers for better compatibility and system stability.

5.2 Support CD information

The support CD that came with the motherboard package contains the drivers, software applications, and utilities that you can install to avail all motherboard features.



The contents of the support CD are subject to change at any time without notice. Visit the ASUS website(www.asus.com) for updates.

5.2.1 Running the support CD

Place the support CD to the optical drive. The CD automatically displays the Drivers menu if Autorun is enabled in your computer.

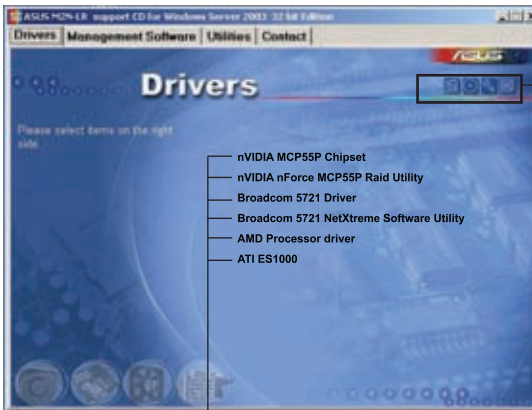

Click an icon to display support CD/motherboard information

Click an item to install



If Autorun is NOT enabled in your computer, browse the contents of the support CD to locate the file ASSETUP.EXE from the BIN folder. Double-click the ASSETUP.EXE to run the CD.

5.2.2 Drivers menu

The drivers menu shows the available device drivers if the system detects installed devices. Install the necessary drivers to activate the devices.

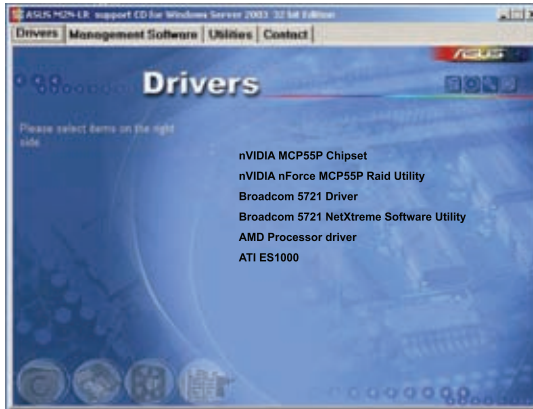

Nvidia MCP55P Chipset

Installs the NVIDIA® MCP55P Chipset driver.

Nvidia nForce™ MCP55P RAID Utility

Installs the NVIDIA® MediaShield RAID Management Utility.

Broadcom 5721 Driver

Installs the Broadcom 5721 driver.

Broadcom 5721 NetXtreme Software Utility

Installs the Broadcom 5721 NetXtreme software utility. Refer to the application help file for details.

AMD Process driver

Installs the AMD processor driver.

ATI ES1000

Installs the ATI ES1000 display driver.

5.2.3 Management Software menu

The Management Software menu displays all the available server management software applications.

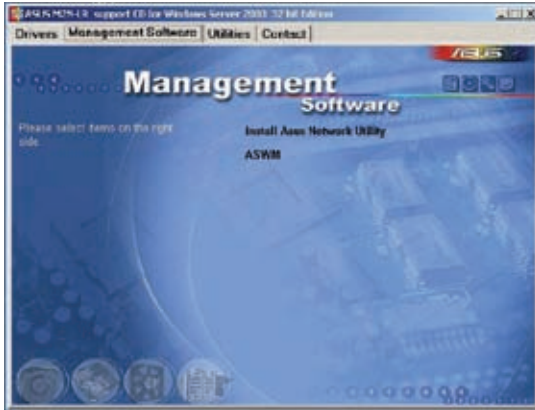

Install ASUS Network Utility

Install the ASUS Network Utility. Refer to the application help file for details.

ASWM

Installs the ASUS web-based management system.

5.2.4 Utilities menu

The Utilities menu shows the applications and other software that the motherboard supports.



ADOBE Acrobat V7.0

Installs the Adobe® Acrobat® Reader that allows you to open, view, and print documents in Portable Document Format (PDF).

Microsoft DirectX 9.0c

Installs the Microsoft® DirectX 9.0c driver. The Microsoft DirectX® 9.0c is a multimedia technology that enhances computer graphics and sound. DirectX® improves the multimedia features of your computer so you can enjoy watching TV and movies, capturing videos, or playing games in your computer. Visit the Microsoft website (www.microsoft.com) for updates.

ASUS Screen Saver

Bring life to your computer screen by installing the ASUS screen saver.

ASUS Update

The ASUS Update utility allows you to update the motherboard BIOS in Windows® environment. This utility requires an Internet connection either through a network or an Internet Service Provider (ISP).

5.2.5 ASUS Contact information

Click the Contact tab to display the ASUS contact information. You can also find this information on the inside front cover of this user guide.

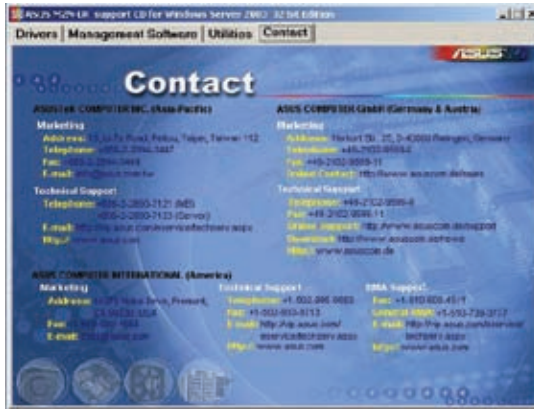

5.2.6 Other information

The icons on the top right corner of the screen give additional information on the motherboard and the contents of the support CD. Click an icon to display the specified information.

Motherboard Info

Displays the general specifications of the motherboard.

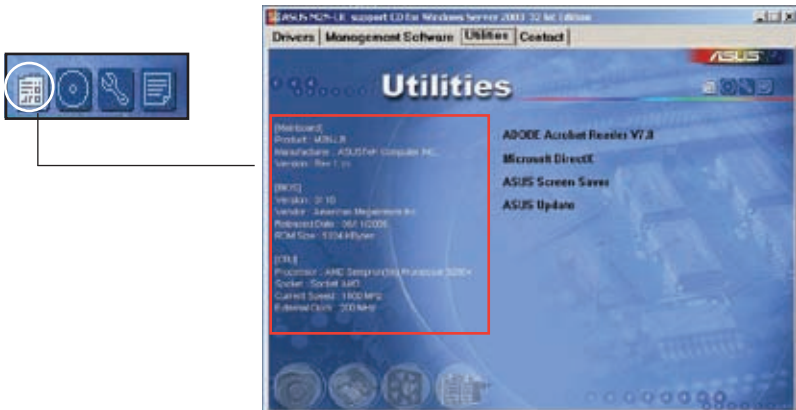

Browse this CD

Displays the support CD contents in graphical format.

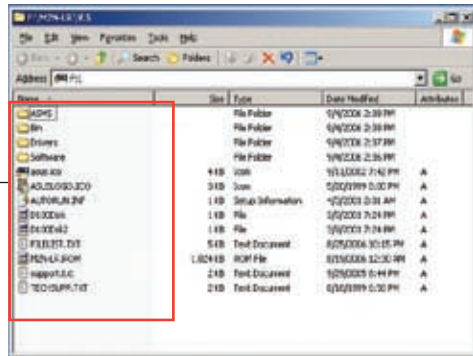

Technical support Form

Displays the ASUS Technical Support Request Form that you have to fill out when requesting technical support.

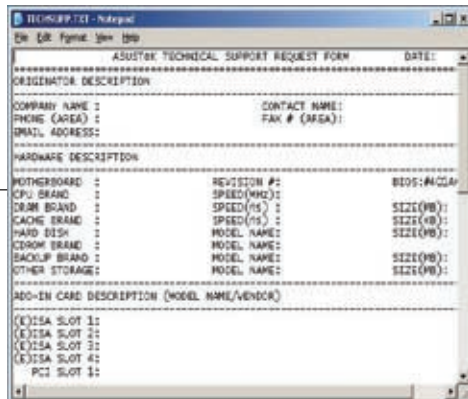

ASUSTEK TECHNICAL SUPPORT REQUEST FORM DATE: _____

ORIGINATOR DESCRIPTION

COMPANY NAME : _____ CONTACT NAME : _____
PHONE (AREA) : _____ FAX # (AREA) : _____
EMAIL ADDRESS : _____

HARDWARE DESCRIPTION

MOTHERBOARD : _____ REVISION # : _____ BEES: #/G/L/P
CPU BRAND : _____ SPEED(MHZ) : _____
DRAM BRAND : _____ SPEED(MS) : _____ SIZE(MB) : _____
CACHE BRAND : _____ SPEED(MS) : _____ SIZE(MB) : _____
HARD DISK : _____ MODEL NAME : _____ SIZE(MB) : _____
STORGE BRAND : _____ MODEL NAME : _____ SIZE(MB) : _____
OTHER STORAGE : _____ MODEL NAME : _____ SIZE(MB) : _____

ADD-IN CARD DESCRIPTION (MODEL NAME/VENDOR)

(E)ISA SLOT 1 : _____
(E)ISA SLOT 2 : _____
(E)ISA SLOT 3 : _____
(E)ISA SLOT 4 : _____
PCI SLOT 1 : _____

5.3 Software information

Most of the applications in the support CD have wizards that will conveniently guide you through the installation. View the online help or readme file that came with the software application for more information.

5.3.1 Cool 'n' Quiet!™ Technology

The motherboard supports the AMD Cool 'n' Quiet!™ Technology that dynamically and automatically change the CPU speed, voltage, and amount of power depending on the task the CPU performs.

Enabling Cool 'n' Quiet!™ Technology

To enable Cool 'n' Quiet!™ Technology:

1. Turn on the system and enter BIOS by pressing the key during the Power On Self-Tests (POST).
2. Go to Advanced -> CPU Configuration -> AMD K8 Cool 'n'Quiet Control and set it to [Enabled]. See section "4.4 Advanced Menu."
3. In the Power menu, select the item ACPI 2.0 Support and set it to [Enabled]. See section "4.5 Power Menu."
4. Save your changes and exit BIOS Setup.
5. Reboot your computer and set your Power Option Properties depending on your operating system.

Windows® 2000/2003

1. From the Windows® 2000/2003 operating system, click the Start button. Select Settings, then Control Panel.
2. Make sure the Control Panel is set to Classic View.
3. Double-click the Display icon in the Control Panel then select the Screen Saver tab.
4. Click the Power... button. The following dialog box appears.
5. From the Power schemes combo list box, select Minimal Power Management.
6. Click OK to effect settings.

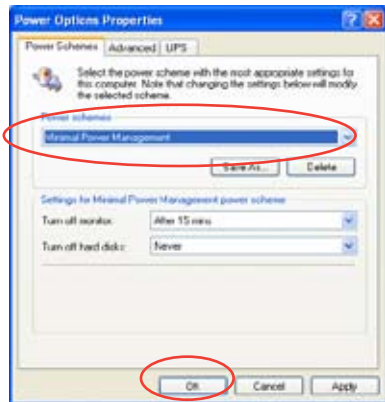

Make sure to install the Cool 'n' Quiet!™ driver and application before using this feature.

Windows® 98 SE/Me

1. From the Windows® 98 SE/Me operating system, click the Start button. Select Settings, then Control Panel.
2. Double-click the Display icon in the Control Panel then select the Screen Saver tab.
3. From the Energy saving features of monitor group, click the Settings button.



4. From the Power Options Properties dialog box, select the AMD's Cool 'n' Quiet(tm) Technology tab.
5. Click the Performance combo list box to select desired mode. Automatic Mode is the recommended setting.
6. Click OK to effect settings.

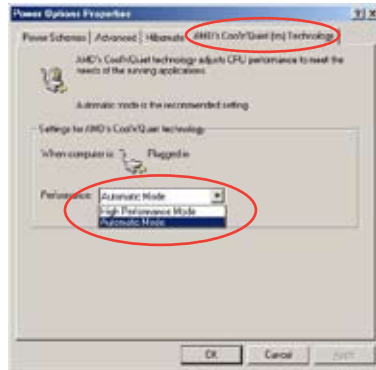

- Make sure to install the AMD Cool 'n' Quiet!™ driver and application before using this feature.
- The AMD Cool 'n' Quiet!™ technology feature works only with the AMD heatsink and fan assembly with monitor chip
- If you purchased a separate heatsink and fan package, use the ASUS Q-Fan technology feature to automatically adjust the CPU fan speed according to your system loading.

5.4 RAID configurations

The motherboard comes with the NVIDIA® nForce™ 570 SLI MCP (MCP55P) RAID utility that allow you to configure Serial ATA hard disk drives as RAID sets. The motherboard supports the following RAID configurations.

RAID 0 (*Data striping*) optimizes two identical hard disk drives to read and write data in parallel, interleaved stacks. Two hard disks perform the same work as a single drive but at a sustained data transfer rate, double that of a single disk alone, thus improving data access and storage. Use of two new identical hard disk drives is required for this setup.

RAID 1 (*Data mirroring*) copies and maintains an identical image of data from one drive to a second drive. If one drive fails, the disk array management software directs all applications to the surviving drive as it contains a complete copy of the data in the other drive. This RAID configuration provides data protection and increases fault tolerance to the entire system. Use two new drives or use an existing drive and a new drive for this setup. The new drive must be of the same size or larger than the existing drive.

RAID 5 stripes both data and parity information across three or more hard disk drives. Among the advantages of RAID 5 configuration include better HDD performance, fault tolerance, and higher storage capacity. The RAID 5 configuration is best suited for transaction processing, relational database applications, enterprise resource planning, and other business systems. Use a minimum of three identical hard disk drives for this setup.

RAID 10 is a striped configuration with RAID 1 segments whose segments are RAID 1 arrays. This configuration has the same fault tolerance as RAID 1, and has the same overhead for fault-tolerance as mirroring alone. RAID 10 achieves high input/output rates by striping RAID 1 segments. In some instances, a RAID 10 configuration can sustain multiple simultaneous drive failure. A minimum of four hard disks is required for this setup.



If you want to boot the system from a hard disk drive included in a created RAID set, copy first the RAID driver from the support CD to a floppy disk before you install an operating system to the selected hard disk drive.

JBOD (*Spanning*) stands for Just a Bunch of Disks and refers to hard disk drives that are not yet configured as a RAID set. This configuration stores the same data redundantly on multiple disks that appear as a single disk on the operating system. Spanning does not deliver any advantage over using separate disks independently and does not provide fault tolerance or other RAID performance benefits.



If you want to boot the system from a hard disk drive included in a RAID set, copy first the RAID driver from the support CD to a floppy disk before you install an operating system to a selected hard disk drive. Refer to section “5.6 Creating a RAID driver disk” for details.

5.4.1 Installing hard disks

The motherboard supports Serial ATA hard disk drives. For optimal performance, install identical drives of the same model and capacity when creating a disk array.

Installing Serial ATA (SATA) hard disks

To install the SATA hard disks for a RAID configuration:

1. Install the SATA hard disks into the drive bays.
2. Connect the SATA signal cables.
3. Connect a SATA power cable to the power connector on each drive.



Refer to the RAID controllers user manual in the motherboard support CD for detailed information on RAID configurations. See section “5.2.4 Manuals menu.”

5.4.2 NVIDIA® MediaShield™ RAID configurations

The motherboard includes a high performance SATA RAID controller integrated in the NVIDIA® nForce™ 570 SLI southbridge chipset. It supports RAID 0, RAID 1, RAID 0+1, RAID 5 and JBOD for six independent Serial ATA channels.

Setting the BIOS RAID items

After installing the hard disk drives, make sure to set the necessary RAID items in the BIOS before setting your RAID configuration.

To set the BIOS RAID items:

1. Boot the system and press during the Power-On Self-Test (POST) to enter the BIOS Setup Utility.
2. From the Main > IDE Configuration menu item in the BIOS set the nVidia RAID Function item to Enabled.
3. Select and enable the SATA drive(s) that you want to configure as RAID. See section “4.3.5 IDE Configuration” for details.
4. Save your changes and Exit Setup.



Make sure to re-enter your NVRAID settings after the CMOS is cleared; otherwise, the system will not recognize your RAID setup.



- For detailed descriptions on the NVIDIA® RAID configuration, refer to the “NVIDIA® MediaShield RAID User’s Manual” found in your motherboard support CD.
 - When using Windows 2000 operating system, make sure to install the Windows 2000 Service Pack 4 or later versions.
-

Entering the NVIDIA® MediaShield RAID utility

To enter the NVIDIA® RAID utility:

1. Boot up your computer.
2. During POST, press <F10> to display the main menu of the utility.



The RAID BIOS setup screens shown in this section are for reference only, and may not exactly match the items on your screen.

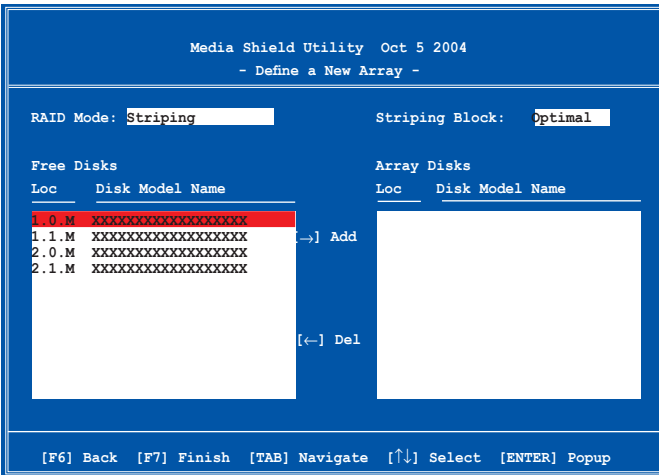

At the bottom of the screen are the navigation keys. These keys allow you to move through and select menu options.

Creating a RAID Volume

To create a RAID volume:

1. From the NVIDIA® RAID utility Define a New Array menu, select RAID Mode then press <Enter>. The following submenu appears.

Use the up or down arrow keys to select a RAID mode then press <Enter>.

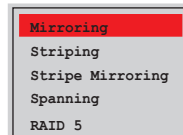

2. Press <TAB> select the Striping Block then press <Enter>. The following submenu appears:

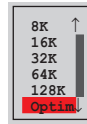

If you selected Striping or Stripe Mirroring, use the up or down arrow keys to select the stripe size for your RAID 0 array then press <Enter>. The available values range from 8 KB to 128 KB. The default selection is 128 KB. The stripe value should be chosen based on the planned drive usage.

- 8 /16 KB - low disk usage
- 64 KB - typical disk usage
- 128 KB - performance disk usage



TIP: For server systems, we recommend using a lower array block size. For multimedia computer systems used mainly for audio and video editing, we recommend a higher array block size for optimum performance.

3. Press <TAB> to select the Free Disks area. Use the left or right arrow keys to assign the array disks.
4. Press <F7> to create RAID set. The following message box appears.

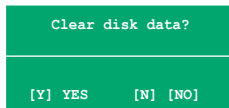

5. Press <Y> to clear the selected disks or <N> to proceed without clearing the disks. The following screen appears.



Take caution in using this option. All data on the RAID drives will be lost!

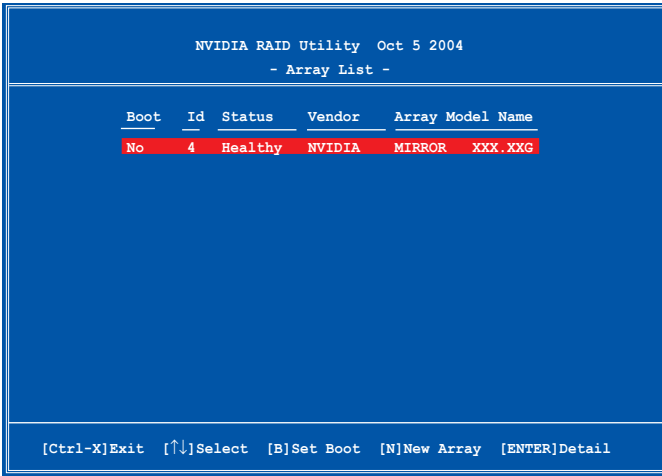

A new set of navigation keys is displayed on the bottom of the screen.

6. Press <Ctrl+X> to save settings and exit.

Rebuilding a RAID array

To rebuild a RAID array:

1. From the Array List menu, use the up or down arrow keys to select a RAID array then press <Enter>. The RAID Array details appear.

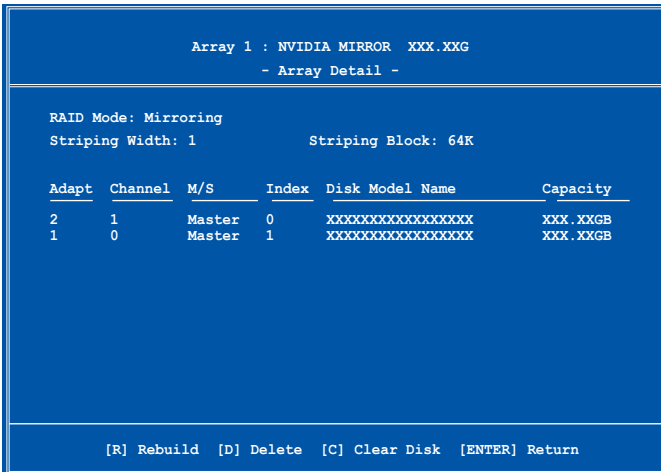

- A new set of navigation keys is displayed on the bottom of the screen.
2. Press <R> to rebuild a RAID array. The following screen appears.

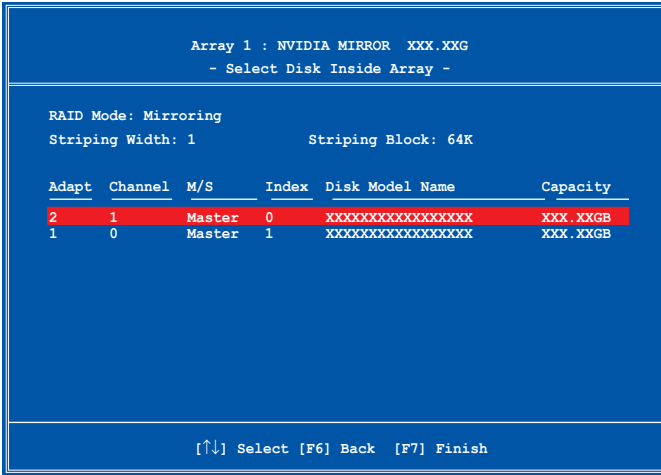

3. Use the up or down arrow keys to select a RAID array to rebuild, then press <F7>. The following confirmation message appears.

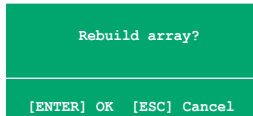

4. Press <Enter> to start rebuilding array or press <Esc> to cancel.
5. After the rebuild process, the Array list menu appears.

Deleting a RAID array

To delete a RAID array:

1. From the Array List menu, use the up or down arrow keys to select a RAID array then press <Enter>. The RAID Array details appear.

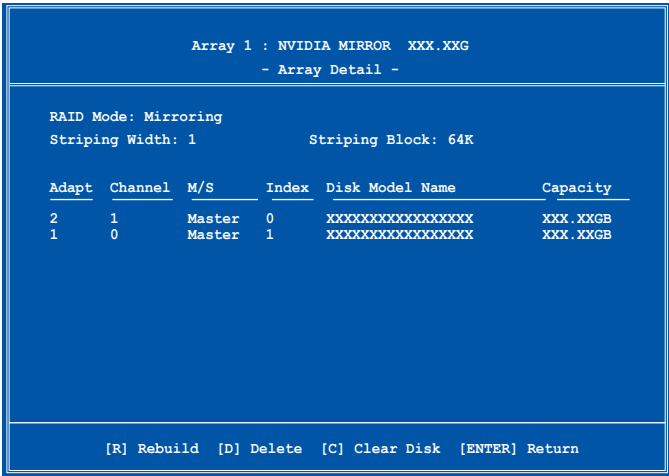

A new set of navigation keys is displayed on the bottom of the screen.

2. Press <D> to delete a RAID array. The following confirmation message appears.

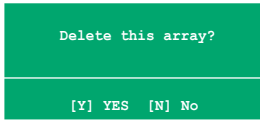

3. Press <Y> to delete array or press <N> to cancel.



Take caution in using this option. All data on the RAID drives will be lost!

4. If you selected Yes, the Define a New Array menu appears.

Clearing a disk data

To clear disk data:

1. From the Array List menu, use the up or down arrow keys to select a RAID array then press <Enter>. The RAID Array details appear.

```
Array 1 : NVIDIA MIRROR XXX.XXG
- Array Detail -

RAID Mode: Mirroring
Striping Width: 1          Striping Block: 64K

Adapt  Channel  M/S    Index  Disk Model Name      Capacity
-----
  2      1      Master  0      XXXXXXXXXXXXXXXXXXXX  XXX.XXGB
  1      0      Master  1      XXXXXXXXXXXXXXXXXXXX  XXX.XXGB

[R] Rebuild [D] Delete [C] Clear Disk [ENTER] Return
```

A new set of navigation keys is displayed on the bottom of the screen.

2. Press <C> to clear disk. The following confirmation message appears.

```
Clear disk data?

[Y] YES [N]
```

5. Press <Y> to clear the disk data or press <N> to cancel.



Take caution in using this option. All data on the RAID drives will be lost!

5.5 Creating a RAID driver disk

A floppy disk with the RAID driver is required when installing Windows® 2000/2003 operating system on a hard disk drive that is included in a RAID set.

To create a RAID driver disk:

1. Place the motherboard support CD into the CD-ROM drive.
2. Select Make Disk tab.
3. From the Make Disk menu, select the RAID driver disk you want to create or browse the contents of the support CD to locate the driver disk utility.



Refer to section "5.2.4 Make Disk menu" for details.

4. Insert floppy disk to floppy disk drive.
5. Follow succeeding screen information to complete process.
6. Write-protect the floppy disk to avoid computer virus infection.

To install the RAID driver:

1. During the OS installation, the system prompts you to press the F6 key to install third-party SCSI or RAID driver.
2. Press <F6> then insert the floppy disk with RAID driver into the floppy disk drive.
3. Follow the succeeding screen instructions to complete the installation.



Due to chipset limitation, the Serial ATA ports supported by the NVIDIA chipset doesn't support Serial Optical Disk Drives (Serial ODD) under DOS.
