

**Crosshair**

**ASUS**<sup>®</sup>

**Motherboard**

E2711

Second Edition V2

July 2006

**Copyright © 2006 ASUSTeK COMPUTER INC. All Rights Reserved.**

No part of this manual, including the products and software described in it, may be reproduced, transmitted, transcribed, stored in a retrieval system, or translated into any language in any form or by any means, except documentation kept by the purchaser for backup purposes, without the express written permission of ASUSTeK COMPUTER INC. ("ASUS").

Product warranty or service will not be extended if: (1) the product is repaired, modified or altered, unless such repair, modification or alteration is authorized in writing by ASUS; or (2) the serial number of the product is defaced or missing.

ASUS PROVIDES THIS MANUAL "AS IS" WITHOUT WARRANTY OF ANY KIND, EITHER EXPRESS OR IMPLIED, INCLUDING BUT NOT LIMITED TO THE IMPLIED WARRANTIES OR CONDITIONS OF MERCHANTABILITY OR FITNESS FOR A PARTICULAR PURPOSE. IN NO EVENT SHALL ASUS, ITS DIRECTORS, OFFICERS, EMPLOYEES OR AGENTS BE LIABLE FOR ANY INDIRECT, SPECIAL, INCIDENTAL, OR CONSEQUENTIAL DAMAGES (INCLUDING DAMAGES FOR LOSS OF PROFITS, LOSS OF BUSINESS, LOSS OF USE OR DATA, INTERRUPTION OF BUSINESS AND THE LIKE), EVEN IF ASUS HAS BEEN ADVISED OF THE POSSIBILITY OF SUCH DAMAGES ARISING FROM ANY DEFECT OR ERROR IN THIS MANUAL OR PRODUCT.

SPECIFICATIONS AND INFORMATION CONTAINED IN THIS MANUAL ARE FURNISHED FOR INFORMATIONAL USE ONLY, AND ARE SUBJECT TO CHANGE AT ANY TIME WITHOUT NOTICE, AND SHOULD NOT BE CONSTRUED AS A COMMITMENT BY ASUS. ASUS ASSUMES NO RESPONSIBILITY OR LIABILITY FOR ANY ERRORS OR INACCURACIES THAT MAY APPEAR IN THIS MANUAL, INCLUDING THE PRODUCTS AND SOFTWARE DESCRIBED IN IT.

Products and corporate names appearing in this manual may or may not be registered trademarks or copyrights of their respective companies, and are used only for identification or explanation and to the owners' benefit, without intent to infringe.

# Contents

Notices.....	vi
Safety information .....	vii
About this guide .....	viii
Crosshair specifications summary .....	x
<b>Chapter 1: Product introduction</b>	
1.1 Welcome! .....	1-1
1.2 Package contents.....	1-1
1.3 Special features.....	1-2
1.3.1 Product highlights .....	1-2
1.3.2 ASUS Unique features .....	1-5
<b>Chapter 2: Hardware information</b>	
2.1 Before you proceed .....	2-1
2.2 Motherboard overview.....	2-2
2.2.1 Placement direction .....	2-2
2.2.2 Screw holes .....	2-2
2.2.3 Motherboard layout.....	2-3
2.2.4 Audio card layout .....	2-3
2.2.5 Layout contents.....	2-4
2.3 Central Processing Unit (CPU) .....	2-6
2.3.1 Installing the CPU .....	2-6
2.3.2 Installing the heatsink and fan .....	2-8
2.3.3 Installing the optional fan .....	2-11
2.4 System memory .....	2-12
2.4.1 Overview .....	2-12
2.4.2 Memory configurations.....	2-12
2.4.3 Installing a DIMM .....	2-19
2.4.4 Removing a DIMM .....	2-19
2.5 Expansion slots.....	2-20
2.5.1 Installing an expansion card .....	2-20
2.5.2 Configuring an expansion card .....	2-20
2.5.3 Interrupt assignments .....	2-21
2.5.4 PCI slots.....	2-22
2.5.5 PCI Express x4 slot.....	2-22
2.5.6 PCI Express x16 slots.....	2-22

# Contents

- 2.6 Jumper ..... 2-23**
- 2.7 Audio Card and EL I/O Installation ..... 2-24**
  - 2.7.1 Audio Card Installation ..... 2-24
  - 2.7.2 EL I/O Installation ..... 2-24
- 2.8 Connectors ..... 2-25**
  - 2.8.1 Rear panel connectors ..... 2-25
  - 2.8.2 Internal connectors ..... 2-28
  - 2.8.3 Onboard switches ..... 2-35
  
- Chapter 3: Powering up**
- 3.1 Starting up for the first time ..... 3-1**
- 3.2 Powering off the computer ..... 3-2**
  - 3.2.1 Using the OS shut down function ..... 3-2
  - 3.2.2 Using the dual function power switch ..... 3-2
  
- Chapter 4: BIOS setup**
- 4.1 Managing and updating your BIOS ..... 4-1**
  - 4.1.1 ASUS Update utility ..... 4-1
  - 4.1.2 Creating a bootable floppy disk ..... 4-4
  - 4.1.3 ASUS EZ Flash 2 utility ..... 4-5
  - 4.1.4 Updating the BIOS ..... 4-6
  - 4.1.5 Saving the current BIOS file ..... 4-8
  - 4.1.6 ASUS CrashFree BIOS 3 utility ..... 4-9
- 4.2 BIOS setup program ..... 4-10**
  - 4.2.1 BIOS menu screen ..... 4-11
  - 4.2.2 Menu bar ..... 4-11
  - 4.2.3 Legend bar ..... 4-12
  - 4.2.4 Menu items ..... 4-12
  - 4.2.5 Sub-menu items ..... 4-12
  - 4.2.6 Configuration fields ..... 4-12
  - 4.2.7 Pop-up window ..... 4-13
  - 4.2.8 General help ..... 4-13
- 4.3 Main menu ..... 4-14**
  - 4.3.1 System Time ..... 4-14
  - 4.3.2 System Date ..... 4-14
  - 4.3.3 Language ..... 4-14
  - 4.3.4 Legacy Diskette A ..... 4-14
  - 4.3.5 Primary IDE Master/Slave ..... 4-15

# Contents

4.3.6	SATA 1/2/3/4/5/6 .....	4-17
4.3.7	HDD SMART Monitoring .....	4-18
4.3.8	Installed Memory.....	4-18
4.3.9	Usable Memory.....	4-18
<b>4.4</b>	<b>Extreme Tweaker menu .....</b>	<b>4-19</b>
4.4.1	LinkBoost .....	4-19
4.4.2	AI Tuning.....	4-19
4.4.3	DRAM Configuration.....	4-23
4.4.4	SLI-Ready Memory.....	4-28
4.4.5	SLI-Ready Memory CPUOC.....	4-28
4.4.6	AMD Live! .....	4-28
4.4.7	AMD Cool 'n' Quiet Function.....	4-28
4.4.8	NVIDIA GPU Ex .....	4-28
<b>4.5</b>	<b>Advanced menu .....</b>	<b>4-29</b>
4.5.1	AI NET2 .....	4-29
4.5.2	PEG Link Mode.....	4-30
4.5.3	PCIPnP .....	4-30
4.5.4	Onboard Device Configuration.....	4-31
<b>4.6</b>	<b>Power menu.....</b>	<b>4-35</b>
4.6.1	ACPI Suspend Type .....	4-35
4.6.2	ACPI APIC Support.....	4-35
4.6.3	APM Configuration.....	4-36
4.6.4	Hardware Monitor .....	4-37
<b>4.7</b>	<b>Boot menu .....</b>	<b>4-41</b>
4.7.1	Boot Device Priority .....	4-41
4.7.2	Removable Drives.....	4-42
4.7.3	Hard Disk Drives .....	4-42
4.7.4	Boot Settings Configuration .....	4-43
4.7.5	Security .....	4-44
<b>4.8</b>	<b>Tools menu .....</b>	<b>4-46</b>
4.8.1	ASUS Music Alarm.....	4-46
4.8.2	ASUS O.C. Profile.....	4-47
4.8.3	ASUS EZ Flash 2.....	4-49
<b>4.9</b>	<b>Exit menu .....</b>	<b>4-50</b>

# Contents

## Chapter 5: Software support

<b>5.1</b>	<b>Installing an operating system .....</b>	<b>5-1</b>
<b>5.2</b>	<b>Support DVD information .....</b>	<b>5-1</b>
5.2.1	Running the support DVD .....	5-1
5.2.2	Drivers menu .....	5-2
5.2.3	Utilities menu .....	5-3
5.2.4	Make Disk menu .....	5-5
5.2.5	Manuals menu .....	5-6
5.2.6	ASUS Contact information .....	5-6
5.2.7	Other information .....	5-7
<b>5.3</b>	<b>Software information .....</b>	<b>5-9</b>
5.3.1	ASUS MyLogo3 .....	5-9
5.3.2	SoundMAX ADI1988 .....	5-11
5.3.3	Cool 'n' Quiet™ Technology .....	5-16
5.3.4	ASUS PC Probe II .....	5-18
<b>5.4</b>	<b>RAID configurations .....</b>	<b>5-24</b>
5.4.1	NVIDIA® MediaShield RAID configurations .....	5-25
5.4.2	Silicon Image RAID configurations .....	5-32
<b>5.5</b>	<b>Creating a RAID driver disk .....</b>	<b>5-40</b>

## Chapter 6: NVIDIA® SLI™ technology support

<b>6.1</b>	<b>Overview .....</b>	<b>6-1</b>
<b>6.2</b>	<b>Dual graphics card setup .....</b>	<b>6-2</b>
6.2.1	Installing SLI-ready graphics cards .....	6-2
6.2.2	Installing the device drivers .....	6-5
6.2.3	Enabling the multi-GPU feature in Windows® .....	6-5

## Appendix: Debug Code

<b>A.1</b>	<b>Debug code table .....</b>	<b>A-1</b>
------------	-------------------------------	------------

# Notices

## Federal Communications Commission Statement

This device complies with Part 15 of the FCC Rules. Operation is subject to the following two conditions:

- This device may not cause harmful interference, and
- This device must accept any interference received including interference that may cause undesired operation.

This equipment has been tested and found to comply with the limits for a Class B digital device, pursuant to Part 15 of the FCC Rules. These limits are designed to provide reasonable protection against harmful interference in a residential installation. This equipment generates, uses and can radiate radio frequency energy and, if not installed and used in accordance with manufacturer's instructions, may cause harmful interference to radio communications. However, there is no guarantee that interference will not occur in a particular installation. If this equipment does cause harmful interference to radio or television reception, which can be determined by turning the equipment off and on, the user is encouraged to try to correct the interference by one or more of the following measures:

- Reorient or relocate the receiving antenna.
- Increase the separation between the equipment and receiver.
- Connect the equipment to an outlet on a circuit different from that to which the receiver is connected.
- Consult the dealer or an experienced radio/TV technician for help.



---

The use of shielded cables for connection of the monitor to the graphics card is required to assure compliance with FCC regulations. Changes or modifications to this unit not expressly approved by the party responsible for compliance could void the user's authority to operate this equipment.

---

## Canadian Department of Communications Statement

This digital apparatus does not exceed the Class B limits for radio noise emissions from digital apparatus set out in the Radio Interference Regulations of the Canadian Department of Communications.

This class B digital apparatus complies with Canadian ICES-003.

# Safety information

## Electrical safety

- To prevent electrical shock hazard, disconnect the power cable from the electrical outlet before relocating the system.
- When adding or removing devices to or from the system, ensure that the power cables for the devices are unplugged before the signal cables are connected. If possible, disconnect all power cables from the existing system before you add a device.
- Before connecting or removing signal cables from the motherboard, ensure that all power cables are unplugged.
- Seek professional assistance before using an adapter or extension cord. These devices could interrupt the grounding circuit.
- Make sure that your power supply is set to the correct voltage in your area. If you are not sure about the voltage of the electrical outlet you are using, contact your local power company.
- If the power supply is broken, do not try to fix it by yourself. Contact a qualified service technician or your retailer.

## Operation safety

- Before installing the motherboard and adding devices on it, carefully read all the manuals that came with the package.
- Handle the product with caution. Some sharp edges and points might cause physical injury. Installing the motherboard with cut or puncture resistant gloves is highly recommended.
- Before using the product, make sure all cables are correctly connected and the power cables are not damaged. If you detect any damage, contact your dealer immediately.
- To avoid short circuits, keep paper clips, screws, and staples away from connectors, slots, sockets and circuitry.
- Avoid dust, humidity, and temperature extremes. Do not place the product in any area where it may become wet.
- Place the product on a stable surface.
- If you encounter technical problems with the product, contact a qualified service technician or your retailer.



# About this guide

This user guide contains the information you need when installing and configuring the motherboard.

## How this guide is organized

This guide contains the following parts:

- **Chapter 1: Product introduction**  
This chapter describes the features of the motherboard and the new technology it supports.
- **Chapter 2: Hardware information**  
This chapter lists the hardware setup procedures that you have to perform when installing system components. It includes description of the switches, jumpers, and connectors on the motherboard.
- **Chapter 3: Powering up**  
This chapter describes the power up sequence and ways of shutting down the system.
- **Chapter 4: BIOS setup**  
This chapter tells how to change system settings through the BIOS Setup menus. Detailed descriptions of the BIOS parameters are also provided.
- **Chapter 5: Software support**  
This chapter describes the contents of the support DVD that comes with the motherboard package.
- **Chapter 6: NVIDIA® SLI™ technology support**  
This chapter tells how to install SLI-ready PCI Express graphics cards.
- **Appendix: Debug Code**  
This appendix explains the debug code on the LCD poster.

## Where to find more information

Refer to the following sources for additional information and for product and software updates.

1. **ASUS websites**  
The ASUS website provides updated information on ASUS hardware and software products. Refer to the ASUS contact information.
2. **Optional documentation**  
Your product package may include optional documentation, such as warranty flyers, that may have been added by your dealer. These documents are not part of the standard package.

## Conventions used in this guide

To make sure that you perform certain tasks properly, take note of the following symbols used throughout this manual.



**DANGER/WARNING:** Information to prevent injury to yourself when trying to complete a task.



**CAUTION:** Information to prevent damage to the components when trying to complete a task.



**IMPORTANT:** Instructions that you **MUST** follow to complete a task.



**NOTE:** Tips and additional information to help you complete a task.

## Typography

**Bold text**

Indicates a menu or an item to select.

*Italics*

Used to emphasize a word or a phrase.

<Key>

Keys enclosed in the less-than and greater-than sign means that you must press the enclosed key.

Example: <Enter> means that you must press the Enter or Return key.

<Key1+Key2+Key3>

If you must press two or more keys simultaneously, the key names are linked with a plus sign (+).

Example: <Ctrl+Alt+D>

**Command**

Means that you must type the command exactly as shown, then supply the required item or value enclosed in brackets.

Example: At the DOS prompt, type the command line:

**format A: /S**

# Crosshair specifications summary

<b>CPU</b>	Support AMD® Socket AM2 Athlon 64 X2 / Athlon 64 FX / Athlon 64/ Sempron AMD Cool 'n' Quiet™ Technology AMD64 architecture enables simultaneous 32-bit and 64-bit computing AMD Live!™ Ready
<b>Chipset</b>	NVIDIA nForce® 590 SLI™ MCP NVIDIA LinkBoost™ Technology
<b>System bus</b>	2000 / 1600 MT/s
<b>Memory</b>	Dual channel memory architecture 4 x DIMM, max. 8GB, DDR2-800/667/533, ECC and non-ECC, un-buffered memory
<b>Expansion slots</b>	2 x PCI Express x16 slot with NVIDIA® SLI™ technology support, at full x16, x16 speed 1 x PCI Express x4 3 x PCI 2.2
<b>Scalable Link Interface (SLI™)</b>	Support two identical NVIDIA SLI-Ready graphics cards (both at x16 mode) ASUS two-slot thermal design ASUS PEG Link
<b>High Definition Audio</b>	SupremeFX Audio Card featuring ADI 1988B 8-channel High Definition Audio CODEC Support Jack-Sensing, Enumeration, Multi-streaming and Jack-Retasking 8 channel audio ports Coaxial, Optical S/PDIF out on back I/O port * ASUS Array Mic * Noise Filter
<b>Storage</b>	NVIDIA nForce® 590 SLI™ MCP supports: * 1 x Ultra DMA 133 / 100 / 66 / 33 * 6 x Serial ATA 3.0Gb/s with NCQ * NVIDIA MediaShield™ RAID supports RAID 0, 1, 0+1, 5 and JBOD span cross Serial ATA drives  Silicon Image® 3132 SATA controller supports: * 2 x External Serial ATA 3.0Gb/s port on back I/O (SATA On-the-Go) * Support RAID 0, 1, JBOD, RAID 0+1(10) and 5 through multiplier

*(continued on the next page)*

## Crosshair specifications summary

<b>Dual Gigabit LAN</b>	<p>Dual Gigabit LAN controllers support NVIDIA DualNet® technology</p> <p>NVIDIA nForce® 590 SLI™ MCP built-in dual Gigabit MAC with external Marvell PHY</p> <ul style="list-style-type: none"> <li>* Support Teaming and fail-over functions</li> <li>* Support TCP/IP Acceleration</li> </ul>
<b>IEEE 1394</b>	TI 1394 controller supports 2 x 1394a ports
<b>USB</b>	max. 10 USB2.0/1.1 ports
<b>ASUS Exclusive Overclocking features</b>	<p>Intelligent overclocking tools:</p> <ul style="list-style-type: none"> <li>* ASUS AI NOS™ (Non-delay Overclocking System)</li> <li>* AI Overclocking (intelligent CPU frequency tuner)</li> <li>* AI Clock Skew</li> <li>* ASUS PEG Link - automatically performance tuning for graphics cards</li> <li>* ASUS O.C. Profile: overclocking configuration-sharing tool</li> <li>* Extreme Tweaker</li> <li>* ASUS AI Booster Utility</li> <li>* Adjustable FSB/DDR2 ratio. Fixed PCI/PCIe frequencies.</li> </ul> <p>Overclocking Protection:</p> <ul style="list-style-type: none"> <li>* ASUS C.P.R.(CPU Parameter Recall)</li> </ul>
<b>ASUS Unique features</b>	<p>LCD Poster</p> <p>EL I/O</p> <p>Onboard LED</p> <p>Onboard switches: Power / Reset / Clr CMOS</p> <p>Q-Connector</p> <p>Q-Fan Plus</p> <p>ASUS CrashFree BIOS3</p> <p>ASUS EZ Flash2</p> <p>ASUS Music Alarm</p> <p>ASUS MyLogo3</p> <p>AI NET2</p> <p>Multi-language BIOS</p>
<b>Rear panel I/O Ports</b>	<p>1 x PS/2 Keyboard port</p> <p>1 x PS/2 Mouses</p> <p>1 x Optical + 1 x Coaxial S/PDIF Output</p> <p>2 x External SATA</p> <p>2 x LAN (RJ45) port</p> <p>4 x USB 2.0/1.1 ports</p> <p>1 x IEEE 1394a port</p> <p>1 x onboard LED switch</p> <p>1 x LCD Poster</p>
<b>BIOS features</b>	<p>8Mb AWARD BIOS, PnP, DMI2.0, WfM2.0, SM BIOS 2.3</p> <p>ASUS CrashFree BIOS 3</p>

*(continued on the next page)*

# Crosshair specifications summary

<b>Internal connectors</b>	<ul style="list-style-type: none"> <li>3 x USB 2.0 connectors supports additional 6 USB 2.0 ports</li> <li>1 x Floppy disk drive connector</li> <li>1 x IDE connector for two devices</li> <li>6 x SATA connectors</li> <li>1 x CPU / 7 x option Fan</li> <li>3 x thermal sensor connector</li> <li>1 x IEEE1394a connector</li> <li>1 x S/PDIF output connector</li> <li>Chassis Intrusion connector</li> <li>Front Panel Audio connector</li> <li>24-pin ATX Power connector</li> <li>8-pin ATX 12V Power connector</li> <li>System panel connector</li> <li>1 x EL I/O Shield connector</li> </ul>
<b>Manageability</b>	WOL by PME, WOR by PME, Chasis Intrusion, PXE
<b>Power requirements</b>	<ul style="list-style-type: none"> <li>ATX power supply (with 24-pin and 8-pin 12 V plugs)</li> <li>ATX 12 V 2.0 compliant</li> </ul>
<b>Support DVD contents</b>	<ul style="list-style-type: none"> <li>Drivers</li> <li>ASUS PC Probe II</li> <li>ASUS Update</li> <li>ASUS AI Booster</li> <li>Futuremark® 3DMark® 06 Advanced Edition</li> <li>NVIDIA MediaShield™ RAID</li> <li>Kaspersky® Anti-Virus</li> </ul>
<b>Accessories</b>	<ul style="list-style-type: none"> <li>1 x SLI bridge</li> <li>1 x ASUS Array Mic</li> <li>1 x ASUS Optional Fan</li> <li>1 x ASUS Q-Connector Kit (system panel; Retail version only)</li> <li>3 x Thermo sensor cables</li> <li>1 x UltraDMA 133/100/66 cable</li> <li>1 x Floppy disk drive cable</li> <li>6 x SATA cables</li> <li>7 x Cable ties</li> <li>3 x SATA power cable for 6 devices</li> <li>1 x 2-port USB2.0 module</li> <li>1 x IEEE1394a module</li> <li>1 x EL I/O Shield</li> <li>InterVideo® Media Launcher (OEM version only)</li> <li>User's manual</li> </ul>
<b>Form factor</b>	ATX Form Factor, 12"x 9.6" (30.5cm x 24.5cm)

\*Specifications are subject to change without notice.



This chapter describes the motherboard features and the new technologies it supports.

# 1 Product introduction

# Chapter summary



- 1.1 Welcome! ..... 1-1
- 1.2 Package contents..... 1-1
- 1.3 Special features..... 1-2



## 1.1 Welcome!

Thank you for buying an **ASUS® Crosshair motherboard!**

The motherboard delivers a host of new features and latest technologies, making it another standout in the long line of ASUS quality motherboards!

Before you start installing the motherboard, and hardware devices on it, check the items in your package with the list below.

## 1.2 Package contents

Check your motherboard package for the following items.

Motherboard	ASUS Crosshair motherboard
I/O modules	USB 2.0 module IEEE 1394a module
Cables	Ultra DMA 133/100/66 cable Floppy disk drive cable Serial ATA cables Serial ATA power cables Thermal sensor cables
Accessories	I/O shield with EL ASUS SLI Bridge Optional fan for water-cooling/passive cooling only
Application CD	ASUS motherboard support DVD Intervideo® WinDVD Suite (OEM version)
Documentation	User guide



If any of the above items is damaged or missing, contact your retailer.

## 1.3 Special features

### 1.3.1 Product highlights

#### Latest processor technology

The motherboard comes with a 940-pin AM2 socket that supports AMD Athlon™ 64 X2/Athlon™ 64/Athlon™ FX/Sempron™ processor. With an integrated low-latency high-bandwidth memory controller and a highly scalable HyperTransport™ technology-based system bus, the motherboard provides a powerful platform for your diverse computing needs, increased office productivity, and enhanced digital media experience. See page 2-6 for details.

#### NVIDIA® nForce® 590-SLI chipset

The NVIDIA® nForce 590-SLI chipset supports the NVIDIA® Scalable Link Interface (SLI™) technology that allows two graphics processing units (GPUs) in a single system. This technology takes advantage of the PCI Express™ bus architecture and features intelligent hardware and software solutions that allows multiple GPUs to work together and achieve exceptional graphics performance. See Chapter 6 for details. The NVIDIA® nForce 590-SLI chipset also supports six (6) Serial ATA 3.0 Gb/s devices, dual PCI Express™ x16 slots at with NVIDIA® SLI™ support at full x16, x16 mode, and up to 10 USB 2.0 ports.

#### 64-bit CPU support

The motherboard supports 64-bit computing, which is the next generation technology to replace the current 32-bit architecture. The 64-bit architecture delivers advanced system performance, faster memory access, and increased productivity. This motherboard provides excellent compatibility and flexibility by support either 64-bit or 32-bit architecture. See page 2-6 for details.

#### DDR2 memory support

The motherboard supports DDR2 memory that features data transfer rates of 800 MHz, 667 MHz or 533 MHz to meet the higher bandwidth requirements of the latest 3D graphics, multimedia, and Internet applications. The dual-channel DDR2 architecture doubles the bandwidth of your system memory to boost system performance, eliminating bottlenecks with peak bandwidths of up to 10.7 GB/s. See pages 2-12 to 2-16 for details.

## PCI Express™ interface

The motherboard fully supports PCI Express, the latest I/O interconnect technology that speeds up the PCI bus. PCI Express features point-to-point serial interconnections between devices and allows higher clockspeeds by carrying data in packets. This high speed interface is software compatible with existing PCI specifications. See page 2-20 for details.

## Serial ATA I/II technology and SATA-On-The-Go



The motherboard fully supports the Serial ATA II 3.0 Gb/s technology through the Serial ATA interfaces and the NVIDIA® NF590-SLI chipset. The Serial ATA 3 Gb/s specification provides twice the bandwidth of the current Serial ATA products with a host of new features, including Native Command Queueing (NCQ), and Power Management (PM) Implementation Algorithm. Serial ATA allows for thinner, more flexible cables with lower pin count and reduced voltage required. Leveraging these Serial ATA 3Gb/s features is the SATA-On-The-Go. Supported by the Silicon Image SiI3132 Serial ATA controller, external SATA ports on the rear panel I/O provide smart setup, hot-plug and support for up to 16 devices per port with port-multiplier functions. See pages 2-23 and 2-27 for details.

## Dual RAID solution



Onboard RAID controllers provide the motherboard with dual-RAID functionality that allows you to select the best RAID solution using IDE or Serial ATA devices.

The NVIDIA® NF590-SLI chipset allows RAID 0, RAID 1, RAID 0+1, RAID 5, and JBOD configuration for six SATA 3.0 Gb/s. See pages 2-27 and 5-24.

The Silicon Image® 3132 controller supports two additional external Serial ATA 3.0 Gb/s ports on the rear panel and allows RAID 0, RAID 1, RAID 0+1, RAID 5 through port multiplier and JBOD configurations on these ports. See pages 2-23 and 5-31 for details.

## IEEE 1394a support



The IEEE 1394a interface provides high-speed and flexible PC connectivity to a wide range of peripherals and devices compliant to the IEEE 1394a standard. The IEEE 1394a interface allows up to 400 Mbps transfer rates through simple, low-cost, high-bandwidth asynchronous (real-time) data interfacing between computers, peripherals, and consumer electronic devices such as camcorders, VCRs, printers, TVs, and digital cameras. See pages 2-22 and 2-28 for details.

## S/PDIF digital sound ready

The motherboard supports the S/PDIF technology through the S/PDIF interfaces on the rear panel. The S/PDIF technology turns your computer into a high-end entertainment system with digital connectivity to powerful audio and speaker systems. See page 2-25 for details.

## USB 2.0 technology

The motherboard implements the Universal Serial Bus (USB) 2.0 specification, dramatically increasing the connection speed from the 12 Mbps bandwidth on USB 1.1 to a fast 480 Mbps on USB 2.0. USB 2.0 is backward compatible with USB 1.1. See pages 2-25 and 2-28 for details.

## Dual Gigabit LAN solution

The motherboard comes with dual Gigabit LAN controllers to provide the total solution for your networking needs. These network controllers use the PCI Express segment to provide faster data bandwidth for your wired or wireless Internet, LAN, and file sharing requirements. See page 2-23 for details.

## AMD Cool 'n' Quiet Technology

The motherboard supports the AMD Cool 'n' Quiet Technology, which monitors system operation and automatically adjusts CPU voltage and frequency for a cool and quiet operating environment.

## 1.3.2 ASUS Unique features

### 8-Phase Power Design



The ASUS 8-Phase Power Design prolongs CPU lifespan and keeps the system stable by preventing high power stress to the CPU and power supply module. The design ensures high efficiency operation to generate less heat compared with conventional power solutions, thus achieving cool system environment and making this motherboard ideal for overclocking.

### Fanless Design



The ASUS fanless design allows multi-directional heat flow from major thermal sources in the motherboard to lower overall system temperature, resulting in quieter operation and longer system life. ASUS has devoted special efforts to address the thermal issues across the motherboard, and most notably in the following areas: CPU, power, VGA, Northbridge and Southbridge. The heat pipe, heatsink, and strategic board layout were tailor made to dissipate heat in the most efficient manner.

### PEG Link Mode for two graphics cards



This feature enhances your PCI Express graphics card performance. It allows the motherboard to automatically adjust the PCI Express graphics link mode to the correct frequency based on the system configuration. Four additional settings are available for overclocking the PEG Link Mode. See page 4-24 for details.

### ASUS Two-slot thermal design

The motherboard is designed with one PCI slot and one PCIe4 slot placed between the two PCI Express x16 slots, allowing increased airflow between the two PCI Express x16 graphics cards. This special design permits more room for ventilation, thus lowering the overall system temperature.

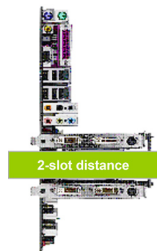

### AI NOS™ (Non-Delay Overclocking System)



ASUS Non-delay Overclocking System™ (NOS) is a technology that auto-detects the CPU loading and dynamically overclocks the CPU speed only when needed. See page 4-20 for details.

## AI NET 2

AI NET 2 is a BIOS-based diagnostic tool that detects and reports Ethernet cable faults and shorts. With this utility, you can easily monitor the condition of the Ethernet cable(s) connected to the Marvell® LAN (RJ-45) port. During the bootup process, AI NET 2 immediately diagnoses the LAN cable and reports shorts and faults up to 100 meters at 1 meter accuracy. See pages 4-23 and 5-11 for details.

## Extreme Tweaker

This feature allows you to fine tune the CPU/memory voltage and gradually increase the memory Front Side Bus (FSB) and PCI Express frequency at 1MHz increment to achieve maximum system performance.

## Optional fan *(for water-cooling/passive-cooling only)*

The optional fan is specifically designed to provide sufficient airflow over the CPU power modules and chipset area when water-cooling or passive-cooling is utilized, ensuring effective heat dissipation for the entire system. See page 2-11 for details.

## ASUS Q-Connector

The ASUS Q-Connector allows you to connect or disconnect chassis front panel cables in one easy step. This unique adapter eliminates the trouble of plugging in one cable at a time, making connection quick and error-free. See pages 2-34 for details.

## ASUS LCD Poster

The LCD Poster displays actual boot error messages instead of codes that other debug cards show. This unique feature allows you to easily find out which devices fail during the boot process, eliminating guesswork and allowing you to solve the problem immediately.

## Onboard LEDs

This motherboard features onboard LEDs located near connector labels, allowing you to connect cables and devices without a flashlight. With this ASUS-patented feature, you can easily identify connector locations to make sure that cables and devices are plugged in and installed correctly.

## Onboard Switches

A power-on button, a reset button, and a clear CMOS button are onboard to provide overclockers and gamers the convenience of fine-tuning performance when working on a bare (open-case) system. Press the power-on button to wake up the system, the reset button to reboot, and the clear CMOS button to clear setup information when the system hangs due to overclocking. See page 2-34 for details.

## CrashFree BIOS 3

This feature allows you to restore the original BIOS data from the support DVD in case the BIOS codes and data are corrupted. This protection eliminates the need to buy a replacement ROM chip. See page 4-9 for details.

## ASUS Q-Fan plus technology

The ASUS Q-Fan plus technology smartly adjusts the CPU and chassis fan 1 speeds according to the system loading to ensure quiet, cool, and efficient operation. See page 4-40 for details.

## ASUS Multi-language BIOS

The multi-language BIOS allows you to select the language of your choice from the available options. The localized BIOS menus allow easier and faster configuration. See page 4-14 for details.

## ASUS MyLogo3

This new feature present in the motherboard allows you to personalize and add style to your system with customizable boot logos. See page 5-9 for details.

## C.P.R. (CPU Parameter Recall)

The C.P.R. feature of the motherboard BIOS allows automatic re-setting to the BIOS default settings in case the system hangs due to overclocking. When the system hangs due to overclocking, C.P.R. eliminates the need to open the system chassis and clear the RTC data. Simply shut down and reboot the system, and the BIOS automatically restores the CPU default setting for each parameter.

## Supreme FX features

This feature can enhance speech-centric applications like Skype, online game, video conference and recording.

### ASUS Array Mic

The Bundled Superbeam Array Microphone receives only the sound coming from the reception cone and ignores the sounds coming from other directions. This mechanism eliminates a large number of interferences, including neighboring speakers and reverberations. It also uses advanced de-reverberation techniques to reduce echo and minimize its effect on the speech engine. This feature can enhance speech-centric applications like Skype, online game, video conference, and recording. See page 5-15 for details.

### Noise Filter

This feature detects repetitive and stationary noises (non-voice signals) like computer fans, air conditioners, and other background noises then eliminates it in the incoming audio stream while recording. See page 5-15 for details.

### DTS® Connect

This feature is consists of two elements: DTS interactive and DTS NEO:PC. DTS interactive re-encodes your stereo or multi-channel sound into a DTS audio signal and send it out from your PC to any DTS enabled system. While DTS NEO:PC turns your stereo audio such as MP3, WMA, CD, and other sound format into a convincing multi-channel audio experience. See page 5-14 for details.



This chapter lists the hardware setup procedures that you have to perform when installing system components. It includes description of the jumpers and connectors on the motherboard.

# 2 Hardware information

2.1	Before you proceed .....	2-1
2.2	Motherboard overview.....	2-2
2.3	Central Processing Unit (CPU) .....	2-6
2.4	System memory .....	2-12
2.5	Expansion slots.....	2-20
2.6	Jumper .....	2-23
2.7	Audio Card and EL I/O Installation .....	2-24
2.8	Connectors .....	2-25

## 2.1 Before you proceed

Take note of the following precautions before you install motherboard components or change any motherboard settings.



- Use a grounded wrist strap or touch a safely grounded object or to a metal object, such as the power supply case, before handling components to avoid damaging them due to static electricity.
- Hold components by the edges to avoid touching the ICs on them.
- Whenever you uninstall any component, place it on a grounded antistatic pad or in the bag that came with the component.

### Onboard LED

Blue lights strategically located beside key motherboard connectors allow you to install components conveniently, even without a flashlight.



Before you install or remove any component, make sure to press the onboard LED switch first and the standby power LED is off. Failure to do so may cause injury or severe damage to the motherboard, peripherals, and/or components.

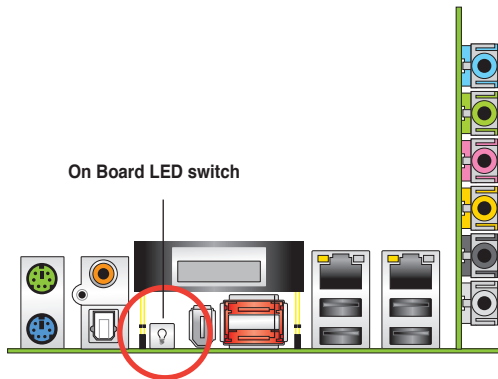

## 2.2 Motherboard overview

Before you install the motherboard, study the configuration of your chassis to ensure that the motherboard fits into it.



- Make sure to unplug the power cord before installing or removing the motherboard. Failure to do so can cause you physical injury and damage motherboard components.
- Remove the film on the heatsink before installation.

### 2.2.1 Placement direction

When installing the motherboard, make sure that you place it into the chassis in the correct orientation. The edge with external ports goes to the rear part of the chassis as indicated in the image below.

### 2.2.2 Screw holes

Place nine (9) screws into the holes indicated by circles to secure the motherboard to the chassis.



Do not overtighten the screws! Doing so can damage the motherboard.

Place this side towards  
the rear of the chassis

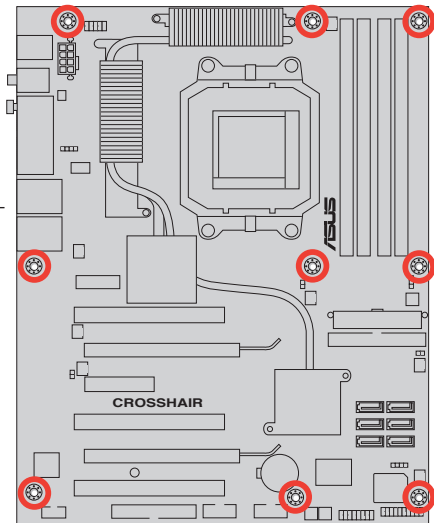

## 2.2.3 Motherboard layout

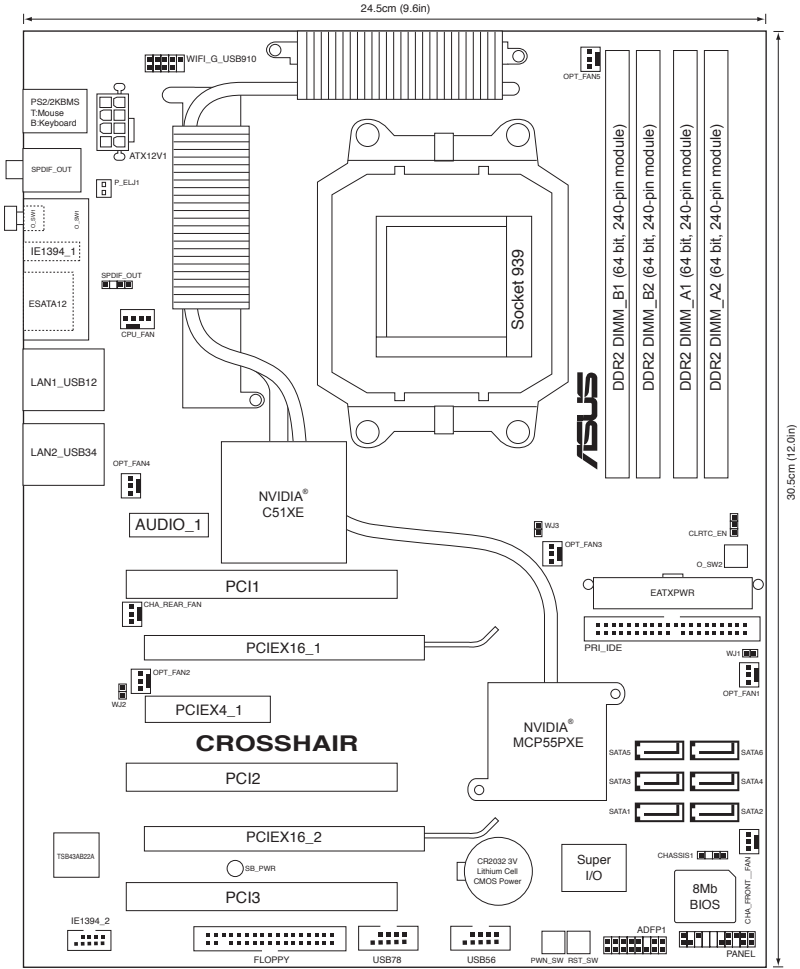

## 2.2.4 Audio card layout



## 2.2.5 Layout contents

Slots		Page
1.	DDR2 DIMM slots	2-12
2.	PCI slots	2-22
3.	PCI Express x 4 slot	2-22
4.	PCI Express x16 slots	2-22

Jumper		Page
1.	Clear RTC RAM (3-pin CLRRTC)	2-23

Rear panel connectors		Page
1.	PS/2 mouse port (green)	2-25
2.	Coaxial S/PDIF Out port	2-25
3.	Onboard LED switch	2-25
4.	IEEE 1394a port	2-25
5.	External SATA ports	2-25
6.	LAN 2 (RJ-45) port.	2-26
7.	LAN 1 (RJ-45) port	2-26
8.	USB 2.0 ports 1 and 2, 3 and 4	2-27
9.	Optical S/PDIF Out port	2-27
10.	PS/2 keyboard port (purple)	2-27

Supreme FX		Page
1.	Line In port (light blue)	2-27
2.	Line Out port (lime)	2-27
3.	Microphone port (pink)	2-27
4.	Center/Subwoofer port (orange)	2-27
5.	Side Speaker Out port (gray)	2-27
6.	Rear Speaker Out port (black)	2-27

Internal connectors		Page
1.	Floppy disk drive connector (34-1 pin FLOPPY)	2-28
2.	IDE connector (40-1 pin PRI_IDE)	2-28
3.	NVIDIA® NF590-SLI Southbridge Serial ATA connectors (7-pin SATA1 [blue], SATA2 [blue], SATA3 [blue], SATA4 [blue], SATA5 [blue], SATA6 [blue])	2-29
4.	USB connectors (10-1 pin USB56, USB78)	2-30
5.	IEEE 1394a port connector (10-1 pin IE1394_2)	2-30
6.	CPU, chassis, and optional fan connectors (4-pin CPU_FAN, 3-pin CHA_REAR_FAN, 3-pin CHA_FRONT_FAN, 3-pin OPT_FAN1, 3-pin OPT_FAN2, 3-pin OPT_FAN3, 3-pin OPT_FAN4, 3-pin OPT_FAN5)	2-31
7.	Chassis intrusion connector (4-1 pin CHASSIS)	2-31
8.	ATX power connectors (24-pin EATXPWR, 8-pin EATX12V,	2-32
9.	System panel connector (20-pin PANEL) <ul style="list-style-type: none"> <li>• System power LED (Green 3-pin PLED)</li> <li>• Hard disk drive activity LED (Red 2-pin IDE_LED)</li> <li>• System warning speaker (Orange 4-pin SPEAKER)</li> <li>• ATX power button/soft-off button (Yellow 2-pin PWR)</li> <li>• Reset button (Blue 2-pin RESET)</li> </ul>	2-33
10.	Thermo sensor cable connectors (WJ1/2/3, 2-pin)	2-34

Onboard switches		Page
1.	Clear CMOS switch	2-33
2.	Power-on switch	2-33
3.	Reset switch	2-34

## 2.3 Central Processing Unit (CPU)

The motherboard comes with a 940-pin AM2 socket designed for the AMD Athlon™ 64 X2/Athlon™ 64/Athlon™ FX/Sempron™ processor.



The AM2 socket has a different pinout from the 940-pin socket designed for the AMD Opteron™ processor. Make sure you use a CPU designed for the AM2 socket. The CPU fits in only one correct orientation. DO NOT force the CPU into the socket to prevent bending the connectors on the socket and damaging the CPU!

### 2.3.1 Installing the CPU

To install a CPU:

1. Locate the CPU socket on the motherboard.

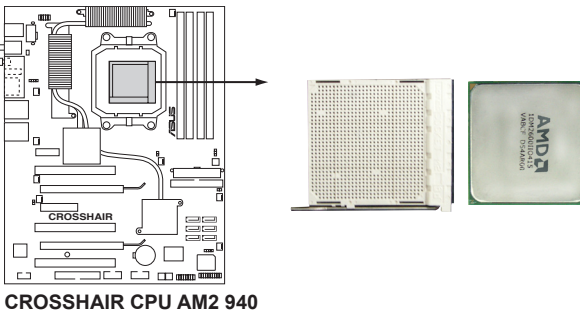

2. Unlock the socket by pressing the lever sideways, then lift it up to a 90° angle.

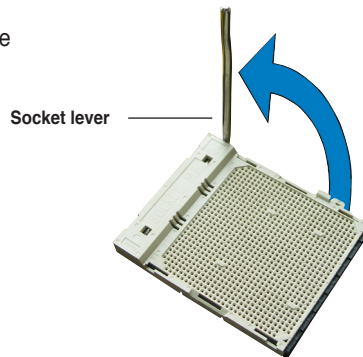

Make sure that the socket lever is lifted up to 90° angle; otherwise, the CPU will not fit in completely.



3. Position the CPU above the socket such that the CPU corner with the gold triangle matches the socket corner with a small triangle.
4. Carefully insert the CPU into the socket until it fits in place.

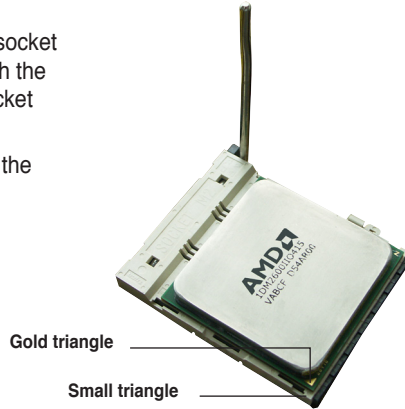

5. When the CPU is in place, push down the socket lever to secure the CPU. The lever clicks on the side tab to indicate that it is locked.
6. Install a CPU heatsink and fan following the instructions that came with the heatsink package.

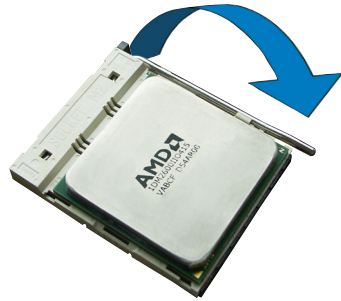

### 2.3.2 Installing the heatsink and fan

The AMD Athlon™ 64FX/Athlon™ 64/Athlon™ 64 X2/Sempron™ processor requires a specially designed heatsink and fan assembly to ensure optimum thermal condition and performance.



---

Make sure that you use only AMD-certified heatsink and fan assembly.

---

To install the CPU heatsink and fan:

1. Place the heatsink on top of the installed CPU, making sure that the heatsink fits properly on the retention module base.



- 
- The retention module base is already installed on the motherboard upon purchase.
  - You do not have to remove the retention module base when installing the CPU or installing other motherboard components.
  - If you purchased a separate CPU heatsink and fan assembly, make sure that a Thermal Interface Material is properly applied to the CPU heatsink or CPU before you install the heatsink and fan assembly.
- 

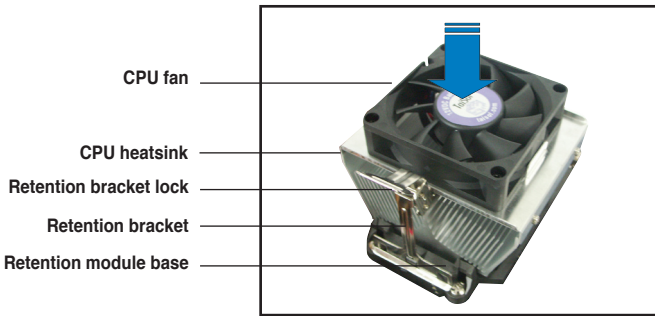

---

Your boxed CPU heatsink and fan assembly should come with installation instructions for the CPU, heatsink, and the retention mechanism. If the instructions in this section do not match the CPU documentation, follow the latter.

---

2. Attach one end of the retention bracket to the retention module base.

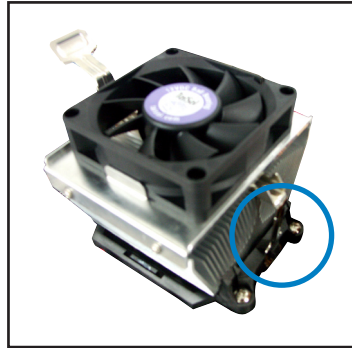

3. Align the other end of the retention bracket (near the retention bracket lock) to the retention module base. A clicking sound denotes that the retention bracket is in place.



Make sure that the fan and heatsink assembly perfectly fits the retention mechanism module base, otherwise you cannot snap the retention bracket in place.



4. Push up the retention bracket lock on the retention mechanism to secure the heatsink and fan to the module base.

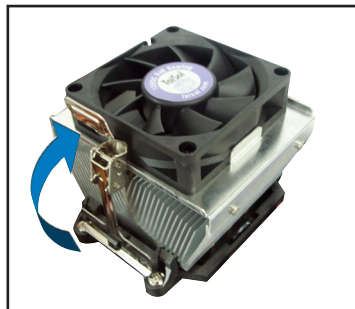

- 5. When the fan and heatsink assembly is in place, connect the CPU fan cable to the connector on the motherboard labeled CPU\_FAN.

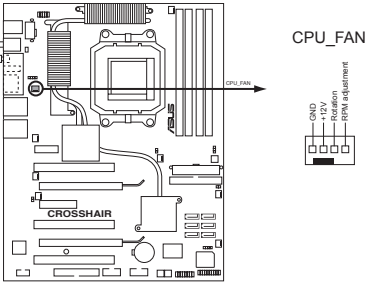

**CROSSHAIR CPU fan connector**



---

Do not forget to connect the CPU fan connector! Hardware monitoring errors can occur if you fail to plug this connector.

---

### 2.3.3 Installing the optional fan



Install the optional fan only if you are using a passive cooler or a water cooler. Installing the optional fan with an active CPU cooler will interfere with the airflow and destabilize the system.

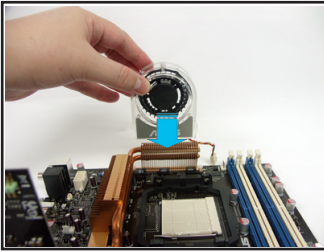

1. Position the fan above the pipe and heatsink assembly.

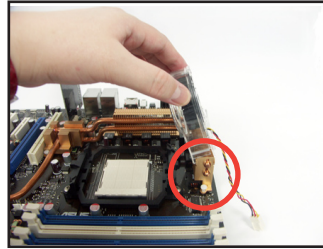

2. Fit the grooved edge to the heatsink.

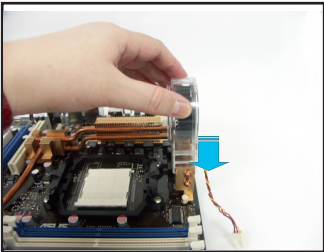

3. Carefully push down the fan until it snugly fits the heatsink, then connect the fan cables.

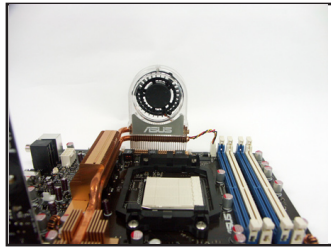

4. The above photo shows the fans installed on the motherboard.



- Plug the optional fan cables to any of the OPT FAN1~5 connectors on the motherboard.
- Make sure the optional fan is installed correctly to prevent damage to the fan and motherboard components.

## 2.4 System memory

### 2.4.1 Overview

The motherboard comes with four Double Data Rate 2 (DDR2) Dual Inline Memory Modules (DIMM) sockets.

A DDR2 module has the same physical dimensions as a DDR DIMM but has a 240-pin footprint compared to the 184-pin DDR DIMM. DDR2 DIMMs are notched differently to prevent installation on a DDR DIMM socket.

The figure illustrates the location of the DDR2 DIMM sockets:

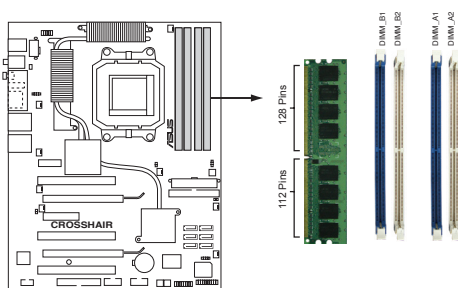

**CROSSHAIR 240-pin DDR DIMM Sockets**

Channel	Sockets
Channel A	DIMM_A1 and DIMM_A2
Channel B	DIMM_B1 and DIMM_B2

### 2.4.2 Memory configurations

You may install 256 MB, 512 MB, 1 GB, and 2 GB unbuffered ECC/non-ECC DDR2 DIMMs into the DIMM sockets.



- If you installed Windows® XP 32-bit version operating system, we recommend that you install less than 3 GB of total memory. For Windows® XP 64-bit version operating system, the maximum support is 8 GB of total memory.
- For dual-channel configuration, the total size of memory module(s) installed per channel must be the same (DIMM\_A1 + DIMM\_A2 = DIMM\_B1 + DIMM\_B2).
- Always install DIMMs with the same CAS latency. For optimum compatibility, we recommend that you obtain memory modules from the same vendor. Refer to the DDR2 Qualified Vendors List on the next page for details.

## Qualified Vendors Lists (QVL) DDR2-800 MHz capability

Qualified Vendors List (QVL) Standard table for user manual									
Size	Vendor	Chip No.	CL	Chip Brand	SS/ DS	Part No.	DIMM Support		
							A*	B*	C*
512MB	KINGSTON	Heat-Sink Package	N/A	N/A	SS	KHX6400D2/512			
512MB	KINGSTON	K4T51083QC	N/A	N/A	SS	KVR800D2N5/512	V	V	V
1024MB	KINGSTON	K4T51083QC	N/A	N/A	DS	KVR800D2N5/1G	V		
256MB	SAMSUNG	K4T56083QF-ZCE7	N/A	N/A	SS	M378T3253FZ3-CE7			
256MB	SAMSUNG	K4T56083QF-ZCE7(ECC)	N/A	N/A	SS	M391T3253FZ3-CE7	V	V	V
512MB	SAMSUNG	EDD339XX	N/A	N/A	SS	M378T6553CZ3-CE7			
512MB	Infineon	HYB18T256800AF25	N/A	N/A	DS	HYS64T64520HU-2.5-A	V		V
512MB	Infineon	HYB18T256800AF25F	N/A	N/A	DS	HYS64T64020HU-25F-A	V	V	
512MB	Hynix	HY5PS12821BFP-S5	N/A	N/A	SS	HYMP564U64BP8-S5	V	V	
1024MB	Hynix	HY5PS12821BFP-S5	N/A	N/A	DS	HYMP512U64BP8-S5	V	V	
512MB	MICRON	5JAIIZ9DQQ	N/A	N/A	SS	MT8HTF6464AY-80EA3	V	V	V
1024MB	MICRON	5JAIIZ9DQQ	N/A	N/A	DS	MT16HTF12864AY-80EA3	V	V	V
512MB	MICRON	5ZD22D9GKX	N/A	N/A	SS	MT8HTF6464AY-80ED4	V	V	V
1024MB	MICRON	5ZD22D9GKX	N/A	N/A	DS	MT16HTF12864AY-80ED4	V	V	
512MB	MICRON	6CD22D9GKX	N/A	N/A	SS	MT8HTF6464AY-80ED4		V	V
1024MB	MICRON	6CD22D9GKX	N/A	N/A	DS	MT16HTF12864AY-80ED4	V	V	
512MB	CORSAIR	Heat-Sink Package	N/A	N/A	SS	CM2X512A-6400			
1024MB	CORSAIR	Heat-Sink Package	N/A	N/A	DS	CM2X1024-6400PRO			
1024MB	CORSAIR	Heat-Sink Package	N/A	N/A	DS	CM2X1024-6400C4	V		
256MB	A-DATA	E2508AB-GE-E	N/A	N/A	SS	M20EL6F3G3170A1D0Z			
256MB	A-DATA	E2508AB-GE-E	N/A	N/A	SS	M20EL6F3G3160A1D0Z			
256MB	A-DATA	E2508AB-GE-E	N/A	N/A	SS	M20EL6F3G3160A1D0Z	V	V	
512MB	A-DATA	E2508AB-GE-E	N/A	N/A	DS	M20EL6F3H4170A1D0Z			
512MB	A-DATA	N/A	N/A	N/A	SS	M20AD6G3H3160J1E52			
512MB	A-DATA	AD29608A8A-25EG	N/A	N/A	SS	M20AD6G3H3160J1E5E			
256MB	Apacer	E2508AB-GE-E	N/A	N/A	SS	78.81091.420	V		
512MB	Apacer	E2508AB-GE-E	N/A	N/A	DS	78.91091.420			
512MB	Crucial	Heat-Sink Package	N/A	N/A	SS	BL6464AA804.8FA			

(Continued on the next page)

## DDR2-800 MHz capability

Qualified Vendors List (QVL) Standard table for user manual							DIMM Support		
Size	Vendor	Chip No.	CL	Chip Brand	SS/ DS	Part No.	A*	B*	C*
1024MB	Crucial	Heat-Sink Package	N/A	N/A	DS	BL12864AA804.16FA	V	V	
256MB	TwinMOS	E2508AB-GE-E	N/A	N/A	SS	8G-24IK2-EBT			
512MB	OCZ	Heat-Sink Package	N/A	N/A	SS	OCZ28001024EBDCPE-K			
512MB	Elixir	N2TU51280AE-25C	N/A	N/A	SS	M2Y51264TU88A2B-25C			
512MB	NANYA	NT5TU64M8AE-25C	N/A	N/A	SS	NT512T64U88A1BY-25C			
512MB	NANYA	NT5TU64M8BE-25C	N/A	N/A	SS	NT512T64U88B0BY-25C			
1024MB	NANYA	NT5TU64M8BE-25C	N/A	N/A	DS	NT1GT64U88B0BY-25C			
1024MB	GEIL	Heat-Sink Package	N/A	N/A	DS	GX22GB6400UDC			

### SS - Single-sided DS - Double-sided

#### DIMM support:

- A** - Supports one module inserted into either slot, in Single-channel memory configuration.
- B** - Supports one pair of modules inserted into either Channel A or Channel B as one pair of Dual-channel memory configuration.
- C** - Supports four modules inserted into the yellow and black slots as two pairs of Dual-channel memory configuration.



---

Visit the ASUS website for the latest DDR2-800 MHz QVL.

---



## DDR2-667 MHz capability

Qualified Vendors List (QVL) Standard table for user manual									
Size	Vendor	Chip No.	CL	Brand	SS/ DS	Part No.	DIMM support		
							A*	B*	C*
512MB	KINGSTON	E5108AE-6E-E	N/A	N/A	SS	KVR667D2N5/512	V	V	V
1024MB	KINGSTON	E5108AE-6E-E	N/A	N/A	DS	KVR667D2N5/1G			V
512MB	KINGSTON	E5108AE-6E-E	N/A	N/A	SS	KVR667D2E5/512	V	V	V
256MB	KINGSTON	HYB18T256800AF3	N/A	N/A	SS	KVR667D2N5/256	V	V	V
256MB	SAMSUNG	K4T56083QF-ZCE6	N/A	N/A	SS	M378T3253FZ0-CE6	V	V	V
512MB	SAMSUNG	K4T56083QF-ZCE6	N/A	N/A	DS	M378T6453FZ0-CE6	V	V	V
256MB	SAMSUNG	K4T56083QF-ZCE6(ECC)	N/A	N/A	SS	M391T3253FZ0-CE6	V	V	
512MB	SAMSUNG	K4T56083QF-ZCE6(ECC)	N/A	N/A	DS	M391T6453FZ0-CE6	V	V	
256MB	SAMSUNG	K4T51163QC-ZCE6	N/A	N/A	SS	M378T3354CZ0-CE6	V	V	
512MB	SAMSUNG	ZCE6K4T51083QC	N/A	N/A	SS	M378T6553CZ0-CE6	V	V	V
1024MB	SAMSUNG	ZCE6K4T51083QC	N/A	N/A	DS	M378T2953CZ0-CE6	V	V	V
512MB	MICRON	4VB41D9CZM	N/A	N/A	DS	MT16HTF6464AY-667B4	V	V	V
256MB	Infineon	HYB18T512160AF-3S	N/A	N/A	SS	HYS64T32000HU-3S-A	V	V	V
512MB	Infineon	HYB18T512800AF3S	N/A	N/A	SS	HYS64T64000HU-3S-A	V	V	V
1024MB	Infineon	HYB18T512800AF3S	N/A	N/A	DS	HYS64T128020HU-3S-A	V	V	
256MB	Infineon	HYB18T256800AF3S(ECC)	N/A	N/A	SS	HYS72T32000HU-3S-A	V	V	
512MB	Infineon	HYB18T512800AF3S(ECC)	N/A	N/A	SS	HYS72T64000HU-3S-A	V	V	V
1024MB	Infineon	HYB18T512800AF3S(ECC)	N/A	N/A	DS	HYS72T128020HU-3S-A	V	V	V
512MB	Infineon	HYB18T512800BF3S(ECC)	N/A	N/A	SS	HYS72T64000HU-3S-B	V	V	V
1024MB	Infineon	HYB18T512800BF3S(ECC)	N/A	N/A	DS	HYS72T128020HU-3S-B	V	V	V
256MB	Infineon	HYB18T512160BF-3S	N/A	N/A	SS	HYS64T32000HU-3S-B	V	V	V
512MB	Infineon	HYB18T512800BF3S	N/A	N/A	SS	HYS64T64000HU-3S-B	V	V	V
1024MB	Infineon	HYB18T512800BF3S	N/A	N/A	DS	HYS64T128020HU-3S-B	V	V	V
512MB	Hynix	HY5PS12821AFP-Y5	N/A	N/A	SS	HYMP564U64AP8-Y5	V	V	V
1024MB	Hynix	HY5PS12821AFP-Y5	N/A	N/A	DS	HYMP512U64AP8-Y5	V	V	V
1024MB	Hynix	HY5PS1G831FP-Y5(ECC)	N/A	N/A	SS	HYMP112U72P8-Y5	V		
512MB	Hynix	HY5PS12821AFP-Y5(ECC)	N/A	N/A	SS	HYMP564U72AP8-Y5			V
1024MB	Hynix	HY5PS12821AFP-Y5(ECC)	N/A	N/A	DS	HYMP512U72AP8-Y5	V	V	V
512MB	Hynix	HY5PS12821AFP-Y4	N/A	N/A	SS	HYMP564U64AP8-Y4	V	V	V
1024MB	Hynix	HY5PS12821AFP-Y4	N/A	N/A	DS	HYMP512U64AP8-Y4	V	V	V
512MB	Hynix	HY5PS12821AFP-Y4(ECC)	N/A	N/A	SS	HYMP564U72AP8-Y4	V	V	V
1024MB	Hynix	HY5PS12821AFP-Y4(ECC)	N/A	N/A	DS	HYMP512U72AP8-Y4	V	V	V
256MB	ELPIDA	E2508AB-6E-E	N/A	N/A	SS	EBE25UC8ABFA-6E-E			V
512MB	ELPIDA	E5108AE-6E-E	N/A	N/A	SS	EBE51UD8AEFA-6E-E	V	V	V
1024MB	ELPIDA	Engineering Sample	N/A	N/A	DS	EBE11UD8AEFA-6E-E			V
512MB	crucial	Heat-Sink Package	N/A	N/A	DS	BL6464AA664.16FB	V	V	V

(Continued on the next page)

## DDR2-667 MHz capability

Qualified Vendors List (QVL) Standard table for user manual

Size	Vendo	Chip No.	CL	Chip Brand	SS/ DS	Part No.	DIMM Support		
							A*	B*	C*
1024MB	crucial	Heat-Sink Package	N/A	N/A	DS	BL12864AA664.16FA	V	V	V
512MB	crucial	Heat-Sink Package	N/A	N/A	DS	BL6464AL664.16FB	V	V	V
1024MB	crucial	Heat-Sink Package	N/A	N/A	DS	BL12864AL664.16FA	V		V
512MB	crucial	Heat-Sink Package	N/A	N/A	DS	BL6464AA663.8FA	V	V	
1024MB	crucial	Heat-Sink Package	N/A	N/A	DS	BL12864AA663.16FA			
512MB	Kingmax	E5108AE-6E-E	N/A	N/A	SS	KLCC28F-A8EB5	V	V	V
1024MB	Kingmax	E5108AE-6E-E	N/A	N/A	DS	KLCD48F-A8EB5			
512MB	Apacer	E5108AE-6E-E	N/A	N/A	SS	78.91092.420			
1024MB	Apacer	E5108AE-6E-E	N/A	N/A	DS	78.01092.420			
512MB	A-DATA	E5108AE-6E-E	N/A	N/A	SS	M20EL5G3H3160B1C0Z	V	V	V
512MB	A-DATA	AD29608A8B-3EG	N/A	N/A	SS	M20AD5Q3H3163J1C52			
512MB	Transcend	E5108AE-6E-E	N/A	N/A	SS	TS64MLQ64V6J	V	V	V
1024MB	Transcend	E5108AE-6E-E	N/A	N/A	DS	TS128MLQ64V6J	V		V
512MB	TwinMOS	E5108AE-GE-E	N/A	N/A	SS	8G-25JK5-EBT			
512MB	GEIL	Heat-Sink Package	N/A	N/A	SS	GX21GB5300UDC			
512MB	GEIL	Heat-Sink Package	N/A	N/A	SS	GX21GB5300DC			
256MB	NANYA	NT5TU32M16AG-3C	N/A	N/A	SS	NT256T64UH4A0FY-3C			
512MB	NANYA	NT5TU64M8AE-3C	N/A	N/A	SS	NT512T64U88A0BY-3C			
512MB	NANYA	NT5TU64M8BE-3B	N/A	N/A	SS	NT512T64U88B0BY-3C			
1024MB	NANYA	NT5TU64M8BE-3B	N/A	N/A	DS	NT1GT64U8HB0BY-3C			
512MB	Elixir	N2TU51280AF-3C	N/A	N/A	SS	M2U51264TU88A0F-3C			
1024MB	Elixir	N2TU51280AF-3C	N/A	N/A	DS	M2U1G64TU8HA2F-3C			
512MB	OCZ	Heat-Sink Package	N/A	N/A	SS	OCZ26671024EBDCPE-K			
1024MB	OCZ	Heat-Sink Package	N/A	N/A	DS	OCZ26672048EBDCPE-K			
512MB	OCZ	Heat-Sink Package	N/A	N/A	SS	OCZ2P6671GK			
1024MB	PQI	E5108AE-5C-E	N/A	N/A	DS	MEAD-403LA			
512MB	WINTEC	4UA12D9CRZ	N/A	N/A	SS	39127282			
1024MB	WINTEC	4WAIID9CWX	N/A	N/A	DS	39137282			
512MB	MDT	18D51280D-30518	N/A	N/A	SS	M512-667-8			
1024MB	MDT	18D51280D-30528	N/A	N/A	DS	M924-667-16			
512MB	Kingbox	DD2640800-667	N/A	N/A	SS	N/A			
1024MB	Kingbox	DD2640800-667	N/A	N/A	DS	N/A			

**SS - Single-sided DS - Double-sided**

**DIMM support:**

- A** - Supports one module inserted into either slot, in Single-channel memory configuration.
- B** - Supports one pair of modules inserted into either Channel A or Channel B as one pair of Dual-channel memory configuration.
- C** - Supports four modules inserted into the yellow and black slots as two pairs of Dual-channel memory configuration.



Visit the ASUS website for the latest DDR2-667 MHz QVL.

## DDR2-533 MHz capability

Qualified Vendors List (QVL) Standard table for user manual									
Size	Vendor	Chip No.	CL	Chip Brand	SS/DS	Part No.	DIMM Support		
							A*	B*	C*
256MB	KINGSTON	E5116AF-5C-E	N/A	N/A	SS	KVR533D2N4/256	V	V	V
512MB	KINGSTON	HYB18T512800AF37	N/A	N/A	SS	KVR533D2N4/512	V	V	V
1024MB	KINGSTON	5YDIID9GCT	N/A	N/A	DS	KVR533D2N4/1G	V	V	V
512MB	SAMSUNG	K4T51083QB-GCD5	N/A	N/A	SS	M378T6553BG0-CD5	V		
256MB	SAMSUNG	K4T56083QF-GCD5	N/A	N/A	SS	M378T3253FG0-CD5	V	V	V
512MB	SAMSUNG	K4T56083QF-GCD5	N/A	N/A	DS	M378T6453FG0-CD5	V	V	V
512MB	SAMSUNG	K4T56083QF-GCD5(ECC)	N/A	N/A	DS	M391T6453FG0-CD5	V	V	V
1024MB	SAMSUNG	K4T51083QB-GCD5(ECC)	N/A	N/A	DS	M391T2953BG0-CD5	V	V	V
256MB	MICRON	4DBIIZ9BQT	N/A	N/A	SS	N/A	V	V	V
512MB	Infineon	HYB18T512800AF3(ECC)	N/A	N/A	SS	HYS72T64000HU-3.7-A			
512MB	Infineon	HYB18T512800AC37	N/A	N/A	SS	HYS64T64000GU-3.7-A	V		V
256MB	Infineon	HYB18T512160AF-3.7	N/A	N/A	SS	HYS64T32000HU-3.7-A	V	V	V
512MB	Infineon	HYB18T512800AF37	N/A	N/A	SS	HYS64T64000HU-3.7-A	V	V	V
1024MB	Infineon	HYB18T512800AF37	N/A	N/A	DS	HYS64T128020HU-3.7-A	V	V	V
2048MB	Infineon	HYB18T1G800AF-3.7	N/A	N/A	DS	HYS64T256020HU-3.7-A	V	V	V
256MB	Infineon	HYB18T512160BF-3.7	N/A	N/A	SS	HYS64T32000HU-3.7-B	V	V	V
512MB	Infineon	HYB18T512800BF37	N/A	N/A	SS	HYS64T64000HU-3.7-B	V	V	V
1024MB	Infineon	HYB18T512800BF37	N/A	N/A	DS	HYS64T128020HU-3.7-B	V	V	V
256MB	Infineon	HYB18T256800AF37(ECC)	N/A	N/A	SS	HYS72T32000HU-3.7-A	V	V	V
1024MB	Infineon	HYB18T512800AF37(ECC)	N/A	N/A	DS	HYS72T128020HU-3.7-A	V		V
512MB	Hynix	HY5PS12821F-C4	N/A	N/A	SS	HYMP564U648-C4	V	V	V
512MB	Hynix	HY5PS12821F-C4(ECC)	N/A	N/A	SS	HYMP564U728-C4	V	V	V
1024MB	Hynix	HY5PS12821F-C4	N/A	N/A	DS	HYMP512U648-C4	V	V	V
1024MB	Hynix	HY5PS12821F-C4(ECC)	N/A	N/A	DS	HYMP512U728-C4	V	V	V
1024MB	Hynix	HY5PS12821F-E3(ECC)	N/A	N/A	DS	HYMP512U728-C4			
512MB	Hynix	HY5PS12821FP-C4(ECC)	N/A	N/A	SS	HYMP564U728-C4	V	V	V
1024MB	Hynix	HY5PS12821FP-C4	N/A	N/A	DS	HYMP512U648-C4	V	V	V
512MB	Hynix	HY5PS12821AFP-C3	N/A	N/A	SS	HYMP564U64AP8-C3	V	V	V
1024MB	Hynix	HY5PS12821AFP-C3	N/A	N/A	DS	HYMP512U64AP8-C3	V	V	V
512MB	ELPIDA	E5108AB-5C-E(ECC)	N/A	N/A	SS	EBE51ED8ABFA-5C-E	V	V	V
512MB	ELPIDA	E5108AB-5C-E	N/A	N/A	SS	EBE51UD8ABFA-5C	V	V	V
512MB	ELPIDA	E5108AB-5C-E	N/A	N/A	SS	EBE51UD8ABFA-5C-E	V	V	V
1024MB	ELPIDA	E5108AB-5C-E	N/A	N/A	DS	EBE11UD8ABFA-5C-E	V	V	
2048MB	ELPIDA	E1108AA-5C-E	N/A	N/A	DS	EBE21EE8AAFA-5C-E	V		
256MB	CORSAIR	MII0051832M8CEC	N/A	N/A	SS	VS256MB533D2	V	V	
512MB	CORSAIR	MII10052432M8CEC	N/A	N/A	DS	VS512MB533D2	V	V	
256MB	Apacer	E5116AB-5C-E	N/A	N/A	SS	78.81077.420	V	V	V
256MB	KINGMAX	E5116AB-5C-E	N/A	N/A	SS	KLBB68F-36EP4	V		V

(Continued on the next page)

## DDR2-533 MHz capability

Qualified Vendors List (QVL) Standard table for user manual

Size	Vendor	Chip No.	CL	Chip Brand	SS/ DS	Part No.	DIMM Support		
							A*	B*	C*
512MB	KINGMAX	E5108AE-5C-E	N/A	N/A	SS	KLBC28F-A8EB4	V	V	V
1024MB	KINGMAX	E5108AE-5C-E	N/A	N/A	DS	KLBD48F-A8EB4	V	V	V
512MB	KINGMAX	KKEA88E4AAK-37	N/A	N/A	SS	KLBC28F-A8KE4	V	V	V
1024MB	KINGMAX	5MB22D9DCN	N/A	N/A	DS	KLBD48F-A8ME4	V	V	V
512MB	Transcend	K4T51083QB-GCD5	N/A	N/A	SS	TS64MLQ64V5J	V	V	V
1024MB	Transcend	K4T51083QB-GCD5	N/A	N/A	DS	TS128MLQ64V5J	V	V	V
256MB	CENTURY	K4T56083QF-GCD5	N/A	N/A	SS	25V6S8SSD5F4-K43			
512MB	CENTURY	E5108AB-5C-E	N/A	N/A	SS	25V2H8EL5CB4-J43			
1024MB	CENTURY	E5108AB-5C-E	N/A	N/A	DS	25V0H8EL5CB4-J45			
1024MB	CENTURY	E5108AB-5C-E	N/A	N/A	DS	25VOH8EL5C			
256MB	elixir	N2TU51216AF-37B	N/A	N/A	SS	M2U25664TUH4A0F-37B			
512MB	elixir	N2TU51280AF-37B	N/A	N/A	SS	M2U51264TU88A0F-37B			
256MB	Aeneon	AET960UD00-37C88X	N/A	N/A	SS	AET560UD00-370A98X			
512MB	Aeneon	AET960UD00-37C88X	N/A	N/A	SS	AET660UD00-370A98X			
512MB	Aeneon	AET93F37AG0513	N/A	N/A	SS	AET660UD00-370A98X			
256MB	Aeneon	AET94F370A	N/A	N/A	SS	AET560UD00-370A98Z			
256MB	Aeneon	AET94F370A	N/A	N/A	SS	AET560UD00-370A98X			
512MB	Aeneon	AET93F370A	N/A	N/A	SS	AET660UD00-370A98Z			
512MB	Aeneon	AET93F370A	N/A	N/A	SS	AET660UD00-370A98X			
512MB	Aeneon	AET93F370	N/A	N/A	SS	AET660UD00-370A98X			
1024MB	Aeneon	AET93F370A	N/A	N/A	DS	AET760UD00-370A98X			
256MB	NANYA	NT5TU32M16AF-37B	N/A	N/A	SS	NT256T64UH4A0F-37B			
512MB	NANYA	NT5TU64M8AF-37B	N/A	N/A	SS	NT512T64U88A0F-37B			
512MB	NANYA	NT5TU64M8AF-37B(ECC)	N/A	N/A	SS	NT512T72U89A0F-37B			
1024MB	NANYA	NT5TU64M8AF-37B	N/A	N/A	DS	NT1GT64U8HA0F-37B			
1024MB	PQI	64MX8D2-E	N/A	N/A	DS	MEAB-323LA			
512MB	PQI	64MX8D2-E	N/A	N/A	SS	MEAB-423LA			
512MB	TwinMOS	K4T51083QB-GCD5	N/A	N/A	SS	8D-22JB5-K2T			
256MB	SimpleTech	858S032F25A	N/A	N/A	SS	SVM-42DR2/256			
512MB	SimpleTech	858S064F25A	N/A	N/A	SS	SVM-42DR2/512			
1024MB	Patriot	Heat-Sink Package	N/A	N/A	SS	PDC21G5600+XBLK			
512MB	MDT	18D51280D-3.70S20	N/A	N/A	SS	M512-533-8			
1024MB	MDT	18D51280D-3.70448	N/A	N/A	DS	M924-533-16			

Side(s): SS - Single-sided DS - Double-sided

DIMM support:

- A** - Supports one module inserted into either slot, in Single-channel memory configuration.
- B** - Supports one pair of modules inserted into either Channel A or Channel B as one pair of Dual-channel memory configuration.
- C** - Supports two pairs of modules inserted into the yellow and black slots as two pairs of Dual-channel memory configuration.



Visit the ASUS website for the latest DDR2-533 MHz QVL.

### 2.4.3 Installing a DIMM



Unplug the power supply before adding or removing DIMMs or other system components. Failure to do so can cause severe damage to both the motherboard and the components.

To install a DIMM:

1. Unlock a DIMM socket by pressing the retaining clips outward.
2. Align a DIMM on the socket such that the notch on the DIMM matches the break on the socket.
3. Firmly insert the DIMM into the socket until the retaining clips snap back in place and the DIMM is properly seated.

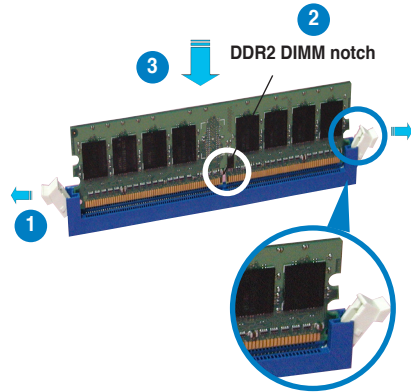

Unlocked retaining clip



- A DDR2 DIMM is keyed with a notch so that it fits in only one direction. Do not force a DIMM into a socket to avoid damaging the DIMM.
- The DDR2 DIMM sockets do not support DDR DIMMs. DO not install DDR DIMMs to the DDR2 DIMM sockets.

### 2.4.4 Removing a DIMM

To remove a DIMM:

1. Simultaneously press the retaining clips outward to unlock the DIMM.



Support the DIMM lightly with your fingers when pressing the retaining clips. The DIMM might get damaged when it flips out with extra force.

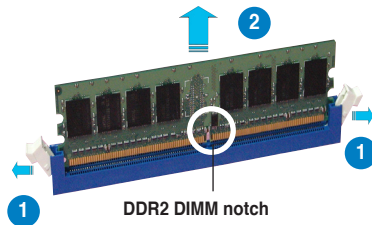

2. Remove the DIMM from the socket.

## 2.5 Expansion slots

In the future, you may need to install expansion cards. The following sub-sections describe the slots and the expansion cards that they support.



---

Make sure to unplug the power cord before adding or removing expansion cards. Failure to do so may cause you physical injury and damage motherboard components.

---

### 2.5.1 Installing an expansion card

To install an expansion card:

1. Before installing the expansion card, read the documentation that came with it and make the necessary hardware settings for the card.
2. Remove the system unit cover (if your motherboard is already installed in a chassis).
3. Remove the bracket opposite the slot that you intend to use. Keep the screw for later use.
4. Align the card connector with the slot and press firmly until the card is completely seated on the slot.
5. Secure the card to the chassis with the screw you removed earlier.
6. Replace the system cover.

### 2.5.2 Configuring an expansion card

After installing the expansion card, configure the it by adjusting the software settings.

1. Turn on the system and change the necessary BIOS settings, if any. See Chapter 4 for information on BIOS setup.
2. Assign an IRQ to the card. Refer to the tables on the next page.
3. Install the software drivers for the expansion card.



---

When using PCI cards on shared slots, ensure that the drivers support “Share IRQ” or that the cards do not need IRQ assignments. Otherwise, conflicts will arise between the two PCI groups, making the system unstable and the card inoperable. Refer to the table on the next page for details.

---

## 2.5.3 Interrupt assignments

### Standard interrupt assignments

IRQ	Priority	Standard function
0	1	System Timer
1	2	Keyboard Controller
2	-	Redirect to IRQ#9
5	13	IRQ Holder for PCI Steering*
6	14	Floppy Disk Controller
7	15	Nvidia nForce PCI system
8	3	System CMOS/Real Time Clock
9	4	Nvidia nForce Networking Controller
10	5	IRQ Holder for PCI Steering*
11	6	IRQ Holder for PCI Steering*
12	7	PS/2 Compatible Mouse Port*
13	8	Numeric Data Processor
14	9	Primary IDE Channel

\* These IRQs are usually available for ISA or PCI devices.

### IRQ assignments for this motherboard

	A	B	C	D	E	F	G	H
PCI Slot 1	shared	-	-	-	-	-	-	-
PCI Slot 2	-	shared	-	-	-	-	-	-
PCI Slot 3			shared					
Onboard 1394	shared	-	-	-	-	-	-	-
PCIE x 16 1	shared	-	-	-	-	-	-	-
PCIE x 16 2	-	-	-	-	-	shared	-	-
PCIE x 4	-	-	-	-	-	-	shared	-

### 2.5.4 PCI slots

The PCI slots support cards such as a LAN card, SCSI card, USB card, and other cards that comply with PCI specifications. Refer to the figure below for the location of the slots.

### 2.5.5 PCI Express x4 slot

This motherboard supports PCI Express x4 network cards, SCSI cards and other cards that comply with the PCI Express specifications. Refer to the figure below for the location of the slot.

### 2.5.6 PCI Express x16 slots

This motherboard supports PCI Express x16 graphics cards that comply with the PCI Express specifications. Refer to the figure below for the location of the slots.

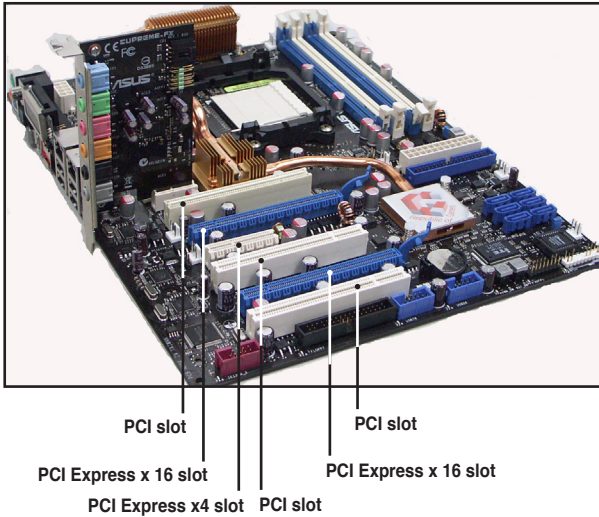



## 2.6 Jumper

### Clear RTC RAM (CLRTC)

This jumper allows you to enable the CLRTC switch. You can clear the CMOS memory of date, time, and system setup parameters by erasing the CMOS RTC RAM data. The onboard clr CMOS switch helps you easily to clear the system setup information such as system passwords. See page 2-35 for details.

To erase the RTC RAM:

1. Turn OFF the computer and unplug the power cord.
2. Move the jumper cap from pins 1-2 (default) to pins 2-3 to enable the CLRTC function.
3. Press down the **clr CMOS** button and again to release it.
4. Plug the power cord and turn ON the computer.
5. Hold down the <Del> key during the boot process and enter BIOS setup to re-enter data.



The **clr CMOS** button will not function until the jumper cap on CLRTC is moved to the ENABLE position. Removing the cap will cause system boot failure!

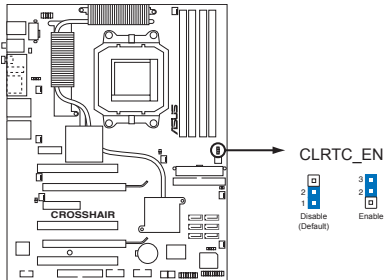

**CROSSHAIR Clear RTC RAM**



- Make sure to re-enter your previous BIOS settings after you clear the CMOS.
- You do not need to clear the RTC when the system hangs due to overclocking. For system failure due to overclocking, use the C.P.R. (CPU Parameter Recall) feature. Shut down and reboot the system so the BIOS can automatically reset parameter settings to default values.
- To prevent accidental pressing of the Clear CMOS switch, the CLRTC jumper default setting disables the switch.

## 2.7 Audio Card and EL I/O Installation

### 2.7.1 Audio Card Installation



1. Take out the Audio card from the package.

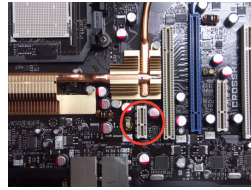

2. Locate the slot on the motherboard.

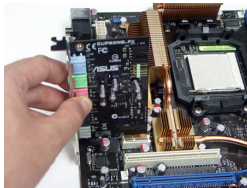

3. Align the card connector with the slot and press firmly until the card sits on the slot completely.

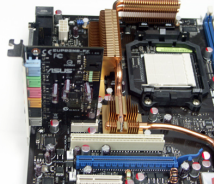

4. The above photo shows the audio card installed on the motherboard.

### 2.7.2 EL I/O Installation



1. Take out the EL I/O from the package.

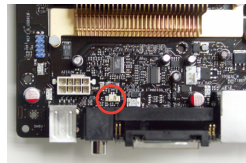

2. Locate the connector on the motherboard.

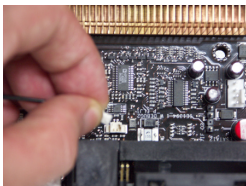

3. Connector the cable to the connector in a correct orientation.

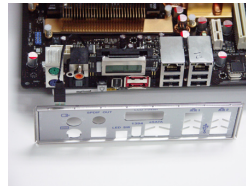

4. The above photo shows the EL I/O installed on the motherboard.

## 2.8 Connectors

### 2.8.1 Rear panel connectors

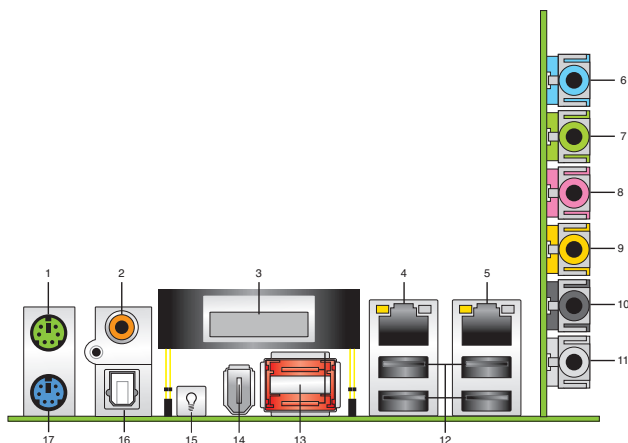

1. **PS/2 mouse port (green).** This port is for a PS/2 mouse.
2. **Coaxial S/PDIF Out port.** This port connects an external audio output device via an optical S/PDIF cable.
3. **LCD Poster.** This poster displays actual boot error messages.
4. **LAN 1 (RJ-45) port.** Supported by NV Gigabit LAN controller, this port allows Gigabit connection to a Local Area Network (LAN) through a network hub. Refer to the table on the next page for the LAN port LED indications.
5. **LAN 2 (RJ-45) port.** Supported by the NV Gigabit LAN controller, this port allows Gigabit connection to a Local Area Network (LAN) through a network hub. Refer to the table below for the LAN port LED indications.

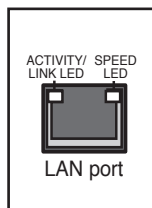

#### 32-bit OS LAN port LED indications

Activity/Link	Speed LED	Description
OFF	OFF	Soft-off Mode
YELLOW*	OFF	During Power ON/OFF
YELLOW*	ORANGE	100 Mbps connection

\* Blinking

#### 64-bit OS LAN port LED indications

Activity/Link	Speed LED	Description
DNR	DNR	Soft-off Mode
DNR	DNR	During Power ON/OFF
DNR	DNR	100 Mbps connection
DNR	DNR	1 Gbps connection

6. **Line In port (light blue).** This port connects the tape, CD, DVD player, or other audio sources.
7. **Line Out port (lime).** This port connects a headphone or a speaker. In 4-channel, 6-channel, and 8-channel configuration, the function of this port becomes Front Speaker Out.
8. **Microphone port (pink).** This port connects a microphone.
9. **Center/Subwoofer port (orange).** This port connects the center/subwoofer speakers.
10. **Rear Speaker Out port (black).** This port connects the rear speakers on a 4-channel, 6-channel, or 8-channel audio configuration.
11. **Side Speaker Out port (gray).** This port connects the side speakers in an 8-channel audio configuration.



---

Refer to the audio configuration table below for the function of the audio ports in 2, 4, 6, or 8-channel configuration.

---

### Audio 2, 4, 6, or 8-channel configuration

Port	Headset 2-channel	4-channel	6-channel	8-channel
Light Blue	Line In	Line In	Line In	Line In
Lime	Line Out	Front Speaker Out	Front Speaker Out	Front Speaker Out
Pink	Mic In	Mic In	Mic In	Mic In
Orange	–	–	Center/Subwoofer	Center/Subwoofer
Black	–	Rear Speaker Out	Rear Speaker Ou	Rear Speaker Out
Gray	–	–	Side Speaker Out	–

12. **USB 2.0 ports 1 and 2, 3 and 4.** These 4-pin Universal Serial Bus (USB) ports are available for connecting USB 2.0 devices.
13. **External SATA ports.** These ports connect to an external SATA box or a Serial ATA port multiplier. These ports support a Serial ATA hard disk drives that you can combine with an external Serial ATA 3.0 Gb/s device to configure a RAID 0, RAID 1, RAID 0+1 (10), RAID 5, or JBOD set through the onboard Silicon Image® SATA RAID controller. Refer to Chapter 5 for details on how to set up Serial ATA RAID configurations.



- 
- Before creating a RAID set using Serial ATA hard disks, make sure that you have connected the Serial ATA signal cable and installed Serial ATA hard disk drives; otherwise, you cannot enter the Silicon Image RAID utility and SATA BIOS setup during POST.
  - The external SATA ports support external Serial ATA 1.5 and 3 Gb/s devices. Longer cables support higher power requirements to deliver signal up to two meters away, and enables improved hot-swap function.
  - If you intend to create a RAID configuration using this connector, set the Silicon 3132 Controller item in the BIOS to [RAID Mode]. See section “4.4.6 Onboard Devices Configuration” for details.
  - Use these ports and an external Serial ATA box connected to the external SATA port, if you want to configure a RAID 0 or RAID 1 set.
  - The Serial ATA port multiplier and external Serial ATA box are purchased separately.
- 



- 
- DO NOT insert a different connector to this port.
  - DO NOT unplug the external Serial ATA box when a RAID 0 or RAID 1 is configured.
- 

14. **IEEE 1394a port.** This 6-pin IEEE 1394a port provides high-speed connectivity for audio/video devices, storage peripherals, PCs, or portable devices.
15. **Onboard LED switch.** This motherboard features onboard LEDs that light up the labels, making it easy for you to install or plug in devices even in the dark. Press this switch to turn on the onboard LEDs.
16. **Optical S/PDIF Out port.** This port connects an external audio output device via an optical S/PDIF cable.
17. **PS/2 keyboard port (purple).** This port is for a PS/2 keyboard.

## 2.8.2 Internal connectors

### 1. Floppy disk drive connector (34-1 pin FLOPPY)

This connector is for the provided floppy disk drive (FDD) signal cable. Insert one end of the cable to this connector, then connect the other end to the signal connector at the back of the floppy disk drive.



Pin 5 on the connector is removed to prevent incorrect cable connection when using a FDD cable with a covered Pin 5.

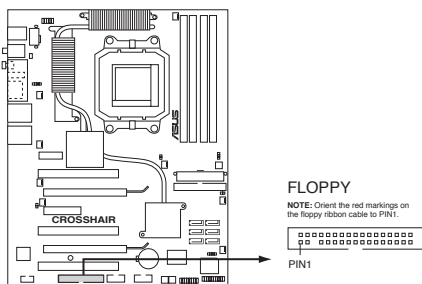

**CROSSHAIR Floppy disk drive connector**

### 2. IDE connector (40-1 pin PRI\_IDE)

The onboard IDE connector is for the Ultra DMA (133/100/66) signal cable. There are three connectors on each Ultra DMA 133/100/66 signal cable: blue, black, and gray. Connect the blue connector to the motherboard's IDE connector, then select one of the following modes to configure your device.

	Drive jumper setting	Mode of device(s)	Cable connector
Single device	Cable-Select or Master	-	Black
Two devices	Cable-Select	Master	Black
		Slave	Gray
	Master	Master	Black or gray
	Slave	Slave	



- Pin 20 on the IDE connector is removed to match the covered hole on the Ultra DMA cable connector. This prevents incorrect insertion when you connect the IDE cable.
- Use the 80-conductor IDE cable for Ultra DMA 133/100/66 IDE devices.



If any device jumper is set as "Cable-Select," make sure all other device jumpers have the same setting.

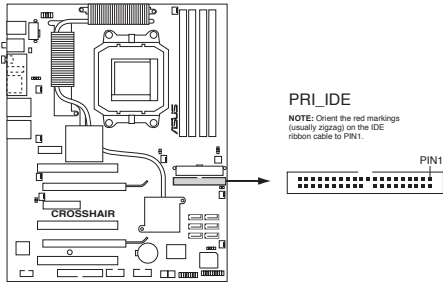

**CROSSHAIR IDE connector**

**3. NVIDIA® NF590-SLI Southbridge Serial ATA connectors (7-pin SATA1 [blue], SATA2 [blue], SATA3 [blue], SATA4 [blue], SATA5 [blue], SATA6 [blue])**

These connectors are for the Serial ATA signal cables for Serial ATA 3.0 Gb/s hard disk and optical disk drives. The Serial ATA 3.0 Gb/s is backward compatible with Serial ATA 1.5 Gb/s specification.

If you installed Serial ATA hard disk drives, you can create a RAID 0, RAID 1, RAID 0+1 (10), RAID 5, or JBOD configuration through the onboard NVRAID controller. Refer to section “5.4.1 NVIDIA® RAID configurations” for details on how to set up Serial ATA RAID configurations.



The RAID function of these connectors is set to [Disabled] by default. If you intend to create a Serial ATA RAID set using these connectors, enable the RAID Enabled item in the BIOS. See section “4.5.4 Onboard Device Configuration > Serial-ATA Configuration” for details.

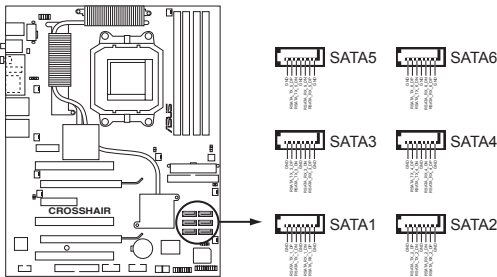

**CROSSHAIR SATA connectors**

#### 4. USB connectors (10-1 pin USB56, USB78, USB910)

These connectors are for USB 2.0 ports. Connect the USB/GAME module cable to any of these connectors, then install the module to a slot opening at the back of the system chassis. These USB connectors comply with USB 2.0 specification that supports up to 480 Mbps connection speed.

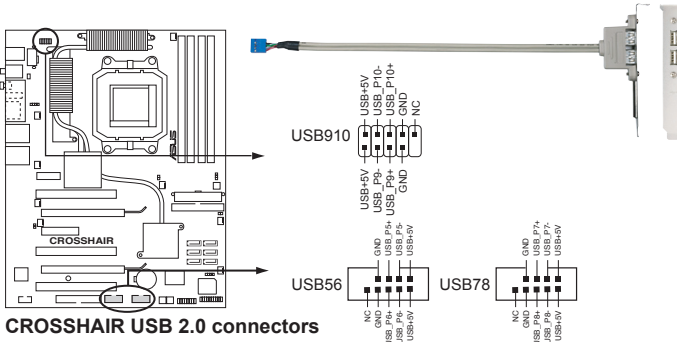

**CROSSHAIR USB 2.0 connectors**



Never connect a 1394 cable to the USB connectors. Doing so will damage the motherboard!

#### 5. IEEE 1394a port connector (10-1 pin IE1394\_2)

This connector is for a IEEE 1394a port. Connect the IEEE 1394a module cable to this connector, then install the module to a slot opening at the back of the system chassis.

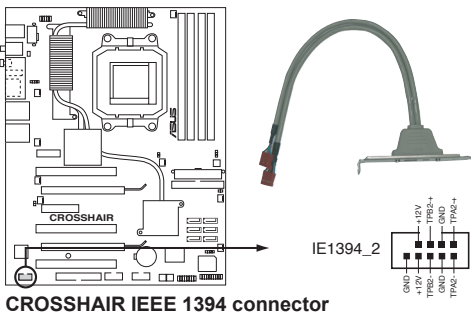

**CROSSHAIR IEEE 1394 connector**



Never connect a USB cable to the IEEE 1394a connector. Doing so will damage the motherboard!



**6. CPU, chassis, and optional fan connectors**  
**(4-pin CPU\_FAN, 3-pin CHA\_REAR\_FAN, 3-pin CHA\_FRONT\_FAN, 3-pin OPT\_FAN1, 3-pin OPT\_FAN2, 3-pin OPT\_FAN3, 3-pin OPT\_FAN4, 3-pin OPT\_FAN5)**

The fan connectors support cooling fans of 350 mA ~ 1000 mA (24 W max.) or a total of 1 A ~ 3.48 A (41.76 W max.) at +12V. Connect the fan cables to the fan connectors on the motherboard, making sure that the black wire of each cable matches the ground pin of the connector.



Do not forget to connect the fan cables to the fan connectors. Insufficient air flow inside the system may damage the motherboard components. These are not jumpers! Do not place jumper caps on the fan connectors!

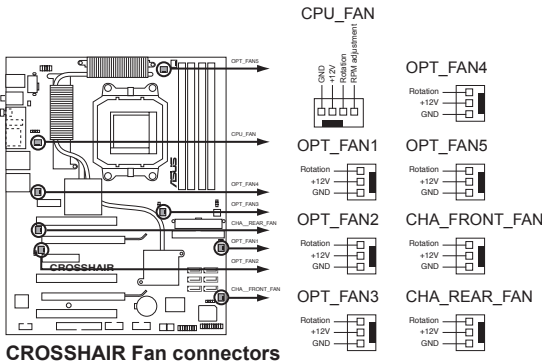

**CROSSHAIR Fan connectors**

**7. Chassis intrusion connector (4-1 pin CHASSIS)**

This connector is for a chassis-mounted intrusion detection sensor or switch. Connect one end of the chassis intrusion sensor or switch cable to this connector. The chassis intrusion sensor or switch sends a high-level signal to this connector when a chassis component is removed or replaced. The signal is then generated as a chassis intrusion event.

By default, the pins labeled “Chassis Signal” and “Ground” are shorted with a jumper cap. Remove the jumper caps only when you intend to use the chassis intrusion detection feature.

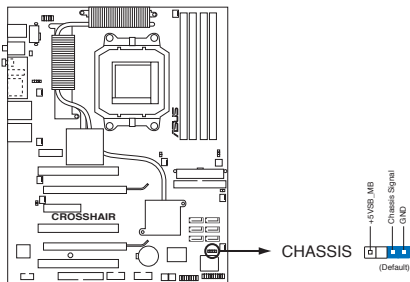

**CROSSHAIR Chassis intrusion connector**

## 8. ATX power connectors (24-pin EATXPWR, 8-pin EATX12V)

These connectors are for ATX power supply plugs. The power supply plugs are designed to fit these connectors in only one orientation. Find the proper orientation and push down firmly until the connectors completely fit.

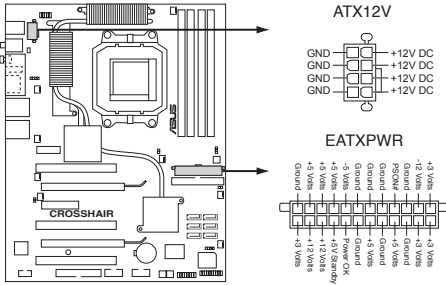

**CROSSHAIR ATX power connectors**



- For a fully configured system, we recommend that you use a power supply unit (PSU) that complies with ATX 12 V Specification 2.0 (or later version) and provides a minimum power of 600 W.
- Do not forget to connect the 8-pin ATX +12 V power plug; otherwise, the system will not boot.
- To support an AMD® Dual-Core CPU, make sure that the PSU can provide at least 16 A and 19 A peak on the +12V\_2 lead.
- Use of a PSU with a higher power output is recommended when configuring a system with more power-consuming devices. The system may become unstable or may not boot up if the power is inadequate.

## 14. System panel connector (20-pin PANEL)

This connector supports several chassis-mounted functions.

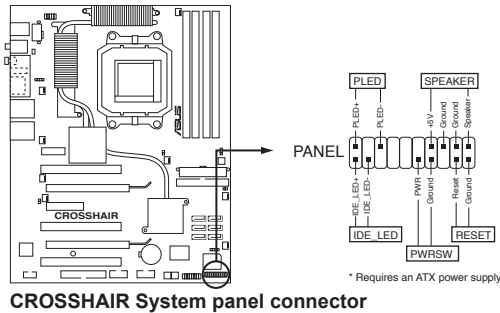

The system panel connector is color-coded for easy connection. Refer to the connector descriptions on the next page for details.

- **System power LED (3-pin PLED)**  
This 3-pin connector is for the system power LED. Connect the chassis power LED cable to this connector. The system power LED lights up when you turn on the system power, and blinks when the system is in sleep mode.
- **Hard disk drive activity LED (2-pin IDE\_LED)**  
This 2-pin connector is for the HDD Activity LED. Connect the HDD Activity LED cable to this connector. The IDE LED lights up or flashes when data is read from or written to the HDD.
- **System warning speaker (4-pin SPEAKER)**  
This 4-pin connector is for the chassis-mounted system warning speaker. The speaker allows you to hear system beeps and warnings.
- **ATX power button/soft-off button (2-pin PWR)**  
This connector is for the system power button. Pressing the power button turns the system on or puts the system in sleep or soft-off mode depending on the BIOS settings. Pressing the power switch for more than four seconds while the system is ON turns the system OFF.
- **Reset button (2-pin RESET)**  
This 2-pin connector is for the chassis-mounted reset button for system reboot without turning off the system power.

## Q-Connector (System panel)

ASUS Q-Connector allows you to easily to connect the chassis front panel cables to the motherboard. Perform these steps to install ASUS Q-Connector.

### Step1.

Connect the front panel cables to their respective connectors on the ASUS Q-Connector. Refer to the labels on the Q-Connector for proper connection and pin definition.

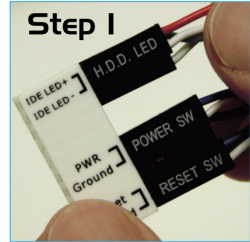

### Step2.

Carefully connect the ASUS Q-Connector to the System panel connector.



The ASUS Q-Connector fits only in one orientation; if it doesn't fit, try reversing it.

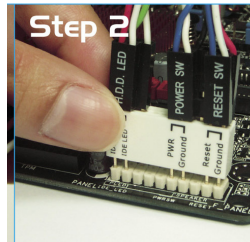

### Step3.

When installed, the Q-connector appears as shown.

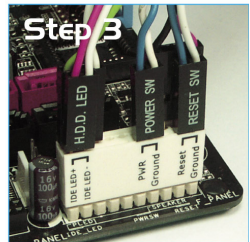

## 15. Thermal sensor cable connectors (W1/2/3, 2-pin)

These connectors are for temperature monitoring. Connect the thermal sensor cables to these connectors and place the other ends to the devices, which you want to monitor temperature. The optional fan1~3 can work with the temperature sensors for a better cooling effect.

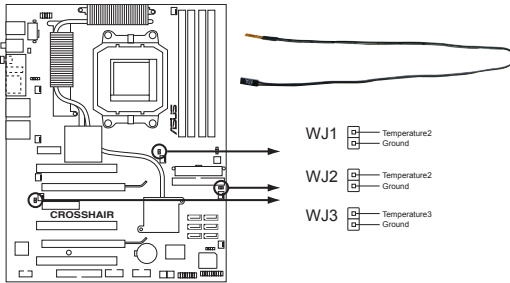

**CROSSHAIR Thermal sensor cable connectors**

## 2.8.3 Onboard switches

Onboard switches allow you to fine-tune performance when working on a bare or open-case system. This is ideal for overclockers and gamers who continually change settings to enhance system performance.

### 1. Clear CMOS switch

Press the clear CMOS switch to clear setup information when the system hangs due to overclocking.

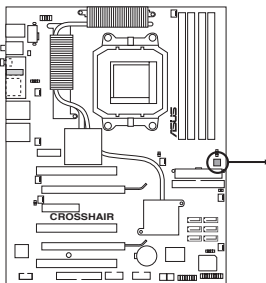

**CROSSHAIR CMOS switch**



To prevent accidental pressing of the Clear CMOS switch, the CLRRTC jumper default setting disables the switch. See page 2-23 for details.

## 2. Power-on switch

Press the clear power-on switch to wake/power up the system.

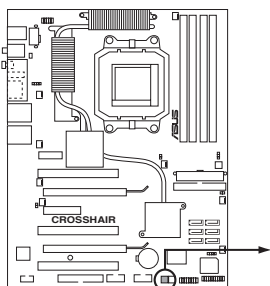

**CROSSHAIR Power on switch**

## 3. Reset switch

Press the reset switch to reboot the system.

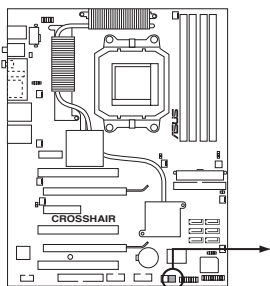

**CROSSHAIR Reset switch**

This chapter describes the power up sequence and ways of shutting down the system.

# Powering up **3**

# Chapter summary

# 3

- 3.1 Starting up for the first time..... 3-1
- 3.2 Powering off the computer..... 3-2



## 3.1 Starting up for the first time

1. After making all the connections, replace the system case cover.
2. Be sure that all switches are off.
3. Connect the power cord to the power connector at the back of the system chassis.
4. Connect the power cord to a power outlet that is equipped with a surge protector.
5. Turn on the devices in the following order:
  - a. Monitor
  - b. External SCSI devices (starting with the last device on the chain)
  - c. System power
6. After applying power, the system power LED on the system front panel case lights up. For systems with ATX power supplies, the system LED lights up when you press the ATX power button. If your monitor complies with “green” standards or if it has a “power standby” feature, the monitor LED may light up or switch between orange and green after the system LED turns on.

The system then runs the power-on self tests or POST. While the tests are running, the BIOS beeps or additional messages appear on the screen. If you do not see anything within 30 seconds from the time you turned on the power, the system may have failed a power-on test. Check the jumper settings and connections or call your retailer for assistance.
7. At power on, hold down the <Delete> key to enter the BIOS Setup. Follow the instructions in Chapter 4.

## **3.2 Powering off the computer**

### **3.2.1 Using the OS shut down function**

If you are using Windows® 2000:

1. Click the Start button then click Shut Down.
2. Make sure that the Shut Down option button is selected, then click the OK button to shut down the computer.
3. The power supply should turn off after Windows® shuts down.

If you are using Windows® XP:

1. Click the Start button then select Turn Off Computer.
2. Click the Turn Off button to shut down the computer.
3. The power supply should turn off after Windows® shuts down.

### **3.2.2 Using the dual function power switch**

While the system is ON, pressing the power switch for less than four seconds puts the system to sleep mode or to soft-off mode, depending on the BIOS setting. Pressing the power switch for more than four seconds lets the system enter the soft-off mode regardless of the BIOS setting. Refer to section “4.6 Power Menu” in Chapter 4 for details.

This chapter tells how to change the system settings through the BIOS Setup menus. Detailed descriptions of the BIOS parameters are also provided.

# BIOS setup **4**

4.1	Managing and updating your BIOS .....	4-1
4.2	BIOS setup program .....	4-10
4.3	Main menu .....	4-14
4.4	Extreme Tweaker menu .....	4-19
4.5	Advanced menu .....	4-28
4.6	Power menu .....	4-34
4.7	Boot menu .....	4-40
4.8	Tools menu .....	4-45
4.9	Exit menu .....	4-49

## 4.1 Managing and updating your BIOS

The following utilities allow you to manage and update the motherboard Basic Input/Output System (BIOS) setup.

1. **ASUS Update** (Updates the BIOS in Windows® environment.)
2. **ASUS EZ Flash 2** (Updates the BIOS in DOS using a floppy disk or a USB flash disk.)
3. **Award BIOS Flash Utility** (Updates the BIOS in DOS mode using a bootable floppy disk.)
4. **ASUS CrashFree BIOS 3** (Updates the BIOS using a bootable floppy disk or the motherboard support DVD when the BIOS file fails or gets corrupted.)

Refer to the corresponding sections for details on these utilities.



---

Save a copy of the original motherboard BIOS file to a bootable floppy disk in case you need to restore the BIOS in the future. Copy the original motherboard BIOS using the ASUS Update or Award BIOS Flash utilities.

---

### 4.1.1 ASUS Update utility

The ASUS Update is a utility that allows you to manage, save, and update the motherboard BIOS in Windows® environment. The ASUS Update utility allows you to:

- Save the current BIOS file
- Download the latest BIOS file from the Internet
- Update the BIOS from an updated BIOS file
- Update the BIOS directly from the Internet, and
- View the BIOS version information.

This utility is available in the support DVD that comes with the motherboard package.



---

ASUS Update requires an Internet connection either through a network or an Internet Service Provider (ISP).

---

### Installing ASUS Update

To install ASUS Update:

1. Place the support DVD in the optical drive. The Drivers menu appears.
2. Click the Utilities tab, then click Install ASUS Update VX.XX.XX. See page 5-3 for the Utilities screen menu.
3. The ASUS Update utility is copied to your system.



Quit all Windows® applications before you update the BIOS using this utility.

## Updating the BIOS through the Internet

To update the BIOS through the Internet:

1. Launch the ASUS Update utility from the Windows® desktop by clicking **Start > Programs > ASUS > ASUSUpdate > ASUSUpdate**. The ASUS Update main window appears.

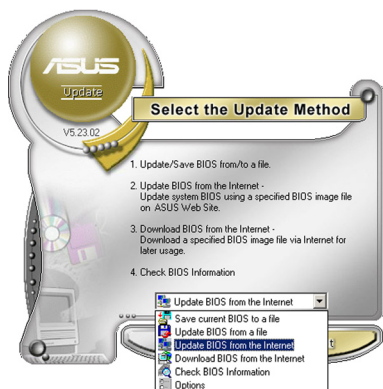
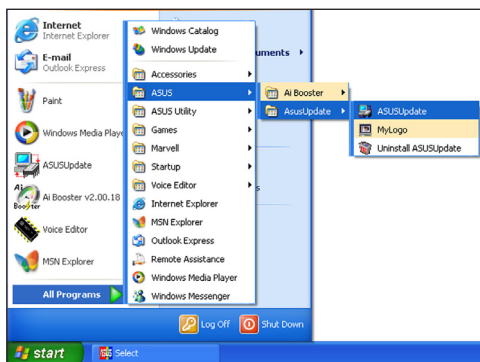

2. Select **Update BIOS** from the Internet option from the drop-down menu, then click **Next**.



3. Select the ASUS FTP site nearest you to avoid network traffic, or click **Auto Select**. Click **Next**.

- From the FTP site, select the BIOS version that you wish to download. Click **Next**.
- Follow the screen instructions to complete the update process.



The ASUS Update utility is capable of updating itself through the Internet. Always update the utility to avail all its features.

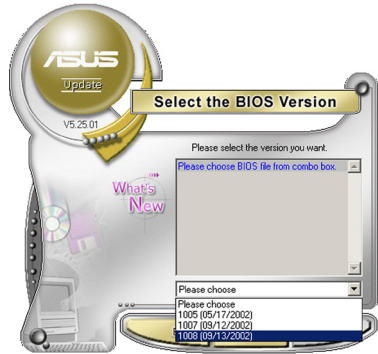

## Updating the BIOS through a BIOS file

To update the BIOS through a BIOS file:

- Launch the ASUS Update utility from the Windows® desktop by clicking **Start > Programs > ASUS > ASUSUpdate > ASUSUpdate**. The ASUS Update main window appears.
- Select Update BIOS from a file option from the drop-down menu, then click **Next**.

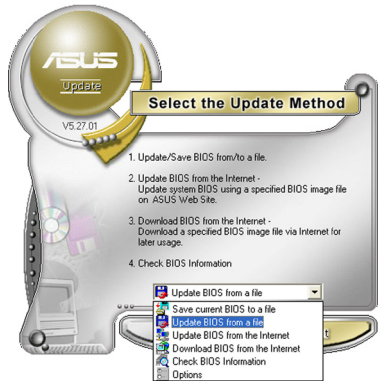

- Locate the BIOS file from the Open window, then click **Open**.
- Follow the screen instructions to complete the update process.

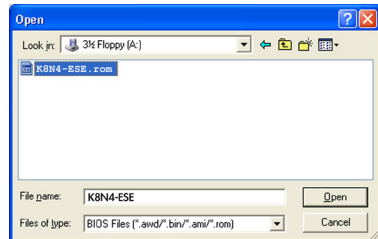

## 4.1.2 Creating a bootable floppy disk

1. Do either one of the following to create a bootable floppy disk.

### *DOS environment*

- a. Insert a 1.44MB floppy disk into the drive.
- b. At the DOS prompt, type `format A: /s` then press <Enter>.

### *Windows® XP environment*

- a. Insert a 1.44 MB floppy disk to the floppy disk drive.
- b. Click **Start** from the Windows® desktop, then select **My Computer**.
- c. Select the 3 1/2 Floppy Drive icon.
- d. Click File from the menu, then select **Format. A Format 3 1/2 Floppy Disk** window appears.
- e. Select **Create an MS-DOS startup disk** from the format options field, then click **Start**.

### *Windows® 2000 environment*

To create a set of boot disks for Windows® 2000:

- a. Insert a formatted, high density 1.44 MB floppy disk into the drive.
- b. Insert the Windows® 2000 CD to the optical drive.
- c. Click **Start**, then select **Run**.
- d. From the Open field, type  
`D:\bootdisk\makeboot a:`  
assuming that D: is your optical drive.
- e. Press <Enter>, then follow screen instructions to continue.

2. Copy the original or the latest motherboard BIOS file to the bootable floppy disk.



### 4.1.3 ASUS EZ Flash 2 utility

The ASUS EZ Flash 2 feature allows you to update the BIOS without having to go through the long process of booting from a floppy disk and using a DOS-based utility. The EZ Flash utility is built-in the BIOS chip so it is accessible by pressing <Alt> + <F2> during the Power-On Self Tests (POST).

To update the BIOS using EZ Flash 2:

1. Visit the ASUS website ([www.asus.com](http://www.asus.com)) to download the latest BIOS file for the motherboard.
2. Save the BIOS file to a floppy disk, then restart the system.
3. Press <Alt> + <F2> during POST to display the following.

```
Insert Disk then press Enter or ESC to continue POST
```

4. Insert the floppy disk that contains the BIOS file to the floppy disk drive then press <Enter>. The following screen appears.

```
AwardBIOS Flash Utility for ASUS V1.14
(C) Phoenix Technologies Ltd. All Rights Reserved

For C51MCP55-CROSSHAIR-00      DATE:04/10/2006
Flash Type - Unknown Flash

File Name to Program: 

Message: Please wait...
```

5. When the correct BIOS file is found, EZ Flash 2 performs the BIOS update process and automatically reboots the system when done.



---

Do not shut down or reset the system while updating the BIOS to prevent system boot failure!

---

### 4.1.4 Updating the BIOS

The Basic Input/Output System (BIOS) can be updated using the AwardBIOS Flash Utility. Follow these instructions to update the BIOS using this utility.

1. Download the latest BIOS file from the ASUS web site. Unzip the file and save it to a floppy disk.



Save only the updated BIOS file in the floppy disk to avoid loading the wrong BIOS file.

2. Copy the AwardBIOS Flash Utility (awdfash.exe) from the Software folder of the support DVD to the floppy disk with the latest BIOS file.
3. Boot the system in DOS mode using the bootable floppy disk you created earlier.
4. When the A:> appears, replace the bootable floppy disk with the floppy disk containing the new BIOS file and the Award BIOS Flash Utility.
5. At the prompt, type awdfash then press <Enter>. The Award BIOS Flash Utility screen appears.

```
AwardBIOS Flash Utility for ASUS V1.14
(C) Phoenix Technologies Ltd. All Rights Reserved

For C51MCP55-CROSSHAIR-00          DATE:04/10/2006
Flash Type - Unknown Flash

File Name to Program: 

Message: Please input File Name!
```

6. Type the BIOS file name in the File Name to Program field, then press <Enter>.

```
AwardBIOS Flash Utility for ASUS V1.14
(C) Phoenix Technologies Ltd. All Rights Reserved

For C51MCP55-CROSSHAIR-00          DATE:04/10/2006
Flash Type - Unknown Flash

File Name to Program: 0113.bin

Message: Do You Want To Save Bios (Y/N)
```

7. Press <N> when the utility prompts you to save the current BIOS file. The following screen appears.
8. The utility verifies the BIOS file in the floppy disk and starts flashing the BIOS file.

```
AwardBIOS Flash Utility for ASUS V1.14
(C) Phoenix Technologies Ltd. All Rights Reserved

For C51MCP55-CROSSHAIR-00      DATE:04/10/2006
Flash Type - Unknown Flash

File Name to Program: 0113.bin

Programming Flash Memory - OFE00 OK

[Progress Bar]

Write OK      No Update      Write Fail

Warning: Don't Turn Off Power Or Reset System!
```



Do not turn off or reset the system during the flashing process!

9. The utility displays a Flashing Complete message indicating that you have successfully flashed the BIOS file. Remove the floppy disk then press <F1> to restart the system.

```
AwardBIOS Flash Utility for ASUS V1.14
(C) Phoenix Technologies Ltd. All Rights Reserved

For C51MCP55-CROSSHAIR-00      DATE:04/10/2006
Flash Type - Unknown Flash

File Name to Program: 0113.bin

Flashing Complete
Press <F1> to Continue

[Progress Bar]

Write OK      No Update      Write Fail

F1 Reset
```

### 4.1.5 Saving the current BIOS file

You can use the AwardBIOS Flash Utility to save the current BIOS file. You can load the current BIOS file when the BIOS file gets corrupted during the flashing process.



Make sure that the floppy disk has enough disk space to save the file.

To save the current BIOS file using the AwardBIOS Flash Utility:

1. Follow steps 1 to 6 of the previous section.
2. Press <Y> when the utility prompts you to save the current BIOS file. The following screen appears.

```
AwardBIOS Flash Utility for ASUS V1.14
(C) Phoenix Technologies Ltd. All Rights Reserved

For C51MCP55-CROSSHAIR-00      DATE:04/10/2006
Flash Type - Unknown Flash

File Name to Program: 0113.bin
Save current BIOS as:

Message:
```

3. Type a filename for the current BIOS file in the Save current BIOS as field, then press <Enter>.

```
AwardBIOS Flash Utility for ASUS V1.14
(C) Phoenix Technologies Ltd. All Rights Reserved

For C51MCP55-CROSSHAIR-00      DATE:04/10/2006
Flash Type - Unknown Flash

File Name to Program:
Checksum: D800H
Save current BIOS as: old.bin

Message: Please Wait!
```

4. The utility saves the current BIOS file to the floppy disk, then returns to the BIOS flashing process.

```
AwardBIOS Flash Utility for ASUS V1.14
(C) Phoenix Technologies Ltd. All Rights Reserved

For C51MCP55-CROSSHAIR-00      DATE:04/10/2006
Flash Type - Unknown Flash

File Name to Program: 0113.bin
Now Backup System BIOS to
File!

Message: Please Wait!
```

## 4.1.6 ASUS CrashFree BIOS 3 utility

The ASUS CrashFree BIOS 3 is an auto recovery tool that allows you to restore the BIOS file when it fails or gets corrupted during the updating process. You can update a corrupted BIOS file using the motherboard support DVD or the floppy disk that contains the updated BIOS file.



---

Prepare the motherboard support DVD or the floppy disk containing the updated motherboard BIOS before using this utility.

---

### Recovering the BIOS from the support DVD

To recover the BIOS from the support DVD:

1. Turn on the system.
2. Insert the motherboard support DVD to the optical drive.
3. The utility displays the following message and automatically checks the DVD for the BIOS file.

```
Award BootBlock BIOS v1.0
Copyright (c) 2000, Award Software, Inc.

BIOS ROM checksum error
Detecting IDE ATAPI device...
```

When found, the utility reads the BIOS file and starts flashing the corrupted BIOS file.

```
Award BootBlock BIOS v1.0
Copyright (c) 2000, Award Software, Inc.

BIOS ROM checksum error
Detecting IDE ATAPI device...
  Found CDROM, try to Boot from it... Pass
```



---

**DO NOT** shut down or reset the system while updating the BIOS! Doing so can cause system boot failure!

---

4. Restart the system after the utility completes the updating process.

## 4.2 BIOS setup program

This motherboard supports a programmable Low-Pin Count (LPC) chip that you can update using the provided utility described in section “4.1 Managing and updating your BIOS.”

Use the BIOS Setup program when you are installing a motherboard, reconfiguring your system, or prompted to “Run Setup.” This section explains how to configure your system using this utility.

Even if you are not prompted to use the Setup program, you can change the configuration of your computer in the future. For example, you can enable the security password feature or change the power management settings. This requires you to reconfigure your system using the BIOS Setup program so that the computer can recognize these changes and record them in the CMOS RAM of the LPC chip.

The LPC chip on the motherboard stores the Setup utility. When you start up the computer, the system provides you with the opportunity to run this program. Press <Del> during the Power-On Self-Test (POST) to enter the Setup utility; otherwise, POST continues with its test routines.

If you wish to enter Setup after POST, restart the system by pressing <Ctrl+Alt+Delete>, or by pressing the reset button on the system chassis. You can also restart by turning the system off and then back on. Do this last option only if the first two failed.

The Setup program is designed to make it as easy to use as possible. Being a menu-driven program, it lets you scroll through the various sub-menus and make your selections from the available options using the navigation keys.



- 
- The default BIOS settings for this motherboard apply for most conditions to ensure optimum performance. If the system becomes unstable after changing any BIOS settings, load the default settings to ensure system compatibility and stability. Select the **Load Default Settings** item under the Exit Menu. See section “4.9 Exit Menu.”
  - The BIOS setup screens shown in this section are for reference purposes only, and may not exactly match what you see on your screen.
  - Visit the ASUS website ([www.asus.com](http://www.asus.com)) to download the latest BIOS file for this motherboard.
-

## 4.2.1 BIOS menu screen

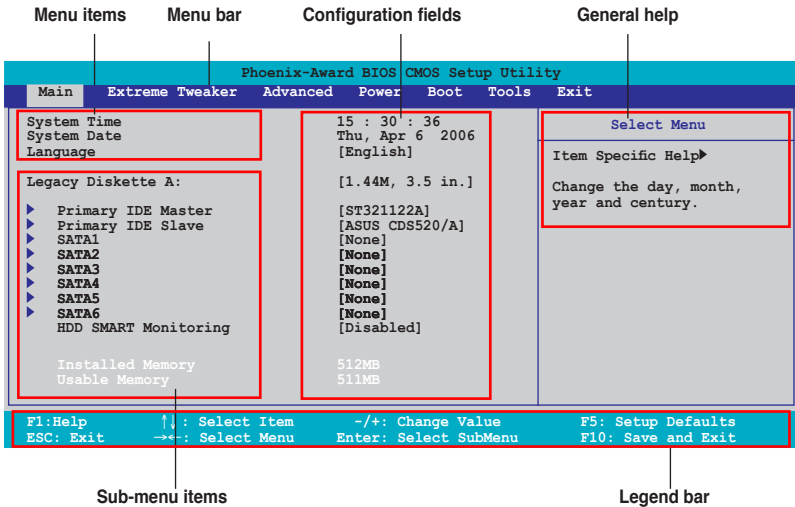

## 4.2.2 Menu bar

The menu bar on top of the screen has the following main items:

- Main** For changing the basic system configuration
- Extreme Tweaker** For changing the overclocking settings
- Advanced** For changing the advanced system settings
- Power** For changing the advanced power management (APM) configuration
- Boot** For changing the system boot configuration
- Tools** For configuring options for special functions
- Exit** For selecting the exit options and loading default settings

To select an item on the menu bar, press the right or left arrow key on the keyboard until the desired item is highlighted.



- The BIOS setup screens shown in this chapter are for reference purposes only, and may not exactly match what you see on your screen.
- Visit the ASUS website ([www.asus.com](http://www.asus.com)) to download the latest BIOS information.

### 4.2.3 Legend bar

At the bottom of the Setup screen is a legend bar. The keys in the legend bar allow you to navigate through the various setup menus. The following table lists the keys found in the legend bar with their corresponding functions.

Navigation Key	Function
<F1>	Displays the General Help screen
<F5>	Loads setup default values
<Esc>	Exits the BIOS setup or returns to the main menu from a sub-menu
Left or Right arrow	Selects the menu item to the left or right
Up or Down arrow	Moves the highlight up or down between fields
Page Down or - (minus)	Scrolls backward through the values for the highlighted field
Page Up or + (plus)	Scrolls forward through the values for the highlighted field
<Enter>	Brings up a selection menu for the highlighted field
<F10>	Saves changes and exit

### 4.2.4 Menu items

The highlighted item on the menu bar displays the specific items for that menu. For example, selecting **Main** shows the Main menu items.

The other items (Advanced, Power, Boot, and Exit) on the menu bar have their respective menu items.

### 4.2.5 Sub-menu items

A solid triangle before each item on any menu screen means that the item has a sub-menu. To display the sub-menu, select the item and press <Enter>.

### 4.2.6 Configuration fields

These fields show the values for the menu items. If an item is user-configurable, you can change the value of the field opposite the item. You cannot select an item that is not user-configurable.

A configurable field is enclosed in brackets, and is highlighted when selected. To change the value of a field, select it then press <Enter> to display a list of options. Refer to “4.2.7 Pop-up window.”



## 4.2.7 Pop-up window

Select a menu item then press <Enter> to display a pop-up window with the configuration options for that item.

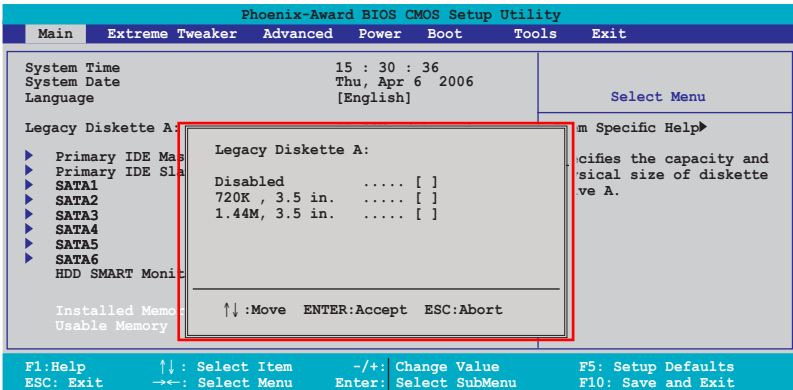

Pop-up menu

## 4.2.8 General help

At the top right corner of the menu screen is a brief description of the selected item.

## 4.3 Main menu

When you enter the BIOS Setup program, the Main menu screen appears, giving you an overview of the basic system information.



Refer to section “4.2.1 BIOS menu screen” for information on the menu screen items and how to navigate through them.

Phoenix-Award BIOS CMOS Setup Utility		
Main	Extreme Tweaker	Advanced Power Boot Tools Exit
System Time	15 : 30 : 36	Select Menu
System Date	Thu, Apr 6 2006	Item Specific Help▶ Change the day, month, year and century.
Language	[English]	
Legacy Diskette A:	[1.44M, 3.5 in.]	
▶ Primary IDE Master	[ST321122A]	
▶ Primary IDE Slave	[ASUS CDS520/A]	
▶ SATA1	[None]	
▶ SATA2	[None]	
▶ SATA3	[None]	
▶ SATA4	[None]	
▶ SATA5	[None]	
▶ SATA6	[None]	
HDD SMART Monitoring	[Disabled]	
Installed Memory	512MB	
Usable Memory	511MB	

F1: Help    ↑↓: Select Item    -/+ : Change Value    F5: Setup Defaults  
ESC: Exit    →←: Select Menu    Enter: Select SubMenu    F10: Save and Exit

### 4.3.1 System Time [xx:xx:xx]

Allows you to set the system time.

### 4.3.2 System Date [Day xx/xx/xxxx]

Allows you to set the system date.

### 4.3.3 Language [English]

Allows you to choose the BIOS language version from the options. Configuration options: [English] [French] [Deutsch] [Chines (Trad.)] [Chinese (Simp.)] [Japanese]

### 4.3.4 Legacy Diskette A [1.44M, 3.5 in.]

Sets the type of floppy drive installed.

Configuration options: [Disabled] [720K , 3.5 in.] [1.44M, 3.5 in.]

### 4.3.5 Primary IDE Master/Slave

While entering Setup, the BIOS automatically detects the presence of IDE devices. There is a separate sub-menu for each IDE device. Select a device item then press <Enter> to display the IDE device information.

Phoenix-Award BIOS CMOS Setup Utility			
Main			
Primary IDE Master		Select Menu	
PIO Mode	[Auto]	Item Specific Help▶▶  Set a PIO mode for IDE device. Mode0 through 4 for successive increase in performance.	
UDMA Mode	[Auto]		
Primary IDE Master	[Auto]		
Access Mode	[Auto]		
Capacity	82 GB		
Cylinder	39420		
Head	16		
Sector	255		
Transfer Mode	UDMA 5		
F1: Help      ↑↓ : Select Item      -/+ : Change Value      F5: Setup Defaults			
ESC: Exit    →← : Select Menu      Enter: Select SubMenu      F10: Save and Exit			

The BIOS automatically detects the values opposite the dimmed items (Capacity, Cylinder, Head, Sector and Transfer Mode). These values are not user-configurable. These items show N/A if no IDE device is installed in the system.

#### PIO Mode [Auto]

Sets the PIO mode for the IDE device.

Configuration options: [Auto] [Mode 0] [Mode 1] [Mode 2] [Mode 3] [Mode 4]

#### UDMA Mode [Auto]

Disables or sets the UDMA mode. Configuration options: [Disable] [Auto]

#### Primary IDE Master/Slave [Auto]

Select [Auto] to automatically detect an IDE hard disk drive. If automatic detection is successful, the BIOS automatically fills in the correct values for the remaining fields on this sub-menu. If the hard disk was already formatted on a previous system, the setup BIOS may detect incorrect parameters. Select [Manual] to manually enter the IDE hard disk drive parameters. If no drive is installed select [None]. Configuration options: [None] [Auto] [Manual]

## Access Mode [Auto]

The default [Auto] allows automatic detection of an IDE hard disk drive. Select [CHS] for this item if you set the IDE Primary Master/Slave to [Manual]. Configuration options: [CHS] [LBA] [Large] [Auto]



---

Before attempting to configure a hard disk drive, make sure you have the correct configuration information supplied by the drive manufacturer. Incorrect settings may cause the system to fail to recognize the installed hard disk.

---

## Capacity

Displays the auto-detected hard disk capacity. This item is not configurable.

## Cylinder

Shows the number of the hard disk cylinders. This item is not configurable.

## Head

Shows the number of the hard disk read/write heads. This item is not configurable.

## Sector

Shows the number of sectors per track. This item is not configurable.

## Transfer Mode

Shows the Transfer mode. This item is not configurable.



---

After entering the IDE hard disk drive information into BIOS, use a disk utility, such as FDISK, to partition and format new IDE hard disk drives. This is necessary so that you can write or read data from the hard disk. Make sure to set the partition of the Primary IDE hard disk drives to active.

---

### 4.3.6 SATA1/2/3/4/5/6

While entering Setup, the BIOS automatically detects the presence of Serial ATA devices. There is a separate sub-menu for each SATA device. Select a device item then press <Enter> to display the SATA device information.

Phoenix-Award BIOS CMOS Setup Utility		
Main		
SATA1		Select Menu
Extended IDE Drive	[Auto]	Item Specific Help▶▶ Selects the type of fixed disk connected to the system.
Access Mode	[Auto]	
Capacity	0 MB	
Cylinder	0	
Head	0	
Landing Zone	0	
Sector	0	

F1: Help      ↑↓ : Select Item      -/+ : Change Value      F5: Setup Defaults  
ESC: Exit      →← : Select Menu      Enter: Select SubMenu      F10: Save and Exit

The BIOS automatically detects the values opposite the dimmed items (Capacity, Cylinder, Head, Landing Zone and Sector). These values are not user-configurable. These items show 0 if no SATA device is installed in the system.

#### Extended IDE Drive [Auto]

Selects the type of fixed disk connected to the system.

Configuration options: [None] [Auto]

#### Access Mode [Auto]

Sets the sector addressing mode. Configuration options: [Large] [Auto]



Before attempting to configure a hard disk drive, make sure you have the correct configuration information supplied by the drive manufacturer. Incorrect settings may cause the system to fail to recognize the installed hard disk.

#### Capacity

Displays the auto-detected hard disk capacity. This item is not configurable.

#### Cylinder

Shows the number of the hard disk cylinders. This item is not configurable.

## Head

Shows the number of the hard disk read/write heads. This item is not configurable.

## Landing Zone

Shows the number of landing zone per track. This item is not configurable.

## Sector

Shows the number of sectors per track. This item is not configurable.



---

After entering the IDE hard disk drive information into BIOS, use a disk utility, such as FDISK, to partition and format new IDE hard disk drives. This is necessary so that you can write or read data from the hard disk. Make sure to set the partition of the Primary IDE hard disk drives to active.

---

### 4.3.7 HDD SMART Monitoring [Disabled]

Allows you to enable or disable the HDD Self-Monitoring Analysis and Reporting Technology (SMART) feature. Configuration options: [Disabled] [Enabled]

### 4.3.8 Installed Memory [xxx MB]

Shows the size of installed memory.

### 4.3.9 Usable Memory [XXX MB]

Shows the size of usable memory.

## 4.4 Extreme Tweaker menu

The Extreme menu items allow you to configure overclocking-related items.



Take caution when changing the settings of the Extreme menu items. Incorrect field values can cause the system to malfunction.

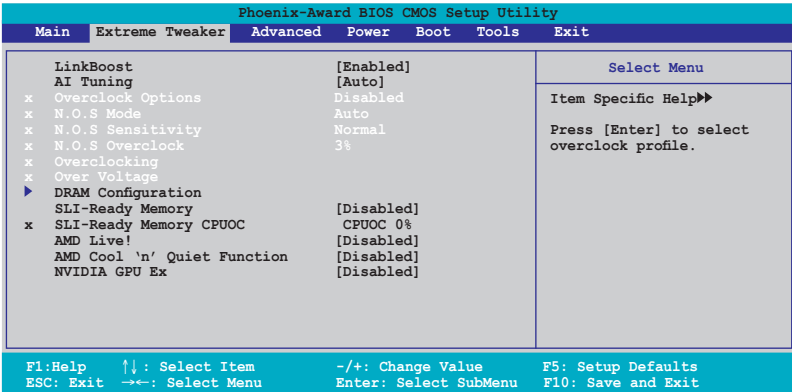

### 4.4.1 LinkBoost [Enabled]

When you install 7900GTX or 7950 GX2 graphics card, this model will auto overclock to get a better performance. Configuration options: [Disabled] [Enabled]

### 4.4.2 AI Tuning [Auto]

Allows selection of CPU overclocking options to achieve desired CPU internal frequency. Select either one of the preset overclocking configuration options:

**Manual** Allows you to individually set overclocking parameters.

**Auto** Loads the optimal settings for the system.

**Standard** Loads the standard settings for the system.

**AI Overclock** Loads overclocking profiles with optimal parameters for stability when overclocking.

**AI N.O.S.** The ASUS Non-delay Overclocking System feature intelligently determines the system load and automatically boosts the performance for the most demanding tasks.



The following item becomes user-configurable when you set **AI Tuning** to [AI Overclock]

### Overclock Options [Disabled]

Allows you to set the overclocking options.

Configuration options: [Disabled] [Overclock 3%] [Overclock 5%] [Overclock 8%] [Overclock 10%]



The following item becomes user-configurable when you set **AI Tuning** to [AI N.O.S.]

### N.O.S. Mode [Auto]

Allows you to set the Non-delay Overclocking System mode.  
Configuration options: [Auto] [Manual]



The following items become user-configurable when you set **N.O.S. Mode** to [Manual].

### N.O.S. Sensitivity [Normal]

Allows you to set the Non-delay Overclocking System sensitivity.  
Configuration options: [Normal] [Sensitive] [Less-Sensitive]

### N.O.S. Overclock [3%]

Allows you to set the Non-delay Overclocking System overclocking options.  
Configuration options: [3%] [5%] [8%] [10%]



The **Overclocking and Over Voltage** items become user-configurable when you set **AI Tuning** to [Manual].

## Overclocking

This sub-menu allows you to adjust the system frequency-related items. Select an item, then press <Enter> to edit.

Phoenix-Award BIOS CMOS Setup Utility	
Extreme Tweaker	
Overclocking	Select Menu
CPU Type	AMD Athlon(tm) 64 Processor 3800+
CPU Speed	2000 MHz
Cache RAM	512K
CPU Frequency	[Auto]
Memory Clock Frequency	[Auto]
PCIEX16_1 Clock	[Auto]
PCIEX16_2 Clock	[Auto]
CPU<->NB HT Speed	[Auto]
NB to SB HT Frequency	[Auto]
NB --> SB HT Speed	[5xNB to SB HT Frequency]
SB --> NB HT Speed	[5xSB to NB HT Frequency]
CPU<->NB HT Width	[16  16]
NB<->SB HT Width	[16  16]
	Item Specific Help▶▶▶
F1: Help	↑↓: Select Item
ESC: Exit	→←: Select Menu
	-/+ : Change Value
	Enter: Select Sub-menu
	F5: Setup Defaults
	F10: Save and Exit

### CPU Frequency [XXX] (value is auto-detected)

Indicates the frequency sent by the clock generator to the system bus and PCI bus. The bus frequency (external frequency) multiplied by the bus multiple equals the CPU speed. The BIOS auto-detects the value of this item. The values range from 200.0 to 400.0.





---

Setting a very high CPU frequency may cause the system to become unstable. If this happens, revert to the default setting.

---

*CPU Multiplier [Auto]*

Allows you to set the operating CPU multiplier. the configuration options may vary depending on the type of CPU installed.

Configuration options: [Auto] [5x] [6x]~[25x]

*Memory Clock Frequency [Auto]*

Sets the memory clock frequency.

Configuration options: [Auto] [DDR2 400] [DDR2 533] [DDR2 667] [DDR2 800]

*PCIEX16\_1 / PCIEX16\_2 Clock [Auto]*

Allows you to set the PCI Express clock.

Configuration options: [Auto] [100MHz] ~[200MHz]

*CPU<->NB HT Speed [Auto]*

Allows you to set the CPU to Northbridge HT Speed.

Configuration options: [Auto] [1xCPU Frequency] [2xCPU Frequency] [3xCPU Frequency] [4xCPU Frequency] [5xCPU Frequency]

*NB to SB HT Frequency [Auto]*

Allows you to set the Northbridge to Southbridge HT frequency.

Configuration options: [Auto] [200MHz] ~ [400MHz]

*NB-->SB HT Speed [5xNB to SB HT Frequency]*

Allows you to set the Northbridge to Southbridge HT Speed.

Configuration options: [1xNB to SB HT Frequency] [2xNB to SB HT Frequency] [3xNB to SB HT Frequency] [4xNB to SB HT Frequency] [5xNB to SB HT Frequency]

*SB-->NB HT Speed [5xSB to NB HT Frequency]*

Allows you to set the Southbridge to Northbridge HT Speed.

Configuration options: [1xSB to NB HT Frequency] [2xSB to NB HT Frequency] [3xSB to NB HT Frequency] [4xSB to NB HT Frequency] [5xSB to NB HT Frequency]

*CPU<->NB HT Width [↓16 ↑16]*

Allows you to set the CPU to Northbridge HT width.

Configuration options: [↓8 ↑8] [↓16 ↑16]

*NB<->SB HT Width [↓16 ↑16]*

Allows you to set the Northbridge to Southbridge HT width.

Configuration options: [↓4 ↑4] [↓8 ↑8] [↓16 ↑16]

## Over Voltage

This sub-menu allows you to adjust the voltage-related items. Select an item, then press <Enter> to edit.

Phoenix-Award BIOS CMOS Setup Utility		
Extreme Tweaker		
Advanced Voltage Control		Select Menu
x CPU Voltage Range	[Auto]	Item Specific Help▶▶▶ Press [Enter] to set.
CPU Voltage	[Auto]	
DDR2 Voltage Control	[Auto]	
HT Link Voltage	[Auto]	
NB Core Voltage	[Auto]	
SB Core Voltage	[Auto]	
SB PLL Voltage	[Auto]	
DDR2 Termination Voltage	[Auto]	
DDR2 Controller Ref Voltage	[Auto]	
DDR2 Channel A Ref Voltage	[Auto]	
DDR2 Channel B Ref Voltage	[Auto]	
F1:Help    ↑↓: Select Item    -/+ : Change Value    F5: Setup Defaults ESC: Exit    ←→: Select Menu    Enter: Select Sub-menu    F10: Save and Exit		

### CPU Voltage Range [Auto]

Allows you to set the operating CPU voltage range.

Configuration options: [Auto] [0.85V-0.95V] [0.95V-1.05V] ~ [1.75V-1.85V]



The following item becomes user-configurable when you set the CPU Voltage Range to any of the available options, except [Auto].

### CPU Voltage [Auto]

Allows you to set the operating CPU voltage.

Configuration options: [Auto] [1.75000V] [1.75625V] [1.76250V] [1.76875V] [1.77500V] [1.78125V] [1.78750V] [1.79375V] [1.8000V] [1.80625V] [1.81250V] [1.81875V] [1.82500V] [1.83125V] [1.83750V] [1.84375V] [1.85000V]

### DDR2 Voltage Control [Auto]

Allows you to set the operating DDR2 voltage.

Configuration options: [Auto] [1.850V] [1.875V] [1.900V] ~ [3.425V]

### HT Link Voltage [Auto]

Allows you to set the HT Link voltage.

Configuration options: [Auto] [1.200V] [1.225V] [1.250V] [1.275V] ~ [1.575V]

### NB Core Voltage [Auto]

Allows you to set the NB Core voltage.

Configuration options: [Auto] [1.200V] [1.225V] [1.250V] [1.275V]~[1.575V]

### SB Core Voltage [Auto]

Allows you to set the SB Core voltage.

Configuration options: [Auto] [1.500V] [1.525V] [1.550V]~[1.875V]

### SB PLL Voltage [Auto]

Allows you to set the SB PLL voltage.

Configuration options: [Auto] [1.50V] [1.55V]~[1.85V]

### DDR2 Termination Voltage [Auto]

Allows you to set the DDR2 termination voltage.

Configuration options: [Auto] [DDR2\_Vol/2] [DDR2\_Vol/2 -50mV]  
[DDR2\_Vol/2-100mV] [DDR2\_Vol/2-150mV] [DDR2\_Vol/2+ 50mV]  
[DDR2\_Vol/2+100mV] [DDR2\_Vol/2+150mV]

### DDR2 Controller Ref Voltage [Auto]

Allows you to set the DDR2 Controller Ref Voltage

Configuration options: [Auto] [DDR2\_Vol/2] [DDR2\_Vol/2- 50mV]  
[DDR2\_Vol/2-100mV] [DDR2\_Vol/2-150mV] [DDR2\_Vol/2+ 50mV]  
[DDR2\_Vol/2+100mV] [DDR2\_Vol/2+150mV]

### DDR2 Channel A Ref Voltage / DDR2 Channel B Ref Voltage [Auto]

Allows you to set the DDR2 Controller/ChannelA/B Ref voltage.

Configuration options: [Auto] [DDR2\_Vol/2] [DDR2\_Vol/2-100mV] [DDR2\_Vol/2+ 50mV] [DDR2\_Vol/2+100mV] [DDR2\_Vol/2+150mV]

## 4.4.3 DRAM Configuration

The items in the sub-menu show the DRAM-related information auto-detected by the BIOS.

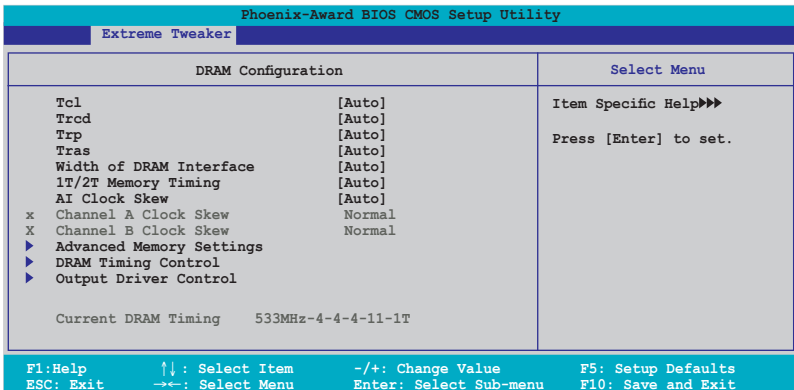

*Tcl [Auto]*

Configuration options: [Auto] [3] [4] [5] [6]

*Trcd [Auto]*

Configuration options: [Auto] [3] [4] [5] [6]

*Trp [Auto]*

Configuration options: [Auto] [3] [4] [5] [6]

*Tras [Auto]*

Configuration options: [Auto] [5] [6] [7]~[18]

*Width of DRAM Interface [Auto]*

Configuration options: [Auto] [64-bit]

*1T/2T Memory Timing [Auto]*

Configuration options: [Auto] [1T] [2T]

*DRAM ECC Enable [Disabled]*

Enables or disables the DRAM ECC function.

Configuration options: [Disabled] [Enabled]



---

This item appears only when you install DRAM modules that support ECC function.

---

*AI Clock Skew [Auto]*

Below items become user-configurable when you set the AI Clock Skew to [Manual].

Channel A Clock Skew: [Advance 900ps] [Advance 750ps] [Advance 600ps] [Advance 450ps] [Advance 300ps] [Advance 150ps] [Normal] [Delay 150ps] [Delay 300ps] [Delay 450ps] [Delay 600ps] [Delay 750ps] [Delay 900ps]

Channel B Clock Skew: [Advance 900ps] [Advance 750ps] [Advance 600ps] [Advance 450ps] [Advance 300ps] [Advance 150ps] [Normal] [Delay 150ps] [Delay 300ps] [Delay 450ps] [Delay 600ps] [Delay 750ps] [Delay 900ps]

## Advanced Memory Settings

Phoenix-Award BIOS CMOS Setup Utility			
Extreme Tweaker			
Advanced Memory Settings	Select Menu		
CPU On-die Termination	[Auto]	Item Specific Help▶▶▶	
Trc	[Auto]	Press [Enter] to set.	
Twr	[Auto]		
Trrd	[Auto]		
Trwt	[Auto]		
Twtr	[Auto]		
Trtp	[Auto]		
Twrrd	[Auto]		
Twrwr	[Auto]		
Trdrd	[Auto]		
Tref	[Auto]		
Trfc	[Auto]		
DRAM Termination	[Auto]		
Max Async Latency	[Auto]		
R/W Queue Bypass	[Auto]		
Dynamic Idle Cycle Counter	[Auto]		
Idle Cycle Limit	[Auto]		
DCQ Bypass Maximum	[Auto]		
DRAM Burst Length	[Auto]		
DRAM Bank Interleaving	[Enabled]		
F1: Help	↑↓: Select Item	-/+ : Change Value	F5: Setup Defaults
ESC: Exit	→←: Select Menu	Enter: Select Sub-menu	F10: Save and Exit

### CPU On-die Termination [Auto]

Configuration options: [Auto] [300 ohm] [150 ohm] [75 ohm]

### Trc [Auto]

Configuration options: [Auto] [11] [12] [13]~[26]

### Twr [Auto]

Configuration options: [Auto] [3] [4] [5] [6]

### Trrd [Auto]

Configuration options: [Auto] [2] [3] [4] [5]

### Trwt [Auto]

Configuration options: [Auto] [2] [3] [4] [5] ~ [9]

### Twtr [Auto]

Configuration options: [Auto] [1] [2] [3]

### Trtp [Auto]

Configuration options: [Auto] [2/4] [3/5]

### Twrrd [Auto]

Configuration options: [Auto] [0] [1] [2] [3]

### Twrwr [Auto]

Configuration options: [Auto] [1] [2] [3]

### Trdrd [Auto]

Configuration options: [Auto] [2] [3] [4] [5]

### Tref [Auto]

Configuration options: [Auto] [7.8 us] [3.9 us]

### Trfc [Auto]

Configuration options: [Auto] [0] [1] [2] [3]

### DRAM Termination [Auto]

Configuration options: [Auto] [Disabled] [75 ohms] [150 ohms] [50 ohms]

### Max Async Latency [Auto]

Configuration options: [Auto] [0 ns] [1 ns] [2 ns] ~ [15 ns]

### R/W Queue Bypass [Auto]

Configuration options: [Auto] [2x] [4x] [8x] [16x]

### Dynamic Idle Cycle Counter [Auto]

Configuration options: [Auto] [Disabled] [Enabled]

### Idle Cycle Limit [Auto]

Configuration options: [Auto] [0 cycles] [4 cycles] [8 cycles] [16 cycles] [32 cycles] [64 cycles] [128 cycles] [256 cycles]

### DCQ Bypass Maximum [Auto]

Configuration options: [Auto] [0x] [1x] [2x]~[15x]

### DRAM Burst Length [Auto]

Configuration options: [Auto] [64-byte] [32-byte]

### DRAM Bank Interleaving [Enabled]

Configuration options: [Disabled] [Enabled]

## DRAM Timing Control

Phoenix-Award BIOS CMOS Setup Utility		
Extreme Tweaker		
DRAM Timing Control		Select Menu
CHA CKE Fine Delay	[Auto]	Item Specific Help▶▶▶▶
CHB CKE Fine Delay	[Auto]	Press [Enter] to set.
CHA CKE Setup Time	[Auto]	
CHB CKE Setup Time	[Auto]	
CHA CS/ODT Fine Delay	[Auto]	
CHB CS/ODT Fine Delay	[Auto]	
CHA CS/ODT Setup Time	[Auto]	
CHB CS/ODT Setup Time	[Auto]	
CHA Add/CMD Fine Delay	[Auto]	
CHB Add/CMD Fine Delay	[Auto]	
CHA Add/CMD Setup Time	[Auto]	
CHB Add/CMD Setup Time	[Auto]	
Read DQS Timing Control	[Auto]	
Write Data Timing Control	[Auto]	
DQS Receiver Enable Timing	[Auto]	

F1: Help                    ↑↓: Select Item                    -/+ : Change Value                    F5: Setup Defaults  
ESC: Exit                ←→: Select Menu                    Enter: Select Sub-menu                F10: Save and Exit

### CHA/CHB CKE Fine Delay [Auto]

Configuration options: [Auto] [No delay] [1/64 MEMCLK delay] [2/64 MEMCLK delay] [3/64 MEMCLK delay] ~ [31/64 MEMCLK delay]

### CHA/CHB CKE Setup Time [Auto]

Configuration options: [Auto] [1/2 MEMCLK] [1 MEMCLK]

### CHA/CHB C/S ODT Fine Delay [Auto]

Configuration options: [Auto] [No delay] [1/64 MEMCLK delay] [2/64 MEMCLK delay] [3/64 MEMCLK delay] ~ [31/64 MEMCLK delay]

### CHA/CHB C/S ODT Setup Time [Auto]

Configuration options: [Auto] [1/2 MEMCLK] [1 MEMCLK]

### CHA/CHB Add/CMD Fine Delay [Auto]

Configuration options: [Auto] [No delay] [1/64 MEMCLK delay] [2/64 MEMCLK delay] [3/64 MEMCLK delay] ~ [31/64 MEMCLK delay]

### CHA/CHB Add/CMD Setup Time [Auto]

Configuration options: [Auto] [1/2 MEMCLK] [1 MEMCLK]

### Read DQS Timing Control [Auto]

Configuration options: [Auto] [No delay] [1/96 MEMCLK delay] [2/96 MEMCLK delay] [3/96 MEMCLK delay] ~ [47/96 MEMCLK delay]

### Write Data Timing Control [Auto]

Configuration options: [Auto] [No delay] [1/96 MEMCLK delay] [2/96 MEMCLK delay] [3/96 MEMCLK]...[47/96 MEMCLK delay]

### DQS Receiver Enable Timing [Auto]

Configuration options: [Auto] [0 ps] [50 ps] [100 ps] [150 ps] ~ [8700 ps]

### Output Driver Control

Phoenix-Award BIOS CMOS Setup Utility	
Extreme Tweaker	
Output Driver Control	Select Menu
CHA CKE Drive Strength [Auto]	Item Specific Help▶▶▶▶
CHB CKE Drive Strength [Auto]	Press [Enter] to set.
CHA CS/ODT Drive Strength [Auto]	
CHB CS/ODT Drive Strength [Auto]	
CHA Add/CMD Drive Strength [Auto]	
CHB Add/CMD Drive Strength [Auto]	
MEMCLK Drive Strength [Auto]	
Data Drive Strength [Auto]	
DQS Drive Strength [Auto]	
DRAM Drivers Weak Mode [Auto]	

F1: Help      ↑↓ : Select Item      -/+ : Change Value      F5: Setup Defaults  
ESC: Exit      →← : Select Menu      Enter: Select Sub-menu      F10: Save and Exit

### CHA/CHB CKE Drive Strength [Auto]

Configuration options: [Auto] [1.00x] [1.25x] [1.50x] [2.00x]

### CHA/CHB C/S ODT Drive Strength [Auto]

Configuration options: [Auto] [1.00x] [1.25x] [1.50x] [2.00x]

### CHA/CHB Add/CMD Drive Strength [Auto]

Configuration options: [Auto] [1.00x] [1.25x] [1.50x] [2.00x]

### MEMCLK Drive Strength [Auto]

Configuration options: [Auto] [0.75x] [1.00x] [1.25x] [1.50x]

### Data Drive Strength [Auto]

Configuration options: [Auto] [0.75x] [1.00x] [1.25x] [1.50x]

### DQS Drive Strength [Auto]

Configuration options: [Auto] [0.75x] [1.00x] [1.25x] [1.50x]

### DRAM Drivers Weak Mode [Auto]

Configuration options: [Auto] [Normal] [Weak]

#### 4.4.4 SLI-Ready Memory [Disabled]

Allows you to select the SPD profile for SLI-Ready memory modules. The configuration options may vary depending on the type of module you installed.  
Configuration options: [Disabled] [Optimal] [High Performance] [High Frequency]



---

The following item becomes user-configurable when SLI-Ready Memory is set to Enabled.

---

#### 4.4.5 SLI-Ready Memory CPUOC [CPUOC 0%]

Configuration options: [CPUOC 0%] [CPUOC 1%]~[CPUOC 14%] [CPUOC MAX]

#### 4.4.6 AMD Live! [Disabled]

Enables or disables AMD Live!  
Configuration options: [Disabled] [Enabled]

#### 4.4.7 AMD Cool 'n' Quiet Function [Disabled]

Enables or disables the AMD Cool 'n' Quiet technology.  
Configuration options: [Auto] [Disabled]

#### 4.4.8 NVIDIA GPU Ex [Disabled]

Enables or disables with the optimized NVIDIA Ex graphics driver.  
Configuration options: [Auto] [Disabled]



## 4.5 Advanced menu

The Advanced menu items allow you to change the settings for system devices.



Take caution when changing the settings of the Advanced menu items. Incorrect field values can cause the system to malfunction.

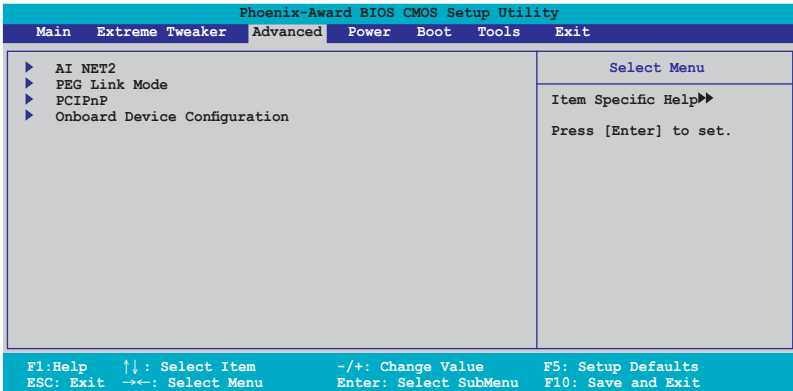

### 4.5.1 AI NET2

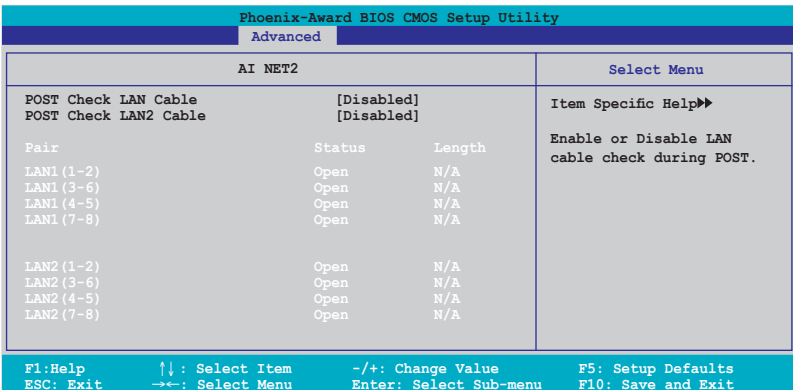

#### POST Check LAN Cable [Disabled] POST Check LAN2 Cable [Disabled]

Enables or disables checking of the LAN/LAN2 cable during the Power-On Self-Test (POST). Configuration options: [Disabled] [Enabled]

## 4.5.2 PEG Link Mode

Phoenix-Award BIOS CMOS Setup Utility	
Advanced	
PEG Link Mode	Select Menu
PEG Link Mode [Auto]	Item Specific Help▶▶ Enhance performance on PCIE serial graphic card.

### PEG Link Mode [Auto]

Allows you to enhance the performance of your PCI Express graphics card.  
Configuration options: [Auto] [Disabled] [Normal] [Fast] [Faster]



Setting to [Fast] or [Faster] may cause your system to be unstable. If this happens, revert to the default setting [Auto].

## 4.5.3 PCIPnP

Phoenix-Award BIOS CMOS Setup Utility	
Advanced	
PCIPnP	Select Menu
Plug & Play O/S [No]	Item Specific Help▶▶
Resources Controlled By [Auto] x IRQ Resources	Select Yes if you are using a Plug and Play capable operating system. Select No if you need the BIOS to configure non-boot devices.

### Plug & Play O/S [No]

When set to [No], the BIOS configures all the devices in the system. When set to [Yes] and if you install a Plug and Play operating system, the operating system configures the Plug and Play devices not required for boot. Configuration options: [No] [Yes]

### Resources Controlled By [Auto]

When set to [Auto], the BIOS automatically configures all the boot and Plug and Play compatible devices. Set to [Manual] if you want to assign the IRQ DMA and memory base address fields. Configuration options: [Auto] [Manual]



The item **IRQ Resources** becomes user-configurable when you set **Resources Controlled By** to [Manual].

## IRQ Resources

Phoenix-Award BIOS CMOS Setup Utility		
Advanced		
IRQ Resources		Select Menu
IRQ-5 assigned to	[PCI Device]	Item Specific Help▶▶▶
IRQ-7 assigned to	[PCI Device]	
IRQ-9 assigned to	[PCI Device]	Legacy ISA for devices compliant with the original PC AT bus specification, PCI/ISA PnP for devices compliant with the Plug and Play standard whether designed for PCI or ISA bus architecture.
IRQ-10 assigned to	[PCI Device]	
IRQ-11 assigned to	[PCI Device]	
IRQ-14 assigned to	[PCI Device]	
IRQ-15 assigned to	[PCI Device]	

### *IRQ-xx assigned to*

When set to [PCI Device], the specific IRQ is for use of PCI/PnP devices. When set to [Reserved], the IRQ is reserved for legacy ISA devices. Configuration options: [PCI Device] [Reserved]

## 4.5.4 Onboard Device Configuration

Phoenix-Award BIOS CMOS Setup Utility		
Advanced		
Onboard Device Configuration		Select Menu
▶ IDE Function Setup		Item Specific Help▶▶▶
▶ Serial-ATA Configuration		
▶ USB Configuration		
Onboard 1394 Controller	[Enabled]	
Onboard 1st nVidia LAN	[Enabled]	
Onboard 2nd nVidia LAN	[Enabled]	
Onboard nVidia Lan Boot ROM	[Disabled]	
Primary Display Adapter	[PCIEX16_1]	
HD Audio	[Auto]	
Front Panel Support Type	[AC97]	
Silicon SATAII Controller	[SATA Mode]	
Internal Connector LED	[Disabled]	
LCD Poster Back Light	[Disabled]	
LCD Poster Mode	[Current Time]	
x LCD Poster String		

F1: Help    ↑↓: Select Item    -/+ : Change Value    F5: Setup Defaults  
 ESC: Exit    →←: Select Menu    Enter: Select SubMenu    F10: Save and Exit

## IDE Function Setup

This sub-menu contains IDE function-related items. Select an item then press <Enter> to edit.

Phoenix-Award BIOS CMOS Setup Utility		
Advanced		
IDE Function Setup		Select Menu
OnChip IDE Channel0	[Enabled]	Item Specific Help▶▶▶
IDE DMA transfer access	[Enabled]	
IDE Prefetch Mode	[Enabled]	

### OnChip IDE Channel0 [Enabled]

Allows you to enable or disable the onchip IDE channel 0 controller .  
Configuration options: [Disabled] [Enabled]

### IDE DMA transfer access [Enabled]

Allows you to enable or disable the IDE DMA transfer access.  
Configuration options: [Disabled] [Enabled]

### IDE Prefetch Mode [Enabled]

Allows you to enable or disable the IDE PIO read prefetch mode.  
Configuration options: [Disabled] [Enabled]

## Serial-ATA Configuration

This sub-menu allows you to change Serial ATA settings. Select an item then press <Enter> to edit.

Phoenix-Award BIOS CMOS Setup Utility			
Advanced			
Serial-ATA Configuration			Select Menu
Serial-ATA Controller		[Enabled]	Item Specific Help▶▶▶
RAID Enabled		[Disabled]	
x SATA1	RAID	Disabled	
x SATA2	RAID	Disabled	
x SATA3	RAID	Disabled	
x SATA4	RAID	Disabled	
x SATA5	RAID	Disabled	
x SATA6	RAID	Disabled	

### Serial-ATA Controller [Enabled]

Allows you to enable or disable the onboard Serial ATA controller.  
Configuration options: [Disabled] [Enabled]

### RAID Enabled [Disabled]

Enables or disables the onboard RAID controller. When set to [Enabled], the succeeding items become user-configurable. Configuration options: [Disabled] [Enabled]

### SATA1/2/3/4/5/6 [Disabled]

Enables or disables the RAID function of the first to sixth SATA master drive.  
Configuration options: [Disabled] [Enabled]

## USB Configuration

The items in this menu allows you to change the USB-related features. Select an item then press <Enter> to display the configuration options.

Phoenix-Award BIOS CMOS Setup Utility	
Advanced	
USB Configuration	Select Menu
USB Controller [Enabled]	Item Specific Help▶▶▶  Enable or disable the USB 1.1 and 2.0 Controller.
USB2.0 Controller [Enabled]	
USB Legacy support [Enabled]	

### USB Controller [Enabled]

Allows you to enable or disable the onchip USB controller.  
Configuration options: [Disabled] [Enabled]

### USB 2.0 Controller [Enabled]

Allows you to enable or disable the USB 2.0 controller.  
Configuration options: [Disabled] [Enabled]

### USB Legacy Support [Enabled]

Allows you to enable or disable support for USB devices on legacy operating systems (OS). Configuration options: [Disabled] [Enabled]

## Onboard 1394 [Enabled]

Allows you to disable or enable the onboard 1394 device support.  
Configuration options: [Disabled] [Enabled]

## Onboard 1st/2nd Nvidia LAN [Enabled]

Enables or disables the onboard NVIDIA® LAN controller.  
Configuration options: [Disabled] [Enabled]

## OnBoard nVidia LAN Boot ROM [Disabled]

Allows you to enable or disable the onboard LAN boot ROM.  
Configuration options: [Enabled] [Disabled]

## Primary Display Adapter [PCIEX16\_1]

Allows you to select the graphics controller to use as the primary boot device.  
Configuration options: [PCI Slot] [PCIEX16\_2] [PCIEX16\_1]

### **HD Audio [Auto]**

Allows you to disable or set the High-Definition audio function.

Configuration options: [Auto] [Disabled]

### **Front Panel Support Type [AC97]**

Allows you to set the front panel audio connector (AAFP) mode to legacy AC'97 or high-definition audio depending on the audio standard that the front panel audio module supports. Configuration options: [AC97] [HD Audio]

### **Silicon SATAII Controller [SATA Mode]**

Allows you to disable or set the function of the extended SATA II controller.

Configuration options: [Disabled] [SATA Mode] [RAID Mode]

### **Internal Connector LED [by Switch]**

Allows you to control the internal connector LED by Switch or Always on.

Configuration options: [By Switch] [Always On]

### **LCD Poster Back Light [Disabled]**

Allows you to enable or disable the LCD poster backlight.

Configuration options: [Disabled] [Enabled]

### **LCD Poster Mode [Current Time]**

Allows you to select the LCD poster mode.

Configuration options: [Current Time] [User String]



---

The following item becomes configurable when the "LCD Poster Mode" item is set to [User String].

---

### **LCD Poster String**

Allows you to enter a string on the LCD poster.

## 4.6 Power menu

The Power menu items allow you to change the settings for the Advanced Configuration and Power Interface (ACPI) and the Advanced Power Management (APM). Select an item then press <Enter> to display the configuration options.

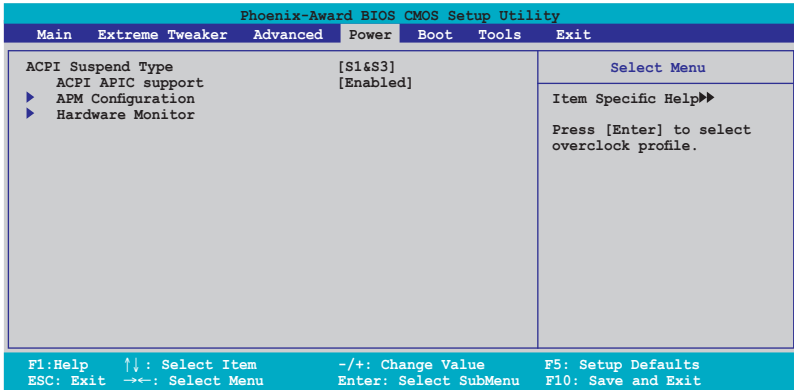

### 4.6.1 ACPI Suspend Type [S1&S3]

Allows you to select the Advanced Configuration and Power Interface (ACPI) state to be used for system suspend. Configuration options: [S1 (POS)] [S3(STR)] [S1&S3]

### 4.6.2 ACPI APIC Support [Enabled]

Allows you to enable or disable the Advanced Configuration and Power Interface (ACPI) support in the Application-Specific Integrated Circuit (ASIC). When set to Enabled, the ACPI APIC table pointer is included in the RSDT pointer list. Configuration options: [Disabled] [Enabled]

## 4.6.3 APM Configuration

Phoenix-Award BIOS CMOS Setup Utility			
Power			
APM Configuration		Select Menu	
Restore on AC Power Loss	[Power-Off]	Item Specific Help▶▶  Press [Enter] to select whether or not to restart the system after AC power loss.	
PWR Button < 4 secs	[Instant-Off]		
Power Up On PCI/PCIE Devices	[Disabled]		
USB Resume from S5	[Disabled]		
Power On by RTC Alarm	[Disabled]		
x Date (of Month) Alarm	[ 0]		
x Alarm Time (hh:mm)	0 : 0 : 0		
Power Up By PS/2 Mouse	[Disabled]		
Power Up By PS/2 Keyboard	[Disabled]		
F1: Help	↑↓ : Select Item		
ESC: Exit	→← : Select Menu	Enter: Select SubMenu	F10: Save and Exit

### Restore on AC Power Loss [Power-Off]

Allows you to enable or disable the Restore on AC Power Loss function.

Configuration options: [Power-Off] [Power-On]

### PWR Button < 4 secs [Instant-Off]

Allows you to set the event after the power button is pressed for more than 4 seconds. Configuration options: [Suspend] [Instant-Off]

### Power Up On PCI/PCIE Devices [Disabled]

Allows you to enable or disable the PME to wake up from S5 by PCI devices & NV Onboard LAN. Configuration options: [Disabled] [Enabled]

### USB Resume from S5 [Disabled]

Allows you to enable or disable the support of USB keyboard or mouse resumption from S5. Configuration options: [Disabled] [Enabled]

### Power On By RTC Alarm [Disabled]

Allows you to enable or disable RTC to generate a wake event. When this item is set to Enabled, the items Date of Month Alarm and Time (hh:mm:ss) Alarm items become user-configurable with set values.

Configuration options: [Disabled] [Enabled]

### Date (of Month) Alarm [XX]

To set the date of alarm, highlight this item and press <Enter> to display the Date of Month Alarm pop-up menu. Key-in a value within the specified range then press <Enter>. Value '0' means everyday. Configuration options: [Min=0] [Max=31]



## Alarm Time (hh:mm) [ X: X: X]

To set the time of alarm:

1. Highlight this item and press <Enter> to display a pop-up menu for the hour field.
2. Key-in a value (Min=0, Max=23), then press <Enter>.
3. Press <TAB> to move to the minutes field then press <Enter>.
4. Key-in a minute value (Min=0, Max=59), then press <Enter>.

## Power Up By PS/2 Mouse [Disabled]

When set to [Enabled], this parameter allows you to use the PS/2 mouse to turn on the system. This feature requires an ATX power supply that provides at least 1A on the +5VSB lead. Configuration options: [Disabled] [Enabled]

## Power Up By PS/2 Keyboard [Disabled]

Allows you to disable the Power On by PS/2 keyboard function or set specific keys on the PS/2 keyboard to turn on the system. This feature requires an ATX power supply that provides at least 1A on the +5VSB lead. Configuration options: [Disabled] [Space Bar] [Ctrl-ESC] [Power Key]

## 4.6.4 Hardware Monitor

The items in this sub-menu displays the hardware monitor values automatically detected by the BIOS. It also allows you to change CPU Q-Fan feature-related parameters. Select an item then press <Enter> to display the configuration options.

The screenshot shows the Phoenix-Award BIOS CMOS Setup Utility interface. At the top, it says "Phoenix-Award BIOS CMOS Setup Utility" and "Power". The main menu is titled "Hardware Monitor" and "Select Menu". The "Hardware Monitor" section lists several items: Voltage Monitor, Temperature Monitor, Fan Speed Monitor, Fan Speed Control, CPU Fan Connector Type (set to [4-Pin Fan]), Fan Boost Function (set to [Disabled]), and CPU Fan Speed warning (set to [800 RPM]). The "Select Menu" section shows "Item Specific Help" and "Press [Enter] to go to the sub-menu." At the bottom, there are navigation instructions: F1: Help, ↑: Select Item, -/+ : Change Value, F5: Setup Defaults, ESC: Exit, →: Select Menu, Enter: Select SubMenu, and F10: Save and Exit.

Hardware Monitor		Select Menu	
▶ Voltage Monitor		Item Specific Help▶▶	
▶ Temperature Monitor		Press [Enter] to go to	
▶ Fan Speed Monitor		the sub-menu.	
▶ Fan Speed Control			
CPU Fan Connector Type	[4-Pin Fan]		
Fan Boost Function	[Disabled]		
CPU Fan Speed warning	[800 RPM]		

F1: Help    ↑ : Select Item    -/+ : Change Value    F5: Setup Defaults  
ESC: Exit    → : Select Menu    Enter: Select SubMenu    F10: Save and Exit

## Voltage Monitor

Phoenix-Award BIOS CMOS Setup Utility		
Power		
Voltage Monitor		Select Menu
+12V Voltage	[ 12.03V]	Item Specific Help▶▶
+5V Voltage	[ 4.99V]	
+3.3V Voltage	[ 3.26V]	Press [Enter] to set.
DDR2 Voltage	[ 1.87V]	
DDR2 Termination Voltage	[ 0.92V]	
CPU Core Voltage	[ 1.44V]	
CPU-NB HT Voltage	[ 1.26V]	
NB 2.5V Voltage	[ 2.75V]	
NB Core Voltage	[ 1.21V]	
SB Core Voltage	[ 1.58V]	
SB PLL Voltage	[ 1.58V]	
Sil3132 ESATA Voltage	[ 1.82V]	
Marvell LAN PHY Voltage	[ 1.77V]	
F1: Help	↑↓: Select Item	-/+ : Change Value
ESC: Exit	→←: Select Menu	Enter: Select SubMenu
		F5: Setup Defaults
		F10: Save and Exit

+12V / +5V / +3.3V Voltage

DDR2 / DDR2 Termination / CPU Core/ CPU-NB HT Voltage

NB 2.5V / NB Core / SB Core / SB PLL Voltage / Sil3132 ESATA / Marvell

LAN PHY Voltage

The onboard hardware monitor automatically detects the voltage output through the onboard voltage regulators.

## Temperature Monitor

Phoenix-Award BIOS CMOS Setup Utility		
Power		
Temperature Monitor		Select Menu
CPU Temperature	57°C	Item Specific Help▶▶
M/B Temperature	37°C	
OPT1 Temperature	0°C	
OPT2 Temperature	0°C	
OPT3 Temperature	0°C	

CPU, M/B, OPT1/2/3 Temperature

The onboard hardware monitor automatically detects and displays the motherboard, CPU, and OPT1/2/3 temperatures. These items are not user-configurable.

## Fan Speed Monitor

Phoenix-Award BIOS CMOS Setup Utility		
Power		
Fan Speed Monitor		Select Menu
CPU FAN Speed	2960 RPM	Item Specific Help▶▶
CHA Rear FAN Speed	0 RPM	
CHA Front FAN Speed	0 RPM	
OPT1 FAN Speed	0 RPM	
OPT2 FAN Speed	0 RPM	
OPT3 FAN Speed	0 RPM	
OPT4 FAN Speed	0 RPM	
OPT5 FAN Speed	0 RPM	

### CPU FAN / CHA Rear FAN Speed

### OPT1/2/3/4/5 FAN Speed

The onboard hardware monitor automatically detects and displays the CPU, Chassis, and OPT1/2/3/4/5 fan speed in rotations per minute (RPM). If any of the fans is not connected to the motherboard, the field shows 0. These items are not user-configurable.

## Fan Speed Control

Phoenix-Award BIOS CMOS Setup Utility		
Power		
Voltage Monitor		Select Menu
CPU Fan Control	[Duty Cycle Mode]	Item Specific Help▶▶
CPU Fan Duty Cycle	[100%]	
CHA Rear Fan Control	[Duty Cycle Mode]	Press [Enter] to enable or disable.
CHA Rear Fan Duty Cycle	[100%]	
x CHA Rear Fan Q-Fan Sense	CPU Temperature	
CHA Front Fan Control	[Duty Cycle Mode]	
CHA Front Fan Duty Cycle	[100%]	
x CHA Rear Fan Q-Fan Sense	CPU Temperature	
OPT Fan1 Control	[Duty Cycle Mode]	
OPT Fan1 Duty Cycle	[100%]	
x OPT Fan1 Target Temperature	40°C/104°F	
OPT Fan2 Control	[Duty Cycle Mode]	
OPT Fan2 Duty Cycle	[100%]	
x OPT Fan2 Target Temperature	40°C/104°F	
OPT Fan3 Control	[Duty Cycle Mode]	
OPT Fan3 Duty Cycle	[100%]	
x OPT Fan3 Target Temperature	40°C/104°F	
OPT Fan4 Duty Cycle	[100%]	
OPT Fan5 Duty Cycle	[100%]	

### CPU / CHA Rear / CHA Front / OPT Fan1, 2, 3, Fan Control

### [Duty Cycle Mode]

Allows you to select the fan control mode.

Configuration options: [Duty Cycle Mode] [Q-FAN Mode]

### CPU / CHA Rear / CHA Front / OPT Fan1, 2, 3, 4, 5 Fan Duty Cycle [100%]

Allows you to set the fan duty cycle. When the Fan Control item is set to Q-FAN Mode, this item is not user-configurable.

Configuration options: [60%] [70%] [80%] [90%] [100%]

### CHA Rear/Front Fan Q-Fan Sense [CPU Temperature]

Allows the Q-Fan to sense CPU/MB temperature and to adjust the fan speed. When the previous items are set to Q-FAN Mode, these items become user-configurable. Configuration options: [CPU Temperature] [MB Temperature]

### OPT Fan1/2/3 Target Temperature [40°C/104°F]

Allows the Q-Fan to sense the temperature of fans connected to OPT Fan1/2/3 and to adjust the fan speed. When the OPT Fan1/2/3 Control items are set to Q-FAN Mode, these items become user-configurable.

Configuration options: [10°C/50°F] [15°C/59°F] [20°C/68°F] [25°C/77°F] [30°C/86°F] [35°C/95°F] [40°C/104°F] [45°C/113°F] [50°C/122°F] [55°C/131°F] [60°C/140°F] [65°C/149°F] [70°C/158°F] [75°C/167°F] [80°C/176°F] [85°C/185°F]



The thermo sensor cables need to be connected to the optional fans first for this function.

---

### **CPU Fan Connector Type [4-Pin Fan]**

Allows you to select the type of CPU fan cable connected to the CPU fan. Configuration options: [4-Pin Fan] [3-Pin Fan]

### **Fan Boost Function [Disabled]**

Allows you to enable or disable the fan boost function. Configuration options: [Disabled] [Enabled]



When the Fan Boost Function is enabled, the 3-pin CPU fan will run at full speed.

---

### **CPU Fan Speed warning [800 RPM]**

Allows you to set the CPU fan warning speed function, which gives off a warning when the CPU fan speed is too low. If you set this item to [Disabled], the system will not warn you even if no fan is installed or if the fan is not functioning properly. Configuration options: [Disabled] [800 RPM] [1200 RPM] [1600 RPM]

## 4.7 Boot menu

The Boot menu items allow you to change the system boot options. Select an item then press <Enter> to display the sub-menu.

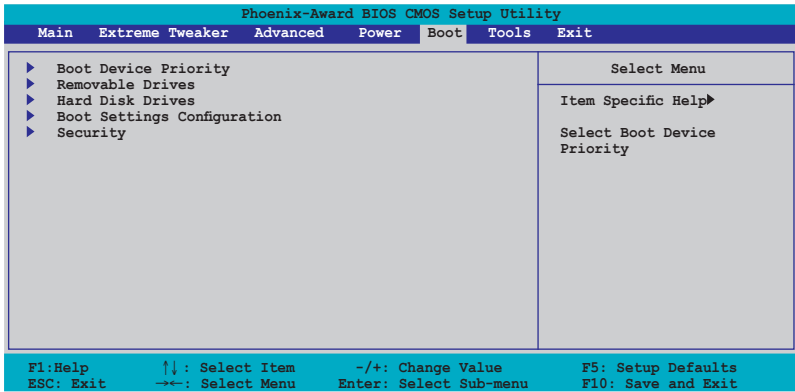

### 4.7.1 Boot Device Priority

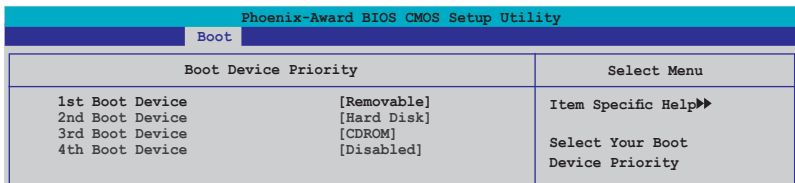

#### 1st ~ 4th Boot Device [Removable]

These items specify the boot device priority sequence from the available devices. The number of device items that appears on the screen depends on the number of devices installed in the system.

Configuration options: [Removable] [Hard Disk] [CDROM] [Disabled]

## 4.7.2 Removable Drives

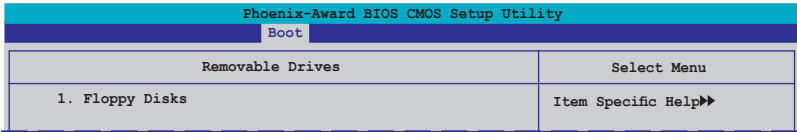

The screenshot shows the Phoenix-Award BIOS CMOS Setup Utility interface. At the top, the title bar reads "Phoenix-Award BIOS CMOS Setup Utility". Below it, a dark blue bar contains the word "Boot" in white. The main area is a light gray table with two columns. The left column is titled "Removable Drives" and contains the entry "1. Floppy Disks". The right column is titled "Select Menu" and contains the entry "Item Specific Help▶".

Phoenix-Award BIOS CMOS Setup Utility	
Boot	
Removable Drives	Select Menu
1. Floppy Disks	Item Specific Help▶

### 1. Floppy Disks

Allows you to assign a removable drive attached to the system.

## 4.7.3 Hard Disk Drives

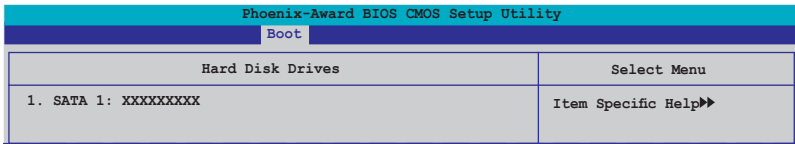

The screenshot shows the Phoenix-Award BIOS CMOS Setup Utility interface. At the top, the title bar reads "Phoenix-Award BIOS CMOS Setup Utility". Below it, a dark blue bar contains the word "Boot" in white. The main area is a light gray table with two columns. The left column is titled "Hard Disk Drives" and contains the entry "1. SATA 1: XXXXXXXXX". The right column is titled "Select Menu" and contains the entry "Item Specific Help▶".

Phoenix-Award BIOS CMOS Setup Utility	
Boot	
Hard Disk Drives	Select Menu
1. SATA 1: XXXXXXXXX	Item Specific Help▶

### 1. SATA 1: XXXXXXXXX

Allows you to assign hard disk drives attached to the system.

## 4.7.4 Boot Settings Configuration

Phoenix-Award BIOS CMOS Setup Utility		
Boot		
Boot Settings Configuration		Select Menu
Case Open Warning	[Enabled]	Item Specific Help▶▶  Press [Enter] to enable or disable.
Quick Boot	[Enabled]	
Boot Up Floppy Seek	[Disabled]	
Bootup Num-Lock	[On]	
Typematic Rate Setting	[Disabled]	
x Typematic Rate (Chars/Sec)	6	
x Typematic Delay (Msec)	250	
OS Select For DRAM > 64MB	[Non-OS2]	
Full Screen LOGO	[Enabled]	
Halt On	[All Errors]	

F1: Help      ↑↓: Select Item      -/+ : Change Value      F5: Setup Defaults  
ESC: Exit      →←: Select Menu      Enter: Select Sub-menu      F10: Save and Exit

### Case Open Warning [Enabled]

Enables or disables the chassis open status feature. Setting to Enabled, clears the chassis open status. Refer to section “2.8.2 Internal connectors” for setting details. Configuration options: [Disabled] [Enabled]

### Quick Boot [Enabled]

Allows you to enable or disable the system quick boot feature. When Enabled, the system skips certain tests while booting. Configuration options: [Disabled] [Enabled]

### Boot Up Floppy Seek [Disabled]

Enables or disables the chassis open status feature. Setting to Enabled, clears the chassis open status. Configuration options: [Disabled] [Enabled]

### Bootup Num-Lock [On]

Allows you to select the power-on state for the NumLock. Configuration options: [Off] [On]

### Typematic Rate Setting [Disabled]

Allows you to set the keystroke rate. Enable this item to configure the Typematic Rate (Chars/Sec) and the Typematic Delay (Msec). Configuration options: [Disabled] [Enabled]



The items **Typematic Rate (Chars/Sec)** and **Typematic Delay (Msec)** become user-configurable only when the item **Typematic Rate Setting** is enabled.

### Typematic Rate (Chars/Sec) [6]

Allows you to select the rate at which a character repeats when you hold a key.  
Configuration options: [6] [8] [10] [12] [15] [20] [24] [30]

### Typematic Delay (Msec) [250]

Allows you to set the delay before keystrokes begin to repeat.  
Configuration options: [250] [500] [750] [1000]

### OS Select for DRAM > 64MB [Non-OS2]

Set this item to OS2 only when you are running on an OS/2 operating system with an installed RAM of greater than 64 MB. Configuration options: [Non-OS2] [OS2]

### Full Screen LOGO [Enabled]

Allows you to enable or disable the full screen logo display feature.  
Configuration options: [Disabled] [Enabled]



Make sure that the above item is set to [Enabled] if you want to use the ASUS MyLogo3™ feature.

### Halt On [All Errors]

Allows you to set the error report type.  
Configuration options: [All Errors] [No Errors] [All, But Keyboard] [All, But Diskette] [All, But Disk/Key]

## 4.7.5 Security

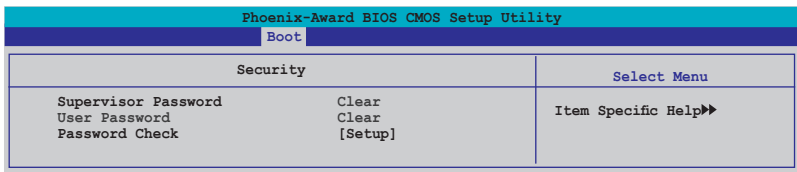

### Supervisor Password

### User Password

These fields allow you to set passwords:

To set a password:

1. Select an item then press <Enter>.
2. Type in a password using a combination of a maximum of eight (8) alpha-numeric characters, then press <Enter>.



3. When prompted, confirm the password by typing the exact characters again, then press <Enter>. The password field setting is changed to Set.

To clear the password:

1. Select the password field and press <Enter> twice. The following message appears:



2. Press any key to continue. The password field setting is changed to Clear.

### **A note about passwords**

The Supervisor password is required to enter the BIOS Setup program preventing unauthorized access. The User password is required to boot the system preventing unauthorized use.

Forgot your password?

If you forget your password, you can clear it by erasing the CMOS Real Time Clock (RTC) RAM. The RAM data containing the password information is powered by the onboard button cell battery. If you need to erase the CMOS RAM, refer to section “2.6 Jumper” for instructions.

### **Password Check**

This field requires you to enter the password before entering the BIOS setup or the system. Select [Setup] to require the password before entering the BIOS Setup. Select [System] to require the password before entering the system.  
Configuration options: [Setup] [System]

## 4.8 Tools menu

The Tools menu items allow you to configure options for special functions. Select an item then press <Enter> to display the sub-menu.

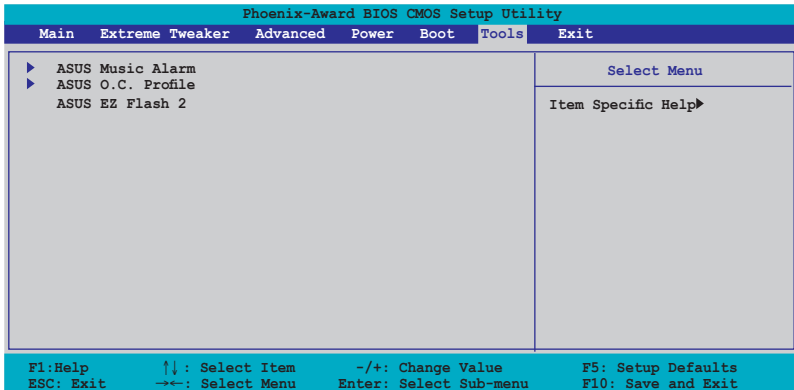

### 4.8.1 ASUS Music Alarm

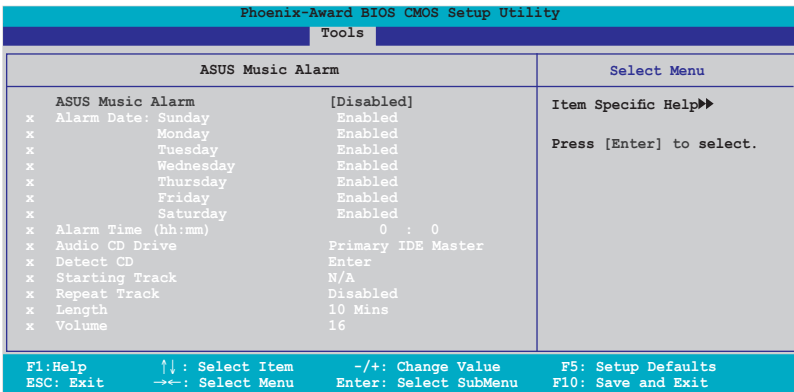

#### ASUS Music Alarm [Disabled]

Allows you to enable or disable the ASUS Music Alarm function.

Configuration options: [Disabled] [Enabled]



The succeeding items become user-configurable when you enable the ASUS Music Alarm.

#### Alarm Date: Sunday/Monday/Tuesday/Wednesday/Thursday/Friday/Saturday [Enabled]

Allows you to enable or disable the alarm for a particular day.

Configuration options: [Disabled] [Enabled]

## Alarm Time (hh:mm) 0 : 0

Allows you to set the alarm time. Press <Tab> to select the field, then use <+> or <-> to change the value. Configuration options: [Disabled] [Enabled]

## Audio CD Drive [Primary IDE Master]

Allows you to select the connection configuration of the optical storage device from which the alarm music will play from.

Configuration options: [Primary IDE Master] [Primary IDE Slave]

## Detect CD [Enter]

Press <Enter> to search the CD track number.

## Starting Track

Allows you to choose the starting track from the CD from which you would like the alarm music to play.

## Repeat Track [Disabled]

Allows you to enable or disable the repeat track function.

Configuration options: [Disabled] [Single] [All]

## Length [10 Mins]

Allows you to set the length of the music alarm.

Configuration options: [10 Mins] [20 Mins] [30 Mins] [1 Hour]

## Volume [16]

Allows you to set the volume level of the music alarm.

Configuration options: [01] ~ [32]

## 4.8.2 ASUS O.C. Profile

This item allows you to store or load multiple BIOS settings.

Phoenix-Award BIOS CMOS Setup Utility	
Tools	
ASUS BIOS Profile	Select Menu
▶ Load BIOS Profile ▶ Save BIOS Profile	Item Specific Help▶▶  Press [Enter] to select.

## Load BIOS Profile

Phoenix-Award BIOS CMOS Setup Utility	
Tools	
Load BIOS Profile	Select Menu
Load from Profile 1 Load from Profile 2 Load from File	Item Specific Help▶▶  Load BIOS Profile from Profile 1.

## Load from Profile 1/2

Allows you to load the previous BIOS settings saved in the BIOS Flash. Press <Enter> to load the file.

## Load from File

Allows you to load the previous BIOS file saved in the hard disk/floppy disk/USB flash disk with the FAT32/16/12 format. Follow the instructions below to load the BIOS file.

1. Insert the storage devices that contains the “xxx.CMO” file.
2. Turn on the system.
3. Enter BIOS setup program. Go to the “Tools” menu to select “Load from File.” Press <Enter> then the setup screen will appear.
4. Press <Tab> to switch between drives before the correct “xxx.CMO” file is found. Then press <Enter> to load the file.
5. A pop-up message will inform you when the loading process finishes.



- Suggest only to update the BIOS file coming from the same memory/CPU configuration and BIOS version.
- Only the “xxx.CMO” file can be loaded.

## Save BIOS Profile

Phoenix-Award BIOS CMOS Setup Utility	
Tools	
Save BIOS Profile	Select Menu
Save to Profile 1 Save to Profile 2 Save to File	Item Specific Help▶▶  Save current BIOS Profile to Profile 1.

## Save to Profile 1/2

Allows you to save the current BIOS file to the BIOS Flash. Press <Enter> to save the file.

## Save to File

Allows you to save the current BIOS file to the hard disk/floppy disk/USB flash disk with FAT32/16/12 format. Follow the instructions below to save the BIOS file.

1. Insert the storage devices with enough space.
2. Turn on the system.
3. Enter the BIOS setup program. Go to the “Tools” menu to select “Save to File.” Press <Enter> then the setup screen will appear.
4. Press <Tab> to switch between the drives. Press hot-key <S> to save the file.

5. Key in the file name. Then press <Enter>.
6. A pop-up message will inform you when the saving process finishes.

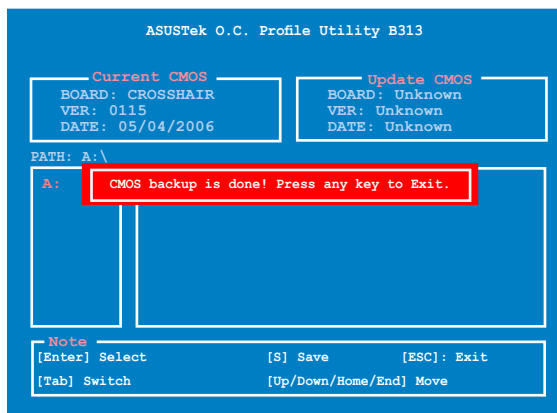

The BIOS file will be saved as "xxx.CMO".

### 4.8.3 ASUS EZ Flash 2

Allows you to run ASUS EZ Flash 2. When you press <Enter>, a confirmation message appears. Use the left/right arrow key to select between [Yes] or [No], then press <Enter> to confirm your choice.

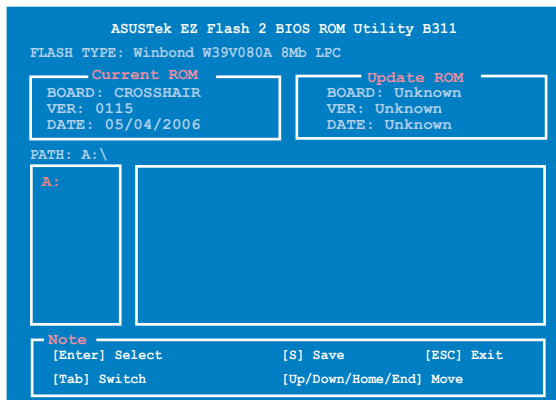

## 4.9 Exit menu

The Exit menu items allow you to load the optimal or failsafe default values for the BIOS items, and save or discard your changes to the BIOS items.

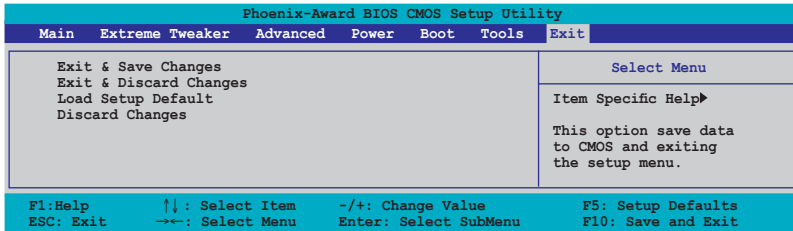

Pressing <Esc> does not immediately exit this menu. Select one of the options from this menu or <F10> from the legend bar to exit.

### Exit & Save Changes

Once you are finished making your selections, choose this option from the Exit menu to ensure the values you selected are saved to the CMOS RAM. An onboard backup battery sustains the CMOS RAM so it stays on even when the PC is turned off. When you select this option, a confirmation window appears. Select YES to save changes and exit.



If you attempt to exit the Setup program without saving your changes, the program prompts you with a message asking if you want to save your changes before exiting. Press <Enter> to save the changes while exiting.

### Exit & Discard Changes

Select this option only if you do not want to save the changes that you made to the Setup program. If you made changes to fields other than System Date, System Time, and Password, the BIOS asks for a confirmation before exiting.

### Load Setup Default

This option allows you to load the default values for each of the parameters on the Setup menus. When you select this option or if you press <F5>, a confirmation window appears. Select YES to load default values. Select Exit & Save Changes or make other changes before saving the values to the non-volatile RAM.

### Discard Changes

This option allows you to discard the selections you made and restore the previously saved values. After selecting this option, a confirmation appears. Select YES to discard any changes and load the previously saved values.

This chapter describes the contents of the support DVD that comes with the motherboard package.

# 5 Software support

5.1	Installing an operating system .....	5-1
5.2	Support DVD information .....	5-1
5.3	Software information .....	5-9
5.4	RAID configurations .....	5-24
5.5	Creating a RAID driver disk.....	5-40



## 5.1 Installing an operating system

This motherboard supports Windows® 2000/2003 Server/XP/64-bit XP operating systems (OS). Always install the latest OS version and corresponding updates to maximize the features of your hardware.



- Motherboard settings and hardware options vary. Use the setup procedures presented in this chapter for reference only. Refer to your OS documentation for detailed information.
- Make sure that you install Windows® 2000 Service Pack 4 or the Windows® XP Service Pack2 or later versions before installing the drivers for better compatibility and system stability.

## 5.2 Support DVD information

The support DVD that came with the motherboard package contains the drivers, software applications, and utilities that you can install to avail all motherboard features.



The contents of the support DVD are subject to change at any time without notice. Visit the ASUS website([www.asus.com](http://www.asus.com)) for updates.

### 5.2.1 Running the support DVD

Place the support DVD to the optical drive. The DVD automatically displays the Drivers menu if Autorun is enabled in your computer.



Click an icon to display support DVD/motherboard information

Click an item to install



If Autorun is NOT enabled in your computer, browse the contents of the support DVD to locate the file ASSETUP.EXE from the BIN folder. Double-click the ASSETUP.EXE to run the DVD.

## 5.2.2 Drivers menu

The drivers menu shows the available device drivers if the system detects installed devices. Install the necessary drivers to activate the devices.

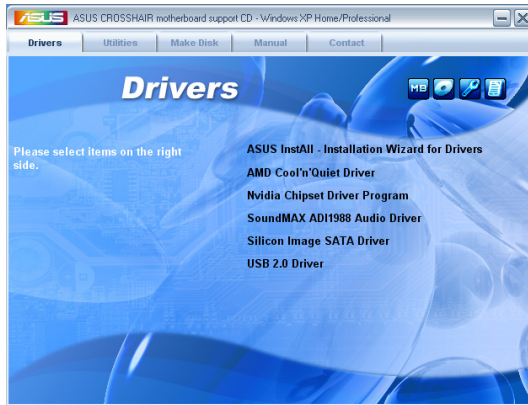

### **ASUS InstAll-Drivers Installation Wizard**

Installs all of the drivers through the Installation Wizard.

### **AMD Cool 'n' Quiet Driver**

Installs the AMD Cool 'n' Quiet™ technology driver.

### **Nvidia Chipset Driver Program**

Installs the NVIDIA® Chipset drivers for the NVIDIA® nForce™ 590 SLI chipset.

### **SoundMAX ADI1988 Audio Driver**

Installs the SoundMAX® ADI1988 audio driver and application.

### **Silicon Image SATA Driver**

Installs the Silicon Image® Serial ATA RAID driver.

### **USB 2.0 Driver**

Installs the USB 2.0 driver.

## 5.2.3 Utilities menu

The Utilities menu shows the applications and other software that the motherboard supports.

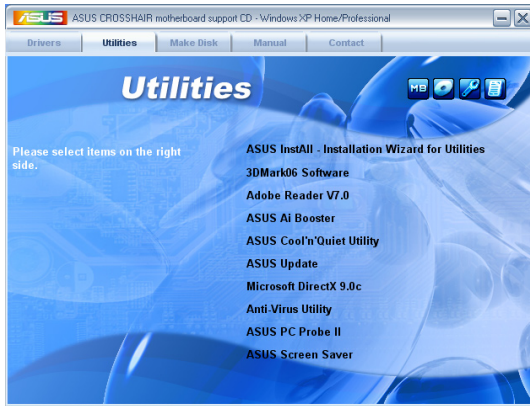

### **ASUS InstAll-Drivers Installation Wizard**

Installs all of the drivers through the Installation Wizard.

### **3DMark06 Software**

Installs the 3DMark06 software.

### **Adobe Reader V7.0**

Installs the Adobe® Acrobat® Reader that allows you to open, view, and print documents in Portable Document Format (PDF).

### **ASUS Ai Booster**

The ASUS AI Booster application allows you to overclock the CPU speed in Windows® environment.

### **ASUS Cool 'n' Quiet Utility**

Installs the AMD Cool 'n' Quiet™ software.

### **ASUS Update**

The ASUS Update utility allows you to update the motherboard BIOS in Windows® environment. This utility requires an Internet connection either through a network or an Internet Service Provider (ISP).

## **Microsoft DirectX 9.0c**

Installs the Microsoft® DirectX 9.0c driver. The Microsoft DirectX® 9.0c is a multimedia technology that enhances computer graphics and sound. DirectX® improves the multimedia features of your computer so you can enjoy watching TV and movies, capturing videos, or playing games in your computer. Visit the Microsoft website ([www.microsoft.com](http://www.microsoft.com)) for updates.

## **Anti-Virus Utility**

The anti-virus application scans, identifies, and removes computer viruses. View the online help for detailed information.

## **ASUS PC Probe II**

This smart utility monitors the fan speed, CPU temperature, and system voltages, and alerts you of any detected problems. This utility helps you keep your computer in healthy operating condition.

## **ASUS Screen Saver**

Bring life to your idle screen by installing the ASUS screen saver.

## 5.2.4 Make Disk menu

The Make Disk menu contains items to create the RAID driver disk.

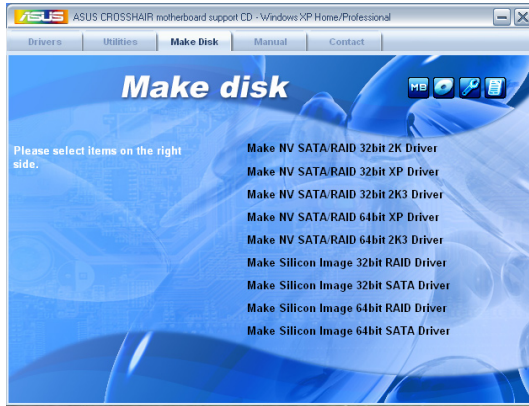

### **Make NV SATA/RAID 32bit 2K Driver**

### **Make NV SATA/RAID 32bit XP Driver**

### **Make NV SATA/RAID 32bit 2K3 Driver**

Allows you to create an NVIDIA® Serial ATA RAID driver disk for a 32-bit 2K/XP/2K3 system.

### **Make NV SATA/RAID 64bit XP Driver**

### **Make NV SATA/RAID 64bit 2K3 Drive**

Allows you to create an NVIDIA® Serial ATA RAID driver disk for a 64-bit XP/2K3 system.

### **Make Silicon Image 32bit RAID Driver**

### **Make Silicon Image 32bit SATA Driver**

Allows you to create a Silicon Image® Serial ATA/RAID driver disk for a 32-bit system.

### **Make Silicon Image 64bit RAID Driver**

### **Make Silicon Image 64bit SATA Driver**

Allows you to create a Silicon Image® Serial ATA/RAID driver disk for a 64-bit system.

## 5.2.5 Manuals menu

The Manuals menu contains a list of supplementary user manuals. Click an item to open the folder of the user manual.



Most user manual files are in Portable Document Format (PDF). Install the Adobe® Acrobat® Reader from the Utilities menu before opening a user manual file.

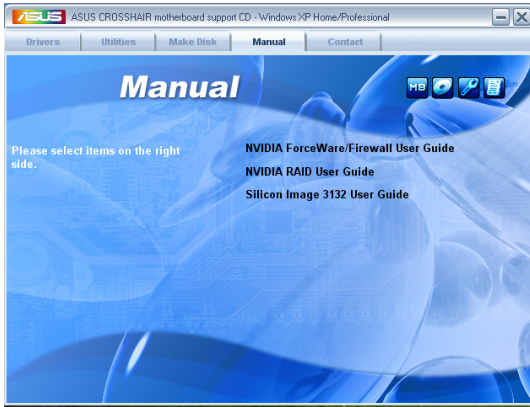

## 5.2.6 ASUS Contact information

Click the Contact tab to display the ASUS contact information. You can also find this information on the inside front cover of this user guide.



## 5.2.7 Other information

The icons on the top right corner of the screen give additional information on the motherboard and the contents of the support DVD. Click an icon to display the specified information.

### Motherboard Info

Displays the general specifications of the motherboard.

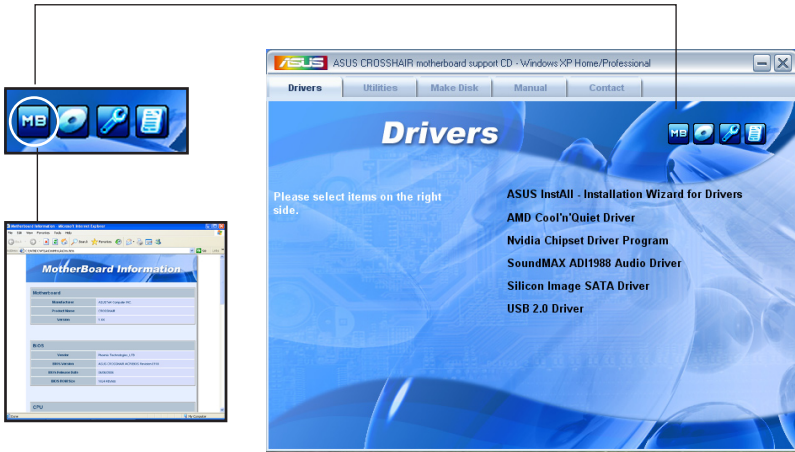

### Browse this DVD

Displays the support DVD contents in graphical format.

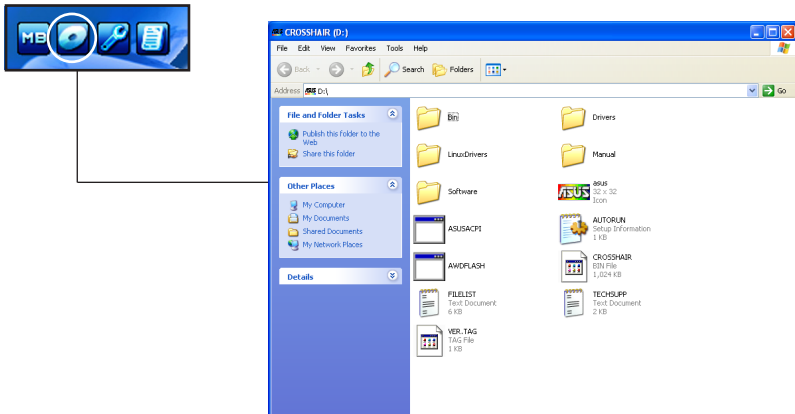

## Technical support Form

Displays the ASUS Technical Support Request Form that you have to fill out when requesting technical support.



ASUSTEK TECHNICAL SUPPORT REQUEST FORM

ORIGINATOR DESCRIPTION

-----

COMPANY NAME :	CONTACT NAME :
PHONE (AREA) :	FAX # (AREA) :
EMAIL ADDRESS :	

-----

HARDWARE DESCRIPTION

-----

MOTHERBOARD :	REVISION # :	BIOS:#A01A0-
CPU BRAND :	SPEED(MHZ) :	
DRAM BRAND :	SPEED(MS) :	SIZE(MB) :
CACHE BRAND :	SPEED(MS) :	SIZE(KB) :
HARD DISK :	MODEL NAME :	SIZE(MB) :
CDROM BRAND :	MODEL NAME :	SIZE(MB) :
BACKUP BRAND :	MODEL NAME :	SIZE(MB) :
OTHER STORAGE :	MODEL NAME :	SIZE(MB) :

-----

ADD-IN CARD DESCRIPTION (MODEL NAME/VENDOR)

-----

(E)ISA SLOT 1 :	
(E)ISA SLOT 2 :	
(E)ISA SLOT 3 :	
(E)ISA SLOT 4 :	
PCI-E SLOT 1 :	
PCI-E SLOT 2 :	
PCI-E SLOT 3 :	
PCI-E SLOT 4 :	
PCI-E SLOT 5 :	

## Filelist

Displays the contents of the support DVD and a brief description of each in text format.



File List for the included support software for CROSSHAIR motherboard

File Name	Description
-----	
--Drivers	
-AMD	
-Cool'n'quiet	-ASUS cool&quiet driver v1.0.1.7 for windows 2000.
	-ASUS cool&quiet driver v1.3.1.0 for windows xp/2003.
	-ASUS cool&quiet driver v1.3.1.0 for windows 64bit xp/2003.
-Audio	
-32bit	-soundMAX audio driver v5.10.01.4530 for windows 2000/XP(BTS driver)/2
-64bit	-soundMAX audio driver v5.10.02.4530 for windows 64bit XP/2003.
-chipset	
-drivers	-NVIDIA MCP55 Package Driver v9.16 for windows 2000/XP/2003 & windows
-SATA	
-s113132	
-32bit-RAID	-s111con Image 3132 Raid 5 driver v1.3.0.9 for windows 2000/XP/2003.0w
-32bit-SATA	-s111con Image 3132 Serial ATA driver V2.0.0.9 for windows 2000/XP/200
-32bit-DOS-RAID	-s111con Image 3132 Raid 5 driver v1.3.0.9 for windows 2000/XP/2003.0w
-32bit-DOS-SATA	-s111con Image 3132 Serial ATA driver V2.0.0.9 for windows 2000/XP/200
-64bit-RAID	-s111con Image 3132 Raid 5 driver v1.3.0.9 for windows 64bit xp/2003.0
-64bit-SATA	-s111con Image 3132 Serial ATA driver V2.0.0.9 for windows 64bit xp.0w
-64bit-DOS-RAID	-s111con Image 3132 Raid 5 driver v1.3.0.9 for windows 64bit xp/2003.0
-64bit-DOS-SATA	-s111con Image 3132 Serial ATA driver V2.0.0.9 for windows 64bit xp/20
-WIFI	
	-Realtek RTL8187 USB wireless LAN driver v5.1230.0518.2006 for windows
	-Realtek RTL8187 USB wireless LAN driver v5.1230.0518.2006 for windows



## 5.3 Software information

Most of the applications in the support DVD have wizards that will conveniently guide you through the installation. View the online help or readme file that came with the software application for more information.

### 5.3.1 ASUS MyLogo3™

The ASUS MyLogo3™ utility lets you customize the boot logo. The boot logo is the image that appears on screen during the Power-On Self-Tests (POST). The ASUS MyLogo3™ is automatically installed when you install the ASUS Update utility from the support DVD. See section “5.2.3 Utilities menu” for details.



- Before using the ASUS MyLogo3™, use the Award BIOS Flash utility to make a copy of your original BIOS file, or obtain the latest BIOS version from the ASUS website. See section “4.1.4 Updating the BIOS.”
- Make sure that the BIOS item Full Screen Logo is set to [Enabled] if you wish to use ASUS MyLogo2. See section “4.6.5 Boot Settings Configuration”.
- You can create your own boot logo image in GIF, JPG, or BMP file formats.

To launch the ASUS MyLogo3™:

1. Launch the ASUS Update utility. Refer to section “4.1.1 ASUS Update utility” for details.
2. Select Options from the drop down menu, then click **Next**.
3. Check the option **Launch MyLogo** to replace system boot logo before flashing BIOS, then click **Next**.
4. Select Update BIOS from a file from the drop down menu, then click Next.
5. When prompted, locate the new BIOS file, then click **Next**. The ASUS MyLogo window appears.
6. From the left window pane, select the folder that contains the image you intend to use as your boot logo.



- 7. When the logo images appear on the right window pane, select an image to enlarge by clicking on it.



- 8. Adjust the boot image to your desired size by selecting a value on the Ratio box.



- 9. When the screen returns to the ASUS Update utility, flash the original BIOS to load the new boot logo.
- 10. After flashing the BIOS, restart the computer to display the new boot logo during POST.

### 5.3.2 SoundMAX® High Definition Audio utility

The ADI AD1988B High Definition Audio CODEC provides 8-channel audio capability through the SoundMAX® audio utility with AudioESP™ software to deliver the ultimate audio experience on your PC. The software implements high quality audio synthesis/rendering, 3D sound positioning, and advanced voice-input technologies.

Follow the installation wizard to install the ADI AD1988B Audio Driver from the support DVD that came with the motherboard package to activate the SoundMAX® audio utility.

- 
- You must use 4-channel, 6-channel or 8-channel speakers for this setup.
  - SoundMAX® requires Microsoft® Windows® 2000/XP or later version. Make sure that one of these operating systems is installed before installing SoundMAX®.
  - Jack Retasking function works on High Definition front panel audio ports only.
- 

If the SoundMAX® audio utility is correctly installed, you will find the SoundMAX® icon on the taskbar.



From the taskbar, double-click on the SoundMAX® icon to display the SoundMAX® Control Panel.



## Audio Setup Wizard

By clicking the  icon from the SoundMAX® control panel, you can easily configure your audio settings. Simply follow succeeding screen instructions and begin enjoying High Definition Audio.



## Jack configuration

This screen helps you configure your computer's audio ports, depending on the audio devices you have installed.

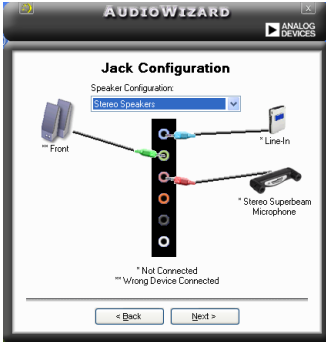

## Adjust speaker volume

This screen helps you adjust speaker volume. Click the **Test** button to hear the changes you have made.



## Adjust microphone volume

This screen helps you adjust microphone volume. You will be asked to read pre-written text to allow the AudioWizard to adjust the volume as you speak.

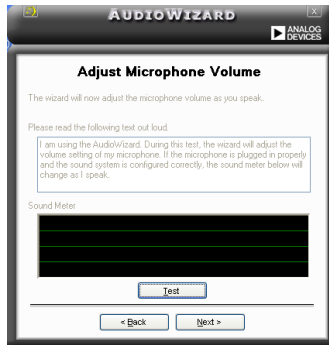

## Audio preferences



Click the  icon to go to the Preferences page. This page allows you to change various audio settings.

### General options

Click the General tab to choose your playback and recording devices, enable/disable the AudioESP™ feature, and enable/disable digital output.

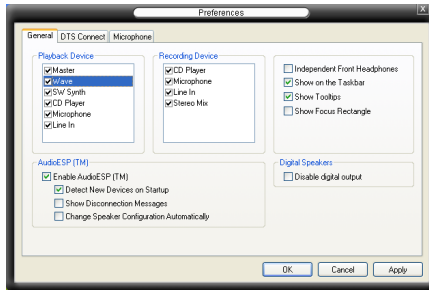

### DTS.

This feature consists of two elements: DTS interactive and DTS NEO:PC. DTS interactive re-encodes your stereo or multi-channel sound into a DTS audio signal and send it out from your PC to any DTS enabled system.

While DTS NEO:PC turns your stereo audio such as MP3, WMA, CD, and other sound format into a convincing multi-channel audio experience.

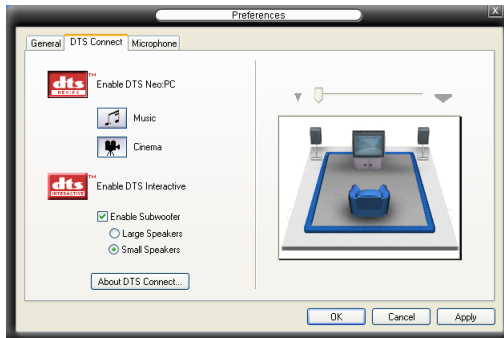

## Microphone options

Click the Listening Environment tab allows you to optimize your microphone input settings.

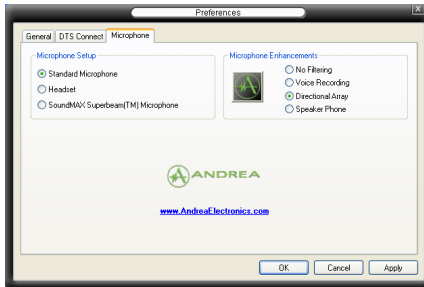

## Enhanced Microphone Features

### Voice recording

Enables Noise Filter function. Detects repetitive and stationary noises like computer fans, air conditioners, and other background noises then eliminates it in the incoming audio stream while recording. You can enable it for a better recording quality.

### Directional Array

Receives only the sound coming from the reception cone and eliminates interferences including neighboring speakers and reverberations. You can enable it to transit clearer sound during on-line games, MSN, or Skype.

### Speaker Phone

Advanced de-reverberation techniques can help to reduce echo and minimize its effect on the speech engine. You can enable it when you have conference call to reduce echoes in the other side.



---

The directional Array and Speaker Phone function only when working with the ASUS Array Mic.

---



### 5.3.3 Cool 'n' Quiet!™ Technology

The motherboard supports the AMD Cool 'n' Quiet!™ Technology that dynamically and automatically change the CPU speed, voltage, and amount of power depending on the task the CPU performs.

#### Enabling Cool 'n' Quiet!™ Technology

To enable Cool 'n' Quiet!™ Technology:

1. Turn on the system and enter BIOS by pressing the <Del> key during the Power On Self-Tests (POST).
2. Go to Extreme -> AMD Cool 'n'Quiet function and set it to [Enabled]. See section "4.4 Extreme Menu."
3. Save your changes and exit BIOS Setup.
4. Reboot your computer and set your Power Option Properties depending on your operating system.

#### *Windows® 2000/XP*

1. From the Windows® 2000/XP operating system, click the Start button. Select Settings, then Control Panel.
2. Make sure the Control Panel is set to Classic View.
3. Double-click the Display icon in the Control Panel then select the Screen Saver tab.
4. Click the Power button. The following dialog box appears.
5. From the Power schemes combo list box, select Minimal Power Management.
6. Click OK to effect settings.

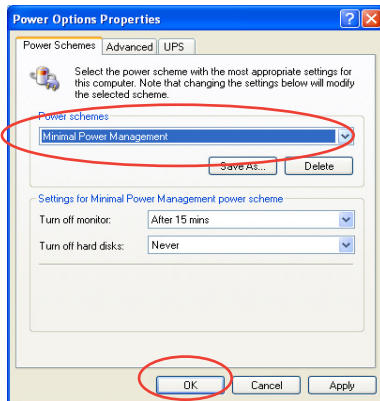





- Make sure to install the AMD Cool 'n' Quiet!™ driver and application before using this feature.
- The AMD Cool 'n' Quiet!™ technology feature works only with the AMD heatsink and fan assembly with monitor chip
- If you purchased a separate heatsink and fan package, use the ASUS Q-Fan technology feature to automatically adjust the CPU fan speed according to your system loading.

## Launching the Cool 'n' Quiet!™ software

The motherboard support DVD includes the Cool 'n' Quiet!™ software that enables you to view your system's real-time CPU Frequency and voltage.



Make sure to install the Cool 'n' Quiet!™ software from the motherboard support DVD. Refer to section "5.2.3 Utilities menu" for details.

To launch the Cool 'n' Quiet!™ program:

1. If you are using Windows® 2000, click the Start button. Select Programs-> ASUS -> Cool & Quiet -> Cool & Quiet.
2. If you are using Windows® XP, click the Start button. Select All Programs-> ASUS -> Cool & Quiet -> Cool & Quiet.
3. The Cool 'n' Quiet!™ technology screen appears and displays the current CPU Frequency and CPU Voltage.

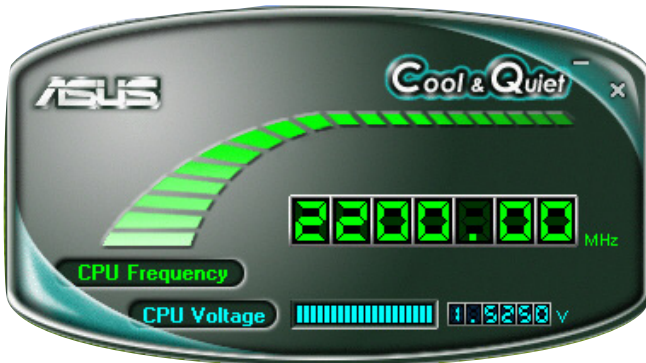

### 5.3.4 ASUS PC Probe II

PC Probe II is a utility that monitors the computer's vital components, and detects and alerts you of any problem with these components. PC Probe II senses fan rotations, CPU temperature, and system voltages, among others. Because PC Probe II is software-based, you can start monitoring your computer the moment you turn it on. With this utility, you are assured that your computer is always at a healthy operating condition.

#### Installing PC Probe II

To install PC Probe II on your computer:

1. Place the support DVD to the optical drive. The Drivers installation tab appears if your computer has an enabled Autorun feature.



If Autorun is not enabled in your computer, browse the contents of the support DVD to locate the setup.exe file from the ASUS PC Probe II folder. Double-click the setup.exe file to start installation.

2. Click the Utilities tab, then click ASUS PC Probe II.
3. Follow the screen instructions to complete installation.

#### Launching PC Probe II

You can launch the PC Probe II right after installation or anytime from the Windows® desktop.

To launch the PC Probe II from the Windows® desktop, click Start > All Programs > ASUS > PC Probe II > PC Probe II v1.00.43. The PC Probe II main window appears.

After launching the application, the PC Probe II icon appears in the Windows® taskbar. Click this icon to close or restore the application.







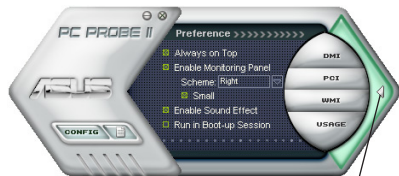

#### Using PC Probe II

##### Main window

The PC Probe II main window allows you to view the current status of your system and change the utility configuration. By default, the main window displays the Preference section. You can close or restore the Preference section by clicking on the triangle on the main window right handle.



Click to close the Preference panel

Button	Function
	Opens the Configuration window
	Opens the Report window
	Opens the Desktop Management Interface window
	Opens the Peripheral Component Interconnect window
	Opens the Windows Management Instrumentation window
	Opens the hard disk drive, memory, CPU usage window
	Shows/Hides the Preference section
	Minimizes the application
	Closes the application

### Sensor alert

When a system sensor detects a problem, the main window right handle turns red, as the illustrations below show.

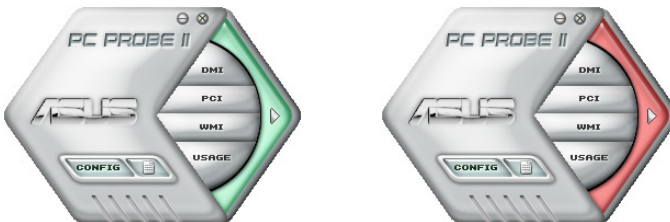

When displayed, the monitor panel for that sensor also turns red. Refer to the Monitor panels section for details.

## Preferences

You can customize the application using the Preference section in the main window. Click the box before each preference to activate or deactivate.

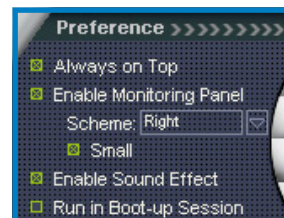

## Hardware monitor panels

The hardware monitor panels display the current value of a system sensor such as fan rotation, CPU temperature, and voltages.

The hardware monitor panels come in two display modes: hexagonal (large) and rectangular (small). When you check the Enable Monitoring Panel option from the Preference section, the monitor panels appear on your computer's desktop.



Large display



Small display

### Changing the monitor panels position

To change the position of the monitor panels in the desktop, click the arrow down button of the Scheme options, then select another position from the list box. Click OK when finished.



### Moving the monitor panels

All monitor panels move together using a magnetic effect. If you want to detach a monitor panel from the group, click the horseshoe magnet icon. You can now move or reposition the panel independently.



### Adjusting the sensor threshold value

You can adjust the sensor threshold value in the monitor panel by clicking the <+> or <-> buttons. You can also adjust the threshold values using the Config window.

You cannot adjust the sensor threshold values in a small monitoring panel.

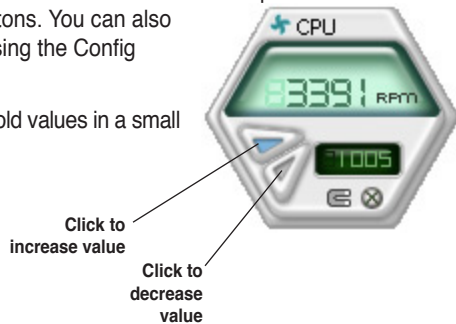

### Monitoring sensor alert

The monitor panel turns red when a component value exceeds or is lower than the threshold value. Refer to the illustrations below.



Large display



Small display

## WMI browser

Click **WMI** to display the WMI (Windows Management Instrumentation) browser. This browser displays various Windows® management information. Click an item from the left panel to display on the right panel. Click the plus sign (+) before WMI Information to display the available information.

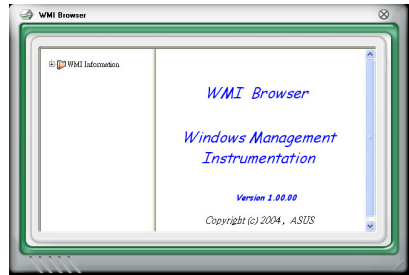

You can enlarge or reduce the browser size by dragging the bottom right corner of the browser.

## DMI browser

Click **DMI** to display the DMI (Desktop Management Interface) browser. This browser displays various desktop and system information. Click the plus sign (+) before DMI Information to display the available information.

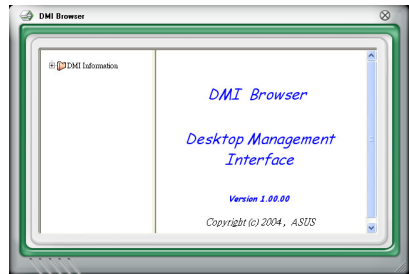

## PCI browser

Click **PCI** to display the PCI (Peripheral Component Interconnect) browser. This browser provides information on the PCI devices installed on your system. Click the plus sign (+) before the PCI Information item to display available information.

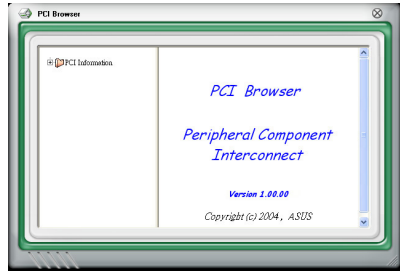

## Usage

The Usage browser displays real-time information on the CPU, hard disk drive space, and memory usage. Click **USAGE** to display the Usage browser.

### CPU usage

The CPU tab displays real-time CPU usage in line graph representation. If the CPU has an enabled Hyper-Threading, two separate line graphs display the operation of the two logical processors.

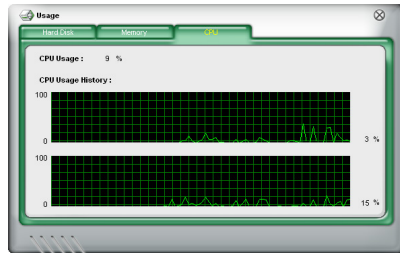

### Hard disk drive space usage

The Hard Disk tab displays the used and available hard disk drive space. The left panel of the tab lists all logical drives. Click a hard disk drive to display the information on the right panel. The pie chart at the bottom of the window represents the used (blue) and the available HDD space.

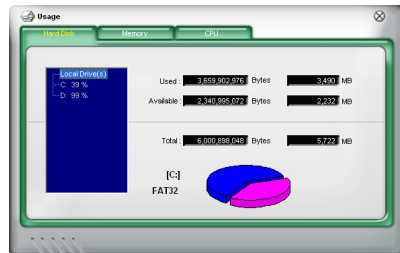

### Memory usage

The Memory tab shows both used and available physical memory. The pie chart at the bottom of the window represents the used (blue) and the available

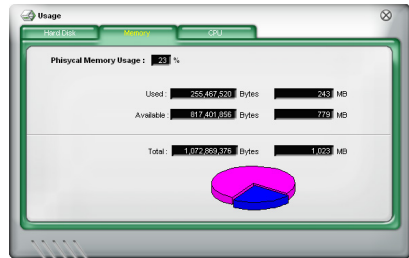

## Configuring PC Probe II

Click  to view and adjust the sensor threshold values.

The Config window has two tabs: Sensor/Threshold and Preference. The Sensor/Threshold tab enables you to activate the sensors or to adjust the sensor threshold values. The Preference tab allows you to customize sensor alerts, or change the temperature scale.

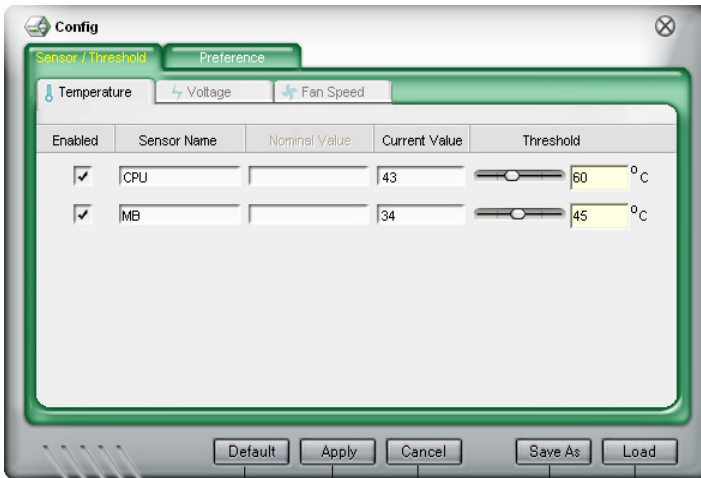

Loads the default threshold values for each sensor

Applies your changes

Cancels or ignores your changes

Loads your saved configuration  
Saves your configuration

## 5.4 RAID configurations

The motherboard comes with the Silicon Image Sil3132 and the NVIDIA® nForce™ 590- SLI Southbridge RAID controllers that allow you to configure Serial ATA hard disk drives as RAID sets. The motherboard supports the following RAID configurations.

**RAID 0** (*Data striping*) optimizes two identical hard disk drives to read and write data in parallel, interleaved stacks. Two hard disks perform the same work as a single drive but at a sustained data transfer rate, double that of a single disk alone, thus improving data access and storage. Use of two new identical hard disk drives is required for this setup.

**RAID 1** (*Data mirroring*) copies and maintains an identical image of data from one drive to a second drive. If one drive fails, the disk array management software directs all applications to the surviving drive as it contains a complete copy of the data in the other drive. This RAID configuration provides data protection and increases fault tolerance to the entire system. Use two new drives or use an existing drive and a new drive for this setup. The new drive must be of the same size or larger than the existing drive.

**RAID 0+1** is data striping and data mirroring combined without parity (redundancy data) having to be calculated and written. With the RAID 0+1 configuration you get all the benefits of both RAID 0 and RAID 1 configurations. Use four new hard disk drives or use an existing drive and three new drives for this setup.

**RAID 5** stripes both data and parity information across three or more hard disk drives. Among the advantages of RAID 5 configuration include better HDD performance, fault tolerance, and higher storage capacity. The RAID 5 configuration is best suited for transaction processing, relational database applications, enterprise resource planning, and other business systems. Use a minimum of three identical hard disk drives for this setup.

**RAID 10** is a striped configuration with each stripe a RAID 1 array of drives. It combines the features of both RAID 1 and RAID 0. Fault tolerance is provided through mirroring while adding performance through striping. This offers higher performance than a RAID 1 configuration but at a much higher cost. A minimum of four hard disk drives is required for this setup.

**JBOD** (*Spanning*) stands for Just a Bunch of Disks and refers to hard disk drives that are not yet configured as a RAID set. This configuration stores the same data redundantly on multiple disks that appear as a single disk on the operating system. Spanning does not deliver any advantage over using separate disks independently and does not provide fault tolerance or other RAID performance benefits.





---

If you want to boot the system from a hard disk drive included in a RAID set, copy first the RAID driver from the support DVD to a floppy disk before you install an operating system to a selected hard disk drive. Refer to section “5.5 Creating a RAID driver disk” for details.

---

## 5.4.1 NVIDIA® RAID configurations

The motherboard includes a high performance SATA RAID controller integrated in the NVIDIA® nForce™ 590-SLI southbridge chipset. It supports RAID 0, RAID 1, RAID 0+1, RAID 5 and JBOD for six independent Serial ATA channels.

### Installing Serial ATA (SATA) hard disks

The motherboard supports Ultra DMA 133/100/66 and Serial ATA hard disk drives. For optimal performance, install identical drives of the same model and capacity when creating a disk array.

To install the SATA hard disks for a RAID configuration:

1. Install the SATA hard disks into the drive bays.
2. Connect the SATA signal cables.
3. Connect a SATA power cable to the power connector on each drive.



---

Refer to the RAID controllers user manual in the motherboard support DVD for detailed information on RAID configurations. See section “5.2.5 Manuals menu.”

---

### Setting the BIOS RAID items

After installing the hard disk drives, make sure to set the necessary RAID items in the BIOS before setting your RAID configuration.

To set the BIOS RAID items:

1. Boot the system and press <Del> during the Power-On Self-Test (POST) to enter the BIOS Setup Utility.
2. Enable the RAID Enabled item in the BIOS. See section “4.5.4 Onboard Device Configuration > Serial-ATA Configuration” for details.
3. Select and enable the IDE or SATA drive(s) that you want to configure as RAID. See section “4.5.4 Onboard Device Configuration > Serial-ATA Configuration” for details.
4. Save your changes and Exit Setup.



---

Make sure to re-enter your NVRAID settings after the CMOS is cleared; otherwise, the system will not recognize your RAID setup.

---



- 
- For detailed descriptions on the NVIDIA® RAID configuration, refer to the “NVIDIA® RAID User’s Manual” found in your motherboard support DVD.
  - When using Windows 2000 operating system, make sure to install the Windows 2000 Service Pack 4 or later versions.
-

## Entering the NVIDIA® RAID utility

To enter the NVIDIA® RAID utility:

1. Boot up your computer.
2. During POST, press <F10> to display the main menu of the utility.



The RAID BIOS setup screens shown in this section are for reference only, and may not exactly match the items on your screen.

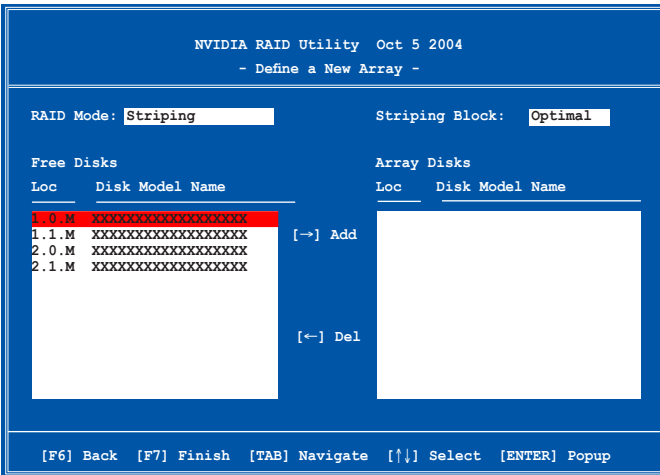

At the bottom of the screen are the navigation keys. These keys allow you to move through and select menu options.

## Creating a RAID Volume

To create a RAID volume:

1. From the NVIDIA® RAID utility Define a New Array menu, select RAID Mode then press <Enter>. The following submenu appears.

Use the up or down arrow keys to select a RAID mode then press <Enter>.

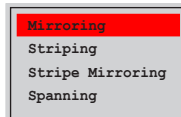

2. Press <TAB> select the Striping Block then press <Enter>. The following submenu appears:

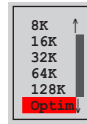

If you selected Striping or Stripe Mirroring, use the up or down arrow keys to select the stripe size for your RAID 0 array then press <Enter>. The available values range from 8 KB to 128 KB. The default selection is 128 KB. The stripe value should be chosen based on the planned drive usage.

- 8 /16 KB - low disk usage
- 64 KB - typical disk usage
- 128 KB - performance disk usage



---

TIP: For server systems, we recommend using a lower array block size. For multimedia computer systems used mainly for audio and video editing, we recommend a higher array block size for optimum performance.

---

3. Press <TAB> to select the Free Disks area. Use the left or right arrow keys to assign the array disks.
4. Press <F7> to create RAID set. The following message box appears.

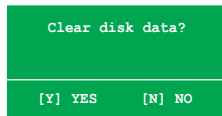

5. Press <Y> to clear the selected disks or <N> to proceed without clearing the disks. The following screen appears.



---

Take caution in using this option. All data on the RAID drives will be lost!

---

```

NVIDIA RAID Utility  Oct 5 2004
- Array List -

  Boot  Id  Status  Vendor  Array Model Name
  ----  -  -  -  -
  No    4  Healthy  NVIDIA  MIRROR  XXX.XXG

[Ctrl-X]Exit  [↑↓]Select  [B]Set Boot  [N]New Array  [ENTER]Detail

```

A new set of navigation keys is displayed on the bottom of the screen.

6. Press <Ctrl+X> to save settings and exit.

### Rebuilding a RAID array

To rebuild a RAID array:

1. From the Array List menu, use the up or down arrow keys to select a RAID array then press <Enter>. The RAID Array details appear.

```

Array 1 : NVIDIA MIRROR  XXX.XXG
- Array Detail -

RAID Mode: Mirroring
Striping Width: 1          Striping Block: 64K

  Adapt  Channel  M/S  Index  Disk Model Name  Capacity
  ----  -  -  -  -  -
  2      1      Master  0  XXXXXXXXXXXXXXXXXXXX  XXX.XXGB
  1      0      Master  1  XXXXXXXXXXXXXXXXXXXX  XXX.XXGB

[R] Rebuild  [D] Delete  [C] Clear Disk  [ENTER] Return

```

- A new set of navigation keys is displayed on the bottom of the screen.
- Press <R> to rebuild a RAID array. The following screen appears.

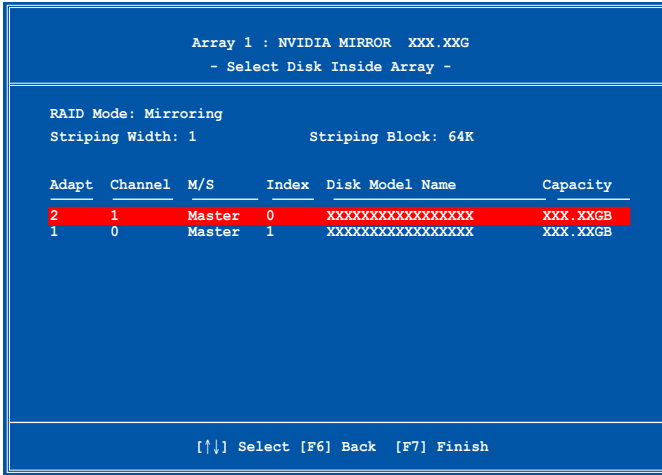

- Use the up or down arrow keys to select a RAID array to rebuild, then press <F7>. The following confirmation message appears.



- Press <Enter> to start rebuilding array or press <Esc> to cancel.
- After the rebuild process, the Array list menu appears.

## Deleting a RAID array

To delete a RAID array:

1. From the Array List menu, use the up or down arrow keys to select a RAID array then press <Enter>. The RAID Array details appear.

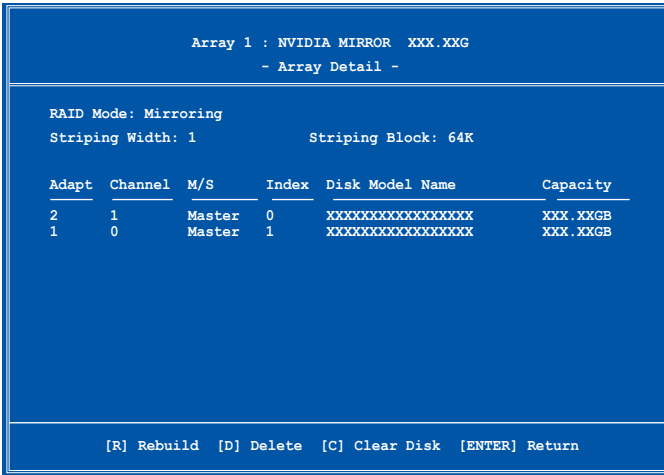

A new set of navigation keys is displayed on the bottom of the screen.

2. Press <D> to delete a RAID array. The following confirmation message appears.

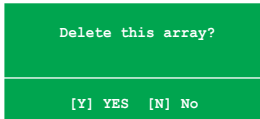

3. Press <Y> to delete array or press <N> to cancel.



Take caution in using this option. All data on the RAID drives will be lost!

4. If you selected Yes, the Define a New Array menu appears.

## Clearing a disk data

To clear disk data:

1. From the Array List menu, use the up or down arrow keys to select a RAID array then press <Enter>. The RAID Array details appear.

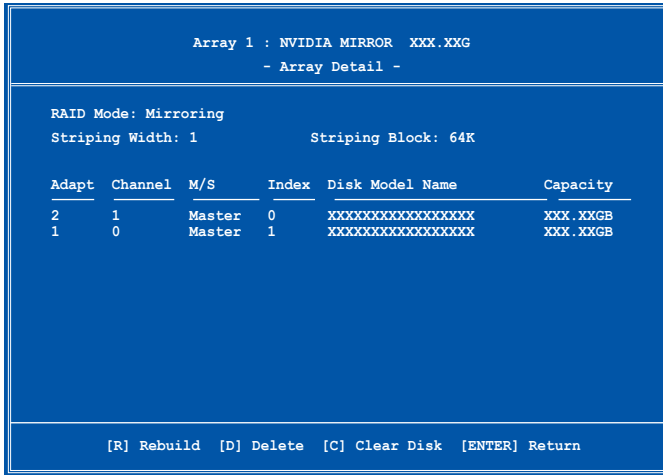

A new set of navigation keys is displayed on the bottom of the screen.

2. Press <C> to clear disk. The following confirmation message appears.

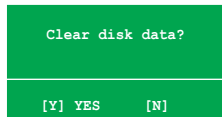

5. Press <Y> to clear the disk data or press <N> to cancel.



Take caution in using this option. All data on the RAID drives will be lost!

## 5.4.2 Silicon Image RAID configurations

The Silicon Image RAID controller supports RAID 0 and RAID 1 configurations. Use the Silicon Image RAID utility to configure a disk array.

### Installing External Serial ATA (E-SATA) hard disks

To install the External SATA hard disks for a RAID configuration:

1. Connect one end of the E-SATA signal cables to the rear panel port.
2. Connect the other end of the E-SATA signal cables to the external SATA disk drives.



---

The installation procedure in this section is provided for reference only, refer to the user's manual that comes with the external drive for detailed installation instructions.

---

### Setting the BIOS RAID items

After installing the hard disk drives, make sure to set the necessary RAID items in the BIOS before setting your RAID configuration.

To set the BIOS RAID items:

1. Boot the system and press <Del> during the Power-On Self-Test (POST) to enter the BIOS Setup Utility.
2. From the Advanced > Onboard Device Configuration menu item in the BIOS set the Silicon SATA II Controller item to RAID Mode. See section "4.5.4 Onboard Device Configuration" for details.
3. Save your changes and Exit Setup.

### Launching the Silicon Image Array Management Software

Launch the Silicon Image Array Management software from Windows® XP by clicking the Start button and selecting All Programs > Silicon Image > Sam



---

For details on the Silicon Image SATA RAID™ RAID configuration, refer to the "Sil3132 SATA RAID User's Manual" in your motherboard support DVD.

---



## Entering the Silicon Image BIOS RAID Configuration Utility

To enter the Silicon Image BIOS RAID configuration utility:

1. Boot up your computer.
2. During POST, press <Ctrl+S> or <F4>.



The RAID BIOS setup screens shown in this section are for reference only, and may not exactly match the items on your screen.

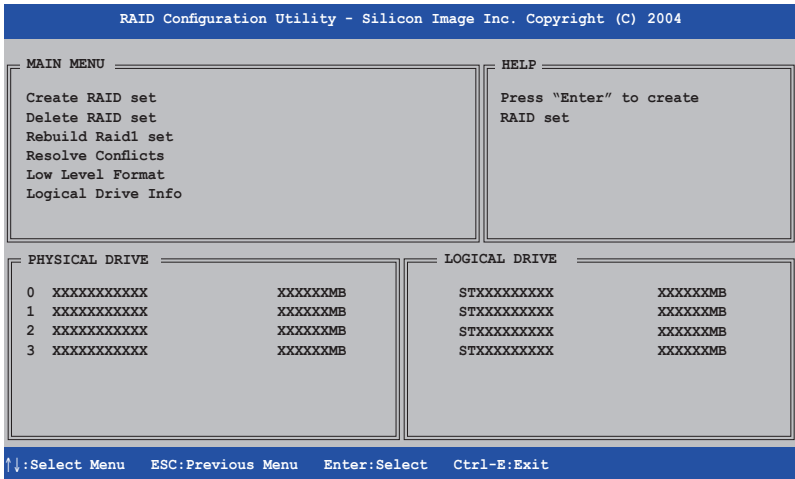

The Main Menu on the upper left corner allows you to select an operation to be performed. The Main Menu options include the following:

Create RAID set - creates a new legacy RAID set or allocates spare drives.

Delete RAID set - deletes a RAID set or deallocates a spare drive.

Rebuild RAID1 set - rebuilds a RAID 1 set (e.g., swapped drives).

Resolve Conflicts - automatically restores disrupted drives on a RAID set.

Low Level Format - creates a pattern of reference marks on a drive. Formatting the disks erases all data previously stored in the drive.

Logical Drive Info - shows the current configuration of each RAID set.

On the upper right corner of the screen is the Help message box. The message describes the function of each menu item. At the bottom of the screen is the legend box. The keys on the legend box allow you to navigate through the setup menu options. The following lists the keys found in the legend box and their corresponding functions.

- ↑, ↓ : Select/Move to the next item
- ESC** : Previous Menu
- Enter** : Select
- Ctrl-E** : Exit

## Creating a RAID 0 set (Striped)

To create a RAID set:

1. From the Silicon Image configuration utility main menu, select Create RAID set then press <Enter> to display an option menu.

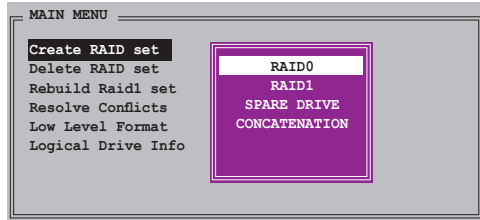

2. Select RAID 0 then press <Enter> to display the following.

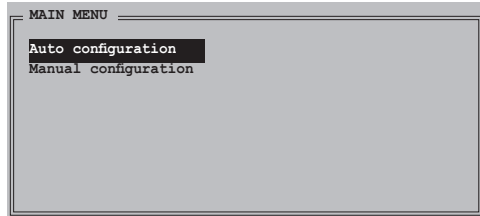

3. Select your desired method of configuration.  
Auto configuration
  - a. Select Auto Configuration the press <Enter>.
  - b. The utility prompts a message to input the RAID size, use the up or down arrow keys to set the RAID size then press <Enter>.
  - c. Press <Y> to confirm or <N> to return to the Main Menu.



By default, Auto configuration sets the stripe size to 64K and sets the logical drives based on the physical drives installed.

### Manual configuration

- a. Select Manual configuration and press <Enter>. The following pop-up menu appears.
- b. Use the up or down arrow keys to select a chunk size appropriate to your drive usage then press <Enter>.

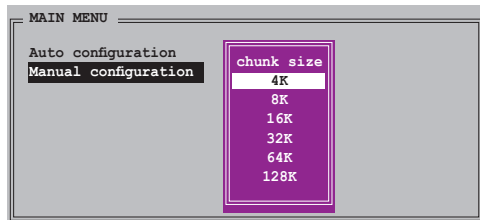



**TIP:** For server systems, we recommend using a lower array block size. For multimedia computer systems used mainly for audio and video editing, we recommend a higher array block size for optimum performance.

c. The selection bar moves to the Physical Drive menu Using the up or down arrowkeys, select a drive then press <Enter> to set the first drive of the RAID set.

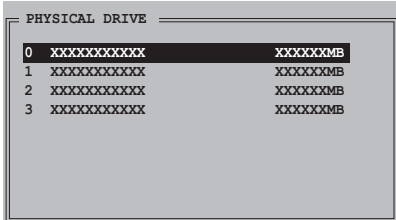

d. Repeat step c to set the second, third, and fourth drive. The number of available drives depend on the installed and enabled physical drives in the system.

e. The utility prompts a message to input the RAID size, use the up or down arrow keys to set the RAID size then press <Enter>.

f. Press <Y> to confirm or <N> to return to the Main Menu.

## Creating a RAID 1 set (Mirrored)

To create a RAID 1 set:

1. From the Silicon Image configuration utility main menu, select Create RAID set then press <Enter>. The following sub-menu appears.

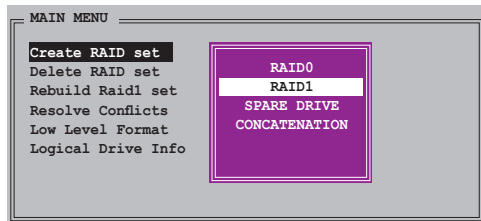

2. Select RAID 1 then press <Enter> to display the following.

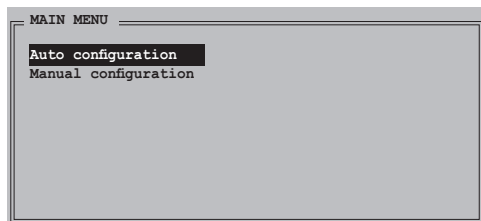

3. Select your desired method of configuration.

Auto configuration

- a. Select Auto Configuration then press <Enter>.
- b. The utility prompts a message to input the RAID size, use the up or down arrow keys to set the RAID size then press <Enter>.
- c. Press <Y> to confirm or <N> to return to the Main Menu.



- 
- Auto-configuration creates a RAID 1 set without a backup copy of the current source disk data.
  - When migrating a single hard disk drive to a RAID 1 set, use of the Manual configuration is recommended.
- 

**Manual configuration**

- a. Select Manual configuration and press <Enter>. The selection bar moves to the Physical Drives menu.
- b. Using the up or down arrow keys, select the source drive and press <Enter>.

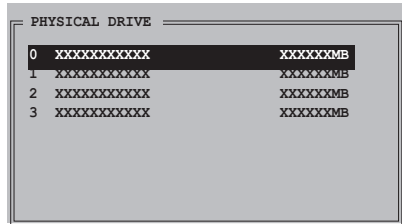

- c. Repeat step b to select the target drive.
- d. After selecting the source and target drives, the following pop-up menu appears.

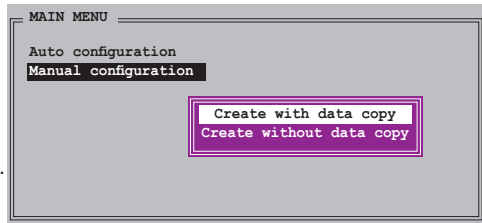

- 
- The Create with data copy option allows you to copy the current data from the source drive to the mirror drive.
  - Select Create with data copy if you have important data in your source drive.
  - The Create without data copy option disables the disk copy function of the Mirrored set.
  - If you selected Create without data copy, the RAID 1 set must be repartitioned and reformatted to guarantee the consistency of its contents.
-

- e. If you selected Create with data copy, the following pop-up menu appears.

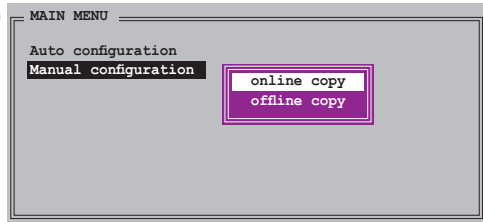

---

The online copy option automatically copies the data to the target drives on the background while writing to the source drives. The offline copy option allows you to copy the contents of the source drive to the target drives now.

---

- f. Use the up or down arrow keys to select desired copy method, then press <Enter>.
- g. The utility prompts a message to input the RAID size, use the up or down arrow keys to set the RAID size then press <Enter>.
- h. Press <Y> to confirm or <N> to return to the Main Menu.



---

A copy progress appears if you previously selected offline copy.

---

## Creating a CONCATENATION set

To create a CONCATENATION set:

1. From the Silicon Image configuration utility main menu, select Create RAID then press <Enter>.
2. From the sub-menu Select CONCATENATION then press <Enter>.

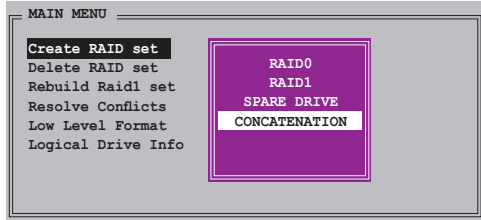

3. The selection bar moves to the Physical Drive menu. Using the up or down arrow keys, select a drive then press <Enter> to set a drive for the RAID set.
4. The utility prompts a message to input the RAID size, use the up or down arrow keys to set the RAID size then press <Enter>.
5. Press <Y> to confirm or <N> to return to the Main Menu.

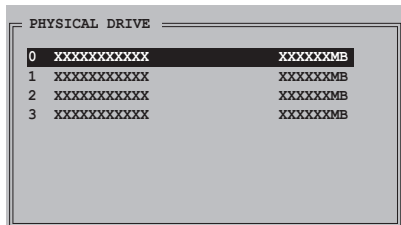

- Configure a CONCATENATION set when using a single Serial ATA drive; otherwise, the system will not recognize the drive.
- You can also create a RAID set using the SATARAID5 GUI utility under a Windows® environment.

## 5.5 Creating a RAID driver disk

A floppy disk with the RAID driver is required when installing Windows® 2000/XP operating system on a hard disk drive that is included in a RAID set.

To create a RAID driver disk:

1. Place the motherboard support DVD into the DVD-ROM drive.
2. Select Make Disk tab.
3. From the Make Disk menu, select the RAID driver disk you want to create or browse the contents of the support DVD to locate the driver disk utility.



---

Refer to section “5.2.4 Make Disk menu” for details.

---

4. Insert floppy disk to floppy disk drive.
5. Follow succeeding screen information to complete process.
6. Write-protect the floppy disk to avoid computer virus infection.

To install the RAID driver:

1. During the OS installation, the system prompts you to press the F6 key to install third-party SCSI or RAID driver.
2. Press <F6> then insert the floppy disk with RAID driver into the floppy disk drive.
3. Follow the succeeding screen instructions to complete the installation.



---

Due to chipset limitation, the Serial ATA ports supported by the NVIDIA chipset doesn't support Serial Optical Disk Drives (Serial ODD) under DOS.

---





This chapter tells how to install SLI-ready  
PCI Express graphics cards.

# **NVIDIA<sup>®</sup> SLI<sup>™</sup>** **technology support**

## Chapter summary

6.1	Overview .....	6-1
6.2	Dual graphics cards setup .....	6-2

## 6.1 Overview

The motherboard supports the NVIDIA® SLI™ (Scalable Link Interface) technology that allows you to install two identical PCI Express™ x16 graphics cards. Follow the installation procedures in this section.

### Requirements

- You should have two identical SLI-ready graphics cards that are NVIDIA® certified.
- Make sure that your graphics card driver supports the NVIDIA SLI technology. Download the latest driver from the NVIDIA website ([www.nvidia.com](http://www.nvidia.com)).
- Make sure that your power supply unit (PSU) can provide at least the minimum power required by your system. See “8. ATX power connectors” on page 2-32 for details.



- 
- The NVIDIA SLI technology supports Windows® XP™ 32-bit/64bit operating system only.
  - Visit the NVIDIA zone website (<http://www.nzone.com>) for the latest certified graphics card and supported 3D application list.
-

## 6.2 Dual graphics card setup

### 6.2.1 Installing SLI-ready graphics cards



Install only identical SLI-ready graphics cards that are NVIDIA®-certified. Different types of graphics cards will not work together properly.

To install the graphics cards:

1. Prepare two graphics cards. Each graphics card should have goldfingers for the SLI connector.

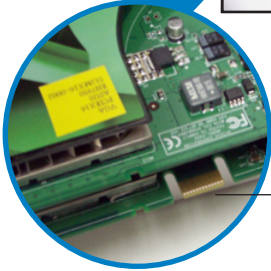

Goldfingers

2. Remove the metal bracket covers opposite the two PCI Express x16 slots.

3. Insert one graphics card into either the blue or black slot. Make sure that the card is properly seated on the slot.

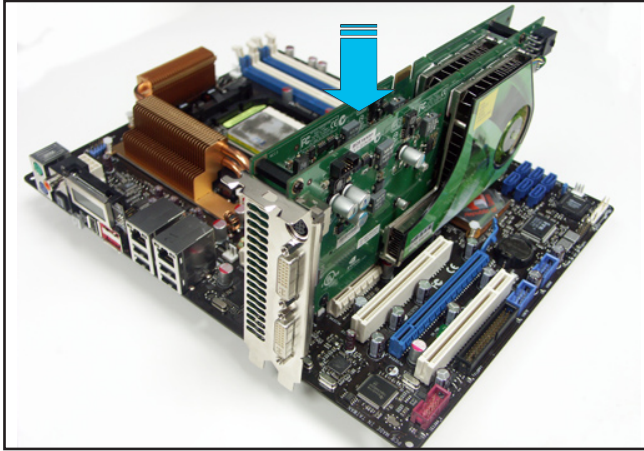

4. Insert the second graphics card into the other slot. Make sure that the card is properly seated on the slot.

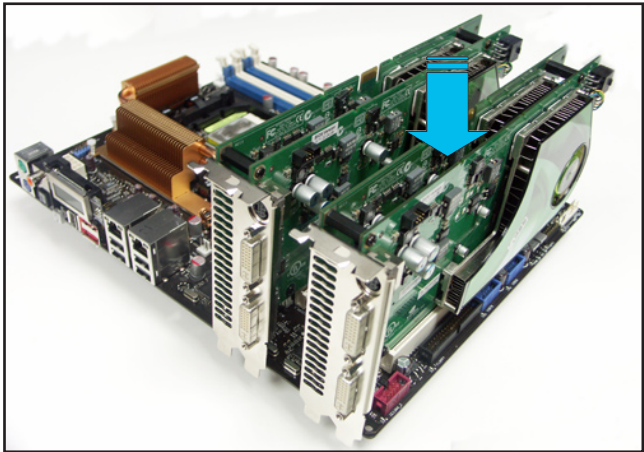

If required, connect an auxiliary power source to the PCI Express graphics cards.

5. Align and insert the SLI connector to the goldfingers on each graphics card. Make sure that the connector is firmly in place.

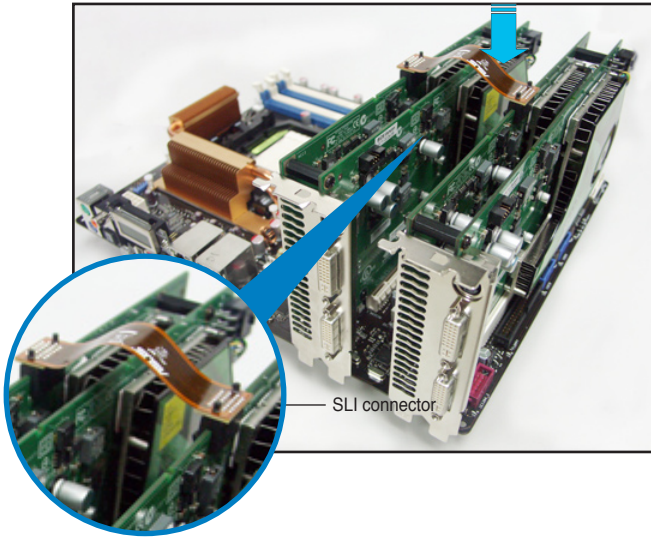

6. When installing two VGA cards using a 20-pin ATX PSU with sufficient +12v capability, we recommend that you connect the auxiliary power source from the power supply to the graphics card. Refer to the PSU documentation for dual VGA power requirements.
7. Connect a VGA cable or a DVI-I cable to the graphics card/s.



---

We recommend to install an additional chassis fan for better thermal environment.

---

## 6.2.2 Installing the device drivers

Refer to the documentation that came with your graphics card package to install the device drivers.



Make sure that your PCI Express graphics card driver supports the NVIDIA SLI technology. Download the latest driver from the NVIDIA website ([www.nvidia.com](http://www.nvidia.com)).

## 6.2.3 Enabling the multi-GPU feature in Windows®

After installing your graphics cards and the device drivers, enable the Multi-Graphics Processing Unit (GPU) feature in the NVIDIA nView properties.

To enable the multi-GPU feature:

1. Click the NVIDIA Settings icon on your Windows taskbar.



NVIDIA Settings icon

2. From the pop-up menu, select nView Desktop Manager then click nView Properties.

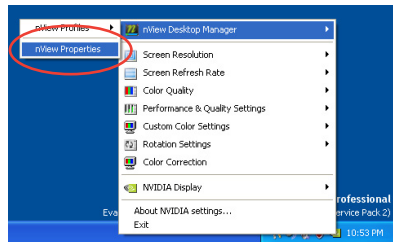

3. From the nView Desktop Manager window, select the Desktop Management tab.
4. Click Properties to display the Display Properties dialog box.

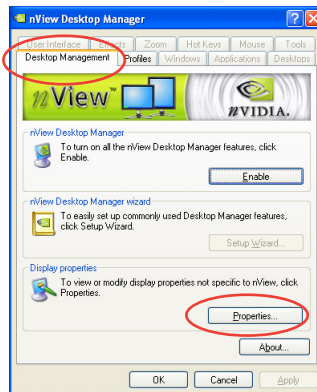

- From the Display Properties dialog box, select the Settings tab then click Advanced.

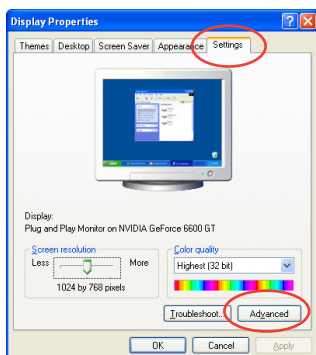

- Select the NVIDIA GeForce tab.

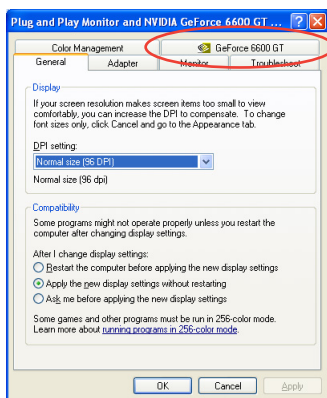

- Click the slider to display the following screen, then select the SLI multi-GPU item.

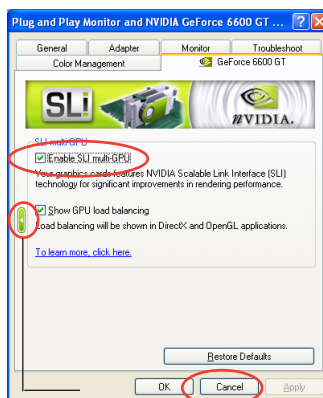
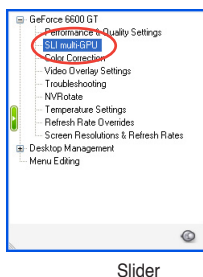

- Click the Enable SLI multi-GPU check box.
- Click OK when done.



The appendix explains the debug code on the LCD poster.

# Debug Code



# Chapter summary



A.1 Debug Code .....A-1

## A.1 Debug Code Table

Code	Description
CPU INIT	CPU Initiation
DET CPU	Test CMOS R/W functionality.
CHIPINIT	Early chipset initialization: -Disable shadow RAM -Disable L2 cache (socket 7 or below) -Program basic chipset registers
DET DRAM	Detect memory -Auto-detection of DRAM size, type and ECC. -Auto-detection of L2 cache (socket 7 or below)
DC FCODE	Expand compressed BIOS code to DRAM
EFSHADOW	Call chipset hook to copy BIOS back to E000 & F000 shadow RAM.
DC XCODE	Expand the Xgroup codes locating in physical address 1000:0
INIT IO	Initial Superio_Early_Init switch.
CLR SCRN	1. Blank out screen 2. Clear CMOS error flag
INIT8042	1. Clear 8042 interface 2. Initialize 8042 self-test
ENABLEKB	1. Test special keyboard controller for Winbond 977 series Super I/O chips. 2. Enable keyboard interface.
DIS MS	1. Disable PS/2 mouse interface (optional). 2. Auto detect ports for keyboard & mouse followed by a port & interface swap (optional). 3. Reset keyboard for Winbond 977 series Super I/O chips.
R/W FSEG	Test F000h segment shadow to see whether it is R/W-able or not. If test fails, keep beeping the speaker.
DET FLASH	Auto detect flash type to load appropriate flash R/W codes into the run time area in F000 for ESCD & DMI support.
TESTCMOS	Use walking 1's algorithm to check out interface in CMOS circuitry. Also set real-time clock power status, and then check for override.
PRG CHIP	Program chipset default values into chipset. Chipset default values are MODBINable by OEM customers.
INIT CLK	Initial Early_Init_Onboard_Generator switch.
CHECKCPU	Detect CPU information including brand, SMI type (Cyrix or Intel) and CPU level (586 or 686).
INTRINIT	Initial interrupts vector table. If no special specified, all H/W interrupts are directed to SPURIOUS_INT_HDLR & S/W interrupts to SPURIOUS_soft_HDLR.
REC MPS	Initial EARLY_PM_INIT switch.
Reserved	Load keyboard matrix (notebook platform)
Reserved	HPM initialization (notebook platform)
SET FDD	1. Check validity of RTC value: e.g. a value of 5Ah is an invalid value for RTC minute. 2. Load CMOS settings into BIOS stack. If CMOS checksum fails, use default value instead. 3. Prepare BIOS resource map for PCI & PnP use. If ESCD is valid, take into consideration of the ESCD's legacy information. 4. Onboard clock generator initialization. Disable respective clock resource to empty PCI & DIMM slots. 5. Early PCI initialization: -Enumerate PCI bus number -Assign memory & I/O resource -Search for a valid VGA device & VGA BIOS, and put it into C000:0.
INITINT9	Initialize INT 09 buffer

CPUSPEED	<ol style="list-style-type: none"> <li>1. Program CPU internal MTRR (P6 &amp; PII) for 0-640K memory address.</li> <li>2. Initialize the APIC for Pentium class CPU.</li> <li>3. Program early chipset according to CMOS setup. Example: onboard IDE controller.</li> <li>4. Measure CPU speed.</li> <li>5. Invoke video BIOS.</li> </ol>
TESTVRAM	<ol style="list-style-type: none"> <li>1. Initialize multi-language</li> <li>2. Put information on screen display, including Award title, CPU type, CPU speed .</li> </ol>
RESET KB	Reset keyboard except Winbond 977 series Super I/O chips.
8254TEST	Test 8254
8259MSK1	Test 8259 interrupt mask bits for channel 1.
8259MSK2	Test 8259 interrupt mask bits for channel 2.
8259TEST	Test 8259 functionality.
Reserved	Initialize EISA slot
COUNTMEM	<ol style="list-style-type: none"> <li>1. Calculate total memory by testing the last double word of each 64K page.</li> <li>2. Program write allocation for AMD K5 CPU.</li> </ol>
MP INIT	<ol style="list-style-type: none"> <li>1. Program MTRR of M1 CPU</li> <li>2. Initialize L2 cache for P6 class CPU &amp; program CPU with proper cacheable range.</li> <li>3. Initialize the APIC for P6 class CPU.</li> <li>4. On MP platform, adjust the cacheable range to smaller one in case the cacheable ranges between each CPU are not identical.</li> </ol>
USB INIT	Initialize USB
TEST MEM	Test all memory (clear all extended memory to 0)
SHOW MP	Display number of processors (multi-processor platform)
PNP LOGO	<ol style="list-style-type: none"> <li>1. Display PnP logo</li> <li>2. Early ISA PnP initialization</li> </ol> -Assign CSN to every ISA PnP device.
Reserved	Initialize the combined Trend Anti-Virus code.
SHOW EZF	(Optional Feature) Show message for entering AWDFLASH.EXE from FDD (optional)
ONBD IO	<ol style="list-style-type: none"> <li>1. Initialize Init_Onboard_Super_IO switch.</li> <li>2. Initialize Init_Onboard_AUDIO switch.</li> </ol>
EN SETUP	Okay to enter Setup utility; i.e. not until this POST stage can users enter the CMOS setup utility.
MSINSTAL	Initialize PS/2 Mouse
CHK ACPI	Prepare memory size information for function call: INT 15h ax=E820h
EN CACHE	Turn on L2 cache
SET CHIP	Program chipset registers according to items described in Setup & Auto-configuration table.
AUTO CFG	<ol style="list-style-type: none"> <li>1. Assign resources to all ISA PnP devices.</li> <li>2. Auto assign ports to onboard COM ports if the corresponding item in Setup is set to "AUTO".</li> </ol>
INIT FDC	<ol style="list-style-type: none"> <li>1. Initialize floppy controller</li> <li>2. Set up floppy related fields in 40:hardware.</li> </ol>
CUTIRQ12	(Optional Feature) Enter AWDFLASH.EXE if : -AWDFLASH is found in floppy drive. -ALT+F2 is pressed
DET IDE	Detect & install all IDE devices: HDD, LS120, ZIP, CDROM.....
COM/LPT	Detect serial ports & parallel ports.
DET FPU	Detect & install co-processor

CPU CHG	CPU change
CPR FAIL	CPR error
FAN FAIL	Fan error
UCODEERR	UCODE error
FLOPYERR	Floppy error
KB ERROR	Keyboard error
HD ERR	HDD error
CMOS ERR	CMOS error
MS ERROR	Mouse error
80P ERR	80 port error
BOOT CHG	Boot device change
SMARTERR	HDD smart function error
HM ERROR	Hard monitor error
AINETERR	AI NET error
CASEOPEN	Case open
PASSWORD	Clear EPA or customization logo. 1. Call chipset power management hook. 2. Recover the text font used by EPA logo (not for full screen logo) 3. If password is set, ask for password.
MEM2CMOS	Save all data in stack back to CMOS
INIT PNP USB FINAL	Initialize ISA PnP boot devices 1. USB final Initialization 2. NET PC: Build SYSID structure 3. Switch screen back to text mode 4. Set up ACPI table at top of memory. 5. Invoke ISA adapter ROMs 6. Assign IRQs to PCI devices 7. Initialize APM 8. Clear noise of IRQs.
READ HDD BOOTMENU	Read HDD boot sector information for Trend Anti-Virus code 1. Enable L2 cache 2. Program boot up speed 3. Chipset final initialization. 4. Power management final initialization 5. Clear screen & display summary table 6. Program K6 write allocation 7. Program P6 class write combining
NUM LOCK	1. Program daylight saving 2. Update keyboard LED & typematic rate
UPDT DMI	1. Build MP table 2. Build & update ESCD 3. Set CMOS century to 20h or 19h 4. Load CMOS time into DOS timer tick 5. Build MSIRQ routing table.
INT 19H	Boot attempt (INT 19h)

