

ASUS[®]

Pundit P1-AH2

ASUS PC (Desktop Barebone)



E2574

First Edition V1
June 2006

Copyright © 2006 ASUSTeK COMPUTER INC. All Rights Reserved.

No part of this manual, including the products and software described in it, may be reproduced, transmitted, transcribed, stored in a retrieval system, or translated into any language in any form or by any means, except documentation kept by the purchaser for backup purposes, without the express written permission of ASUSTeK COMPUTER INC. ("ASUS").

Product warranty or service will not be extended if: (1) the product is repaired, modified or altered, unless such repair, modification or alteration is authorized in writing by ASUS; or (2) the serial number of the product is defaced or missing.

ASUS PROVIDES THIS MANUAL "AS IS" WITHOUT WARRANTY OF ANY KIND, EITHER EXPRESS OR IMPLIED, INCLUDING BUT NOT LIMITED TO THE IMPLIED WARRANTIES OR CONDITIONS OF MERCHANTABILITY OR FITNESS FOR A PARTICULAR PURPOSE. IN NO EVENT SHALL ASUS, ITS DIRECTORS, OFFICERS, EMPLOYEES OR AGENTS BE LIABLE FOR ANY INDIRECT, SPECIAL, INCIDENTAL, OR CONSEQUENTIAL DAMAGES (INCLUDING DAMAGES FOR LOSS OF PROFITS, LOSS OF BUSINESS, LOSS OF USE OR DATA, INTERRUPTION OF BUSINESS AND THE LIKE), EVEN IF ASUS HAS BEEN ADVISED OF THE POSSIBILITY OF SUCH DAMAGES ARISING FROM ANY DEFECT OR ERROR IN THIS MANUAL OR PRODUCT.

SPECIFICATIONS AND INFORMATION CONTAINED IN THIS MANUAL ARE FURNISHED FOR INFORMATIONAL USE ONLY, AND ARE SUBJECT TO CHANGE AT ANY TIME WITHOUT NOTICE, AND SHOULD NOT BE CONSTRUED AS A COMMITMENT BY ASUS. ASUS ASSUMES NO RESPONSIBILITY OR LIABILITY FOR ANY ERRORS OR INACCURACIES THAT MAY APPEAR IN THIS MANUAL, INCLUDING THE PRODUCTS AND SOFTWARE DESCRIBED IN IT.

Products and corporate names appearing in this manual may or may not be registered trademarks or copyrights of their respective companies, and are used only for identification or explanation and to the owners' benefit, without intent to infringe.

Table of contents

Notices	vi
Safety information	vii
About this guide.....	viii
System package contents.....	x

Chapter 1: System Introduction

1.1 Welcome!	1-2
1.2 Front panel	1-2
1.3 Rear panel.....	1-4
1.4 Internal components.....	1-6

Chapter 2: Basic Installation

2.1 Preparation	2-2
2.2 Before you proceed	2-2
2.3 Removing the side cover	2-3
2.4 Removing the front panel cover	2-4
2.5 Removing the storage drive assembly.....	2-4
2.6 Removing the CPU fan and heatsink	2-5
2.7 Central Processing Unit (CPU)	2-6
2.7.1 Overview	2-6
2.7.2 Installing CPU	2-6
2.7.3 Installing the heatsink and fan	2-8
2.8 Installing a DIMM	2-8
2.8.1 Memory configurations	2-8
2.8.2 Installing a DDR2 DIMM	2-11
2.8.3 Removing a DDR2 DIMM	2-11
2.9 Expansion slots	2-12
2.9.1 PCI slots	2-12
2.9.2 Installing an expansion card	2-12
2.10 Installing an optical drive	2-14
2.11 Reinstalling the storage drive assembly	2-15
2.12 Installing the foot stand	2-16
2.13 Reinstalling the front panel cover and the cover.....	2-16

Table of contents

Chapter 3: Starting up

3.1	Installing an operating system.....	3-2
3.2	Powering up	3-2
3.3	Support CD information	3-2
3.3.1	Running the support CD.....	3-3
3.3.2	Utilities menu	3-4
3.3.3	ASUS contact information	3-5
3.4	Software information.....	3-5
3.4.1	ASUS PC Probe II.....	3-5
3.4.2	DTS function.....	3-12

Chapter 4: Motherboard Info

4.1	Introduction	4-2
4.2	Motherboard layout	4-2
4.3	Jumpers	4-3
4.4	Connectors	4-5

Chapter 5: BIOS Information

5.1	Managing and updating your BIOS	5-2
5.1.1	ASUS Update utility	5-2
5.1.2	Creating a bootable floppy disk	5-5
5.1.3	ASUS EZ Flash utility	5-5
5.1.4	AwardBIOS Flash utility	5-7
5.1.5	Saving the current BIOS file	5-9
5.1.6	ASUS CrashFree BIOS utility.....	5-10
5.2	BIOS setup program.....	5-11
5.2.1	BIOS menu screen.....	5-12
5.2.2	Menu bar	5-12
5.2.3	Navigation keys.....	5-13
5.2.4	Menu items	5-13
5.2.5	Sub-menu items.....	5-13
5.2.6	Configuration fields.....	5-13
5.2.7	Pop-up window.....	5-14
5.2.8	General help	5-14

Table of contents

5.3	Main menu.....	5-15
5.3.1	System Time	5-15
5.3.2	System Date	5-15
5.3.3	Primary IDE Master/Slave.....	5-16
5.3.4	First/Second SATA Master	5-18
5.3.5	HDD SMART Monitoring.....	5-19
5.3.6	Installed Memory	5-19
5.3.7	Usable Memory.....	5-19
5.4	Advanced menu	5-20
5.4.1	CPU Configuration	5-17
5.4.2	Chipset.....	5-21
5.4.3	PCIPnP	5-22
5.4.4	Onboard Devices Configuration.....	5-23
5.5	Power menu	5-26
5.5.1	ACPI Suspend Type	5-26
5.5.2	ACPI APIC Support	5-26
5.5.3	APM Configuration	5-27
5.5.4	Hardware Monitor.....	5-29
5.6	Boot menu	5-31
5.6.1	Boot Device Priority	5-31
5.6.2	Hard Disk Drive	5-31
5.6.3	Boot Settings Configuration	5-32
5.6.4	Security.....	5-33
5.7	Exit menu.....	5-34

Notices

Federal Communications Commission Statement

This device complies with Part 15 of the FCC Rules. Operation is subject to the following two conditions:

- This device may not cause harmful interference, and
- This device must accept any interference received including interference that may cause undesired operation.

This equipment has been tested and found to comply with the limits for a Class B digital device, pursuant to Part 15 of the FCC Rules. These limits are designed to provide reasonable protection against harmful interference in a residential installation. This equipment generates, uses and can radiate radio frequency energy and, if not installed and used in accordance with manufacturer's instructions, may cause harmful interference to radio communications. However, there is no guarantee that interference will not occur in a particular installation. If this equipment does cause harmful interference to radio or television reception, which can be determined by turning the equipment off and on, the user is encouraged to try to correct the interference by one or more of the following measures:

- Reorient or relocate the receiving antenna.
- Increase the separation between the equipment and receiver.
- Connect the equipment to an outlet on a circuit different from that to which the receiver is connected.
- Consult the dealer or an experienced radio/TV technician for help.



WARNING! The use of shielded cables for connection of the monitor to the graphics card is required to assure compliance with FCC regulations. Changes or modifications to this unit not expressly approved by the party responsible for compliance could void the user's authority to operate this equipment.

Canadian Department of Communications Statement

This digital apparatus does not exceed the Class B limits for radio noise emissions from digital apparatus set out in the Radio Interference Regulations of the Canadian Department of Communications.

This class B digital apparatus complies with Canadian ICES-003.

Safety information

Electrical safety

- To prevent electrical shock hazard, disconnect the power cable from the electrical outlet before relocating the system.
- When adding or removing devices to or from the system, ensure that the power cables for the devices are unplugged before the signal cables are connected.
- If the power supply is broken, do not try to fix it by yourself. Contact a qualified service technician or your retailer.

Operation safety

- Before installing devices into the system, carefully read all the documentation that came with the package.
- Before using the product, make sure all cables are correctly connected and the power cables are not damaged. If you detect any damage, contact your dealer immediately.
- To avoid short circuits, keep paper clips, screws, and staples away from connectors, slots, sockets and circuitry.
- Avoid dust, humidity, and temperature extremes. Do not place the product in any area where it may become wet. Place the product on a stable surface.
- If you encounter technical problems with the product, contact a qualified service technician or your retailer.

Lithium-Ion Battery Warning

CAUTION: Danger of explosion if battery is incorrectly replaced. Replace only with the same or equivalent type recommended by the manufacturer. Dispose of used batteries according to the manufacturer's instructions.

VORSICHT: Explosionsgefahr bei unsachgemäßen Austausch der Batterie. Ersatz nur durch denselben oder einem vom Hersteller empfohlenem ähnlichen Typ. Entsorgung gebrauchter Batterien nach Angaben des Herstellers.

LASER PRODUCT WARNING

CLASS 1 LASER PRODUCT

About this guide

Audience

This guide provides general information and installation instructions about the ASUS Pundit P1 - AH2 barebone system. This guide is intended for experienced users and integrators with hardware knowledge of personal computers.

How this guide is organized

This guide contains the following parts:

1. Chapter 1: System introduction

This chapter gives a general description of the ASUS Pundit P1 - AH2. The chapter lists the system features, including introduction on the front and rear panel, and internal components.

2. Chapter 2: Basic installation

This chapter provides step-by-step instructions on how to install components in the system.

3. Chapter 3: Starting up

This chapter helps you power up the system and install drivers and utilities from the support CD.

4. Chapter 4: Motherboard information

This chapter gives information about the motherboard that comes with the system. This chapter includes the motherboard layout, jumper settings, and connector locations.

5. Chapter 5: BIOS information

This chapter tells how to change system settings through the BIOS Setup menus and describes the BIOS parameters.

Conventions used in this guide



WARNING: Information to prevent injury to yourself when trying to complete a task.



CAUTION: Information to prevent damage to the components when trying to complete a task.



IMPORTANT: Instructions that you **MUST** follow to complete a task.



NOTE: Tips and additional information to aid in completing a task.

Where to find more information

Refer to the following sources for additional information and for product and software updates.

1. ASUS Websites

The ASUS websites worldwide provide updated information on ASUS hardware and software products. Refer to the ASUS contact information.

2. Optional Documentation

Your product package may include optional documentation, such as warranty flyers, that may have been added by your dealer. These documents are not part of the standard package.

System package contents

Check your Pundit P1 - AH2 system package for the following items.



If any of the items is damaged or missing, contact your retailer immediately.

Item description
1. ASUS Pundit P1 - AH2 barebone system with
• ASUS motherboard
• CPU fan and heatsink assembly
• CompactFlash card reader
• 3-in-1 storage card reader
• PCI riser card
• 250W power supply unit
2. Cable
• Power cable and plug
• Serial ATA power cable and signal cable
• IDE cable
3. CDs
• Support CD
• Recover PRO CD
4. Quick installation Guide

Chapter 1

This chapter gives a general description of the ASUS Pundit P1-AH2. The chapter lists the system features including introduction on the front and rear panel, and internal components.



ASUS Pundit P1-AH2

System introduction

1.1 Welcome!

Thank you for choosing the ASUS Pundit P1-AH2!

The ASUS Pundit P1-AH2 is an all-in-one barebone system with a versatile home entertainment feature.

The system comes in a stylish casing and powered by the ASUS motherboard that supports the AMD® Athlon64, AMD® Athlon 64 FX, AMD® Sempron, or AMD® Athlon 64 X2 processor.

The system supports up to 2 GB of system memory using DDR2-800/667/533/400 DIMMs, high-resolution graphics via integrated graphics controller, Serial ATA, USB 2.0, and 6-channel audio.

1.2 Front panel

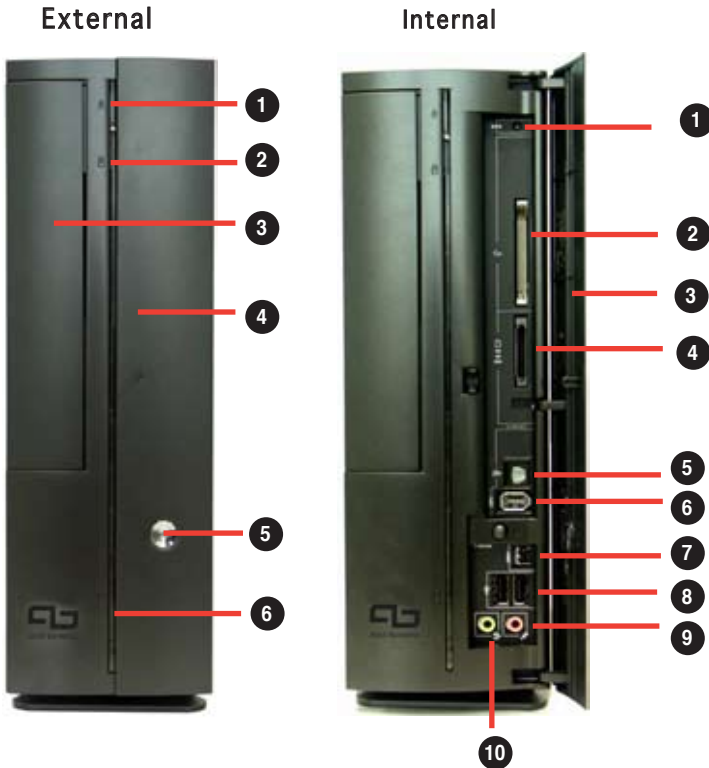

External

1. Optical drive eject button
2. HDD LED
3. Optical drive bay cover
4. Press to open the front panel cover
5. Power button
6. Power LED

Internal

1. Reset button.
2. CompactFlash card slot.
3. Front panel cover.
4. 3-in-1 card reader.
5. S/PDIF Out port.
6. 6-pin IEEE 1394 port.
7. 4-pin IEEE 1394 port.
8. USB 2.0 ports.
9. Microphone port.
10. Headphone port.

1.3 Rear panel

The system rear panel includes the power connector and several I/O ports that allow convenient connection of devices.

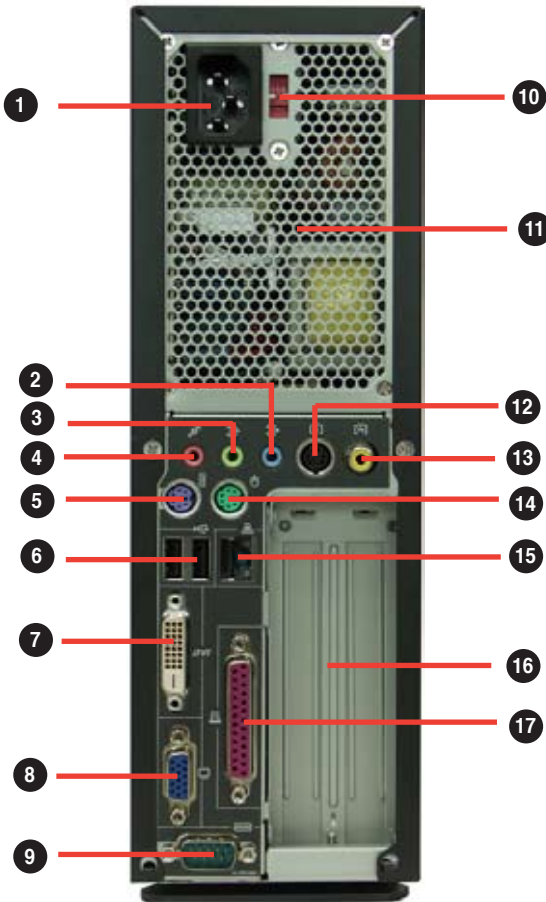

1. Power connector.
2. Line In port.
3. Line Out port.
4. Microphone port.
5. PS/2 keyboard port.

6. USB 2.0 ports.
7. DVI-D Out port.
8. VGA port.
9. Serial port.
10. Voltage selector
11. Power supply air vents.
12. S-Video Out port.
13. TV Out port.
14. PS/2 mouse port.
15. LAN (RJ-45) port.
16. PCI slot mental brackets.
17. Parallel port.



The system's power supply unit has a 115 V/230 V voltage selector switch located near the power connector. Use this switch to select the correct system input voltage according to the voltage supply in your area.



Refer to the audio configuration table below for the function of the audio ports in 2, 4, or 6-channel configuration.

Audio 2, 4, or 6-channel configuration

Port	Headset 2-speaker	4-speaker	6-speaker
Light Blue	Line In	Surround Out	Surround Out
Lime	Line Out	Front Speaker Out	Front Speaker Out
Pink	Mic In	Mic	Center/Bass

1.4 Internal components

The illustration below is the internal view of the system when you remove the top cover and the power supply unit. The installed components are labeled for your reference. Proceed to Chapter 2 for instructions on installing additional system components.



- | | |
|---|----------------------------------|
| 1. 5.25-inch optical drive and 3.5 inch hard disk drive cage | 5. ASUS motherboard |
| 2. Front panel cover | 6. DIMM sockets |
| 3. Power supply unit | 7. CPU socket |
| 4. PCI card riser bracket (connected to the motherboard PCI slot) | 8. CPU fan and heatsink assembly |

Chapter 2

This chapter provides step-by-step instructions on how to install components in the system.



Basic installation

2.1 Preparation

Before you proceed, make sure that you have all the components you plan to install in the system.

Basic components to install

1. Central Processing Unit (CPU)
2. DDR2 Dual Inline Memory Module (DIMM)
3. Expansion card(s)
4. Hard disk drive
5. Optical drive

Tool

Phillips (cross) screw driver

2.2 Before you proceed

Take note of the following precautions before you install components into the system.



- Use a grounded wrist strap or touch a safely grounded object or a metal object, such as the power supply case, before handling components to avoid damaging them due to static electricity.
- Hold components by the edges to avoid touching the ICs on them.
- Whenever you uninstall any component, place it on a grounded antistatic pad or in the bag that came with the component.

The motherboard comes with an onboard standby power LED. This LED lights up to indicate that the system is ON, in sleep mode or in soft-off mode, and not powered OFF. Unplug the power cable from the power outlet and make sure that the standby power LED is OFF before installing any system component.

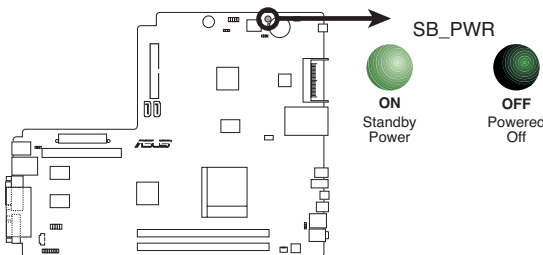

Onboard LED

2.3 Removing the side cover

1. Remove the cover screws.
Keep the screws for later use.



2. Pull the cover slightly toward the rear panel.



3. Lift the cover, then set aside.



2.4 Removing the front panel cover

1. Lift the front panel cover hooks outward.
2. Carefully remove the front panel cover, then set it aside.



2.5 Removing the storage drive assembly

1. Lay the system on its side, then locate and remove three storage drive assembly screws.
2. Lift the storage drive assembly, then set aside.



2.6 Removing the CPU fan and heatsink

1. Disconnect the CPU fan cable.
2. Remove two screws securing the blower to the CPU fan. Set the blower aside.

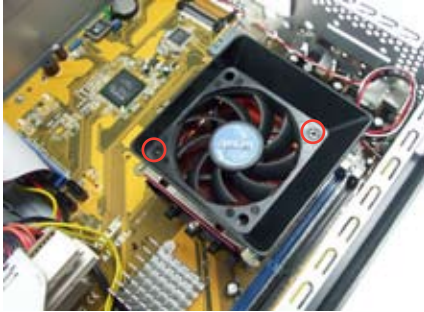

3. Unhook and slide out the metal clips that secure the fan and heatsink assembly to the retention module.



4. Lift the CPU fan and heatsink assembly, then set aside.

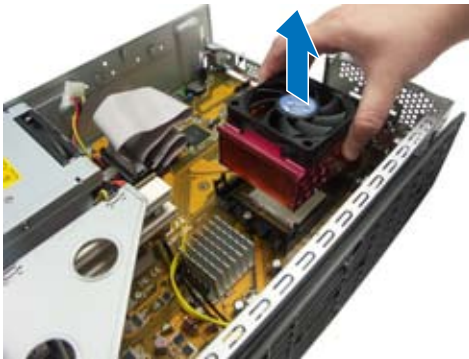

2.7 Central Processing Unit (CPU)

2.7.1 Overview

The motherboard comes with a 940-pin AM2 socket designed for the AMD Athlon™ 64 X2/Athlon™ 64/Sempron™ processor.



The AM2 socket has a different pinout from the 940-pin socket designed for the AMD Opteron™ processor. Make sure you use a CPU that is designed for the AM2 socket. The CPU fits in only one correct orientation. DO NOT force the CPU into the socket to prevent bending the pins the CPU!

2.7.2 Installing CPU

To install a CPU:

1. Locate the CPU socket on the motherboard.

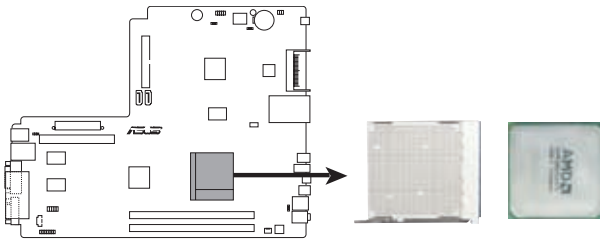

CPU Socket AM2

2. Unlock the socket by pressing the lever sideways, then lift it up to a 90° angle.



Make sure that the socket lever is lifted up to a 90° angle; otherwise, the CPU will not fit in completely.

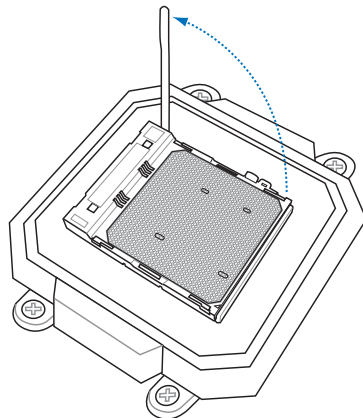

3. Position the CPU above the socket such that the CPU corner with the gold triangle matches the socket corner with a small triangle.
4. Carefully insert the CPU into the socket until it fits in place.

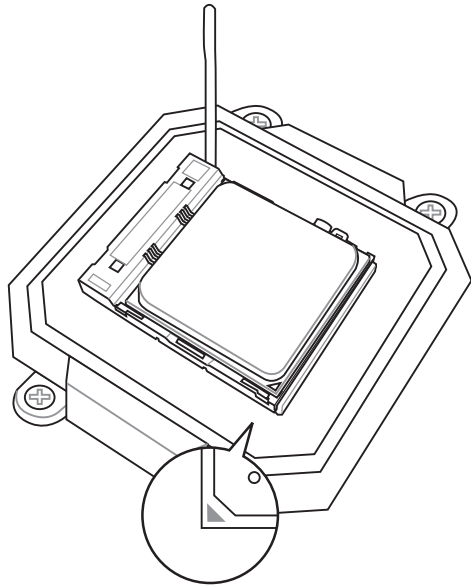

5. When the CPU is in place, push down the socket lever to secure the CPU. The lever clicks on the side tab to indicate that it is locked.
6. Install a CPU heatsink and fan following the instructions that came with the heatsink package.

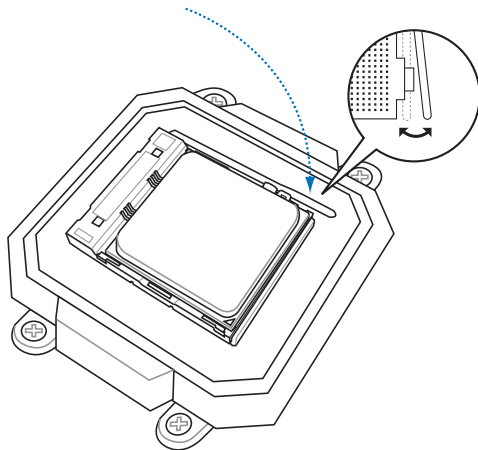

2.7.3 Installing the heatsink and fan

The AMD Athlon™ 64/AMD Athlon™ 64 X2/ AMD Sempron™ processor requires a specially designed heatsink and fan assembly to ensure optimum thermal condition and performance.

Follow these steps to install the CPU heatsink and fan.

1. Place the heatsink on top of the installed CPU, making sure that the heatsink fits properly on the retention module base.



- The retention module base is already installed on the motherboard upon purchase.
- You do not have to remove the retention module base when installing the CPU or installing other motherboard components.

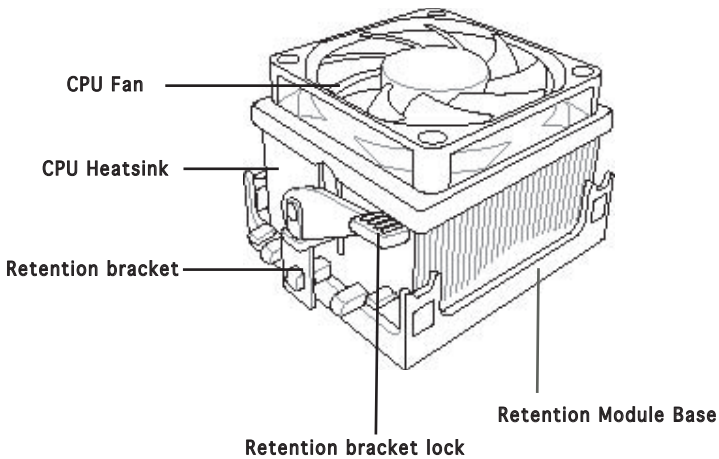

2. Attach one end of the retention bracket to the retention module base.

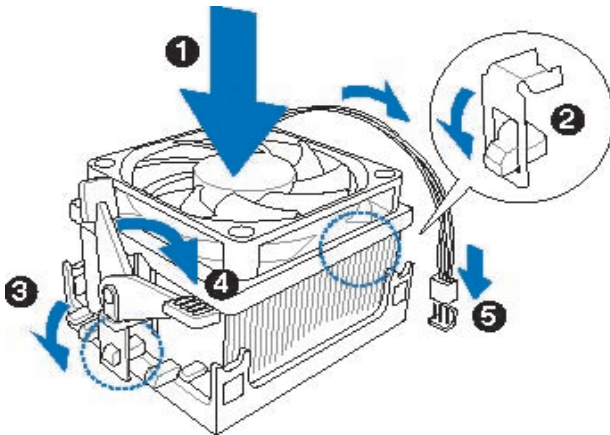

3. Align the other end of the retention bracket (near the retention bracket lock) to the retention module base. A clicking sound denotes that the retention bracket is in place.



Make sure that the fan and heatsink assembly perfectly fits the retention mechanism module base, otherwise you cannot snap the retention bracket in place.

4. Push down the retention bracket lock on the retention mechanism to secure the heatsink and fan to the module base.
5. When the fan and heatsink assembly is in place, connect the CPU fan cable to the connector on the motherboard labeled CPU_FAN.



Do not forget to connect the CPU fan connector! Hardware monitoring errors can occur if you fail to plug this connector.

2.8 Installing a DIMM

The system motherboard comes with two Double Data Rate 2 (DDR2) Dual Inline Memory Module (DIMM) sockets.

The following figure illustrates the location of the sockets:

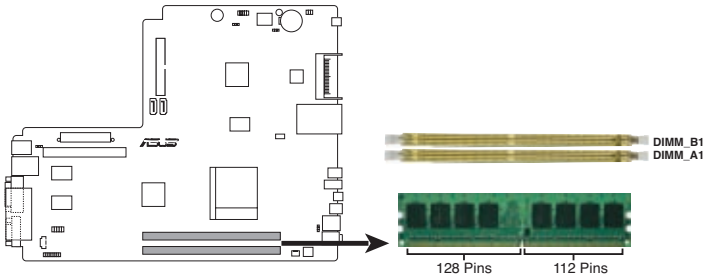

240-pin DDR2 DIMM Sockets

2.8.1 Memory configurations

You may install up to 2 GB system memory using 256 MB, 512 MB, and 1 GB DDR2 DIMMs.



- Install only **identical** (the same type and size) DDR2 memory modules.
- Install only ASUS-certified memory modules. Refer to the DDR2 Qualified Vendors List on the next page for details. Visit the ASUS website for the latest DDR2 QVL.
- Always install DIMMs with the same CAS latency. For optimum compatibility, we recommend that you obtain memory modules from the same vendor.

Qualified Vendors Lists (QVL)

DDR2-800

Size	Vendor	Component	Side(s)	Model	DIMM Support	
					A	B
512MB	KINGSTON	K4T51083QC	SS	KVR800D2N5/512	V	V
1024MB	KINGSTON	K4T51083QC	DS	KVR800D2N5/1G	V	V
512MB	SAMSUNG	EDD339XX	SS	M378T6553CZ3-CE7	V	V
256MB	SAMSUNG	K4T51163QC-ZCE7	SS	M378T3354CZ3-CE7	V	V
512MB	Qimonda	HYB18T256800AF25F	DS	HYS64T64020HU-25F-A	V	V
512MB	Hynix	HY5PS12821BFP-S5	SS	HYMP564U64BP8-S5	V	V
1024MB	Hynix	HY5PS12821BFP-S5	DS	HYMP512U64BP8-S5	V	V
512MB	MICRON	5JAIJ9DQQ	SS	MT8HTF6464AY-80EA3	V	V
1024MB	MICRON	5JAIJ9DQQ	DS	MT16HTF12864AY-80EA3	V	V
512MB	MICRON	5ZD22D9GKX	SS	MT8HTF6464AY-80ED4	V	V
1024MB	MICRON	5ZD22D9GKX	DS	MT16HTF12864AY-80ED4	V	V
512MB	MICRON	6CD22D9GKX	SS	MT8HTF6464AY-80ED4	V	V
1024MB	MICRON	6CD22D9GKX	DS	MT16HTF12864AY-80ED4	V	V
512MB	CORSAIR	Heat-Sink Package	SS	CM2X512A-6400	V	V
1024MB	CORSAIR	Heat-Sink Package	DS	CM2X1024-6400C4	V	V
512MB	A-DATA	N/A	SS	M20AD6G3H3160J1E52	V	V
512MB	A-DATA	AD29608A8A-25EG	SS	M20AD6G3H3160J1E5E	V	V
1024MB	Crucial	Heat-Sink Package	DS	BL12864AA804.16FD	V	V
256MB	Apacer	E2508AB-GE-E	SS	78.81091.420	V	V
512MB	Apacer	E2508AB-GE-E	DS	78.91091.420	V	V
256MB	TwinMOS	E2508AB-GE-E	SS	8G-24IK2-EBT	V	V

DDR2-667

Size	Vendor	Component	Side(s)	Model	DIMM Support	
					A	B
512MB	KINGSTON	E5108AE-6E-E	SS	KVR667D2N5/512	V	V
1024MB	KINGSTON	E5108AE-6E-E	DS	KVR667D2N5/1G	V	V
512MB	KINGSTON	E5108AE-6E-E	SS	KVR667D2E5/512	V	V
256MB	KINGSTON	HYB18T256800AF3	SS	KVR667D2N5/256	V	V
256MB	SAMSUNG	K4T51163QC-ZCE6	SS	M378T3354CZ0-CE6	V	V
512MB	SAMSUNG	ZCE6K4T51083QC	SS	M378T6553CZ0-CE6	V	V
1024MB	SAMSUNG	ZCE6K4T51083QC	DS	M378T2953CZ0-CE6	V	V
256MB	Qimonda	HYB18T512160AF-3S	SS	HYS64T32000HU-3S-A	V	V
512MB	Qimonda	HYB18T512800AF3S	SS	HYS64T64000HU-3S-A	V	V
1024MB	Qimonda	HYB18T512800AF3S	DS	HYS64T128020HU-3S-A	V	V
256MB	Qimonda	HYB18T512160BF-3S	SS	HYS64T32000HU-3S-B	V	V
512MB	Qimonda	HYB18T512800BF3S	SS	HYS64T64000HU-3S-B	V	V
1024MB	Qimonda	HYB18T512800BF3S	DS	HYS64T128020HU-3S-B	V	V
256MB	ELPIDA	E2508AB-6E-E	SS	EBE25UC8ABFA-6E-E	V	V
512MB	ELPIDA	E5108AE-6E-E	SS	EBE51UD8AEFA-6E-E	V	V
512MB	A-DATA	AD29608A8B-3EG	SS	M20AD5Q3H3163J1C52	V	V
512MB	Transcend	E5108AE-6E-E	SS	TS64MLQ64V6J	V	V
1024MB	Transcend	E5108AE-6E-E	DS	TS128MLQ64V6J	V	V

DDR2-533

Size	Vendor	Component	Side(s)	Model	DIMM Support	
					A	B
256MB	KINGSTON	E5116AF-5C-E	SS	KVR533D2N4/256	V	V
512MB	KINGSTON	HYB18T512800AF37	SS	KVR533D2N4/512	V	V
1024MB	KINGSTON	5YDID9GCT	DS	KVR533D2N4/1G	V	V
512MB	Infineon	HYB18T512800AC37	SS	HYS64T64000GU-3.7-A	V	V
256MB	Infineon	HYB18T512160AF-3.7	SS	HYS64T32000HU-3.7-A	V	V
512MB	Infineon	HYB18T512800AF37	SS	HYS64T64000HU-3.7-A	V	V
1024MB	Infineon	HYB18T512800AF37	DS	HYS64T128020HU-3.7-A	V	V
2048MB	Infineon	HYB18T1G800AF-3.7	DS	HYS64T256020HU-3.7-A	V	V
256MB	Infineon	HYB18T5121608BF-3.7	SS	HYS64T32000HU-3.7-B	V	V
512MB	Infineon	HYB18T512800BF37	SS	HYS64T64000HU-3.7-B	V	V
1024MB	Infineon	HYB18T512800BF37	DS	HYS64T128020HU-3.7-B	V	V
512MB	Hynix	HY5PS12821F-C4	S	HYMP564U648-C4	V	V
1024MB	Hynix	HY5PS12821F-C4	DS	HYMP512U648-C4	V	V
1024MB	Hynix	HY5PS12821FP-C4	DS	HYMP512U648-C4	V	V
512MB	Hynix	HY5PS12821AFP-C3	SS	HYMP564U64AP8-C3	V	V
1024MB	Hynix	HY5PS12821AFP-C3	DS	HYMP512U64AP8-C3	V	V
512MB	ELPIDA	E5108AB-5C-E	SS	EBE51UD8ABFA-5C	V	V
512MB	ELPIDA	E5108AB-5C-E	SS	EBE51UD8ABFA-5C-E	V	V
1024MB	ELPIDA	E5108AB-5C-E	DS	EBE11UD8ABFA-5C-E	V	V
2048MB	ELPIDA	E1108AA-5C-E	DS	EBE21EE8AAFA-5C-E	V	
256MB	CORSAIR	MII0051832M8CEC	SS	VS256MBS33D2		V
512MB	CORSAIR	M110052432M8CEC	DS	VS512MBS33D2	V	V
256MB	Apacer	E5116AB-5C-E	SS	78.81077.420	V	V
256MB	KINGMAX	E5116AB-5C-E	SS	KLBB68F-36EP4	V	V
512MB	KINGMAX	E5108AE-5C-E	SS	KLBC28F-A8EB4	V	V
1024MB	KINGMAX	E5108AE-5C-E	DS	KLBD48F-A8EB4	V	V
512MB	KINGMAX	KKEA88E4AAK-37	SS	KLBC28F-A8KE4	V	V
1024MB	KINGMAX	5MB22D9DCN	DS	KLBD48F-A8ME4	V	V
512MB	Transcend	K4T51083QB-GCD5	SS	TS64MLQ64V5J	V	V
1024MB	Transcend	K4T51083QB-GCD5	DS	TS128MLQ64V5J	V	V

Side(s): SS - Single-sided

DS - Double-sided

CL: CAS Latency

DIMM support:

A -Supports one module inserted into either slot, in Single-channel memory configuration.

B -Supports one pair of modules inserted into both slots as one pair of Dual-channel memory configuration.

2.8.2 Installing a DDR2 DIMM



Make sure to unplug the power supply before adding or removing DIMMs or other system components. Failure to do so may cause severe damage to both the motherboard and the components.

1. Unlock a DDR2 DIMM socket by pressing the retaining clips outward.
2. Align a DIMM on the socket such that the notch on the DIMM matches the break on the socket.

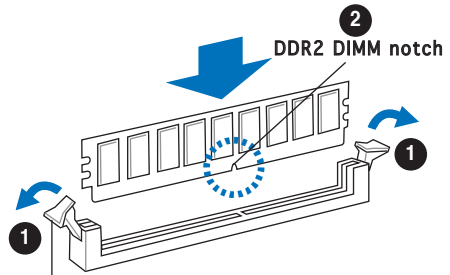

Unlocked retaining clip



A DDR2 DIMM is keyed with a notch so that it fits in only one direction. DO NOT force a DIMM into a socket to avoid damaging the DIMM.

3. Firmly insert the DIMM into the socket until the retaining clips snap back in place and the DIMM is properly seated.

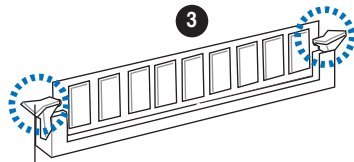

Locked Retaining Clip

2.8.3 Removing a DDR2 DIMM

Follow these steps to remove a DIMM.

1. Simultaneously press the retaining clips outward to unlock the DIMM.

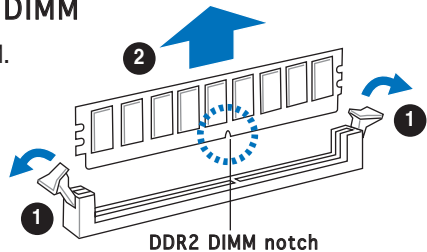

Support the DIMM lightly with your fingers when pressing the retaining clips. The DIMM might get damaged when it flips out with extra force.

2. Remove the DIMM from the socket.

2.9 Expansion slots

In the future, you may need to install expansion cards. The following sub-sections describe the slots and the expansion cards that they support.



Make sure to unplug the power cord before adding or removing expansion cards. Failure to do so may cause you physical injury and damage motherboard components.

2.9.1 PCI slots

This system has two PCI slot that supports cards such as a LAN card, SCSI card, USB card, and other cards that comply with PCI specifications.

2.9.2 Installing an expansion card

1. Lift the PCI riser card assembly.



2. Remove the metal cover opposite the slot that you intend to use.



3. Insert the card connector to the slot, then press the card firmly until it fits in place. Secure the card with a screw.



4. Reinstall the PCI riser card assembly. Make sure that the riser card connector sits properly on the motherboard PCI slot.



2.10 Installing an optical drive

Follow these steps to install an optical drive:

1. Turn the storage drive assembly upside down with the 3.5-inch bay on top of the 5.25-inch bay.
2. Insert the optical drive upside down to the 5.25-inch bay, then secure it with two screws on both sides.



3. Turn the storage drive assembly, insert the hard disk drive upside down to the 3.5-inch bay, then secure it with two screws on both sides.



2.11 Reinstalling the storage drive assembly

Before reinstalling the storage drive assembly, connect the IDE / SATA and power plugs to the IDE / SATA and power connectors at the back of the drives.

1. Connect the black plug of the IDE cable to the optical drive, then the gray plug to the hard disk drive. If you have the SATA HDD, connect the SATA cable to the SATA HD.
2. Connect the 4-pin power plugs to the power connectors at the back of the drives.
3. Install the storage drive assembly to the chassis.



4. Secure the storage drive assembly with three screws.



2.12 Installing the foot stand

1. Match the foot stand hooks to the holes on the chassis.



2. Pull the foot stand to the direction of the arrow until the lock clicks in place.



To remove the foot stand, lift the lock, then slightly push the foot stand to the direction of the rear panel until it disengages from the chassis.

2.13 Reinstalling the front panel cover and the cover

Refer to the section of Removing the front panel cover and follow the instructions in reverse.

Refer to the section of Removing the cover and follow the instructions in reverse.

Chapter 3

This chapter helps you power up the system and install drivers and utilities from the support CD.



ASUS Pundit P1-AH2

Starting up

3.1 Installing an operating system

The barebone system supports Windows® 2000/XP operating systems (OS). Always install the latest OS version and corresponding updates so you can maximize the features of your hardware.



Because motherboard settings and hardware options vary, use the setup procedures presented in this chapter for general reference only. Refer to your OS documentation for more information.

3.2 Powering up

Press the system power button (⏻) to enter the OS.



3.3 Support CD information

The support CD that came with the system contains useful software and several utility drivers that enhance the system features.



- Screen display and driver options may not be the same for different operating system versions.
 - The contents of the support CD are subject to change at any time without notice. Visit the ASUS website for updates.
-

3.3.1 Running the support CD

To begin using the support CD, place the CD in your optical drive. The CD automatically displays the **Drivers** menu if Autorun is enabled in your computer.



Click an icon to display support CD/motherboard information

Click an item to install



If **Autorun** is NOT enabled in your computer, browse the contents of the support CD to locate the file **ASSETUP.EXE** from the BIN folder. Double-click the **ASSETUP.EXE** to run the CD.

AMD Cool'n'Quiet Driver

Installs the AMD Cool'n'Quiet driver.

NVIDIA nForce Chipset Driver

Installs the NVIDIA nForce chipset driver.

NVIDIA GeForce 61X0 Display Driver

Installs the NVIDIA GeForce 61X0 display driver.

Realtek Audio Driver

Allows you to install the Realtek audio driver.

USB 2.0 Driver

Installs the USB 2.0 driver file that came with the utility for details.

3.3.2 Utilities menu

The Utilities menu shows the applications and other software that the motherboard supports.



ASUS PC Probe II

This smart utility monitors the fan speed, CPU temperature, and system voltages, and alerts you of any detected problems. This utility helps you keep your computer in healthy operating condition.

ASUS Update

The ASUS Update utility allows you to update the motherboard BIOS in a Windows® environment. This utility requires an Internet connection either through a network or an Internet Service Provider (ISP).

ASUS Cool'n'Quiet Utility

Installs the ASUS Cool'n'Quiet Utility.

ADOBE Acrobat Reader V7.0

Installs the Adobe® Acrobat® Reader V7.0 that allows you to open, view, and print documents in Portable Document Format (PDF).

ASUS Screen Saver

Installs the ASUS screen saver.

Microsoft DirectX 9.0c

Installs the Microsoft® DirectX 9.0c driver.

USB2.0 Card Reader Software

Installs the USB2.0 card reader software.

Anti-virus utility

The anti-virus application scans, identifies, and removes computer viruses. View the online help for detailed information.

3.3.3 ASUS Contact information

Click the **Contact** tab to display the ASUS contact information. You can also find this information on the inside front cover of this user guide.



3.4 Software information

Most of the applications in the support CD have wizards that will conveniently guide you through the installation. View the online help or readme file that came with the software for more information.

3.4.1 ASUS PC Probe II

PC Probe II is a utility that monitors the computer's vital components and alerts you of any problem with these components. PC Probe II senses fan rotations, CPU temperature, and system voltages, among others. PC Probe II is software-based, allowing you to start monitoring your computer the moment you turn it on. With this utility, you are assured that your computer is always at a healthy operating condition.

Installing PC Probe II

To install PC Probe II on your computer:

1. Place the support CD to the optical drive. The **Drivers** installation tab appears if your computer has an enabled Autorun feature.



If Autorun is not enabled in your computer, browse the contents of the support CD to locate the setup.exe file from the ASUS PC Probe II folder. Double-click the setup.exe file to start installation.

2. Click the **Utilities** tab, then click **ASUS PC Probe II**.
3. Follow the screen instructions to complete installation.

Launching PC Probe II

You can launch the PC Probe II right after installation or anytime from the Windows® desktop.

To launch the PC Probe II from the Windows® desktop, click **Start > All Programs > ASUS > PC Probe II**. The PC Probe II main window appears.

After launching the application, the PC Probe II icon appears in the Windows® taskbar. Click this icon to close or restore the application.









Using PC Probe II

Main window

The PC Probe II main window allows you to view the current status of your system and change the utility configuration. By default, the main window displays the **Preference** section. You can close or restore the **Preference** section by clicking on the triangle on the main window right handle.



Click to close the Preference panel

Button	Function
	Opens the Configuration window
	Opens the Report window
	Opens the Desktop Management Interface window
	Opens the Peripheral Component Interconnect window
	Opens the Windows Management Instrumentation window
	Opens the hard disk drive, memory, CPU usage window
	Shows/Hides the Preference section
	Minimizes the application
	Closes the application

Sensor alert

When a system sensor detects a problem, the main window right handle turns red, as the illustrations below show.

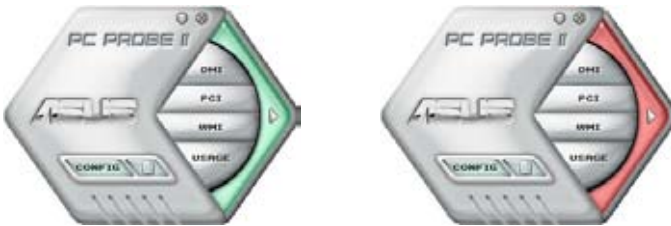

When displayed, the monitor panel for that sensor also turns red. Refer to the **Monitor panels** section for details.

Preferences

You can customize the application using the Preference section in the main window. Click the box before each preference to activate or deactivate.

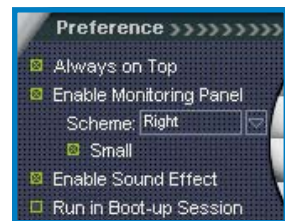

Hardware monitor panels

The hardware monitor panels display the current value of a system sensor such as fan rotation, CPU temperature, and voltages.

The hardware monitor panels come in two display modes: hexagonal (large) and rectangular (small). When you check the **Enable Monitoring Panel** option from the **Preference** section, the monitor panels appear on your computer's desktop.



Large display



Small display

Changing the monitor panels position

To change the position of the monitor panels on the desktop, click the arrow down button of the **Scheme** options, then select another position from the list box. Click **OK** when finished.



Moving the monitor panels

All monitor panels move together using a magnetic effect. If you want to detach a monitor panel from the group, click the horseshoe magnet icon. You can now move or reposition the panel independently.

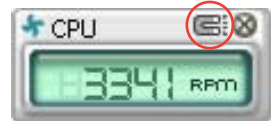

Adjusting the sensor threshold value

You can adjust the sensor threshold value in the monitor panel by clicking the arrow buttons. You can also adjust the threshold values using the **Config** window.

You cannot adjust the sensor threshold values in a small monitoring panel.

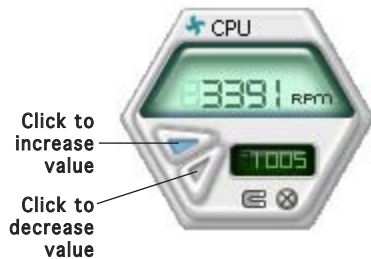

Monitoring sensor alert

The monitor panel turns red when a component value exceeds or is lower than the threshold value. Refer to the illustrations below.



Large display



Small display

WMI browser

Click **WMI** to display the WMI (Windows Management Instrumentation) browser. This browser displays various Windows® management information. Click an item from the left panel to display on the right panel. Click the plus sign (+) before **WMI Information** to display the available information.



You can enlarge or reduce the browser size by dragging the bottom right corner of the browser.

DMI browser

Click **DMI** to display the DMI (Desktop Management Interface) browser. This browser displays various desktop and system information. Click the plus sign (+) before **DMI Information** to display the available information.



PCI browser

Click **PCI** to display the PCI (Peripheral Component Interconnect) browser. This browser provides information on the PCI devices installed on your system. Click the plus sign (+) before the **PCI Information** item to display available information.

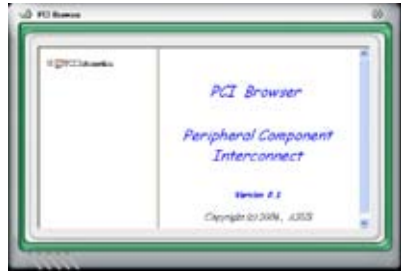

Usage

The **Usage** browser displays real-time information on the CPU, hard disk drive space, and memory usage. Click **USAGE** to display the Usage browser.

CPU usage

The **CPU** tab displays real-time CPU usage in line graph representation. If the CPU has an enabled Hyper-Threading, two separate line graphs display the operation of the two logical processors.



Hard disk drive space usage

The **Hard Disk** tab displays the used and available hard disk drive space. The left panel of the tab lists all logical drives. Click a hard disk drive to display the information on the right panel. The pie chart at the bottom of the window represents the used (blue) and the available HDD space.



Memory usage

The **Memory** tab shows both used and available physical memory. The pie chart at the bottom of the window represents the used (blue) and the available physical memory.



Configuring PC Probe II

Click **CONFIG** to view and adjust the sensor threshold values.

The **Config** window has two tabs: **Sensor/Threshold** and **Preference**. The **Sensor/Threshold** tab enables you to activate the sensors or to adjust the sensor threshold values. The **Preference** tab allows you to customize sensor alerts, change temperature scale, or enable the Q-Fan feature.*



Loads the default threshold values for each sensor

Applies your changes

Cancels or ignores your changes

Loads your saved configuration
 Saves your configuration

*Available on some motherboards only.

3.4.2 DTS function



Refer to the appendix of this section on page 3-15 for more information about DTS function.

DTS Connect is embedded in the audio drivers. After the driver installed, there is “Realtek HD Audio Manager” icon in the desktop manual bar (see figure below).



When click the icon or insert the device into the phone jack, the manager will pop out. You can click the dts Neo: PC and dts Interactive buttons to initiate those functions as shown below.

DTS NEO: PC



“DTS CONNECT”, “DTS INTERACTIVE” and “DTS NEO: PC” are trademark of DTS, Inc. “DTS” is a registered trademark of DTS, Inc.

DTS Interactive



When DTS Interactive is enabled, only digital audio output(S/PDIF) is working, and you will not hear sound from analog speaker or headphone.



“DTS CONNECT”, “DTS INTERACTIVE” and “DTS NEO: PC” are trademark of DTS,Inc. “DTS” is a registered trademark of DTS, Inc.

Detailed Settings



"DTS CONNECT", "DTS INTERACTIVE" and "DTS NEO: PC" are trademark of DTS, Inc. "DTS" is a registered trademark of DTS, Inc.

Appendix: DTS function



DTS connect

DTS Connect - Stereo is boring, surround sound is fun!

DTS Connect™ is the latest product from DTS that turns your PC into an action packed entertainment experience that surrounds you in sound.

DTS Connect includes DTS Neo:PC™ and DTS Interactive™ to bring new sound capabilities to your PC. DTS Neo:PC converts stereo sources into 7.1 multichannel sound, and DTS Interactive enables you to re-encode your multichannel sources into DTS 5.1 channel surround sound for playback through your home entertainment system.



DTS NEO: PC

DTS Neo:PC – Listen to your Stereo Movies and Music in exciting Surround Sound!

With DTS Neo:PC you can listen to all of your stereo movies and music in multichannel DTS surround sound. DTS Neo:PC expands conventional stereo sources (CD, MP3, WMA, even Internet FM radio) into as many as 7.1 channels of awesome surround sound.



DTS Interactive

DTS-Interactive: Encode your favorite movies, music or games in full DTS Digital Surround quality (1.5 Mbps, 48kHz).

DTS Interactive encodes any 5.1 channel audio source into full DTS Digital Surround and links your PC to your DTS capable home entertainment system. Best of all, your PC connects to your home entertainment system with a single digital cable for playback of your music, movies and games in DTS Digital Surround. It's the ultimate entertainment experience!

"DTS CONNECT", "DTS INTERACTIVE" and "DTS NEO: PC" are trademark of DTS, Inc. "DTS" is a registered trademark of DTS, Inc.

Chapter 4

This chapter gives information about the motherboard that comes with the system. This chapter includes the motherboard layout, jumper settings, and connector locations.



ASUS Pundit P1-AH2

4.1 Introduction

The Pundit P1-AH2 barebone system comes with an ASUS motherboard. This chapter provides technical information about the motherboard for future upgrades or system reconfiguration.

4.2 Motherboard layout

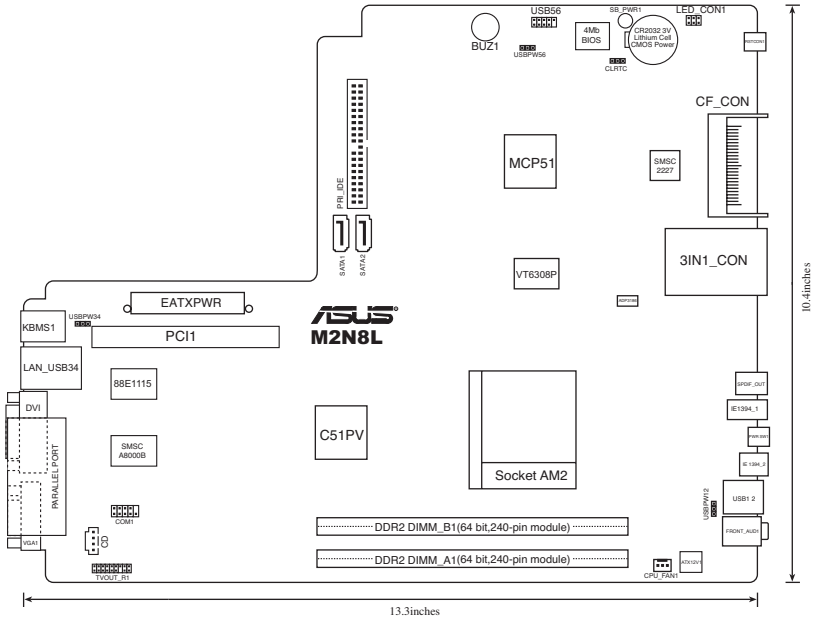

4.3 Jumpers

1. Clear RTC RAM (CLRTC)

This jumper allows you to clear the Real Time Clock (RTC) RAM in CMOS. You can clear the CMOS memory of date, time, and system setup parameters by erasing the CMOS RTC RAM data. The onboard button cell battery powers the RAM data in the CMOS, which includes the system setup information such as system passwords.

To erase the RTC RAM:

1. Turn OFF the computer and unplug the power cord.
2. Remove the battery.
3. Move the jumper cap from pins 1-2 (default) to pins 2-3. Keep the cap on pins 2-3 for about 5-10 seconds, then move the cap back to pins 1-2.
4. Re-install the battery.
5. Plug the power cord and turn ON the computer.
6. Hold down the key during the boot process and enter BIOS setup to re-enter data.

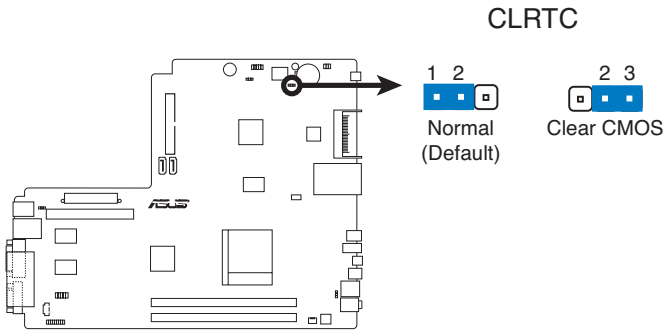

Clear RTC RAM



Except when clearing the RTC RAM, never remove the cap on CLRTC jumper default position. Removing the cap will cause system boot failure.

2. USB device wake-up (3-pin USBPW12, USBPW34, USBPW56)

Set these jumpers to +5V to wake up the computer from S1 sleep mode (CPU stopped, DRAM refreshed, system running in low power mode) using the connected USB devices. Set to +5VSB to wake up from S3 and S4 sleep modes (no power to CPU, DRAM in slow refresh, power supply in reduced power mode).

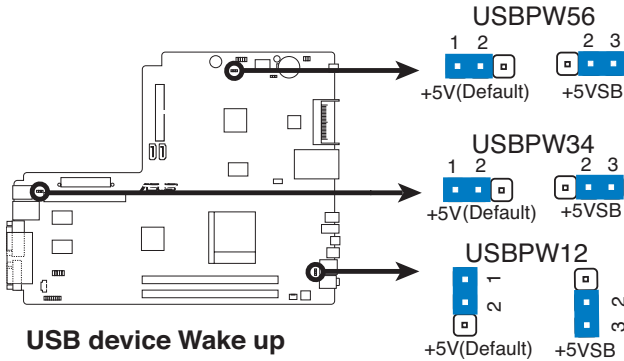

- The USB device wake-up feature requires a power supply that can provide 500mA on the +5VSB lead for each USB port; otherwise, the system would not power up.
- The total current consumed must NOT exceed the power supply capability (+5VSB) whether under normal condition or in sleep mode.

4.4 Connectors

1. Serial ATA connectors (7-pin SATA1, SATA2)

These connectors are for the Serial ATA signal cables for Serial ATA hard disk drives.



Important notes on Serial ATA

- Only Windows® 2000 Service Pack 4 / Windows® XP Service Pack 1 and above support Serial ATA hard disk drives.
- When using the connectors in **Standard IDE** mode, connect the primary (boot) hard disk drive to the SATA1 or SATA2 connector.

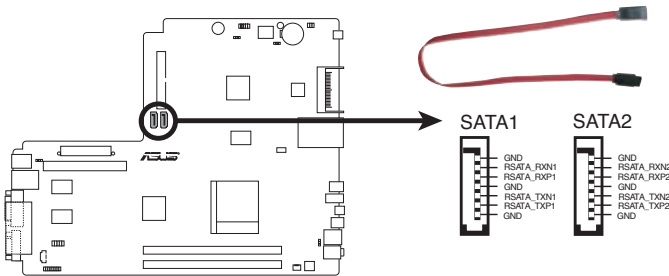

SATA Connectors

2. COM port connector (10-1pin COM1)

This connector is for a serial (COM) port. Connect the serial port module cable to this connector, then install the module to a slot opening at the back of the system chassis.

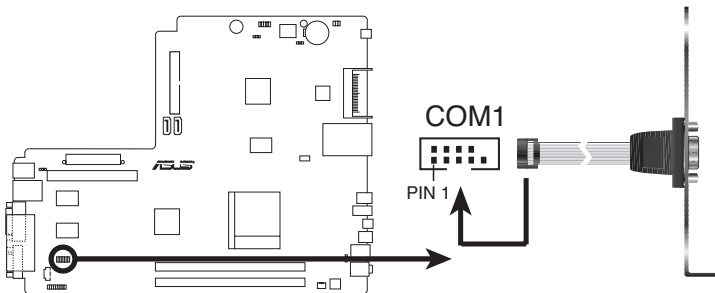

COM Port Connector

3 IDE connectors (40-1 pin PRI_IDE)

The onboard IDE connectors are for Ultra DMA 133/100/66 signal cable(s). There are three connectors on each Ultra DMA 133/100/66 signal cable: blue, black, and gray. Connect the blue connector to the motherboard's IDE connector, then select one of the following modes to configure your device(s).

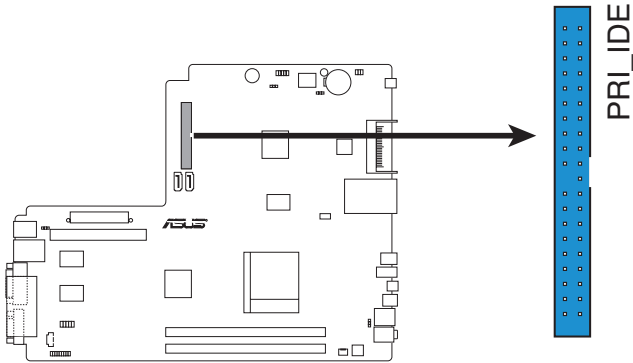

IDE Connector

	Drive jumper setting	Mode Cable of device(s)	Cable connector
Single device	Cable-Select or Master	-	Black
Two devices	Cable-Select	Master Slave	Black Gray
	Master Slave	Master Slave	Black or gray



- Pin 20 on the IDE connector is removed to match the covered hole on the Ultra DMA cable connector. This prevents incorrect insertion when you connect the IDE cable.
- Use the 80-conductor IDE cable for Ultra DMA 133/100/66 IDE devices.



If any device jumper is set as “Cable-Select”, make sure all other device jumpers have the same setting.

4. CPU Fan connectors (3-pin CPU_FAN)

The fan connectors support cooling fans of 350 mA~740 mA (8.88 W max.) or a total of 1 A~2.22 A (26.64 W max.) at +12V. Connect the fan cables to the fan connectors on the motherboard, making sure that the black wire of each cable matches the ground pin of the connector.

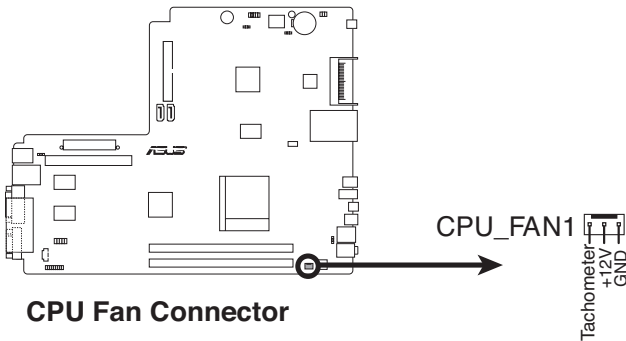

Do not forget to connect the fan cables to the fan connectors. Insufficient air flow inside the system may damage the motherboard components. These are not jumpers! Do not place jumper caps on the fan connectors!

5. USB connector (10-1 pin USB56)

These connectors are for USB 2.0 ports. Users can connect a USB/ GAME module cable to the connectors, then install the module to a slot opening at the back of the system chassis. These USB connectors comply with USB 2.0 specification that supports up to 480 Mbps connection speed.

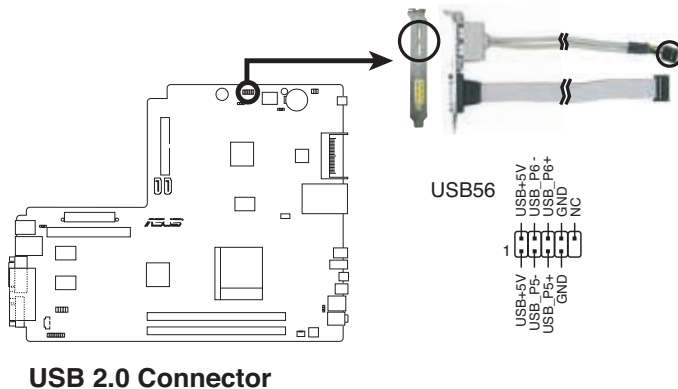

6. ATX power connectors (24-pin EATXPWR, 4-pin ATX12V)

These connectors are for ATX power supply plugs. The plugs from the power supply are designed to fit these connectors in only one orientation. Find the proper orientation and push down firmly until the connectors completely fit.

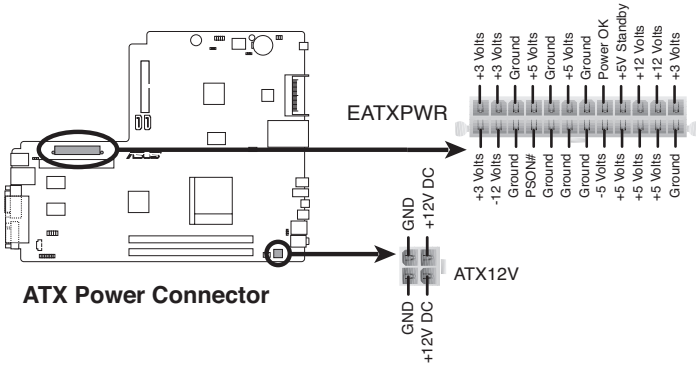

- Do not forget to connect the 4-pin ATX +12 V power plug; otherwise, the system will not boot.
- Use of a PSU with a higher power output is recommended when configuring a system with more power-consuming devices. The system may become unstable or may not boot up if the power is inadequate.
- Make sure that your power supply unit (PSU) can provide at least the minimum power required by your system.

7. Internal audio connectors (4-pin CD)

This connector allows you to receive stereo audio input from sound sources such as a CD-ROM, TV tuner, or MPEG card.

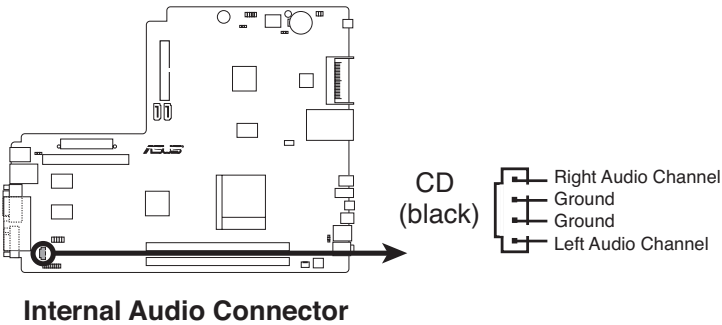

Enable the CD-IN function in the audio utility when using this connector.

8. Power button with LED (6-pin LED_CON1)

This connector supports the Power and HDD activity LEDs in the system front panel.

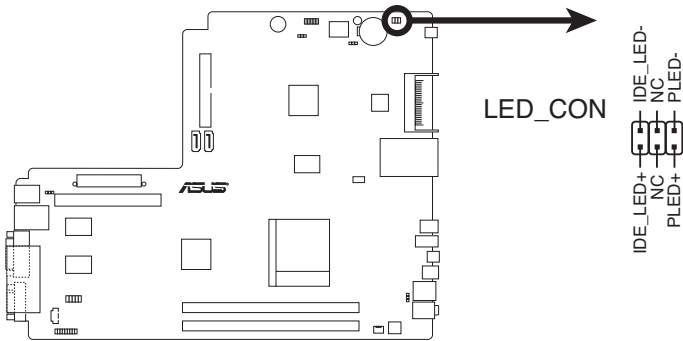

LED Connector

9. TV-out connector (20-pin TVOUT_R1)

This 20-pin connector is for the TV-out port module that allows you to connect a television to your system.

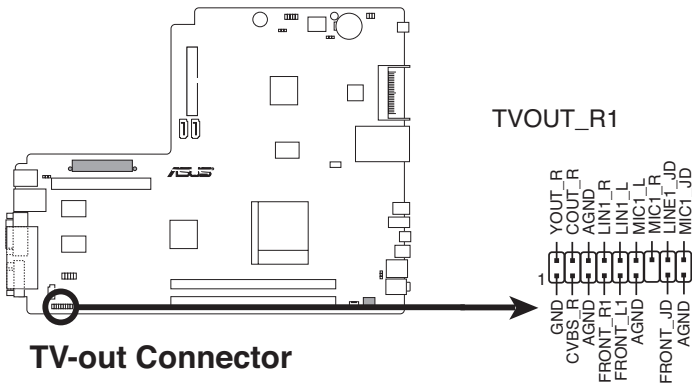

TV-out Connector

Chapter 5

This chapter tells how to change system settings through the BIOS Setup menus and describes the BIOS parameters.



ASUS Pundit P1-AH2

5.1 Managing and updating your BIOS

The following utilities allow you to manage and update the motherboard Basic Input/Output System (BIOS) setup.

1. **ASUS Update** (Updates the BIOS in Windows® environment)
2. **ASUS EZ Flash** (Updates the BIOS during the Power-On Self Test)
3. **Award BIOS Flash Utility** (Updates the BIOS in DOS mode)
4. **ASUS CrashFree BIOS 2** (Updates the BIOS when the BIOS file fails or gets corrupted.)

Refer to the corresponding sections for details on these utilities.



Save a copy of the original motherboard BIOS file to a bootable floppy disk in case you need to restore the BIOS in the future. Copy the original motherboard BIOS using the ASUS Update or Award BIOS Flash utilities.

5.1.1 ASUS Update utility

The ASUS Update is a utility that allows you to manage, save, and update the motherboard BIOS in Windows® environment. The ASUS Update utility allows you to:

- Save the current BIOS file
- Download the latest BIOS file from the Internet
- Update the BIOS from an updated BIOS file
- Update the BIOS directly from the Internet, and
- View the BIOS version information.

This utility is available in the support CD that comes with the motherboard package.



ASUS Update requires an Internet connection either through a network or an Internet Service Provider (ISP).

Installing ASUS Update

To install ASUS Update:

1. Place the support CD in the optical drive. The Drivers menu appears.
2. Click the Utilities tab, then click Install ASUS Update VX.XX.XX.
3. The ASUS Update utility is copied to your system.



Quit all Windows® applications before you update the BIOS using this utility.

Updating the BIOS through the Internet

To update the BIOS through the Internet:

1. Launch the ASUS Update utility from the Windows® desktop by clicking **Start > Programs > ASUS > ASUSUpdate > ASUSUpdate**. The ASUS Update main window appears.

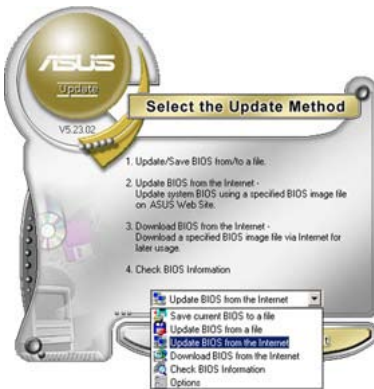
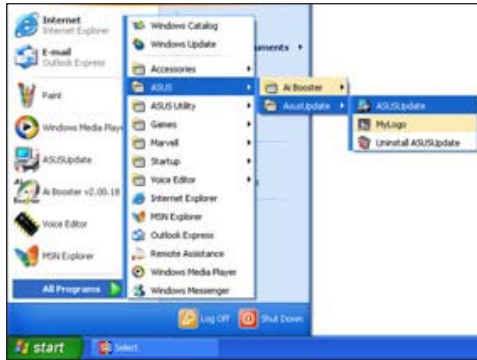

2. Select **Update BIOS** from the Internet option from the drop-down menu, then click **Next**.



3. Select the ASUS FTP site nearest you to avoid network traffic, or click Auto Select. Click **Next**.

- From the FTP site, select the BIOS version that you wish to download. Click **Next**.
- Follow the screen instructions to complete the update process.



The ASUS Update utility is capable of updating itself through the Internet. Always update the utility to avail all its features.



Updating the BIOS through a BIOS file

To update the BIOS through a BIOS file:

- Launch the ASUS Update utility from the Windows® desktop by clicking **Start > Programs > ASUS > ASUSUpdate > ASUSUpdate**. The ASUS Update main window appears.
- Select Update BIOS from a file option from the drop-down menu, then click **Next**.



- Locate the BIOS file from the Open window, then click Open.
- Follow the screen instructions to complete the update process.

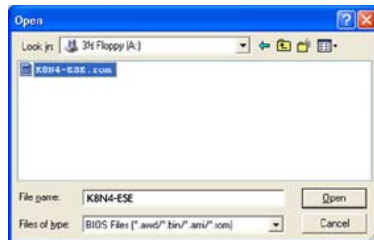

5.1.2 Creating a bootable floppy disk

1. Do either one of the following to create a bootable floppy disk.

DOS environment

- a. Insert a 1.44MB floppy disk into the drive.
- b. At the DOS prompt, type `format a: /s` then press <Enter>.

Windows® XP environment

- a. Insert a 1.44 MB floppy disk to the floppy disk drive.
- b. Click **Start** from the Windows® desktop, then select **My Computer**.
- c. Select the 3 1/2 Floppy Drive icon.
- d. Click File from the menu, then select **Format. A Format 3 1/2 Floppy Disk** window appears.
- e. Select **Create an MS-DOS startup disk** from the format options field, then click **Start**.

Windows® 2000 environment

To create a set of boot disks for Windows® 2000:

- a. Insert a formatted, high density 1.44 MB floppy disk into the drive.
- b. Insert the Windows® 2000 CD to the optical drive.
- c. Click **Start**, then select **Run**.
- d. From the Open field, type
`D:\bootdisk\makeboot a:`
assuming that D: is your optical drive.
- e. Press <Enter>, then follow screen instructions to continue.

2. Copy the original or the latest motherboard BIOS file to the bootable floppy disk.

5.1.3 ASUS EZ Flash utility

The ASUS EZ Flash feature allows you to update the BIOS without having to go through the long process of booting from a floppy disk and using a DOS-based utility. The EZ Flash utility is built-in the BIOS chip so it is accessible by pressing <Alt> + <F2> during the Power-On Self Tests (POST).

To update the BIOS using EZ Flash 2:

1. Download the latest BIOS file from ASUS website (www.asus.com), or obtain it from the support CD.
2. Save the BIOS file to a floppy disk, then boot the system from floppy disk.

3. Press <Alt> + <F2> during POST, the following screen appears:

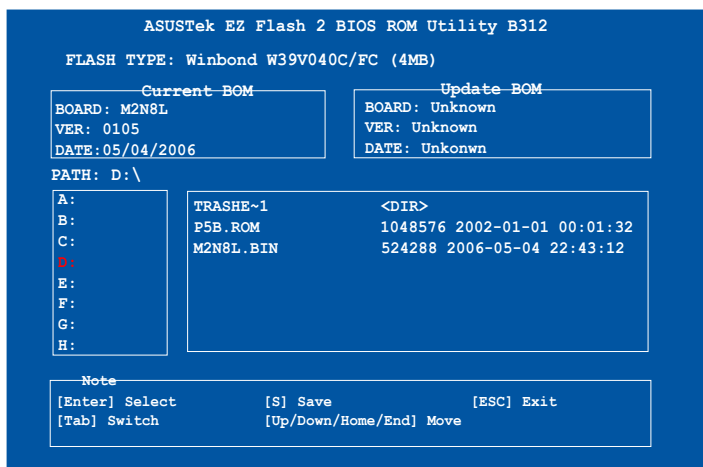

3. Select the floppy disk from the **PATH:** text box, then select the BIOS file's name from the text box on the right side (see figure below). Then press Enter on your keyboard.

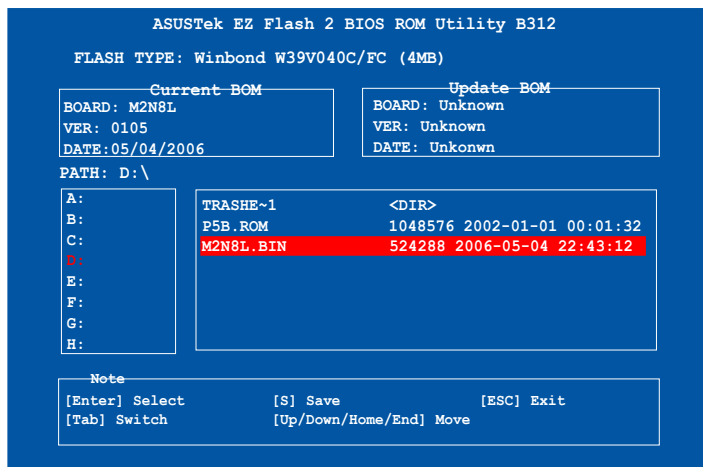

4. An "Are you sure to update BIOS?" message appears. Select "Yes" and press Enter on your keyboard, the EZ Flash utility will perform BIOS update process. The process may take a few minutes to complete.



Do not shut down or reset the system while updating the BIOS to prevent system boot failure!

5.1.4 AwardBIOS Flash utility

The Basic Input/Output System (BIOS) can be updated using the AwardBIOS Flash Utility. Follow these instructions to update the BIOS using this utility.

1. Download the latest BIOS file from the ASUS web site. Rename the file to M2N-SLI.BIN and save it to a floppy disk.



Save only the updated BIOS file in the floppy disk to avoid loading the wrong BIOS file.

2. Copy the AwardBIOS Flash Utility (awdflash.exe) from the Software folder of the support CD to the floppy disk with the latest BIOS file.
3. Boot the system in DOS mode using the bootable floppy disk you created earlier.
4. When the A:> appears, replace the bootable floppy disk with the floppy disk containing the new BIOS file and the Award BIOS Flash Utility.
5. At the prompt, type awdflash then press <Enter>. The Award BIOS Flash Utility screen appears.

```
AwardBIOS Flash Utility for ASUS V1.17
(C) Phoenix Technologies Ltd. All Rights Reserved

For C51/MCP51-M2N8L-00      DATE:05/04/2006
Flash Type - Winbond W39V040C/FC (4MB)

File Name to Program: M2N8L.bin

Message: Please input File Name!
```

6. Type the BIOS file name in the File Name to Program field, then press <Enter>.

```
AwardBIOS Flash Utility for ASUS V1.17
(C) Phoenix Technologies Ltd. All Rights Reserved

For C51/MCP51-M2N8L-00      DATE:05/04/2006
Flash Type - Winbond W39V040C/FC (4MB)

File Name to Program: M2N8L.bin

Message: Do You Want To Save Bios (Y/N)
```

7. Press <N> when the utility prompts you to save the current BIOS file. The following screen appears.
8. The utility verifies the BIOS file in the floppy disk and starts flashing the BIOS file.

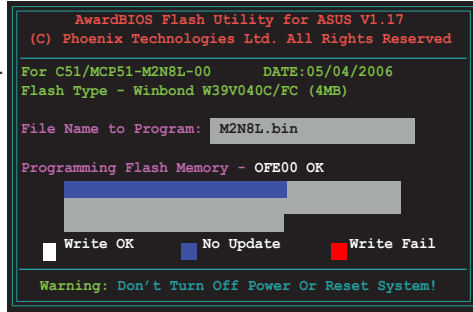

Do not turn off or reset the system during the flashing process!

9. The utility displays a Flashing Complete message indicating that you have successfully flashed the BIOS file. Remove the floppy disk then press <F1> to restart the system.

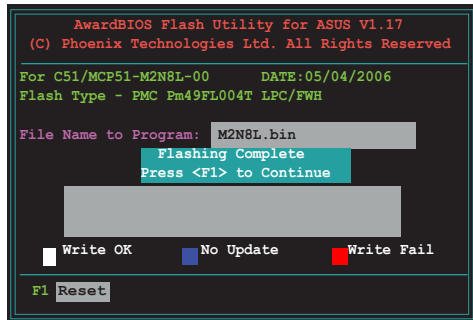

5.1.5 Saving the current BIOS file

You can use the AwardBIOS Flash Utility to save the current BIOS file. You can load the current BIOS file when the BIOS file gets corrupted during the flashing process.



Make sure that the floppy disk has enough disk space to save the file.

To save the current BIOS file using the AwardBIOS Flash Utility:

1. Follow steps 1 to 6 of the previous section.
2. Press <Y> when the utility prompts you to save the current BIOS file. The following screen appears.

```
AwardBIOS Flash Utility for ASUS V1.17
(C) Phoenix Technologies Ltd. All Rights Reserved

For C51/MCP51-M2N8L-00      DATE:05/04/2006
Flash Type - Winbond W39V040C/FC (4MB)

File Name to Program: M2N8L.bin
Save current BIOS as:

Message:
```

3. Type a filename for the current BIOS file in the Save current BIOS as field, then press <Enter>.

```
AwardBIOS Flash Utility for ASUS V1.17
(C) Phoenix Technologies Ltd. All Rights Reserved

For C51/MCP51-M2N8L-00      DATE:05/04/2006
Flash Type - Winbond W39V040C/FC (4MB)

File Name to Program: M2N8L.bin
Checksum:
Save current BIOS as:

Message: Please Wait!
```

4. The utility saves the current BIOS file to the floppy disk, then returns to the BIOS flashing process.

```
AwardBIOS Flash Utility for ASUS V1.17
(C) Phoenix Technologies Ltd. All Rights Reserved

For C51/MCP51-M2N8L-00      DATE:05/04/2006
Flash Type - Winbond W39V040C/FC (4MB)

File Name to Program: M2N8L.bin
Now Backup System BIOS to
File!

Message: Please Wait!
```

5.1.6 ASUS CrashFree BIOS utility

The ASUS CrashFree BIOS is an auto recovery tool that allows you to restore the BIOS file when it fails or gets corrupted during the updating process. You can update a corrupted BIOS file using the motherboard support CD or the floppy disk that contains the updated BIOS file.



Prepare the motherboard support CD or the floppy disk containing the updated motherboard BIOS before using this utility.

Recovering the BIOS from the support CD

To recover the BIOS from the support CD:

1. Turn on the system.
2. Insert the motherboard support CD to the optical drive.
3. The utility displays the following message and automatically checks the CD for the BIOS file.

```
Award BootBlock BIOS v1.0
Copyright (c) 2000, Award Software, Inc.

BIOS ROM checksum error
Detecting IDE ATAPI device...
```

When found, the utility reads the BIOS file and starts flashing the corrupted BIOS file.

```
Award BootBlock BIOS v1.0
Copyright (c) 2000, Award Software, Inc.

BIOS ROM checksum error
Detecting IDE ATAPI device...
  Found CDRom, try to Boot from it... Pass
```



DO NOT shut down or reset the system while updating the BIOS! Doing so can cause system boot failure!

4. Restart the system after the utility completes the updating process.

5.2 BIOS setup program

This motherboard supports a programmable Low-Pin Count (LPC) chip that you can update using the provided utility described in section “4.1 Managing and updating your BIOS.”

Use the BIOS Setup program when you are installing a motherboard, reconfiguring your system, or prompted to “Run Setup.” This section explains how to configure your system using this utility.

Even if you are not prompted to use the Setup program, you can change the configuration of your computer in the future. For example, you can enable the security password feature or change the power management settings. This requires you to reconfigure your system using the BIOS Setup program so that the computer can recognize these changes and record them in the CMOS RAM of the LPC chip.

The LPC chip on the motherboard stores the Setup utility. When you start up the computer, the system provides you with the opportunity to run this program. Press during the Power-On Self-Test (POST) to enter the Setup utility; otherwise, POST continues with its test routines.

If you wish to enter Setup after POST, reboot the system by doing any of the following procedures:

- Restart using the OS standard shut-down procedure.
- Press <Ctrl>+<Alt>+ simultaneously.
- Press the reset button on the system chassis.
- Press the power button to turn the system off then back on.



Using the **power button**, **reset button**, or the <Ctrl>+<Alt>+ keys to force reset from a running operating system can cause damage to the data or system. We recommend to always shut-down the system properly from the operating system.

The Setup program is designed to make it as easy to use as possible. Being a menu-driven program, it lets you scroll through the various sub-menus and make your selections from the available options using the navigation keys.



-
- The default BIOS settings for this motherboard apply for most conditions to ensure optimum performance. If the system becomes unstable after changing any BIOS settings, load the default settings to ensure system compatibility and stability. Select the **Load Default Settings** item under the Exit Menu. See section “4.8 Exit Menu.”
 - The BIOS setup screens shown in this section are for reference purposes only, and may not exactly match what you see on your screen.
 - Visit the ASUS website (www.asus.com) to download the latest BIOS file for this motherboard.
-

5.2.1 BIOS menu screen

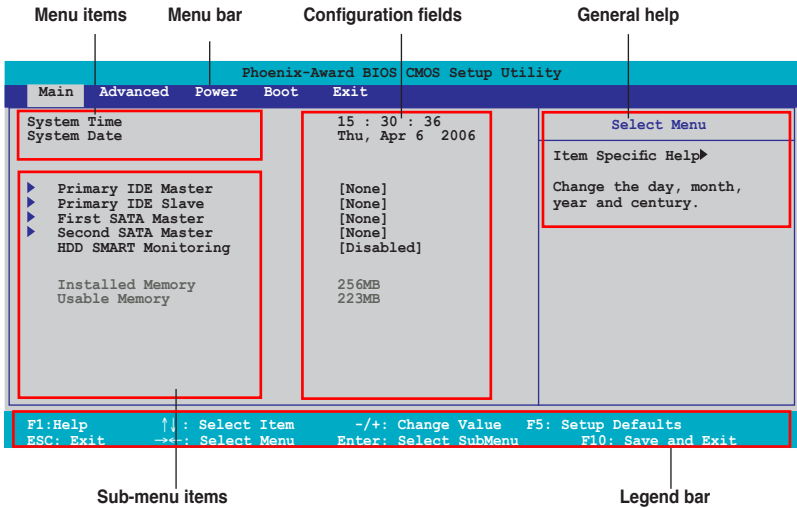

5.2.2 Menu bar

The menu bar on top of the screen has the following main items:

- | | |
|----------|--|
| Main | For changing the basic system configuration |
| Advanced | For changing the advanced system settings |
| Power | For changing the advanced power management (APM) configuration |
| Boot | For changing the system boot configuration |
| Exit | For selecting the exit options and loading default settings |

To select an item on the menu bar, press the right or left arrow key on the keyboard until the desired item is highlighted.



- The BIOS setup screens shown in this chapter are for reference purposes only, and may not exactly match what you see on your screen.
- Visit the ASUS website (www.asus.com) to download the latest BIOS information.

5.2.3 Legend bar

At the bottom of the Setup screen is a legend bar. The keys in the legend bar allow you to navigate through the various setup menus. The following table lists the keys found in the legend bar with their corresponding functions.

Navigation Key	Function
<F1>	Displays the General Help screen
<F5>	Loads setup default values
<Esc>	Exits the BIOS setup or returns to the main menu from a sub-menu
Left or Right arrow	Selects the menu item to the left or right
Up or Down arrow	Moves the highlight up or down between fields
Page Down or - (minus)	Scrolls backward through the values for the highlighted field
Page Up or + (plus)	Scrolls forward through the values for the highlighted field
<Enter>	Brings up a selection menu for the highlighted field
<F10>	Saves changes and exit

5.2.4 Menu items

The highlighted item on the menu bar displays the specific items for that menu. For example, selecting **Main** shows the Main menu items.

The other items (Advanced, Power, Boot, and Exit) on the menu bar have their respective menu items.

5.2.5 Sub-menu items

A solid triangle before each item on any menu screen means that the item has a sub-menu. To display the sub-menu, select the item and press <Enter>.

5.2.6 Configuration fields

These fields show the values for the menu items. If an item is user-configurable, you can change the value of the field opposite the item. You cannot select an item that is not user-configurable.

A configurable field is enclosed in brackets, and is highlighted when selected. To change the value of a field, select it then press <Enter> to display a list of options. Refer to “4.2.7 Pop-up window.”

5.2.7 Pop-up window

Select a menu item then press <Enter> to display a pop-up window with the configuration options for that item.

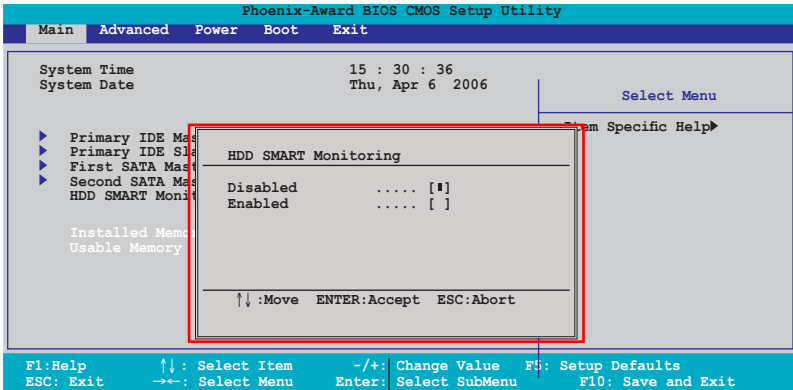

Pop-up menu

5.2.8 General help

At the top right corner of the menu screen is a brief description of the selected item.

5.3 Main menu

When you enter the BIOS Setup program, the Main menu screen appears, giving you an overview of the basic system information.



Refer to section “4.2.1 BIOS menu screen” for information on the menu screen items and how to navigate through them.

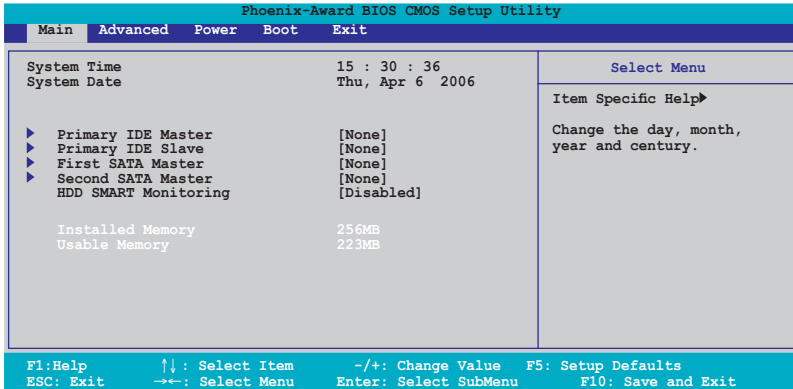

5.3.1 System Time [xx:xx:xx]

Allows you to set the system time.

5.3.2 System Date [Day xx/xx/xxxx]

Allows you to set the system date.

5.3.3 Primary IDE Master/Slave

While entering Setup, the BIOS automatically detects the presence of IDE devices. There is a separate sub-menu for each IDE device. Select a device item then press <Enter> to display the IDE device information.

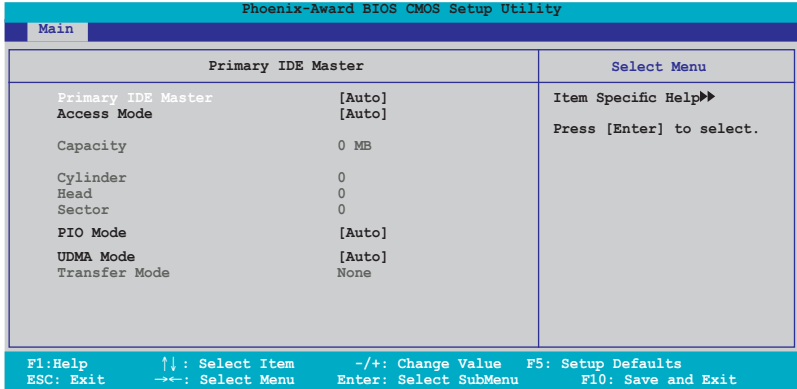

The BIOS automatically detects the values opposite the dimmed items (Capacity, Cylinder, Head, Sector and Transfer Mode). These values are not user-configurable. These items show N/A if no IDE device is installed in the system.

PIO Mode [Auto]

Sets the PIO mode for the IDE device.

Configuration options: [Auto] [Mode 0] [Mode 1] [Mode 2] [Mode 3] [Mode 4]

UDMA Mode [Auto]

Disables or sets the UDMA mode. Configuration options: [Disabled] [Auto]

Primary IDE Master/Slave [Auto]

Select [Auto] to automatically detect an IDE hard disk drive. If automatic detection is successful, the BIOS automatically fills in the correct values for the remaining fields on this sub-menu. If the hard disk was already formatted on a previous system, the setup BIOS may detect incorrect parameters. Select [Manual] to manually enter the IDE hard disk drive parameters. If no drive is installed select [None]. Configuration options: [None] [Auto] [Manual]

Access Mode [Auto]

The default [Auto] allows automatic detection of an IDE hard disk drive. Select [CHS] for this item if you set the IDE Primary Master/Slave to [Manual]. Configuration options: [CHS] [LBA] [Large] [Auto]



Before attempting to configure a hard disk drive, make sure you have the correct configuration information supplied by the drive manufacturer. Incorrect settings may cause the system to fail to recognize the installed hard disk.

Capacity

Displays the auto-detected hard disk capacity. This item is not configurable.

Cylinder

Shows the number of the hard disk cylinders. This item is not configurable.

Head

Shows the number of the hard disk read/write heads. This item is not configurable.

Sector

Shows the number of sectors per track. This item is not configurable.

Transfer Mode

Shows the Transfer mode. This item is not configurable.



After entering the IDE hard disk drive information into BIOS, use a disk utility, such as FDISK, to partition and format new IDE hard disk drives. This is necessary so that you can write or read data from the hard disk. Make sure to set the partition of the Primary IDE hard disk drives to active.

5.3.4 First / Second SATA Master

While entering Setup, the BIOS automatically detects the presence of Serial ATA devices. There is a separate sub-menu for each SATA device. Select a device item then press <Enter> to display the SATA device information.

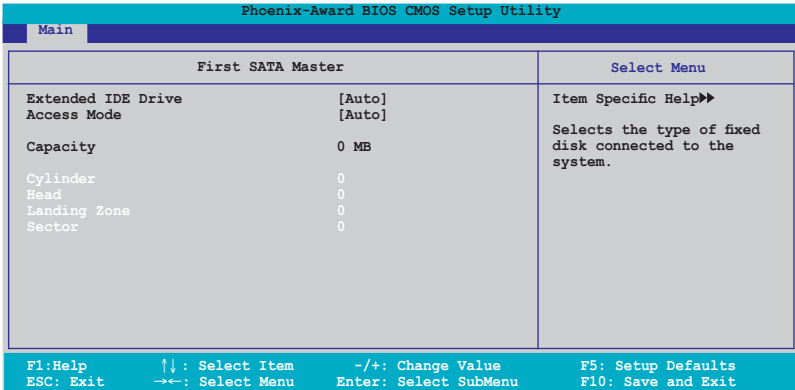

The BIOS automatically detects the values opposite the dimmed items (Capacity, Cylinder, Head, Landing Zone and Sector). These values are not user-configurable. These items show 0 if no SATA device is installed in the system.

Extended IDE Drive [Auto]

Selects the type of fixed disk connected to the system.

Configuration options: [None] [Auto]

Access Mode [Auto]

Sets the sector addressing mode. Configuration options: [Large] [Auto]



Before attempting to configure a hard disk drive, make sure you have the correct configuration information supplied by the drive manufacturer. Incorrect settings may cause the system to fail to recognize the installed hard disk.

Capacity

Displays the auto-detected hard disk capacity. This item is not configurable.

Cylinder

Shows the number of the hard disk cylinders. This item is not configurable.

Head

Shows the number of the hard disk read/write heads. This item is not configurable.

Landing Zone

Shows the number of landing zone per track. This item is not configurable.

Sector

Shows the number of sectors per track. This item is not configurable.



After entering the IDE hard disk drive information into BIOS, use a disk utility, such as FDISK, to partition and format new IDE hard disk drives. This is necessary so that you can write or read data from the hard disk. Make sure to set the partition of the Primary IDE hard disk drives to active.

5.3.5 HDD SMART Monitoring [Disabled]

Allows you to enable or disable the HDD Self-Monitoring Analysis and Reporting Technology (SMART) feature. Configuration options: [Disabled] [Enabled]

5.3.6 Installed Memory [xxx MB]

Shows the size of installed memory.

5.3.7 Usable Memory [XXX MB]

Shows the size of usable memory.

5.4 Advanced menu

The Advanced menu items allow you to change the settings for the CPU and other system devices.



Take caution when changing the settings of the Advanced menu items. Incorrect field values can cause the system to malfunction.

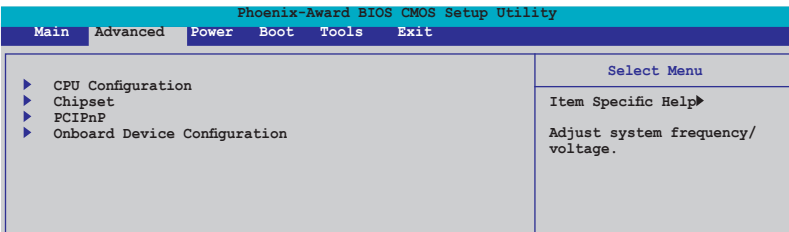

5.4.1 CPU Configuration

Phoenix-Award BIOS CMOS Setup Utility		
Advanced		
CPU Configuration		Select Menu
CPU Type	AMD Sempron (tm) Processor 3200+	Item Specific Help▶▶
CPU Speed	1810MHz	DRAM timing and control.
Cache RAM	128K	
▶ DRAM Configuration		
AMD Cool 'n' Quiet Function	[Auto]	

DRAM Configuration

The items in the sub-menu show the DRAM-related information auto-detected by the BIOS.

Phoenix-Award BIOS CMOS Setup Utility		
Advanced		
DRAM Configuration		Select Menu
Timing Mode	[Auto]	Item Specific Help▶▶▶
Memory Clock Frequency	[Auto]	

Timing Mode

Configuration options: [Auto] [MaxMemClk] [Manual].

Memory Clock Frequency

Sets platform Memclock or limit value. Configuration options: [Auto] [DDR2 400] [DDR2 533] [DDR2 667] [DDR2 800]

AMD Cool 'n' Quiet Function [Disabled]

Enables or disables the AMD Cool 'n' Quiet technology.

Configuration options: [Disabled] [Auto]

5.4.2 Chipset

Phoenix-Award BIOS CMOS Setup Utility		
Advanced		
Chipset		Select Menu
Frame Buffer Size	[32M]	Item Specific Help▶▶▶
CPU Frequency	[200.0]	
Spread Spectrum	[Disabled]	
SATA Spread Spectrum	[Disabled]	
HT Spread Spectrum	[Disabled]	
RGB/TV Display	[Auto]	
TV Mode Support	[Disabled]	

F1: Help ↑↓: Select Item -/+ : Change Value F5: Setup Defaults
ESC: Exit →←: Select Menu Enter: Select Sub-menu F10: Save and Exit

Frame Buffer Size [32M]

Select Frame Buffer Size for Onboard Graphic.

Configuration options: [16M] [32M] [64M] [128M]

CPU Frequency [200.0]

Select CPU frequency.

Configuration options: [200.0] [201.0] [202.0] [203.0] [204.0][205.0]...[400.0]

Spread Spectrum [Disabled]

Disable/enable Spread Spectrum for CPU.

Configuration options: [Disabled] [Center] [Down]

SATA Spread Spectrum [Disabled]

Disable/Enable Spread Spectrum for SATA.

Configuration options: [Disabled] [Enabled]

HT Spread Spectrum [Disabled]

Disable/Enable Spread Spectrum for Hyper Transport.

Configuration options: [Disabled] [Center] [Down]

RGB/TV Display [Auto]

Select Video output type.

Configuration options: [Auto] [CRT] [TV]

TV Mode Support [Disabled]

Select TV Signal output format.

Configuration options: [NTSC-M] [NTSC-J] [PAL-M] [PAL-BDGHI] [PAL-N] [PAL-NC] [Disabled]

5.4.3 PCIPnP

Phoenix-Award BIOS CMOS Setup Utility		
Advanced		
PCIPnP		Select Menu
Plug & Play O/S	[No]	Item Specific Help▶▶
Primary Display Adapter	[PCI]	
Resources Controlled By	[Auto]	
x IRQ Resources		

Plug & Play O/S [No]

When set to [No], the BIOS configures all the devices in the system. When set to [Yes] and if you install a Plug and Play operating system, the operating system configures the Plug and Play devices not required for boot. Configuration options: [No] [Yes]

Primary Display Adapter [PCI]

Select which graphics controller to use as the primary boot device. Configuration options: [PCI] [Onboard]

Resources Controlled By [Auto]

When set to [Auto], the BIOS automatically configures all the boot and Plug and Play compatible devices. Set to [Manual] if you want to assign the IRQ DMA and memory base address fields. Configuration options: [Auto] [Manual]



The item **IRQ Resources** becomes user-configurable when you set **Resources Controlled By** to [Manual].

IRQ Resources

Phoenix-Award BIOS CMOS Setup Utility		
Advanced		
IRQ Resources		Select Menu
IRQ-5 assigned to	[PCI Device]	Item Specific Help▶▶▶ Legacy ISA for devices compliant with the original PC AT bus specification, PCI/ISA PnP for devices compliant with the Plug and Play standard whether designed for PCI or ISA bus architecture.
IRQ-7 assigned to	[PCI Device]	
IRQ-9 assigned to	[PCI Device]	
IRQ-10 assigned to	[PCI Device]	
IRQ-11 assigned to	[PCI Device]	
IRQ-14 assigned to	[PCI Device]	
IRQ-15 assigned to	[PCI Device]	

IRQ-xx assigned to

When set to [PCI Device], the specific IRQ is free for use of PCI/PnP devices. When set to [Reserved], the IRQ is reserved for legacy ISA devices. Configuration options: [PCI Device] [Reserved]

5.4.4 Onboard Device Configuration

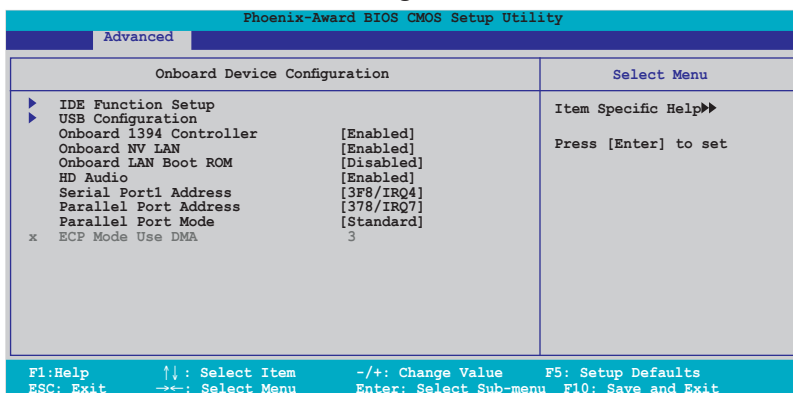

IDE Function Setup

This sub-menu contains IDE function-related items. Select an item then press <Enter> to edit.

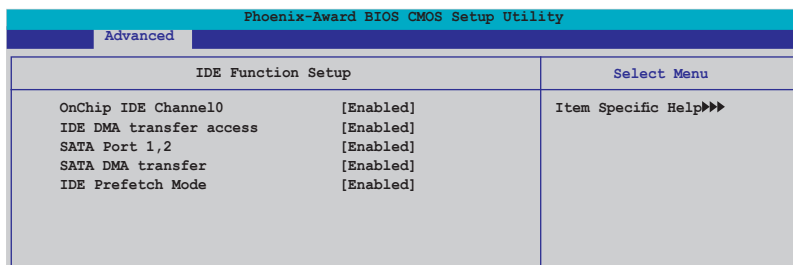

OnChip IDE Channel0 [Enabled]

Allows you to enable or disable the onchip IDE channel 0 controller .
Configuration options: [Disabled] [Enabled]

IDE DMA transfer access [Enabled]

Allows you to enable or disable the IDE DMA transfer access.
Configuration options: [Disabled] [Enabled]

SATA Port 1, 2 [Enabled]

Disable/Enable onchip SATA (Port 1, Port 2).
Configuration options: [Disabled] [Enabled]

SATA DMA transfer [Enabled]

Allows you to enable or disable the SATA DMA transfer support.
Configuration options: [Disabled] [Enabled]

IDE Prefetch Mode [Enabled]

Allows you to enable or disable the IDE PIO read prefetch mode.
Configuration options: [Disabled] [Enabled]

USB Configuration

The items in this menu allows you to change the USB-related features. Select an item then press <Enter> to display the configuration options.

Phoenix-Award BIOS CMOS Setup Utility	
Advanced	
USB Configuration	Select Menu
USB Controller [Enabled]	Item Specific Help▶ Enable or Disable the USB Controller.
USB2.0 Controller [Enabled]	
USB Legacy support [Enabled]	

USB Controller [Enabled]

Allows you to enable or disable the onchip USB controller.

Configuration options: [Disabled] [Enabled]

USB 2.0 Controller [Enabled]

Allows you to enable or disable the USB 2.0 controller.

Configuration options: [Disabled] [Enabled]

USB Legacy Support [Enabled]

Allows you to enable or disable support for USB devices on legacy operating systems (OS). Configuration options: [Disabled] [Enabled]

Onboard 1394 Controller [Enabled]

Allows you to disable or enable the onboard 1394 device support.

Configuration options: [Disabled] [Enabled]

Onboard NV LAN [Enabled]

Enables or disables the onboard NVIDIA® LAN interface.

Configuration options: [Disabled] [Enabled]

OnBoard LAN Boot ROM [Disabled]

Allows you to enable or disable the onboard LAN boot ROM.

Configuration options: [Enabled] [Disabled]

HD Audio [Auto]

Allows you to disable or set the High-Definition audio function.

Configuration options: [Auto] [Disabled]

Serial Port1 Address [3F8/IRQ4]

Allows you to select the Serial Port1 base address.

Configuration options: [Disabled] [3F8/IRQ4] [2F8/IRQ3] [3E8/IRQ4] [2E8/IRQ3] [Auto]

Parallel Port Address [378/IRQ7]

Allows you to select the Parallel Port address.

Configuration options: [Disabled] [378/IRQ7] [278/IRQ5] [3BC/IRQ7]

Parallel Port Mode [Normal]

Allows you to select the Parallel Port mode.

Configuration options: [Normal] [EPP] [ECP] [Bi-Directional]



The “ECP Mode Use DMA” item becomes user-configurable when the “ Parallel Port Mode” item is set to [ECP] or [Bi-Directional]

ECP Mode Use DMA [3]

Allows selection of ECP Mode. Configuration options: [1] [3]

5.5 Power menu

The Power menu items allow you to change the settings for the Advanced Configuration and Power Interface (ACPI) and the Advanced Power Management (APM). Select an item then press <Enter> to display the configuration options.

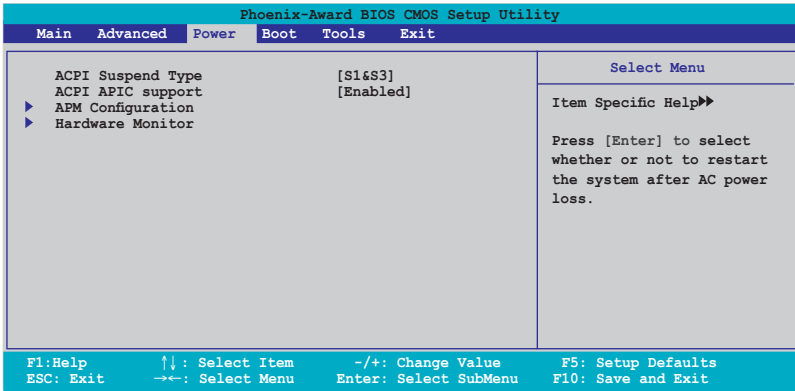

5.5.1 ACPI Suspend Type [S1&S3]

Allows you to select the Advanced Configuration and Power Interface (ACPI) state to be used for system suspend. Configuration options: [S1 (POS)] [S3(STR)] [S1&S3]

5.5.2 ACPI APIC Support [Enabled]

Allows you to enable or disable the Advanced Configuration and Power Interface (ACPI) support in the Application-Specific Integrated Circuit (ASIC). When set to Enabled, the ACPI APIC table pointer is included in the RSDT pointer list. Configuration options: [Disabled] [Enabled]

5.5.3 APM Configuration

Phoenix-Award BIOS CMOS Setup Utility		
Power		
APM Configuration		Select Menu
Restore on AC Power Loss	[Disabled]	Item Specific Help▶▶
PS2 Keyboard Power on	[Disabled]	
PS2 Mouse Power on	[Disabled]	
HDD Down In Suspend	[Disabled]	
PWR Button < 4 secs	[Instant-Off]	
Power Up On PCI/PCIE Devices	[Disabled]	
Power On By External Modems	[Disabled]	
Power On By RTC Alarm	[Disabled]	
* Date (of Month) Alarm	0	
* Time (hh:mm:ss) Alarm	0 : 0 : 0	

F1: Help ↑↓ : Select Item -/+ : Change Value F5: Setup Defaults
ESC: Exit →← : Select Menu Enter: Select SubMenu F10: Save and Exit

Restore on AC Power Loss [Disabled]

Select system power state when AC power returns.

Configuration options: [Disabled] [Enabled]

PS2 Keyboard Power on [Disabled]

Enable or disable the PS2 keyboard power on function while the system is in Soft off state. Configuration options: [Disabled] [Enabled]

PS2 Mouse Power on [Disabled]

Enable or disable the Ps2 Mouse Power in function while the system is in Soft off state. Configuration options: [Disabled] [Enabled]

HDD Down In Suspend [Disabled]

Enable or disable Hard disk Down in suspend function. Configuration options: [Disabled] [Enabled]

PWR Button < 4 secs [Instant-Off]

When sets to [Instant-Off], the system will go to soft-off instantly when power button is pressed for less than 4 seconds. When sets to [Suspend], the system will go to suspend when power button is pressed. Configuration options: [Instant-Off] [Suspend]

Power Up On PCI/PCIE Devices [Disabled]

Disable/Enable PME to wake up from S5 by PCI devices & NV onboard LAN.

Configuration options: [Disabled] [Enabled]

Power On By External Modems [Disabled]

Disable/Enable wake up by ring function.

Configuration options: [Disabled] [Enabled]

Power On By RTC Alarm [Disabled]

Enable or disable the power on by RTC alarm function.

Configuration options: [Disabled] [Enabled]

5.5.4 Hardware Monitor

The items in this sub-menu displays the hardware monitor values automatically detected by the BIOS. It also allows you to change CPU Q-Fan feature-related parameters. Select an item then press <Enter> to display the configuration options.

Phoenix-Award BIOS CMOS Setup Utility		
Power		
Hardware Monitor		Select Menu
CPU Temperature	45C	Item Specific Help▶▶ Press [Enter] to enable or disable.
M/B Temperature	35C	
Vccp	[1.34V]	
5V	[4.96V]	
x 12V	[11.71V]	
3.3V	[3.21V]	
CPU Fan Speed	934 RPM	
CPU Fan Speed warning	[800 RPM]	
Fan Control	[Enabled]	
Fan Low Temp	[45C]	
Temperature Range	[26.67C]	
Set CPUFAN RAMP RATE	[7 secs]	
Fan1 Full Run Temp	[63]	
CPU Fan Low Voltage	[4.0V]	

F1: Help ↑↓ : Select Item -/+ : Change Value F5: Setup Defaults
ESC: Exit →← : Select Menu Enter: Select SubMenu F10: Save and Exit

3.3V Voltage, 5V Voltage, 12V Voltage

The onboard hardware monitor automatically detects the voltage output through the onboard voltage regulators.

CPU Temperature, M/B Temperature

The onboard hardware monitor automatically detects and displays the motherboard and CPU temperatures. These items are not user-configurable.

CPU Fan Speed

The onboard hardware monitor automatically detects and displays the CPU, fan speeds in rotations per minute (RPM). These items are not user-configurable.

CPU Fan Speed warning [800 RPM]

Allows you to disable or set the CPU fan warning speed.

Configuration options: [Disabled] [800 RPM] [1200 RPM] [1600 RPM]

Fan Control [Enabled]

Enable/Disable the control of the system/CPU fan speed by changing the fan voltage. Configuration options: [Disabled] [Enabled]

Fan Low Temp [45C]

The system fan will switch to the slower speed if the temperature decreases below this level. Fan Low Temp must be less than Fan High Temp. Configuration options:[20] [21] [22] [23] [24]...[89]

Temperature Range [26.67C]

Allows you to select Delta temperature to decide smart Fan working slope. Configuration options: [2C] [2.5C] [3.33C] [4C] [5C] [6.67C] [8C] [10C] [13.33C] [16C] [20C] [26.67C]...[80C]

FAN1 Full Run Temp [63]

Sets the FAN1 Full Run Temp by keying in a DEC number. Minmum: 0, Maxmum: 255.

CPU Fan Low Voltage [4.0 V]

Select the fan voltage for slower fan speed operation.Configuration options: [3.0V] [3.5V] [4.0V] [4.5V] [5V]... [10.5V]

5.6 Boot menu

The Boot menu items allow you to change the system boot options. Select an item then press <Enter> to display the sub-menu.

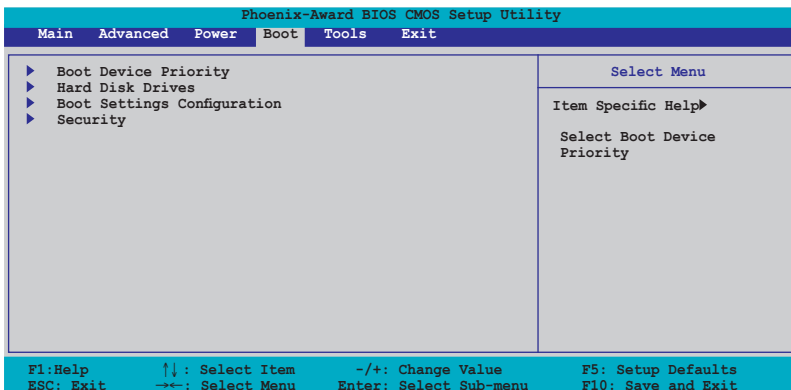

5.6.1 Boot Device Priority

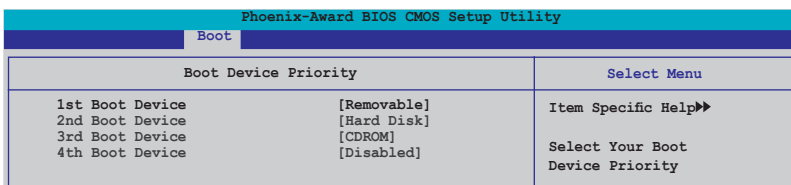

1st ~ 4th Boot Device

These items specify the boot device priority sequence from the available devices. The number of device items that appears on the screen depends on the number of devices installed in the system. Configuration options: [Removable] [Hard Disk] [CDROM] [Disabled]

5.6.2 Hard Disk Drives

Allows you to assign hard disk drives attached to the system.

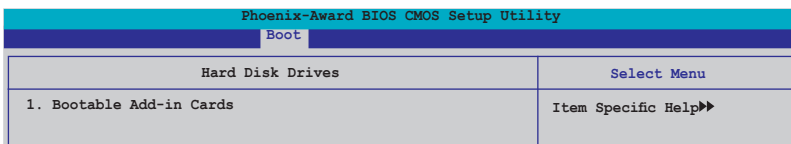

5.6.3 Boot Settings Configuration

Phoenix-Award BIOS CMOS Setup Utility			
Boot			
Boot Settings Configuration		Select Menu	
Quick Boot	[Enabled]	Item Specific Help▶▶ Press [Enter] to enable or disable.	
Bootup Num-Lock	[On]		
Typematic Rate Setting	[Disabled]		
x Typematic Rate (Chars/Sec)	6		
x Typematic Delay (Msec)	250		
OS Select For DRAM > 64MB	[Non-OS2]		
Full Screen LOGO	[Enabled]		
Halt On	[All, But Keyboard]		
F1: Help	↑↓: Select Item	-/+ : Change Value	F5: Setup Defaults
ESC: Exit	→←: Select Menu	Enter: Select Sub-menu	F10: Save and Exit

Quick Boot [Enabled]

Allows you to enable or disable the system quick boot feature. When Enabled, the system skips certain tests while booting. Configuration options: [Disabled] [Enabled]

Bootup Num-Lock [On]

Allows you to select the power-on state for the NumLock. Configuration options: [Off] [On]

Typematic Rate Setting [Disabled]

Allows you to set the keystroke rate. Enable this item to configure the Typematic Rate (Chars/Sec) and the Typematic Delay (Msec). Configuration options: [Disabled] [Enabled]



The items **Typematic Rate (Chars/Sec)** and **Typematic Delay (Msec)** become user-configurable only when the item **Typematic Rate Setting** is enabled.

Typematic Rate (Chars/Sec) [6]

Allows you to select the rate at which a character repeats when you hold a key. Configuration options: [6] [8] [10] [12] [15] [20] [24] [30]

Typematic Delay (Msec) [250]

Allows you to set the delay before keystrokes begin to repeat. Configuration options: [250] [500] [750] [1000]

OS Select for DRAM > 64MB [Non-OS2]

Set this item to OS2 only when you are running on an OS/2 operating system with an installed RAM of greater than 64 KB. Configuration options: [Non-OS2] [OS2]

Full Screen LOGO [Enabled]

Allows you to enable or disable the full screen logo display feature. Configuration options: [Disabled] [Enabled]



Make sure that the above item is set to [Enabled] if you want to use the ASUS MyLogo3™ feature.

Halt On [All, But Keyboard]

Allows you to error report type.

Configuration options: [All Errors] [No Errors] [All, But Keyboard] [All, But Diskette] [All, But Disk/Key]

5.6.4 Security

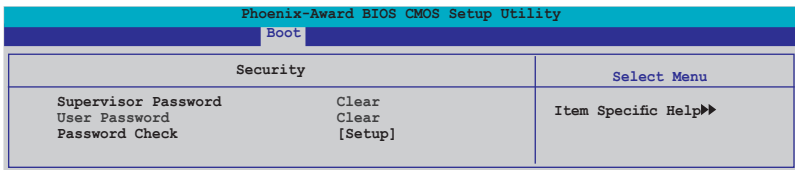

Supervisor Password

User Password

These fields allow you to set passwords:

To set a password:

1. Select an item then press <Enter>.
2. Type in a password using a combination of a maximum of eight (8) alphanumeric characters, then press <Enter>.

- When prompted, confirm the password by typing the exact characters again, then press <Enter>. The password field setting is changed to Set.

To clear the password:

- Select the password field and press <Enter> twice. The following message appears:

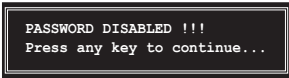

- Press any key to continue. The password field setting is changed to Clear.

A note about passwords

The Supervisor password is required to enter the BIOS Setup program preventing unauthorized access. The User password is required to boot the system preventing unauthorized use.

Forgot your password?

If you forget your password, you can clear it by erasing the CMOS Real Time Clock (RTC) RAM. The RAM data containing the password information is powered by the onboard button cell battery. If you need to erase the CMOS RAM, refer to section “2.6 Jumper” for instructions.

Password Check

This field requires you to enter the password before entering the BIOS setup or the system. Select [Setup] to require the password before entering the BIOS Setup. Select [System] to require the password before entering the system. Configuration options: [Setup] [System]

5.8 Exit menu

The Exit menu items allow you to load the optimal or failsafe default values for the BIOS items, and save or discard your changes to the BIOS items.

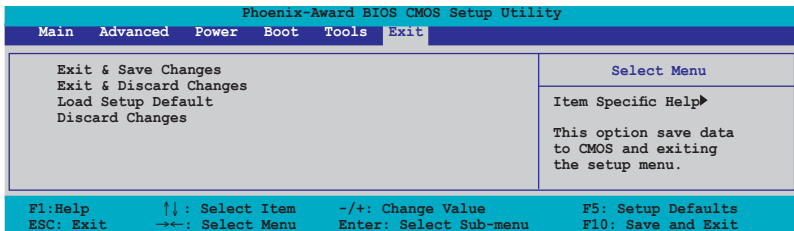



Pressing <Esc> does not immediately exit this menu. Select one of the options from this menu or <F10> from the legend bar to exit.

Exit & Save Changes

Once you are finished making your selections, choose this option from the Exit menu to ensure the values you selected are saved to the CMOS RAM. An onboard backup battery sustains the CMOS RAM so it stays on even when the PC is turned off. When you select this option, a confirmation window appears. Select YES to save changes and exit.



If you attempt to exit the Setup program without saving your changes, the program prompts you with a message asking if you want to save your changes before exiting. Press <Enter> to save the changes while exiting.

Exit & Discard Changes

Select this option only if you do not want to save the changes that you made to the Setup program. If you made changes to fields other than System Date, System Time, and Password, the BIOS asks for a confirmation before exiting.

ASUS EZ Flash 2

Press Enter to run ASUS EZ Flash 2 utility.

Load Setup Defaults

This option allows you to load the default values for each of the parameters on the Setup menus. When you select this option or if you press <F5>, a confirmation window appears. Select YES to load default values. Select Exit & Save Changes or make other changes before saving the values to the non-volatile RAM.

Discard Changes

This option allows you to discard the selections you made and restore the previously saved values. After selecting this option, a confirmation appears. Select YES to discard any changes and load the previously saved values.