

P5W DH
Deluxe

ASUS[®]

Motherboard

E2557

First Edition V1

May 2006

Copyright © 2006 ASUSTeK COMPUTER INC. All Rights Reserved.

No part of this manual, including the products and software described in it, may be reproduced, transmitted, transcribed, stored in a retrieval system, or translated into any language in any form or by any means, except documentation kept by the purchaser for backup purposes, without the express written permission of ASUSTeK COMPUTER INC. ("ASUS").

Product warranty or service will not be extended if: (1) the product is repaired, modified or altered, unless such repair, modification or alteration is authorized in writing by ASUS; or (2) the serial number of the product is defaced or missing.

ASUS PROVIDES THIS MANUAL "AS IS" WITHOUT WARRANTY OF ANY KIND, EITHER EXPRESS OR IMPLIED, INCLUDING BUT NOT LIMITED TO THE IMPLIED WARRANTIES OR CONDITIONS OF MERCHANTABILITY OR FITNESS FOR A PARTICULAR PURPOSE. IN NO EVENT SHALL ASUS, ITS DIRECTORS, OFFICERS, EMPLOYEES OR AGENTS BE LIABLE FOR ANY INDIRECT, SPECIAL, INCIDENTAL, OR CONSEQUENTIAL DAMAGES (INCLUDING DAMAGES FOR LOSS OF PROFITS, LOSS OF BUSINESS, LOSS OF USE OR DATA, INTERRUPTION OF BUSINESS AND THE LIKE), EVEN IF ASUS HAS BEEN ADVISED OF THE POSSIBILITY OF SUCH DAMAGES ARISING FROM ANY DEFECT OR ERROR IN THIS MANUAL OR PRODUCT.

SPECIFICATIONS AND INFORMATION CONTAINED IN THIS MANUAL ARE FURNISHED FOR INFORMATIONAL USE ONLY, AND ARE SUBJECT TO CHANGE AT ANY TIME WITHOUT NOTICE, AND SHOULD NOT BE CONSTRUED AS A COMMITMENT BY ASUS. ASUS ASSUMES NO RESPONSIBILITY OR LIABILITY FOR ANY ERRORS OR INACCURACIES THAT MAY APPEAR IN THIS MANUAL, INCLUDING THE PRODUCTS AND SOFTWARE DESCRIBED IN IT.

Products and corporate names appearing in this manual may or may not be registered trademarks or copyrights of their respective companies, and are used only for identification or explanation and to the owners' benefit, without intent to infringe.

Contents

Notices.....	vii
Safety information	viii
About this guide	ix
P5W DH Deluxe specifications summary	xi

Chapter 1: Product introduction

1.1	Welcome!	1-1
1.2	Package contents.....	1-1
1.3	Special features.....	1-2
1.3.1	Product highlights	1-2
1.3.2	ASUS AI Life features	1-6
1.3.3	Innovative ASUS features	1-6
1.3.4	Digital Home features	1-9

Chapter 2: Hardware information

2.1	Before you proceed	2-1
2.2	Motherboard overview	2-2
2.2.1	Placement direction	2-2
2.2.2	Screw holes	2-2
2.2.3	ASUS Stack Cool 2.....	2-3
2.2.4	Motherboard layout.....	2-4
2.2.5	Layout contents.....	2-5
2.3	Central Processing Unit (CPU)	2-7
2.3.1	Installing the CPU	2-8
2.3.2	Installing the CPU heatsink and fan	2-10
2.3.3	Uninstalling the CPU heatsink and fan	2-12
2.4	System memory	2-14
2.4.1	Overview	2-14
2.4.2	Memory configurations.....	2-14
2.4.3	Installing a DIMM	2-21
2.4.4	Removing a DIMM	2-21
2.5	Expansion slots.....	2-22
2.5.1	Installing an expansion card	2-22
2.5.2	Configuring an expansion card	2-22
2.5.3	Interrupt assignments	2-23
2.5.4	PCI slots.....	2-24
2.5.5	PCI Express x1 slot.....	2-24
2.5.6	Two PCI Express x16 slots	2-24

Contents

2.6	Jumpers	2-26
2.7	Connectors	2-28
2.7.1	Rear panel connectors	2-28
2.7.2	Internal connectors	2-31

Chapter 3: Powering up

3.1	Starting up for the first time	3-1
3.2	Turning off the computer	3-2
3.2.1	Using the OS shut down function.....	3-2
3.2.2	Using the dual function power switch.....	3-2

Chapter 4: BIOS setup

4.1	Managing and updating your BIOS	4-1
4.1.1	ASUS Update utility	4-1
4.1.2	Creating a bootable floppy disk.....	4-4
4.1.3	ASUS EZ Flash 2 utility.....	4-5
4.1.4	AFUDOS utility.....	4-6
4.1.5	ASUS CrashFree BIOS 3 utility	4-9
4.2	BIOS setup program	4-10
4.2.1	BIOS menu screen.....	4-11
4.2.2	Menu bar.....	4-11
4.2.3	Navigation keys.....	4-11
4.2.4	Menu items	4-12
4.2.5	Sub-menu items.....	4-12
4.2.6	Configuration fields	4-12
4.2.7	Pop-up window	4-12
4.2.8	Scroll bar.....	4-12
4.2.9	General help	4-12
4.3	Main menu	4-13
4.3.1	System Time	4-13
4.3.2	System Date	4-13
4.3.3	Legacy Diskette A	4-13
4.3.4	Language.....	4-13
4.3.5	Primary, Third, and Fourth IDE Master/Slave	4-14
4.3.6	IDE Configuration.....	4-15
4.3.7	System Information	4-17

Contents

4.4	Advanced menu	4-18
4.4.1	JumperFree Configuration	4-18
4.4.2	LAN Cable Status	4-22
4.4.3	USB Configuration	4-23
4.4.4	CPU Configuration	4-24
4.4.5	Chipset	4-26
4.4.6	Onboard Devices Configuration	4-28
4.4.7	PCI PnP	4-30
4.4.8	DH Feature page	4-31
4.5	Power menu.....	4-32
4.5.1	Suspend Mode	4-32
4.5.2	Repost Video on S3 Resume.....	4-32
4.5.3	ACPI 2.0 Support	4-32
4.5.4	ACPI APIC Support	4-32
4.5.5	APM Configuration	4-33
4.5.6	Hardware Monitor	4-35
4.6	Boot menu	4-38
4.6.1	Boot Device Priority	4-38
4.6.2	Hard Disk Drives	4-39
4.6.3	Boot Settings Configuration	4-39
4.6.4	Security	4-41
4.7	Tools menu	4-43
4.7.1	ASUS Music Alarm.....	4-43
4.7.2	ASUS EZ Flash 2	4-45
4.8	Exit menu	4-46
 Chapter 5: Software support		
5.1	Installing an operating system	5-1
5.2	Support CD information	5-1
5.2.1	Running the support CD	5-1
5.2.2	Drivers menu	5-2
5.2.3	Utilities menu	5-3
5.2.4	Make Disk menu	5-6
5.2.5	Manual menu	5-7
5.2.6	Contact information	5-7
5.2.7	Other information	5-8

Contents

- 5.3 Software information 5-10**
 - 5.3.1 ASUS MyLogo 2 5-10
 - 5.3.2 AI NET2 5-12
 - 5.3.3 Audio configurations 5-13
 - 5.3.4 ASUS PC Probe II..... 5-20
 - 5.3.5 ASUS Music Alarm..... 5-26
- 5.4 RAID configurations 5-29**
 - 5.4.1 Installing Serial ATA hard disks 5-30
 - 5.4.2 Intel® RAID configurations..... 5-30
 - 5.4.3 JMicron® RAID Configuration 5-40
 - 5.4.4 Silicon Image® RAID configuration..... 5-48
 - 5.4.5 Cross-RAID Configuration: Creating a RAID 10 set (RAID 0+1) with ASUS EZ-Backup and Intel ICH7R® ... 5-61
- 5.5 Creating a RAID driver disk..... 5-64**
 - 5.5.1 Creating a RAID driver disk without entering the OS.... 5-64
 - 5.5.2 Creating a RAID driver disk in Windows®..... 5-64

Chapter 6: ATI® CrossFire™ technology support

- 6.1 Overview 6-1**
 - 6.1.1 Requirements..... 6-1
 - 6.1.2 Before you begin..... 6-1
- 6.2 Installing CrossFire™ graphics cards 6-2**
- 6.3 Software information 6-5**
 - 6.3.1 Installing the device drivers..... 6-5
 - 6.3.2 Using the Catalyst™ Control Center..... 6-7

Appendix: CPU features

- A.1 Intel® EM64T.....A-1**
- A.2 Enhanced Intel SpeedStep® Technology (EIST)A-1**
- A.3 Intel® Hyper-Threading TechnologyA-3**

Notices

Federal Communications Commission Statement

This device complies with Part 15 of the FCC Rules. Operation is subject to the following two conditions:

- This device may not cause harmful interference, and
- This device must accept any interference received including interference that may cause undesired operation.

This equipment has been tested and found to comply with the limits for a Class B digital device, pursuant to Part 15 of the FCC Rules. These limits are designed to provide reasonable protection against harmful interference in a residential installation. This equipment generates, uses and can radiate radio frequency energy and, if not installed and used in accordance with manufacturer's instructions, may cause harmful interference to radio communications. However, there is no guarantee that interference will not occur in a particular installation. If this equipment does cause harmful interference to radio or television reception, which can be determined by turning the equipment off and on, the user is encouraged to try to correct the interference by one or more of the following measures:

- Reorient or relocate the receiving antenna.
- Increase the separation between the equipment and receiver.
- Connect the equipment to an outlet on a circuit different from that to which the receiver is connected.
- Consult the dealer or an experienced radio/TV technician for help.



The use of shielded cables for connection of the monitor to the graphics card is required to assure compliance with FCC regulations. Changes or modifications to this unit not expressly approved by the party responsible for compliance could void the user's authority to operate this equipment.

Canadian Department of Communications Statement

This digital apparatus does not exceed the Class B limits for radio noise emissions from digital apparatus set out in the Radio Interference Regulations of the Canadian Department of Communications.

This class B digital apparatus complies with Canadian ICES-003.

Safety information

Electrical safety

- To prevent electrical shock hazard, disconnect the power cable from the electrical outlet before relocating the system.
- When adding or removing devices to or from the system, ensure that the power cables for the devices are unplugged before the signal cables are connected. If possible, disconnect all power cables from the existing system before you add a device.
- Before connecting or removing signal cables from the motherboard, ensure that all power cables are unplugged.
- Seek professional assistance before using an adapter or extension cord. These devices could interrupt the grounding circuit.
- Make sure that your power supply is set to the correct voltage in your area. If you are not sure about the voltage of the electrical outlet you are using, contact your local power company.
- If the power supply is broken, do not try to fix it by yourself. Contact a qualified service technician or your retailer.

Operation safety

- Before installing the motherboard and adding devices on it, carefully read all the manuals that came with the package.
- Before using the product, make sure all cables are correctly connected and the power cables are not damaged. If you detect any damage, contact your dealer immediately.
- To avoid short circuits, keep paper clips, screws, and staples away from connectors, slots, sockets and circuitry.
- Avoid dust, humidity, and temperature extremes. Do not place the product in any area where it may become wet.
- Place the product on a stable surface.
- If you encounter technical problems with the product, contact a qualified service technician or your retailer.



This symbol of the crossed out wheeled bin indicates that the product (electrical and electronic equipment) should not be placed in municipal waste. Check local regulations for disposal of electronic products.

About this guide

This user guide contains the information you need when installing and configuring the motherboard.

How this guide is organized

This guide contains the following parts:

- **Chapter 1: Product introduction**
This chapter describes the features of the motherboard and the new technology it supports.
- **Chapter 2: Hardware information**
This chapter lists the hardware setup procedures that you have to perform when installing system components. It includes description of the switches, jumpers, and connectors on the motherboard.
- **Chapter 3: Powering up**
This chapter describes the power up sequence and ways of shutting down the system.
- **Chapter 4: BIOS setup**
This chapter tells how to change system settings through the BIOS Setup menus. Descriptions of the BIOS items are also provided.
- **Chapter 5: Software support**
This chapter describes the contents of the support CD that comes with the motherboard package.
- **Chapter 6: ATI CrossFire™ support**
This chapter describes the ATI CrossFire™ feature and shows the graphics card installation procedures.
- **Appendix: CPU features**
The Appendix describes the CPU features and technologies that the motherboard supports.

Where to find more information

Refer to the following sources for additional information and for product and software updates.

1. **ASUS websites**
The ASUS website provides updated information on ASUS hardware and software products. Refer to the ASUS contact information.
2. **Optional documentation**
Your product package may include optional documentation, such as warranty flyers, that may have been added by your dealer. These documents are not part of the standard package.

Conventions used in this guide

To make sure that you perform certain tasks properly, take note of the following symbols used throughout this manual.



DANGER/WARNING: Information to prevent injury to yourself when trying to complete a task.



CAUTION: Information to prevent damage to the components when trying to complete a task.



IMPORTANT: Instructions that you **MUST** follow to complete a task.



NOTE: Tips and additional information to help you complete a task.

Typography

Bold text

Indicates a menu or an item to select.

Italics

Used to emphasize a word or a phrase.

<Key>

Keys enclosed in the less-than and greater-than sign means that you must press the enclosed key.

Example: <Enter> means that you must press the Enter or Return key.

<Key1+Key2+Key3>

If you must press two or more keys simultaneously, the key names are linked with a plus sign (+).

Example: <Ctrl+Alt+D>

Command

Means that you must type the command exactly as shown, then supply the required item or value enclosed in brackets.

Example: At the DOS prompt, type the command line:

```
afudos /i[filename]  
afudos /ip5wdh.rom
```

P5W DH Deluxe specifications summary

CPU	LGA775 socket for Intel® Pentium® 4/Celeron® processor Supports Intel® Pentium® Processor Extreme Edition and Intel® Pentium® D Processor Supports Intel® next generation 65 nm and Intel® Core™2 Duo/Intel® Core™2 Extreme processors Supports Intel® next generation Multi-Core processor Compatible with Intel® 05B/ 05A and 04B/04A processors Intel® EM64T and Hyper-Threading Technology ready
Chipset	Intel® 975X Intel® ICH7R
Front Side Bus	1066 / 800 MHz
Memory	Dual-channel memory architecture <ul style="list-style-type: none"> - 4 x 240-pin DIMM sockets support ECC/non-ECC DDR2 800/667/533 MHz memory modules - Supports up to 8 GB system memory Intel® MPT (Intel® Memory Pipeline Technology) ASUS Hyper Path3 Note: Visit the ASUS website at www.asus.com for the latest Qualified Vendors List (QVL).
Expansion slots	2 x PCI Express™ x16 slots for discrete graphics card 2 x PCI Express™ x1 slots 3 x PCI slots
CrossFire™	Supports ATI CrossFire™ graphics cards (both at x8 mode) ASUS Two-slot thermal design ASUS PEG Link
Advanced Thermal Design	ASUS 8-Phase Power Design ASUS Stack Cool 2 ASUS Fanless Design: Heat-pipe thermal solution
Storage/RAID	Intel® ICH7R Southbridge supports: <ul style="list-style-type: none"> - 1 x Ultra DMA 100/66/33 - 3 x Serial ATA 3.0 Gb/s devices with RAID 0, 1, 5 configuration - Intel® Matrix Storage Technology Jmicron® JMB363 Serial ATA controller supports: <ul style="list-style-type: none"> - 1 x External Serial ATA 3.0 Gb/s (SATA-on-the-Go) - 1 x Internal Serial ATA 3.0 Gb/s with RAID 0, 1 configuration with External Serial ATA 3.0 Gb/s - 1 x Ultra DMA 100/66/33 connector for two devices Note: Do not remove/unplug the External SATA device when running under RAID mode. Silicon Image® 4723 Hardware RAID controller (ASUS EZ-Backup) supports: <ul style="list-style-type: none"> - 2 x Serial ATA 3.0 Gb/s with RAID 0 and RAID 1 configuration

(continued on the next page)

P5W DH Deluxe specifications summary

Storage/RAID <i>(continued)</i>	Supports RAID 10 through cross-configuration between three (3) Serial ATA ports from Intel® ICH7R and one (1) Serial ATA port from Silicon Image® 4723 Hardware RAID controller
LAN	Marvell® 88E8053 dual Gigabit LAN controllers, both featuring AI NET2 Wireless LAN: 54 Mbps IEEE 802.11g (ASUS WiFi-AP Solo™)
High Definition Audio	Realtek® ALC882M 8-channel CODEC Supports Multi-Streaming, Jack-Sensing and Jack-Retasking Technology Anti-Pop Function Optical and Coaxial S/PDIF Out interfaces Features Dolby® Master Studio Technology <ul style="list-style-type: none"> - Dolby ProLogic IIX - Dolby Headphone - Dolby Virtual Speaker - Dolby Digital Live
IEEE 1394	TI 1394 controller supports: <ul style="list-style-type: none"> - 2 x IEEE 1394a connectors (1 at mid-board, 1 on the rear panel)
USB	Supports up to 8 USB 2.0/1.1 ports
ASUS Digital Home features	<p>ASUS EZ Backup™</p> <ul style="list-style-type: none"> - 2 x Serial ATA 3.0 Gb/s support hardware RAID 0 or RAID 1 mode - Plug and play: Default setting in RAID 1 mode requires no driver and no BIOS configuration <p>ASUS Wi-Fi AP Solo™</p> <ul style="list-style-type: none"> - 54 Mbps IEEE 802.11g, backward compatible with 11 Mbps IEEE 802.1b - Software Access Point mode - Station mode: Infrastructure mode and Ad-Hoc mode <p>ASUS DH Remote™</p> <ul style="list-style-type: none"> - Power - Quick Power - Noise off - EZ WiFi - AP Launch - Full Screen - Media Control Zone <p>ASUS MP3-In™</p>

(continued on the next page)

P5W DH Deluxe specifications summary

ASUS AI Life features	Stack Cool 2 patented fanless cooling system SATA-On-The-Go external Serial ATA port AI Quiet
ASUS Exclusive Overclocking features	<p>Intelligent overclocking tools:</p> <ul style="list-style-type: none"> - AI NOS™ (Non-delay Overclocking System) - AI Overclocking (intelligent CPU frequency tuner) - ASUS PEG Link (automatic performance tuning for single/dual graphics cards) <p>Precision Tweaker:</p> <ul style="list-style-type: none"> - vDIMM: 12-step DRAM voltage control - vCore: Adjustable CPU voltage at 0.0125 V increment - Stepless Frequency Selection(SFS) allows FSB tuning from 200 MHz up to 400 MHz at 1 MHz increment - PCI Express x16 frequency tuning from 90 MHz to 150 MHz at 1 MHz increment <p>Adjustable FSB/DDR ratio Fixed PCI/PCI Express frequencies Overclocking protection:</p> <ul style="list-style-type: none"> - ASUS C.P.R. (CPU Parameter Recall) <p>ASUS AI Booster Utility</p>
Other ASUS special features	ASUS CrashFree BIOS 3 ASUS EZ Flash 2 ASUS Q-Fan2 ASUS Multi-language BIOS ASUS MyLogo 2
Rear panel	1 x PS/2 keyboard port (purple) 1 x PS/2 mouse port (green) 1 x Serial port 1 x IEEE 1394a port 1 x External Serial ATA port 1 x Optical S/PDIF Out port 1 x Coaxial S/PDIF Out port 2 x LAN (RJ-45) ports 4 x USB 2.0/1.1 ports 1 x WiFi-AP Solo™ antenna jack 8-channel audio ports

(continued on the next page)

P5W DH Deluxe specifications summary

Internal connectors	2 x USB 2.0 connectors support four additional USB 2.0 ports 2 x IDE connectors 1 x Floppy disk drive connector 6 x Serial ATA connectors 1 x IEEE1394a connector 1 x CPU / 2 x Chassis / 2 x Power fan connectors 1 x Azalia Digital Header (ADH) Front panel High Definition Audio connector Chassis intrusion connector CD audio-in connector MP3 audio-in connector S/PDIF Out connector 24-pin ATX power connector 4-pin ATX12 V power connector System panel connector ASUS EZ Backup RAID selection mode jumper
BIOS features	8 Mb Flash ROM, AMI BIOS, PnP, DMI2.0, WfM2.0, SM BIOS 2.3, PXE & RPL
Manageability	WOL by PME, WOR by PME, Chassis Intrusion
Power requirements	ATX power supply (with 24-pin and 4-pin 12 V plugs) ATX 12 V 2.0 compliant
Support CD contents	Device Drivers Make RAID driver disk for Intel® ICH7R and JMicron® JMB 363 RAID Manuals for Intel® ICH7R, ASUS EZ-Backup, JMicron® JMB 363, and Cross-RAID (RAID 10) ASUS PC Probe 2 ASUS LiveUpdate Utility ASUS DH Remote application ASUS WiFi-AP Solo™ Wizard Anti-virus utility (OEM version) Intervideo® WinDVD® software
Form factor	ATX form factor: 12 in x 9.6 in (30.5 cm x 24.5 cm)

*Specifications are subject to change without notice.

This chapter describes the motherboard features and the new technologies it supports.

1 Product introduction

Chapter summary

1

1.1	Welcome!	1-1
1.2	Package contents.....	1-1
1.3	Special features.....	1-2

1.1 Welcome!

Thank you for buying an ASUS® P5W DH Deluxe motherboard!

The motherboard delivers a host of new features and latest technologies, making it another standout in the long line of ASUS quality motherboards!

Before you start installing the motherboard, and hardware devices on it, check the items in your package with the list below.

1.2 Package contents

Check your motherboard package for the following items.

ASUS Digital Home Accessories	
• ASUS DH Remote	●
• ASUS DH Remote receiver	●
• ASUS WiFi-AP Solo™ antenna	●
• ASUS EZ Backup SATA cables	2
• 2-in-1 SATA power cable	●
• ASUS MP3-In Module	●
Accessories	
• 1 x ASUS Q-Connector set (USB, IEEE 1394a, system panel) - for retail version only	●
• 1 x IEEE 1394a port module	●
• 2 x SATA cables	●
• 3 x SATA power cables for six devices	●
• 1 x Ultra DMA 133/100/66 cable	●
• 1 x IDE cable	●
• 1 x FDD cable	●
• 1 x 2-port USB 2.0 module	●
• 1 x Optional fan	●
• I/O shield	●
Documentation	
• User guide	●



If any of the above items is damaged or missing, contact your retailer.

1.3 Special features

1.3.1 Product highlights

Latest processor technology

This motherboard supports the latest Intel® Pentium® 4 processors in the LGA775 package. With 1066/ 800 MHz FSB, Hyper-Threading Technology support, and core-speeds of up to 3.8 GHz and beyond, Intel®'s LGA775 Pentium® 4 is among the fastest desktop processors to date. See page 2-7 for details.

Intel® Core™2 Duo/ Intel® Core™2 Extreme CPU support

This motherboard supports the latest powerful and energy efficient processors from Intel®. Intel® Core™2 Duo and Intel® Core™2 Extreme are based on the Intel® Core™ Microarchitecture and built on the 65-nanometer (nm) process technology with copper interconnect. Intel® Core™2 Duo and Intel® Core™2 Extreme allow users to step up to new levels of gaming experience and multi-tasking performance. Boosting performance is a shared and multi-core optimized L2 cache of 2 MB or 4 MB, guaranteeing enhanced user experience in the digital home and office. See page 2-7 for details.

Intel® 65 nm Dual-Core Technology CPU support

Dual-core processors contain two physical CPU cores with dedicated L2 caches to meet demands for more powerful processing. Intel®'s 65 nm process is the most advanced chip manufacturing technology, delivering breakthrough performance, enhanced media experience, and low power consumption. Intel® 65nm dual-core processors utilize the latest package technologies for a thinner, lighter design without compromising performance. See page 2-7 for details.

Intel® 975X/ICH7R chipset

The Intel® 975X Memory Controller Hub (MCH) and the ICH7R I/O controller hub provide the vital interfaces for the motherboard. The Intel® 975X supports up to 8 GB dual-channel DDR2-667/533 MHz, 1066/800 FSB, PCI Express x16 graphics, and dual-core CPU. The MCH supports the Intel® Memory Pipeline Technology (MPT) that boosts system performance.

The Intel® ICH7R Southbridge integrates four Serial ATA ports enabled through the Serial ATA 3 Gb/s RAID controller to ensure data security and enable powerful multi-task processing.



ATI Radeon® Xpress 200 CrossFire™

The ATI Radeon® Xpress 200 CrossFire™ boosts image quality and rendering speed, eliminating the need to crank down screen resolutions to get high quality images. The chipset allows higher antialiasing, anisotropic filtering, shading, and texture settings. ATI Radeon® Xpress 200 CrossFire™ features the ATI Catalyst™ Control Center that allows you to get real-time 3D-rendered previews of adjustments to your display configurations and advanced 3D settings. See Chapter 6 for details.



Intel® Memory Pipeline Technology (MPT)

The Intel® MPT increases system-level and standard operating performance by optimizing memory access between CPU and system memory.



Intel® EM64T

The motherboard supports Intel® Pentium® 4 CPUs with the Intel® EM64T (Extended Memory 64 Technology). The Intel® EM64T feature allows your computer to run on 64-bit operating systems and access larger amounts of system memory for faster and more efficient computing. See the Appendix for details.

Enhanced Intel SpeedStep® Technology (EIST)

The Enhanced Intel SpeedStep® Technology (EIST) intelligently manages the CPU resources by automatically adjusting the CPU voltage and core frequency depending on the CPU loading and system speed or power requirement. See page 4-25 and the Appendix for details.



PCI Express™ interface

The motherboard fully supports PCI Express, the latest I/O interconnect technology that speeds up the PCI bus. PCI Express features point-to-point serial interconnections between devices and allows higher clocks speeds by carrying data in packets. This high speed interface is software compatible with existing PCI specifications. See page 2-24 for details.

8-channel high definition audio



Onboard is the Realtek® ALC882M High Definition Audio 8-channel audio CODEC. This CODEC is fully-compliant with Intel® High Definition Audio standard (192 KHz, 24-bit audio). With the CODEC, 8-channel audio ports, and S/PDIF interfaces, you can connect your computer to home theater decoders to produce crystal-clear digital audio.

The Realtek® ALC882M CODEC comes with a software application that features jack detection to monitor the plugging status of each jack, impedance sensing to determine audio device classes, and pre-defined equalization for various audio devices. See pages 2-28, 2-29, and 5-13 for details.



Theater-level audio (designed for Dolby® Master Studio)

This motherboard offers theater-level 7.1 surround sound and audio specifications higher than that of DVD. Enjoy true home theatre experience with the following advanced sound technologies: Dolby® Prologic IIx, Dolby® Headphone, Dolby® Virtual Speaker, and Dolby® Digital Live. See page 5-18 for details.



IEEE 1394a support

The motherboard supports the IEEE 1394a interface that provides high-speed and flexible PC connectivity to a wide range of peripherals and devices compliant to IEEE 1394a standards. The IEEE 1394a interface allows up to 400 Mbps transfer rates through simple, low-cost, high-bandwidth asynchronous (real-time) data interfacing between computers, peripherals, and consumer electronic devices such as camcorders, VCRs, printers, TVs, and digital cameras. See pages 2-28 and 2-37 for details.

S/PDIF digital sound ready



The motherboard supports the S/PDIF technology through the S/PDIF interfaces on the rear panel. The S/PDIF technology turns your computer into a high-end entertainment system with digital connectivity to powerful audio and speaker systems. See page 2-30 for details.

USB 2.0 technology



The motherboard implements the Universal Serial Bus (USB) 2.0 specification, dramatically increasing the connection speed from the 12 Mbps bandwidth on USB 1.1 to a fast 480 Mbps on USB 2.0. USB 2.0 is backward compatible with USB 1.1. See pages 2-29 and 2-37 for details.

Multi-RAID solution

Onboard RAID controllers provide the motherboard with multiple RAID functionality that allows you to select the best RAID solution using Serial ATA devices.

- **ASUS EZ-Backup.** Enabled by Silicon Image's SiI4723 controller, ASUS EZ-Backup provides ready-to-go hardware RAID for plug-and play RAID 1 and easy-to-configure RAID 0 sets of two hard disk drives
- **Intel® ICH7R Southbridge RAID** provides RAID level 5 support for three or more hard disk drives.
- **Cross-RAID** allows you to build a RAID 10 set through a cross-configuration of ASUS EZ-Backup and Intel® ICH7R.
- **JMicron® RAID.** Enabled by JMicron® JMB363 controller, JMicron® RAID extends the advantages of software RAID beyond internal hard disk drives to an external disk or external, port-multiplier enabled enclosure.

Refer to Chapter 5 for details on how to configure RAID.



Dual Gigabit LAN solution

The motherboard comes with dual Gigabit LAN controllers to provide the total solution for your networking needs. These network controllers use the PCI Express segment to provide faster data bandwidth for your wired or wireless Internet, LAN, and file sharing requirements. See page 2-28 for details.

1.3.2 ASUS AI Life features



Serial ATA /II technology and SATA-On-The-Go



The motherboard fully supports the Serial ATA II 3.0 Gb/s technology through the Serial ATA interfaces and the Intel® ICH7R MCH. The Serial ATA 3 Gb/s specification provides twice the bandwidth of the current Serial ATA products with a host of new features, including Native Command Queueing (NCQ), and Power Management (PM) Implementation Algorithm. Serial ATA allows for thinner, more flexible cables with lower pin count and reduced voltage required.

Leveraging these Serial ATA 3.0 Gb/s features is the SATA-On-The-Go. Supported by the Jmicron® JMB363 Serial ATA controller are two Serial ATA 3.0 Gb/s connectors (one at mid-board and one on the rear panel) provide smart setup, and hot-plug function. See pages 2-29 and 2-34 for details.

AI Quiet



The ASUS AI Quiet function dynamically controls CPU speed and reduces temperature and fan speeds, thus minimizing noise and ensuring quiet operation. See page 4-35 for details.

ASUS Stack Cool 2



ASUS Stack Cool 2 is a fan-less and zero-noise cooling solution that lowers the temperature of critical heat generating components by 20°C. The motherboard uses a special design on the printed circuit board (PCB) to dissipate heat that critical components generate. See page 2-3 for details.

1.3.3 Innovative ASUS features

AI NOS™ (Non-Delay Overclocking System)



ASUS Non-delay Overclocking System™ (NOS) is a technology that auto-detects the CPU loading and dynamically overclocks the CPU speed only when needed. See page 4-21 for details.

AI NET2



AI NET2 is a BIOS-based diagnostic tool that detects and reports Ethernet cable faults and shorts. With this utility, you can easily monitor the condition of the Ethernet cable connected to the LAN (RJ-45) port. During the bootup process, AI NET2 immediately diagnoses the LAN cable and reports shorts and faults up to 100 meters at 1 meter accuracy. See pages 4-22 and 5-12 for details.

8-Phase Power Design



The ASUS 8-Phase Power Design prolongs CPU lifespan and keeps the system stable by preventing high power stress to the CPU and power supply module. The design ensures high efficiency operation to generate less heat compared with conventional power solutions, thus achieving cool system environment and making this motherboard ideal for overclocking.

Fanless Design and Heat-pipe



The ASUS fanless design allows multi-directional heat flow from major thermal sources in the motherboard to lower overall system temperature, resulting in quieter operation and longer system life. ASUS has devoted special efforts to address the thermal issues across the motherboard, and most notably in the following areas: CPU, power, VGA, Northbridge and Southbridge. The heat pipe, heatsink, and strategic board layout were tailor made to dissipate heat in the most efficient manner.

ASUS exclusive two-slot thermal design

ASUS two-slot thermal design provides better air-flow and lower VGA cards temperature than other brands' one-slot design, which also ensures better system stability and longer component life cycle.



Precision Tweaker



This feature allows you to fine-tune the CPU/memory voltage and gradually increase the Front Side Bus (FSB) and PCI Express frequency to achieve maximum system performance.

PEG Link Mode



This feature enhances your PCI Express graphics card performance by allowing the motherboard to automatically adjust the PCI Express graphics link mode to the correct frequency based on the system configuration. Four additional settings are available for overclocking the PEG Link Mode. See page 4-27 for details.

ASUS Hyper Path 3



This feature significantly shortens latency time during data transfers, allowing users to experience the real power of their computers. See page 4-27 for details.

CrashFree BIOS 3



The ASUS CrashFree BIOS 3 allows users to restore corrupted BIOS data from a USB flash disk containing the BIOS file. This utility saves users the cost and hassle of buying a replacement BIOS chip. See page 4-9 for details.

ASUS EZ Flash 2



ASUS EZ Flash 2 is a user-friendly BIOS update utility. Simply press the predefined hotkey to launch the utility and update the BIOS without entering the OS. Update your BIOS easily without preparing a bootable diskette or using an OS-based flash utility. See page 4-5 for details.

ASUS Q-Fan 2 technology



The ASUS Q-Fan 2 technology smartly adjusts the fan speeds according to the system loading to ensure quiet, cool, and efficient operation. See page 4-36 for details.

ASUS Multi-language BIOS



The multi-language BIOS allows you to select the language of your choice from the available options. The localized BIOS menus allow easier and faster configuration. See page 4-13 for details.

ASUS MyLogo 2



ASUS My Logo 2 is the new feature present in the motherboard that allows you to personalize and add style to your system with customizable and animated boot logos. See pages 4-40 and 5-10 for details.

ASUS Music Alarm



Wake up to the music of your choice instead of the irritating sound of an alarm clock. The ASUS Music Alarm gives you a personal wake-up call with your favorite CD music without having to enter the OS. See page 4-43 and 5-26 for details.

ASUS Q-Connector



You can use ASUS Q-Connector to connect/disconnect chassis front panel cables by only a few easy steps. See pages 2-43 for details.

1.3.4 Digital Home features Digital HOME

ASUS WiFi-AP Solo™



WiFi AP Solo™ allows a new level of versatility for your PC, enabling it to create a complete wireless home network in either AP or wireless client mode. Users will be able to play LAN games, connecting to the Internet, access and share printers, and use Skype from anywhere within range. WiFi-AP Solo™ can provide these functions even when the PC is in sleep mode, so users can use Skype as a true replacement for traditional long distance telephone service. WiFi-AP Solo™ is an on-board feature, which means that users will save the extra WiFi-AP cost. (Refer to the ASUS Wi-Fi AP Solo™ user guide for details.)

ASUS DH Remote™



DH Remote™ is a convenient PC remote controller that gives users unprecedented control over their PCs from the comfort of their couches. With the touch of a button, users can instantly operate the following functions: (Refer to the ASUS DH Remote™ user guide for details.)

Power: Turns the computer on/off.

Quick Power: Puts the computer quickly into sleep mode.

Noise Off: Reduces the noise coming from the computer.

EZ WiFi: Puts the computer quickly into sleep mode but allowing WiFi-AP Solo™ to still operate.

Full Screen: Puts the media application into full screen.

AP Launch: Launches the media application.

Media Control Zone: Controls the media application.

ASUS MP3-In™



A convenient interface between computers and MP3 players, the ASUS MP3-In™ features enables MP3 players to connect to PC speakers even when the PC power is off, which means that users can enjoy the sound quality from PC speakers without additional stereo equipment cost. (Refer to the ASUS MP3-In™ quick installation guide for details.)

ASUS EZ Backup™



ASUS EZ Backup requires no driver or BIOS configuration. ASUS EZ Backup offers plug and play RAID to backup your data instantaneously. Exclusive to ASUS and the first of its kind in the world, EZ Backup allows users to utilize SATA2 technology to build RAID 1 (default) or RAID 0 without requiring any BIOS setup or any other configuration. ASUS EZ Backup is ideal for anyone who wants to secure data on the hard drive but does not want the hassle of complicated software configuration. See section “5.4.4 Silicon Image® RAID configuration” for details.

This chapter lists the hardware setup procedures that you have to perform when installing system components. It includes description of the jumpers and connectors on the motherboard.

Hardware ² information

2.1	Before you proceed	2-1
2.2	Motherboard overview.....	2-2
2.3	Central Processing Unit (CPU)	2-7
2.4	System memory	2-14
2.5	Expansion slots.....	2-22
2.6	Jumpers	2-26
2.7	Connectors	2-28

2.1 Before you proceed

Take note of the following precautions before you install motherboard components or change any motherboard settings.



- Unplug the power cord from the wall socket before touching any component.
- Use a grounded wrist strap or touch a safely grounded object or a metal object, such as the power supply case, before handling components to avoid damaging them due to static electricity.
- Hold components by the edges to avoid touching the ICs on them.
- Whenever you uninstall any component, place it on a grounded antistatic pad or in the bag that came with the component.
- Before you install or remove any component, ensure that the ATX power supply is switched off or the power cord is detached from the power supply. Failure to do so may cause severe damage to the motherboard, peripherals, and/or components.

Onboard LED

The motherboard comes with a standby power LED. The green LED lights up to indicate that the system is ON, in sleep mode, or in soft-off mode. This is a reminder that you should shut down the system and unplug the power cable before removing or plugging in any motherboard component. The illustration below shows the location of the onboard LED.

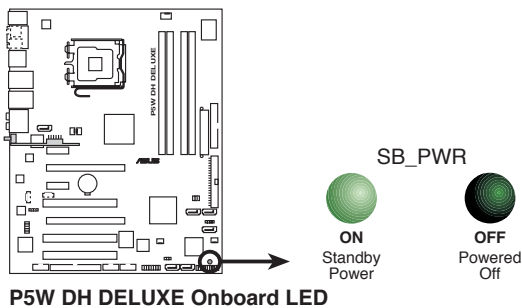

2.2 Motherboard overview

Before you install the motherboard, study the configuration of your chassis to ensure that the motherboard fits into it.



Make sure to unplug the power cord before installing or removing the motherboard. Failure to do so can cause you physical injury and damage motherboard components.

2.2.1 Placement direction

When installing the motherboard, make sure that you place it into the chassis in the correct orientation. The edge with external ports goes to the rear part of the chassis as indicated in the image below.

2.2.2 Screw holes

Place nine (9) screws into the holes indicated by circles to secure the motherboard to the chassis.



Do not overtighten the screws! Doing so can damage the motherboard.

Place this side towards the rear of the chassis

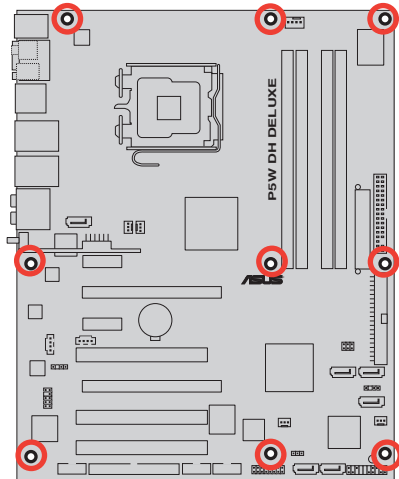

2.2.3 ASUS Stack Cool 2

The motherboard comes with the ASUS Stack Cool 2 cooling solution that lowers the temperature of critical heat generating components by 20°C. The motherboard uses a special design on the printed circuit board (PCB) to dissipate heat that critical components generate.

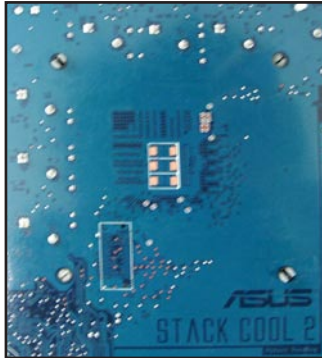

2.2.4 Motherboard layout

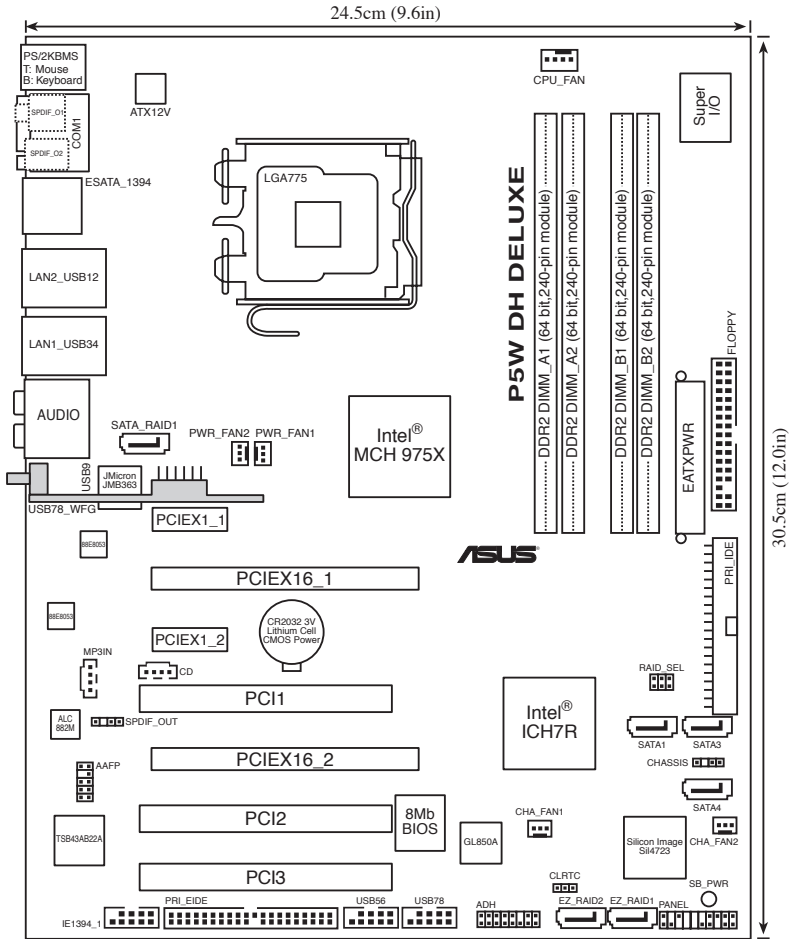

2.2.5 Layout contents

Slots		Page
1.	DDR2 DIMM slots	2-14
2.	PCI slots	2-24
3.	PCI Express x1 slot	2-24
4.	PCI Express x16 slots	2-24

Jumpers		Page
1.	Clear RTC RAM (3-pin CLRTC)	2-26
2.	ASUS EZ-Backup RAID mode selection (RAID_SEL)	2-27

Rear panel connectors		Page
1.	PS/2 mouse port (green)	2-28
2.	Serial port	2-28
3.	IEEE 1394a port	2-28
4.	LAN1 (RJ-45) port	2-28
5.	LAN2 (RJ-45) port	2-28
6.	Center/Subwoofer port (yellow orange)	2-28
7.	Rear Speaker Out port (black)	2-28
8.	Line In port (light blue)	2-29
9.	Line Out port (lime)	2-29
10.	Microphone port (pink)	2-29
11.	Side Speaker Out port (gray)	2-29
12.	USB 2.0 ports 1,2, 3, and 4	2-29
13.	External SATA port	2-29
14.	Optical S/PDIF Out port	2-30
15.	Coaxial S/PDIF Out port	2-30
16.	PS/2 keyboard port (purple)	2-30
17.	Antenna jack	2-30
18.	ASUS Wi-Fi AP Solo™ LED indicator	2-30

Internal connectors		Page
1.	Floppy disk drive connector (34-1 pin FLOPPY)	2-31
2.	JMicron® IDE connector (40-1 pin PRI_EIDE [black])	2-31
3.	Intel® ICH7R IDE connector (40-1 pin PRI_IDE)	2-32
4.	Intel® ICH7R Serial ATA connectors (7-pin SATA1 [red], SATA3 [black], SATA4 [black],)	2-33
5.	JMicron® JMB363 Serial ATA connector (7-pin SATA_RAID1 [red])	2-34
6.	ASUS EZ-Backup Serial ATA connectors (7-pin EZ_RAID1 [orange], EZ_RAID2 [orange])	2-35
7.	MP3-In connector (4-pin MP3IN)	2-35
8.	Internal audio connector (4-pin CD)	2-36
9.	Front panel audio connector (10-1 pin AAFP)	2-36
10.	USB connector (10-1 pin USB56, USB78)	2-37
11.	IEEE 1394a port connector (10-1 pin IE1394_1 [Red])	2-37
12.	Chassis intrusion connector (4-1 pin CHASSIS)	2-38
13.	CPU, Chassis, and Power Fan connectors (4-pin CPU_FAN, 3-pin PWR_FAN1, 3-pin PWR_FAN2, 3-pin CHA_FAN1, 3-pin CHA_FAN2)	2-38
14.	ATX power connectors (24-pin EATXPWR, 4-pin ATX12V)	2-40
15.	System panel connector (20-pin PANEL) <ul style="list-style-type: none"> • System power LED (2-pin PLED) • Hard disk drive activity LED (2-pin IDE_LED) • System warning speaker (4-pin SPEAKER) • ATX power button/soft-off button (2-pin PWRSW) • Reset button (2-pin RESET) 	2-42

2.3 Central Processing Unit (CPU)

The motherboard comes with a surface mount LGA775 socket designed for the Intel® Pentium® 4/Celeron®/Intel® Pentium® D and the Intel® next generation 65 nm Intel® Core™2 Duo and Intel® Core™2 Extreme multi-core processor in the 775-land package.

This motherboard also supports the Intel® Pentium® Processor Extreme Edition, the latest CPU with embedded dual physical cores and Hyper-Threading technology, making four CPU threads possible. Refer to the table below for the operating system support status.

OS licensing support list	
Intel® Dual-Core CPU support	Intel® Dual-Core CPU and Hyper-Threading Technology support
Windows® 2000 Professional	
Windows® 2000 Advanced Server	Windows® 2000 Advanced Server
Windows® XP Home	Windows® XP Home
Windows® XP Professional	Windows® XP Professional
Windows® Server 2003 - Standard, Enterprise	Windows® Server 2003 - Standard, Enterprise



- If installing a dual-core CPU, connect the chassis fan cable to the PWR_FAN1/2 or CHA_FAN1/2 connector to ensure system stability.
- Install a chassis fan with at least a speed of 2400 rpm and 8 CFM turnrate when using a dual-core CPU to ensure system stability. Overheating can permanently damage the system and/or CPU.
- Install an additional chassis fan to ensure better air flow when overclocking.
- Upon purchase of the motherboard, make sure that the PnP cap is on the socket and the socket contacts are not bent. Contact your retailer immediately if the PnP cap is missing, or if you see any damage to the PnP cap/socket contacts/motherboard components. ASUS will shoulder the cost of repair only if the damage is shipment/transit-related.
- Keep the cap after installing the motherboard. ASUS will process Return Merchandise Authorization (RMA) requests only if the motherboard comes with the cap on the LGA775 socket.
- The product warranty does not cover damage to the socket contacts resulting from incorrect CPU installation/removal, or misplacement/loss/incorrect removal of the PnP cap.

2.3.1 Installing the CPU

To install a CPU:

1. Locate the CPU socket on the motherboard.

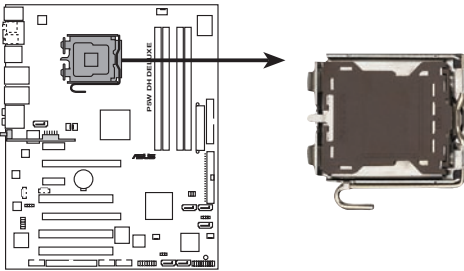

P5W DH DELUXE CPU Socket 775



Before installing the CPU, make sure that the cam box is facing towards you and the load lever is on your left.

2. Press the load lever with your thumb (A), then move it to the left (B) until it is released from the retention tab.

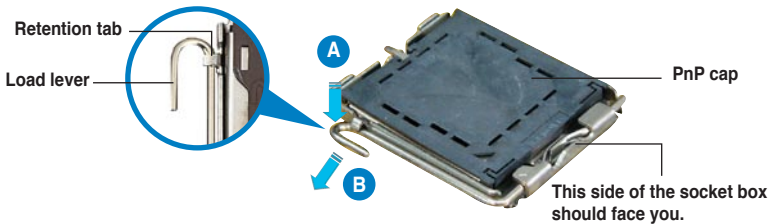

To prevent damage to the socket pins, do not remove the PnP cap unless you are installing a CPU.

3. Lift the load lever in the direction of the arrow to a 135° angle.

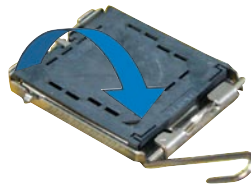

- Lift the load plate with your thumb and forefinger to a 100° angle (A), then push the PnP cap from the load plate window to remove (B).

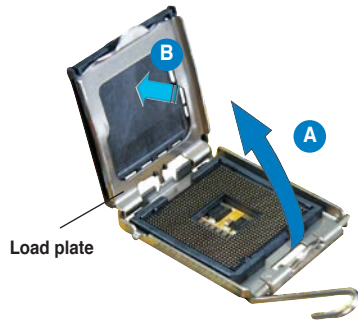

- Position the CPU over the socket, making sure that the gold triangle is on the bottom-left corner of the socket then fit the socket alignment key into the CPU notch.

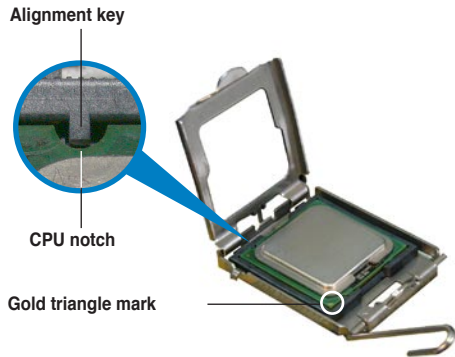

The CPU fits in only one correct orientation. DO NOT force the CPU into the socket to prevent bending the connectors on the socket and damaging the CPU!

- Close the load plate (A), then push the load lever (B) until it snaps into the retention tab.
- If installing a dual-core CPU, connect the chassis fan cable to the PWR_FAN1/2 or CHA_FAN1/2 connector to ensure system stability.

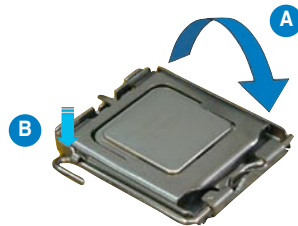

The motherboard supports Intel® Pentium® 4 LGA775 processors with the Intel® Enhanced Memory 64 Technology (EM64T), Enhanced Intel SpeedStep® Technology (EIST), and Hyper-Threading Technology. Refer to the Appendix for more information on these CPU features.

2.3.2 Installing the CPU heatsink and fan

The Intel® Pentium® 4 LGA775 processor requires a specially designed heatsink and fan assembly to ensure optimum thermal condition and performance.



- When you buy a boxed Intel® Pentium® 4 processor, the package includes the CPU fan and heatsink assembly. If you buy a CPU separately, make sure that you use only Intel®-certified multi-directional heatsink and fan.
- Your Intel® Pentium® 4 LGA775 heatsink and fan assembly comes in a push-pin design and requires no tool to install.
- If you purchased a separate CPU heatsink and fan assembly, make sure that you have properly applied Thermal Interface Material to the CPU heatsink or CPU before you install the heatsink and fan assembly.



Make sure that you have installed the motherboard to the chassis before you install the CPU fan and heatsink assembly.

To install the CPU heatsink and fan:

1. Place the heatsink on top of the installed CPU, making sure that the four fasteners match the holes on the motherboard.



Orient the heatsink and fan assembly such that the CPU fan cable is closest to the CPU fan connector.

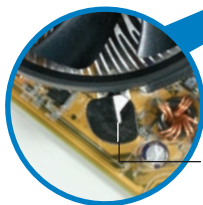

Narrow end of the groove

Motherboard hole
Fastener



Make sure to orient each fastener with the narrow end of the groove pointing outward. (The photo shows the groove shaded for emphasis.)

2. Push down two fasteners at a time in a diagonal sequence to secure the heatsink and fan assembly in place.

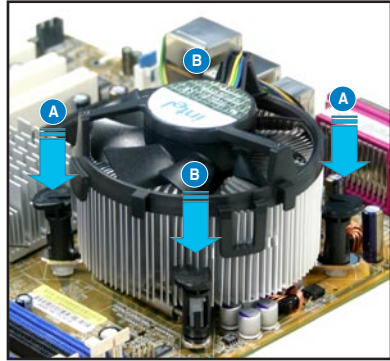
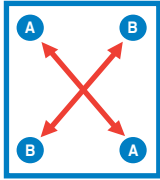

3. Connect the CPU fan cable to the connector on the motherboard labeled CPU_FAN.

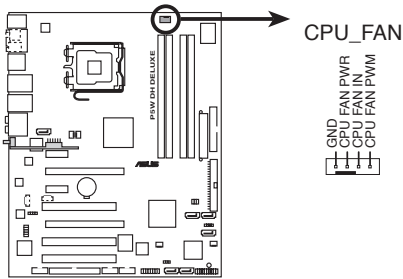

P5W DH DELUXE CPU fan connector



Do not forget to connect the CPU fan connector! Hardware monitoring errors can occur if you fail to plug this connector.

2.3.3 Uninstalling the CPU heatsink and fan

To uninstall the CPU heatsink and fan:

1. Disconnect the CPU fan cable from the connector on the motherboard.
2. Rotate each fastener counterclockwise.

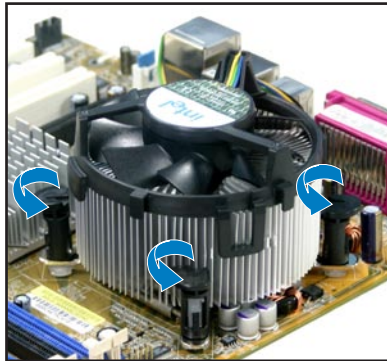

3. Pull up two fasteners at a time in a diagonal sequence to disengage the heatsink and fan assembly from the motherboard.

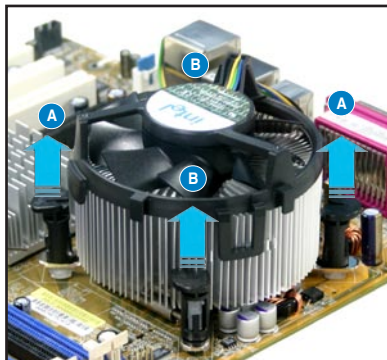
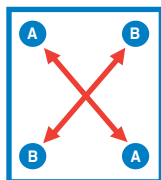

4. Carefully remove the heatsink and fan assembly from the motherboard.

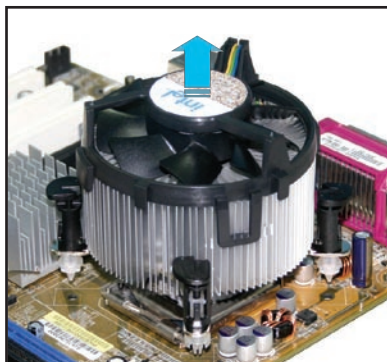

5. Rotate each fastener clockwise to ensure correct orientation when reinstalling.

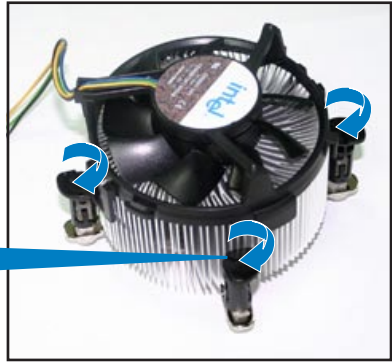
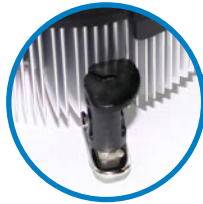

Narrow end of the groove



The narrow end of the groove should point outward after resetting. (The photo shows the groove shaded for emphasis.)

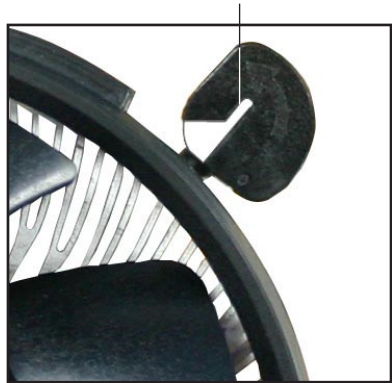

Refer to the documentation in the boxed or stand-alone CPU fan package for detailed information on CPU fan installation.

2.4 System memory

2.4.1 Overview

The motherboard comes with four Double Data Rate 2 (DDR2) Dual Inline Memory Modules (DIMM) sockets.

A DDR2 module has the same physical dimensions as a DDR DIMM but has a 240-pin footprint compared to the 184-pin DDR DIMM. DDR2 DIMMs are notched differently to prevent installation on a DDR DIMM socket.

The figure illustrates the location of the DDR2 DIMM sockets:

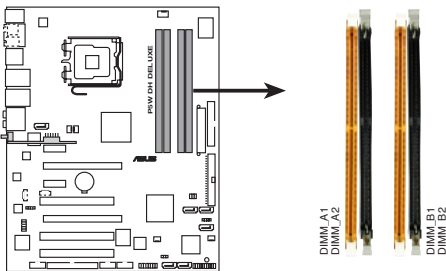

P5W DH DELUXE 240-pin DDR2 DIMM sockets

Channel	Sockets
Channel A	DIMM_A1 and DIMM_A2
Channel B	DIMM_B1 and DIMM_B2

2.4.2 Memory configurations

You may install 256 MB, 512 MB, 1 GB, and 2 GB unbuffered ECC/non-ECC DDR2 DIMMs into the DIMM sockets.



- For dual-channel configuration, the total size of memory module(s) installed per channel must be the same (DIMM_A1 + DIMM_A2 = DIMM_B1 + DIMM_B2).
- Always install DIMMs with the same CAS latency. For optimum compatibility, it is recommended that you obtain memory modules from the same vendor. Visit the ASUS website (www.asus.com) for the latest Qualified Vendors List.
- For dual-channel memory configuration, install the DIMMs in slots DIMM_B1 and DIMM_A1 (orange slots); install another pair of DIMMs in slots DIMM_B2 and DIMM_A2 (black slots).



Important notice on installing Windows® XP 32-bit version

If you install Windows® XP 32-bit version Operating System (OS), the limitation of this OS version is that it may reserve a certain amount of memory space for system devices. We recommend that you install less than 3 GB system memory if you would like to work under Windows® XP 32-bit version OS. The excess memory installation will not cause any usage problem, but it will not give users the benefit of manipulating this excess memory space.

Visit the ASUS FAQ site for further explanation:

<http://support.asus.com/faq/faq.aspx?SLanguage=en-us>

Under **General Search**, make the selections as shown, then click **Search**.

Click the article titled **"4GB memory installed but less memory size detected."**

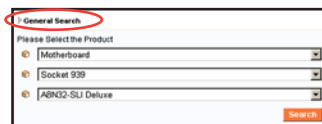

You also may check the URLs below for third party comments on this issue:

http://dlsvr01.asus.com/pub/ASUS/mb/4GB_Rev1.pdf

<http://www.intel.com/support/motherboards/server/sb/cs-016594.htm>



Notes on memory limitations

- Due to chipset limitation, this motherboard can only support up to 8 GB on the operating systems listed below. You may install a maximum of 2 GB DIMMs on each slot.

32-bit	64-bit
Windows® 2000 Advanced Server	Windows® Server 2003 Standard x64 Edition
Windows® Server 2003 Enterprise Edition	Windows® XP Professional x64 Enterprise Edition Windows® Server 2003 Enterprise x64 Edition

- Some old-version DDR2-667 DIMMs may not match Intel®'s On-Die-Termination (ODT) requirement and will automatically downgrade to run at DDR2-533. If this happens, contact your memory vendor to check the ODT value.
- Due to chipset limitation, DDR2-667 with CL=4 will be downgraded to run at DDR2-533 by default setting. If you want to operate with lower latency, adjust the memory timing manually.
- Due to chipset limitation, DDR2-533 with CL=3 will be downgraded to run at DDR2-400 by default setting. If you want to operate with lower latency, adjust the memory timing manually.

Qualified Vendors Lists

DDR2-800

Size	Vendor	Chip No.	Chip brand	Side(s)	Part No.	CL	DIMM socket support (Optional)		
							A*	B*	C*
512 MB	KINGSTON	Heat-Sink Package	-	SS	KHX6400D2/512	-	•	•	
512 MB	KINGSTON	K4T51083QC	-	SS	KVR800D2N5/512	-			
1024 MB	KINGSTON	K4T51083QC	-	DS	KVR800D2N5/1G	-		•	•
256 MB	SAMSUNG	K4T56083QF-ZCE7	-	SS	M378T3253FZ3-CE7	-	•	•	
256 MB	SAMSUNG	K4T56083QF-ZCE7(ECC)	-	SS	M391T3253FZ3-CE7	-			
512 MB	SAMSUNG	EDD339XX	-	SS	M378T6553CZ3-CE7	-	•	•	
512 MB	Infineon	HYB18T256800AF25	-	DS	HYS64T64520HU-2.5-A	-	•	•	•
512 MB	Hynix	HY5PS12821AFP-S6	-	SS	HYMP564U64AP8-S6	-			
1024 MB	Hynix	HY5PS12821AFP-S6	-	DS	HYMP512U64AP8-S6	-			
512 MB	MICRON	5JAIJ29DQQ	-	SS	MT8HTF6464AY-80EA3	-	•	•	•
1024 MB	MICRON	5JAIJ29DQQ	-	DS	MT16HTF12864AY-80EA3	-	•	•	•
512 MB	CORSAIR	Heat-Sink Package	-	SS	CM2X512A-6400	-			
1024 MB	CORSAIR	Heat-Sink Package	-	DS	CM2X1024-6400PRO	-	•	•	•
256 MB	A-DATA	E2508AB-GE-E	-	SS	M20EL6F3G3170A1D0Z	-	•	•	
256 MB	A-DATA	E2508AB-GE-E	-	SS	M20EL6F3G3160A1D0Z	-			
256 MB	A-DATA	E2508AB-GE-E	-	SS	M20EL6F3G3160A1D0Z	-	•		
512 MB	A-DATA	E2508AB-GE-E	-	DS	M20EL6F3H4170A1D0Z	-			
256 MB	Apacer	E2508AB-GE-E	-	SS	78.81091.420	-	•	•	
512 MB	Apacer	E2508AB-GE-E	-	DS	78.91091.420	-			
512 MB	Crucial	Heat-Sink Package	-	SS	BL6464AA804.8FA	-			
1024 MB	Crucial	Heat-Sink Package	-	DS	BL12864AA804.16FA	-		•	
256 MB	TwinMOS	E2508AB-GE-E	-	SS	8G-24IK2-EBT	-			
512 MB	OCZ	Heat-Sink Package	-	SS	OCZ28001024EBDCPE-K	-			
512 MB	Elixir	N2TU51280AE-25C	-	SS	M2Y51264TU88A2B-25C	-			
512 MB	NANYA	NT5TU64M8AE-25C	-	SS	NT512T64U88A1BY-25C	-			
512 MB	NANYA	NT5TU64M8BE-25C	-	SS	NT512T64U88B0BY-25C	-			
1024 MB	NANYA	NT5TU64M8BE-25C	-	DS	NT1GT64U88B0BY-25C	-			

Side(s): SS - Single-sided DS - Double-sided

DIMM support:

- A - Supports one module inserted into either slot, in Single-channel memory configuration.
- B - Supports one pair of modules inserted into either the orange slots or the black slots as one pair of Dual-channel memory configuration.
- C - Supports two pairs of modules inserted into both the orange and black slots as two pairs of Dual-channel memory configuration.



Visit the ASUS website for the latest DDR2-800 with lower latency Qualified Vendors List.

DDR2-667

Size	Vendor	Chip No.	Chip brand	Side(s)	Part No.	CL	DIMM socket support (Optional)		
							A*	B*	C*
512MB	KINGSTON	E5108AE-6E-E	-	SS	K-R667D2N5/512	-	*	*	*
1024MB	KINGSTON	E5108AE-6E-E	-	DS	K-R667D2N5/1G	-	*	*	*
512MB	KINGSTON	E5108AE-6E-E	-	SS	K-R667D2E5/512	-	*	*	*
256MB	KINGSTON	HYB18T256800AF3	-	SS	K-R667D2N5/256	-	*	*	*
256MB	SAMSUNG	K4T56083QF-ZCE6	-	SS	M378T3253FZ0-CE6	-	*	*	*
512MB	SAMSUNG	K4T56083QF-ZCE6	-	DS	M378T6453FZ0-CE6	-	*	*	*
256MB	SAMSUNG	K4T56083QF-ZCE6(ECC)	-	SS	M391T3253FZ0-CE6	-	*	*	*
512MB	SAMSUNG	K4T56083QF-ZCE6(ECC)	-	DS	M391T6453FZ0-CE6	-	*	*	*
256MB	SAMSUNG	K4T51163QC-ZCE6	-	SS	M378T3354CZ0-CE6	-	*	*	*
512MB	SAMSUNG	ZCE6K4T51083QC	-	SS	M378T6553CZ0-CE6	-	*	*	*
1024MB	SAMSUNG	ZCE6K4T51083QC	-	DS	M378T2953CZ0-CE6	-	*	*	*
512MB	MICRON	4-B41D9CZM	-	DS	MT16HTF6464AY-667B4	-	*	*	*
256MB	Infineon	HYB18T512160AF-3S	-	SS	HYS64T32000HU-3S-A	-	*	*	*
512MB	Infineon	HYB18T512800AF3S	-	SS	HYS64T64000HU-3S-A	-	*	*	*
1024MB	Infineon	HYB18T512800AF3S	-	DS	HYS64T128020HU-3S-A	-	*	*	*
256MB	Infineon	HYB18T256800AF3S(ECC)	-	SS	HYS72T32000HU-3S-A	-	*	*	*
512MB	Infineon	HYB18T512800AF3S(ECC)	-	SS	HYS72T64000HU-3S-A	-	*	*	*
1024MB	Infineon	HYB18T512800AF3S(ECC)	-	DS	HYS72T128020HU-3S-A	-	*	*	*
512MB	Hynix	HY5PS12821AFP-Y5	-	SS	HYMP564U64AP8-Y5	-	*	*	*
1024MB	Hynix	HY5PS12821AFP-Y5	-	DS	HYMP512U64AP8-Y5	-	*	*	*
1024MB	Hynix	HY5PS1G831FP-Y5(ECC)	-	SS	HYMP112U72P8-Y5	-	*	*	*
512MB	Hynix	HY5PS12821AFP-Y5(ECC)	-	SS	HYMP564U72AP8-Y5	-	*	*	*
1024MB	Hynix	HY5PS12821AFP-Y5(ECC)	-	DS	HYMP512U72AP8-Y5	-	*	*	*
512MB	Hynix	HY5PS12821AFP-Y4	-	SS	HYMP564U64AP8-Y4	-	*	*	*
1024MB	Hynix	HY5PS12821AFP-Y4	-	DS	HYMP512U64AP8-Y4	-	*	*	*
512MB	Hynix	HY5PS12821AFP-Y4(ECC)	-	SS	HYMP564U72AP8-Y4	-	*	*	*
1024MB	Hynix	HY5PS12821AFP-Y4(ECC)	-	DS	HYMP512U72AP8-Y4	-	*	*	*
256MB	ELPIDA	E2508AB-6E-E	-	SS	EBE25UC8ABFA-6E-E	-	*	*	*
512MB	ELPIDA	E5108AE-6E-E	-	SS	EBE51UD8AEFA-6E-E	-	*	*	*
1024MB	ELPIDA	Engineering Sample	-	DS	EBE11UD8AEFA-6E-E	-	*	*	*
512MB	crucial	Heat-Sink Package	-	DS	BL6464AA664.16FB	-	*	*	*
1024MB	crucial	Heat-Sink Package	-	DS	BL12864AA664.16FA	-	*	*	*
512MB	crucial	Heat-Sink Package	-	DS	BL6464AL664.16FB	-	*	*	*
1024MB	crucial	Heat-Sink Package	-	DS	BL12864AL664.16FA	-	*	*	*
512MB	crucial	Heat-Sink Package	-	DS	BL6464AA663.8FA	-	*	*	*
1024MB	crucial	Heat-Sink Package	-	DS	BL12864AA663.16FA	-	*	*	*
512MB	Kingmax	E5108AE-6E-E	-	SS	KLCC28F-A8EB5	-	*	*	*
1024MB	Kingmax	E5108AE-6E-E	-	DS	KLCD48F-A8EB5	-	*	*	*
512MB	Apacer	E5108AE-6E-E	-	SS	78.91092.420	-	*	*	*
1024MB	Apacer	E5108AE-6E-E	-	DS	78.01092.420	-	*	*	*
512MB	A-DATA	E5108AE-6E-E	-	SS	M20EL5G3H3160B1C0Z	-	*	*	*
512MB	TwinMOS	E5108AE-GE-E	-	SS	8G-25JK5-EBT	-	*	*	*
512MB	GEIL	Heat-Sink Package	-	SS	GX21GB5300UDC	-	*	*	*

(continued on the next page)

DDR2-667

Size	Vendor	Chip No.	Chip brand	Side(s)	Part No.	CL	DIMM socket support (Optional)		
							A*	B*	C*
512MB	GEIL	Heat-Sink Package	-	SS	GX21GB5300DC	-			
256MB	NANYA	NT5TU32M16AG-3C	-	SS	NT256T64UH4A0FY-3C	-			
512MB	NANYA	NT5TU64M8AE-3C	-	SS	NT512T64U88A0BY-3C	-			
512MB	NANYA	NT5TU64M8BE-3B	-	SS	NT512T64U88B0BY-3C	-			
1024MB	NANYA	NT5TU64M8BE-3B	-	DS	NT1GT64U8HB0BY-3C	-			
512MB	Elixir	N2TU51280AF-3C	-	SS	M2U51264TU88A0F-3C	-			
1024MB	Elixir	N2TU51280AF-3C	-	DS	M2U1G64TU8HA2F-3C	-			
512MB	OCZ	Heat-Sink Package	-	SS	OCZ28671024EBDCPE-K	-			
1024MB	OCZ	Heat-Sink Package	-	DS	OCZ28672048EBDCPE-K	-			
1024MB	PQI	E5108AE-5C-E	-	DS	MEAD-403LA	-			
512MB	WINTEC	4UAI2D9CRZ	-	SS	39127282	-			
1024MB	WINTEC	4WAIID9CWX	-	DS	39137282	-			
512MB	MDT	18D51280D-30518	-	SS	M512-667-8	-			
1024MB	MDT	18D51280D-30528	-	DS	M924-667-16	-			
512MB	Kingbox	DD2640800-667	-	SS	-	-			
1024MB	Kingbox	DD2640800-667	-	DS	-	-			

Side(s): SS - Single-sided DS - Double-sided

DIMM support:

- A - Supports one module inserted into either slot, in Single-channel memory configuration.
- B - Supports one pair of modules inserted into either the orange slots or the black slots as one pair of Dual-channel memory configuration.
- C - Supports two pairs of modules inserted into both the orange and black slots as two pairs of Dual-channel memory configuration.



Visit the ASUS website for the latest DDR2-667 with lower latency Qualified Vendors List.

DDR2-533

Size	Vendor	Chip No.	Chip brand	Side(s)	Part No.	CL	DIMM socket support (Optional)		
							A*	B*	C*
256 MB	KINGSTON	E5116AF-5C-E	-	SS	KVR533D2N4/256	-			
512 MB	KINGSTON	HYB18T512800AF37	-	SS	KVR533D2N4/512	-	*	*	*
1024 MB	KINGSTON	5YDIIID9GCT	-	DS	KVR533D2N4/1G	-	*	*	*
512 MB	SAMSUNG	K4T51083QB-GCD5	-	SS	M378T6553BG0-CD5	-	*		
256 MB	SAMSUNG	K4T56083QF-GCD5	-	SS	M378T3253FG0-CD5	-	*	*	
512 MB	SAMSUNG	K4T56083QF-GCD5	-	DS	M378T6453FG0-CD5	-	*		
512 MB	SAMSUNG	K4T56083QF-GCD5(ECC)	-	DS	M391T6453FG0-CD5	-	*		
1024 MB	SAMSUNG	K4T51083QB-GCD5(ECC)	-	DS	M391T2953BG0-CD5	-	*		
256 MB	MICRON	4DBIIZ9BQT	-	SS	N/A	-	*	*	
512 MB	Infineon	HYB18T512800AF3(ECC)	-	SS	HYS72T64000HU-3.7-A	-	*	*	
512 MB	Infineon	HYB18T512800AC37	-	SS	HYS64T64000GU-3.7-A	-	*	*	*
256 MB	Infineon	HYB18T512160AF-3.7	-	SS	HYS64T32000HU-3.7-A	-	*	*	*
512 MB	Infineon	HYB18T512800AF37	-	SS	HYS64T64000HU-3.7-A	-	*	*	*
1024 MB	Infineon	HYB18T512800AF37	-	DS	HYS64T128020HU-3.7-A	-	*	*	*
2048 MB	Infineon	HYB18T1G800AF-3.7	-	DS	HYS64T256020HU-3.7-A	-	*		
256 MB	Infineon	HYB18T5121608BF-3.7	-	SS	HYS64T32000HU-3.7-B	-	*	*	
512 MB	Infineon	HYB18T512800BF37	-	SS	HYS64T64000HU-3.7-B	-	*	*	*
1024 MB	Infineon	HYB18T512800BF37	-	DS	HYS64T128020HU-3.7-B	-	*		
512 MB	Hynix	HY5PS12821F-C4	-	SS	HYMP564U648-C4	-	*	*	*
512 MB	Hynix	HY5PS12821F-C4(ECC)	-	SS	HYMP564U728-C4	-	*	*	*
1024 MB	Hynix	HY5PS12821F-C4	-	DS	HYMP512U648-C4	-	*	*	*
1024 MB	Hynix	HY5PS12821F-C4(ECC)	-	DS	HYMP512U728-C4	-	*	*	*
1024 MB	Hynix	HY5PS12821F-E3(ECC)	-	DS	HYMP512U728-C4	-	*	*	*
512 MB	Hynix	HY5PS12821FP-C4(ECC)	-	SS	HYMP564U728-C4	-	*	*	*
1024 MB	Hynix	HY5PS12821FP-C4	-	DS	HYMP512U648-C4	-	*	*	*
512 MB	Hynix	HY5PS12821AFP-C3	-	SS	HYMP564U64AP8-C3	-	*	*	*
1024 MB	Hynix	HY5PS12821AFP-C3	-	DS	HYMP512U64AP8-C3	-	*	*	*
512 MB	ELPIDA	E5108AB-5C-E(ECC)	-	SS	EBE51ED8ABFA-5C-E	-	*	*	*
512 MB	ELPIDA	E5108AB-5C-E	-	SS	EBE51UD8ABFA-5C	-	*	*	*
512 MB	ELPIDA	E5108AB-5C-E	-	SS	EBE51UD8ABFA-5C-E	-	*	*	*
1024 MB	ELPIDA	E5108AB-5C-E	-	DS	EBE11UD8ABFA-5C-E	-	*	*	*
2048 MB	ELPIDA	E1108AA-5C-E	-	DS	EBE21EE8AFA-5C-E	-	*	*	*
256 MB	CORSAIR	MIII0051832M8CEC	-	SS	VS256MB533D2	-	*	*	*
512 MB	CORSAIR	MII10052432M8CEC	-	DS	VS512MB533D2	-	*	*	*
256 MB	Apacer	E5116AB-5C-E	-	SS	78.81077.420	-	*	*	*
256 MB	KINGMAX	E5116AB-5C-E	-	SS	KLBB68F-36EP4	-	*	*	*
512 MB	KINGMAX	E5108AE-5C-E	-	SS	KLBC28F-A8EB4	-	*	*	*
1024 MB	KINGMAX	E5108AE-5C-E	-	DS	KLBD48F-A8EB4	-	*	*	*
512 MB	KINGMAX	KKEA88E4AAK-37	-	SS	KLBC28F-A8KE4	-	*	*	*
1024 MB	KINGMAX	5MB22D9DCN	-	DS	KLBD48F-A8ME4	-	*	*	*
512 MB	Transcend	K4T51083QB-GCD5	-	SS	TS64MLQ64V5J	-	*	*	*
1024 MB	Transcend	K4T51083QB-GCD5	-	DS	TS128MLQ64V5J	-	*	*	*
256 MB	CENTURY	K4T56083QF-GCD5	-	SS	25V6S8SSD5F4-K43	-	*	*	*
512 MB	CENTURY	E5108AB-5C-E	-	SS	25V2H8EL5CB4-J43	-	*	*	*
1024 MB	CENTURY	E5108AB-5C-E	-	DS	25V0H8EL5CB4-J45	-	*	*	*
1024 MB	CENTURY	E5108AB-5C-E	-	DS	25V0H8EL5C	-	*	*	*
256 MB	elixir	N2TU51216AF-37B	-	SS	M2U25664TUH40F-37B	-	*	*	*
512 MB	elixir	N2TU51280AF-37B	-	SS	M2U51264TU88A0F-37B	-	*	*	*
256 MB	Aeneon	AET960UD00-37C88X	-	SS	AET560UD00-370A98X	-	*	*	*

(continued on the next page)

DDR2-533

Size	Vendor	Chip No.	Model	Side(s)	Part No.	CL	DIMM socket support (Optional)		
							A*	B*	C*
512 MB	Aeneon	AET960UD00-37C88X	-	SS	AET660UD00-370A98X	-			
512 MB	Aeneon	AET93F370AG0513	-	SS	AET660UD00-370A98X	-			
256 MB	Aeneon	AET94F370A	-	SS	AET560UD00-370A98Z	-			
256 MB	Aeneon	AET94F370A	-	SS	AET560UD00-370A98X	-			
512 MB	Aeneon	AET93F370A	-	SS	AET660UD00-370A98Z	-			
512 MB	Aeneon	AET93F370A	-	SS	AET660UD00-370A98X	-			
512 MB	Aeneon	AET93F370	-	SS	AET660UD00-370A98X	-			
1024 MB	Aeneon	AET93F370A	-	DS	AET760UD00-370A98X	-			
256 MB	NANYA	NT5TU32M16AF-37B	-	SS	NT256T64UH4A0F-37B	-			
512 MB	NANYA	NT5TU64M8AF-37B	-	SS	NT512T64U88A0F-37B	-			
512 MB	NANYA	NT5TU64M8AF-37B(ECC)	-	SS	NT512T72U89A0F-37B	-			
1024 MB	NANYA	NT5TU64M8AF-37B	-	DS	NT1GT64U8HA0F-37B	-			
1024 MB	PQI	64MX8D2-E	-	DS	MEAB-323LA	-			
512 MB	PQI	64MX8D2-E	-	SS	MEAB-423LA	-			
512 MB	TwinMOS	K4T51083QB-GCD5	-	SS	8D-22JB5-K2T	-			
256 MB	SimpleTech	858S032F25A	-	SS	SVM-42DR2/256	-			
512 MB	SimpleTech	858S064F25A	-	SS	SVM-42DR2/512	-			
1024 MB	Patriot	Heat-Sink Package	-	SS	PDC21G5600+XBLK	-			
512 MB	MDT	18D51280D-3.70S20	-	SS	M512-533-8	-			
1024 MB	MDT	18D51280D-3.70448	-	DS	M924-533-16	-			

Side(s): SS - Single-sided DS - Double-sided

DIMM support:

- A - Supports one module inserted into either slot, in Single-channel memory configuration.
- B - Supports one pair of modules inserted into either the orange slots or the black slots as one pair of Dual-channel memory configuration.
- C - Supports two pairs of modules inserted into both the orange and black slots as two pairs of Dual-channel memory configuration.



Visit the ASUS website for the latest DDR2-533 with lower latency Qualified Vendors List.

2.4.3 Installing a DIMM



Unplug the power supply before adding or removing DIMMs or other system components. Failure to do so can cause severe damage to both the motherboard and the components.

To install a DIMM:

1. Unlock a DIMM socket by pressing the retaining clips outward.
2. Align a DIMM on the socket such that the notch on the DIMM matches the break on the socket.
3. Firmly insert the DIMM into the socket until the retaining clips snap back in place and the DIMM is properly seated.

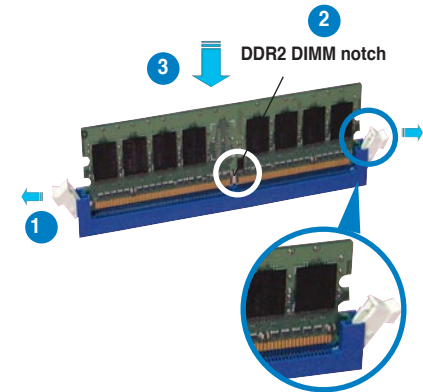

Unlocked retaining clip



- A DDR2 DIMM is keyed with a notch so that it fits in only one direction. Do not force a DIMM into a socket to avoid damaging the DIMM.
- The DDR2 DIMM sockets do not support DDR DIMMs. Do not install DDR DIMMs to the DDR2 DIMM sockets.

2.4.4 Removing a DIMM

To remove a DIMM:

1. Simultaneously press the retaining clips outward to unlock the DIMM.



Support the DIMM lightly with your fingers when pressing the retaining clips. The DIMM might get damaged when it flips out with extra force.

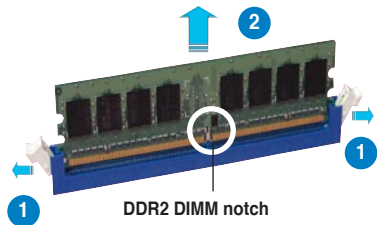

2. Remove the DIMM from the socket.

2.5 Expansion slots

In the future, you may need to install expansion cards. The following sub-sections describe the slots and the expansion cards that they support.



Make sure to unplug the power cord before adding or removing expansion cards. Failure to do so may cause you physical injury and damage motherboard components.

2.5.1 Installing an expansion card

To install an expansion card:

1. Before installing the expansion card, read the documentation that came with it and make the necessary hardware settings for the card.
2. Remove the system unit cover (if your motherboard is already installed in a chassis).
3. Remove the bracket opposite the slot that you intend to use. Keep the screw for later use.
4. Align the card connector with the slot and press firmly until the card is completely seated on the slot.
5. Secure the card to the chassis with the screw you removed earlier.
6. Replace the system cover.

2.5.2 Configuring an expansion card

After installing the expansion card, configure the it by adjusting the software settings.

1. Turn on the system and change the necessary BIOS settings, if any. See Chapter 4 for information on BIOS setup.
2. Assign an IRQ to the card. Refer to the tables on the next page.
3. Install the software drivers for the expansion card.



When using PCI cards on shared slots, ensure that the drivers support “Share IRQ” or that the cards do not need IRQ assignments. Otherwise, conflicts will arise between the two PCI groups, making the system unstable and the card inoperable. Refer to the table on the next page for details.

2.5.3 Interrupt assignments

IRQ	Priority	Standard function
0	1	System Timer
1	2	Keyboard Controller
2	–	Redirect to IRQ#9
3	11	IRQ Holder for PCI Steering*
4	12	Communications Port (COM1)*
5	13	IRQ Holder for PCI Steering*
6	14	Floppy Disk Controller
7	15	Printer Port (LPT1)*
8	6	System CMOS/Real Time Clock
9	4	IRQ Holder for PCI Steering*
10	5	IRQ Holder for PCI Steering*
11	6	IRQ Holder for PCI Steering*
12	7	PS/2 Compatible Mouse Port*
13	8	Numeric Data Processor
14	9	Primary IDE Channel
15	10	Secondary IDE Channel

* These IRQs are usually available for ISA or PCI devices.

IRQ assignments for this motherboard

	A	B	C	D	E	F	G	H
PCI slot 1	–	–	–	–	–	shared	–	–
PCI slot 2	–	–	–	–	–	–	shared	–
PCI slot 3	–	–	–	–	–	–	–	shared
Onboard IDE (JMicron®)	–	shared	–	–	–	–	–	–
Onboard 1394	–	–	–	–	–	shared	–	–
Onboard LAN1	–	–	–	shared	–	–	–	–
Onboard LAN2	shared	–	–	–	–	–	–	–
PCIe x16 1	shared	–	–	–	–	–	–	–
PCIe x16 2	shared	–	–	–	–	–	–	–
PCIe x1	shared	–	–	–	–	–	–	–
PCIe x1	–	–	shared	–	–	–	–	–
USB controller 1	–	–	–	–	shared	–	–	–
USB controller 2	–	shared	–	–	–	–	–	–
USB controller 3	–	–	shared	–	–	–	–	–
USB controller 4	–	–	–	shared	–	–	–	–
USB 2.0 controller	–	–	–	–	shared	–	–	–
Serial ATA	–	–	–	–	–	–	–	shared
IDE	–	–	–	–	–	–	shared	–
HD Audio	–	–	–	shared	–	–	–	–

2.5.4 PCI slots

The PCI slots support cards such as a LAN card, SCSI card, USB card, and other cards that comply with PCI specifications. The figure shows a LAN card installed on a PCI slot.

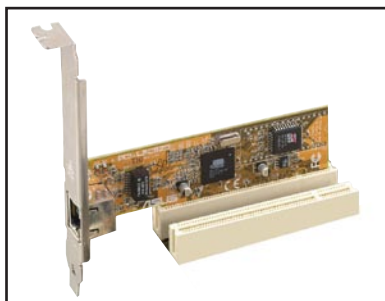

2.5.5 PCI Express x1 slot

This motherboard supports PCI Express x1 network cards, SCSI cards and other cards that comply with the PCI Express specifications. The following figure shows a network card installed on the PCI Express x1 slot.

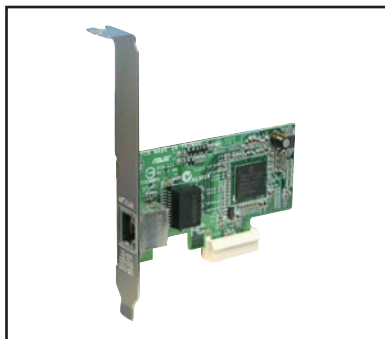

2.5.6 Two PCI Express x16 slots

This motherboard supports two ATI CrossFire™ PCI Express x16 graphics cards that comply with the PCI Express specifications.

The figure shows two graphics cards installed on the PCI Express x16 slots.

See Chapter 6 for details on the CrossFire™ technology feature.

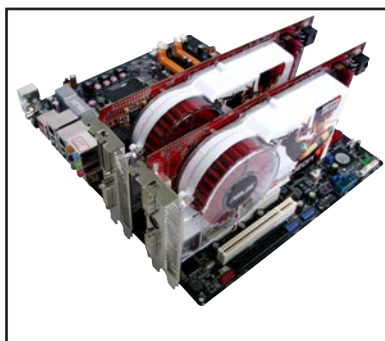



- We recommend that you install a graphics card on the primary (orange) PCI Express slot and install other PCI Express devices on the black PCI Express x16 slot.
- In CrossFire™ mode, each PCI Express x16 slot works at x8 bandwidth.
- In CrossFire™ mode, install the ATI CrossFire™ Edition (Master) graphics card on the primary (orange) PCI Express slot.
- Refer to the table below for possible PCI Express Card configurations.

PCI Express x16 slot configurations

	PCIEX16_1 (orange) slot		PCIEX16_2 (black) slot	
	Card type	Speed	Card type	Speed
Non-CrossFire™ mode	PCIe x16 graphics card	x16	NA	NA
	PCIe x16 graphics card	x8	Other PCIe x16 graphics card	x8** (dual screen)
	PCIe x16 graphics card	x8	Other PCIe card	x8, x4, x1**
Dual graphics cards in CrossFire™ mode*	ATI® CrossFire™ Edition graphics card	x8	ATI graphics card	x8



- * Install two ATI graphics cards from the same GPU family that support CrossFire™ mode.
- ** The speed of the primary PCIe x16 slot (PCIEX16_1) changes to x8 mode after you install any device in the secondary PCIe x16 (PCIEX16_2) slot.

2.6 Jumpers

1. Clear RTC RAM (CLRRTC)

This jumper allows you to clear the Real Time Clock (RTC) RAM in CMOS. You can clear the CMOS memory of date, time, and system setup parameters by erasing the CMOS RTC RAM data. The onboard button cell battery powers the RAM data in CMOS, which include system setup information such as system passwords.

To erase the RTC RAM:

1. Turn OFF the computer and unplug the power cord.
2. Remove the onboard battery.
3. Move the jumper cap from pins 1-2 (default) to pins 2-3. Keep the cap on pins 2-3 for about 5~10 seconds, then move the cap back to pins 1-2.
4. Reinstall the battery.
5. Plug the power cord and turn ON the computer.
6. Hold down the key during the boot process and enter BIOS setup to re-enter data.



Except when clearing the RTC RAM, never remove the cap on CLRRTC jumper default position. Removing the cap will cause system boot failure!

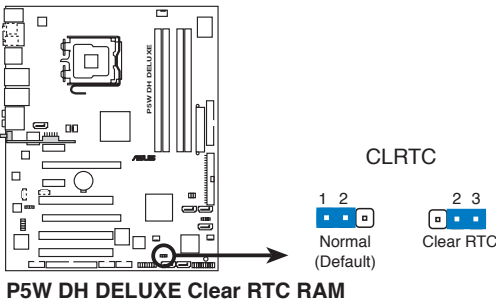

You do not need to clear the RTC when the system hangs due to overclocking. For system failure due to overclocking, use the C.P.R. (CPU Parameter Recall) feature. Shut down and reboot the system so the BIOS can automatically reset parameter settings to default values.

2. ASUS EZ-Backup RAID mode selection (RAID_SEL)

This jumper allows you to select the ASUS EZ-Backup RAID mode. Keeping the default setting RAID 1 allows you to build a RAID 1 set without any jumper or BIOS setting. Install the ASUS EZ-Backup Manager utility from the support CD and install two Serial ATA hard disk drives on the EZ_RAID1 and EZ_RAID2 connectors on the motherboard, and you are ready to mirror your data.

For detailed information about ASUS EZ-Backup, see section “5.4.4 Silicon Image® RAID configuration.”

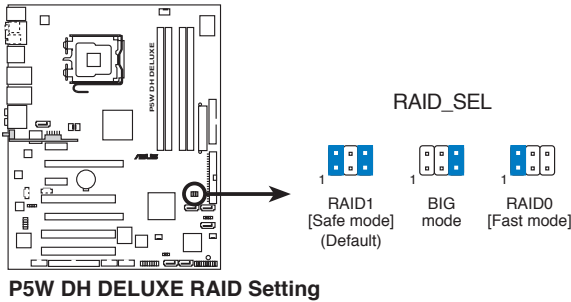

2.7 Connectors

2.7.1 Rear panel connectors

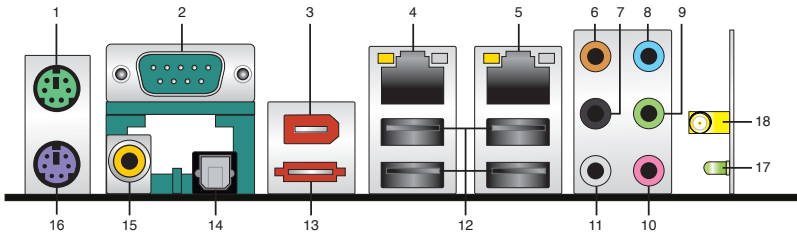

1. **PS/2 mouse port (green).** This port is for a PS/2 mouse.
2. **Serial port.** This 9-pin COM1 port is for pointing devices or other serial devices.
3. **IEEE 1394a port.** The 6-pin IEEE 1394a port provides high-speed connectivity for audio/video devices, storage peripherals, PCs, or portable devices.
4. **LAN1 (RJ-45) port.** This Marvell® LAN port allows Gigabit connection to a Local Area Network (LAN) through a network hub. Refer to the table below for the LAN port LED indications.
5. **LAN2 (RJ-45) port.** This Marvell® LAN port allows Gigabit connection to a Local Area Network (LAN) through a network hub. Refer to the table below for the LAN port LED indications.

LAN port LED indications

Activity/Link Speed LED			
Status	Description	Status	Description
OFF	No link	OFF	10 Mbps connection
ORANGE	Linked	ORANGE	100 Mbps connection
BLINKING	Data activity	GREEN	1 Gbps connection

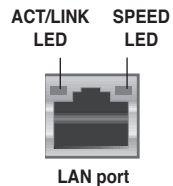

6. **Center/Subwoofer port (yellow orange).** This port connects the center/subwoofer speakers.
7. **Rear Speaker Out port (black).** This port connects the rear speakers in a 4/8-channel audio configuration, and the side speakers in a 6-channel configuration.

8. **Line In port (light blue).** This port connects a tape, CD, DVD player, or other audio sources.
9. **Line Out port (lime).** This port connects a headphone or a speaker. In 4-channel, 6-channel, and 8-channel configuration, the function of this port becomes Front Speaker Out.
10. **Microphone port (pink).** This port connects a microphone.
11. **Side Speaker Out port (gray).** This port connects the side speakers in an 8-channel audio configuration.



Refer to the audio configuration table below for the function of the audio ports in 2, 4, 6, or 8-channel configuration.

Audio 2, 4, 6, or 8-channel configuration

Port	Headset 2-channel	4-channel	6-channel	8-channel
Light Blue	Line In	Line In	Line In	Line In
Lime	Line Out	Front Speaker Out	Front Speaker Out	Front Speaker Out
Pink	Mic In	Mic In	Mic In	Mic In
Gray	–	–	–	Side Speaker Out
Black	–	Rear Speaker Out	Side Speaker Out	Rear Speaker Out
Orange	–	–	Center/Subwoofer	Center/Subwoofer

12. **USB 2.0 ports 1, 2, 3 and 4.** These 4-pin Universal Serial Bus (USB) ports are available for connecting USB 2.0 devices. USB 2.0 ports 3 and 4 support S5 wake-up by USB. For the location of these ports, see page 2-4.
13. **External SATA port.** This port connects to an external SATA box or a Serial ATA port multiplier.



The external SATA port supports external Serial ATA 3.0 Gb/s devices. Longer cables support higher power requirements to deliver signal up to two meters away, and enables improved hot-swap function.



14. **Optical S/PDIF Out port.** This port connects an external audio output device via an optical S/PDIF cable.
15. **Coaxial S/PDIF Out port.** This port connects an external audio output device via a coaxial S/PDIF cable.
16. **PS/2 keyboard port (purple).** This port is for a PS/2 keyboard.



The following items are only for the optional Wireless LAN module.

17. **ASUS Wi-Fi AP Solo™ LED indicator.** The ASUS Wi-Fi AP Solo™ comes with a green data transmission LED (AIR). For more information, refer to the ASUS Wi-Fi AP Solo™ user guide.
18. **Antenna jack.** This jack is on the onboard wireless LAN module that allows you to set up a wireless network and exchange information with other wireless devices without tangling cables and wires. Connect the moveable omni-directional antenna to this jack.

2.7.2 Internal connectors

1. Floppy disk drive connector (34-1 pin FLOPPY)

This connector is for the provided floppy disk drive (FDD) signal cable. Insert one end of the cable to this connector, then connect the other end to the signal connector at the back of the floppy disk drive.



Pin 5 on the connector is removed to prevent incorrect cable connection when using a FDD cable with a covered Pin 5.

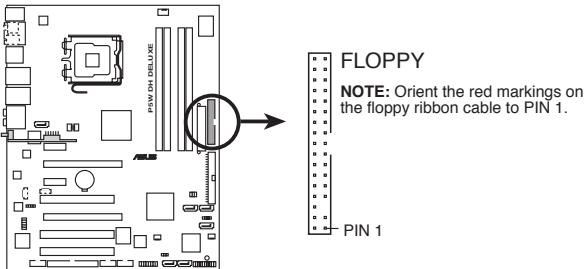

P5W DH DELUXE Floppy disk drive connector

2. JMicon® IDE connector (40-1 pin PRI_EIDE [black])

This connector is for Ultra ATA 133/100/66 signal cables. The JMicon® IDE connector supports up to two IDE hard disk drives for easier data storage.

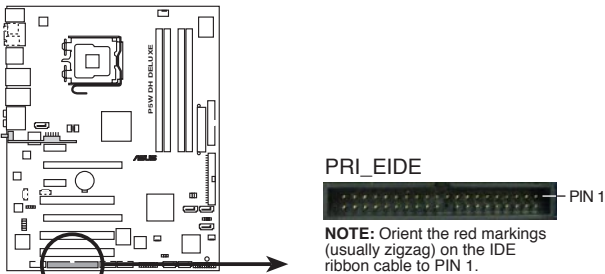

P5W DH DELUXE IDE connector



This connector does not support ATAPI devices.

3. Intel® ICH7R IDE connector (40-1 pin PRI_IDE)

The onboard IDE connector is for the Ultra DMA (133/100/66) signal cable. There are three connectors on each Ultra DMA 133/100/66 signal cable: blue, black, and gray. Connect the blue connector to the motherboard's IDE connector, then select one of the following modes to configure your device.

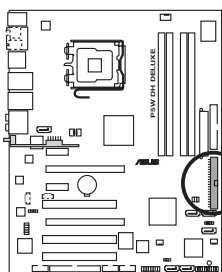

NOTE: Orient the red markings (usually zigzag) on the IDE ribbon cable to PIN 1.

P5W DH DELUXE IDE connector



- Pin 20 on the IDE connector is removed to match the covered hole on the Ultra DMA cable connector. This prevents incorrect insertion when you connect the IDE cable.
- Use the 80-conductor IDE cable for Ultra DMA 100/66 IDE devices.
- Install devices on this connector (PRI_IDE) first, then install on the JMicron® IDE connector, PRI_EIDE (see item #2 on the previous page for the location of the PRI_EIDE connector).

	Drive jumper setting	Mode of device(s)	Cable connector
Single device	Cable-Select or Master	-	Black
Two devices	Cable-Select	Master	Black
		Slave	Gray
	Master	Master	Black or gray
	Slave	Slave	



If any device jumper is set as "Cable-Select," make sure all other device jumpers have the same setting.

4. Intel® ICH7R Serial ATA connectors (7-pin SATA1 [red], SATA3 [black], SATA4 [black],)

These connectors are for the Serial ATA signal cables for Serial ATA hard disk drives.

If you installed Serial ATA hard disk drives, you can create a RAID 0, RAID 1, and RAID 5 configuration with the Intel® Matrix Storage Technology through the onboard Intel® ICH7R RAID controller. You may create a RAID 10 set through a cross-RAID configuration with the onboard Intel® ICH7R RAID controller and ASUS EZ-Backup. Refer to Chapter 5 for details on how to set up Serial ATA RAID configurations.



- These connectors are set to Standard IDE mode by default. In Standard IDE mode, you can connect Serial ATA boot/data hard disk drives to these connectors. If you intend to create a Serial ATA RAID set using these connectors, set the Configure SATA As item in the BIOS to [RAID]. See section “4.3.6 IDE Configuration” for details.
- For RAID 5, use at least three hard disk drives.
- For RAID 10 (cross-RAID configuration), use three hard disk drives on these connectors, and one hard disk drive on EZ_RAID1. See section “5.4.5 Cross-RAID configuration” for details.
- Use two Serial ATA hard disk drives for each RAID 0 or RAID 1 set.

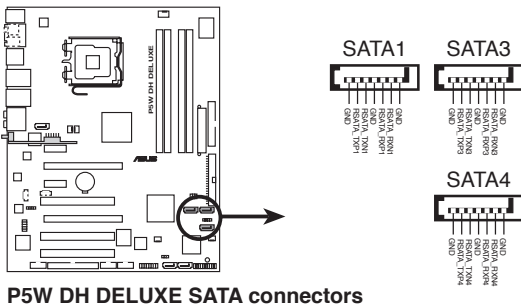

P5W DH DELUXE SATA connectors



Important notes on Serial ATA

- You must install Windows® 2000 Service Pack 4 or the Windows® XP Service Pack 1 before using Serial ATA hard disk drives. The Serial ATA RAID feature (RAID 0/RAID 1/RAID 5/RAID 10) is available only if you are using Windows® 2000/XP/Server 2003 or later version.
- When using the connectors in Standard IDE mode, connect the primary (boot) hard disk drive to the SATA1 connector.



- To build RAID 1, we recommend that you install the hard disk drives on the ASUS EZ-Backup connectors (EZ_RAID1 and EZ_RAID2) to enjoy the instant setup; otherwise, you may also install on the ICH7R connectors.
- You may install an extra hard disk drive on the JMicron Serial ATA connector after using up the Intel® ICH7R and ASUS EZ-Backup connectors

Serial ATA hard disk drive connection

Connector	Color	Setting	Use
SATA1	Red	Master	Boot disk
SATA 3/SATA4	Black	Slave	Data disk

5. JMicron® JMB363 Serial ATA connector (7-pin SATA_RAID1 [black])

This connector is for a Serial ATA signal cable for a Serial ATA hard disk drive that you can combine with an external Serial ATA 3.0 Gb/s device to configure a RAID 0, and RAID 1 set through the onboard JMicron® JMB363 SATA RAID controller. Refer to Chapter 5 for details on how to set up Serial ATA RAID configurations.

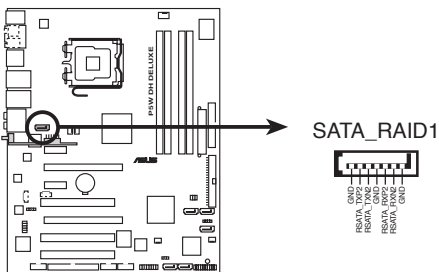

P5W DH DELUXE SATA RAID connector



The JMicron® JMB363 Controller item in the BIOS is set to [Basic] by default, allowing you to enable the hot-plug function for the external device. Set to [Raid] to use the connector to build a RAID set. See section “4.4.6 Onboard Device Configuration” for details.

6. ASUS EZ-Backup Serial ATA connectors (7-pin EZ_RAID1 [orange], EZ_RAID2 [orange])

These connectors are for the ASUS EZ-Backup feature. Connect Serial ATA signal cables that support Serial ATA hard disk drives to build a RAID 0 or RAID 1 set easily. Refer to Chapter 5 for details on how to build an EZ-Backup RAID set.

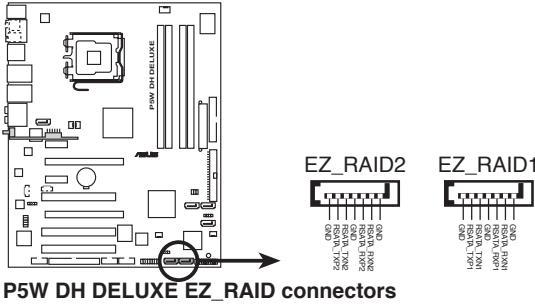

P5W DH DELUXE EZ_RAID connectors



You may create a RAID 10 set through a cross-RAID configuration by installing three hard disk drives on the ICH7R Serial ATA connectors, and one hard disk drive on EZ_RAID1. See section "5.4.5 Cross-RAID configuration for details.

7. MP3-In connector (4-pin MP3IN [red])

This connector is for the MP3-In module that allows you to connect your MP3 player to the speakers of the computer. For more information, refer to the MP3-In Module Quick Installation Guide or the ASUS FrontLinker™ user guide.

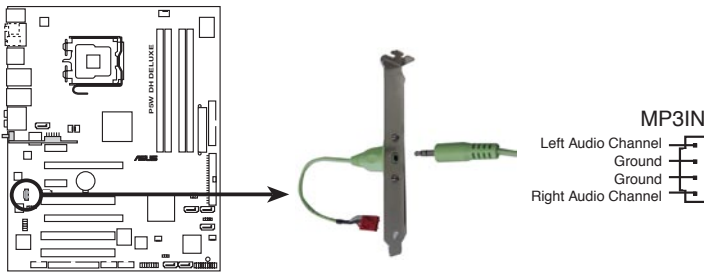

P5W DH DELUXE MP3-In connector



- The MP3-In module is bundled with the motherboard package if the motherboard does not include the ASUS FrontLinker™. Connect the cable to the MP3IN connector, and enjoy music from computer speakers even when the PC is turned off.
- Do not plug the MP3-In cable into the Audio-In connector.

8. Internal audio connector (4-pin CD)

This connector allows you to receive stereo audio input from a CD-ROM.

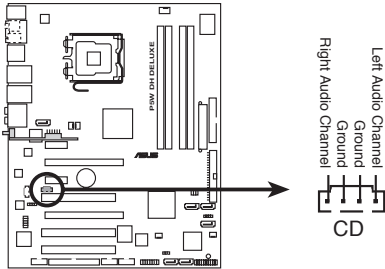

P5W DH DELUXE Internal audio connector

9. Front panel audio connector (10-1 pin AAFP)

This connector is for a chassis-mounted front panel audio I/O module that supports either HD Audio or legacy AC'97 audio standard.

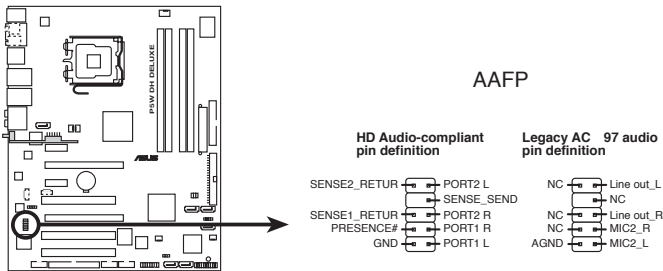

P5W DH DELUXE Analog front panel connector



- We recommend that you connect a high-definition front panel audio module to this connector to avail the motherboard high-definition audio capability.
- By default, this connector is set to HD Audio. If you want to connect a legacy AC '97 front panel audio module to this connector, set the Front Panel Support Type item in the BIOS Setup to [AC97]. See page 4-28 for details.

10. USB connector (10-1 pin USB56, USB78)

These connectors are for USB 2.0 ports. Connect the USB module cable to these connectors, then install the module to a slot opening at the back of the system chassis. These USB connectors comply with the USB 2.0 specification that supports up to 480 Mbps connection speed.

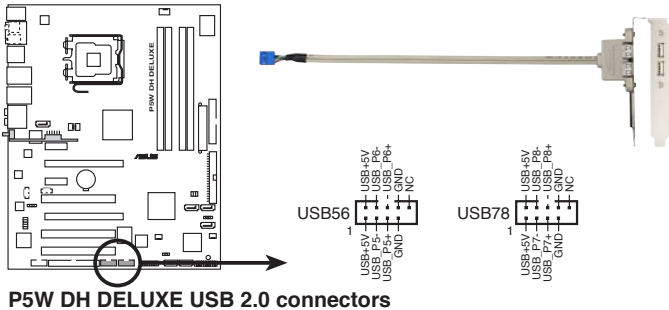

Never connect a 1394 cable to the USB connectors. Doing so will damage the motherboard!



Only USB34 on the rear panel can support S5 wake-up by keyboard/mouse function.

11. IEEE 1394a port connector (10-1 pin IE1394_1 [Red])

This connector is for an additional IEEE 1394a port. Connect the IEEE 1394a module cable (red) to this connector, then install the module to a slot opening at the back of the system chassis.

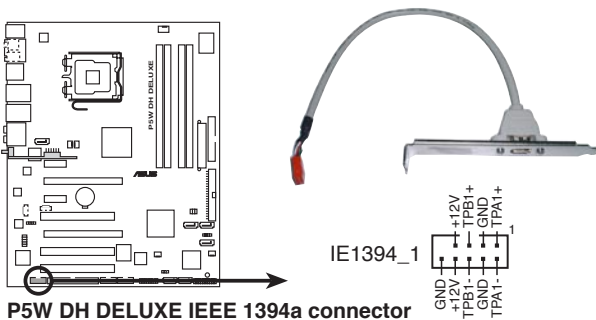

Never connect a USB port module cable to the IEEE 1394 connector. Doing so will damage the motherboard!

12. Chassis intrusion connector (4-1 pin CHASSIS)

This connector is for a chassis-mounted intrusion detection sensor or switch. Connect one end of the chassis intrusion sensor or switch cable to this connector. The chassis intrusion sensor or switch sends a high-level signal to this connector when a chassis component is removed or replaced. The signal is then generated as a chassis intrusion event.

By default, the pins labeled “Chassis Signal” and “Ground” are shorted with a jumper cap. Remove the jumper caps only when you intend to use the chassis intrusion detection feature.

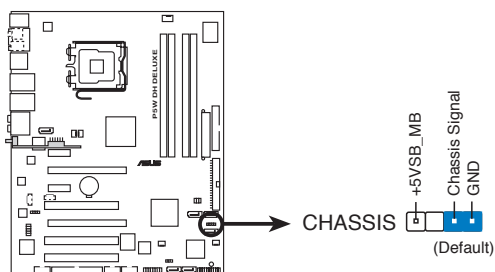

P5W DH DELUXE Chassis intrusion connector

13. CPU, Chassis, and Power Fan connectors (4-pin CPU_FAN, 3-pin PWR_FAN1, 3-pin PWR_FAN2, 3-pin CHA_FAN1, 3-pin CHA_FAN2)

The fan connectors support cooling fans of 2A (24W max.) at +12V. Connect the fan cables to the fan connectors on the motherboard, making sure that the black wire of each cable matches the ground pin of the connector.

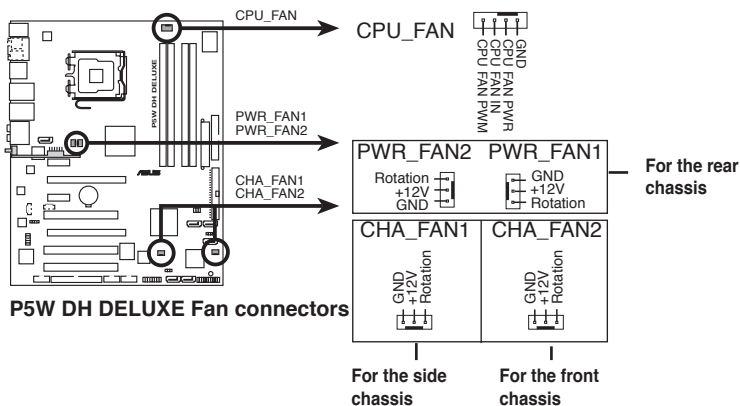

P5W DH DELUXE Fan connectors



Do not forget to connect the fan cables to the fan connectors. Insufficient air flow inside the system may damage the motherboard components. These are not jumpers! Do not place jumper caps on the fan connectors!



If you install two VGA cards, we recommend that you plug the rear chassis fan cable to the motherboard connector labeled PWR_FAN1 or PWR_FAN2 for better thermal environment.



Suggestions for installing the chassis fan:

- If you install a fan at the back of the chassis, plug the fan cable to PWR_FAN2 or PWR_FAN1.
 - If you install a fan on the side of the chassis, plug the fan cable to CHA_FAN1.
 - If you install a fan in front of the chassis, plug the fan cable to CHA_FAN2.
-

14. ATX power connectors (24-pin EATXPWR, 4-pin ATX12V)

These connectors are for ATX power supply plugs. The power supply plugs are designed to fit these connectors in only one orientation. Find the proper orientation and push down firmly until the connectors completely fit.

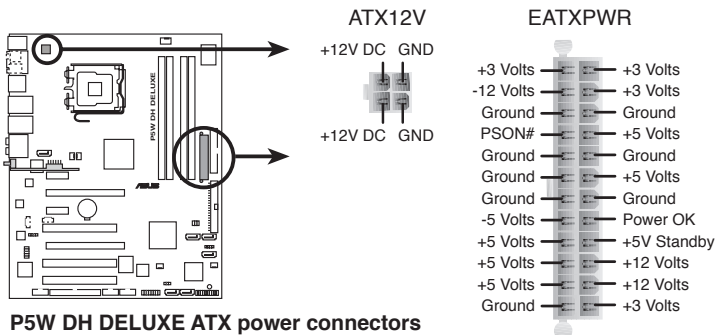

Important notes on motherboard power requirements

- For a fully configured system, we recommend that you use a power supply unit (PSU) that complies with ATX 12 V Specification 2.0 (or later version) and provides a minimum power of 400 W.
- Do not forget to connect the 4-pin EATX12 V power plug; otherwise, the system will not boot up.
- To support an Intel® Dual-Core CPU up to 965 Extreme Edition, make sure that the PSU can provide at least DC 16A (peak 22A) on the +12V_2 lead. The vendors list on the next page is provided for your reference.

Power Supply Unit reference vendors list

Vendor	Model	Max. Power (W)
FSP	400-60THN	400
Seasonic	SS-600HT	600
Seasonic	SS-400FT	400
Acbel	ATX-550CA-AB8FM	550
THERMALTAKE	HPC-420-302 DF	400
AUSU	S-30EP	300
Bestec	ATX0400D5W	400
Silverstone	SST ST56ZF	560
Enermax	Eg701AX-VE	600



Use of a PSU with a higher power output is recommended when configuring a system with more power consuming devices. The system may become unstable or may not boot up if the power is inadequate. Refer to the **Power wattage** tables below and on the next page for details.

Power wattage

Loading	Heavy		Normal		Light	
CPU	Extreme Edition 965		Prescott 672		Conroe E6700	
DDR2 800	1G*4		1G*2		512M*2	
VGA	ATI 1900XTX*2		NVIDIA 6800GTX*1		NVIDIA 6600*1	
HDD	IDE*2		IDE*1		IDE*1	
	SATA*5		SATA*3		SATA*2	
CD-ROM	2		2		1	
USB	7		6		4	
PCI-E	1		1		1	
PCI	2		2		1	
Wi-Fi AP Solo™	Enabled		Enabled		Enabled	
DH Remote	Enabled		Enabled		Enabled	
Required +12V current	+12V-V2	+12V-V1	+12V-V2	+12V-V1	+12V-V2	+12V-V1
	>12A	>18A	>12A	>8A	>12A	>6A
Required wattage	>=525W		>=300W		>=160W	

15. System panel connector (20-pin PANEL)

This connector supports several chassis-mounted functions.

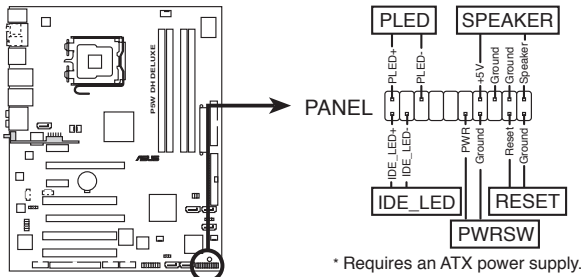

P5W DH DELUXE System panel connector

- **System power LED (2-pin PLED)**

This 3-pin connector is for the system power LED. Connect the chassis power LED cable to this connector. The system power LED lights up when you turn on the system power, and blinks when the system is in sleep mode.

- **Hard disk drive activity LED (2-pin IDE_LED)**

This 2-pin connector is for the HDD Activity LED. Connect the HDD Activity LED cable to this connector. The IDE LED lights up or flashes when data is read from or written to the HDD.

- **System warning speaker (4-pin SPEAKER)**

This 4-pin connector is for the chassis-mounted system warning speaker. The speaker allows you to hear system beeps and warnings.

- **ATX power button/soft-off button (2-pin PWRSW)**

This connector is for the system power button. Pressing the power button turns the system on or puts the system in sleep or soft-off mode depending on the BIOS settings. Pressing the power switch for more than four seconds while the system is ON turns the system OFF.

- **Reset button (2-pin RESET)**

This 2-pin connector is for the chassis-mounted reset button for system reboot without turning off the system power.

ASUS Q-Connector (system panel)

You can use the ASUS Q-Connector to connect/disconnect chassis front panel cables in a few steps. Refer to the instructions below to install the ASUS Q-Connector.

1. Connect the front panel cables to the ASUS Q-Connector.
Refer to the labels on the Q-Connector to know the detailed pin definitions, then match them to the respective front panel cable labels.

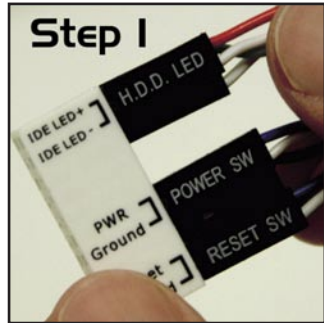

2. Install the ASUS Q-Connector to the system panel connector, making sure the orientation matches the labels on the motherboard.

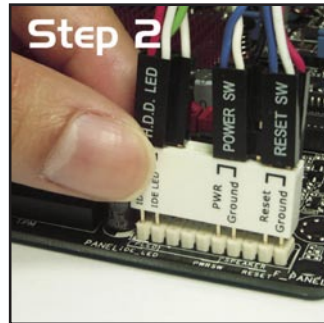

3. The front panel functions are now enabled. The figure shows the Q-Connector properly installed on the motherboard.

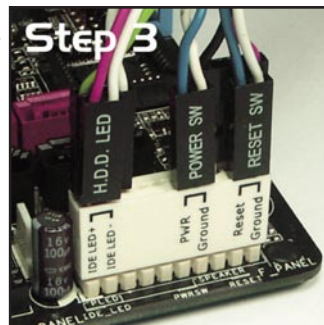

Installing the optional fan



Install the optional fan only if you are using a passive cooler or a water cooler. Installing the optional fan with an active CPU cooler will interfere with the airflow and destabilize the system.

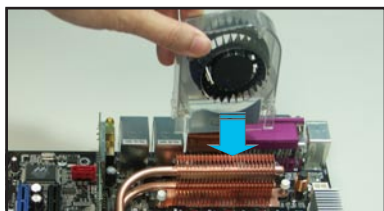

1. Position the fan above the pipe and heatsink assembly.

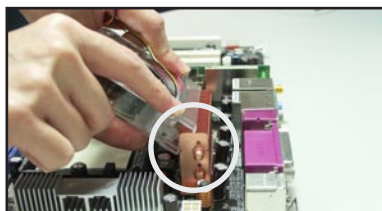

2. Fit the grooved edge to the heatsink.

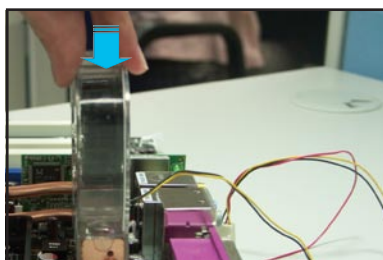

3. Carefully push down the fan until it snugly fits the heatsink, then connect the fan cables.



- Plug the optional fan cables to the NB_FAN and/or PWR_FAN connector on the motherboard.
- Make sure the optional fan is installed correctly to prevent damage to the fan and motherboard components.



Do not tilt the fan.

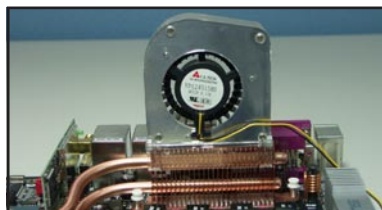

Do not install the fan with its rear side facing you.

This chapter describes the power up sequence, the vocal POST messages, and ways of shutting down the system.

Powering up **3**

Chapter summary

3

- 3.1 Starting up for the first time..... 3-1
- 3.2 Turning off the computer..... 3-2

3.1 Starting up for the first time

1. After making all the connections, replace the system case cover.
2. Be sure that all switches are off.
3. Connect the power cord to the power connector at the back of the system chassis.
4. Connect the power cord to a power outlet that is equipped with a surge protector.
5. Turn on the devices in the following order:
 - a. Monitor
 - b. External SCSI devices (starting with the last device on the chain)
 - c. System power
6. After applying power, the system power LED on the system front panel case lights up. For systems with ATX power supplies, the system LED lights up when you press the ATX power button. If your monitor complies with “green” standards or if it has a “power standby” feature, the monitor LED may light up or switch between orange and green after the system LED turns on.

The system then runs the power-on self tests or POST. While the tests are running, the BIOS beeps (see BIOS beep codes table below) or additional messages appear on the screen. If you do not see anything within 30 seconds from the time you turned on the power, the system may have failed a power-on test. Check the jumper settings and connections or call your retailer for assistance.

AMI BIOS beep codes

Beep Description	Error
One beep	Keyboard controller error Refresh Time error No master drive detected
Two continuous beeps followed by two short beeps	Floppy controller failure
Two continuous beeps followed by four short beeps	Hardware component failure

7. At power on, hold down the <Delete> key to enter the BIOS Setup. Follow the instructions in Chapter 4.

3.2 Turning off the computer

3.2.1 Using the OS shut down function

If you are using Windows® 2000:

1. Click the Start button then click Shut Down...
2. Make sure that the Shut Down option button is selected, then click the OK button to shut down the computer.
3. The power supply should turn off after Windows® shuts down.

If you are using Windows® XP or later version:

1. Click the Start button then select Turn Off Computer.
2. Click the Turn Off button to shut down the computer.
3. The power supply should turn off after Windows® shuts down.

3.2.2 Using the dual function power switch

While the system is ON, pressing the power switch for less than four seconds puts the system to sleep mode or to soft-off mode, depending on the BIOS setting. Pressing the power switch for more than four seconds lets the system enter the soft-off mode regardless of the BIOS setting. Refer to section “4.5 Power Menu” in Chapter 4 for details.

This chapter tells how to change the system settings through the BIOS Setup menus. Detailed descriptions of the BIOS parameters are also provided.

BIOS setup **4**

4.1	Managing and updating your BIOS	4-1
4.2	BIOS setup program	4-10
4.3	Main menu	4-13
4.4	Advanced menu	4-18
4.5	Power menu.....	4-32
4.6	Boot menu	4-38
4.7	Tools menu	4-43
4.8	Exit menu.....	4-46

4.1 Managing and updating your BIOS

The following utilities allow you to manage and update the motherboard Basic Input/Output System (BIOS) setup.

1. **ASUS Update** (Updates the BIOS in Windows® environment.)
2. **ASUS EZ Flash 2** (Updates the BIOS in DOS using a floppy disk/USB flash disk, or the motherboard support CD.)
3. **ASUS AFUDOS** (Updates the BIOS in DOS mode using a bootable floppy disk.)
4. **ASUS CrashFree BIOS 3** (Updates the BIOS using a bootable floppy disk/USB flash disk or the motherboard support CD when the BIOS file fails or gets corrupted.)

Refer to the corresponding sections for details on these utilities.



Save a copy of the original motherboard BIOS file to a bootable floppy disk in case you need to restore the BIOS in the future. Copy the original motherboard BIOS using the ASUS Update or AFUDOS utilities.

4.1.1 ASUS Update utility

The ASUS Update is a utility that allows you to manage, save, and update the motherboard BIOS in Windows® environment. The ASUS Update utility allows you to:

- Save the current BIOS file
- Download the latest BIOS file from the Internet
- Update the BIOS from an updated BIOS file
- Update the BIOS directly from the Internet, and
- View the BIOS version information.

This utility is available in the support CD that comes with the motherboard package.



ASUS Update requires an Internet connection either through a network or an Internet Service Provider (ISP).

Installing ASUS Update

To install ASUS Update:

1. Place the support CD in the optical drive. The Drivers menu appears.
2. Click the **Utilities** tab, then click **ASUS Update**. See page 5-3 for the Utilities screen menu.
3. The ASUS Update utility is copied to your system.



Quit all Windows® applications before you update the BIOS using this utility.

Updating the BIOS through the Internet

To update the BIOS through the Internet:

1. Launch the ASUS Update utility from the Windows® desktop by clicking Start > Programs > ASUS > ASUSUpdate > ASUSUpdate. The ASUS Update main window appears.

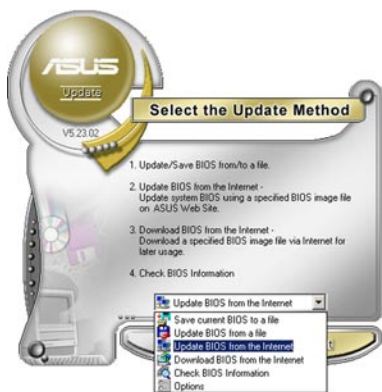
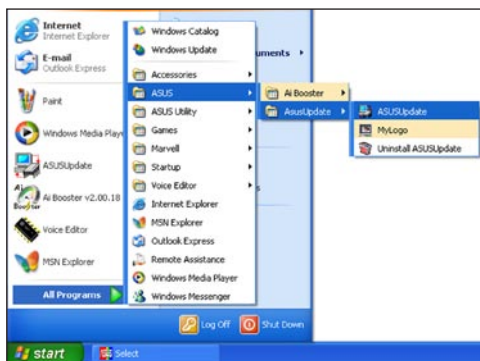

2. Select Update BIOS from the Internet option from the drop-down menu, then click **Next**.



3. Select the ASUS FTP site nearest you to avoid network traffic, or click Auto Select. Click **Next**.

- From the FTP site, select the BIOS version that you wish to download. Click **Next**.
- Follow the screen instructions to complete the update process.



The ASUS Update utility is capable of updating itself through the Internet. Always update the utility to avail of all its features.



Updating the BIOS through a BIOS file

To update the BIOS through a BIOS file:

- Launch the ASUS Update utility from the Windows® desktop by clicking **Start > Programs > ASUS > ASUSUpdate > ASUSUpdate**. The ASUS Update main window appears.
- Select **Update BIOS from a file** option from the drop-down menu, then click **Next**.

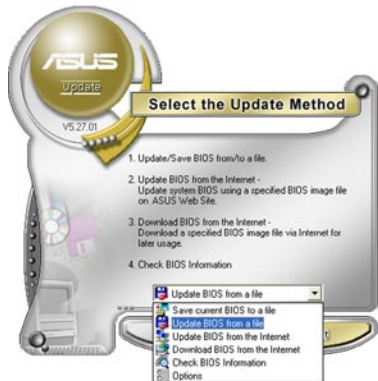

- Locate the BIOS file from the Open window, then click **Save**.
- Follow the screen instructions to complete the update process.

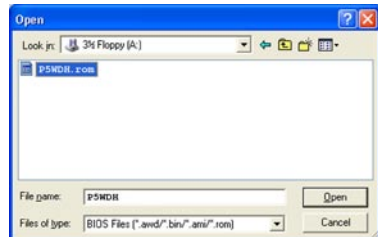

4.1.2 Creating a bootable floppy disk

1. Do either one of the following to create a bootable floppy disk.

DOS environment

- a. Insert a 1.44MB floppy disk into the drive.
- b. At the DOS prompt, type `format A: /s` then press <Enter>.

Windows® XP environment

- a. Insert a 1.44 MB floppy disk to the floppy disk drive.
- b. Click **Start** from the Windows® desktop, then select **My Computer**.
- c. Select the 3 1/2 Floppy Drive icon.
- d. Click **File** from the menu, then select **Format**. A Format 3 1/2 Floppy Disk window appears.
- e. Windows® XP users: **Select Create an MS-DOS startup disk** from the format options field, then click **Start**.

Windows® 2000 environment

To create a set of boot disks for Windows® 2000:

- a. Insert a formatted, high density 1.44 MB floppy disk into the drive.
 - b. Insert the Windows® 2000 CD to the optical drive.
 - c. Click **Start**, then select **Run**.
 - d. In the Open field, type `D:\bootdisk\makeboot a:`
assuming that D is your optical drive letter.
 - e. Press <Enter>, then follow screen instructions to continue.
2. Copy the original or the latest motherboard BIOS file to the bootable floppy disk.

4.1.3 ASUS EZ Flash 2 utility

The ASUS EZ Flash 2 feature allows you to update the BIOS without having to go through the long process of booting from a floppy disk and using a DOS-based utility. The EZ Flash 2 utility is built-in the BIOS chip so it is accessible by pressing <Alt> + <F2> during the Power-On Self Tests (POST).

To update the BIOS using EZ Flash 2:

1. Visit the ASUS website (www.asus.com) to download the latest BIOS file for the motherboard.
2. Save the BIOS file to a floppy disk or a USB flash disk, then restart the system.
3. You can launch the EZ Flash 2 by two methods.
 - (1) Insert the floppy disk/USB flash disk that contains the BIOS file to the floppy disk drive or the USB port.

Press <Alt> + <F2> during POST to display the following.

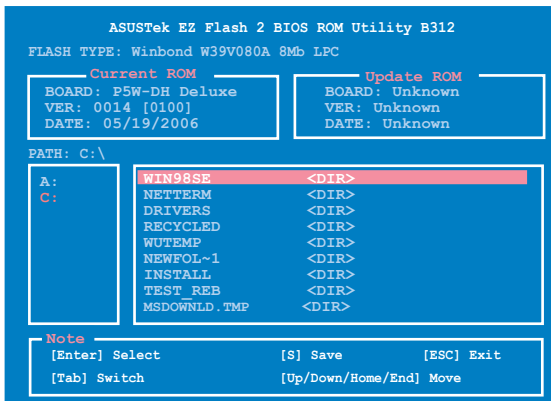

- (2) Enter BIOS setup program. Go to the **Tools** menu to select **EZ Flash2** and press <Enter> to enable it.

You can switch between drives by pressing <Tab> before the correct file is found. Then press <Enter>

4. When the correct BIOS file is found, EZ Flash 2 performs the BIOS update process and automatically reboots the system when done.



- This function can support devices such as USB flash disk, hard disk, or floppy disk with FAT 32/16/12 format only.
- Do not shut down or reset the system while updating the BIOS to prevent system boot failure!

4.1.4 AFUDOS utility

The AFUDOS utility allows you to update the BIOS file in DOS environment using a bootable floppy disk with the updated BIOS file. This utility also allows you to copy the current BIOS file that you can use as backup when the BIOS fails or gets corrupted during the updating process.

Copying the current BIOS

To copy the current BIOS file using the AFUDOS utility:



- Make sure that the floppy disk is not write-protected and has at least 1.2 MB free space to save the file.
- The succeeding BIOS screens are for reference only. The actual BIOS screen displays may not be same as shown.

1. Copy the AFUDOS utility (afudos.exe) from the motherboard support CD to the bootable floppy disk you created earlier.
2. Boot the system in DOS mode, then at the prompt type:

```
afudos /o[filename]
```

where the [filename] is any user-assigned filename not more than eight alphanumeric characters for the main filename and three alphanumeric characters for the extension name.

```
A:\>afudos /oOLDBIOS1.rom
```

Main file name Extension name

3. Press <Enter>. The utility copies the current BIOS file to the floppy disk.

```
A:\>afudos /oOLDBIOS1.rom
AMI Firmware Update Utility - Version 1.19(ASUS V2.07(03.11.24BB))
Copyright (C) 2002 American Megatrends, Inc. All rights reserved.
  Reading flash ..... done
  Write to file..... ok
A:\>
```

The utility returns to the DOS prompt after copying the current BIOS file.

Updating the BIOS file

To update the BIOS file using the AFUDOS utility:

1. Visit the ASUS website (www.asus.com) and download the latest BIOS file for the motherboard. Save the BIOS file to a bootable floppy disk.



Write the BIOS filename on a piece of paper. You need to type the exact BIOS filename at the DOS prompt.

2. Copy the AFUDOS utility (afudos.exe) from the motherboard support CD to the bootable floppy disk you created earlier.
3. Boot the system in DOS mode, then at the prompt type:

```
afudos /i[filename]
```

where [filename] is the latest or the original BIOS file on the bootable floppy disk.

```
A:\>afudos /iP5WDH.rom
```

4. The utility verifies the file and starts updating the BIOS.

```
A:\>afudos /iP5WDH.rom
AMI Firmware Update Utility - Version 1.19 (ASUS V2.07 (03.11.24BB))
Copyright (C) 2002 American Megatrends, Inc. All rights reserved.

WARNING!! Do not turn off power during flash BIOS
Reading file ..... done
Reading flash ..... done

Advance Check .....
Erasing flash ..... done
Writing flash ..... 0x0008CC00 (9%)
```



Do not shut down or reset the system while updating the BIOS to prevent system boot failure!

5. The utility returns to the DOS prompt after the BIOS update process is completed. Reboot the system from the hard disk drive.

```
A:\>afudos /iP5WDH.com
AMI Firmware Update Utility - Version 1.19(ASUS V2.07(03.11.24BB))
Copyright (C) 2002 American Megatrends, Inc. All rights reserved.

WARNING!! Do not turn off power during flash BIOS
Reading file ..... done
Reading flash ..... done

Advance Check .....
Erasing flash ..... done
Writing flash ..... done
Verifying flash .... done

Please restart your computer

A:\>
```

4.1.5 ASUS CrashFree BIOS 3 utility

The ASUS CrashFree BIOS 3 is an auto recovery tool that allows you to restore the BIOS file when it fails or gets corrupted during the updating process. You can update a corrupted BIOS file using the motherboard support CD, the floppy disk, or the USB flash disk that contains the updated BIOS file.



Prepare the motherboard support CD, the floppy disk or the USB flash disk containing the updated motherboard BIOS before using this utility.

Recovering the BIOS from the support CD

To recover the BIOS from the support CD:

1. Turn on the system.
2. Insert the motherboard support CD to the optical drive.
3. The utility displays the following message and automatically checks the CD for the BIOS file.

```
BIOS ROM checksum error
Detecting IDE ATAPI device...
```

When found, the utility reads the BIOS file and starts flashing the corrupted BIOS file.

4. Restart the system after the utility completes the updating process.

Recovering the BIOS from a floppy/USB flash disk

To recover the BIOS from a floppy/USB flash disk:

1. Download the latest BIOS from the ASUS website (www.asus.com). Rename the BIOS file as **P5WDH.ROM**.
2. Insert the floppy/USB flash disk that contains BIOS file to the FDD/USB port.
3. Turn on the system.
4. The utility will automatically checks the devices for the BIOS file. When found, the utility reads the BIOS file and starts flashing the corrupted BIOS file.
5. Restart the system after the utility completes the updating process.



- Only the USB flash disk with FAT 32/16/12 format and single partition can support ASUS CrashFree BIOS 3. The device size should be smaller than 8GB.
 - Flash time takes around one (1) minute.
 - DO NOT shut down or reset the system while updating the BIOS! Doing so can cause system boot failure!
-

4.2 BIOS setup program

This motherboard supports a programmable firmware chip that you can update using the provided utility described in section “4.1 Managing and updating your BIOS.”

Use the BIOS Setup program when you are installing a motherboard, reconfiguring your system, or prompted to “Run Setup.” This section explains how to configure your system using this utility.

Even if you are not prompted to use the Setup program, you can change the configuration of your computer in the future. For example, you can enable the security password feature or change the power management settings. This requires you to reconfigure your system using the BIOS Setup program so that the computer can recognize these changes and record them in the CMOS RAM or the firmware hub.

The firmware hub on the motherboard stores the Setup utility. When you start up the computer, the system provides you with the opportunity to run this program. Press during the Power-On Self-Test (POST) to enter the Setup utility; otherwise, POST continues with its test routines.

If you wish to enter Setup after POST, restart the system by pressing <Ctrl>+<Alt>+, or by pressing the reset button on the system chassis. You can also restart by turning the system off and then back on. Do this last option only if the first two failed.

The Setup program is designed to make it as easy to use as possible. Being a menu-driven program, it lets you scroll through the various sub-menus and make your selections from the available options using the navigation keys.



-
- The default BIOS settings for this motherboard apply for most conditions to ensure optimum performance. If the system becomes unstable after changing any BIOS settings, load the default settings to ensure system compatibility and stability. Select the Load Default Settings item under the Exit Menu. See section “4.8 Exit Menu.”
 - The BIOS setup screens shown in this section are for reference purposes only, and may not exactly match what you see on your screen.
 - Visit the ASUS website (www.asus.com) to download the latest BIOS file for this motherboard.
-

4.2.1 BIOS menu screen

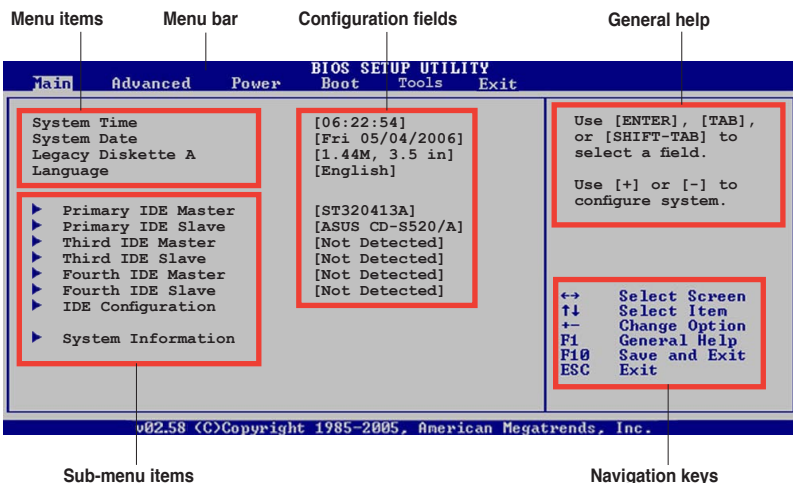

4.2.2 Menu bar

The menu bar on top of the screen has the following main items:

Main	For changing the basic system configuration
Advanced	For changing the advanced system settings
Power	For changing the advanced power management (APM) configuration
Boot	For changing the system boot configuration
Exit	For selecting the exit options and loading default settings

To select an item on the menu bar, press the right or left arrow key on the keyboard until the desired item is highlighted.

4.2.3 Navigation keys

At the bottom right corner of a menu screen are the navigation keys for that particular menu. Use the navigation keys to select items in the menu and change the settings.



Some of the navigation keys differ from one screen to another.

4.2.4 Menu items

The highlighted item on the menu bar displays the specific items for that menu. For example, selecting Main shows the Main menu items.

The other items (Advanced, Power, Boot, and Exit) on the menu bar have their respective menu items.

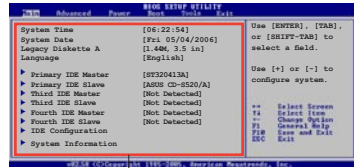

Main menu items

4.2.5 Sub-menu items

A solid triangle before each item on any menu screen means that the item has a sub-menu. To display the sub-menu, select the item and press <Enter>.

4.2.6 Configuration fields

These fields show the values for the menu items. If an item is user-configurable, you can change the value of the field opposite the item. You cannot select an item that is not user-configurable.

A configurable field is enclosed in brackets, and is highlighted when selected. To change the value of a field, select it then press <Enter> to display a list of options. Refer to “4.2.7 Pop-up window.”

4.2.7 Pop-up window

Select a menu item then press <Enter> to display a pop-up window with the configuration options for that item.

4.2.8 Scroll bar

A scroll bar appears on the right side of a menu screen when there are items that do not fit on the screen. Press the Up/Down arrow keys or <Page Up> /<Page Down> keys to display the other items on the screen.

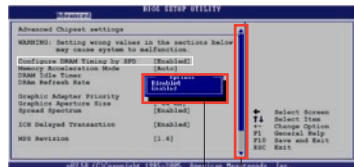

Pop-up window

Scroll bar

4.2.9 General help

At the top right corner of the menu screen is a brief description of the selected item.

4.3 Main menu

When you enter the BIOS Setup program, the Main menu screen appears, giving you an overview of the basic system information.



Refer to section “4.2.1 BIOS menu screen” for information on the menu screen items and how to navigate through them.

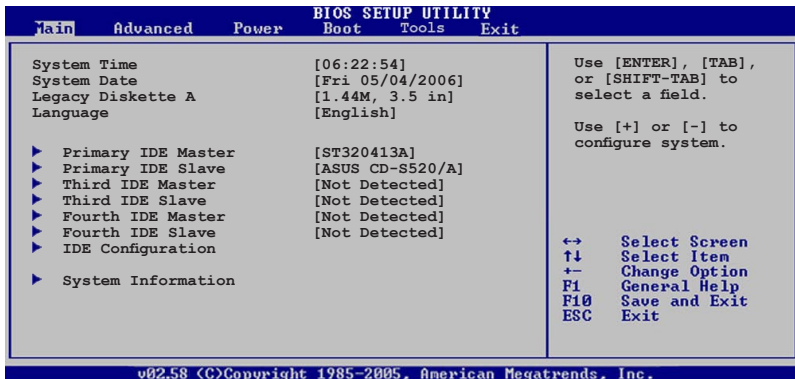

4.3.1 System Time [xx:xx:xx]

Allows you to set the system time.

4.3.2 System Date [Day xx/xx/xxxx]

Allows you to set the system date.

4.3.3 Legacy Diskette A [1.44M, 3.5 in.]

Sets the type of floppy drive installed. Configuration options: [Disabled] [360K, 5.25 in.] [1.2M, 5.25 in.] [720K, 3.5 in.] [1.44M, 3.5 in.] [2.88M, 3.5 in.]

4.3.4 Language [English]

Allows you to choose the BIOS language version from the options.
Configuration options: [English] [Français] [Deutsch] [Japanese] [Chinese (GB)] [Chinese BIG5]

4.3.5 Primary, Third, and Fourth IDE Master/Slave

The BIOS automatically detects the connected IDE devices. There is a separate sub-menu for each IDE device. Select a device item, then press <Enter> to display the IDE device information.

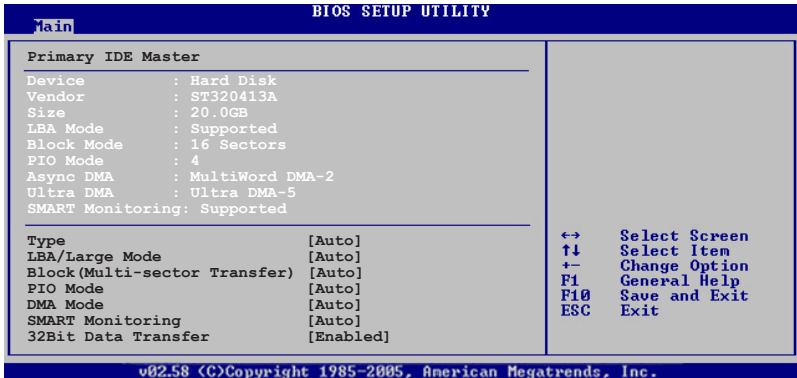

The BIOS automatically detects the values opposite the dimmed items (Device, Vendor, Size, LBA Mode, Block Mode, PIO Mode, Async DMA, Ultra DMA, and SMART monitoring). These values are not user-configurable. These items show N/A if no IDE device is installed in the system.

Type [Auto]

Selects the type of IDE drive. Setting to [Auto] allows automatic selection of the appropriate IDE device type. Select [CDROM] if you are specifically configuring a CD-ROM drive. Select [ARMD] (ATAPI Removable Media Device) if your device is either a ZIP, LS-120, or MO drive.

Configuration options: [Not Installed] [Auto] [CDROM] [ARMD]

LBA/Large Mode [Auto]

Enables or disables the LBA mode. Setting to [Auto] enables the LBA mode if the device supports this mode, and if the device was not previously formatted with LBA mode disabled. Configuration options: [Disabled] [Auto]

Block (Multi-sector Transfer) [Auto]

Enables or disables data multi-sectors transfers. When set to [Auto], the data transfer from and to the device occurs multiple sectors at a time if the device supports multi-sector transfer feature. When set to [Disabled], the data transfer from and to the device occurs one sector at a time. Configuration options:

[Disabled] [Auto]

PIO Mode [Auto]

Selects the PIO mode.

Configuration options: [Auto] [0] [1] [2] [3] [4]

DMA Mode [Auto]

Selects the DMA mode. Configuration options: [Auto] [SWDMA0] [SWDMA1] [SWDMA2] [MWDMA0] [MWDMA1] [MWDMA2] [UDMA0] [UDMA1] [UDMA2] [UDMA3] [UDMA4] [UDMA5]

SMART Monitoring [Auto]

Sets the Smart Monitoring, Analysis, and Reporting Technology. Configuration options: [Auto] [Disabled] [Enabled]

32Bit Data Transfer [Enabled]

Enables or disables 32-bit data transfer.

Configuration options: [Disabled] [Enabled]

4.3.6 IDE Configuration

The items in this menu allow you to set or change the configurations for the IDE devices installed in the system. Select an item then press <Enter> if you want to configure the item.

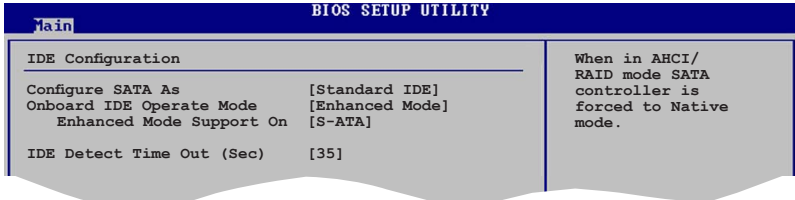

Configure SATA As [Standard IDE]

Sets the configuration for the Serial ATA connectors supported by the Southbridge chip.

The AHCI allows the onboard storage driver to enable advanced Serial ATA features that increases storage performance on random workloads by allowing the drive to internally optimize the order of commands.

If you want to create a RAID 0, RAID 1, RAID 5, RAID 10, or the Intel® Matrix Storage Technology configuration from the Serial ATA hard disk drives, set this item to [RAID].

If you want to use the Serial ATA hard disk drives as Parallel ATA physical storage devices, keep the default setting [Standard IDE].

If you want the Serial ATA hard disk drives to use the Advanced Host Controller Interface (AHCI), set this item to [AHCI].

For details on AHCI, go to:

www.intel.com/support/chipsets/imst/sb/CS-012304.htm

www.intel.com/support/chipsets/imst/sb/CS-012305.htm

The SATA controller is set to Native mode when this item is set to [RAID] or [AHCI]



The Onboard IDE Operate Mode and sub-menu items appear only when the Configure SATA As item is set to [Standard IDE].

Onboard IDE Operate Mode [Enhanced Mode]

Allows selection of the IDE operation mode depending on the installed operating system (OS). Set to [Enhanced Mode] if you are using native OS including Windows® 2000/XP or later version. Configuration options: [Disabled] [Compatible Mode] [Enhanced Mode]



If you are using a Serial ATA optical drive, set this item to [Compatible Mode] before creating a boot disk using the support CD.

Enhanced Mode Support On [S-ATA]

Allows you to use native OS on Serial ATA and Parallel ATA ports. It is recommended that you do not change the default setting for better OS compatibility. In this setting, you may use legacy OS on the Parallel ATA ports only if you do not install any Serial ATA device.

The P-ATA+S-ATA and P-ATA options are for advanced users only. If you set to any of these options and encountered problems, revert to the default setting S-ATA.

Configuration options: [S-ATA+P-ATA] [S-ATA only] [P-ATA only]

Combined Mode Option [Primary P-ATA + S-ATA]

Allows you to select the IDE ports to use. Configuration options: [Primary P-ATA+S-ATA] [S-ATA only] [P-ATA only]

The S-ATA and P-ATA options are for advanced users only. If you set to any of these options and encounter problems, revert to the default setting [Primary P-ATA+S-ATA]. Configuration options: [Primary P-ATA+S-ATA] [S-ATA] [P-ATA]



The **Combined Mode Option** item appears only when the **Onboard IDE Operate Mode** item is set to [Compatible Mode].

Onboard Serial-ATA BOOTROM [Enabled]

Enables or disables the onboard Serial ATA boot ROM.

Configuration options: [Disabled] [Enabled]



The **Onboard Serial-ATA BOOTROM** appears only when the **Configure SATA As** item is set to [RAID].

ALPE and ASP [Disabled]

Allows you to enable or disable the Aggressive Link Power Management (ALPE) and Aggressive Slumber/Partial (ASP) management features. Configuration options: [Disabled] [Enabled]



The **ALPE and ASP** and its sub-menu item appear only when the **Configure SATA As** item is set to [AHCI].

IDE Detect Time Out [35]

Selects the time out value for detecting ATA/ATAPI devices. Configuration options: [0] [5] [10] [15] [20] [25] [30] [35]

4.3.7 System Information

This menu gives you an overview of the general system specifications. The BIOS automatically detects the items in this menu.

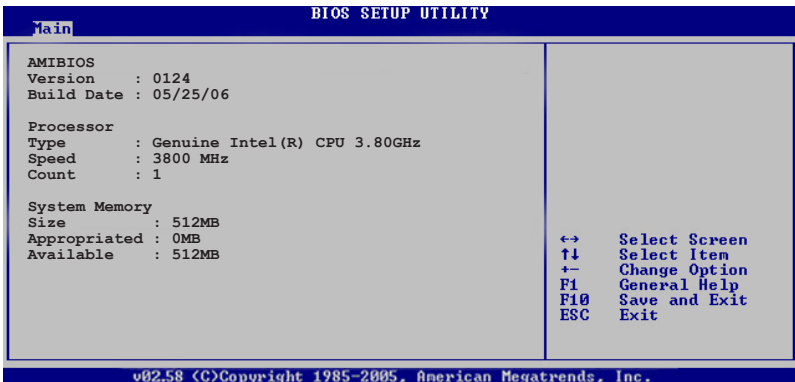

AMI BIOS

Displays the auto-detected BIOS information.

Processor

Displays the auto-detected CPU specification.

System Memory

Displays the auto-detected system memory.

4.4 Advanced menu

The Advanced menu items allow you to change the settings for the CPU and other system devices.



Take caution when changing the settings of the Advanced menu items. Incorrect field values can cause the system to malfunction.

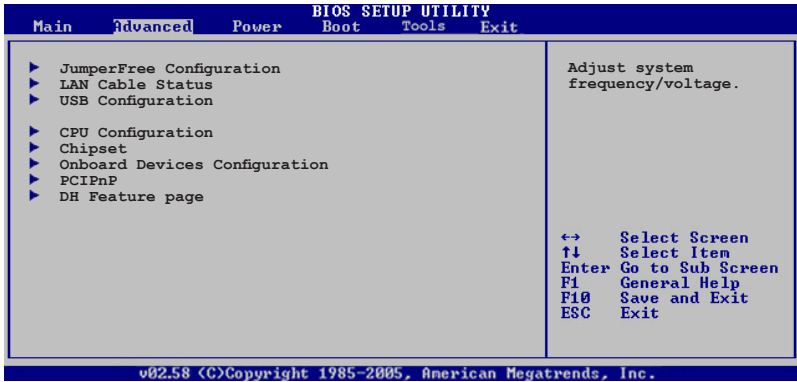

4.4.1 JumperFree Configuration

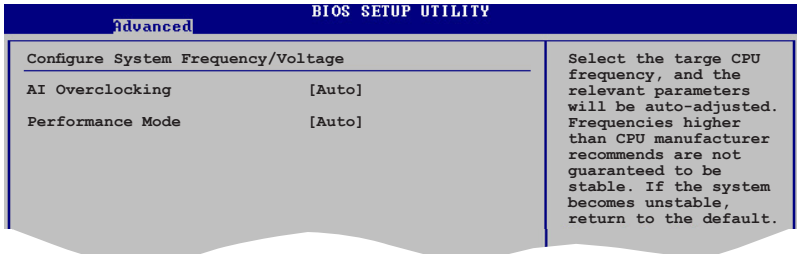

AI Overclocking [Auto]

Allows you to select the overclocking options to achieve the desired CPU internal frequency. Select either one of the preset overclocking configuration options.

Manual - allows you to individually set overclocking parameters.

Auto - loads the optimal settings for the system.

Overclock Profile - loads overclocking profiles with optimal parameters for stability when overclocking.

AI NOS - the ASUS AI Non-delay Overclocking System feature intelligently determines the system load and automatically boost the performance for the most demanding tasks.



The following items appear only when you set the AI Overclocking item to [Manual].

CPU Frequency [XXX]

Displays the frequency sent by the clock generator to the system bus and PCI bus. The value of this item is auto-detected by the BIOS. Use the <+> and <-> keys to adjust the CPU frequency. You can also type the desired CPU frequency using the numeric keypad. The values range from 100 to 450. Refer to the table below for the correct Front Side Bus and CPU External Frequency settings.

FSB/CPU External Frequency Synchronization

Front Side Bus	CPU External Frequency
FSB 1066	266 MHz
FSB 800	200 MHz

DRAM Frequency [Auto]

Allows you to set the DDR operating frequency.

Configuration options: [Auto] [DDR2-300MHz] [DDR2-400MHz]

Available DRAM frequency options in various FSB settings

FSB	Configuration options							
	Auto	DDR2-400	DDR2-533	DDR2-667	DDR2-711*	DDR2-800*	DDR2-889*	DDR2-1067*
FSB 1066	•	•	•	•	•	•	•	•
FSB 800	•	•	•	•		•		

* Provided for overclocking purpose only.



Selecting a very high DRAM frequency may cause the system to become unstable! If this happens, revert to the default setting.

Performance Mode [Auto]

Allows enhanced system performance. Setting to [Turbo] may cause the system to become unstable. If this happens, revert to the default setting [Auto]. Configuration options: [Auto] [Standard] [Turbo]

PCI Express Frequency [Auto]

Allows you to set the PCI Express frequency. This item is set to [Auto] by default.
Configuration options: [Auto] [90] [91] ~ [150]

PCI Clock Synchronization Mode [Auto]

Allows you to synchronize the PCI frequency with the PCI Express or CPU frequency.
Configuration options: [To CPU] [33.33MHz] [Auto]



The following items also appear when the **AI Overclocking** item is set to [AI NOS].

Memory Voltage [Auto]

Allows you to select the DDR2 reference voltage.
Configuration options: [Auto] [1.80V] [1.90V] [1.95V] [2.00V] [2.05V] [2.10V] [2.15V] [2.20V] [2.25V] [2.30V] [2.35V] [2.40V]



Refer to the DDR2 documentation before adjusting the memory voltage. Setting a very high memory voltage may damage the memory module(s)!

CPU VCore Voltage [Auto]

Allows you to select the CPU VCore voltage. Configuration options: [Auto] [1.7000V] [1.6875V] [1.6750V] [1.6625V] [1.6500V] [1.6375V] [1.6250V] [1.6125V] [1.6000V] [1.5875V] [1.5750V] [1.5625V] [1.5500V] [1.5375V] [1.5250V] [1.5125V] [1.5000V] [1.4875V] [1.4750V] [1.4625V] [1.4500V] [1.4375V] [1.4250V] [1.4125V] [1.4000V] [1.3875V] [1.3750V] [1.3625V] [1.3500V] [1.3375V] [1.3250V] [1.3125V] [1.3000V] [1.2875V] [1.2750V] [1.2625V] [1.2500V] [1.2375V] [1.2250V] [1.2125V] [1.2000V]



Refer to the CPU documentation before setting the CPU Vcore voltage. Setting a high Vcore voltage may damage the CPU!

FSB Termination Voltage [Auto]

Allows you to select the front side bus termination voltage.
Configuration options: [Auto] [1.20V] [1.30V] [1.40V] [1.50V]



Setting a high FSB termination voltage may damage the chipset and CPU.

MCH Chipset Voltage [Auto]

Allows you to select the chipset voltage of the memory controller hub (MCH).

Configuration options: [Auto] [1.50V] [1.55V] [1.60V] [1.65V]



Setting a high MCH chipset voltage may damage the chipset!

ICH Chipset Voltage [Auto]

Allows you to select the chipset voltage of the I/O controller hub (ICH).

Configuration options: [Auto] [1.05V] [1.20V]



Setting a high ICH chipset voltage may damage the chipset!



The following item appears only when the **AI Overclocking** item is set to [Overclock Profile].

Overclock Options [Overclock 5%]

Allows you to overclock the CPU speed through the available preset values.

Configuration options:

[Overclock 5%]	[FSB888/DDR2-667]
[Overclock 10%]	[FSB960/DDR2-800]
[Overclock 15%]	[FSB1200/DDR2-800]
[Overclock 20%]	[FSB1280/DDR2-800]
[Overclock 30%]	[FSB1333/DDR2-667]
	[FSB1333/DDR2-834]



The following item appears only when the **AI Overclocking** item is set to [AI NOS].

N.O.S. Mode [Auto]

Sets the Non-Delay Overclocking System mode. Select either of the following configuration options:

Auto - loads the optimum sensitivity and overclocking percentage setting.

Manual - allows you to manually set overclocking configurations.



The following items appear if the **NOS Mode** item is set to [Manual]

Sensitivity [Sensitive]

Allows you to choose the sensitivity of the AI NOS sensor. Setting this item to [Sensitive] will trigger AI NOS with less CPU loading. Configuration options: [Normal] [Sensitive] [Less-Sensitive]

Target Frequency [Overclock 3%]

Allows you to set the maximum overclock percentage for the selected NOS Mode. Configuration options: [Overclock 3%] [Overclock 5%] [Overclock 7%] [Overclock 10%] [Overclock 15%] [Overclock 20%] [Overclock 30%]



Selecting a very high frequency may cause the system to become unstable. If this happens, revert to the default setting.

4.4.2 LAN Cable Status

This menu displays the status of the Local Area Network (LAN) cable connected to the LAN (RJ-45) port.

Advanced			BIOS SETUP UTILITY
POST Check LAN Cable			[Disabled]
LAN Cable Status			
Pair	Status	Length	
1-2	Normal	N/A	
3-6	Normal	N/A	
4-5	Normal	N/A	
7-8	Normal	N/A	
1-2	Open	0.0M	
3-6	Open	0.0M	
4-5	Open	0.0M	
7-8	Open	0.0M	
			Check PCI Marvell LAN cable during
002.58 (C)Copyright 1985-2005, American Megatrends, Inc.			

POST Check LAN Cable [Disabled]

Allows you to enable or disable LAN cable check during POST. When enabled, the menu reports the cable faults or shorts, and displays the point (length) where the fault or short is detected. Configuration options: [Disabled] [Enabled]

4.4.3 USB Configuration

The items in this menu allows you to change the USB-related features. Select an item then press <Enter> to display the configuration options.

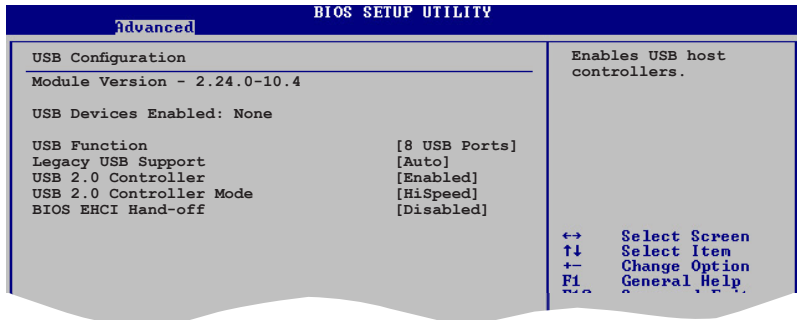

The Module Version and USB Devices Enabled items show the auto-detected values. If no USB device is detected, the item shows None.

USB Function [8 USB Ports]

Disables the USB host controllers or specifies the .

Configuration options: [Disabled] [2 USB ports] [4 USB ports] [6 USB ports] [8 USB ports]

Legacy USB Support [Auto]

Allows you to enable or disable support for legacy USB devices. Setting to [Auto] allows the system to detect the presence of USB devices at startup. If detected, the USB controller legacy mode is enabled. If no USB device is detected, the legacy USB support is disabled. Configuration options: [Disabled] [Enabled] [Auto]

USB 2.0 Controller [Enabled]

Allows you to disable the USB 2.0 controller, or specify the number of ports to enable Configuration options: [Disabled] [Enabled]

USB 2.0 Controller Mode [HiSpeed]

Allows you to set the USB 2.0 controller mode to HiSpeed (480 Mbps) or FullSpeed (12 Mbps). Configuration options: [HiSpeed] [FullSpeed]

BIOS EHCI Hand-off [Disabled]

Allows you to enable support for operating systems without an EHCI hand-off feature. Configuration options: [Disabled] [Enabled]

4.4.4 CPU Configuration

The items in this menu show the CPU-related information that the BIOS automatically detects.

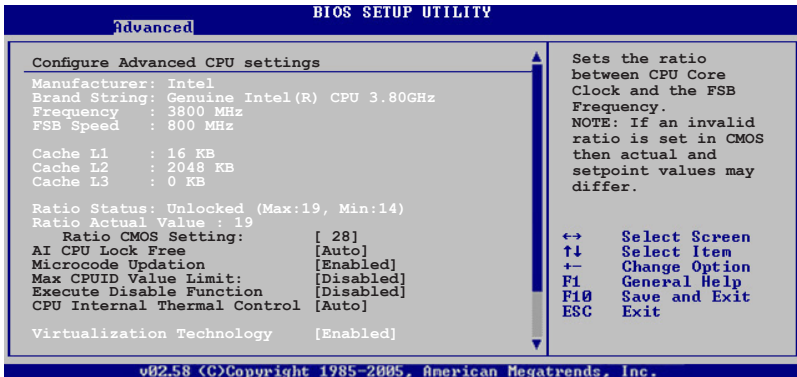

Ratio CMOS Setting [28]

Sets the ratio between the CPU core clock and the Front Side Bus frequency. The BIOS auto-detects the default value of this item. Use the <+> or <-> keys to adjust the values.



You can only adjust the Ratio CMOS if you installed an unlocked CPU. Refer to the CPU documentation for details.



The **AI CPU Lock Free** item appears only when you install a CPU that supports the lock free feature. Only some latest CPUs support this feature.

AI CPU Lock Free [Auto]

Disables or sets the AI CPU Lock Free feature.
Configuration options: [Auto] [Disabled] [Enabled]

Microcode Updation [Enabled]

Allows you to enable or disable the microcode updation.
Configuration options: [Disabled] [Enabled]

Max CPUID Value Limit [Disabled]

Setting this item to [Enabled] allows legacy operating systems to boot even without support for CPUs with extended CPUID functions.
Configuration options: [Disabled] [Enabled]

Execute Disable Function [Disabled]

Allows you to enable or disable the No-Execution Page Protection Technology. Setting this item to [Enabled] forces the XD feature flag to always return to zero (0). Configuration options: [Disabled] [Enabled]

CPU Internal Thermal Control [Auto]

Allows you to disable or set to auto the CPU Internal Thermal Control function. When set to [Auto], the BIOS automatically checks the CPU's capability to enable TM or TM2 support. In TM mode, the CPU power consumption is reduced. In TM2 mode, the CPU core and VID are reduced. Configuration options: [Auto] [Disabled]



The following item appears only when you installed an Intel® Pentium® 4 CPU that supports the Enhanced Intel SpeedStep® Technology (EIST).

Intel(R) SpeedStep Technology [Disabled]

Allows you to use the Enhanced Intel SpeedStep® Technology. When set to [Automatic], you can adjust the system power settings in the operating system to use the EIST feature.

Set this item to [Disabled] if you do not want to use the EIST.

Configuration options: [Automatic] [Disabled] [Minimum]



-
- Refer to the Appendix for details on how to use the EIST feature.
 - The motherboard comes with a BIOS file that supports EIST.
-



The following item appears only when you installed an Intel® Pentium® 4 CPU that supports Hyper Threading Technology.

Hyper Threading Technology [Enabled]

Allows you to enable or disable the processor Hyper-Threading Technology. Configuration options: [Disabled] [Enabled]

4.4.5 Chipset

The Chipset menu allows you to change the advanced chipset settings. Select an item then press <Enter> to display the sub-menu.

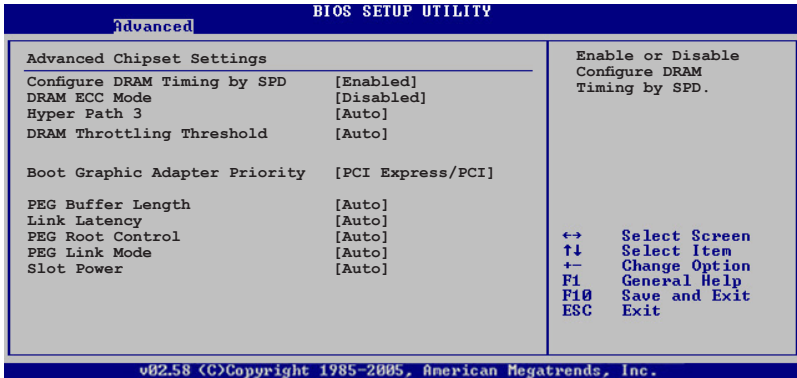

Configure DRAM Timing by SPD [Enabled]

When this item is enabled, the DRAM timing parameters are set according to the DRAM SPD (Serial Presence Detect). When disabled, you can manually set the DRAM timing parameters through the DRAM sub-items. The following sub-items appear when this item is Disabled. Configuration options: [Disabled] [Enabled]

DRAM CAS# Latency [5 Clocks]

Controls the latency between the SDRAM read command and the time the data actually becomes available. Configuration options: [6 Clocks] [5 Clocks] [4 Clocks] [3 Clocks]

DRAM RAS# Precharge [4 Clocks]

Controls the idle clocks after issuing a precharge command to the DDR SDRAM. Configuration options: [2 Clocks] ~ [6 Clocks]

DRAM RAS# to CAS# Delay [4 Clocks]

Controls the latency between the DDR SDRAM active command and the read/write command. Configuration options: [2 Clocks] ~ [6 Clocks]

DRAM RAS# Activate to Precharge Delay [15 Clocks]

Configuration options: [4 Clocks] ~ [18 Clocks]

DRAM Write Recovery Time [4 Clocks]

Configuration options: [2 Clocks] ~ [6 Clocks]

DRAM ECC Mode [Disabled]

Allows you to disable or set the DRAM ECC mode. This item appears only when you install DRAM modules that support ECC function. Configuration options: [Disabled] [Enabled] [Auto]

Hyper Path 3 [Auto]

Allows you to enable, disable, or set the ASUS Hyper Path 3 feature. Configuration options: [Disabled] [Enabled] [Auto]

DRAM Throttling Threshold [Auto]

Disables or sets the DRAM Thermal Throttling feature. Set to [Auto] for system stability. Configuration options: [Disabled] [Auto]

Boot Graphic Adapter Priority [PCI Express/PCI]

Allows selection of the graphics controller to use as primary boot device. Configuration options: [PCI Express/PCI] [PCI/PCI Express]

PEG Buffer Length [Auto]

Sets the length of the PCI Express graphics card buffer. Configuration options: [Auto] [Long] [Short]

Link Latency [Auto]

Sets the PCI Express graphics card link latency. Configuration options: [Auto] [Slow] [Normal]

PEG Root Control [Auto]

Allows you to enable, disable, or set to automatic the PCI Express graphics card root control. Configuration options: [Auto] [Disabled] [Enabled]

PEG Link Mode [Auto]

Sets the PCI Express graphics link mode. Setting this item to [Auto] allows the motherboard to automatically adjust the PCI Express graphics link mode to the correct frequency based on the system configuration. Four additional settings are available for overclocking the PEG Link Mode. Configuration options: [Auto] [Slow] [Normal] [Fast] [Faster]

Slot Power [Auto]

Sets the PCI Express graphics card slot power. Configuration options: [Auto] [Light] [Normal] [Heavy] [Heavier]

4.4.6 Onboard Devices Configuration

Advanced		BIOS SETUP UTILITY	
Configure Win627EHG Super IO Chipset		Enable or disable High Definition Audio Controller.	
HD Audio Controller	[Enabled]		
Front Panel Support Type	[HD Audio]		
Onboard 1394 Controller	[Enabled]		
Onboard PCIE GbE LAN_1	[Enabled]		
Onboard PCIE GbE LAN_2	[Enabled]		
LAN Option ROM	[Disabled]		
JMicron SATA/PATA Controller	[Enabled]		
JMicron Controller Mode	[Basic]		
JMicron SATA/RAID BOOTROM	[Enabled]		
Serial Port1 Address	[3F8/IRQ4]		

002.58 (C)Copyright 1985-2005, American Megatrends, Inc.

HD Audio Controller [Enabled]

Allows you to enable or disable the high-definition audio CODEC.
Configuration options: [Enabled] [Disabled]

Front Panel Support Type [HD Audio]

Allows you to set the front panel audio connector (AAFP) mode to legacy AC'97 or high-definition audio depending on the audio standard that the front panel audio module supports. Configuration options: [AC97] [HD Audio]

Onboard 1394 Controller [Enabled]

Allows you to enable or disable the onboard IEEE 1394 controller. Configuration options: [Disabled] [Enabled]

Onboard PCIE GbE LAN_1 [Enabled]

Allows you to enable or disable the onboard PCI Express Gigabit LAN 1 controller. Configuration options: [Disabled] [Enabled]

Onboard PCIE GbE LAN_2 [Enabled]

Allows you to enable or disable the onboard PCI Express Gigabit LAN 2 controller. Configuration options: [Disabled] [Enabled]

LAN Option ROM [Disabled]

This item allows you to enable or disable the option ROM in the onboard LAN controller. This item appears only when the Onboard PCIE Gbe LAN item is set to Enabled. Configuration options: [Disabled] [Enabled]

JMicron SATA/PATA Controller [Enabled]

Allows you to enable or disable the JMicron Serial ATA/Parallel ATA controller.

Configuration options: [Disabled] [Enabled]

JMicron Controller Mode [Basic]

Allows you to set the mode of the JMicron controller.

Configuration options: [Raid] [Basic] [AHCI]

JMicron SATA/RAID BOOTROM [Enabled]

Allows you to enable or disable the JMicron Serial ATA RAID boot ROM.

Configuration options: [Disabled] [Enabled]



Setting the above item to [Disabled] may cause adverse effects. We strongly recommend that you keep the default setting [Enabled].

Serial Port1 Address [3F8/IRQ4]

Allows you to select the Serial Port1 base address.

Configuration options: [Disabled] [3F8/IRQ4] [2F8/IRQ3] [3E8/IRQ4] [2E8/IRQ3]

4.4.7 PCI PnP

The PCI PnP menu items allow you to change the advanced settings for PCI/PnP devices. The menu includes setting IRQ and DMA channel resources for either PCI/PnP or legacy ISA devices, and setting the memory size block for legacy ISA devices.



Take caution when changing the settings of the PCI PnP menu items. Incorrect field values can cause the system to malfunction.



Plug And Play O/S [No]

When set to [No], BIOS configures all the devices in the system. When set to [Yes] and if you install a Plug and Play operating system, the operating system configures the Plug and Play devices not required for boot. Configuration options: [No] [Yes]

PCI Latency Timer [64]

Allows you to select the value in units of PCI clocks for the PCI device latency timer register. Configuration options: [32] [64] [96] [128] [160] [192] [224] [248]

Allocate IRQ to PCI VGA [Yes]

When set to [Yes], BIOS assigns an IRQ to PCI VGA card if the card requests for an IRQ. When set to [No], BIOS does not assign an IRQ to the PCI VGA card even if requested. Configuration options: [No] [Yes]

Palette Snooping [Disabled]

When set to [Enabled], the palette snooping feature informs the PCI devices that an ISA graphics device is installed in the system so that the latter can function correctly. Configuration options: [Disabled] [Enabled]

IRQ-xx assigned to [PCI Device]

When set to [PCI Device], the specific IRQ is free for use of PCI/PnP devices.
When set to [Reserved], the IRQ is reserved for legacy ISA devices. Configuration options: [PCI Device] [Reserved]

4.4.8 DH Feature page

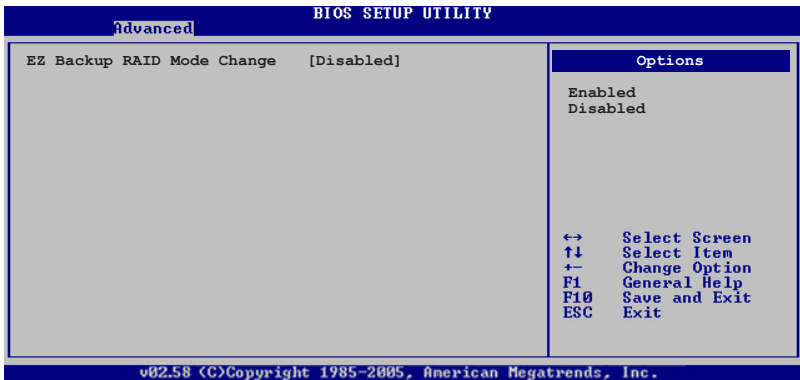

EZ Backup RAID Mode Change [Disabled]

Allows you to enable or disable RAID mode change for the EZ-Backup feature.
For detailed information about building an EZ-Backup RAID set, see section "5.4.4 Silicon Image RAID configuration." Configuration options: [Disabled] [Enabled]

4.5 Power menu

The Power menu items allow you to change the settings for the ACPI and Advanced Power Management (APM) features. Select an item then press <Enter> to display the configuration options.

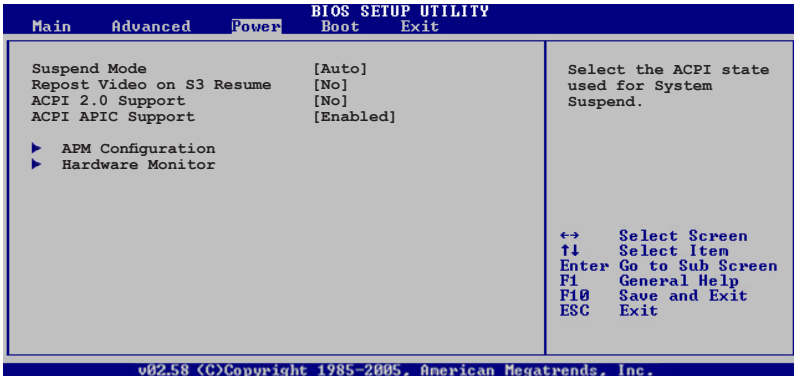

4.5.1 Suspend Mode [Auto]

Allows you to select the Advanced Configuration and Power Interface (ACPI) state to be used for system suspend. Setting this item to [Auto] allows the OS to select the ACPI state. Configuration options: [S1 (POS) Only] [S3 Only] [Auto]

4.5.2 Repost Video on S3 Resume [No]

Determines whether to invoke VGA BIOS POST on S3/STR resume. Configuration options: [No] [Yes]

4.5.3 ACPI 2.0 Support [No]

Allows you to add more tables for Advanced Configuration and Power Interface (ACPI) 2.0 specifications. Configuration options: [No] [Yes]

4.5.4 ACPI APIC Support [Enabled]

Allows you to enable or disable the Advanced Configuration and Power Interface (ACPI) support in the Advanced Programmable Interrupt Controller (APIC). When set to Enabled, the ACPI APIC table pointer is included in the RSDT pointer list. Configuration options: [Disabled] [Enabled]

4.5.5 APM Configuration

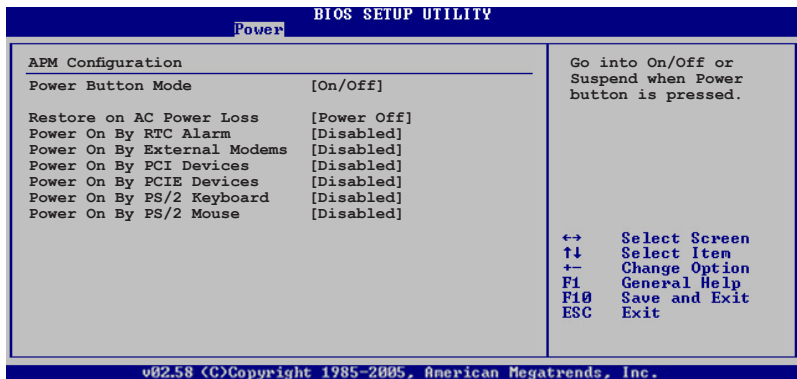

Power Button Mode [On/Off]

Allows the system to go into On/Off mode or suspend mode when the power button is pressed. Configuration options: [On/Off] [Suspend]

Restore on AC Power Loss [Power Off]

When set to Power Off, the system goes into off state after an AC power loss. When set to Power On, the system goes on after an AC power loss. When set to Last State, the system goes into either off or on state, whatever the system state was before the AC power loss. Configuration options: [Power Off] [Power On] [Last State]

Power On By RTC Alarm [Disabled]

Allows you to enable or disable RTC to generate a wake event. Configuration options: [Disabled] [Enabled]



The succeeding items appear when the **Power On By RTC Alarm** item is set to Enabled.

RTC Alarm Date

To set the alarm date, highlight this item and press the <+> or <-> key to make the selection. Configuration options: [Everyday] [1] [2] [3]... ~ [31]

RTC Alarm Hour

To set the alarm hour, highlight this item and press the <+> or <-> key to make the selection. Configuration options: [00] [1]... ~ [23]

RTC Alarm Minute

To set the alarm minute, highlight this item and press the <+> or <-> key to make the selection. Configuration options: [00] [1]... ~ [59]

RTC Alarm Second

To set the alarm second, highlight this item and press the <+> or <-> key to make the selection. Configuration options: [00] [1]... ~ [59]

Power On By External Modems [Disabled]

Allows either settings of [Enabled] or [Disabled] for powering up the computer when the external modem receives a call while the computer is in Soft-off mode. Configuration options: [Disabled] [Enabled]



The computer cannot receive or transmit data until the computer and applications are fully running. Thus, connection cannot be made on the first try. Turning an external modem off and then back on while the computer is off causes an initialization string that turns the system power on.

Power On By PCI Devices [Disabled]

When set to [Enabled], this parameter allows you to turn on the system through a PCI LAN or modem card. This feature requires an ATX power supply that provides at least 1A on the +5VSB lead.

Configuration options: [Disabled] [Enabled]

Power On By PCIE Devices [Disabled]

When set to [Enabled], this parameter allows you to turn on the system through a PCI Express device. Configuration options: [Disabled] [Enabled]

Power On By PS/2 Keyboard [Disabled]

Allows you to use specific keys on the keyboard to turn on the system. This feature requires an ATX power supply that provides at least 1A on the +5VSB lead.

Configuration options: [Disabled] [Space Bar] [Ctrl-Esc] [Power Key]

Power On By PS/2 Mouse [Disabled]

When set to [Enabled], this parameter allows you to use the PS/2 mouse to turn on the system. This feature requires an ATX power supply that provides at least 1A on the +5VSB lead. Configuration options: [Disabled] [Enabled]

4.5.6 Hardware Monitor

BIOS SETUP UTILITY		
Power		
Hardware Monitor		Automatically optimize BIOS settings to minimize CPU FAN Speed according to system loading.
AI Quiet	[Enabled]	
CPU Temperature	[54°C/129°F]	
MB Temperature	[37°C/98.5°F]	
CPU Fan Speed (RPM)	[2884RPM]	
CPU Q-Fan Control	[Enabled]	
CPU Q-Fan Mode	[PWM]	
CPU Fan Profile	[Optimal]	
Chassis Fan1 Speed (RPM)	[N/A]	
Chassis Fan2 Speed (RPM)	[N/A]	
Chassis Q-Fan Control	[Enabled]	
Chassis Fan Profile	[Optimal]	
Power Fan1 Speed (RPM)	[N/A]	
Power Fan2 Speed (RPM)	[N/A]	
PWR Q-Fan Control	[Enabled]	
PWR Fan Profile	[Optimal]	

↔ Select Screen
↑↓ Select Item
+− Change Option
F1 General Help
F10 Save and Exit
ESC Exit

v02.58 (C)Copyright 1985-2005, American Megatrends, Inc.

Scroll down to display more items

VCORE Voltage	[1.488V]	↔ Select Screen ↑↓ Select Item +− Change Option F1 General Help F10 Save and Exit ESC Exit
3.3V Voltage	[3.312V]	
5V Voltage	[5.324V]	
12V Voltage	[12.144V]	

v02.58 (C)Copyright 1985-2005, American Megatrends, Inc.

AI Quiet [Enabled]

Allows you to enable or disable the ASUS AI Quiet feature. ASUS AI Quiet optimizes system performance by automatically adjusting the CPU fan speed according to the system loading. Configuration options: [Disabled] [Enabled]

CPU Temperature [xxx°C/xxx°F]

MB Temperature [xxx°C/xxx°F]

The onboard hardware monitor automatically detects and displays the motherboard and CPU temperatures. Select [Ignored] if you do not wish to display the detected temperatures.

CPU Fan Speed (RPM) [xxxxRPM] or [Ignored]

The onboard hardware monitor automatically detects and displays the CPU fan speed in rotations per minute (RPM). If the fan is not connected to the motherboard, the field shows N/A. Select [Ignored] from the item options to disable CPU fan speed monitoring.

CPU Q-Fan Control [Enabled]

Allows you to enable or disable the CPU Q-Fan feature that smartly adjusts the fan speeds for more efficient system operation. Configuration options: [Disabled] [Enabled]



The CPU Q-Fan Mode and CPU Fan Profile Mode items appear when you enable the ASUS Q-FAN Control feature.

CPU Q-Fan Mode [PWM]

Allows you to select the type of CPU fan cable connected to the CPU fan connector. Set to [PWM] when using a 4-pin CPU fan cable. Set to [DC] when using a 3-pin CPU fan cable. Configuration options: [PWM] [DC]



Some CPU fans with a 4-pin cable do not comply with Intel®'s PWM fan specification. When using this type of CPU fan, you can not reduce the CPU fan speed even if you set the CPU Q-Fan Mode to [PWM].

CPU Fan Profile [Optimal]

Allows you to set the appropriate CPU fan performance. When set to [Optimal], the CPU fan automatically adjusts depending on the CPU temperature. Set this item to [Silent] to minimize fan speed for quiet CPU fan operation, or [Performance] to achieve maximum CPU fan speed. Configuration options: [Optimal] [Silent Mode] [Performance Mode]

Chassis Fan1/2 Speed [xxxxRPM] or [N/A]/[Ignored]

The onboard hardware monitor automatically detects and displays the chassis fan speed in rotations per minute (RPM). If the fan is not connected to the chassis, the specific field shows N/A. Select [Ignored] from the item options to disable chassis fan speed monitoring.

Chassis Q-Fan Control [Enabled]

Allows you to enable or disable the ASUS Q-Fan feature that smartly adjusts the chassis fan speeds for more efficient system operation. Configuration options: [Disabled] [Enabled]



-
- The Chassis Q-Fan function is available only on CHA_FAN1.
 - The Chassis Fan Profile Mode item appears when you enable the Chassis Q-Fan Control feature.
-

Chassis Fan Profile [Optimal]

Allows you to set the appropriate performance level of the chassis Q-Fan. Configuration options: [Optimal] [Silent Mode] [Performance Mode]

Power Fan1/2 Speed [xxxxRPM] or [N/A] or [Ignored]

The onboard hardware monitor automatically detects and displays the power fan speed in rotations per minute (RPM). If the fan is not connected, the specific field shows N/A. Select [Ignored] from the item options to disable power fan speed monitoring.

PWR Q-Fan Control [Enabled]

Allows you to enable or disable the ASUS Q-Fan feature that smartly adjusts the power fan speeds for more efficient system operation. Configuration options: [Disabled] [Enabled]

PWR Fan Profile [Optimal]

Allows you to set the appropriate performance level of the power Q-Fan. Configuration options: [Optimal] [Silent Mode] [Performance Mode]

VCORE Voltage, 3.3V Voltage, 5V Voltage, 12V Voltage

The onboard hardware monitor automatically detects the voltage output through the onboard voltage regulators.

4.6 Boot menu

The Boot menu items allow you to change the system boot options. Select an item then press <Enter> to display the sub-menu.

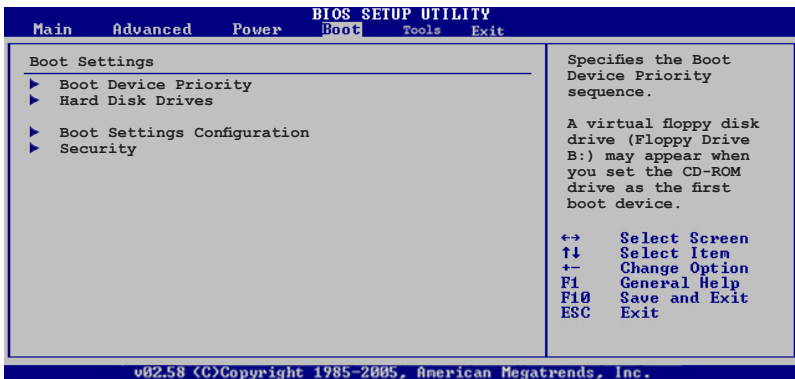

4.6.1 Boot Device Priority

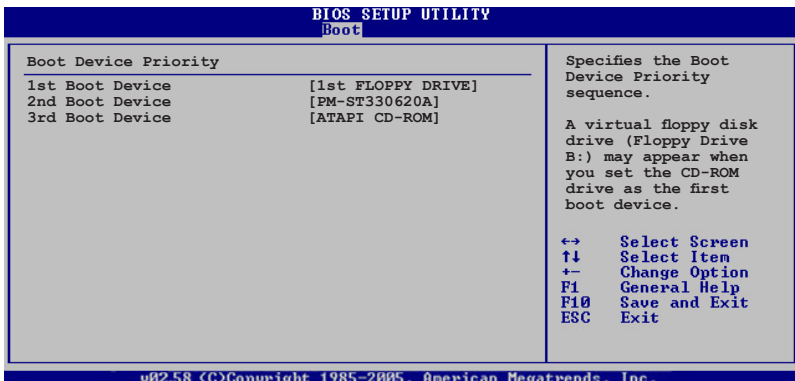

1st ~ xxth Boot Device [1st Floppy Drive]

These items specify the boot device priority sequence from the available devices. The number of device items that appears on the screen depends on the number of devices installed in the system. Configuration options: [xxxx Drive] [Disabled]

4.6.2 Hard Disk Drives

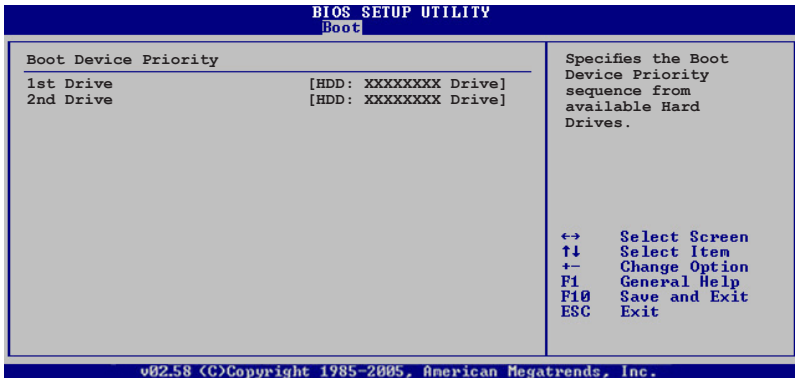

1st ~ xxth Drive [HDD: XXXXXXXX Drive]

These items specify the boot device priority sequence from the available hard disk drives. The number of device items that appears on the screen depends on the number of devices installed in the system. Configuration options: [xxxxx Drive] [Disabled]

4.6.3 Boot Settings Configuration

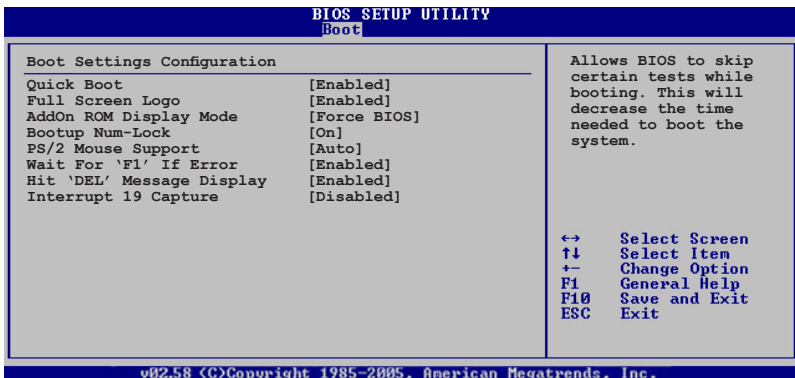

Quick Boot [Enabled]

Enabling this item allows the BIOS to skip some power on self tests (POST) while booting to decrease the time needed to boot the system. When set to [Disabled], BIOS performs all the POST items. Configuration options: [Disabled] [Enabled]

Full Screen Logo [Enabled]

Allows you to enable or disable the full screen logo display feature. Configuration options: [Disabled] [Enabled]



Set this item to [Enabled] to use the ASUS MyLogo 2 feature.

Add On ROM Display Mode [Force BIOS]

Sets the display mode for option ROM.
Configuration options: [Force BIOS] [Keep Current]

Bootup Num-Lock [On]

Allows you to select the power-on state for the NumLock.
Configuration options: [Off] [On]

PS/2 Mouse Support [Auto]

Allows you to enable or disable support for PS/2 mouse.
Configuration options: [Disabled] [Enabled] [Auto]

Wait for 'F1' If Error [Enabled]

When set to Enabled, the system waits for the F1 key to be pressed when error occurs. Configuration options: [Disabled] [Enabled]

Hit 'DEL' Message Display [Enabled]

When set to Enabled, the system displays the message "Press DEL to run Setup" during POST. Configuration options: [Disabled] [Enabled]

Interrupt 19 Capture [Disabled]

When set to [Enabled], this function allows the option ROMs to trap Interrupt 19.
Configuration options: [Disabled] [Enabled]

4.6.4 Security

The Security menu items allow you to change the system security settings. Select an item then press <Enter> to display the configuration options.

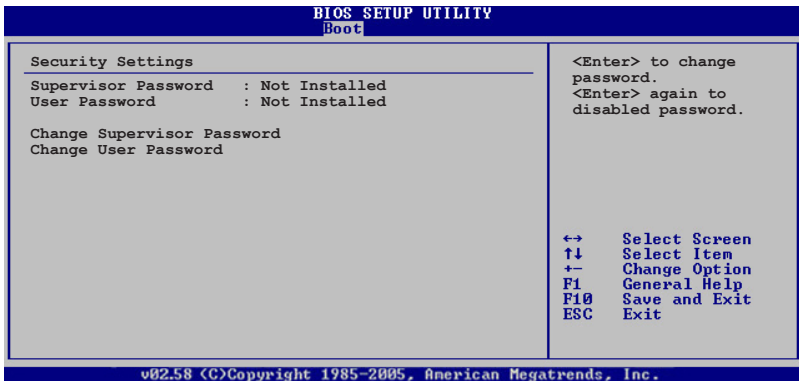

Change Supervisor Password

Select this item to set or change the supervisor password. The Supervisor Password item on top of the screen shows the default Not Installed. After you set a password, this item shows Installed.

To set a Supervisor Password:

1. Select the Change Supervisor Password item, then press <Enter>.
2. From the password box, type a password composed of at least six letters and/or numbers, then press <Enter>.
3. Confirm the password when prompted.

The message "Password Installed" appears after you successfully set your password.

To change the supervisor password, follow the same steps as in setting a user password.

To clear the supervisor password, select the Change Supervisor Password then press <Enter>. The message "Password Uninstalled" appears.



If you forget your BIOS password, you can clear it by erasing the CMOS Real Time Clock (RTC) RAM. See section "2.6 Jumpers" for information on how to erase the RTC RAM.

After you have set a supervisor password, the other items appear to allow you to change other security settings.

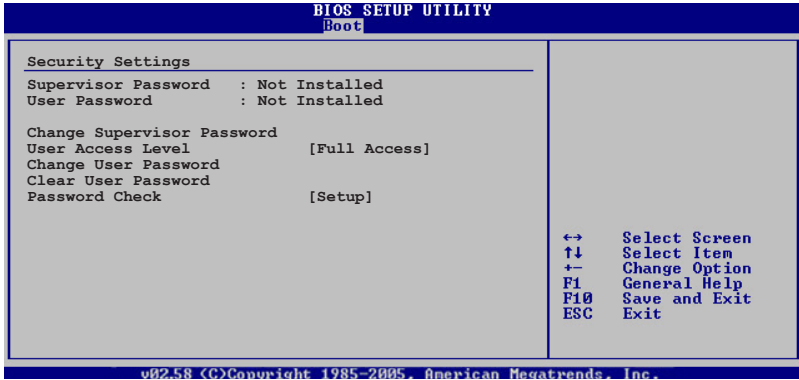

User Access Level [Full Access]

This item allows you to select the access restriction to the Setup items. Configuration options: [No Access] [View Only] [Limited] [Full Access]

No Access prevents user access to the Setup utility.

View Only allows access but does not allow change to any field.

Limited allows changes only to selected fields, such as Date and Time.

Full Access allows viewing and changing all the fields in the Setup utility.

Change User Password

Select this item to set or change the user password. The User Password item on top of the screen shows the default Not Installed. After you set a password, this item shows Installed.

To set a User Password:

1. Select the Change User Password item and press <Enter>.
2. On the password box that appears, type a password composed of at least six letters and/or numbers, then press <Enter>.
3. Confirm the password when prompted.

The message "Password Installed" appears after you set your password successfully.

To change the user password, follow the same steps as in setting a user password.

Clear User Password

Select this item to clear the user password.

Password Check [Setup]

When set to [Setup], BIOS checks for user password when accessing the Setup utility. When set to [Always], BIOS checks for user password both when accessing Setup and booting the system. Configuration options: [Setup] [Always]

4.7 Tools menu

The Exit menu items allow you to load the optimal or failsafe default values for the BIOS items, and save or discard your changes to the BIOS items.

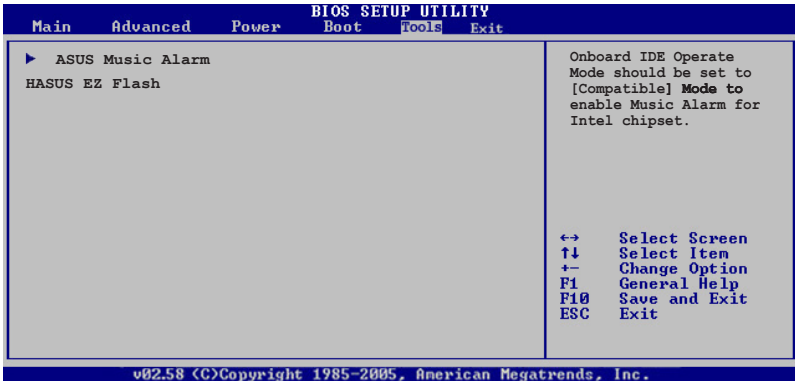

4.7.1 ASUS Music Alarm

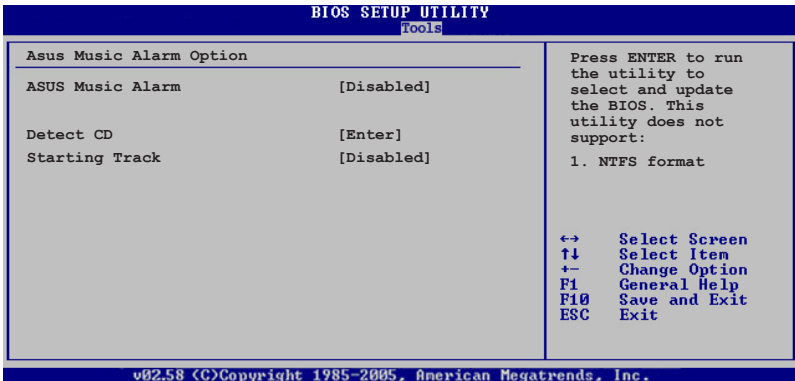

ASUS Music Alarm [Disabled]

Allows you to enable or disable the ASUS Music Alarm function.

Configuration options: [Disabled] [Enabled]



The succeeding items become user-configurable when you enable the ASUS Music Alarm.

Alarm Day: Sunday/Monday/Tuesday/Wednesday/Thursday/Friday/Saturday [Enabled]

Allows you to enable or disable the alarm for a particular day.

Configuration options: [Disabled] [Enabled]

Alarm Time (hh:mm) 0 : 0

Allows you to set the alarm time. Press <Tab> to select the field, then use <+> or <-> to change the value.

Audio CD Device [Primary IDE Slave]

Allows you to select the connection configuration of the optical storage device from which the alarm music will play from. Configuration options: [Primary IDE Master] [Primary IDE Slave]

Detect CD

Press <Enter> to search the CD track number.

Starting Track

Allows you to choose the starting track from the CD from which you would like the alarm music to play.

Repeat Track [Disabled]

Allows you to enable or disable the repeat track function.

Configuration options: [Disabled] [Single] [All]

Duration [10 Mins]

Allows you to set the length of the music alarm.

Configuration options: [10 Mins] [20 Mins] [30 Mins] [1 Hour]

Volume [16]

Allows you to set the volume level of the music alarm.

Configuration options: [01] ~ [32]



- Only the IDE ATAPI devices from South bridge can support this function.
- The system needs standby power, so ensure that the power cord is plugged.
- You can also set the alarm time under operating system using ASUS Music Alarm Utility. See section 5.3.6 for details.
- ASUS Music Alarm only supports audio CDs.

4.7.2 ASUS EZ Flash 2

Allows you to run ASUS EZ Flash 2. When you press <Enter>, a confirmation message appears. Use the left/right arrow key to select between [Ok] or [Cancel], then press <Enter> to confirm your choice.

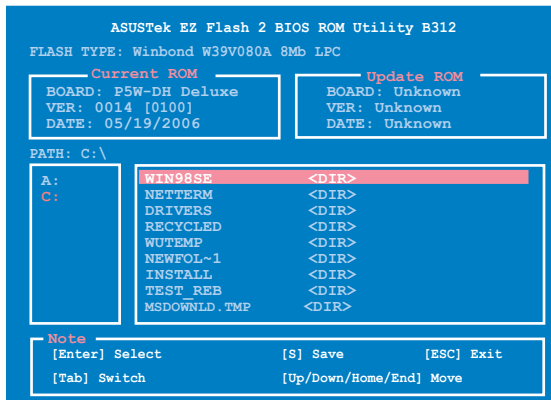

4.8 Exit menu

The Exit menu items allow you to load the optimal or failsafe default values for the BIOS items, and save or discard your changes to the BIOS items.

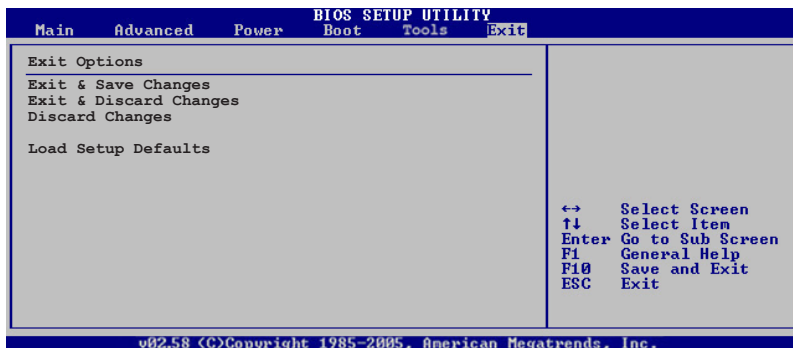

Pressing <Esc> does not immediately exit this menu. Select one of the options from this menu or <F10> from the legend bar to exit.

Exit & Save Changes

Once you are finished making your selections, choose this option from the Exit menu to ensure the values you selected are saved to the CMOS RAM. An onboard backup battery sustains the CMOS RAM so it stays on even when the computer is turned off. When you select this option, a confirmation window appears. Select **OK** to save the changes and exit.



If you attempt to exit the Setup program without saving your changes, the program prompts you with a message asking if you want to save your changes before exiting. Press <Enter> to save the changes while exiting.

Exit & Discard Changes

Select this option only if you do not want to save the changes that you made to the Setup program. If you made changes to fields other than System Date, System Time, and Password, the BIOS asks for a confirmation before exiting.

Discard Changes

Allows you to discard the selections you made and restore the previously saved values. After selecting this option, a confirmation appears. Select **OK** to discard any changes and load the previously saved values.

Load Setup Defaults

Allows you to load the default values for each of the parameters on the Setup menus. When you select this option or if you press <F5>, a confirmation window appears. Select **OK** to load default values. Select **Exit & Save Changes** or make other changes before saving the values to the non-volatile RAM.

This chapter describes the contents of the support CD that comes with the motherboard package.

5 Software support

- 5.1 Installing an operating system 5-1**
- 5.2 Support CD information 5-1**
- 5.3 Software information 5-10**
- 5.4 RAID configurations 5-29**
- 5.5 Creating a RAID driver disk..... 5-64**

5.1 Installing an operating system

This motherboard supports Windows® 2000/2003 Server/XP operating systems (OS). Always install the latest OS version and corresponding updates to maximize the features of your hardware.



- Motherboard settings and hardware options vary. Use the setup procedures presented in this chapter for reference only. Refer to your OS documentation for detailed information.
- Make sure that you install Windows® 2000 Service Pack 4 or the Windows® XP Service Pack 1 or later versions before installing the drivers for better compatibility and system stability.

5.2 Support CD information

The support CD that came with the motherboard package contains the drivers, software applications, and utilities that you can install to avail all motherboard features.



The contents of the support CD are subject to change at any time without notice. Visit the ASUS website (www.asus.com) for updates.

5.2.1 Running the support CD

Place the support CD to the optical drive. The CD automatically displays the Drivers menu if Autorun is enabled in your computer.

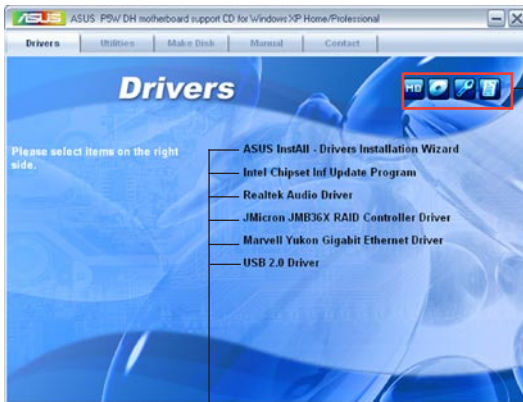

Click an icon to display support CD/motherboard information

Click an item to install



If Autorun is NOT enabled in your computer, browse the contents of the support CD to locate the file ASSETUP.EXE from the BIN folder. Double-click the ASSETUP.EXE to run the CD.

5.2.2 Drivers menu

The drivers menu shows the available device drivers if the system detects installed devices. Install the necessary drivers to activate the devices.



ASUS InstAll -Drivers Installation Wizard

Launches the ASUS InstallAll driver installation wizard.

Intel Chipset Inf Update Program

Installs the Intel® Chipset INF Update Program. This driver enables Plug-n-Play INF support for the Intel® chipset components on the motherboard. When installed to the target system, this driver provides the method for configuring the chipset components.

You can install this utility using three different modes: interactive, silent or unattended preload. Installing the driver in interactive mode requires user input during installation. User input is not required when installing the driver in silent or unattended preload modes. Refer to the online help or readme file that came with the utility for details.

Realtek Audio Driver

Installs the Realtek® ALC882M audio driver and application. See section “5.3.3 Audio configurations” for details.

JMicron JMB36X RAID Controller Driver

Installs the JMicron® JMB363 RAID controller driver.

Marvell Yukon Gigabit Ethernet Driver

Installs the Marvell Yukon Gigabit Ethernet LAN driver.

USB 2.0 Driver

Installs the USB 2.0 driver.

5.2.3 Utilities menu

The Utilities menu displays the software applications and utilities that the motherboard supports. Click on an item to install.

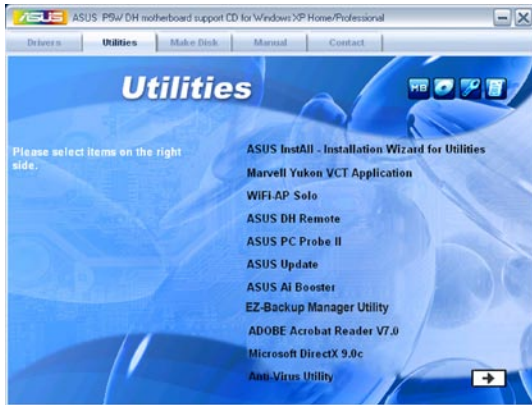

ASUS InstAll - Installation Wizard for Utilities

Launches the ASUS InstallAll utilities installation wizard.

Marvell Yukon VCT Application

Installs the Marvell® Yukon Virtual Cable Tester™ (VCT) application that diagnoses and reports LAN cable faults and shorts using the Time Domain Reflectometry (TDR) technology.

WiFi-AP Solo

Installs the WiFi-AP Solo™ utility, which allows a new level of versatility for your PC, enabling it to create a complete wireless home network in either AP or wireless client mode.

ASUS DH Remote

Installs the utility for the ASUS DH Remote, a handy remote controller that lets you operate key PC functions from a distance. Power on, adjust fan speed according to CPU loading for low noise and high power savings, and even control the media player with the one touch convenience.

ASUS PC Probe II

This smart utility monitors the fan speed, CPU temperature, and system voltages, and alerts you of any detected problems. This utility helps you keep your computer in healthy operating condition.

ASUS Update

The ASUS Update utility that allows you to update the motherboard BIOS in Windows® environment. This utility requires an Internet connection either through a network or an Internet Service Provider (ISP). See page 4-8 for details.

ASUS Ai Booster

The ASUS Ai Booster application allows you to overclock the CPU speed in Windows® environment.

Ez-Backup Manager Utility

Installs the EzRaid Manager Utility for EZ Backup, which allows you to mirror your data instantaneously. EZ Backup leverages the Serial ATA 2 3.0/1.5 Gb/s technology to deliver handy plug-and-play RAID without requiring any configuration or setup. Choose from either the default RAID 1 configuration, or RAID 0 setting. See section “5.4.4 Silicon Image RAID configuration” for more information.

ADOBE Acrobat Reader

The Adobe Acrobat® Reader V7.0 is for opening, viewing, and printing documents in Portable Document Format (PDF).

Microsoft DirectX 9.0c

The Microsoft DirectX® 9.0c is a multimedia technology that enhances computer graphics and sounds. DirectX® improves the multimedia features of your computer so you can enjoy watching TV and movies, capturing videos, or playing games in your computer.

Anti-virus Utility

The anti-virus utility scans, identifies, and removes computer viruses. View the online help for detailed information.



Click  to open the next screen.

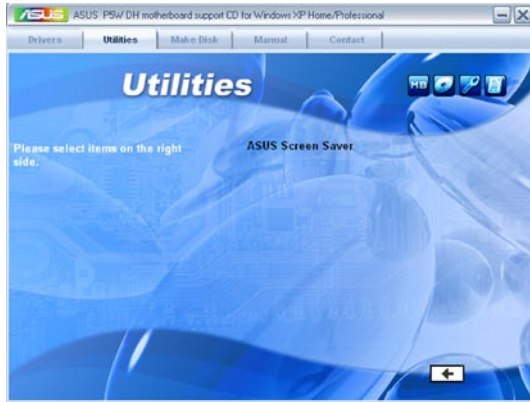

Click  to view the previous screen.

ASUS Screen Saver

Bring life to your idle screen by installing the ASUS screen saver.

5.2.4 Make Disk menu

The Make Disk menu allows you to make RAID/Serial ATA driver disks for Intel ICH7R and JMicron software RAID.



Intel ICH7R 32 bit RAID Driver Disk

Intel ICH7R 64 bit RAID Driver Disk

Allows you to create an Intel® ICH7R RAID driver disk for a 32/64-bit system.

Make JMicron JMB36X 32/64-bit RAID Driver

Allows you to create a JMicron JMB363 RAID driver disk for a 32/64-bit system.

5.2.5 Manual menu

The Manual menu contains the user manuals for third party components and applications.

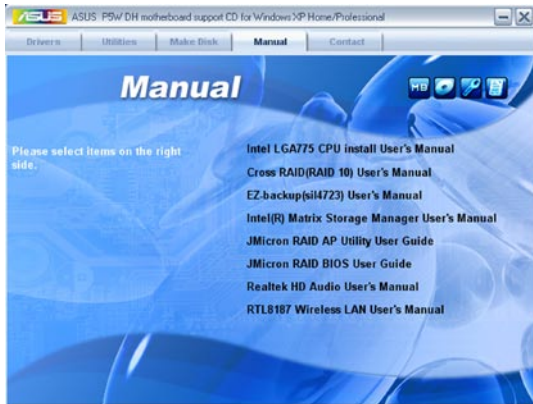

- Most user manual files are in Portable Document Format (PDF). Install the Adobe Acrobat Reader application from the Utilities tab before opening a user manual file.
- The contents of the support CD are subject to change at any time without notice. Visit the ASUS website (www.asus.com) for updates.

5.2.6 Contact information

Click the Contact tab to display the ASUS contact information. You can also find this information on the inside front cover of this user guide.

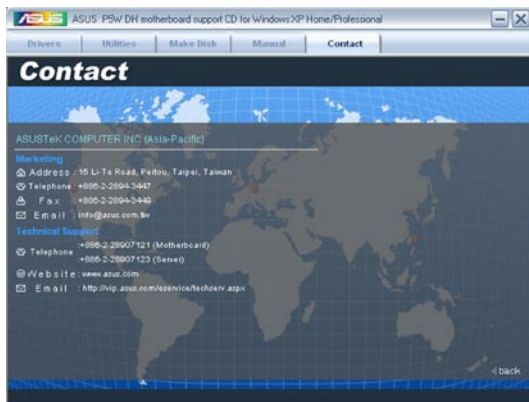

5.2.7 Other information

The icons on the top right corner of the screen provide additional information on the motherboard and the contents of the support CD. Click an icon to display the specified information.

Motherboard Info

Displays the general specifications of the motherboard.



Browse this CD

Displays the contents of the support CD in graphical format.

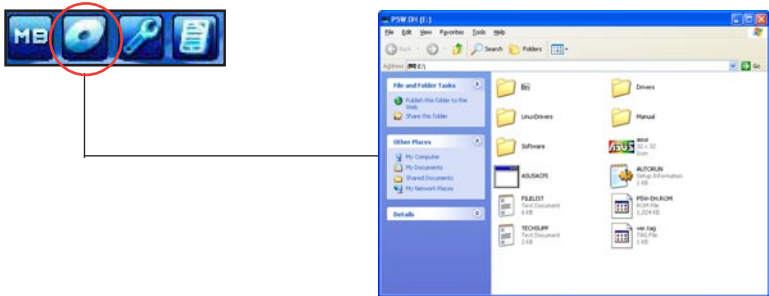

5.3 Software information

Most of the applications in the support CD have wizards that will conveniently guide you through the installation. View the online help or readme file that came with the software application for more information.

5.3.1 ASUS MyLogo 2

The ASUS MyLogo 2 utility lets you customize the boot logo. The boot logo is the image that appears on screen during the Power-On-Self-Tests (POST). The ASUS MyLogo3™ is automatically installed when you install the ASUS Update utility from the support CD. See section “5.2.3 Utilities menu” for details.



- Before using the ASUS MyLogo 2, use the AFUDOS utility to make a copy of your original BIOS file, or obtain the latest BIOS version from the ASUS website. See section “4.1.2 AFUDOS utility.”
- Make sure that the BIOS item Full Screen Logo is set to [Enabled] if you wish to use ASUS MyLogo3. See section “4.6.2 Boot Settings Configuration.”
- You can create your own boot logo image in BMP file format.
- The file size should be smaller than 150 K.

To launch the ASUS MyLogo 2:

1. Launch the ASUS Update utility. Refer to section “4.1.5 ASUS Update utility” for details.
2. Select Options from the drop down menu, then click Next.
3. Check the option Launch MyLogo to replace system boot logo before flashing BIOS, then click Next.
4. Select Update BIOS from a file from the drop down menu, then click Next.
5. When prompted, locate the new BIOS file, then click Next. The ASUS MyLogo 2 window appears.
6. From the left window pane, select the folder that contains the image you intend to use as your boot logo.



- When the logo images appear on the right window pane, select an image to enlarge by clicking on it.



- Adjust the boot image to your desired size by selecting a value on the Ratio box.



- When the screen returns to the ASUS Update utility, flash the original BIOS to load the new boot logo.
- After flashing the BIOS, restart the computer to display the new boot logo during POST.

5.3.2 AI NET2

The AI NET2 features the Marvell® Virtual Cable Tester™ (VCT). VCT is a cable diagnostic utility that reports LAN cable faults and shorts using the Time Domain Reflectometry (TDR) technology. The VCT detects and reports open and shorted cables, impedance mismatches, pair swaps, pair polarity problems, and pair skew problems of up to 64 ns at one meter accuracy.

The VCT feature reduces networking and support costs through a highly manageable and controlled network system. This utility can be incorporated in the network systems software for ideal field support as well as development diagnostics.

Using the Virtual Cable Tester™

To use the the Marvell® Virtual Cable Tester™ utility:

1. Launch the VCT utility from the Windows® desktop by clicking Start > All Programs > Marvell > Virtual Cable Tester.
2. Click Virtual Cable Tester from the menu to display the screen below.

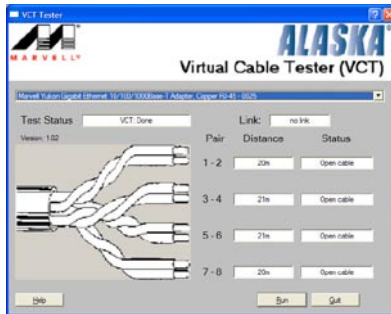

3. Click the Run button to perform a cable test.



- The VCT only runs on systems with Windows® XP or Windows® 2000 operating systems.
- The VCT utility only tests Ethernet cables connected to Gigabit LAN port(s).
- The Run button on the Virtual Cable Tester™ main window is disabled if no problem is detected on the LAN cable(s) connected to the LAN port(s).
- If you want the system to check the status of the LAN cable before entering the OS, enable the item Post Check LAN Cable in the BIOS Setup.

5.3.3 Audio configurations

The Realtek® ALC882M audio CODEC provides 8-channel audio capability to deliver the ultimate audio experience on your computer. The software provides Jack-Sensing function, S/PDIF Out support, and interrupt capability. The ALC882M also includes the Realtek® proprietary UAJ® (Universal Audio Jack) technology for all audio ports, eliminating cable connection errors and giving users plug and play convenience.

Follow the installation wizard to install the Realtek® Audio Driver from the support CD that came with the motherboard package.

If the Realtek audio software is correctly installed, you will find the Realtek HD Audio Manager icon on the taskbar.

From the taskbar, double-click on the SoundEffect icon to display the Realtek HD Audio Manager.



Realtek HD Audio Manager

Realtek HD Audio Manager

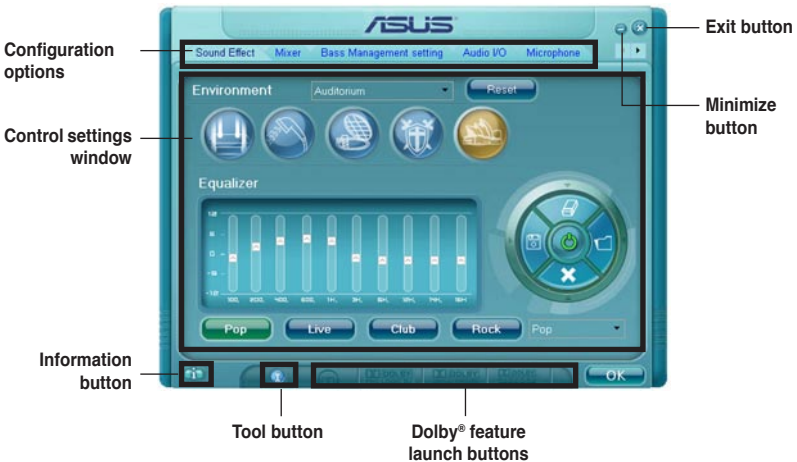

Information

Click the information button () to display information about the audio driver version, DirectX version, audio controller, audio codec, and language setting.



Tools

Click the tool button () to display tools for supported Dolby® applications.

Dolby® feature launch buttons

Click the button of the feature you want to launch.



Minimize

Click the minimize button () to minimize the window.

Exit

Click the exit button () to exit the Realtek HD Audio Manager.

Configuration options

Click any of the tabs in this area to configure your audio settings. Click the arrow button () to display more options.

Sound Effect

The Realtek® ALC882M Audio CODEC allows you to set your listening environment, adjust the equalizer, set the karaoke, or select pre-programmed equalizer settings for your listening pleasure.

To set the sound effect options:

1. From the Realtek HD Audio Manager, click the Sound Effect tab.
2. Click the shortcut buttons or the drop-down menus for options on changing the acoustic environment or adjust the equalizer to your desired settings.
3. Click  to effect the Sound Effect settings and exit.



Mixer

The Mixer option allows you to configure audio output (playback) volume and audio input (record) volume.

To set the mixer options:

1. From the Realtek HD Audio Manager, click the Mixer tab.
2. Turn the volume buttons to adjust the Playback and/or Record volume.





The Mixer option activates voice input from all channels by default. Make sure to set those channels to mute () if you do not want voice input.

3. Make adjustments to Wave, SW Synth, Front, Rear, Subwoofer, CD volume, Mic volume, Line Volume, and Stereo mix by clicking the control tabs and dragging them up and down until you get the desired levels.
4. Click  to effect the Mixer settings and exit.

Bass Management setting

Click this tab to manage your bass settings.

To set the bass management options:

1. From the Realtek HD Audio Manager, click the Bass Management setting tab.
2. Click <M> to display the distance in meters, or <FT> to display the distance in feet.
3. Adjust the values to your desired settings by entering a numeric value in the boxes, or clicking the up/down arrow.
4. Click  to test your settings.
5. Click  to effect the Bass Management settings and exit.



Audio I/O

The Audio I/O option allows you configure your input/output settings.

To set the Audio I/O options:

1. From the Realtek HD Audio Manager, click the Audio I/O tab.
2. Click the drop-down menu to select the channel configuration.
3. The control settings window displays the status of connected devices. Click  for analog and digital options.
4. Click <OK> to effect the Audio I/O settings and exit



Microphone

The Microphone option allows you to configure your input/output settings and to check if your audio devices are connected properly.

To set the Microphone options:

1. From the Realtek HD Audio Manager, click the Microphone tab.
2. Click the Noise Suppression option button to reduce the static background noise when recording.
3. Click the Acoustic Echo Cancellation option button to reduce the echo from the front speakers when recording.
4. Click  to effect the Microphone settings and exit.



3D Audio Demo

The 3D Audio Demo option gives you a demonstration of the 3D audio feature.

To start the 3D Audio Demo:

1. From the Realtek HD Audio Manager, click the 3D Audio Demo tab.
2. Click the option buttons to change the sound, moving path, or environment settings.
3. Click  to test your settings.
4. Click  to effect the 3D Audio Demo settings and exit.



Designed for Dolby® Master Studio

Dolby® Master Studio combines advanced audio technologies to bring you the highest-quality in audio entertainment. Enjoy true home theatre experience with the following advanced sound technologies: Dolby Prologic IIx, Dolby Headphone, Dolby Virtual Speaker, and Dolby Digital Live.

Dolby® Headphone: Allows you to wear any pair of headphones and listen to music with the dramatic surround effects of a 5.1-channel audio configuration.

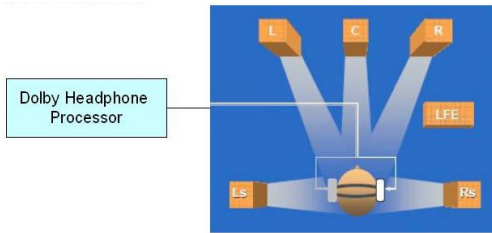

Dolby® Pro Logic IIx: expands any stereo audio or 5.1-channel audio for a 6.1 or 7.1-channel playback, creating a seamless, natural surround soundfield that immerses you in the entertainment experience.

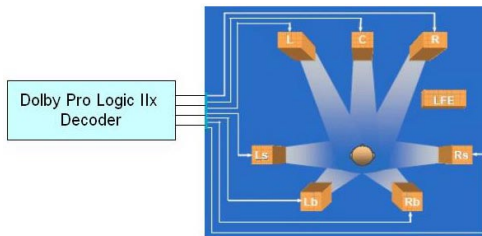

Dolby® Virtual Speaker: Simulates a highly realistic 5.1-speaker surround sound listening environment using only two speakers.

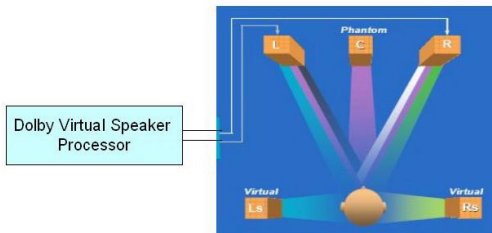

Using Dolby® Digital Live™

The Dolby® Digital Live™ technology encodes your computer's digital audio contents to real-time Dolby® Digital streams. Using the CODEC and the Sony/Philips Digital Interface (S/PDIF) ports on the motherboard, you can send the encoded Dolby® Digital streams to an AC-3 decoder for playback on a multi-channel speaker system.

Refer to the following illustrations when converting sounds to Dolby® Digital streams.

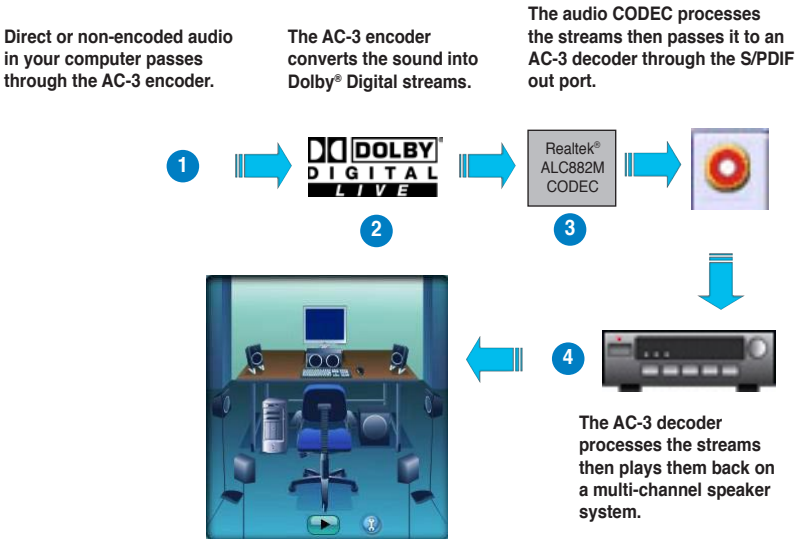

To enable the Dolby® Digital Live™:

1. Connect an AC-3 decoder to the coaxial/optical S/PDIF out port.
2. Connect the AC-3 decoder to the multi-channel speaker system.
3. Launch the Realtek HD Audio Manager by double clicking the Realtek HD Audio Manager icon on the Windows® taskbar.
4. Click the Dolby Digital Live button. You can now convert your computer's audio content to Dolby® Digital streams.



5.3.4 ASUS PC Probe II

PC Probe II is a utility that monitors the computer's vital components, and detects and alerts you of any problem with these components. PC Probe II senses fan rotations, CPU temperature, and system voltages, among others. Because PC Probe II is software-based, you can start monitoring your computer the moment you turn it on. With this utility, you are assured that your computer is always at a healthy operating condition.

Installing PC Probe II

To install PC Probe II on your computer:

1. Place the support CD to the optical drive. The Drivers installation tab appears if your computer has an enabled Autorun feature.



If Autorun is not enabled in your computer, browse the contents of the support CD to locate the setup.exe file from the ASUS PC Probe II folder. Double-click the setup.exe file to start installation.

2. Click the Utilities tab, then click ASUS PC Probe II.
3. Follow the screen instructions to complete installation.

Launching PC Probe II

You can launch the PC Probe II right after installation or anytime from the Windows® desktop.

To launch the PC Probe II from the Windows® desktop, click Start > All Programs > ASUS > PC Probe II > PC Probe II v1.00.43. The PC Probe II main window appears.

After launching the application, the PC Probe II icon appears in the Windows® taskbar. Click this icon to close or restore the application.







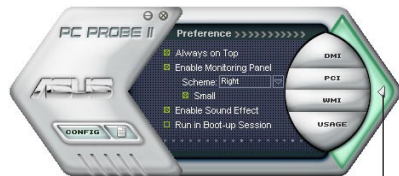

Using PC Probe II

Main window

The PC Probe II main window allows you to view the current status of your system and change the utility configuration. By default, the main window displays the Preference section. You can close or restore the Preference section by clicking on the triangle on the main window right handle.



Click to close the Preference panel

Button	Function
	Opens the Configuration window
	Opens the Report window
	Opens the Desktop Management Interface window
	Opens the Peripheral Component Interconnect window
	Opens the Windows Management Instrumentation window
	Opens the hard disk drive, memory, CPU usage window
	Shows/Hides the Preference section
	Minimizes the application
	Closes the application

Sensor alert

When a system sensor detects a problem, the main window right handle turns red, as the illustrations below show.

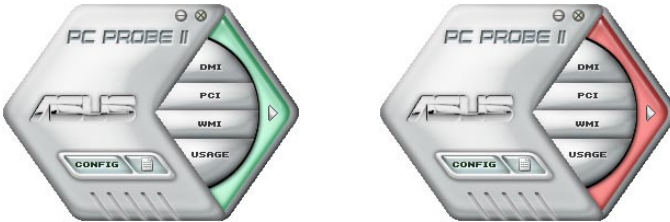

When displayed, the monitor panel for that sensor also turns red. Refer to the Monitor panels section for details.

Preferences

You can customize the application using the Preference section in the main window. Click the box before each preference to activate or deactivate.

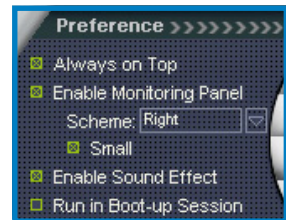

Hardware monitor panels

The hardware monitor panels display the current value of a system sensor such as fan rotation, CPU temperature, and voltages.

The hardware monitor panels come in two display modes: hexagonal (large) and rectangular (small). When you check the Enable Monitoring Panel option from the Preference section, the monitor panels appear on your computer's desktop.



Large display



Small display

Changing the monitor panels position

To change the position of the monitor panels in the desktop, click the arrow down button of the Scheme options, then select another position from the list box. Click OK when finished.

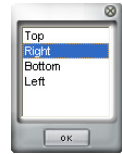

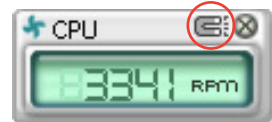

Moving the monitor panels

All monitor panels move together using a magnetic effect. If you want to detach a monitor panel from the group, click the horseshoe magnet icon. You can now move or reposition the panel independently.



Adjusting the sensor threshold value

You can adjust the sensor threshold value in the monitor panel by clicking the  or  buttons. You can also adjust the threshold values using the Config window.

You cannot adjust the sensor threshold values in a small monitoring panel.

Click to increase value

Click to decrease value



Monitoring sensor alert

The monitor panel turns red when a component value exceeds or is lower than the threshold value. Refer to the illustrations below.



Large display

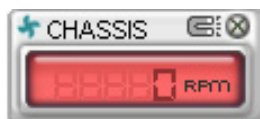

Small display

WMI browser

Click **WMI** to display the WMI (Windows Management Instrumentation) browser. This browser displays various Windows® management information. Click an item from the left panel to display on the right panel. Click the plus sign (+) before WMI Information to display the available information.

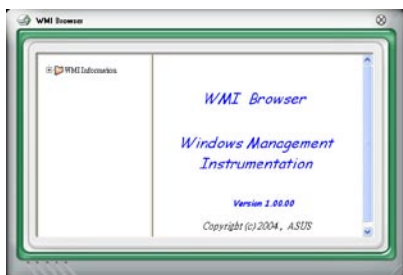

You can enlarge or reduce the browser size by dragging the bottom right corner of the browser.

DMI browser

Click **DMI** to display the DMI (Desktop Management Interface) browser. This browser displays various desktop and system information. Click the plus sign (+) before DMI Information to display the available information.



PCI browser

Click **PCI** to display the PCI (Peripheral Component Interconnect) browser. This browser provides information on the PCI devices installed on your system. Click the plus sign (+) before the PCI Information item to display available information.

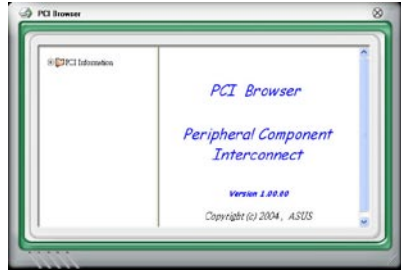

Usage

The Usage browser displays real-time information on the CPU, hard disk drive space, and memory usage. Click **USAGE** to display the Usage browser.

CPU usage

The CPU tab displays real-time CPU usage in line graph representation. If the CPU has an enabled Hyper-Threading, two separate line graphs display the operation of the two logical processors.

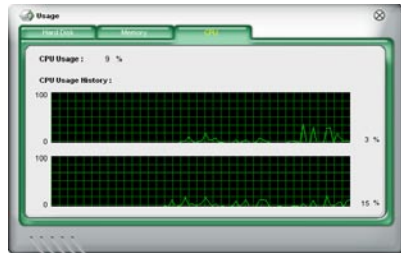

Hard disk drive space usage

The Hard Disk tab displays the used and available hard disk drive space. The left panel of the tab lists all logical drives. Click a hard disk drive to display the information on the right panel. The pie chart at the bottom of the window represents the used (blue) and the available HDD space.



Memory usage

The Memory tab shows both used and available physical memory. The pie chart at the bottom of the window represents the used (blue) and the available physical memory.

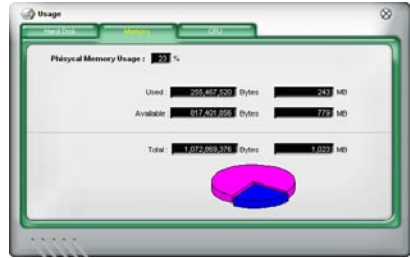

Configuring PC Probe II

Click **CONFIG** to view and adjust the sensor threshold values.

The Config window has two tabs: Sensor/Threshold and Preference. The Sensor/Threshold tab enables you to activate the sensors or to adjust the sensor threshold values. The Preference tab allows you to customize sensor alerts, or change the temperature scale.

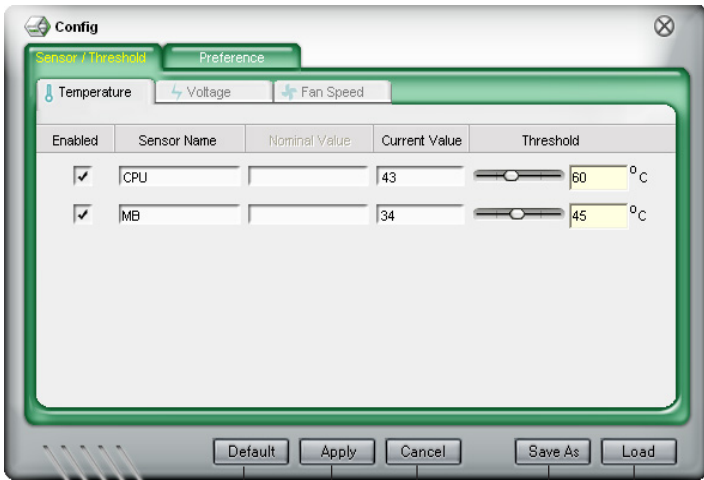

Loads the default threshold values for each sensor

Applies your changes

Cancels or ignores your changes

Loads your saved configuration
Saves your configuration

5.3.5 ASUS Music Alarm

This motherboard is equipped with an audio alarm clock called ASUS Music Alarm. The ASUS Music Alarm gives you a personal wake-up called with your favorite CD music when the system is off. The onboard audio CODEC supports this feature, which requires an optical drive (CD-ROM, CD-RW, or DVD-ROM).



-
- Make sure that the power cord is plugged to a grounded power source so that the system has standby power.
 - ASUS Music Alarm only supports audio CDs.
 - ASUS Music Alarm will not work if you installed and enabled an add-on sound card.
 - Only IDE ATAPI devices from the Southbridge support this feature.
-

Hardware setup

To set up the hardware:

1. Connect the analog audio cable from the optical drive to the 4-pin CD-In connector labeled CD on the motherboard. See section “2.7.2 Internal connectors” for the connector location.
2. Connect speakers or a headphone to the Line-Out (lime-colored) port on the front or rear panel for audio output. You may also connect speakers or a headphone to the output jack on the optical drive.
3. Refer to the succeeding sections to make the appropriate settings in the BIOS or in Windows®.

BIOS configuration

To enable ASUS Music Alarm in the BIOS:

1. Turn on the system.
2. During POST, press to enter BIOS setup.
3. Go to the **Tools** menu, then select **ASUS Music Alarm**.
4. Set the **ASUS Music Alarm** item to [Enabled]. See section “4.7.1 ASUS Music Alarm” for details.

OS configuration

To configure ASUS Music Alarm in Windows®

1. Place the support CD into the optical drive.
2. Click the **Utilities** tab and choose **ASUS Music Alarm** to install the utility.
3. Insert an audio CD into the optical drive.
4. Launch the ASUS Music Alarm application by going to **Start > ASUS > ASUS Music Alarm**. The main window appears.

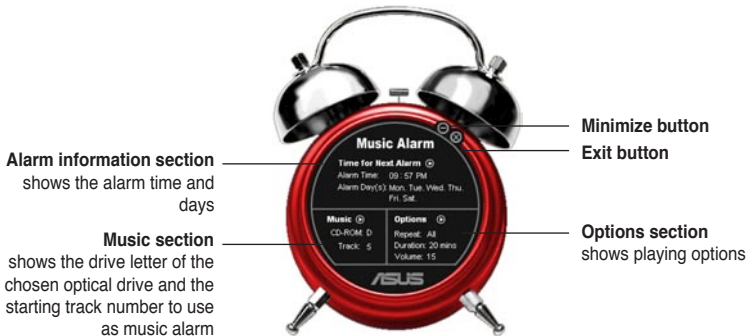

5. Click the arrow (▶) next to **Time for Next Alarm** in the Alarm information section. The Alarm Time Setting panel appears. Set the days and time of the alarm, or enable/disable the Music Alarm feature.

When done, click **OK**.



6. Click the arrow (▶) next to **Music** in the Music section. The Music Selection panel appears. Select the optical storage device, then choose the starting CD track number from which you would like the music alarm to play.

When done, click **OK**.



7. Click the arrow (▶) next to **Options** in the Options section. The Options panel appears. Disable or select the Repeat mode, then specify the length of the alarm music to play. Set the desired volume.

When done, click **OK**.



8. After you have finished making all the required settings, turn off the system.

Adjusting the volume

To adjust the volume while the music alarm is playing:

- Use the <Up> or <Down> arrow key to increase or decrease the volume.

Turning off the music alarm

To turn off the music alarm:

- Press any key to stop playing the CD and turn off the system.



-
- While the music alarm is playing, the system wake-up features (LAN, keyboard, mouse, PCI/PCIE device, modem) are deactivated.
 - If the system loses connection or if it does not detect any optical drive or audio CD, the ASUS Music Alarm is automatically disabled/turned off.
 - While the music alarm is playing, the optical drive front panel functions are automatically disabled.
 - The ASUS Music Alarm works only when the system is off.
-

5.4 RAID configurations

The motherboard comes with four Serial ATA RAID solutions:

- **ASUS EZ-Backup.** Enabled by Silicon Image's Sil4723 controller, ASUS EZ-Backup provides ready-to-go hardware RAID for plug-and play RAID 1 and easy-to-configure RAID 0 sets of two hard disk drives
- **Intel® ICH7R Southbridge RAID** provides RAID level 5 support for three or more hard disk drives.
- **Cross-RAID** allows you to build a RAID 10 set through a cross-configuration of ASUS EZ-Backup and Intel® ICH7R.
- **JMicron® RAID.** Enabled by JMicron® JMB363 controller, JMicron® RAID extends the advantages of software RAID beyond internal hard disk drives to an external disk or external, port-multiplier enabled enclosure

While individually the RAID implementations offer advantages for specific applications, as a whole, this set of tools provides ultimate flexibility for every environment.

Refer to the following RAID definitions for details.

RAID 0 (Data striping) optimizes two identical hard disk drives to read and write data in parallel, interleaved stacks. Two hard disks perform the same work as a single drive but at a sustained data transfer rate, double that of a single disk alone, thus improving data access and storage. Use of two new identical hard disk drives is required for this setup.

RAID 1 (Data mirroring) copies and maintains an identical image of data from one drive to a second drive. If one drive fails, the disk array management software directs all applications to the surviving drive as it contains a complete copy of the data in the other drive. This RAID configuration provides data protection and increases fault tolerance to the entire system. Use two new drives or use an existing drive and a new drive for this setup. The new drive must be of the same size or larger than the existing drive.

RAID 5 stripes both data and parity information across three or more hard disk drives. Among the advantages of RAID 5 configuration include better HDD performance, fault tolerance, and higher storage capacity. The RAID 5 configuration is best suited for transaction processing, relational database applications, enterprise resource planning, and other business systems. Use a minimum of three identical hard disk drives for this setup.

RAID 10* is data striping and data mirroring combined without parity (redundancy data) having to be calculated and written. With the RAID 10* configuration you get all the benefits of both RAID 0 and RAID 1 configurations. Use four new hard disk drives or use an existing drive and three new drives for this setup.



*To build a RAID 10 set, you need to cross-configure Intel® ICH7R with Silicon Image®, which controls the EZ_RAID connectors for the EZ Backup feature. See section "5.4.5 Cross-RAID configuration" for details.

Intel® Matrix Storage. The Intel® Matrix Storage technology supported by the ICH7R chip allows you to create a RAID 0, RAID 1, RAID 5, and RAID 10* function to improve both system performance and data safety. You can also combine two RAID sets to get higher performance, capacity, or fault tolerance provided by the difference RAID function. For example, RAID 0 and RAID 1 set can be created by using only two identical hard disk drives.



If you want to boot the system from a hard disk drive included in a created RAID set, copy first the RAID driver from the support CD to a floppy disk before you install an operating system to the selected hard disk drive. Refer to section “5.6 Creating a RAID driver disk” for details.

5.4.1 Installing Serial ATA hard disks

The motherboard supports Serial ATA hard disk drives. For optimal performance, install identical drives of the same model and capacity when creating a disk array.

To install the SATA hard disks for a RAID configuration:

1. Install the SATA hard disks into the drive bays.
2. Connect the SATA signal cables.
3. Connect a SATA power cable to the power connector on each drive.

5.4.2 Intel® RAID configurations

This motherboard supports RAID 0, RAID 1, RAID 5, RAID 10* (0+1) and Intel® Matrix Storage configurations for Serial ATA hard disks drives through the Intel® ICH7R Southbridge chip.



*To build a RAID 10 set, you need to cross-configure Intel® ICH7R with Silicon Image®, which controls the EZ_RAID connectors for the EZ Backup feature. See section “5.4.5 Cross-RAID configuration” for details.

Setting the RAID item in BIOS

You must set the RAID item in the BIOS Setup before you can create a RAID set(s). To do this:

1. Enter the BIOS Setup during POST.
2. Go to the Main Menu, select IDE Configuration, then press <Enter>.
3. Select the item Configure SATA As, then press <Enter> to display the configuration options.
4. Select RAID from the Configure SATA As item options, then press <Enter>.
5. Select the item Onboard Serial-ATA BOOTROM, press <Enter>, then select Enabled from the options.
6. Save your changes, then exit the BIOS Setup.



See Chapter 4 for details on entering and navigating through the BIOS Setup.

Intel® Matrix Storage Manager Option ROM Utility

The Intel® Matrix Storage Manager Option ROM utility allows you to create RAID 0, RAID 1, RAID 10 (RAID 0+1), and RAID 5 set(s) from Serial ATA hard disk drives that are connected to the Serial ATA connectors supported by the Southbridge.

To enter the Intel® Matrix Storage Manager Option ROM utility:

1. Install all the Serial ATA hard disk drives.
2. Turn on the system.
3. During POST, press <Ctrl+I> to display the utility main menu.

```
Intel(R) Matrix Storage Manager Option ROM v5.0.0.1032 ICH7R wRAID5
Copyright (C) 2003-05 Intel Corporation. All Rights Reserved.

----- [ MAIN MENU ] -----
1. Create RAID Volume
2. Delete RAID Volume
3. Reset Disks to Non-RAID
4. Exit

----- [ DISK/VOLUME INFORMATION ] -----

RAID Volumes:
None defined.

Physical Disks:
Port Drive Model          Serial #          Size      Type/Status (Vol ID)
0  XXXXXXXXXXXX          XXXXXXXX        XX.XXGB  Non-RAID Disk
1  XXXXXXXXXXXX          XXXXXXXX        XX.XXGB  Non-RAID Disk
2  XXXXXXXXXXXX          XXXXXXXX        XX.XXGB  Non-RAID Disk
3  XXXXXXXXXXXX          XXXXXXXX        XX.XXGB  Non-RAID Disk

[↑↓]-Select      [ESC]-Exit      [ENTER]-Select Menu
```

The navigation keys at the bottom of the screen allow you to move through the menus and select the menu options.



The RAID BIOS setup screens shown in this section are for reference only and may not exactly match the items on your screen.

Creating a RAID 0 set (striped)

To create a RAID 0 set:

1. From the utility main menu, select 1. Create RAID Volume, then press <Enter>. This screen appears.

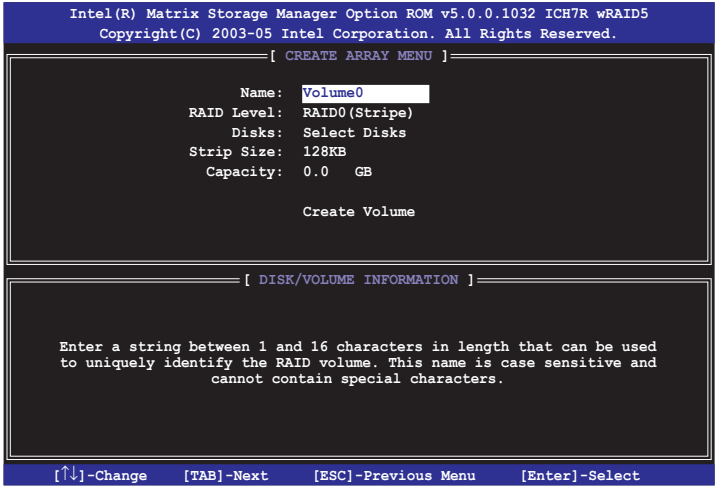

2. Enter a name for the RAID 0 set, then press <Enter>.
3. When the RAID Level item is highlighted, press the up/down arrow key to select RAID 0(Stripe), then press <Enter>.
4. When the Disks item is highlighted, press <Enter> to select the hard disk drives to configure as RAID. This pop-up screen appears.

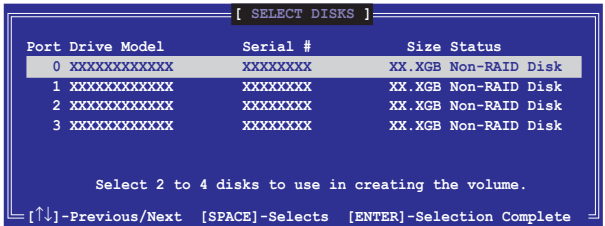

5. Use the up/down arrow key to highlight a drive, then press <Space> to select. A small triangle marks the selected drive. Press <Enter> after completing your selection.

6. Use the up/down arrow key to select the stripe size for the RAID 0 array, then press <Enter>. The available stripe size values range from 4 KB to 128 KB. The default stripe size is 128 KB.



TIP: We recommend a lower stripe size for server systems, and a higher stripe size for multimedia computer systems used mainly for audio and video editing.

7. Key in the RAID volume capacity that you want, then press <Enter>. The default value indicates the maximum allowed capacity.
8. Press <Enter> when the Create Volume item is highlighted. This warning message appears.

```
WARNING: ALL DATA ON SELECTED DISKS WILL BE LOST
Are you sure you want to create this volume? (Y/N):
```

9. Press <Y> to create the RAID volume and return to the main menu, or <N> to go back to the Create Volume menu.

Creating a RAID 1 set (mirrored)

To create a RAID 1 set:

1. From the utility main menu, select 1. Create RAID Volume, then press <Enter>. This screen appears.

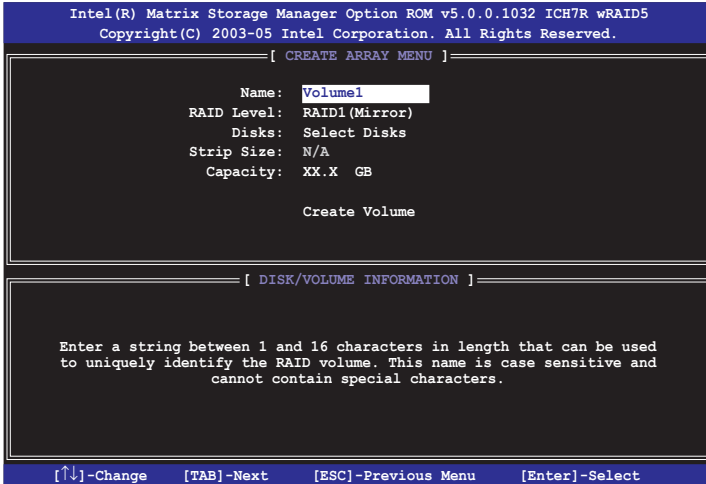

2. Enter a name for the RAID 1 set, then press <Enter>.
3. When the RAID Level item is highlighted, press the up/down arrow key to select RAID 1(Mirror), then press <Enter>.
4. When the Capacity item is highlighted, key in the RAID volume capacity that you want, then press <Enter>. The default value indicates the maximum allowed capacity.
5. Press <Enter> when the Create Volume item is highlighted. This warning message appears.

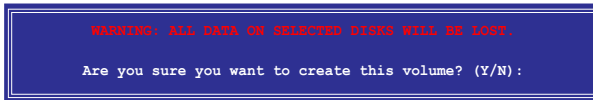

6. Press <Y> to create the RAID volume and return to main menu or <N> to go back to Create Volume menu.

Creating a RAID 5 set (parity)

To create a RAID 5 set:

1. From the utility main menu, select 1. Create RAID Volume, then press <Enter>. This screen appears.

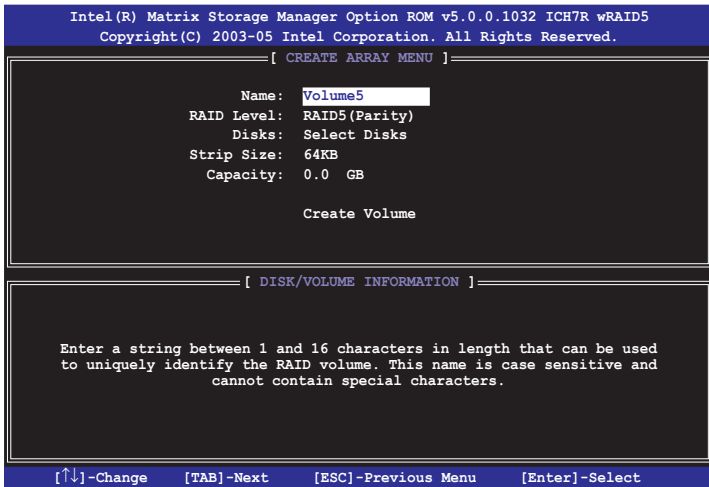

2. Enter a name for the RAID 5 set, then press <Enter>.
3. When the RAID Level item is highlighted, press the up/down arrow key to select RAID 5(Parity), then press <Enter>.
4. The Disks item is highlighted, press <Enter> to select the hard disk drives to configure as RAID. The following pop-up screen appears.

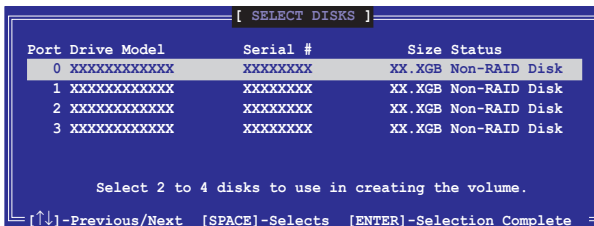

5. Use the up/down arrow key to highlight the drive you want to set, then press <Space> to select. A small triangle marks the selected drive. Press <Enter> after completing your selection.
6. When the Stripe Size item is highlighted, press the up/down arrow key to select the stripe size for the RAID 5 array, then press <Enter>. The available stripe size values range from 4 KB to 128 KB. The default stripe size is 64 KB.



TIP: We recommend a lower stripe size for server systems, and a higher stripe size for multimedia computer systems used mainly for audio and video editing.

7. Key in the RAID volume capacity that you want, then press <Enter> when the Capacity item is highlighted. The default value indicates the maximum allowed capacity.
8. Press <Enter> when the Create Volume item is highlighted. This warning message appears.

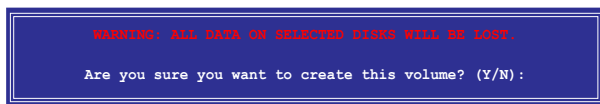

9. Press <Y> to create the RAID volume and return to the main menu or <N> to go back to the Create Volume menu.

Deleting a RAID set



Take caution when deleting a RAID set. You will lose all data on the hard disk drives when you delete a RAID set.

To delete a RAID set:

1. From the utility main menu, select 2. Delete RAID Volume, then press <Enter> to display this screen.

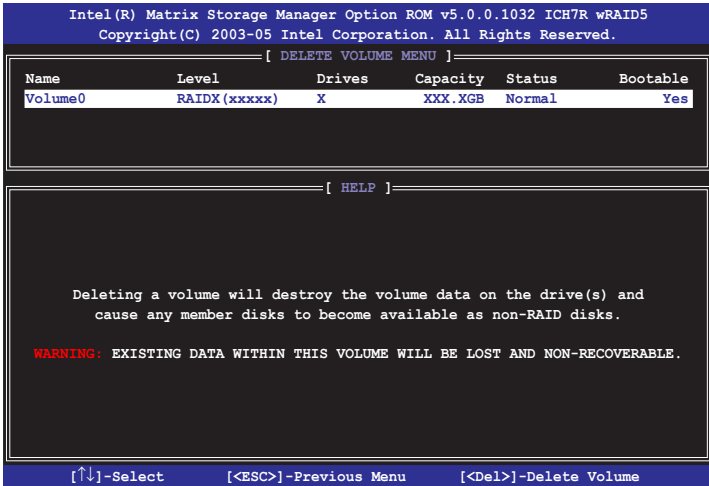

2. Use the up/down arrow key to select the RAID set you want to delete, then press . This window appears.

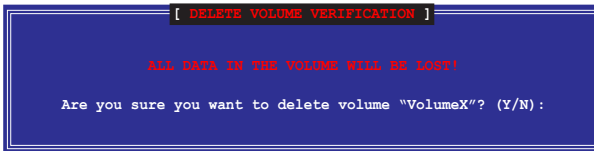

3. Press <Y> to delete the RAID set and return to the utility main menu; otherwise, press <N> to return to the Delete Volume menu.

Resetting Disks to Non-RAID



Take caution before you reset a RAID volume HDD to non-RAID. Resetting a RAID volume HDD deletes all internal RAID structure on the drive.

To reset a RAID set hard disk drive:

1. From the utility main menu, select 3. Reset Disks to Non-RAID, then press <Enter> to display this screen.



2. Use the up/down arrow key to highlight the RAID set drive you want to reset, then press <Space> to select.
3. Press <Enter> to reset the RAID set drive. A confirmation message appears.
4. Press <Y> to reset the drive or press <N> to return to the utility main menu.

Exiting the Intel® Matrix Storage Manager utility

To exit the utility:

1. From the utility main menu, select 4. Exit, then press <Enter>. This window appears.



2. Press <Y> to exit or press <N> to return to the utility main menu.

Resetting a RAID set hard disks drive



Take caution before you reset a RAID volume HDD to non-RAID. Resetting a RAID volume HDD deletes all internal RAID structure on the drive.

To reset a RAID set hard disk drive:

1. From the utility main menu, select [3. Reset Disks to Non-RAID], then press <Enter> to display the following screen.

```

[ RESET RAID DATA ]

Resetting RAID data will remove the internal RAID structures
from the selected RAID disks. By removing these structures
the drive will revert back to a Non-RAID disk.

WARNING: Resetting a disk causes all data on the disk to be lost.

Port Drive Model      Serial #      Size      Status
  0 STXXXXXXXXX      XXXXXXXX     XX.0GB   Member Disk
  1 STXXXXXXXXX      XXXXXXXX     XX.0GB   Member Disk

Select the disk that should be reset

[↑↓]-Previous/Next  [Space]-Selects  [Enter]-Selection Complete
```

2. Use the up or down arrow keys to highlight the RAID set drive you want to reset, then press <Space> to select.
3. Press <Enter> to reset the RAID set drive. A confirmation window appears.
4. Press <Y> to reset the drive; otherwise, press <N> to return to the utility main menu.
5. Follow steps 2 to 4 to select and reset other RAID set drives.

5.4.3 JMicron® RAID Configuration

The JMicron® Serial ATA controller allows you to configure RAID 0 and RAID 1 sets on the external Serial ATA hard disk drives.

Before creating a RAID set

Prepare the following items:

1. Two HDDs, preferably with the same model and capacity.
2. A write-enabled floppy disk
3. Microsoft® Windows® OS installation disk (Windows 2000/XP/2003)
4. Motherboard support CD with JMB363 driver

Complete the following steps before you create a RAID set:

1. Install the external Serial ATA hard disk drives (HDDs) on your system.
2. Set the **JMicron Controller Mode** item in the BIOS to [RAID]. See section “4.4.6 Onboard Devices Configuration” for details.

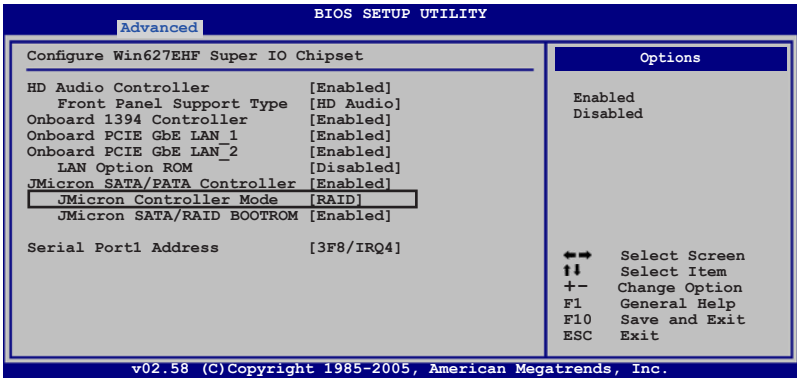

3. Enter the JMB363 RAID BIOS utility to set up your RAID configuration.
4. Create a JMB363 RAID driver disk for Windows® OS installation. See section “5.5 Creating a RAID driver disk” for details.
5. Install the JMB363 driver after the Windows® OS had been installed.

Entering the JMB363 RAID BIOS utility

1. During POST, press <Ctrl-J> to enter the JBM363 RAID BIOS menu.

```
JMicron Technology Corp. PCI-to-SATA II/IDE RAID Controller BIOS v0.97
Copyright (C) 2004-2005 JMicron Technology          http://www. jmicron.com

HDD0 : HDS722516VLSA80                               164 GB Non-RAID
HDD1 : HDS722516DLA380                               164 GB Non-RAID

Press <Ctrl-J> to enter RAID Setup Utility...
```

2. The main JMB363 RAID BIOS menu appears.
3. Use the arrow keys to move the color bar and navigate through the items.

```
JMicron Technology Corp. PCI-to-SATA II/IDE RAID Controller BIOS v0.97

[Main Menu]
Create RAID Disk Drive
Delete RAID Disk Drive
Revert HDD to Non-RAID
Repair Mirror Conflict
Save and Exit Setup
Exit Without Saving

[Hard Disk Drive List]
Model Name      Capacity  Type/Status
HDD0: HDS722516VLSA80  164 GB  Non-RAID
HDD1: HDS722516DLA380  164 GB  Non-RAID

[RAID Disk Drive List]

[←→] TAB]-Switch Window  [↑↓]-Select Item  [ENTER]-Action  [ESC]-Exit
```

Creating a RAID set

1. In the main JMB363 RAID BIOS menu, highlight Create RAID Disk Drive using the up/down arrow key then press <Enter>.

```
[Main Menu]
Create RAID Disk Drive
Delete RAID Disk Drive
Revert HDD to Non-RAID
Repair Mirror Conflict

Save and Exit Setup
Exit Without Saving
```

- When the Level item is highlighted, use the up/down arrow key to select the RAID set that you want to create.

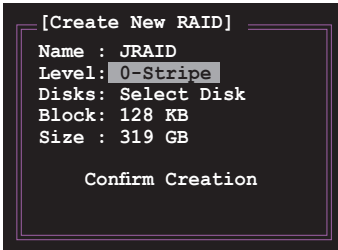

- When the Disks item is highlighted, use the up/down arrow key to highlight an HDD that you want to belong to the RAID set, then press the space bar to confirm selection. Repeat the process until the HDDs are selected.

A selected HDD shows a ► sign before it.

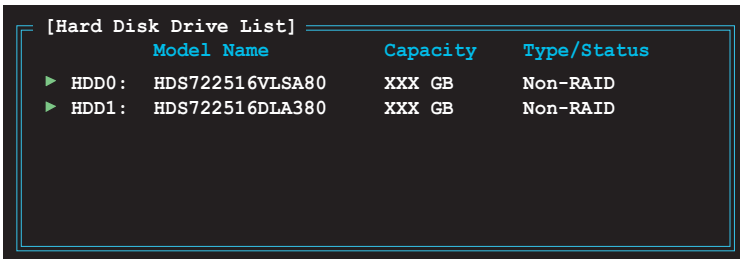

- Key in the RAID volume capacity. Use the up/down arrow to choose the block size. The default value indicates the maximum allowed capacity.



- When done, press <Enter> to confirm the creation of the RAID set. A dialogue box appears to confirm the action. Press <Y> to confirm; otherwise, press <N>.

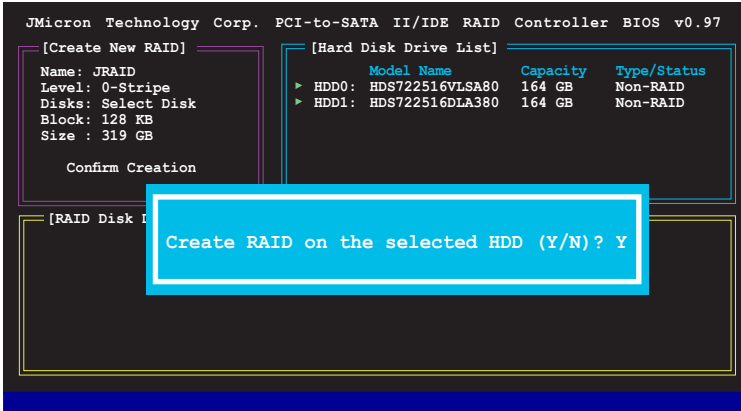

Pressing <Y> deletes all the data in the HDDs.

- The following screen appears, displaying the relevant information about the RAID set you created.

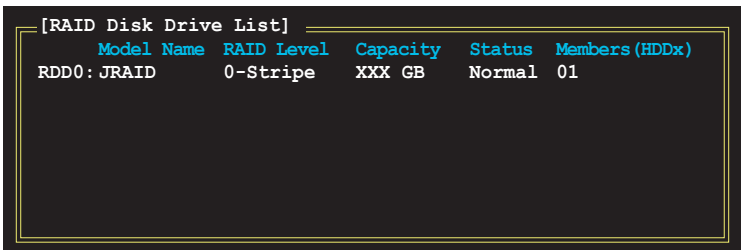

Deleting a RAID set

1. In the main JMB363 RAID BIOS menu, highlight Delete RAID Disk Drive using the up/down arrow key then press <Enter>.

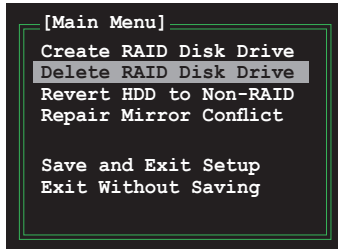

2. Use the space bar to select the RAID set you want to delete. A selected set shows a ► sign before it. Press the key to delete the set.
3. A dialogue box appears to confirm the action. Press <Y> to confirm; otherwise, press <N>.

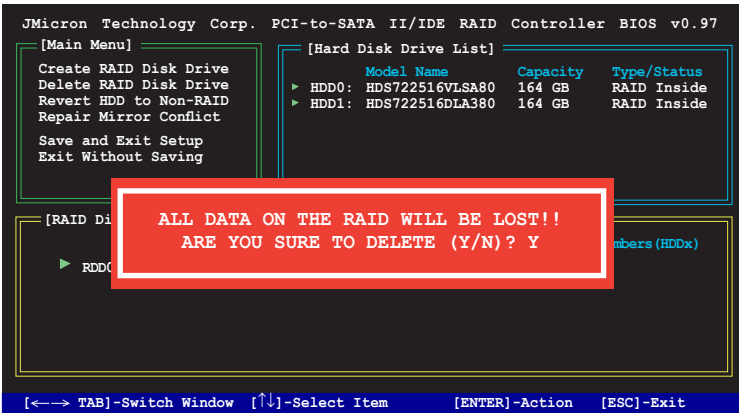

Pressing <Y> deletes all the data in the HDDs.

Resetting disks to non-RAID



An HDD that has been previously configured as part of another RAID set in another platform is called a broken RAID HDD. When you install a broken RAID HDD, you cannot select this HDD when configuring a RAID set through the JMB363 utility.

If you still want to use this broken RAID HDD as part of the RAID set configured through the JMB363, you may do so by resetting the disk to non-RAID. You will, however, lose all data and previous RAID configurations.

To reset disks to non-RAID:

1. In the main JMB363 RAID BIOS menu, highlight Revert HDD to non-RAID using the up/down arrow key then press <Enter>.

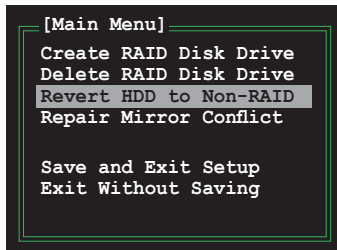

2. Use the space bar to select the HDD that you want to reset to non-RAID. A selected HDD shows a ► sign before it.
3. A dialogue box appears to confirm the action. Press <Y> to confirm; otherwise, press <N>.



Pressing <Y> deletes all the data in the HDD.

Repairing a Mirror conflict

A Mirror conflict occurs when one or both disks in a RAID 1 (Mirror) configuration are unplugged from the system, then plugged in again. Since both disks contain exactly the same data, the system will be unable to determine which of the two is the source drive. This option allows you to set the source drive and rebuild the Mirror drive according to the contents of the source drive.

To repair a Mirror conflict:

1. In the main JMB363 RAID BIOS menu, highlight Repair Mirror Conflict using the up/down arrow key then press <Enter>.

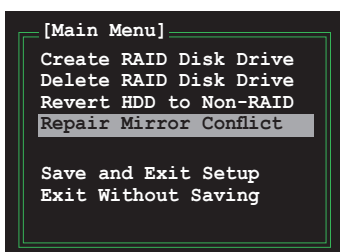

2. Use the space bar to select the HDD that you want to set as source drive. The selected HDD shows a ► sign before it.
3. Using the <TAB>, move to the RAID Disk Drive List menu and highlight the RAID set that you want to rebuild. Press to begin rebuilding the Mirror configuration.

A status bar at the bottom of the screen shows the progress of the rebuilding.

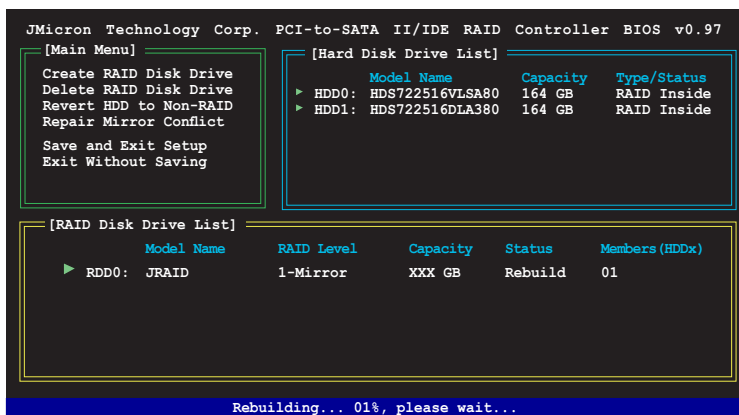

Saving the settings and exiting setup

When you have finished, highlight Save & Exit Setup using the up/down arrow key then press <Enter> to save the current RAID configuration and exit the JMB363 RAID BOS utility.

A dialogue box appears to confirm the action. Press <Y> to confirm; otherwise, press <N> to return to the JMB RAID BIOS menu.

5.4.4 Silicon Image® RAID configuration

The Silicon Image® 4723 Serial ATA controller allows you to build RAID sets on the ASUS EZ-Backup Serial ATA hard disk drives.

About ASUS EZ-Backup

ASUS EZ-Backup is an ASUS exclusive feature that allows you to build a RAID set easily. Without any configuration or BIOS setting required, you can create a RAID 1 set by simply plugging in two Serial ATA hard disks to the onboard EZ_RAID connectors. Simply install the ASUS EZ-Backup Manager, and you are ready to mirror your data. ASUS EZ-Backup secures your data and saves you from complex configurations, troublesome setups, and complicated BIOS settings. Refer to the succeeding sections to configure other RAID sets.

RAID modes supported

ASUS EZ-Backup supports the following RAID modes:

1. **SAFE / RAID 1 (*Data mirroring*)** is storage policy in which all data are stored in duplicate on separate drives to protect against data loss due to drive failure. One drive mirrors the other at all times. This mode is equivalent to RAID 1. Every write operation goes to both drives. Safe provides the highest level of data protection, but halves the amount of storage space because all data must be stored twice.

If one drive fails, the Safe volume is in a vulnerable state because its mirrored hard drive is inaccessible. When the offline drive comes back online, the firmware begins a rebuild process immediately to restore data redundancy. A message box appears in the ASUS EZ-Backup Manager graphical user interface (GUI) to notify you that a rebuild is in progress. Although the volume remains available during the rebuild process, the volume is susceptible to data loss through damage to the remaining drive until redundancy is restored at the end of the rebuild and verification process. Host access takes precedence over the rebuild process. If you continue to use the Safe volume during the rebuild, the rebuild process will take a longer time to complete.

To implement the Safe storage policy, the ASUS EZ-Backup Manager creates one volume. One hard drive mirrors the other.

2. **FAST / RAID 0 (*Data striping*)** is a storage policy in which I/O processing is balanced evenly in a method known as striping. This mode equivalent to RAID 0. Striping increases storage operation speed because each portion of data is divided into segments that are written to different disks simultaneously. Fast offers the best performance, but no data redundancy because there is no way to retrieve or reconstruct data on a failed drive.

To implement the Fast storage policy, the ASUS EZ-Backup Manager creates a single volume that is striped across both hard drives.

3. **BIG** is storage policy in which multiple physical drives are concatenated and treated as one large volume. This configuration allows you to increase virtual volume size beyond the capacity of individual drives. Big provides the maximum amount of storage space, but no additional performance or data redundancy.

To implement the Big storage policy, the ASUS EZ-Backup Manager concatenates both hard drives into a single volume.

Before creating a RAID set

Prepare the following items:

1. Two Serial ATA hard disk drives (HDDs), preferably with the same model and capacity.
2. Motherboard support CD with ASUS EZ-Backup Manager

Building a RAID 1 set for the first time

The ASUS EZ-Backup advantage is that you can build a RAID 1 set without any jumper or BIOS setting. When creating a RAID 1 set for the first time, you can follow these simple steps.

1. Prepare two Serial ATA hard disk drives (HDDs). Plug one end of the Serial ATA cable to the rear interface on each drive and plug the other end of the cable to the motherboard connectors labeled EZ_RAID1 and EZ_RAID2 (colored light orange). Refer to section "2.7.2 Internal connectors" for the location of the connectors.



For best results, use Serial ATA 3.0 Gb/s hard disk drives listed in the EZ-Backup compatibility list. Visit the ASUS website at www.asus.com for details.

2. Connect a Serial ATA power cable or a 4-pin legacy power connector from the power supply unit to the rear power connector on each drive.



Using both the SATA power cable and 4-pin power connector simultaneously will cause damage to the system.

3. Install the operating system.
4. Install the ASUS EZ-Backup Manager utility from the support CD that came with the motherboard package.
5. Reboot the computer.

Creating a Big/Fast RAID set for the first time

1. Set the EZ-Backup jumper mode. Refer to the jumper settings below for the respective RAID modes supported.



If you do not change the jumper setting on first installation, the system applies the default RAID mode, which is RAID 1.

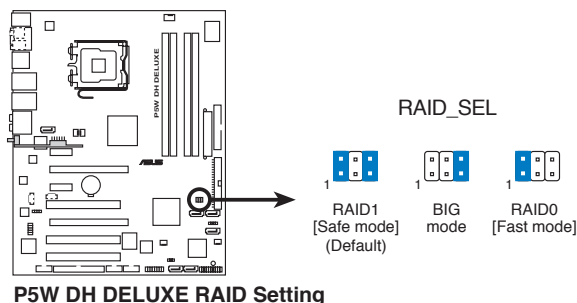

P5W DH DELUXE RAID Setting

2. Prepare two Serial ATA hard disk drives (HDDs). Plug one end of the Serial ATA cable to the rear interface on each drive and plug the other end of the cable to the motherboard connectors labeled EZ_RAID1 and EZ_RAID2 (colored light orange). Refer to section “2.7.2 Internal connectors” for the location of the connectors.



- For best results, use Serial ATA 3.0 Gb/s hard disk drives listed in the EZ-Backup compatibility list. Visit the ASUS website at www.asus.com for details.
- **The total RAID disk volume size should be less than 2.1 Terabytes (TB).**

3. Connect a Serial ATA power cable or a 4-pin legacy power connector from the power supply unit to the rear power connector on each drive.



Using both the SATA power cable and 4-pin power connector simultaneously will cause damage to the system.

4. Enter the BIOS setup during POST. Go to Advanced menu > DH Feature page. Set the **EZ Backup RAID Mode Change** item to Enabled.



Make sure you have made the above BIOS setting. If you changed the jumper settings but did not enable the EZ Backup RAID Mode Change, the system applies the default RAID mode, which is RAID 1.

5. Press <F10> to save and exit. The system will restart.
The following message appears after you exit the BIOS utility.

```
EZ Backup RAID Mode will change.  
Press F1 to continue.
```

6. Install the operating system.
7. Install the ASUS EZ-Backup Manager utility from the support CD that came with the motherboard package.

Changing RAID modes

To change from one RAID mode to another, follow steps 1, 4, and 5 of the previous section, "Creating a Big/Fast RAID set for the first time."





RAID mode change will destroy any data on the hard disk drives. Backup existing data before changing RAID modes.

Using the ASUS EZ-Backup Manager

After rebooting the computer and entering Windows® again, you will find an icon shortcut for the ASUS EZ-Backup Manager utility on your desktop or taskbar.

Launching the ASUS EZ-Backup Manager

To launch the ASUS EZ-Backup Manager, double-click  on your desktop or  on the taskbar.



You may also go to **Start > Programs > EzBackup > EzBackupManager**.



When you create a RAID 10 set through a cross configuration, you cannot use the EZ-Backup Manager utility to view the status of hard disks installed on the EZ_RAID1 and EZ_RAID2 connectors.

Status window

The ASUS EZ-Backup Manager status window allows you to monitor the devices connected to the host computer.

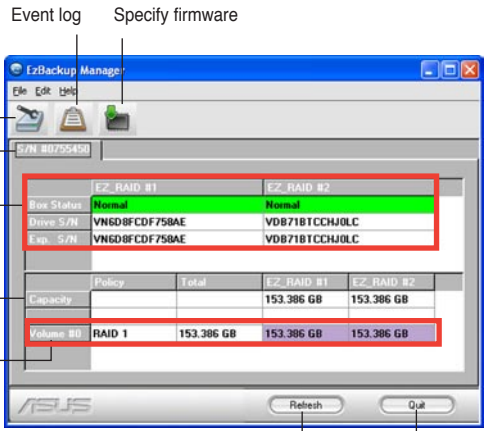

The screenshot shows the ASUS EZ-Backup Manager status window. Annotations include:

- Event log
- Specify firmware
- Configure pop-ups
- Serial number
- Drive status and information
- Capacity information
- Volume information
- Refresh button
- Quit button

	EZ_RAID #1	EZ_RAID #2
Box Status	Normal	Normal
Drive S/N	VN6D8FCDF758AE	VDB71BT CCHJ0LC
Exp. S/N	VN6D8FCDF758AE	VDB71BT CCHJ0LC

	Policy	Total	EZ_RAID #1	EZ_RAID #2
Capacity			153.386 GB	153.386 GB

Volume #0		153.386 GB	153.386 GB	153.386 GB
RAID 1				



Screen captures shown in the section are provided for your reference only, and may change any time without notice.

Serial number. Displays the serial number of the ASUS EZ-Backup Manager.

Drive status and information. Displays the current status and serial number of each drive member of the RAID set.

Below is a list of possible drive states:

1. Normal
2. Rebuilding
3. Verifying
4. Unplugged
5. Needs rebuild
6. New drive
7. Wrong slot
8. Use bigger drive

Capacity information. Displays the maximum capacity of each drive member of the RAID set.

Volume information. Shows the RAID mode, total volume of the RAID set, and maximum capacity of each drive member of the RAID set.

File menu

The File menu allows you to change the password, scan devices, change connection, and exit the ASUS EZ-Backup Manager.

Change Password. Opens a dialog box that allows you to change the default password, **admin**. To change this, key in a new password, then retype the new password. Press <OK> to set.

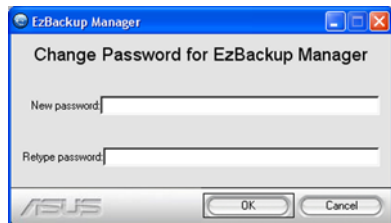

Scan Devices. Refreshes the information shown on the status window.

Change Connection. Opens a dialog box that allows you to change remote connection settings.

Exit. Quits the ASUS EZ-Backup Manager.

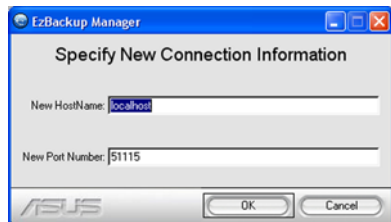

Edit menu

The File menu allows you to configure pop-ups, view event logs, and view/update the current firmware.

Configure pop-ups. Click this button to open a window that allows you to enable or disable pop-up display, and specify the number of seconds for the pop-ups to remain on screen.



Event log. Click this button to display the record of events for storage devices installed.

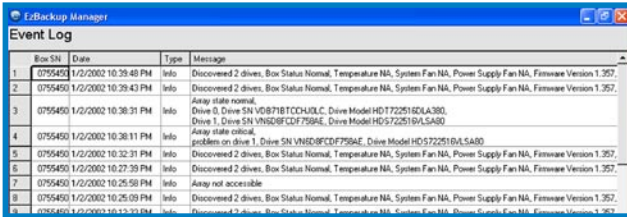

Row	Box SN	Date	Type	Message
1	0755450	1/2/2002 10:35:48 PM	Info	Discovered 2 drives, Box Status Normal, Temperature NA, System Fan NA, Power Supply Fan NA, Firmware Version 1.357.
2	0755450	1/2/2002 10:39:43 PM	Info	Discovered 2 drives, Box Status Normal, Temperature NA, System Fan NA, Power Supply Fan NA, Firmware Version 1.357.
3	0755450	1/2/2002 10:38:31 PM	Info	Array state normal.
4	0755450	1/2/2002 10:38:11 PM	Info	Drive 0, Drive SN V08718TCC4JL.C, Drive Model HD1722518DLA380. Drive 1, Drive SN VNSD8FCDF759AE, Drive Model HD5722518LASA80.
5	0755450	1/2/2002 10:32:31 PM	Info	Array state critical. problem on drive 1, Drive SN VNSD8FCDF759AE, Drive Model HD5722518LASA80.
6	0755450	1/2/2002 10:27:39 PM	Info	Discovered 2 drives, Box Status Normal, Temperature NA, System Fan NA, Power Supply Fan NA, Firmware Version 1.357.
7	0755450	1/2/2002 10:25:59 PM	Info	Array not accessible.
8	0755450	1/2/2002 10:25:09 PM	Info	Discovered 2 drives, Box Status Normal, Temperature NA, System Fan NA, Power Supply Fan NA, Firmware Version 1.357.
9	0755450	1/2/2002 10:13:33 PM	Info	Discovered 2 drives, Box Status Normal, Temperature NA, System Fan NA, Power Supply Fan NA, Firmware Version 1.357.

Specify firmware. Click this button to view the current firmware version or to update the firmware.

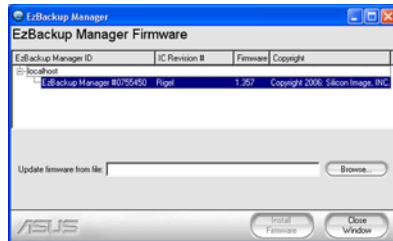

Partitioning volumes

You need to partition the hard disk drive volumes for the operating system before you can store/backup data on the drive.



Before partitioning volumes, back up your data and delete any previously defined partition.

To partition volumes:

1. Boot your computer and enter the Windows® operating system.
2. Right-click **My Computer** on your desktop. Select **Manage** from the pop-up window.

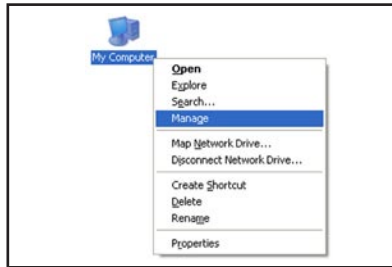

3. Under Storage, select **Disk Management**. The Windows® Disk Manager opens.

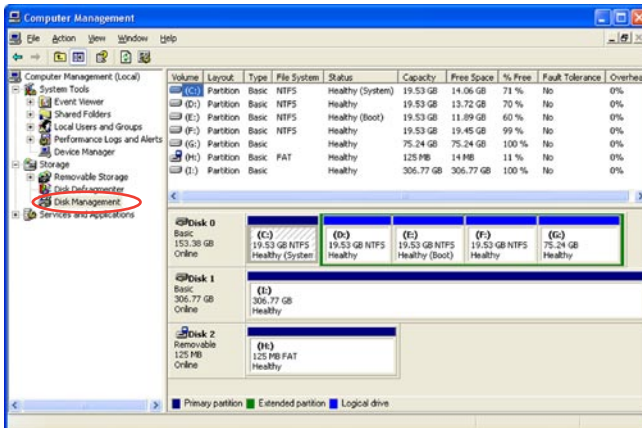

4. Select the disk you want to partition.



The disk number on Windows Disk Manager may not be the same as the disk number shown on the ASUS EZ-Backup Manager. Make sure you select the correct disk by checking the total disk capacity information.

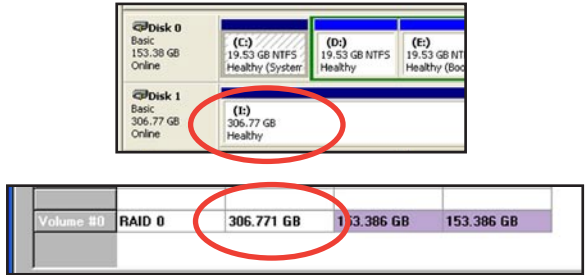

5. Right-click the disk's unallocated space, then select **New Partition**.

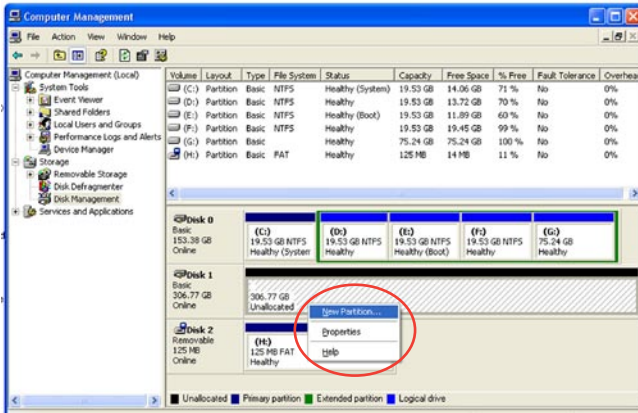

The screen captures in this section are provided for your reference only. The appearance of the screen and items in it may vary, depending on the operating system you installed.

6. The Partition Wizard opens. Click **Next** to start the partition process.

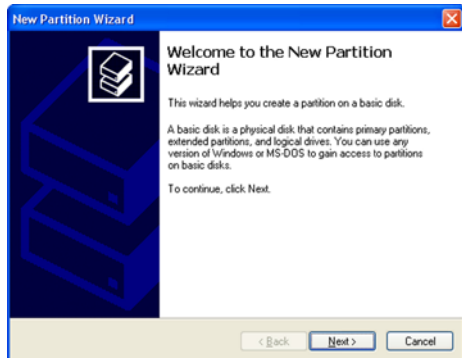

7. Select the type of partition you want to create. Click **Next**.

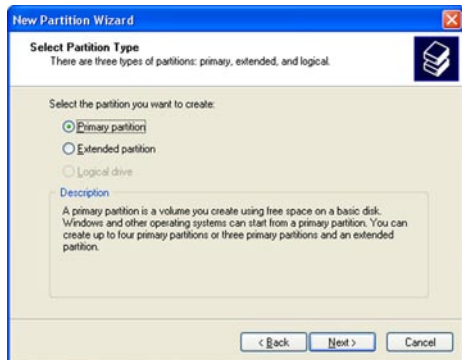

8. Specify your desired partition size. The default partition size is the entire volume. Click **Next**.



9. Assign a drive letter or drive path to the partition.
Click **Next**.

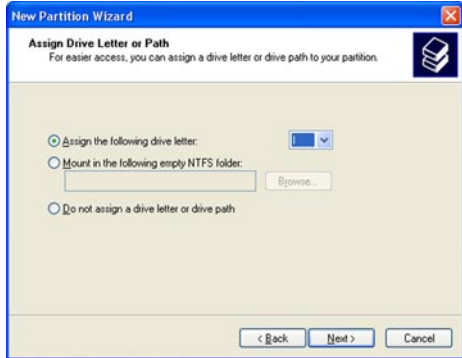

10. Name and format the partition.
Click **Next**.

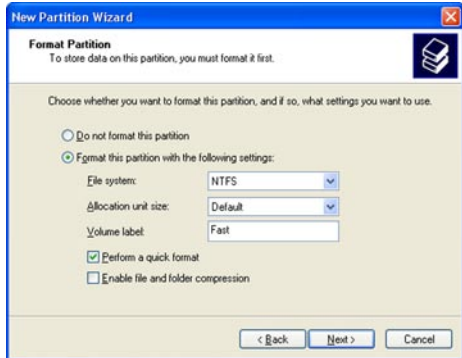

11. The New Partition Wizard displays the file system settings. Make sure the settings are correct.
Click **Finish** to create the partition; otherwise, click **Back** to make the necessary changes.

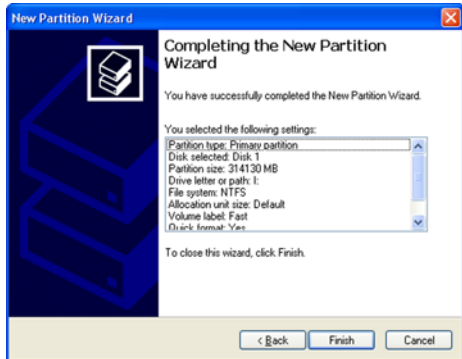

Rebuilding a hard disk drive

ASUS EZ-Backup will rebuild a RAID 1 set after a failed hard disk drive is replaced with a functioning HDD, or the mirror becomes unsynchronized when a working hard disk drive is removed, then returned.



This function applies only to a RAID 1 (SAFE) set.

The following message pops up when a hard disk drive is unplugged:



To rebuild:

1. Plug in the Serial ATA cable to the available EZ_RAID connector.
2. Rebuilding starts.

The Box Status cell displays the rebuilding progress.

Note that the box is colored orange.

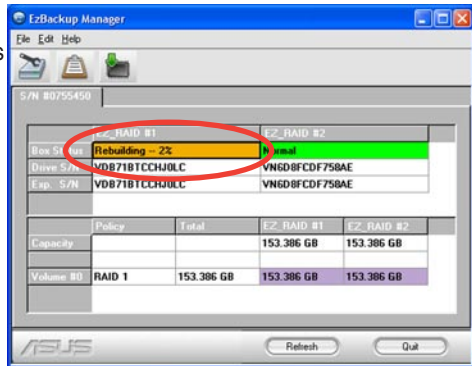

3. When done, the following message pops up. Click **OK**

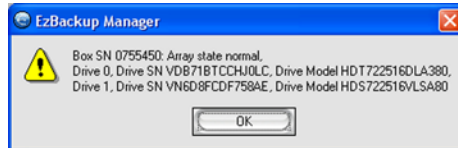

4. When done, click **Refresh** to update the information. If rebuilding is successful, the status displays **Normal** and the box color changes to green.

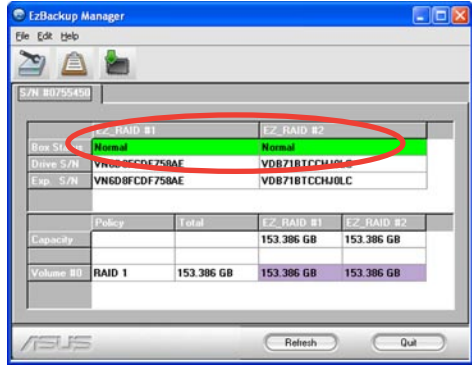

5.4.5 Cross-RAID Configuration: Creating a RAID 10 set with ASUS EZ-Backup and Intel ICH7R®

A RAID 10 set requires four HDDs. The onboard RAID controller on the Intel® ICH7R Southbridge, however, controls only three Serial ATA connectors. To build a RAID 10 set, you need to cross-configure Intel® ICH7R with Silicon Image®, which controls the EZ_RAID connectors for the EZ-Backup feature.

Refer to the succeeding sections to build a RAID 10 set.

Hardware setup

1. Install one Serial ATA HDD on the motherboard connector labeled EZ_RAID1.
2. Install three Serial HDDs on the motherboard connectors labeled SATA1, SATA3, and SATA4.

EZ Backup jumper setting and BIOS configuration



For information on EZ-Backup jumper setting and BIOS configuration, see section "5.4.4 Silicon Image RAID configuration."

1. After installing the Serial ATA hard disks, set the jumper setting to the default RAID 1 mode.
2. Turn the system on, and enter the BIOS setup during POST. Go to Advanced menu > DH Feature page. Set the **EZ Backup RAID Mode Change** item to Enabled (if the jumper setting has been changed).
3. Press <F10> to save and exit. The system will restart.

Creating a RAID 10 set using the Intel® Matrix Storage Manager Option ROM Utility

To create a RAID 10 set:

1. Turn on the system.
2. During POST, press <Ctrl+I> to display the utility main menu.
3. From the utility main menu, select 1. Create RAID Volume, then press <Enter>. This screen appears.

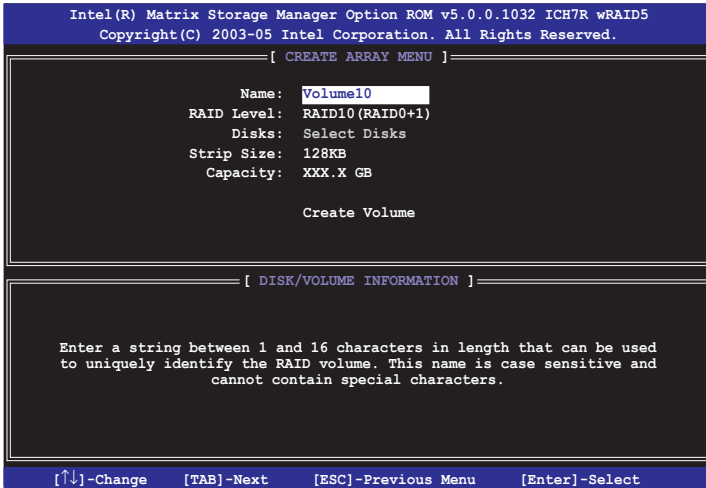

4. Enter a name for the RAID 10 set, then press <Enter>.
5. When the RAID Level item is highlighted, press the up/down arrow key to select RAID 10(RAID0+1), then press <Enter>.
6. When the Stripe Size item is highlighted, press the up/down arrow key to select the stripe size for the RAID 10 array, then press <Enter>. The available stripe size values range from 4 KB to 128 KB. The default stripe size is 64 KB.



TIP: We recommend a lower stripe size for server systems, and a higher stripe size for multimedia computer systems used mainly for audio and video editing.

7. Key in the RAID volume capacity that you want then press <Enter> when the Capacity item is highlighted. The default value indicates the maximum allowed capacity.
8. Press <Enter> when the Create Volume item is highlighted. This warning message appears.



9. Press <Y> to create the RAID volume and return to the main menu or <N> to go back to the Create Volume menu.
10. The main menu appears as follows after you have created the RAID 10 set. The HDD connected to the EZ_RAID connector is identified as “External Disk.”

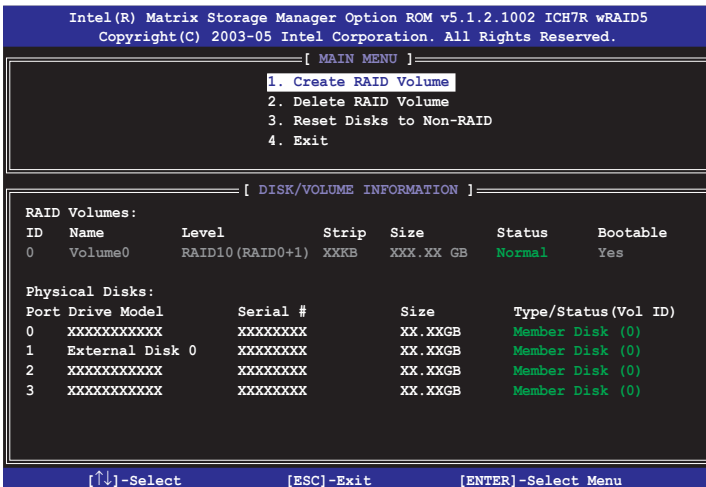

When you create a RAID 10 set through a cross configuration, you cannot use the EZ-Backup Manager utility to view the status of hard disks installed on the EZ_RAID1 and EZ_RAID2 connectors. Intel® Matrix Storage cannot read the hard disk drive information on the ASUS EZ-Backup connectors.

5.5 Creating a RAID driver disk

A floppy disk with the RAID driver is required when installing Windows® 2000/XP and later operating system on a hard disk drive that is included in a RAID set.



You do not need to create a RAID driver disk if you will create a Safe, Big, or Fast RAID set through the ASUS EZ-Backup.

5.5.1 Creating a RAID driver disk without entering the OS

To create a RAID driver disk without entering the OS:

1. Boot your computer.
2. Press during POST to enter the BIOS setup utility.
3. Set the optical drive as the primary boot device.
4. Insert the support CD into the optical drive.
5. Save changes and exit BIOS.
6. Press any key when the system prompts "Press any key to boot from the optical drive."
7. When the menu appears, press <1> to create a RAID driver disk.
8. Insert a formatted floppy disk into the floppy drive then press <Enter>.
9. Follow succeeding screen instructions to complete the process.

5.5.2 Creating a RAID driver disk in Windows®

To create a RAID driver disk in Windows®:

1. Start Windows®.
2. Place the motherboard support CD into the optical drive.
3. Go to the Make Disk menu, then click **Intel ICH7R 32/64 bit RAID Driver Disk** to create an Intel® ICH7R RAID driver disk or the **Make JMicron JMB36X 32/64-bit RAID Driver** to create a JMicron JMB363 RAID driver disk.
4. Insert a floppy disk into the floppy disk drive.
5. Follow succeeding screen instructions to complete the process.



Write-protect the floppy disk to avoid computer virus infection.

To install the RAID driver:

1. During the OS installation, the system prompts you to press the F6 key to install third-party SCSI or RAID driver.
2. Press <F6> then insert the floppy disk with RAID driver into the floppy disk drive.
3. When prompted to select the SCSI adapter to install, make sure you select Intel(R) 82801GH/GM SATA RAID Controller (Desktop ICH7R/DH) and JMicron JMB363.
4. Follow the succeeding screen instructions to complete the installation.

This chapter tells how to install ATI®
CrossFire™ graphics cards to avail of
ATI's Multi-Video Processing technology.

ATI® CrossFire™ technology support **6**

6.1	Overview	6-1
6.2	Installing CrossFire™ graphics cards	6-2
6.3	Software information	6-5

6.1 Overview

The motherboard supports the ATI® CrossFire™ technology that allows you to install multi-graphics processing units (GPU) graphics cards. Follow the installation procedures in this section.

6.1.1 Requirements

- CrossFire™ Edition graphics card (Master)
- CrossFire™-ready graphics card (Slave)
- CrossFire™-ready motherboard, such as the ASUS P5W DH Deluxe motherboard.
- Make sure that your power supply unit (PSU) can provide at least the minimum power required by your system. See “14. Power connectors” on page 2-40 for details.



-
- Visit the ATI website or download the Radeon® X850 Crossfire™ Edition User's Guide from the support CD for detailed hardware requirements and installation procedures.
 - The ATI CrossFire™ technology supports only the following operating systems:
 - Windows® XP 32-bit (Home or Professional) with Service Pack 2 (SP2)
 - Windows® XP Professional 64-bit Edition.
 - Make sure that your graphics card driver supports the ATI® CrossFire™ Technology. Download the latest driver from the ATI website (www.ati.com)
 - The maximum resolution of Radeon™ X850 CrossFire™ Edition is 1600 x 1200 at 65 MHz when you use DVI output.
-

6.1.2 Before you begin

Uninstall other graphics card drivers in your system

To uninstall other graphics card drivers:

1. Close all current applications.
2. Go to Control Panel > Add/Remove Programs.
3. Select your current graphics card driver/s.
4. Select **Add/Remove**.
5. Restart your system.

6.2 Installing CrossFire™ graphics cards



Before installing a CrossFire™ system, refer to the user guide that came with the ATI® CrossFire™ Edition graphics card.

To install the graphics cards:

1. Prepare one CrossFire™ Edition (Master) graphics card and one CrossFire™-ready (Slave) graphics card.

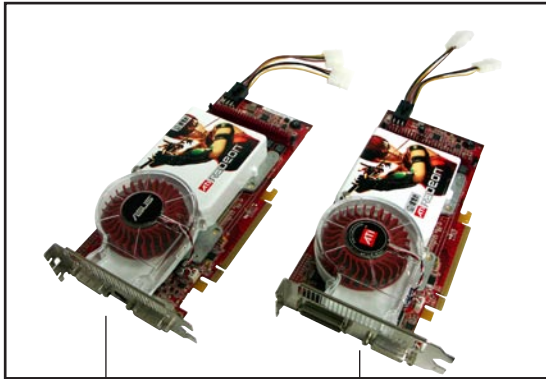

Slave graphics card

Master graphics card

2. Insert the CrossFire™ Edition (Master) graphics card into the PCI Express x16 orange slot. Make sure that the card is properly seated on the slot.

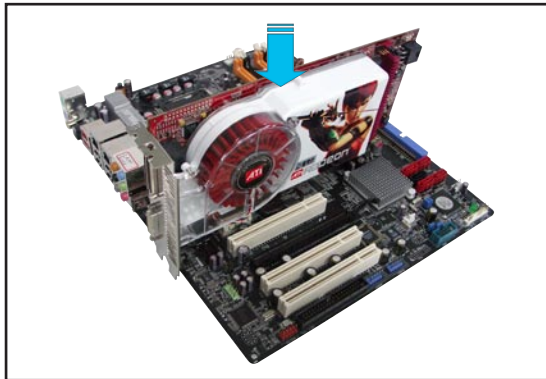

3. Insert the CrossFire™-ready (Slave) graphics card into the PCI Express x16 black slot. Make sure that the card is properly seated on the slot.

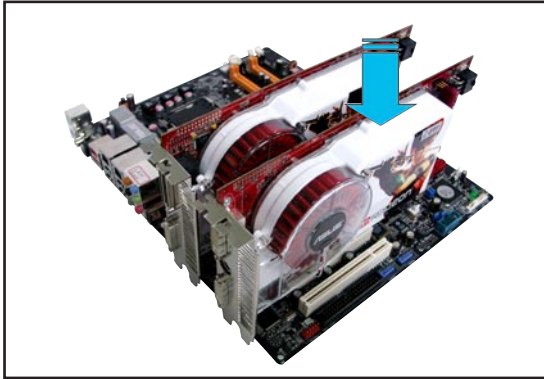

4. Connect an auxiliary power source from the power supply to the graphics cards.

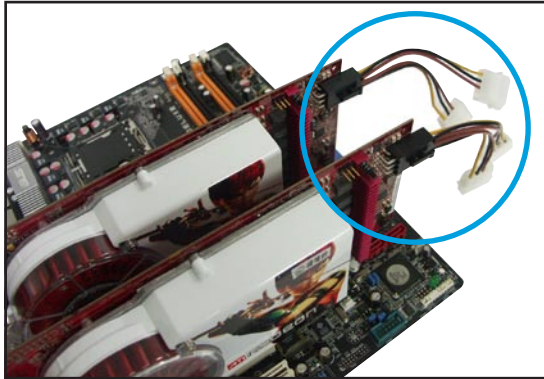

5. Connect one end of the external cable to the Master graphics card.

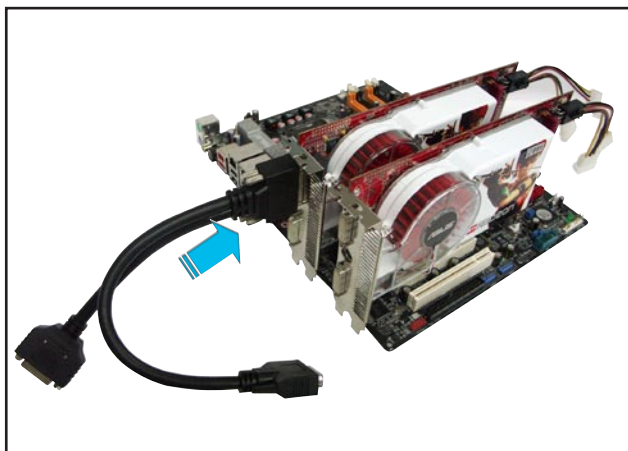

6. Connect the other end of the external cable to the Slave graphics card.
7. Connect the loose end to the corresponding port on your monitor.

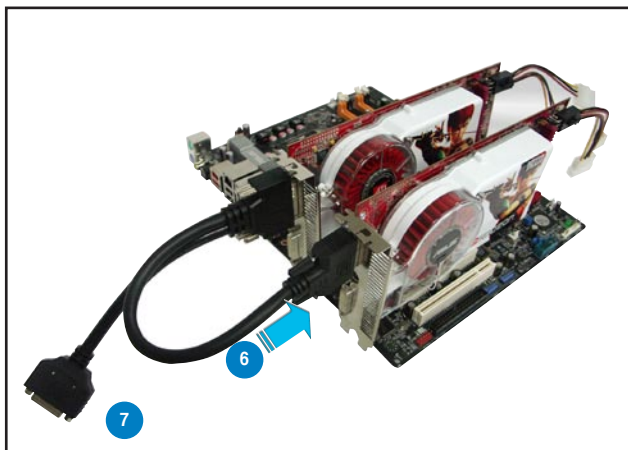

6.3 Software information

6.3.1 Installing the device drivers

Refer to the documentation that came with your graphics card package to install the device drivers.



The ATI CrossFire™ technology supports only the following operating systems:

- Windows® XP 32-bit (Home or Professional) with Service Pack 2 (SP2)
- Windows® XP Professional 64-bit Edition.

1. Turn on your system and log in with administrator rights.
2. Windows® auto-detects the CrossFire™ graphics cards and displays the Found New Hardware Wizard window. Click **Cancel**.
3. Place the CrossFire™ installation CD in your optical drive and install drivers from the opening menu.



4. Click **Next** to continue from the installation window that appears.

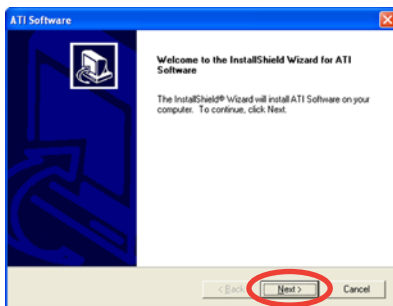

5. Read the License Agreement, then click **Yes**.

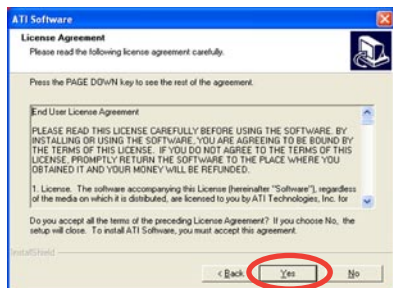

6. Select the components that you want to install, then click **Next**.

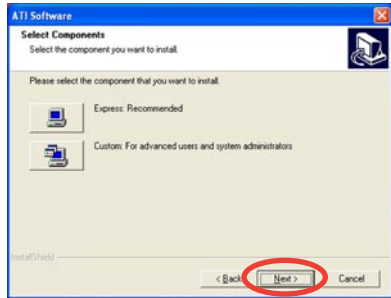

- Select Express to install the HydraVision™ multi-monitor and desktop management software, as well as the ATI driver.
- Select Custom to individually choose desired software components.

Setup prepares the installation wizard that will guide you to setup process.

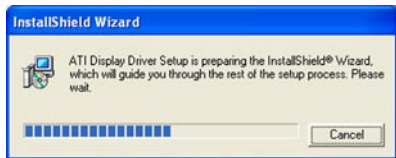

Windows automatically configures the ATI Catalyst Control Center. The status windows indicates the progress of the installation.



7. The Setup Complete window appears, indicating that the driver files have been copied to your computer.

Click **Yes** to restart your computer now or **No** to restart later

8. Click **Finish**.

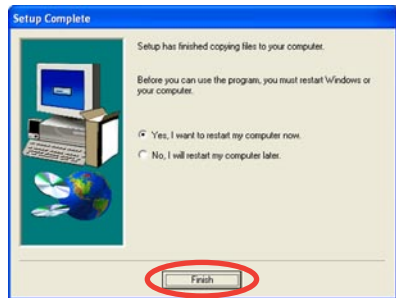

6.3.2 Using the Catalyst™ Control Center

The Catalyst™ Control Center allows you to access display features of the ATI hardware and software you installed. Use this application to adjust your graphic settings, enable/disable connected devices, and change your desktop orientation.

Launching the Catalyst™ Control Center

There are several ways to launch the Catalyst™ Control Center:

- On the Windows® task bar, click Start > ATI Catalyst™ Control Center > Catalyst™ Control Center
- Double-click the Catalyst™ Control Center desktop shortcut.



- On the Windows® task bar, double-click the Catalyst™ Control Center icon.



The Catalyst™ Control Center Dialog Box

View

The Catalyst™ Control Center provides two views:

- **Standard** - simple view with wizards for beginners



- **Advance** - allows advanced users to access and configure the complete features of the software



Set to **Advance** view to enable the CrossFire™ function.

To enable CrossFire™:

1. Set the view to **Advance**.
2. Click the Crossfire™ item in Graphics Settings.
3. In the CrossFire™ Settings dialog, tick the box opposite **Enable CrossFire™**.
4. Click **OK** to effect the setting.



Hotkeys

Click the **Hotkeys** tab on the Catalyst™ Control Center to access the Hotkeys Manager, which allows you to create key combinations as shortcuts for performing certain functions quickly.



Profiles

Click the **Profiles** tab on the Catalyst™ Control Center to access the Profiles Manager, which allows you to create customized environments for your desktop, video, and 3D applications.



Preferences

Click the **Preferences** tab on the Catalyst™ Control Center to select a language, restore defaults, change skins, or enable/disable the System Tray icon.



Help

Click the **Help** tab on the Catalyst™ Control Center to access the online help system, generate a Problem Report, and get the Catalyst™ Control Center version information.



The Appendix describes the CPU features and technologies that the motherboard supports.

Appendix A CPU features

Chapter summary



A.1	Intel® EM64T.....	A-1
A.2	Enhanced Intel SpeedStep® Technology (EIST).....	A-1
A.3	Intel® Hyper-Threading Technology	A-3

A.1 Intel® EM64T



- The motherboard is fully compatible with Intel® Pentium® 4 LGA775 processors running on 32-bit operating systems.
 - The motherboard comes with a BIOS file that supports EM64T. You can download the latest BIOS file from the ASUS website (www.asus.com/support/download/) if you need to update the BIOS file. See Chapter 4 for details.
 - Visit www.intel.com for more information on the EM64T feature.
 - Visit www.microsoft.com for more information on Windows® 64-bit OS.
-

Using the Intel® EM64T feature

To use the Intel® EM64T feature:

1. Install an Intel® Pentium® 4 CPU that supports the Intel® EM64T.
2. Install a 64-bit operating system (Windows® XP Professional x64 Edition or Windows® Server 2003 x64 Edition).
3. Install the 64-bit drivers for the motherboard components and devices from the support CD.
4. Install the 64-bit drivers for expansion cards or add-on devices, if any.



Refer to the expansion card or add-on device(s) documentation, or visit the related website, to verify if the card/device supports a 64-bit system.

A.2 Enhanced Intel SpeedStep® Technology (EIST)



- The motherboard comes with a BIOS file that supports EIST. You can download the latest BIOS file from the ASUS website (www.asus.com/support/download/) if you need to update the BIOS. See Chapter 4 for details.
 - Visit www.intel.com for more information on the EIST feature.
-

A.2.1 System requirements

Before using EIST, check your system if it meets the following requirements:

- Intel® Pentium® 4 processor with EIST support
- BIOS file with EIST support
- Operating system with EIST support (Windows® XP SP2/Windows® Server 2003 SP1/Linux 2.6 kernel or later versions)

A.2.2 Using the EIST

To use the EIST feature:

1. Turn on the computer, then enter the BIOS Setup.
2. Go to the Advanced Menu, highlight **CPU Configuration**, then press <Enter>.
3. Set the **Intel(R) SpeedStep Technology** item to [Automatic], then press <Enter>. See page 4-25 for details.
4. Press <F10> to save your changes and exit the BIOS setup.
5. After the computer restarts, right click on a blank space on the desktop, then select **Properties** from the pop-up menu.
6. When the **Display Properties** window appears, click the **Screen Saver** tab.
7. Click the **Power** button on the Monitor power section to open the **Power Options Properties** window.

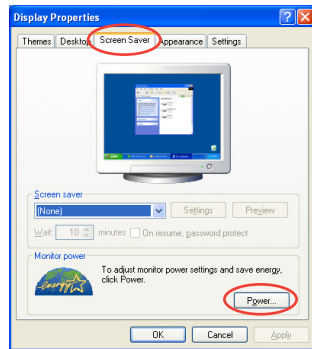

8. On the Power schemes section, click , then select any option except Home/Office Desktop or Always On.
9. Click **Apply**, then click **OK**.
10. Close the Display Properties window. After you adjust the power scheme, the CPU internal frequency slightly decreases when the CPU loading is low.

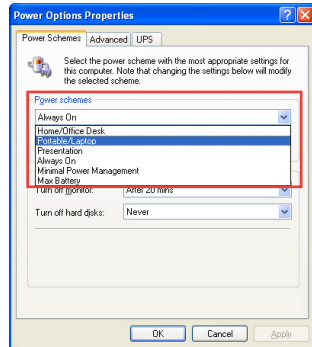

The screen displays and procedures may vary depending on the operating system.

A.3 Intel® Hyper-Threading Technology



- The motherboard supports Intel® Pentium® 4 LGA775 processors with Hyper-Threading Technology.
 - Hyper-Threading Technology is supported under Windows® XP/2003 Server and Linux 2.4.x (kernel) and later versions only. Under Linux, use the Hyper-Threading compiler to compile the code. If you are using any other operating systems, disable the Hyper-Threading Technology item in the BIOS to ensure system stability and performance.
 - Installing Windows® XP Service Pack 1 or later version is recommended.
 - Make sure to enable the Hyper-Threading Technology item in BIOS before installing a supported operating system.
 - For more information on Hyper-Threading Technology, visit www.intel.com/info/hyperthreading.
-

Using the Hyper-Threading Technology

To use the Hyper-Threading Technology:

1. Install an Intel® Pentium® 4 CPU that supports Hyper-Threading Technology.
2. Power up the system and enter the BIOS Setup. Under the Advanced Menu, make sure that the item **Hyper-Threading Technology** is set to Enabled. See page 4-25 for details.
The BIOS item appears only if you installed a CPU that supports Hyper-Threading Technology.
3. Restart the computer.

