

ASUS[®]
Terminator 1
Barebone System
Model A7VT400



E2030

Revised Edition V2

March 2005

Copyright © 2005 ASUSTeK COMPUTER INC. All Rights Reserved.

No part of this manual, including the products and software described in it, may be reproduced, transmitted, transcribed, stored in a retrieval system, or translated into any language in any form or by any means, except documentation kept by the purchaser for backup purposes, without the express written permission of ASUSTeK COMPUTER INC. ("ASUS").

Product warranty or service will not be extended if: (1) the product is repaired, modified or altered, unless such repair, modification or alteration is authorized in writing by ASUS; or (2) the serial number of the product is defaced or missing.

ASUS PROVIDES THIS MANUAL "AS IS" WITHOUT WARRANTY OF ANY KIND, EITHER EXPRESS OR IMPLIED, INCLUDING BUT NOT LIMITED TO THE IMPLIED WARRANTIES OR CONDITIONS OF MERCHANTABILITY OR FITNESS FOR A PARTICULAR PURPOSE. IN NO EVENT SHALL ASUS, ITS DIRECTORS, OFFICERS, EMPLOYEES OR AGENTS BE LIABLE FOR ANY INDIRECT, SPECIAL, INCIDENTAL, OR CONSEQUENTIAL DAMAGES (INCLUDING DAMAGES FOR LOSS OF PROFITS, LOSS OF BUSINESS, LOSS OF USE OR DATA, INTERRUPTION OF BUSINESS AND THE LIKE), EVEN IF ASUS HAS BEEN ADVISED OF THE POSSIBILITY OF SUCH DAMAGES ARISING FROM ANY DEFECT OR ERROR IN THIS MANUAL OR PRODUCT.

SPECIFICATIONS AND INFORMATION CONTAINED IN THIS MANUAL ARE FURNISHED FOR INFORMATIONAL USE ONLY, AND ARE SUBJECT TO CHANGE AT ANY TIME WITHOUT NOTICE, AND SHOULD NOT BE CONSTRUED AS A COMMITMENT BY ASUS. ASUS ASSUMES NO RESPONSIBILITY OR LIABILITY FOR ANY ERRORS OR INACCURACIES THAT MAY APPEAR IN THIS MANUAL, INCLUDING THE PRODUCTS AND SOFTWARE DESCRIBED IN IT.

Products and corporate names appearing in this manual may or may not be registered trademarks or copyrights of their respective companies, and are used only for identification or explanation and to the owners' benefit, without intent to infringe.

Table of contents

Notices	vi
Safety information	vii
About this guide	viii
System package contents	x

Chapter 1: System introduction

1.1 Welcome!	1-2
1.2 Front panel	1-2
1.3 Rear panel	1-4
1.4 Internal components	1-6

Chapter 2: Basic installation

2.1 Preparation	2-2
2.2 Before you proceed	2-2
2.3 Removing the cover	2-3
2.4 Detaching the drive frame	2-4
2.5 Installing a CPU	2-6
2.6 Installing the fan and heatsink assembly	2-8
2.7 Installing system memory	2-10
2.7.1 Memory configurations	2-10
2.7.2 DIMM installation	2-11
2.8 Installing an expansion card	2-12
2.8.1 Expansion slots	2-12
2.8.2 Expansion card installation	2-13
2.8.3 Configuring an expansion card	2-13
2.8.4 Standard interrupt assignments	2-14
2.8.5 IRQ assignments for this motherboard	2-14
2.9 Installing a CD-ROM drive	2-15
2.10 Installing a hard disk drive	2-17
2.11 Reconnecting cables	2-19
2.11.1 LED cables	2-19
2.11.2 UAEX module	2-20
2.12 Replacing the cover	2-21

Table of contents

2.13	Connecting external devices	2-23
2.14	Power supply specifications	2-24
2.14.1	Input Characteristics	2-24
2.14.2	Output Characteristics	2-24
2.14.3	Over-Voltage Protection (OVP)	2-24

Chapter 3: Starting up

3.1	Installing an operating system	3-2
3.2	Support CD information	3-2
3.2.1	Running the support CD	3-2
3.2.2	Utilities menu	3-3
3.2.3	ASUS Contact information	3-4
3.2.4	Other information	3-5
3.3	Software information	3-7
3.3.1	ASUS PC Probe	3-7
3.3.2	ASUS Update	3-11

Chapter 4: Motherboard info

4.1	Introduction	4-2
4.2	Motherboard layout	4-2
4.3	Jumpers	4-3
4.4	Connectors	4-6

Chapter 5: BIOS information

5.1	Managing and updating your BIOS	5-2
5.1.1	Creating a bootable floppy disk	5-2
5.1.2	Updating the BIOS using the AwardBIOS Flash Utility	5-3
5.1.3	Recovering the BIOS with CrashFree BIOS	5-6
5.1.4	ASUS Update	5-7
5.2	BIOS Setup program	5-8
5.2.1	BIOS menu bar	5-9
5.2.2	Legend bar	5-9

Table of contents

5.3	Main Menu	5-11
5.3.1	System Time	5-11
5.3.2	System Date	5-11
5.3.3	Legacy Diskette A	5-11
5.3.4	Installed Memory	5-11
5.3.5	Primary and Secondary Master/Slave	5-12
5.4	Advanced Menu	5-13
5.4.1	CPU configuration	5-14
5.4.2	Memory configuration	5-15
5.4.3	Chipset configuration	5-16
5.4.4	PCIPnP	5-18
5.4.5	Onboard device configuration	5-19
5.4.6	USB configuration	5-21
5.5	Power Menu	5-22
5.5.1	APM configuration	5-23
5.5.2	Hardware monitor	5-26
5.6	Boot Menu	5-28
5.6.1	Boot Device Priority	5-28
5.6.2	Removable drives	5-29
5.6.3	Hard Disk Drives	5-29
5.6.4	CD-ROM drives	5-30
5.6.5	Boot settings configuration	5-30
5.6.6	Security	5-32
5.7	Exit menu	5-33

Notices

Federal Communications Commission Statement

This device complies with Part 15 of the FCC Rules. Operation is subject to the following two conditions:

- This device may not cause harmful interference, and
- This device must accept any interference received including interference that may cause undesired operation.

This equipment has been tested and found to comply with the limits for a Class B digital device, pursuant to Part 15 of the FCC Rules. These limits are designed to provide reasonable protection against harmful interference in a residential installation. This equipment generates, uses and can radiate radio frequency energy and, if not installed and used in accordance with manufacturer's instructions, may cause harmful interference to radio communications. However, there is no guarantee that interference will not occur in a particular installation. If this equipment does cause harmful interference to radio or television reception, which can be determined by turning the equipment off and on, the user is encouraged to try to correct the interference by one or more of the following measures:

- Reorient or relocate the receiving antenna.
- Increase the separation between the equipment and receiver.
- Connect the equipment to an outlet on a circuit different from that to which the receiver is connected.
- Consult the dealer or an experienced radio/TV technician for help.



WARNING! The use of shielded cables for connection of the monitor to the graphics card is required to assure compliance with FCC regulations. Changes or modifications to this unit not expressly approved by the party responsible for compliance could void the user's authority to operate this equipment.

Canadian Department of Communications Statement

This digital apparatus does not exceed the Class B limits for radio noise emissions from digital apparatus set out in the Radio Interference Regulations of the Canadian Department of Communications.

This class B digital apparatus complies with Canadian ICES-003.

Safety information

Electrical safety

- To prevent electrical shock hazard, disconnect the power cable from the electrical outlet before relocating the system.
- When adding or removing devices to or from the system, ensure that the power cables for the devices are unplugged before the signal cables are connected.
- If the power supply is broken, do not try to fix it by yourself. Contact a qualified service technician or your retailer.

Operation safety

- Before installing devices into the system, carefully read all the documentation that came with the package.
- Before using the product, make sure all cables are correctly connected and the power cables are not damaged. If you detect any damage, contact your dealer immediately.
- To avoid short circuits, keep paper clips, screws, and staples away from connectors, slots, sockets and circuitry.
- Avoid dust, humidity, and temperature extremes. Do not place the product in any area where it may become wet. Place the product on a stable surface.
- If you encounter technical problems with the product, contact a qualified service technician or your retailer.

Lithium-Ion Battery Warning

CAUTION: Danger of explosion if battery is incorrectly replaced. Replace only with the same or equivalent type recommended by the manufacturer. Dispose of used batteries according to the manufacturer's instructions.

VORSICHT: Explosionsgefahr bei unsachgemäßen Austausch der Batterie. Ersatz nur durch denselben oder einem vom Hersteller empfohlenem ähnlichen Typ. Entsorgung gebrauchter Batterien nach Angaben des Herstellers.

LASER PRODUCT WARNING

CLASS 1 LASER PRODUCT

About this guide

Audience

This guide provides general information and installation instructions about the ASUS Terminator 1 barebone system. This guide is intended for experienced users and integrators with hardware knowledge of personal computers.

How this guide is organized

This guide contains the following parts:

1. Chapter 1: System introduction

This chapter gives a general description of the ASUS Terminator 1. The chapter lists the system features, including introduction on the front and rear panel, and internal components.

2. Chapter 2: Basic installation

This chapter provides step-by-step instructions on how to install components in the system.

3. Chapter 3: Starting up

This chapter helps you power up the system and install drivers and utilities from the support CD.

4. Chapter 4: Motherboard information

This chapter gives information about the motherboard that comes with the system. This chapter includes the motherboard layout, jumper settings, and connector locations.

5. Chapter 5: BIOS information

This chapter tells how to change system settings through the BIOS Setup menus and describes the BIOS parameters.

Conventions used in this guide



WARNING: Information to prevent injury to yourself when trying to complete a task.



CAUTION: Information to prevent damage to the components when trying to complete a task.



IMPORTANT: Instructions that you **MUST** follow to complete a task.



NOTE: Tips and additional information to aid in completing a task.

Where to find more information

Refer to the following sources for additional information and for product and software updates.

1. ASUS Websites

The ASUS websites worldwide provide updated information on ASUS hardware and software products. Refer to the ASUS contact information.

2. Optional Documentation

Your product package may include optional documentation, such as warranty flyers, that may have been added by your dealer. These documents are not part of the standard package.

System package contents

Check your Terminator 1 system package for the following items.



If any of the items is damaged or missing, contact your retailer immediately.

Item description
1. ASUS Terminator 1 barebone system with
• ASUS motherboard
• 165 W PFC/non-PFC power supply unit
• 2 x 5.25" drive bays
• 1 x 3.5" hard disk drive bay
• 4 x USB 2.0 ports
2. Cable
• AC power cable and plug
3. Support CD
4. User guide
5. Optional items
• 1 x Floppy disk drive
• CPU fan and heatsink assembly
• Optical drive (<i>CD-ROM/CD-RW/DVD-ROM/DVD-RW</i>)

Chapter 1

This chapter gives a general description of the ASUS Terminator 1 A7VT400. The chapter lists the system features including introduction on the front and rear panel, and internal components.



ASUS Terminator 1 A7VT400

System introduction

1.1 Welcome!

Thank you for choosing the ASUS Terminator 1 A7VT400!

The ASUS Terminator 1 A7VT400 is an all-in-one barebone system with a versatile home entertainment feature.

The system comes in a stylish mini-tower casing, and is powered by the ASUS motherboard that supports AMD Sempron™ processors.

1.2 Front panel

The ASUS Terminator 1 A7VT400 barebone system is composed of the ASUS motherboard and a power supply unit in the ASUS TriOptix form factor chassis.



The CD-ROM drive and the floppy disk drive are optional items.

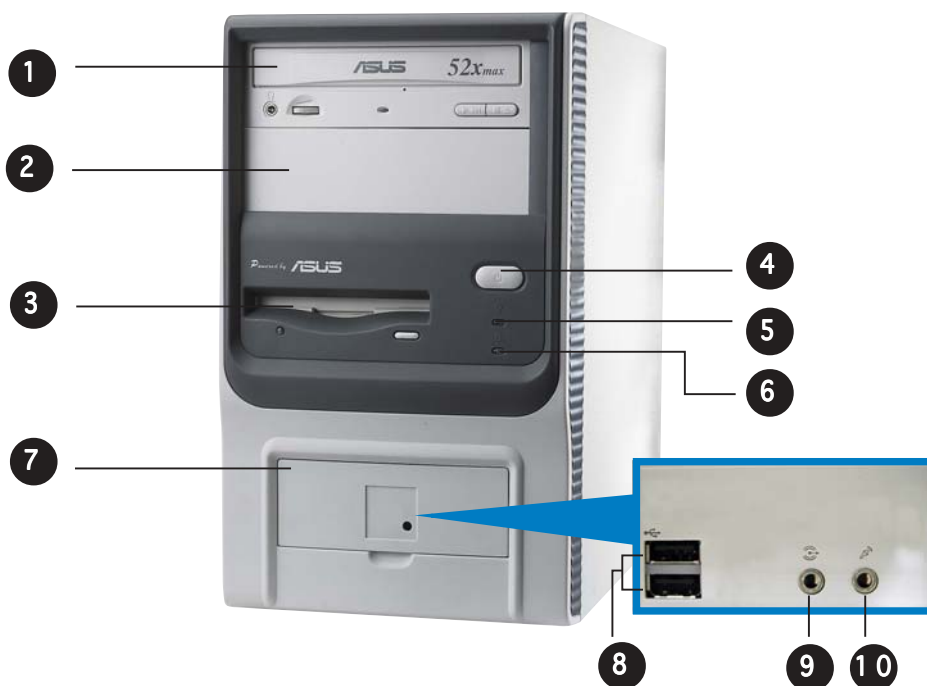

1. **Optical drive.** This is an optional IDE optical drive.
2. **Empty 5.25-inch drive bay.** This covered slot is for a second optical drive or other 5.25-inch storage devices.
3. **Floppy drive door.** This is for an optional 1.44 MB, 3.5-inch floppy disk drive.

4. **Power button.** Press this button to turn the system on.
5. **Power LED.** This LED lights up to indicate that the system is ON.
6. **HDD LED.** This LED lights up when data is being read from or written to the hard disk drive.
7. **Front panel I/O door.** Flip up this door to show the front panel input/output ports.
8. **USB 2.0 ports.** These Universal Serial Bus 2.0 (USB 2.0) ports are available for connecting USB 2.0 devices such as a mouse, printer, scanner, camera, PDA, and others.
9. **Headphone port.** This port connects a headphone with a stereo mini-plug.
10. **Microphone port.** This Mic (pink) port connects a microphone.

1.3 Rear panel

The system rear panel includes the power socket and several I/O ports that allow convenient connection of devices.

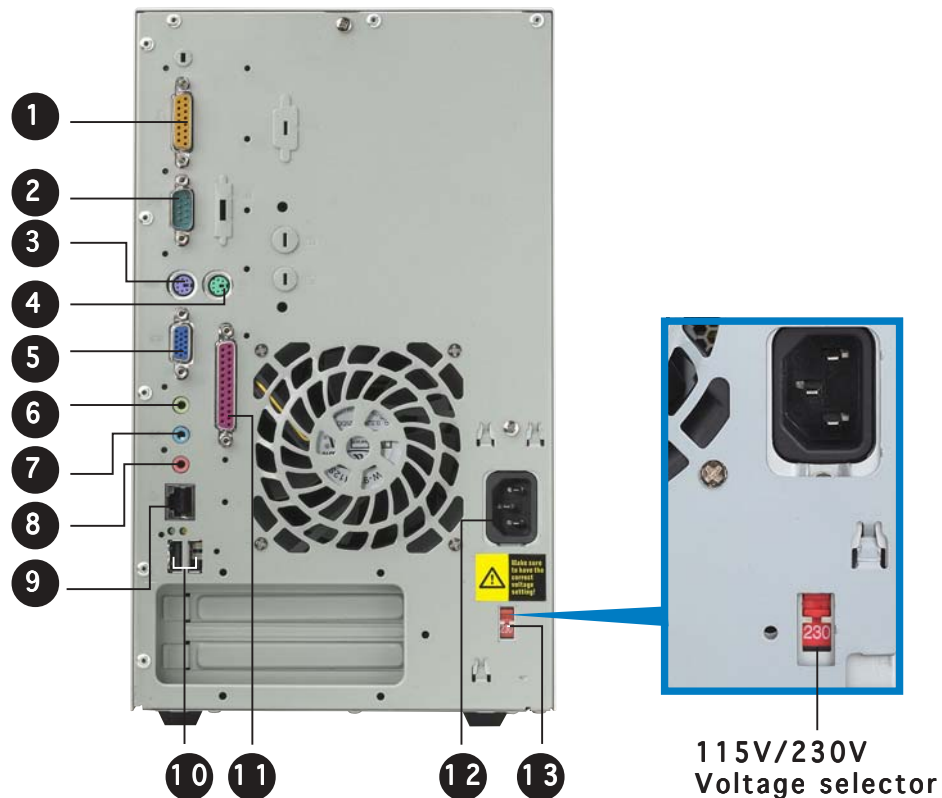

1. **GAME/MIDI port.** This port connects a joystick or game pad for playing games, and MIDI devices for audio editing.
2. **Serial port.** This port connects a mouse, modem, or other devices that conform with serial specification.
3. **PS/2 mouse port.** This green 6-pin connector is for a PS/2 mouse.
4. **PS/2 keyboard port.** This purple 6-pin connector is for a PS/2 keyboard.
5. **VGA port.** This port connects a VGA monitor.
6. **Line Out port.** This Line Out (lime) port connects a headphone or a speaker. In 4/6-channel mode, the function of this port becomes Front Speaker Out.
7. **Line In port.** This Line In (light blue) port connects a tape player or other audio sources. In 6-channel mode, the function of this port becomes Low Frequency Enhanced Output/Center.

- 8. Microphone port.** This Microphone (pink) port connects a microphone. In 4/6-channel mode, the function of this port becomes Surround Speaker.



The functions of the Line Out (lime), Line In (blue), and Mic (pink) ports on the rear panel change when you select the 4-channel or 6-channel audio configuration as shown in the following table.

Audio ports function variation

Port	Headphone/ 2-Channel	4-Channel	6-Channel
Light Blue	Line In	Line In	LFE Output*/Center
Lime	Line Out	Front Speaker Out	Front Speaker Out
Pink	Mic In	Surround	Surround

* LFE Output: Low Frequency Enhanced Output



Windows® 98 SE only supports 4.1-channel speaker setting.

- 9. LAN (RJ-45) port.** This port allows connection to a Local Area Network (LAN) through a network hub.
- 10. USB 2.0 ports.** These Universal Serial Bus 2.0 (USB 2.0) ports are available for connecting USB 2.0 devices such as a mouse, printer, scanner, camera, PDA, and others.
- 11. Parallel port.** This 25-pin port connects a printer, scanner, or other devices.
- 12. Power socket.** This socket connects the power cable and plug.
- 13. Voltage selector.** This switch allows you to select the appropriate voltage supply in your area.

Voltage Selector

The switching power supply that came with the system has a voltage selector switch below the power socket. Use this switch to select the appropriate voltage according to the voltage supply in your area.

If the voltage supply in your area is 100-127 V, set the switch to 115 V.

If the voltage supply in your area is 200-240 V, set the switch to 230 V.



Setting the switch to 115 V in a 230 V environment will seriously damage the system!

1.4 Internal components

The figure below shows the internal view of the system when you remove the cover and flip out the drive frame. The standard components already installed in the system and the locations of the available drive bays are pointed out.



The system may come with either a PFC (Power Factor Correction) or non-PFC power supply.

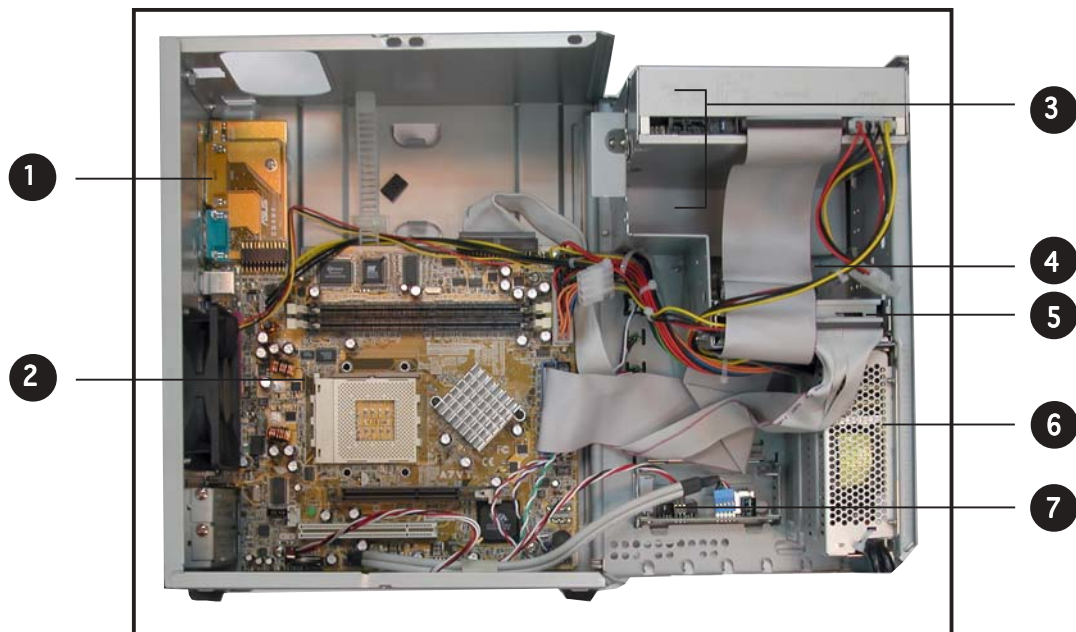

- | | |
|---|---|
| 1. Game/MIDI/COM1 extension module | 4. 3.5" HDD drive bay |
| 2. Motherboard | 5. 3.5" floppy drive bay (Optional floppy disk drive) |
| 3. Two 5.25" drive bays (Optional CD-ROM) | 6. PFC/Non-PFC power supply |
| | 7. USB/audio board |

Chapter 2

This chapter gives step-by-step instructions on how to install components into the barebone system.



ASUS Terminator 1 A7VT400

Basic installation

2.1 Preparation

Before you proceed, make sure that you have all the components that you plan to install in the system.

Basic components to install

1. Central processing unit (CPU)
2. DDR Dual Inline Memory Module (DIMM)
3. Expansion card(s)
4. Hard disk drive
5. Optical drive

Tool

Phillips (cross) screw driver

2.2 Before you proceed

Take note of the following precautions before you install components into the system.



- Use a grounded wrist strap or touch a safely grounded object or a metal object, such as the power supply case, before handling components to avoid damaging them due to static electricity.
- Hold components by the edges to avoid touching the ICs on them.
- Whenever you uninstall any component, place it on a grounded antistatic pad or in the bag that came with the component.

The motherboard comes with an onboard standby power LED. This LED lights up to indicate that the system is ON, in sleep mode or in soft-off mode, and not powered OFF. Unplug the power cable from the power outlet and make sure that the standby power LED is OFF before installing any system component.

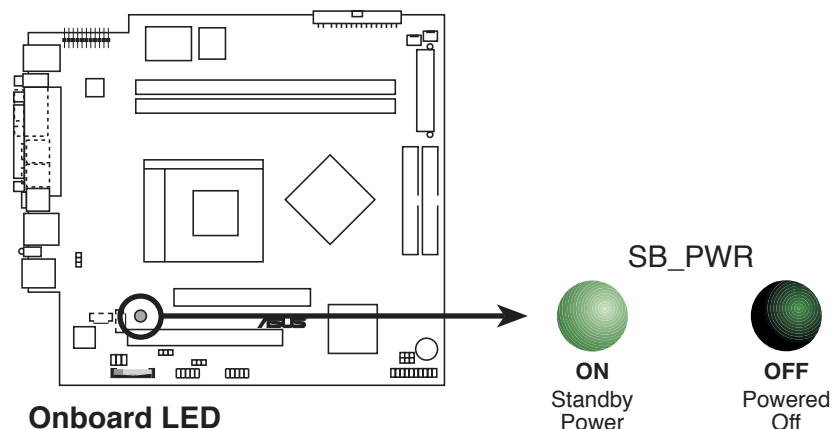

2.3 Removing the cover

The chassis cover is secured by a screw located on the rear panel.

To remove the chassis cover:

1. Turn the screw counterclockwise to release the cover. Set the screw aside.



Screw

2. Place your hands on both corners of the front panel, just beside the CD-ROM frame. Push on the CD-ROM area with your thumbs until the cover tilts forward.



TIP

Another way to release the cover is to place your hands underneath the front panel edge, then push the inner chassis with your thumbs while pulling the panel with your other fingers.

3. While supporting the front panel with one hand, place your other hand on the top rear edge of the cover and carefully lift the cover from the chassis.



2.4 Detaching the drive frame

To detach the drive frame:

1. Place the chassis on a flat surface and turn it on its side.



2. The power socket and voltage selector switch are attached to a metal module secured to the rear panel by a screw. Remove the screw to release the power socket module.

Power socket module screw



Power socket module

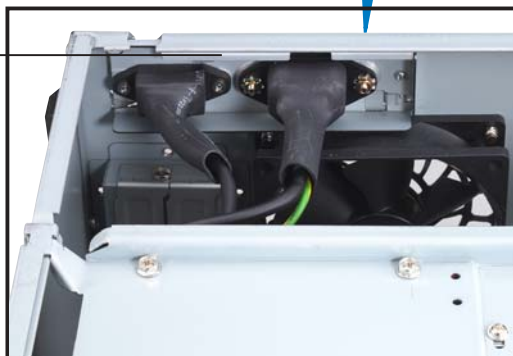

You must release the power socket module from the rear panel before detaching the drive frame to avoid breaking the power cable.

3. Place your thumb on the right edge of the power socket module, then slide the module to the right until it is completely detached from the rear panel.



4. Unlatch the drive frame by pulling it outward.

Drive frame

Swivel edge



The drive frame has a swivel (hinge-like) edge that is attached to the main chassis. You do not have to completely detach the drive frame from the chassis when installing components.

5. Carefully lay the drive frame alongside the main chassis frame.

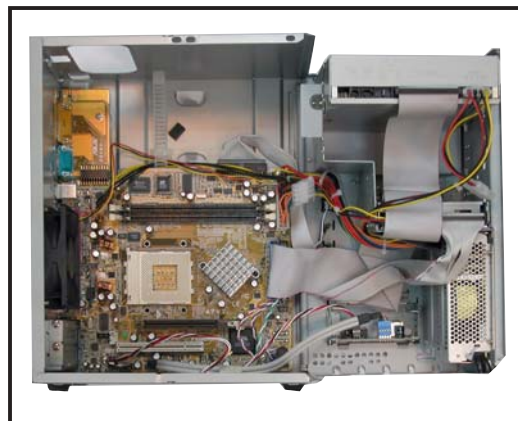

2.5 Installing a CPU

The motherboard comes with a surface mount 462-pin Zero Insertion Force (ZIF) socket designed for the AMD Sempron™ processor.

Take note of the marked corner (with gold triangle) on the CPU. This mark should match a specific corner on the socket to ensure correct installation.

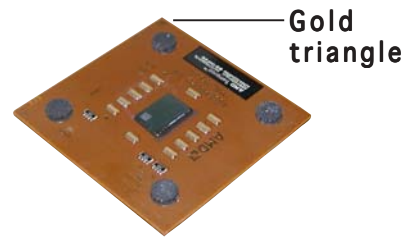

CPU installation

To install the CPU:

1. Locate the 462-pin ZIF socket on the motherboard.

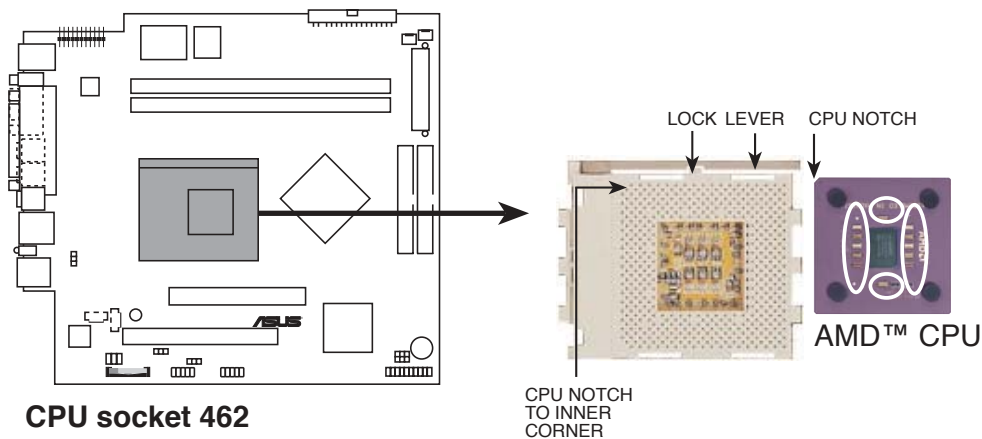

2. Unlock the socket by pressing the lever sideways, then lift it up to a 90°-100° angle.

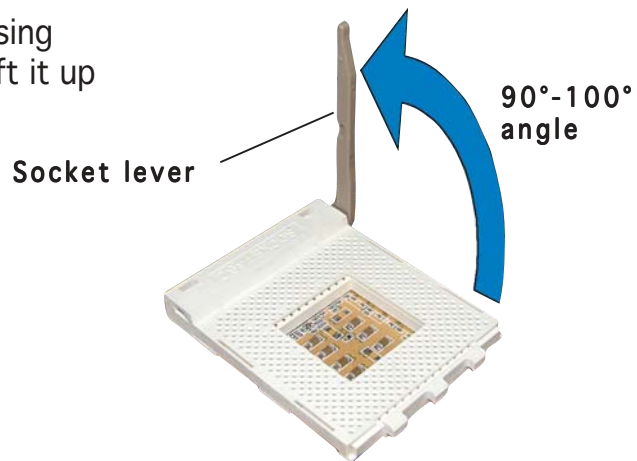

Make sure that the socket lever is lifted up to a 90°-100° angle; otherwise, the CPU does not fit in completely.

3. Position the CPU above the socket such that the CPU corner with the gold triangle matches the base of the socket lever.
4. Carefully insert the CPU into the socket until it fits in place.

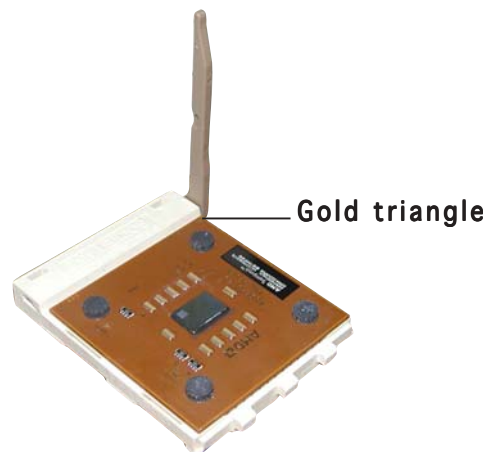

The CPU fits only in one correct orientation. DO NOT force the CPU into the socket to prevent bending the pins and damaging the CPU!

5. When the CPU is in place, push down the socket lever to secure the CPU. The lever clicks on the side tab to indicate that it is locked.

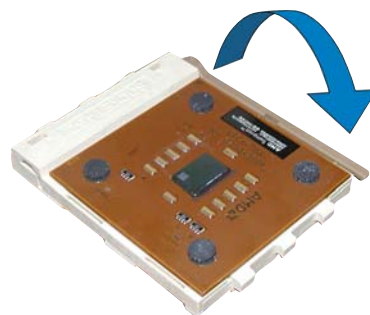

2.6 Installing the fan and heatsink assembly



The CPU fan and heatsink assembly is an optional item in the Terminator 1 barebone system package.

The processor requires a CPU fan and heatsink assembly to ensure optimum thermal condition and system performance.



- Make sure that you properly install the CPU fan and heatsink to avoid thermal problems.
 - Use only AMD-certified fan and heatsink assembly.
 - Make sure that you have installed the motherboard to the chassis before you install the CPU fan and heatsink.
-

To install the CPU fan and heatsink:

1. Position the fan and heatsink assembly on top of the installed CPU such that the heatsink fins are perpendicular to the DDR sockets and PCI slots.
2. Align one end of the heatsink bracket to the protruding tabs on the CPU socket. Hook the holes of the bracket to the protruding tabs, making sure that they fit properly.



Socket tabs matched to the holes on the heatsink bracket

- Using a flat screwdriver, carefully hook the other end of the heatsink bracket to the tabs on the base of the CPU socket. This secures the fan and heatsink assembly.



- Connect the CPU fan cable from the assembly to the fan connector labeled CPU_FAN1.

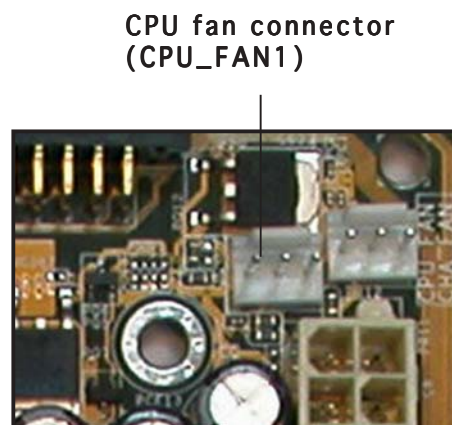

2.7 Installing system memory

The motherboard comes with two Double Data Rate (DDR) Dual Inline Memory Module (DIMM) sockets. These sockets support up to 2 GB system memory using unbuffered ECC or non-ECC PC2700/PC2100/PC1600 DIMMs.

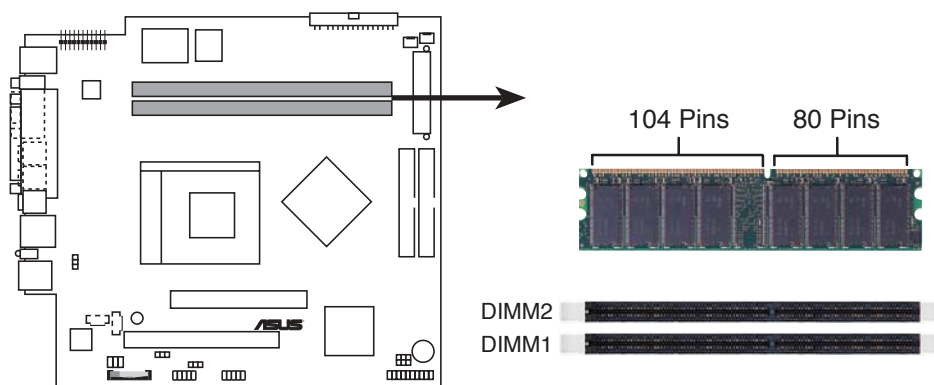

184-Pin DDR DIMM sockets

2.7.1 Memory configurations

You may install any DDR DIMMs with 64 MB, 128 MB, 256 MB, 512 MB, and 1 GB densities into the DIMM sockets.

Memory frequency/CPU FSB synchronization

CPU FSB	DDR DIMM Type	Memory Frequency
100 MHz	PC2100/PC1600	266/200 MHz
133MHz	PC2700/PC2100/PC1600	333/266/200 MHz
166 MHz	PC2700/PC2100/PC1600	333/266/200 MHz
200 MHz	PC2700/PC2100/PC1600	333/266/200 MHz



- When using 100 MHz CPU FSB, any DDR DIMM you installed may run only at a maximum of 266 MHz due to chipset limitation.
- If you are using CPU FSB other than 100 MHz and installed 400 MHz DDR DIMMs, the memory frequency downgrades to 333 MHz.

2.7.2 DIMM installation

To install a DDR DIMM:

1. Locate the two DIMM sockets on the motherboard.

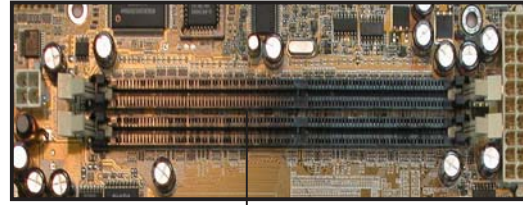

DDR DIMM sockets

2. Unlock a socket by pressing the retaining clips outward.
3. Align a DIMM on the socket such that the notch on the DIMM matches the break on the socket.

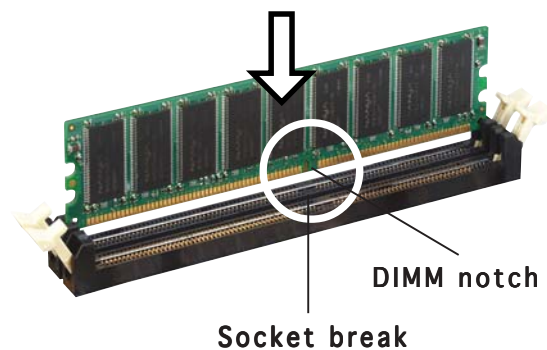

4. Firmly insert the DIMM into the socket until the retaining clips snap back in place and the DIMM is properly seated.

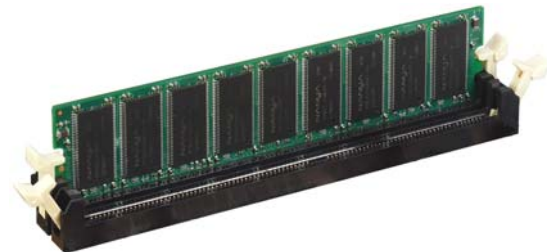

A DDR DIMM is keyed with a notch so that it fits in only one direction. DO NOT force a DIMM into a socket to avoid damaging the DIMM.

2.8 Installing an expansion card

In the future, you may need to install expansion cards. The motherboard has one 32-bit PCI slot and one Accelerated Graphic Port (AGP) slot. The following sub-sections describe the slots and the expansion cards that they support.

2.8.1 Expansion slots

PCI slot

The PCI slot supports PCI slots such as a LAN card, SCSI card, USB card, and other cards that comply with PCI specifications

AGP slot

The AGP slot supports AGP 8x cards. When you buy an AGP card, make sure that you ask for one with 1.5V specification.



Install only +1.5V AGP cards. The motherboard does not support 3.3V AGP cards.



Make sure to unplug the power cord before adding or removing expansion cards. Failure to do so may cause you physical injury and damage the motherboard.

2.8.2 Expansion card installation

To install a PCI or AGP card.

1. Place the chassis on its side.
2. Remove the metal bracket opposite the slot that you wish to use.
3. Align the card golden fingers to the slot and its metal bracket to the slot opening on the chassis.
4. Press the card firmly until it is properly seated on the slot.
5. Secure the card to the chassis with a bracket screw.

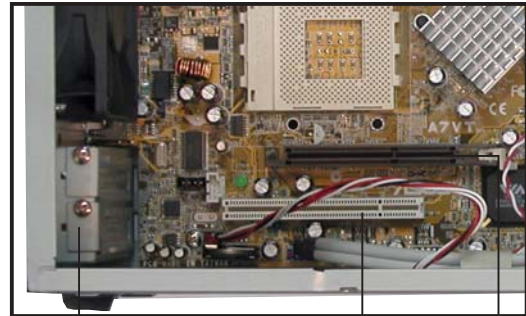

Metal bracket

PCI slot (PCI1)

AGP slot (AGP1)

2.8.3 Configuring an expansion card

After installing the expansion card, configure it by adjusting the software settings.

1. Turn on the system and change the necessary BIOS settings, if any. See Chapter 5 for information on BIOS setup.
2. Install the software drivers for the expansion card.

2.8.4 Standard interrupt assignments

IRQ	Priority	Standard Function
0	1	System Timer
1	2	Keyboard Controller
2	N/A	Programmable Interrupt
3*	11	USB Universal Host Controller
4*	12	Communications Port (COM1)
5*	13	USB Enhanced Host Controller
6	14	Standard Floppy Disk Controller
7*	15	Printer Port (LPT1)
8	3	System CMOS/Real Time Clock
9*	4	ACPI Mode when used
10*	5	Multimedia Device
11*	6	Network Controller
12*	7	PS/2 Compatible Mouse Port
13	8	Numeric Data Processor
14*	9	Primary IDE Channel
15*	10	Secondary IDE Channel

* These IRQs are usually available for ISA or PCI devices.

2.8.5 IRQ assignments for this motherboard

	A	B	C	D	E	F	G	H
PCI slot	—	used	—	—	—	—	—	—
AGP slot	used	—	—	—	—	—	—	—
USB 1.1 UHCI 1	—	—	—	—	shared	—	—	—
USB 1.1 UHCI 1	—	—	—	—	—	used	—	—
USB 1.1 UHCI 1	—	—	—	—	—	—	shared	—
USB 2.0 EHCI	—	—	—	—	—	—	—	used
Onboard Audio	—	—	—	—	—	—	shared	—
Onboard LAN	—	—	—	—	shared	—	—	—

2.9 Installing a CD-ROM drive

A CD-ROM drive is an optional item in this barebone system. Refer to the instructions in this section if you acquired a model without a CD-ROM.

To install a CD-ROM drive:

1. Place the chassis upright.
2. Insert the CD-ROM drive into the upper 5.25-inch drive bay.



5.25-inch drive bay

3. Carefully push the CD-ROM drive into the bay until its screw holes align with the holes on the bay as shown.
4. Secure the CD-ROM with two screws on each side of the bay.



CD-ROM screws

5. Connect a power cable from the power supply to the power connector at the back of the CD-ROM. Use the cable with the white connector labeled P1.
6. Connect one end of the IDE ribbon cable to the IDE interface at the back of the CD-ROM, matching the red stripe on the cable with Pin 1 on the IDE interface.
7. Connect one end of the CD-ROM audio cable to the 4-pin connector at the back of the CD-ROM.



CD-ROM audio cable
 IDE ribbon cable
 Red stripe to Pin 1
 Power cable (P1)

8. Connect the other end of the IDE ribbon cable to the secondary IDE connector (black connector labeled SEC_IDE) on the motherboard.

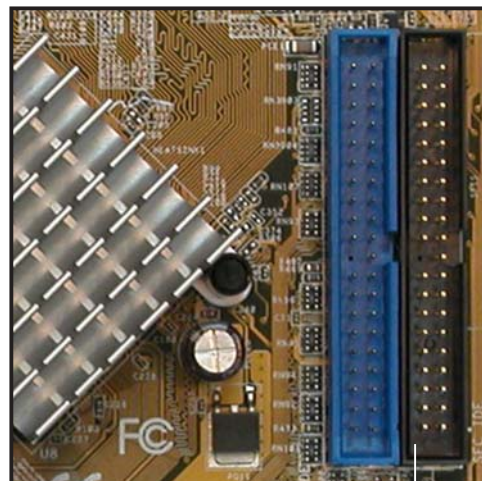

Secondary IDE connector (SEC_IDE)

9. Connect the other end of the audio cable to the black 4-pin connector labeled CD on the motherboard.

CD-ROM connector (CD)

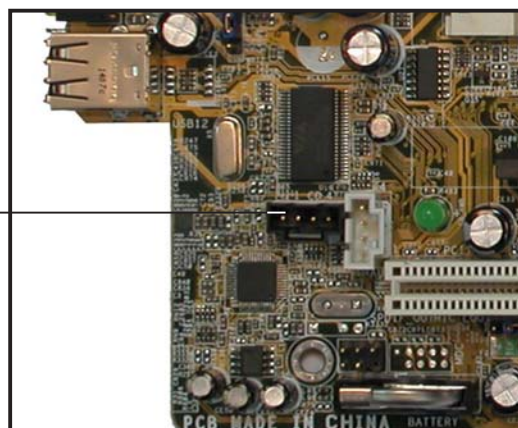

2.10 Installing a hard disk drive

The chassis has one 3.5-inch hard disk drive (HDD) bay right under the 5.25-inch bay. The following figures show the internal and external views of the HDD bay location.

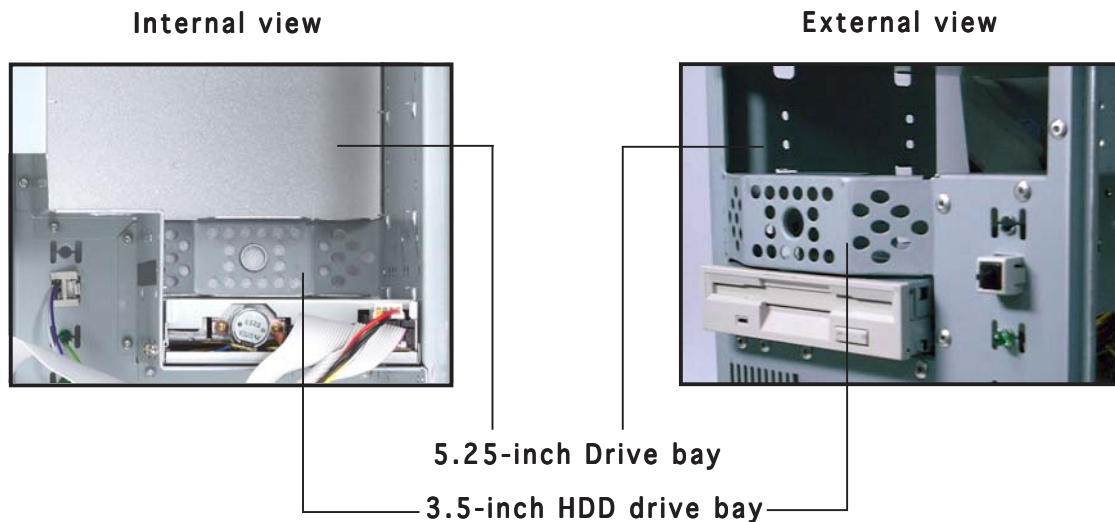

To install an IDE HDD:

1. Place the chassis upright.
2. With the HDD label side up, carefully insert the drive into the 3.5-inch bay.

HDD label side



3. Push the drive into the bay until its screw holes align with the holes on the bay marked HDD.
4. Secure the drive with two screws on each side of the bay.

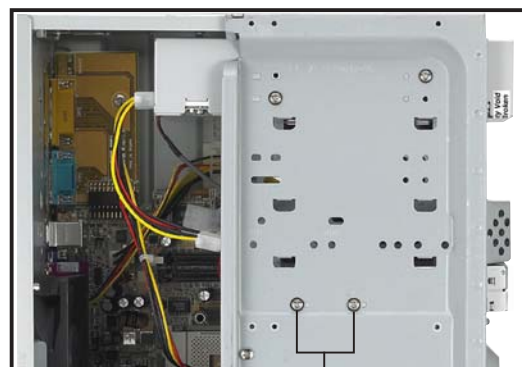

HDD screws

5. Connect a power cable from the power supply to the power connector at the back of the HDD. Use the cable with the white connector labeled P3.
6. Connect one end of the IDE hard disk ribbon cable to the IDE interface at the back of the HDD, matching the red stripe on the cable with Pin 1 on the IDE interface.



Red stripe to Pin 1
IDE ribbon cable Power cable (P3)

7. Connect the other end of the IDE ribbon cable to the primary IDE connector (blue connector labeled PRI_IDE) on the motherboard.

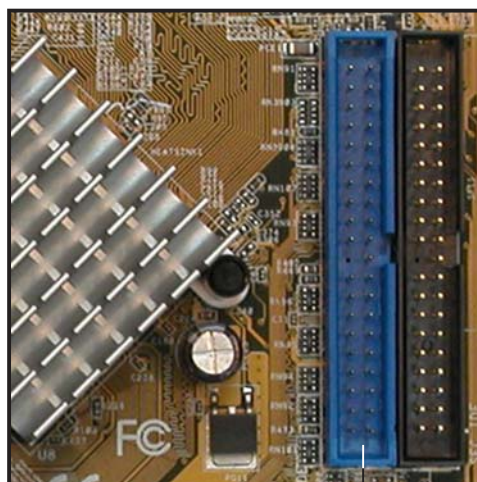

Primary IDE connector (PRI_IDE)

2.11 Reconnecting cables

You may have disconnected some cables when you were installing components. You must reconnect these cables before you replace the chassis cover.

2.11.1 LED cables

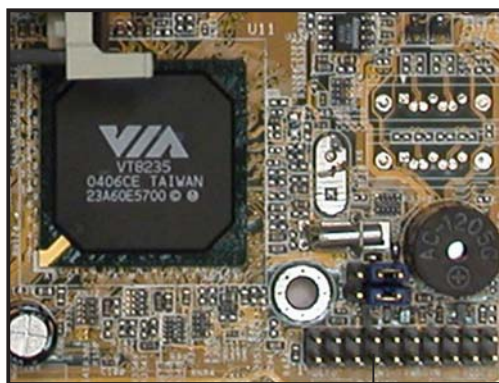
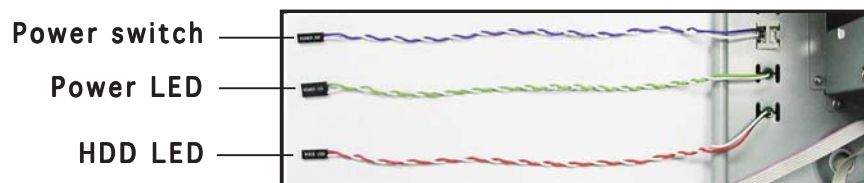

PANEL

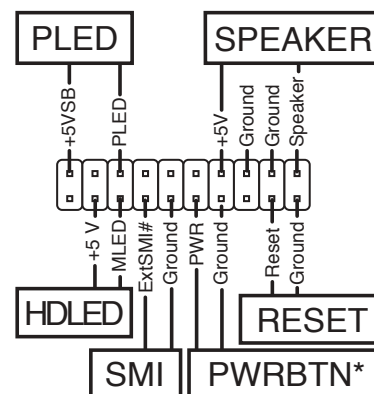

* Requires an ATX power supply.

- Connect the **power switch** and **power LED** cables to their respective leads in the PANEL connector on the motherboard.
- Connect the **HDD LED** cable to the 2-pin lead marked HDLED.

2.11.2 UAEX module

The system front I/O panel has a UAEX module that contains the front panel I/O ports and the connectors to the motherboard.

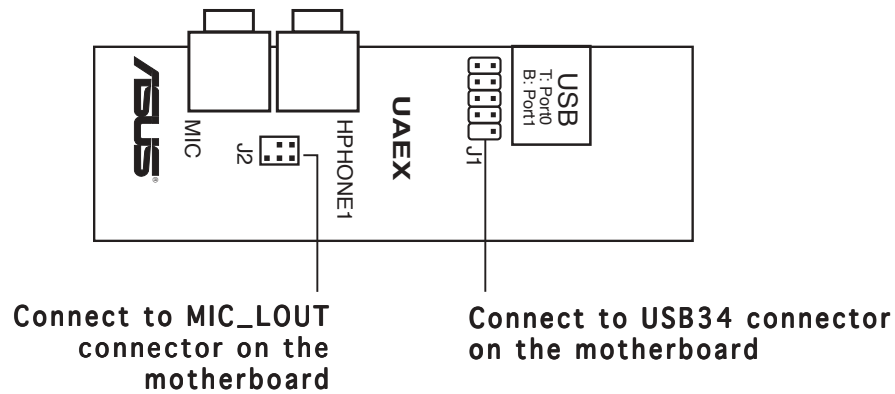

Connector locations on the motherboard

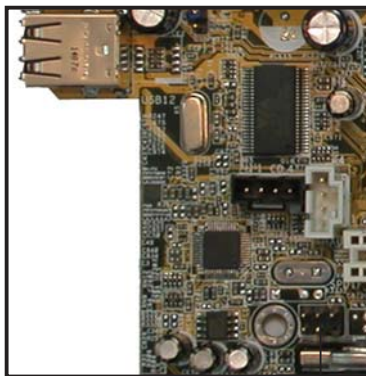

MIC_LOUT connector
(for Microphone/
Line Out cable)

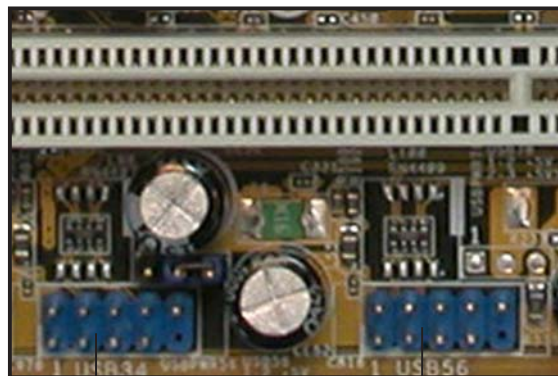

USB34

USB56

2.12 Replacing the cover

After you have installed all the internal components and you have connected all the necessary cables, you are now ready to put the system back together.

To re-assemble the system:

1. With the chassis lying on its side, hook the swivel edge of the drive frame to the main chassis.
2. Sway the drive frame inward until it fits completely. The protruding tabs on both ends of the drive frame should snap perfectly to the chassis edge.



Protruding tab

3. Turn the chassis upright.
4. Place the cover over the chassis leaving about two inches from the rear panel.



5. Fit the rail tabs on the sides and bottom of the cover to the edges of the chassis.

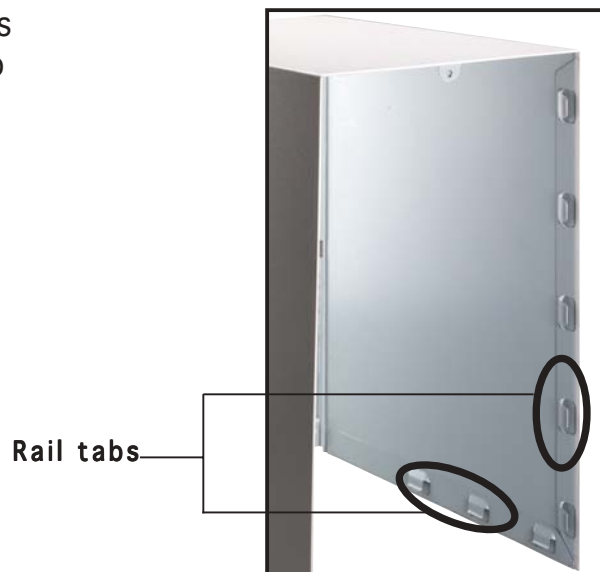

6. Push the cover towards the rear until it fits. The locking tab snaps into the hole on the chassis indicating that the cover is in place.



Firmly push the cover to ensure that it is fully engaged to the chassis.

7. Lock the cover with the screw on the rear panel.

2.13 Connecting external devices

The figure below shows the specific connectors and devices that you can connect to the rear panel ports.

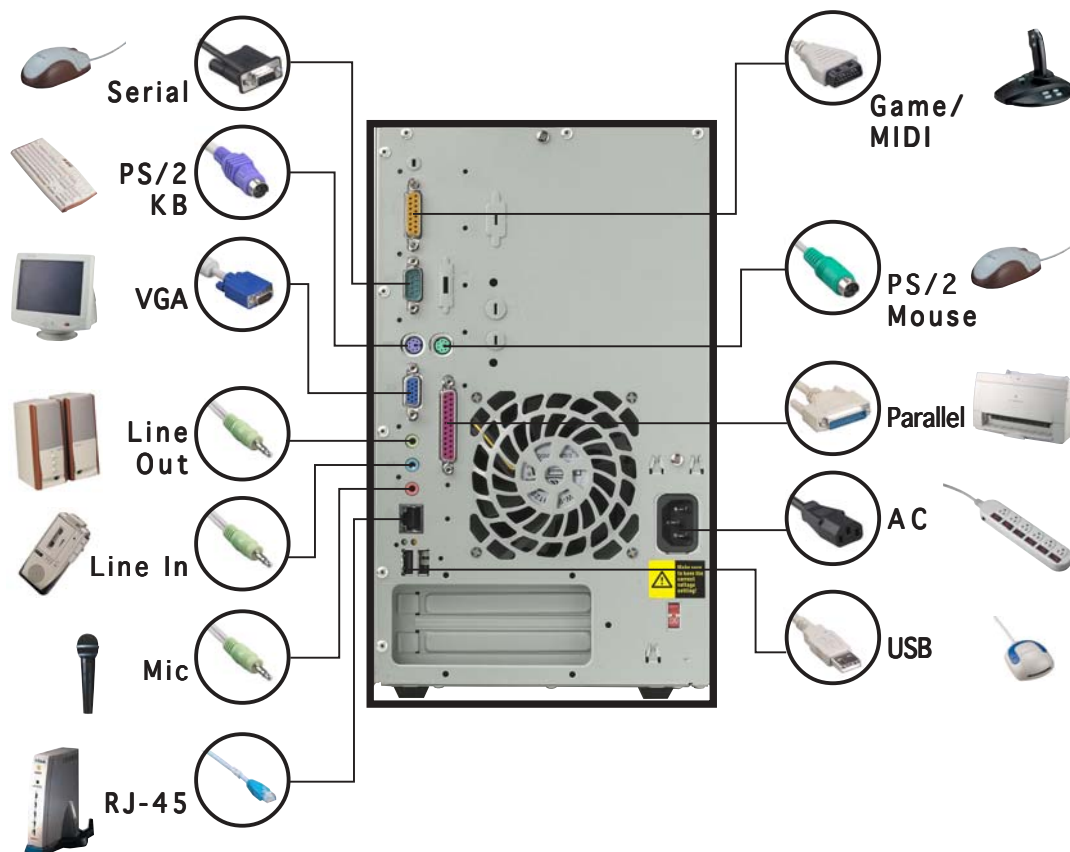

2.14 Power supply specifications

2.14.1 Input characteristics

Input Voltage Range	Min	Nom	Max
Range 1	90 V	115 V	135V
Range 2	180 V	230 V	265V
Input Frequency Range	47 Hz to 63 Hz		
Maximum Input ac Current	4 A max. at 115 Vac 2 A max. at 230 Vac, maximum load		
Inrush Current	90 A max. at 115 Vac, full load cold start at 25°C		
Efficiency	70% min. at nominal input, maximum load		

2.14.2 Output characteristics

Output Voltage	Load Range		Regulation		Ripple
	Min	Max	Min	Max	Max
+5 V	0.5 A	4.0 A	-5%	+5%	50mVp-p
+12 V	0.45 A	9.5 A	-5%	+5%	120mVp-p
-12 V	0 A	0.2 A	-10%	+10%	120mVp-p
+5 VSB	0.05 A	1.5 A	-5%	+5%	50mVp-p
+3 V3	1 A	8.0 A	-5%	+5%	50mVp-p

2.14.3 Over-Voltage Protection (OVP)

Output Voltage	Maximum Voltage
+5 V	6.5 V
+12 V	15.6 V
+3.3 V	4.3 V



The power supply will shut down and latch off for shorting +5V, +12V, -12V, or +3.3V. By shorting +5VSB, the power supply can latch down or automatically recover when the fault condition is removed.

Chapter 3

This chapter helps you power up your system and install drivers and utilities that came with the support CD.



ASUS Terminator 1 A7VT400

Starting up

3.1 Installing an operating system

The ASUS motherboard that comes with this barebone system supports Windows® 98/ME/NT/2000/XP operating systems (OS). Always install the latest OS version and corresponding updates so you can maximize the features of your hardware.



Because motherboard settings and hardware options vary, use the setup procedures presented in this chapter for general reference only. Refer to your OS documentation for more information.

3.2 Support CD information

The support CD that came with the motherboard contains useful software and several utility drivers that enhance the motherboard features.



The contents of the support CD are subject to change at any time without notice. Visit the ASUS website for updates.

3.2.1 Running the support CD

To begin using the support CD, simply insert the CD into your CD-ROM drive. If Autorun is enabled in your computer, the Utilities menu automatically appears on your screen.

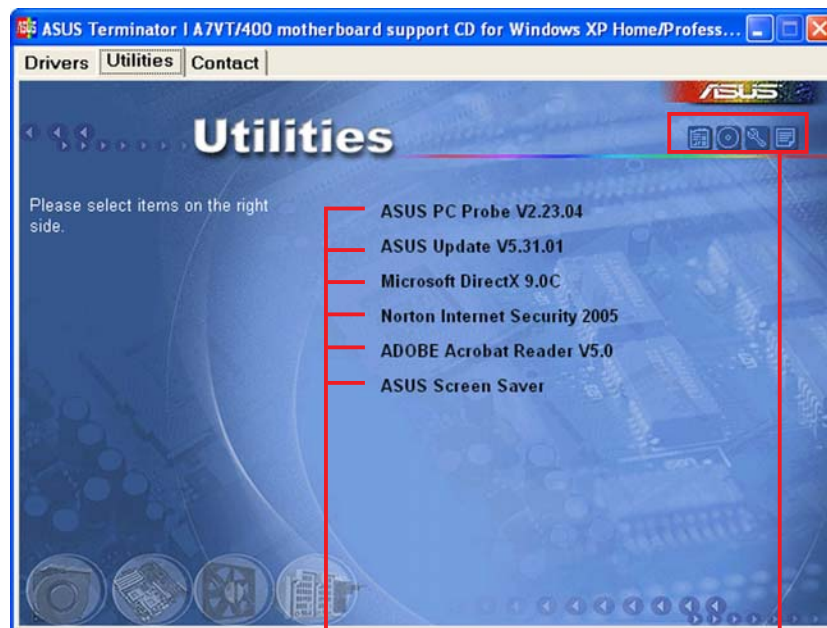

Click an item to install

Click an icon to display more information



If **Autorun** is NOT enabled in your computer, browse the contents of the support CD to locate the file ASSETUP.EXE from the BIN folder. Double-click the ASSETUP.EXE to run the CD.

3.2.2 Utilities menu

The menu lists the drivers and applications that are available for this motherboard. Simply click on a specific item then follow the installation wizard to install it.



ASUS PC Probe

This smart utility monitors the fan speed, CPU temperature, and system voltages, and alerts you of any detected problems. This utility helps you keep your computer at a healthy operating condition.

ASUS Update

This item installs the ASUS Update. This program allows you to download the latest version of the BIOS from the ASUS website.

Microsoft® Direct X Driver

This item installs the Microsoft® Direct X driver.

Anti-virus application

The anti-virus application scans, identifies, and removes computer viruses. View the online help for detailed information.

ADOBE Acrobat Reader

This item installs the Adobe Acrobat® Reader®. The Acrobat Reader software is for viewing files saved in Portable Document Format (PDF).

ASUS Screen Saver

This item installs the ASUS screen saver.

3.2.3 ASUS Contact information

Click the **Contact** tab to display the ASUS contact information.

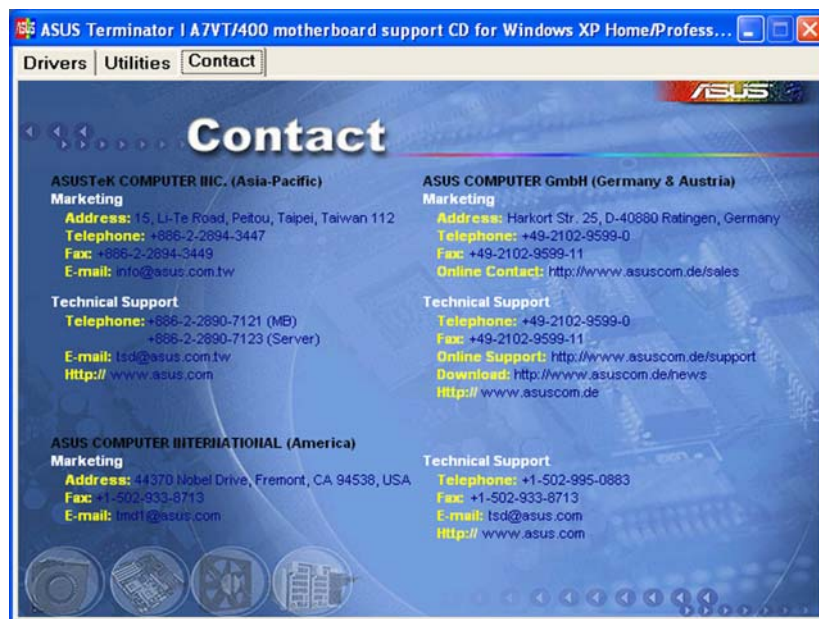

3.2.4 Other information

The icons on the top right of the screen give additional information on the motherboard and the contents of the support CD. Click an icon to display the specified information.

Motherboard Info

Displays the general specifications of the motherboard.



The screen image below is for general reference only. The support CD will automatically detect the motherboard information and display it on your screen.

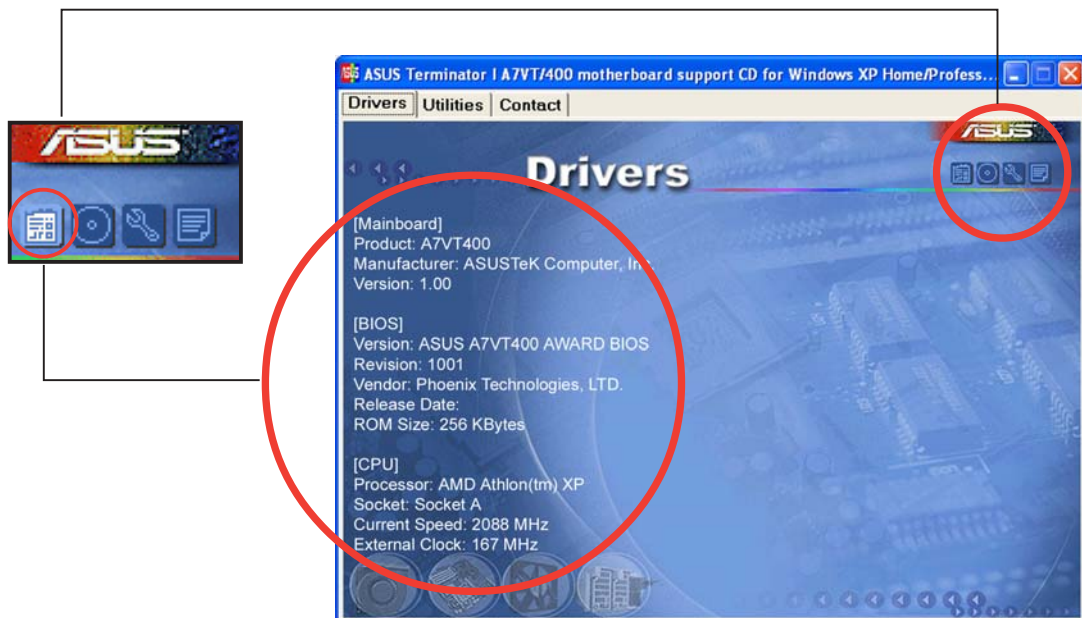

Browse this CD

Displays the support CD contents in graphical format.

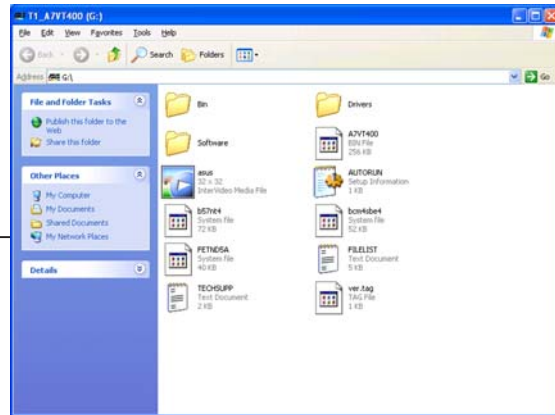
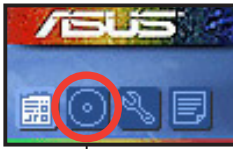

Technical support form

Displays the ASUS Technical Support Request Form that you have to fill out when requesting technical support.

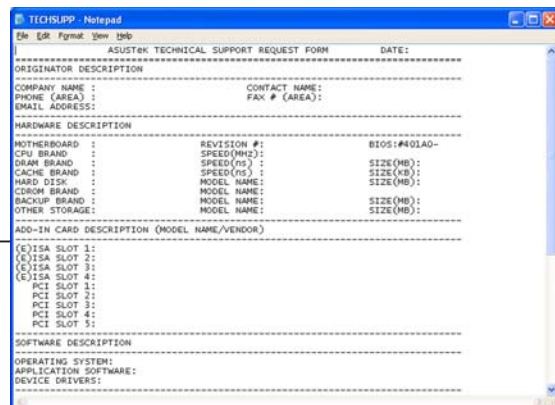
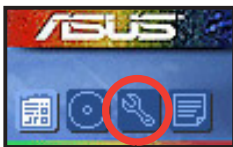

Filelist

Displays the contents of the support CD and a brief description of each in text format.

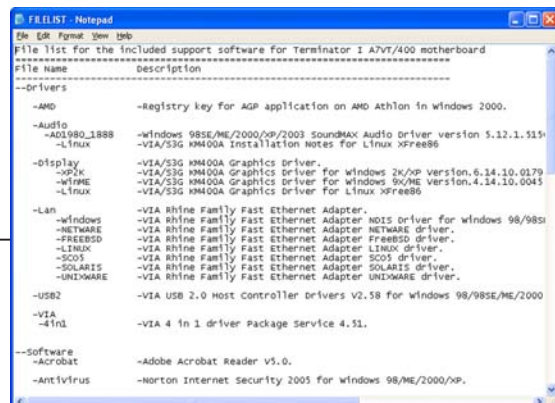
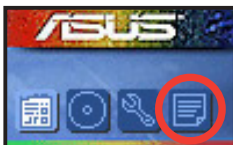

3.3 Software information

Most of the applications in the support CD have wizards that will conveniently guide you through the installation. View the online help or readme file that came with the software for more information.

3.3.1 ASUS PC Probe

ASUS PC Probe is a convenient utility to continuously monitor your computer system's vital components, such as fan rotations, voltages, and temperatures. It also has a utility that lets you review useful information about your computer, such as hard disk space, memory usage, and CPU type, CPU speed, and internal/external frequencies through the DMI Explorer.

Starting ASUS PC Probe

When ASUS PC Probe starts, a splash screen appears, allowing you to select whether to show the screen again when you open PC Probe or not. To bypass this startup screen, clear the **Show up in next execution** check box.

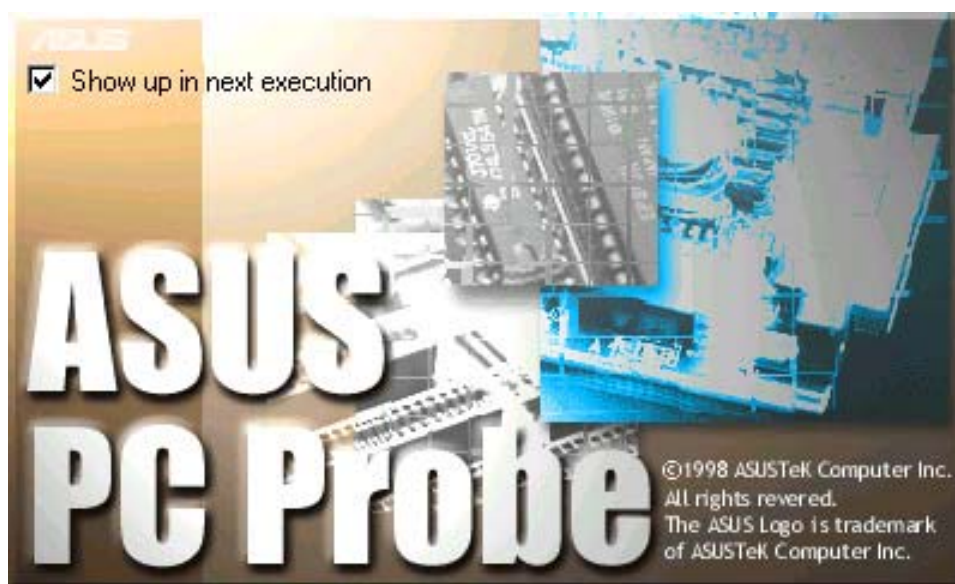

To launch **ASUS PC Probe**, click the Windows® **Start** button, point to **Programs**, and then **ASUS Utility**, and then click **Probe Vx.xx**.

The PC Probe icon  appears on the taskbar system tray indicating that ASUS PC Probe is running. Clicking the icon allows you to see the status of your PC.

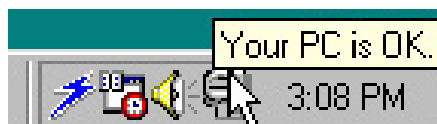

Using ASUS PC Probe Monitoring

Monitor Summary

Shows a summary of the items being monitored.

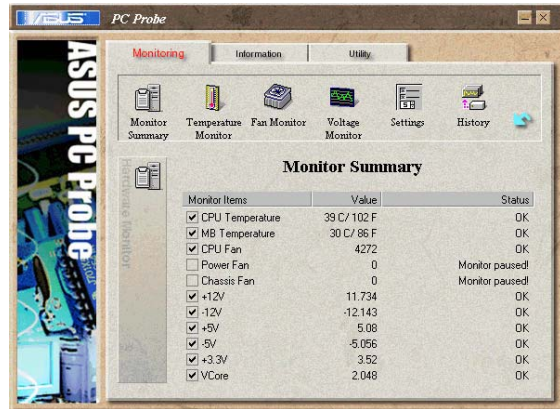

Temperature Monitor

Shows the PC temperature.

Temperature Warning threshold adjustment
(Move the slider up to increase the threshold level or down to decrease the threshold level)

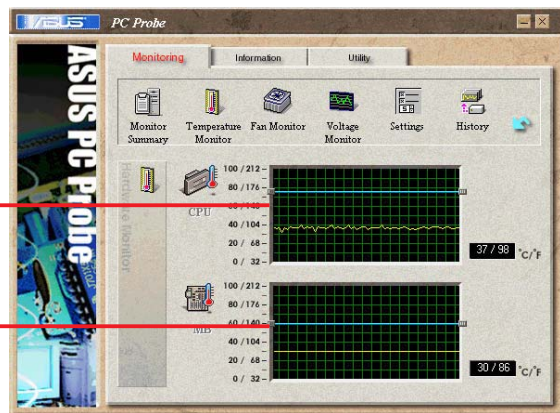

Fan Monitor

Shows the PC fan rotation.

Fan Warning threshold adjustment
(Move the slider up to increase the threshold level or down to decrease the threshold level)

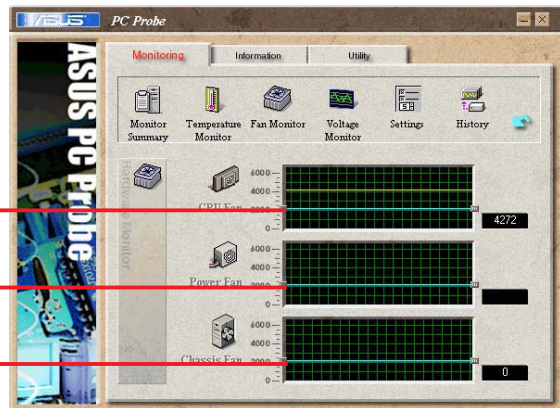

Voltage Monitor

Shows the PC voltages.

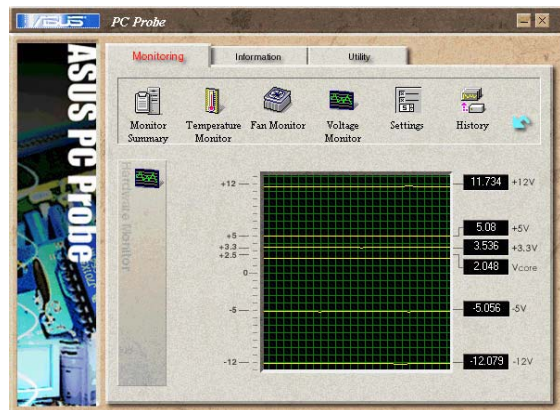

Settings

Lets you set threshold levels and polling intervals or refresh times of the PC's temperature, fan rotation, and voltages.



CPU Cooling System Setup
*Lets you select when to enable software CPU cooling. If you select **When CPU Over-heated**, the CPU cooling system is enabled whenever the CPU temperature reaches the threshold value.*



History

Lets you record the monitoring activity of a certain component of your PC for future reference.

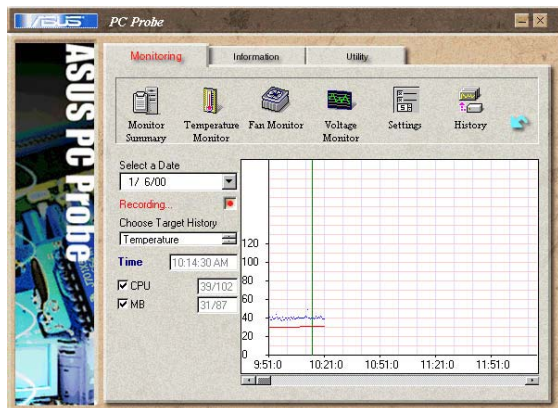

Fan Control

Lets you enable/disable Smart Fan Control. Smart Fan Control adjusts the fan speed automatically based on the current CPU temperature and predefined threshold.



Hard Drives

Shows the used and free space of the PC's hard disk drives and the file allocation table or file system used.

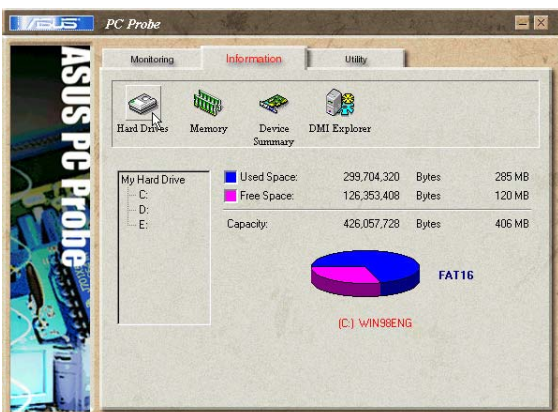

Memory

Shows the PC memory load, memory usage, and paging file usage.

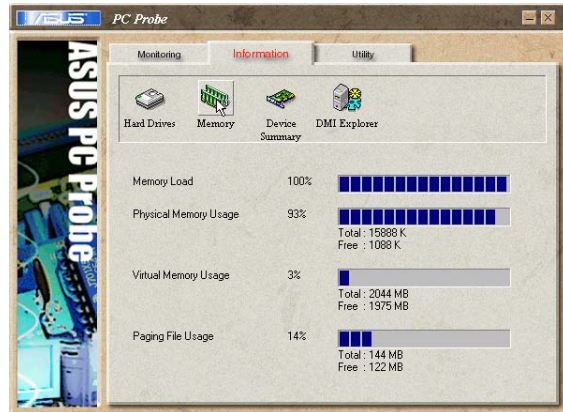

Device Summary

Shows a summary of devices present in your PC.



DMI Explorer

Shows information pertinent to the PC, such as CPU type, CPU speed, and internal/external frequencies, and memory size.



Utility

Lets you run programs outside of the ASUS Probe modules. To run a program, click **Execute Program**.



This feature is currently unavailable.

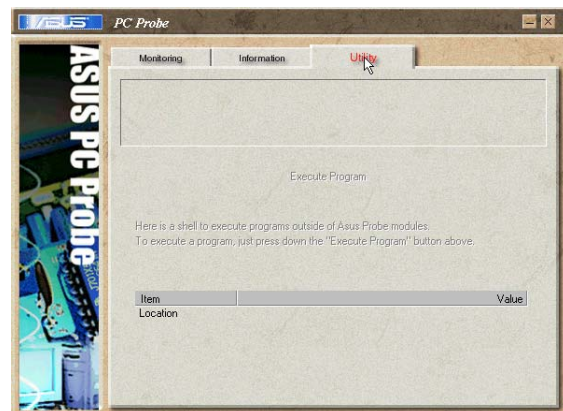

ASUS PC Probe Task Bar Icon

Right clicking the PC Probe icon brings up a menu to open or exit ASUS PC Probe and pause or resume all system monitoring.



When the ASUS PC Probe senses a problem with your PC, portions of the ASUS PC Probe icon change to red, the PC speaker beeps, and the ASUS PC Probe monitor appears.



3.3.2 ASUS Update

The ASUS Update is a utility that allows you to update the motherboard BIOS and drivers. This utility requires an Internet connection either through a network or an Internet Service Provider (ISP).

To use the ASUS Update:

1. Launch the utility from your Windows Start menu:
Programs/AsusUpdate Vx.xx.xx/AsusUpdate
The ASUS Update initial screen appears.
2. Select your desired update method, then click **Next**.

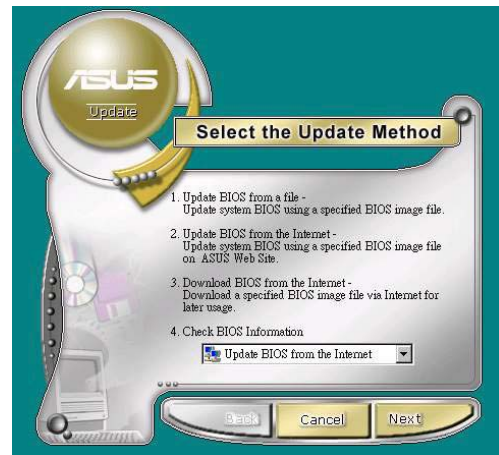

3. If you selected updating/downloading from the Internet, select the ASUS FTP site nearest you to avoid network traffic, or choose Auto Select. Click **Next**.

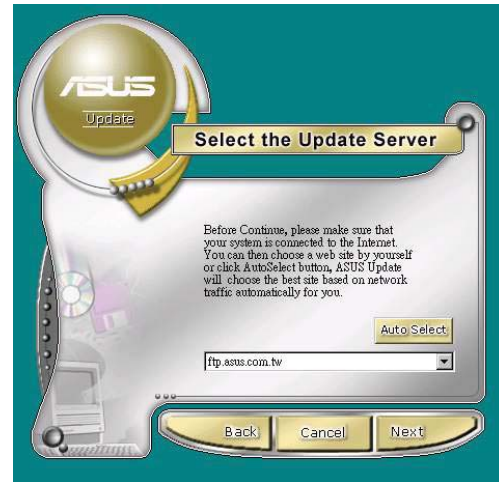

4. From the FTP site, select the BIOS version that you wish to download. Click **Next**.
5. Follow the instructions on the succeeding screens to complete the update process.

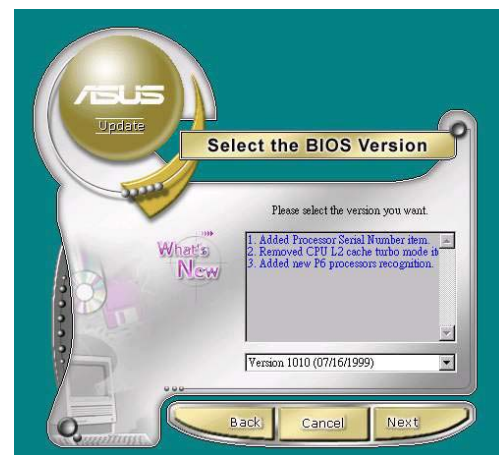

If you selected the option to update the BIOS from a file, a window pops up prompting you to locate the file. Select the file, click Save, then follow the screen instructions to complete the update process.

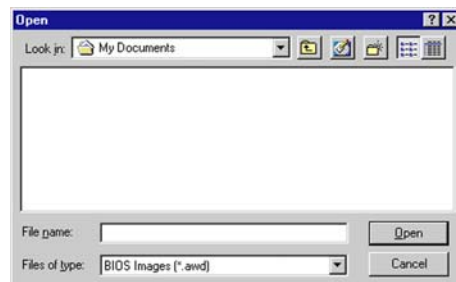

Chapter 4

This chapter gives information about the motherboard that came with the system. This chapter includes the motherboard layout, jumper settings, and connector locations.



ASUS Terminator T1 A7VT400

4.1 Introduction

The ASUS motherboard comes already installed in the ASUS Terminator 1 A7VT400 barebone system. This chapter provides technical information about the motherboard for future upgrades or system reconfiguraiton.

4.2 Motherboard layout

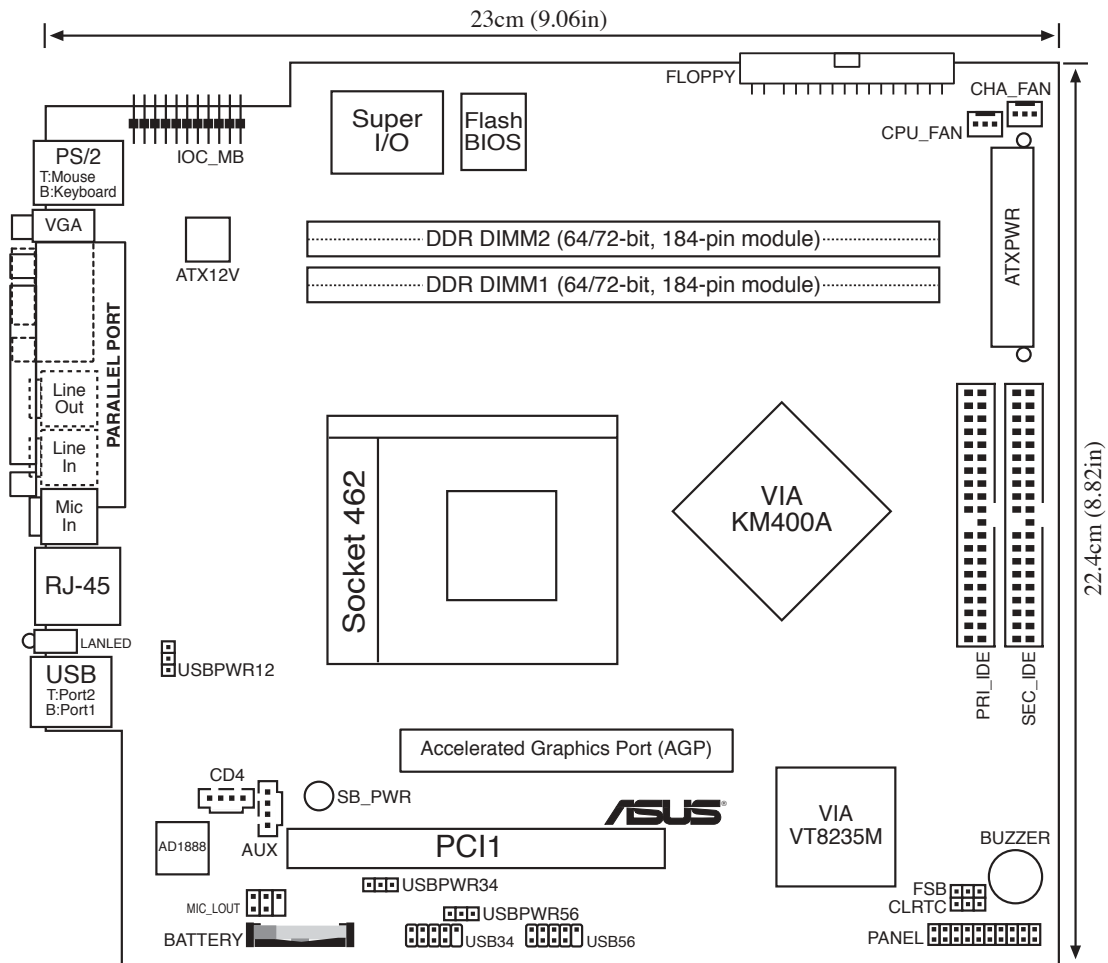

4.3 Jumpers

This section describes and illustrates the jumpers on the motherboard.

1. USB device wake-up (3-pin USBPWR12, USBPWR34, USBPWR56)

Set these jumpers to +5V to wake up the computer from S1 sleep mode (CPU stopped, DRAM refreshed, system running in low power mode) using the connected USB devices. Set to +5VSB to wake up from S3, S4, and S5 sleep mode (no power to CPU, DRAM in slow refresh, power supply in reduced power mode).

The USBPWR12 jumper is for the rear USB ports. The USBPWR34 and USBPWR56 jumpers are for the internal USB connectors that you can connect to additional USB ports.



- The motherboard provides 0.5A for each USB port and 1.5A for all devices requiring +5VSB power. To use the USB device wake-up feature, the total +5VSB power for all connected devices must not exceed 1.5A.
- The total current consumed must NOT exceed the power supply capability (+5VSB), whether under normal condition or in sleep mode.
- Make sure to set the jumpers to +5VSB if you want to wake up the system from S3, S4, and S5 sleep mode.

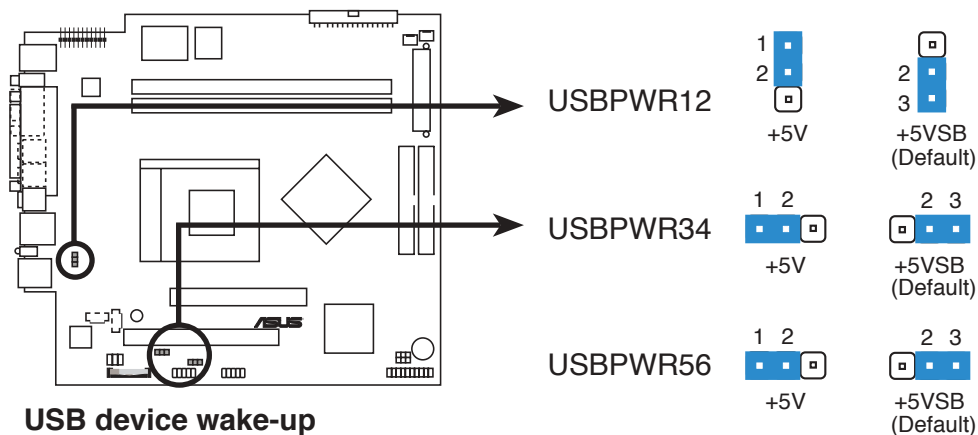

2. Clear RTC RAM (CLRTC)

This jumper allows you to clear the Real Time Clock (RTC) RAM in CMOS. You can clear the CMOS memory of date, time, and system setup parameters by erasing the CMOS RTC RAM data. The onboard button cell battery powers the RAM data in CMOS, which include system setup information such as system passwords.

To erase the RTC RAM:

1. Turn OFF the computer and unplug the power cord.
2. Remove the battery.
3. Move the jumper cap from pins 2-3 (default) to pins 1-2. Keep the cap on pins 1-2 for about 5~10 seconds, then move the cap back to pins 2-3.
4. Re-install the battery.
5. Plug the power cord and turn ON the computer.
6. Hold down the key during the boot process and enter BIOS setup to re-enter data.

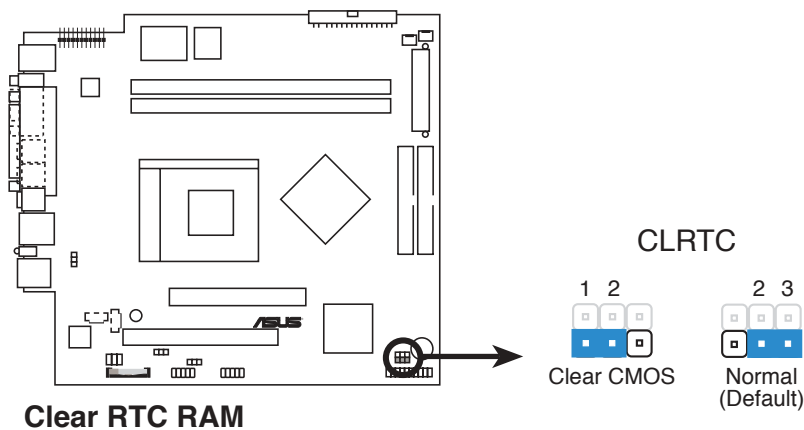

Except when clearing the RTC RAM, never remove the cap.

3. External frequency selection (FSB)

This jumper allows you to set the CPU Front Side Bus (FSB) frequency. Set the jumper to 2-3 only when your CPU FSB frequency is 100 MHz. If your CPU FSB frequency is 133/166/200 MHz, set the jumper to 1-2.

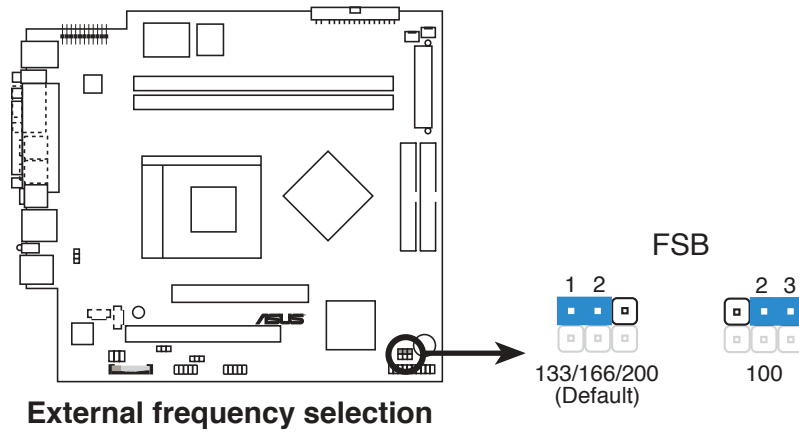

4.4 Connectors

This section describes and illustrates the connectors on the motherboard. See page 1-4 for the description of rear panel connectors.

1. IDE connectors (40-pin PRI_IDE, SEC_IDE)

These connectors are for Ultra DMA 133/100/66 signal cables. The Ultra DMA 133/100/66 signal cable has three connectors: a blue connector for the primary IDE connector on the motherboard, a black connector for an Ultra DMA 133/100/66 IDE slave device (optical drive/hard disk drive), and a gray connector for an Ultra DMA 133/100/66 IDE master device (hard disk drive). If you install two hard disk drives, you must configure the second drive as a slave device by setting its jumper accordingly. Refer to the hard disk documentation for the jumper settings.



- Pin 20 on the IDE connector is removed to match the covered hole on the Ultra DMA cable connector. This prevents incorrect insertion when you connect the IDE cable.
- Use the 80-conductor IDE cable for Ultra DMA 133/100/66 IDE devices.

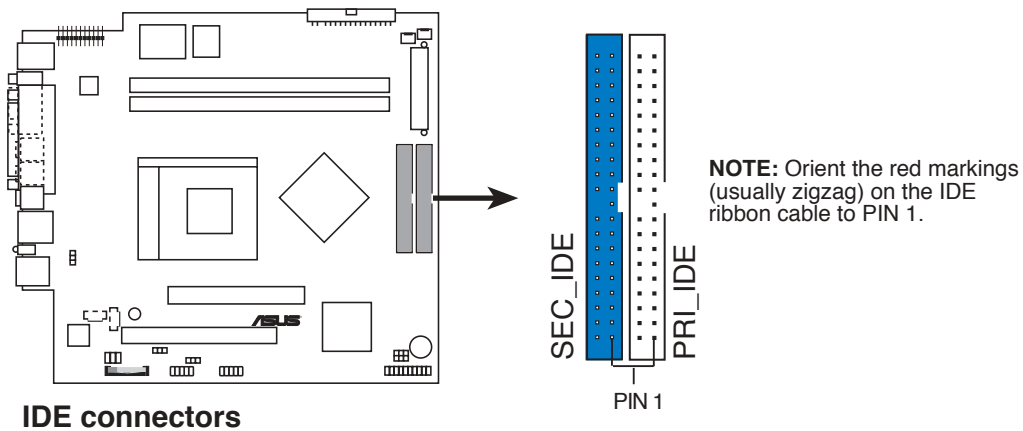

2. Floppy disk drive connector (34-1 pin FLOPPY)

This connector supports the provided floppy drive ribbon cable. After connecting one end to the motherboard, connect the other end to the floppy drive. (Pin 5 is removed to prevent incorrect insertion when using ribbon cables with pin 5 plug).

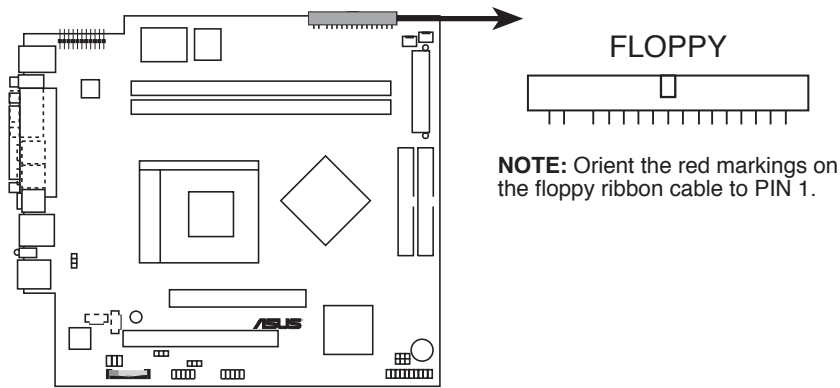

Floppy disk drive connector

3. Internal audio connectors (4-pin AUX, CD)

These connectors allow you to receive stereo audio input from sound sources such as an optical drive, TV tuner, or MPEG card.

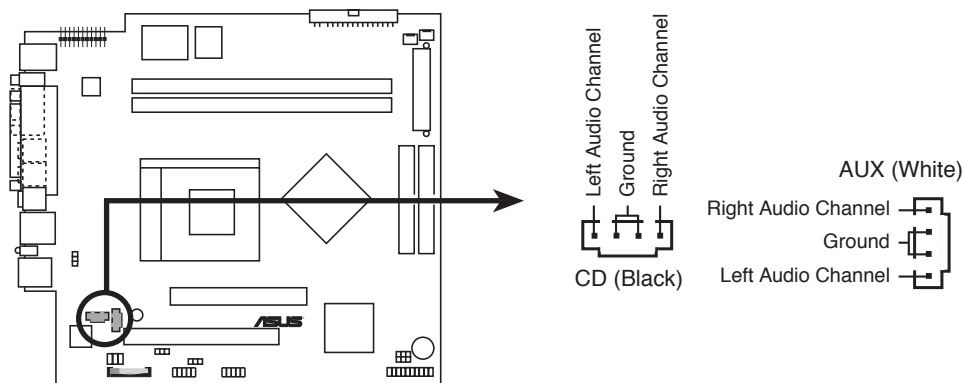

Internal audio connectors

4. ATX power connectors (20-pin ATXPWR, 4-pin ATX +12V)

These connectors are for ATX power supply plugs. The plugs from the power supply are designed to fit these connectors in only one orientation. Find the proper orientation and push down firmly until the connectors completely fit.

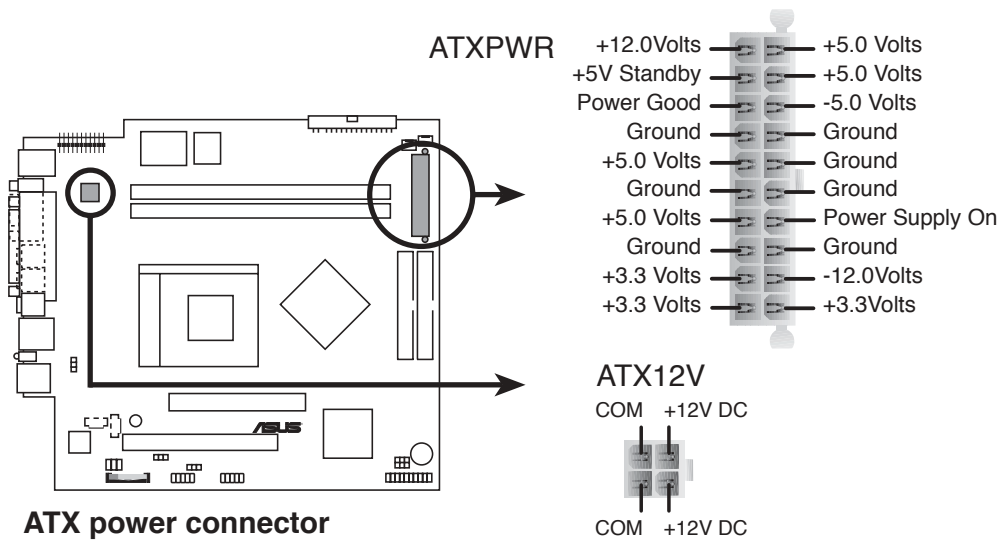

Make sure to connect the 4-pin ATX +12V power plug; otherwise, the system does not boot up.

5. Front panel audio connector (5-1 pin MIC_LOUT)

This connector is for a chassis-mounted front panel audio I/O module that supports legacy AC'97 audio standard.

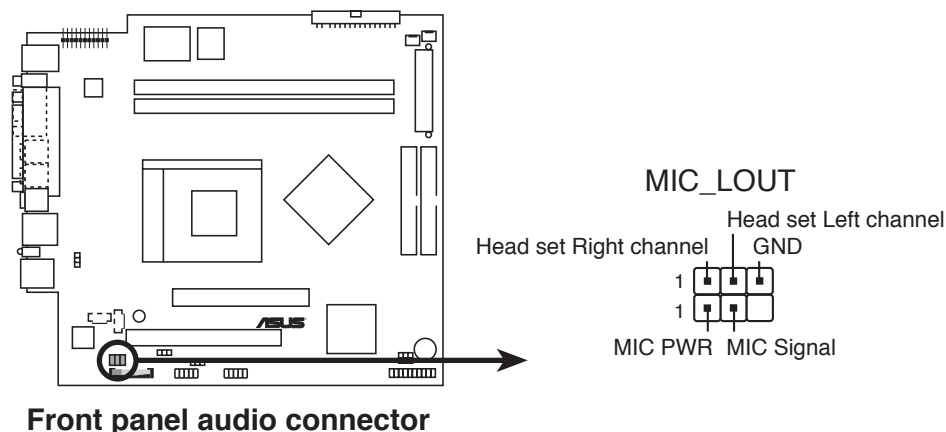

6. CPU and chassis fan connectors (3-pin CPU_FAN, CHA_FAN)

These connectors support cooling fans of 350mA~740mA (8.88W max.) or a total of 1A~2.22A (26.64W max) at +12V. Connect the fan cables to the fan connectors on the motherboard, making sure that the black wire of each cable matches the ground pin of the connector.

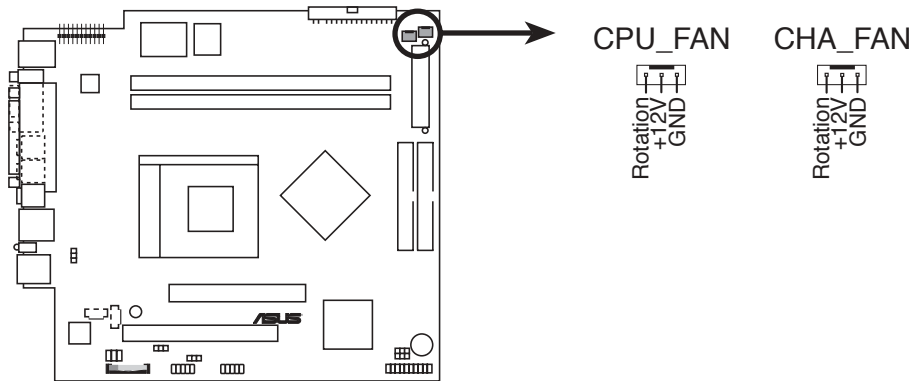

Fan connectors



Do not forget to connect the fan cables to the fan connectors. Insufficient air flow inside the system may damage the motherboard components. These are not jumpers! Do not place jumper caps on the fan connectors!

7. IO extension module connector (22-pin IOC_MB)

This connector is for the CGAEX extension module.

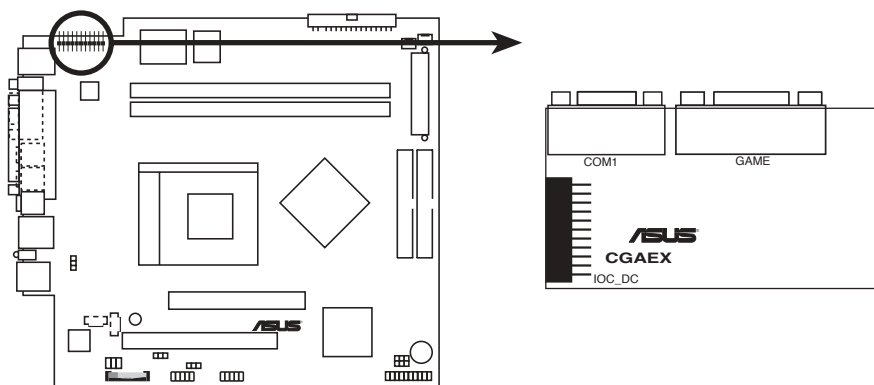

CGAEX extension module

8. USB 2.0 connectors (10-1 pin USB34, USB56)

These connectors are for USB 2.0 ports. Connect the USB module cable to any of these connectors, then install the module to a slot opening at the back of the system chassis. These USB connectors comply with USB 2.0 specification that supports up to 480 Mbps connection speed.

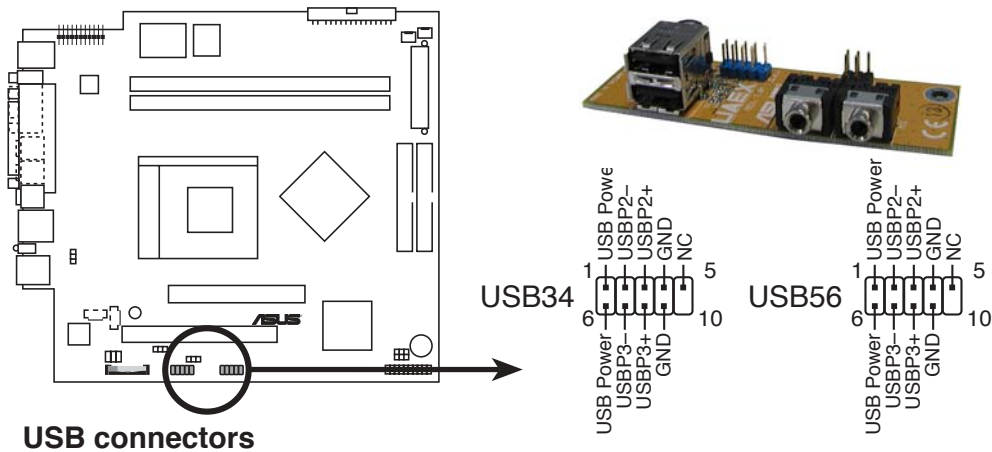

9. System panel connector (20-pin PANEL)

This connector supports several chassis-mounted functions.

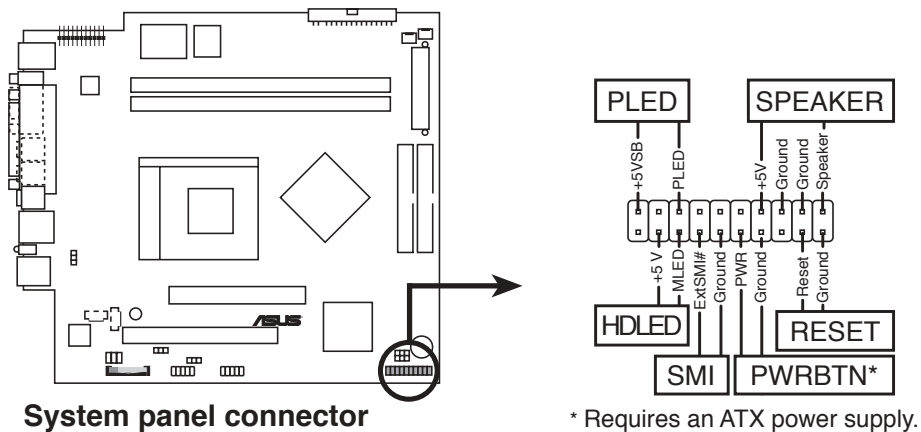

- **System power LED (3-pin PLED)**
This 3-pin connector is for the system power LED. Connect the chassis power LED cable to this connector. The system power LED lights up when you turn on the system power, and blinks when the system is in sleep mode.
- **System warning speaker (4-pin SPEAKER)**
This 4-pin connector is for the chassis-mounted system warning speaker. The speaker allows you to hear system beeps and warnings.
- **Hard disk drive activity LED (2-pin HDLED)**
This 2-pin connector is for the HDD Activity LED. Connect the HDD Activity LED cable to this connector. The IDE LED lights up or flashes when data is read from or written to the HDD.
- **System management interrupt (2-pin SMI)**
This 2-pin connector allows you to manually place the system in suspend mode, or “green” mode, where system activity is instantly decreased to save power and to expand the life of certain system components. Attach the chassis-mounted suspend switch to this 2-pin connector.
- **Reset button (2-pin RESET)**
This 2-pin connector is for the chassis-mounted reset button for system reboot without turning off the system power.
- **ATX power button/soft-off button (2-pin PWRBTN)**
This connector is for the system power button. Pressing the power button turns the system on or puts the system in sleep or soft-off mode depending on the BIOS settings. Pressing the power switch for more than four seconds while the system is ON turns the system OFF.

Chapter 5

This chapter tells how to change system settings through the BIOS Setup menus. It includes detailed descriptions of the BIOS parameters.



5.1 Managing and updating your BIOS

The following utilities allow you to manage and update the motherboard Basic Input/Output System (BIOS) setup.

1. **AwardBIOS Flash Utility** (*Updates the BIOS using a floppy disk during POST.*)
2. **ASUS CrashFree BIOS** (*Updates the BIOS using a bootable floppy disk when the BIOS gets corrupted.*)
3. **ASUS Update** (*Updates the BIOS in Windows® environment.*)

Refer to the corresponding section for details on these utilities.

Important notes



-
- Save a copy of the **original motherboard BIOS file** to a **bootable floppy disk** in case you need to restore the BIOS in the future. Copy the original motherboard BIOS using the ASUS Update or AFLASH utilities.
 - Visit the ASUS website and download the latest BIOS file for this motherboard using the ASUS Update utility.
-

5.1.1 Creating a bootable floppy disk

1. Do either one of the following to create a bootable floppy disk.
DOS environment

Insert a 1.44 MB floppy disk into the drive. At the DOS prompt, type:

format A:/S then press <Enter>.

Windows® ME environment

- a. From your Windows desktop, click on **Start**, then select **My Computer**.
- b. Double-click on **Add/Remove Programs** icon from the Control Panel window.
- c. Click on the **Startup Disk** tab, then on **Create Disk...** button.
- d. Insert a 1.44 MB floppy disk when prompted. Follow the succeeding screen instructions to complete the process.

Windows® XP environment

- a. Insert a 1.44 MB floppy disk into the floppy disk drive.
 - b. From your Windows desktop, click on **Start**, then select **My Computer**.
 - c. Select the **3 1/2 Floppy Drive** icon.
 - d. Click **File** from the menu, then select **Format**. A **Format 3 1/2 Floppy Disk** window appears.
 - e. Select **Create an MS-DOS startup disk** from the format options field, then click **Start**.
2. Copy the original (or the latest) motherboard BIOS to the bootable floppy disk.

5.1.2 Updating the BIOS using the AwardBIOS Flash Utility

The Basic Input/Output System (BIOS) can be updated using the built-in Flash Memory Writer utility or using a bootable floppy disk with the executable Flash Memory Writer Utility (AWDFLASH.EXE). Follow these instructions to update the BIOS using this utility.



Save only the updated BIOS file in the floppy disk to avoid loading a wrong BIOS file.



The succeeding screens are for reference only. The actual displays may not exactly match what you see on your screen.

Updating the BIOS file

1. Download the latest BIOS file from the system builder's website. . Rename the file to (BIOS file name on the support CD).BIN and save it to the bootable floppy disk you created earlier.
2. Copy the AwardBIOS Flash Utility (awdfash.exe) from the Software folder of the support CD to the floppy disk with the latest BIOS file.
3. Boot the system in DOS mode using the bootable floppy disk you created earlier.

4. When the **A:>** appears, replace the bootable floppy disk with the floppy disk containing the new BIOS file and the Award BIOS Flash Utility.
5. At the prompt, type **awdf flash** then press **<Enter>**. The Award BIOS Flash Utility screen appears.

```
AwardBIOS Flash Utility for ASUS B107A
(C) Phoenix Technologies Ltd. All Rights Reserved

For KM400A-8235M-6A6LYA0AC      DATE: 12/07/2004
Flash Type - SST-39SF020 /5V

File Name to Program: 

Message: Please input File Name!
```

6. Type the BIOS file name in the **File Name to Program** field, then press **<Enter>**.

```
AwardBIOS Flash Utility for ASUS B107A
(C) Phoenix Technologies Ltd. All Rights Reserved

For KM400A-8235M-6A6LYA0AC      DATE: 12/07/2004
Flash Type - SST-39SF020 /5V

File Name to Program: 

Message: Do You Want To Save Bios (Y/N)
```

7. The utility prompts you to save the current BIOS file. Press **<Y>** to save the current BIOS file to the floppy disk, or **<N>** to continue.



If you intend to save the current BIOS file, make sure that the floppy disk has enough disk space to save the file. See the next section for details on saving the current BIOS file.

5.1.3 Recovering the BIOS with CrashFree BIOS

The CrashFree BIOS auto recovery tool allows you to restore the BIOS from a floppy disk that contains the BIOS file, in case the current BIOS on the motherboard fails or gets corrupted.



- Prepare the **floppy disk that contains the motherboard BIOS (A7VT400.BIN)** before proceeding with the BIOS update process.
- If you have saved a copy of the original motherboard BIOS to a bootable floppy disk, you may also use this disk to restore the BIOS.

To recover the BIOS from a floppy disk:

1. Boot the system.
2. When a corrupted BIOS is detected, the following message appears.

```
Bad BIOS checksum. Starting BIOS recovery...
Checking for floppy...
```

3. Insert a floppy disk that contains the original, or the latest, BIOS file for this motherboard (A7VT400.BIN). If the BIOS file that you downloaded from the ASUS website has a different filename (e.g. A7VT400_1001.001). Rename it to **A7VT400.BIN**. The BIOS update process continues when the A7VT400.BIN is found.

```
Bad BIOS checksum. Starting BIOS recovery...
Checking for floppy...
Floppy found!
Reading file "a7vt400.bin". Completed.
Start flashing...
```



DO NOT shut down or reset the system while updating the BIOS! Doing so may cause system boot failure!

4. When the BIOS update process is complete, reboot the system.

5.1.4 ASUS Update

The ASUS Update is a utility that allows you to update the motherboard BIOS in Windows® environment. This utility is available in the support CD that comes with the motherboard package. ASUS Update requires an Internet connection either through a network or an Internet Service Provider (ISP).

Go to section “3.3.2 ASUS Update” for details on how to update the motherboard BIOS using ASUS Update.

5.2 BIOS Setup program

This motherboard supports a programmable Flash ROM that you can update using the provided utility described in section “5.1 Managing and updating your BIOS.”

Use the BIOS Setup program when you are installing a motherboard, reconfiguring your system, or prompted to “Run Setup.” This section explains how to configure your system using this utility.

Even if you are not prompted to use the Setup program, you may want to change the configuration of your computer in the future. For example, you may want to enable the security password feature or make changes to the power management settings. This requires you to reconfigure your system using the BIOS Setup program so that the computer can recognize these changes and record them in the CMOS RAM of the Flash ROM.

The Flash ROM on the motherboard stores the Setup utility. When you start up the computer, the system provides you with the opportunity to run this program. Press <Delete> during the Power-On Self Test (POST) to enter the Setup utility; otherwise, POST continues with its test routines.

To enter Setup after POST, restart the system by pressing <Ctrl> + <Alt> + <Delete>, or by pressing the reset button on the system chassis. You can also restart by turning the system off and then back on. Do this last option only if the first two failed.

The Setup program is designed to make it as easy to use as possible. It is a menu-driven program, which means you can scroll through the various sub-menus and make your selections among the predetermined choices.



Because the BIOS software is constantly being updated, the following BIOS setup screens and descriptions are for reference purposes only, and may not exactly match what you see on your screen.

5.2.1 BIOS menu bar

The top of the screen has a menu bar with the following selections:

MAIN	Use this menu to make changes to the basic system configuration.
ADVANCED	Use this menu to enable and make changes to the advanced features.
POWER	Use this menu to configure and enable Power Management features.
BOOT	Use this menu to configure the default system device used to locate and load the Operating System.
EXIT	Use this menu to exit the current menu or to exit the Setup program.

To access the menu bar items, press the right or left arrow key on the keyboard until the desired item is highlighted.

5.2.2 Legend bar

At the bottom of the Setup screen is a legend bar. The keys in the legend bar allow you to navigate through the various setup menus. The following table lists the keys found in the legend bar with their corresponding functions.

Navigation Key(s)	Function Description
<F1> or <Alt + H>	Displays the General Help screen from anywhere in the BIOS Setup
<Esc>	Jumps to the Exit menu or returns to the main menu from a sub-menu
Left or Right arrow	Selects the menu item to the left or right
Up or Down arrow	Moves the highlight up or down between fields
- (minus key)	Scrolls backward through the values for the highlighted field
+ (plus key) or spacebar	Scrolls forward through the values for the highlighted field
<Enter>	Brings up a selection menu for the highlighted field
<Home> or <PgUp>	Moves the cursor to the first field
<End> or <PgDn>	Moves the cursor to the last field
<F5>	Resets the current screen to its Setup Defaults
<F10>	Saves changes and exits Setup

General help

In addition to the Item Specific Help window, the BIOS setup program also provides a General Help screen. You may launch this screen from any menu by simply pressing <F1>. The General Help screen lists the legend keys and their corresponding functions.

Saving changes and exiting the Setup program

See “5.7 Exit Menu” for detailed information on saving changes and exiting the setup program.

Scroll bar

When a scroll bar appears to the right of a help window, it indicates that there is more information to be displayed that will not fit in the window. Use <PgUp> and <PgDn> or the up and down arrow keys to scroll through the entire help document. Press <Home> to display the first page, press <End> to go to the last page. To exit the help window, press <Enter> or <Esc>.

Sub-menu

Note that a right pointer symbol (as shown on the left) appears to the left

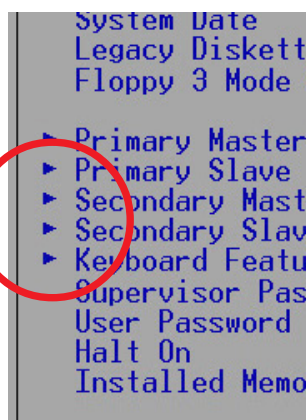

of certain fields. This pointer indicates that you can display a sub-menu from this field. A sub-menu contains additional options for a field parameter. To display a sub-menu, move the highlight to the field and press <Enter>. The sub-menu appears. Use the legend keys to enter values and move from field to field within a sub-menu as you would within a menu. Use the <Esc> key to return to the main menu.

Take some time to familiarize yourself with the legend keys and their corresponding functions.

Practice navigating through the various menus and sub-menus. If you accidentally make unwanted changes to any of the fields, use the set default hot key <F5> to load the Setup default values. While moving around through the Setup program, note that explanations appear in the Item Specific Help window located to the right of each menu. This window displays the help text for the currently highlighted field.

5.3 Main Menu

When you enter the Setup program, the following screen appears.

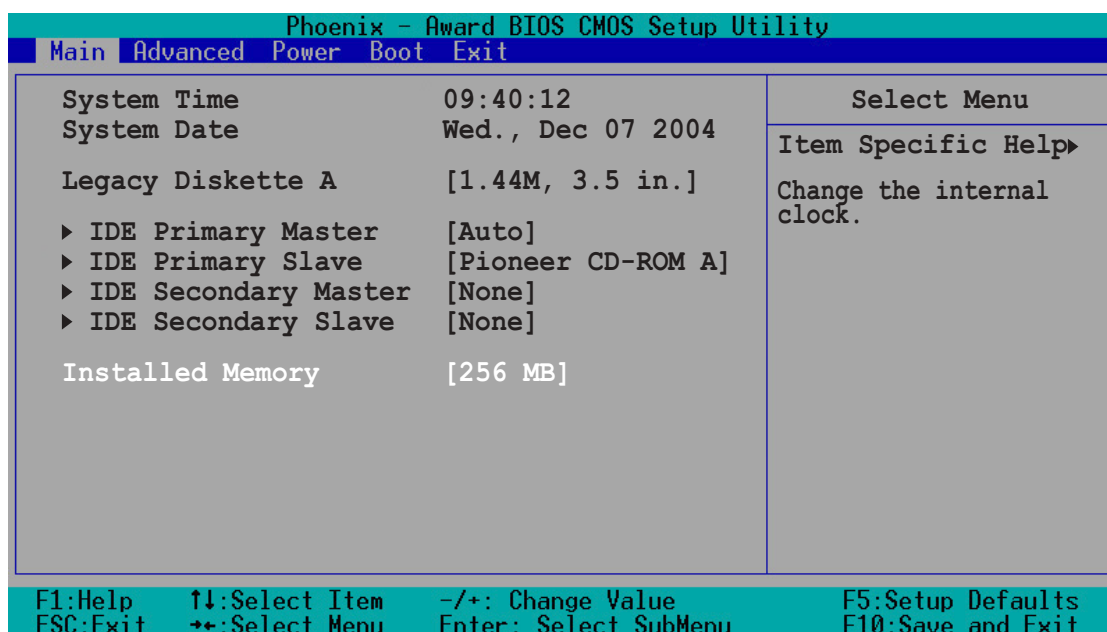

5.3.1 System Time [xx:xx:xx]

Sets the system to the time that you specify (usually the current time). The format is hour, minute, second. Valid values for hour, minute and second are Hour: (00 to 23), Minute: (00 to 59), Second: (00 to 59). Use the <Tab> key to move between the hour, minute, and second fields.

5.3.2 System Date [xx/xx/xxxx]

Sets the system to the date that you specify (usually the current date). The format is month, day, year. Valid values for month, day, and year are Month: (1 to 12), Day: (1 to 31), Year: (up to 2084). Use the <Tab> key to move between the month, day, and year fields.

5.3.3 Legacy Diskette A [1.44M, 3.5 in.]

Sets the type of floppy drive installed. Configuration options: [Disabled] [360K, 5.25 in.] [1.2M, 5.25 in.] [720K, 3.5 in.] [1.44M, 3.5 in.] [2.88M, 3.5 in.]

5.3.4 Installed Memory [xxx MB]

This field automatically displays the amount of conventional memory detected by the system during the boot process.

5.3.5 Primary and Secondary Master/Slave

Phoenix - Award BIOS CMOS Setup Utility	
Main	
IDE Primary Master	Select Menu
Primary IDE Master [Auto]	Item Specific Help▶
Access Mode [Auto]	Press [Enter] to select.
Capacity 0 MB	
Cylinder 0	
Head 0	
Sector 0	
PIO Mode [Auto]	
UDMA Mode [Auto]	
Transfer Mode None	
F1:Help ↑↓:Select Item -/+ : Change Value F5:Setup Defaults	
ESC:Exit →+:Select Menu Enter: Select SubMenu F10:Save and Exit	

Primary IDE Master [Auto]

Select [Auto] to automatically detect an IDE hard disk drive. If automatic detection is successful, Setup automatically fills in the correct values for the remaining fields on this sub-menu. If automatic detection fails, this may be because the hard disk drive is too old or too new. If the hard disk was already formatted on an older system, Setup may detect incorrect parameters. In these cases, select [Manual] to manually enter the IDE hard disk drive parameters. Refer to the next section for details.



Before attempting to configure a hard disk drive, make sure you have the correct configuration information supplied by the drive manufacturer. Incorrect settings may cause the system to fail to recognize the installed hard disk.

Access Mode [Auto]

This item allows the user to select the sector addressing mode.
Configuration options: [CHS] [LBA] [Large] [Auto]

PIO Mode [Auto]

This option lets you set a PIO (Programmed Input/Output) mode for the IDE device. Modes 0 through 4 provide successive increase in performance.
Configuration options: [Auto] [Mode 0] [Mode 1] [Mode 2] [Mode 3] [Mode 4]

UDMA Mode [Auto]

Ultra DMA capability allows improved transfer speeds and data integrity for compatible IDE devices. Set to [Disabled] to suppress Ultra DMA capability.

5.4 Advanced Menu

The Advanced menu items allow you to change the settings for the CPU and other system devices.



Take caution when changing the settings of the Advanced menu items. Incorrect field values may cause the system to malfunction.

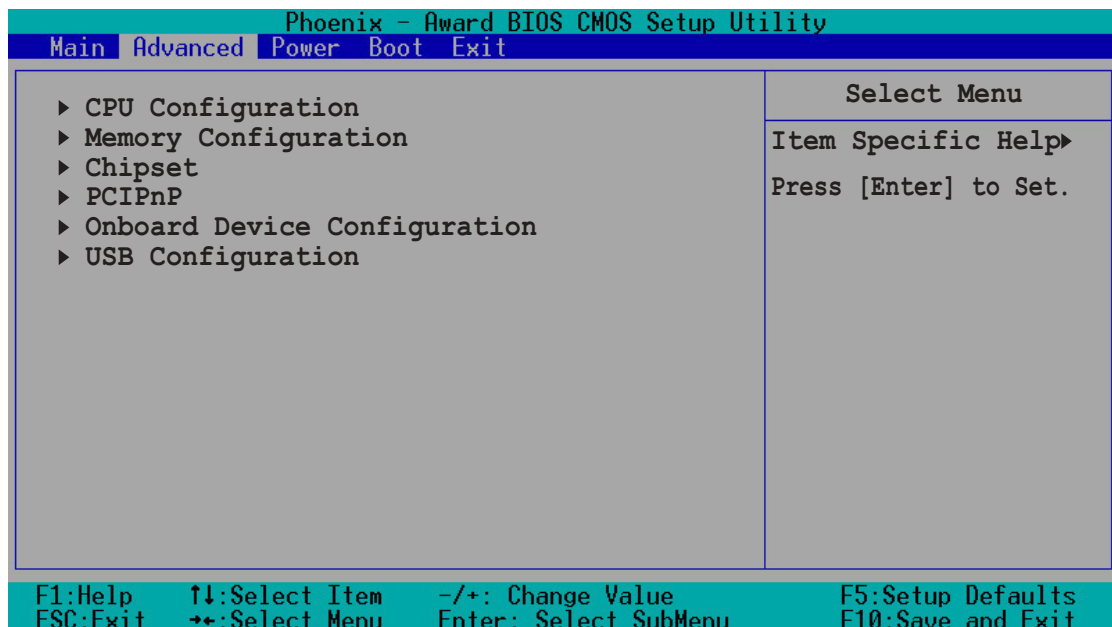

5.4.1 CPU configuration

The items in this menu show the CPU-related information auto-detected by the BIOS.

Phoenix - Award BIOS CMOS Setup Utility	
Advanced	
CPU Configuration	Select Menu
CPU Type	AMD Athlon (tm)
CPU Speed	1000 MHz
Cache RAM	256 K
Current FSB Frequency	100 MHz
	Item Specific Help▶▶

F1:Help ↑↓:Select Item -/+ : Change Value F5:Setup Defaults
ESC:Exit →+:Select Menu Enter: Select SubMenu F10:Save and Exit

5.4.2 Memory configuration

The items in this menu show the memory configuration settings. Select an item then press <Enter> to display a pop-up menu with the configuration options.

Phoenix - Award BIOS CMOS Setup Utility	
Advanced	
Memory Configuration	Select Menu
Current DRAM Frequency	133 MHz
DRAM Clock	[By SPD]
DRAM Timing	[Auto by SPD]
x DRAM CAS Latency	2.5
x Bank Interleave	Disabled
x Precharge to Active (Trp)	5T
x Active to Precharge (Tras)	7T
x Active to CMD (Trcd)	5T
DRAM Burst Length	[4]
DRAM Command Rate	[2T Command]
Write Recovery Time	[3T]
tWTR	[2T]
Item Specific Help▶▶	
Set DRAM Frequency.	

F1:Help ↑:Select Item -/+ : Change Value F5:Setup Defaults
 ESC:Exit →:Select Menu Enter: Select SubMenu F10:Save and Exit

DRAM Clock [By SPD]

Sets the DRAM frequency. Configuration options: [By SPD] [133 MHz] [166 MHz]

DRAM Timing [Auto by SPD]

The DRAM clock is set according to DRAM SPD (Serial Presence Detect). Select [Auto by SPD] for automatic DRAM clock detection. Select [Manual] to set the DRAM Timing manually. Select [Safe] to set the DRAM timing to safe value. Configuration options: [Auto by SPD] [Manual] [Safe]

DRAM Burst Length [4]

Sets the DRAM burst length width. Configuration options: [4] [8]

DRAM Command Rate [2T Command]

Sets the DRAM command rate .
 Configuration options: [1T Command] [2T Command]

Write Recovery Time [3T]

Sets the DRAM write recovery time. Configuration options: [2T] [3T]

tWTR [2T]

Sets the tWTR time. Configuration options: [1T] [2T]

5.4.3 Chipset configuration

The items in this menu show the chipset configuration settings. Select an item then press <Enter> to display a pop-up menu with the configuration options.

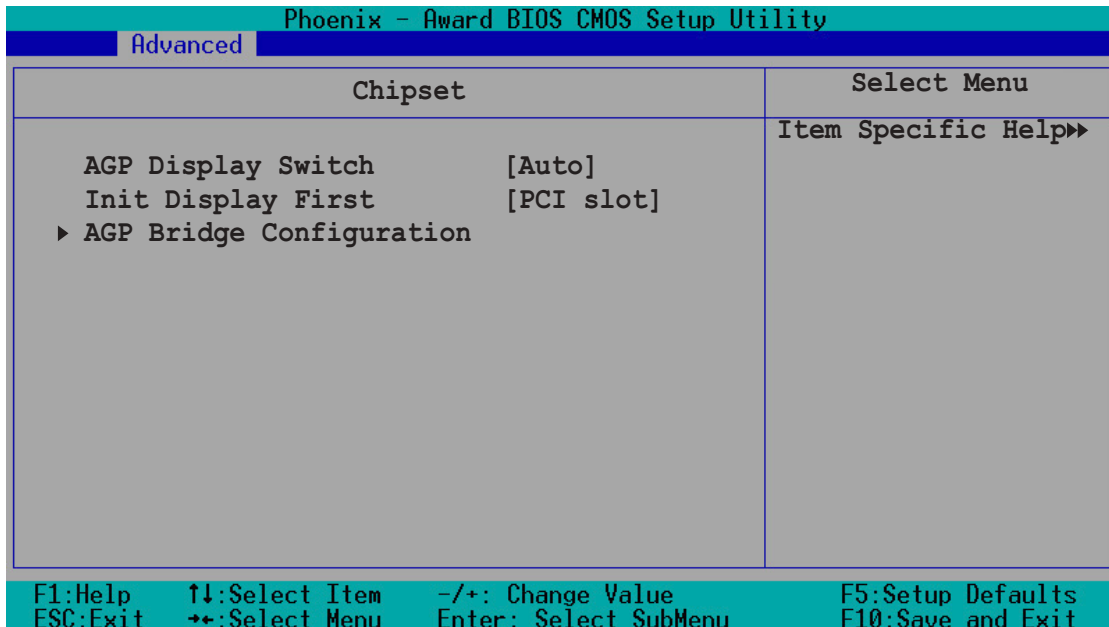

AGP Display Switch [Auto]

Select [Auto] to boot from the AGP card first. Select [Onchip AGP] to boot from the Onboard VGA even if there is an AGP card.

Configuration options: [Auto] [Onchip AGP]

Init Display First [PCI slot]

Allows you to set which graphics controller to use as the primary boot device. Configuration options: [PCI slot] [AGP]

AGP Bridge Configuration

This sub-menu allows you to set the values for the following items:

Graphics Aperture Size [64M]

Allows you to select the size of mapped memory for AGP graphic data. Configuration options: [1G] [512M] [256M] [128M] [64M] [32M] [16M] [8M] [4M]

AGP Mode [8X]

This motherboard supports the AGP 8X interface that enables enhanced graphics performance with high bandwidths of up to 2.21 GB/s. AGP 8X is backward-compatible. When set to [4X], this item allows 1066 MB/s video data transfers through the AGP 4X interface card. When set to [1X], the AGP interface only provides a peak data throughput of 266 MB/s even if you are using an AGP 8X card. Configuration options: [1X] [2X] [4X] [8X]

AGP Fast Write [Disabled]

This item allows you to enable or disable the AGP fast write feature. The AGP fast write is a data transfer protocol that combines PCI and AGP protocols to support continuous data transfer directly from the chipset to the AGP. Configuration options: [Disabled] [Enabled]

Onboard Video Memory [32M]

This item allows you to set the memory space reserved for the VGA frame buffer (display memory) within the system main memory. If you have installed a 3D graphics device, select at least 16MB VGA shared memory size. Note that the more system memory you share with VGA, the less memory space is left for other system devices. Configuration options: [16M] [32M] [64M]

5.4.4 PCIPnP

The items in this menu show the PCIPnP configuration settings. Select an item then press <Enter> to display a pop-up menu with the configuration options.

Phoenix - Award BIOS CMOS Setup Utility	
Advanced	
PCIPnP	Select Menu
Plug & Play O/S [No]	Item Specific Help▶▶
Resources Controlled By [Auto] x IRQ Resources	
PCI/VGA Palette Snoop [Disabled]	
Assign IRQ for VGA [Enabled]	
F1:Help ↑↓:Select Item -/+ : Change Value F5:Setup Defaults ESC:Exit →←:Select Menu Enter: Select SubMenu F10:Save and Exit	

Plug & Play OS [No]

Select [Yes] if you are using a Plug and Play capable operating system. Select [No] if you need the BIOS to configure non-boot devices. Configuration options: [No] [Yes]

Resources Controlled By [Auto]

When set to [Auto], this allows the BIOS to automatically configure all the boot and Plug and Play devices. When set to [Manual], you can assign the available IRQ resources to the PCI devices. Configuration options: [Auto] [Manual]



When the item **Resources Controlled By** is set to [Auto], the item IRQ Resources is grayed out and not user-configurable..

PCI/VGA Palette Snoop [Disabled]

Some non-standard VGA cards, like graphics accelerators or MPEG video cards, may not show colors properly. Setting this field to [Enabled] corrects this problem. If you are using standard VGA cards, leave this field to the default setting [Disabled]. Configuration options: [Disabled] [Enabled]

Assign IRQ VGA [Enabled]

Allows you to enable or disable the option to assign an IRQ for the onboard VGA. Configuration options: [Enabled] [Disabled]

5.4.5 Onboard device configuration

The items in this menu show the onboard device configuration settings. Select an item then press <Enter> to display a pop-up menu with the configuration options.

Phoenix - Award BIOS CMOS Setup Utility	
Advanced	
PCIPnP	Select Menu
Onboard LAN Boot ROM [Disabled]	Item Specific Help▶
AC97 Audio [Auto]	
Onboard LAN [Enabled]	
Serial Port1 Address [3F8/IRQ4]	
Parallel Port Address [378/IRQ7]	
Parallel Port Mode [ECP+EPP]	
EPP Mode Select [EPP1.7]	
ECP Mode Use DMA [3]	
Game Port Address [201]	
Midi Port Address [Disabled]	
x Midi Port IRQ 10	

F1:Help ↑↓:Select Item -/+ : Change Value F5:Setup Defaults
ESC:Exit ++:Select Menu Enter: Select SubMenu F10:Save and Exit

Onboard LAN Boot ROM [Disabled]

Allows you to enable or disable the option ROM on the onboard LAN chipset. Configuration options: [Disabled] [Enabled]

AC97 Audio [Auto]

Allows you to enable or disable the onboard AC97 Audio controller. Configuration options: [Auto] [Disabled]

Onboard LAN [Enabled]

Allows you to enable or disable the onboard LAN controller. Keep the default enabled if you wish to use the onboard LAN feature. Set to [Disabled] if you installed a PCI LAN card. Configuration options: [Disabled] [Enabled]

Serial Port1 Address [3F8/IRQ4]

Allows you to set the addresses for the onboard serial port connector. Configuration options: [3F8/IRQ4] [2F8/IRQ3] [3E8/IRQ4] [2E8/IRQ3] [Disabled]

Parallel Port Address [378/IRQ7]

Allows you to set the base address of the onboard parallel port connector. If you disable this field, the Parallel Port Mode and ECP DMA Select configurations are not available. Configuration options: [Disabled] [378/IRQ7] [278/IRQ5] [3BC/IRQ7]

Parallel Port Mode [ECP+EPP]

Allows you to set the operation mode of the parallel port.

Configuration options: [SPP] [EPP] [ECP] [ECP+EPP]

EPP Mode Select [EPP1.7]

Allows you to select the EPP mode. This item becomes configurable only if the **Parallel Port Mode** is set to [EPP] or [ECP+EPP].

Configuration options: [EPP1.7] [EPP1.9]

ECP Mode Use DMA [3]

Allows you to select the ECP Mode. This item becomes configurable only if the **Parallel Port Mode** is set to [ECP] or [ECP+EPP].

Configuration options: [1] [3]

Game Port Address [201]

Sets the I/O address for the game port.

Configuration options: [Disabled] [201] [209]

Midi Port Address [Disabled]

Sets the I/O address for the MIDI I/O port.

Configuration options: [Disabled] [330] [300] [290]

5.4.6 USB configuration

The items in this menu show the USB configuration settings. Select an item then press <Enter> to display a pop-up menu with the configuration options.

Phoenix - Award BIOS CMOS Setup Utility	
Advanced	
USB Configuration	Select Menu
USB 1.1 Controller [Enabled]	Item Specific Help▶▶
USB 2.0 Controller [Enabled]	Enable or Disable the USB 1.1 Controller.
USB Legacy Support [Enabled]	

F1:Help ↑↓:Select Item -/+ : Change Value F5:Setup Defaults
ESC:Exit →:Select Menu Enter: Select SubMenu F10:Save and Exit

USB 1.1 Controller [Enabled]

Allows you to enable or disable the USB 1.1 controller.
Configuration options: [Enabled] Disabled]

USB 2.0 Controller [Enabled]

Allows you to enable or disable the EHCI controller. Setting this item to [Enabled] allows the built-in high speed USB support in the BIOS to turn on automatically when you install high speed USB devices.
Configuration options: [Enabled] Disabled]

USB Legacy Support [Enabled]

Allows you to enable or disable support for legacy USB devices.
Configuration options: [Enabled] Disabled]

5.5 Power Menu

The Power menu allows you to reduce power consumption. This feature turns off the video display and shuts down the hard disk after a period of inactivity.

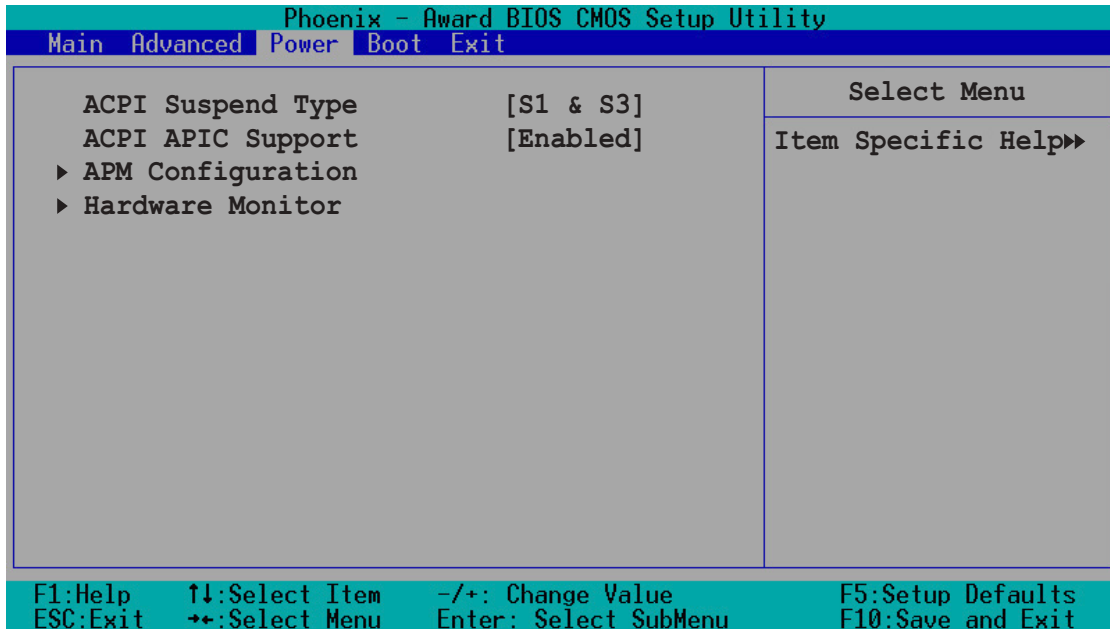

ACPI Suspend Type [S1 & S3]

Allows you to select the ACPI state used for system suspend.
Configuration options: [S1(POS)] [S3(STR)] [S1&S3]

ACPI APIC Support [Enabled]

Allows you enable or disable the ACPI feature on the operating system.
Configuration options: [Enabled] [Disabled]

5.5.1 APM configuration

This menu shows the Advanced Power Management (APM) configuration settings. Select an item then press <Enter> to display a pop-up menu with the configuration options.

Phoenix - Award BIOS CMOS Setup Utility		
Power		
APM Configuration		Select Menu
PS2KB Wakeup Select	[Hot key]	Item Specific Help▶▶
PS2KB Wakeup Password	Clear	
PS2KB Wakeup from S3/S4/S5	[Disabled]	
PS2MS Wakeup from S3/S4/S5	[Disabled]	
USB Resume from S3/S4	[Enabled]	
Power Up On PCI Devices	[Disabled]	
Modem Ring Resume	[Disabled]	
Power On By RTC Alarm	[Disabled]	
x Date of Month	0	
x Resume Time (hh:mm:ss)	0:0:0	
Video Off Option	[Suspend -> Off]	
PWR Button <4 secs	[Instant-Off]	
Restore on AC Power Loss	[Power Off]	
F1:Help	↑↓:Select Item	-/+ : Change Value
ESC:Exit	→←:Select Menu	Enter: Select SubMenu
		F5:Setup Defaults
		F10:Save and Exit

PS2KB Wakeup Select [Hot Key]

Allows you to wake up the system using a keyboard hot key or password. Configuration options: [Hot key] [Password]

PS2KB Wakeup from S3/S4/S5 [Disabled]

Allows you to use specific keys on the keyboard to turn on the system. This feature requires an ATX power supply that provides at least 1A on the +5VSB lead. Configuration options: [Disabled] [Ctrl+F1] [Ctrl+F2] [Ctrl+F3] [Ctrl+F4] [Ctrl+F5] [Ctrl+F6] [Ctrl+F7] [Ctrl+F8] [Ctrl+F9] [Ctrl+F10] [Ctrl+F11] [Ctrl+F12] [Power] [Wake] [Any Key]

PS2MS Wakeup from S3/S4/S5 [Disabled]

Configuration options: [Disabled] [Enabled]

USB Resume from S3/S4 [Enabled]

Configuration options: [Disabled] [Enabled]

Power Up On PCI Devices [Disabled]

When set to [Enabled], this parameter allows you to turn on the system through a PCI modem. This feature requires an ATX power supply that provides at least 1A on the +5VSB lead. Configuration options: [Disabled] [Enabled]

Modem Ring Resume [Disabled]

Allows you to enable or disable system power up when the external modem receives a call while the computer is in soft-off mode. Configuration options: [Disabled] [Enabled]



The computer cannot receive or transmit data until the computer and applications are fully running. Thus, connection cannot be made on the first try. Turning an external modem off and then back on while the computer is off causes an initialization string that turns the system power on.

Power On By RTC Alarm [Disabled]

Allows you to enable or disable RTC to generate an event. When this item is enabled, you can set the date and time of alarm using the two following items. Configuration options: [Disabled] [Enabled]

Date (of Month) [0]

To set the date of alarm, highlight this item and press <Enter> to display a pop-up menu. Key-in a value within the specified range then press <Enter>. Configuration options: [Min=0] [Max=31]

Resume time (hh:mm:ss) [0 : 0 : 0]

To set the time of alarm:

1. Highlight this item and press <Enter> to display a pop-up menu for the hour field.
2. Key-in a value (Min=0, Max=23), then press <Enter>.
3. Press tab to move to the minutes field, then press <Enter>.
4. Key-in a minute value (Min=0, Max=59), then press <Enter>.
5. Press tab to move to the seconds field, then press <Enter>.
6. Key-in a value (Min=0, Max=59), then press <Enter>.

Video Off Option [Suspend -> Off]

This item determines when to activate the video off feature to monitor power management. Configuration options: [Suspend -> Off] [Always On]

PWR Button < 4 secs [Instant-Off]

When set to [Instant-Off], the system goes to soft-off when you press the power button for **less** than 4 seconds. When set to [Suspend], press the power button for **more** than 4 seconds to power off the system.

Configuration options: [Suspend] [Instant-Off]

Restore on AC Power Loss [Power Off]

Allows you to set whether or not to reboot the system after power interruptions. [Power Off] leaves your system off, [Power On] reboots the system, and [Last State] sets the system back to the state it was before the power interruption. Configuration options: [Power Off] [Power On] [Last State]

5.5.2 Hardware monitor

This menu shows the hardware monitor configuration settings. Select an item then press <Enter> to display a pop-up menu with the configuration options.

Phoenix - Award BIOS CMOS Setup Utility	
Power	
Hardware Monitor	Select Menu
Q-FAN Function [Disabled]	Item Specific Help▶▶ System will shut down when CPU temperature is too high.
Shutdown Temperature [Disabled]	
Power Temperature 0°C/32°F	
CPU Temperature 54°C/129°F	
Chassis Fan Speed 0 RPM	
CPU Fan Speed 7273 RPM	
Vcore 1.79 V	
+3.3 V 3.34 V	
+5 V 5.08 V	
+12 V 11.80 V	
F1:Help ↑↓:Select Item -/+ : Change Value F5:Setup Defaults ESC:Exit →+:Select Menu Enter : Select SubMenu F10:Save and Exit	

Q-Fan Function [Disabled]

This item allows you to enable or disable the ASUS Q-Fan feature that smartly adjusts the CPU fan speed for more efficient system operation. Configuration options: [Disabled] [Enabled]

Shutdown Temperature [Disabled]

When set to [Enabled], the system shuts down when the CPU temperature is too high. Configuration options: [Disabled] [45°C/113°F] [50°C/122°F] [55°C/131°F] [60°C/140°F] [65°C/149°F] [70°C/158°F] [75°C/167°F]

Power Temperature [xxx°C/xxx°F]

CPU Temperature [xxx°C/xxx°F]

The onboard hardware monitor automatically detects and displays the power supply and CPU temperatures in these fields.

Chassis Fan Speed [xxxxRPM]

CPU Fan Speed [xxxxRPM]

The onboard hardware monitor automatically detects the CPU and chassis fan speeds in rotations per minute (RPM).

VCORE Voltage, +3.3V Voltage, +5V Voltage, +12V Voltage

The onboard hardware monitor automatically detects the voltage output through the onboard voltage regulators.

5.6 Boot Menu

The Boot menu items allow you to change the system boot settings. Select an item then press <Enter> to display a pop-up menu with the configuration options.

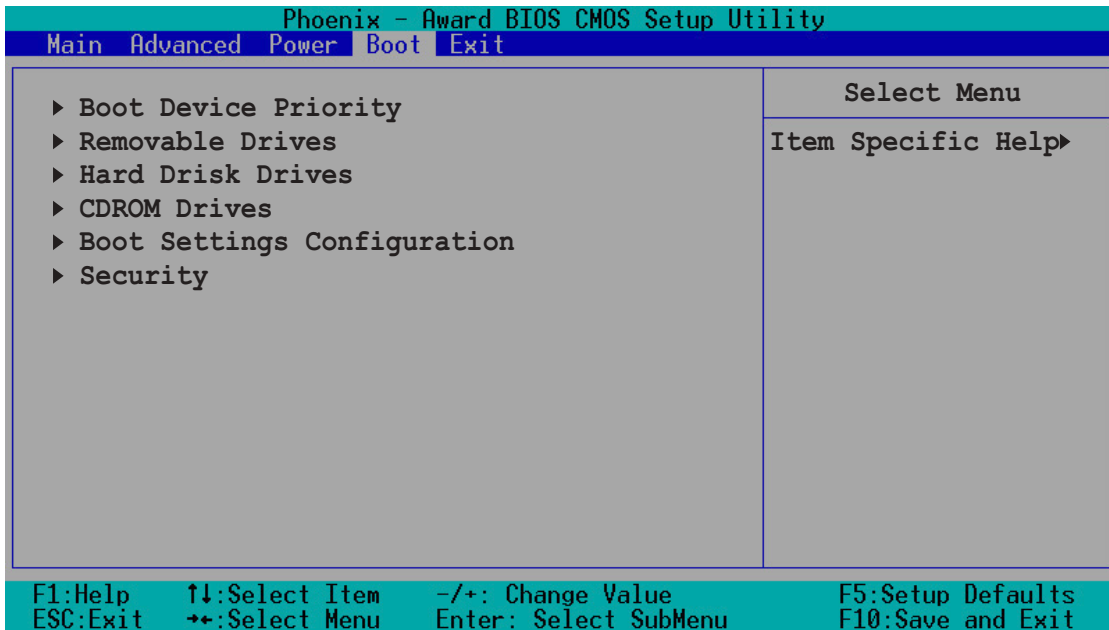

5.6.1 Boot device priority

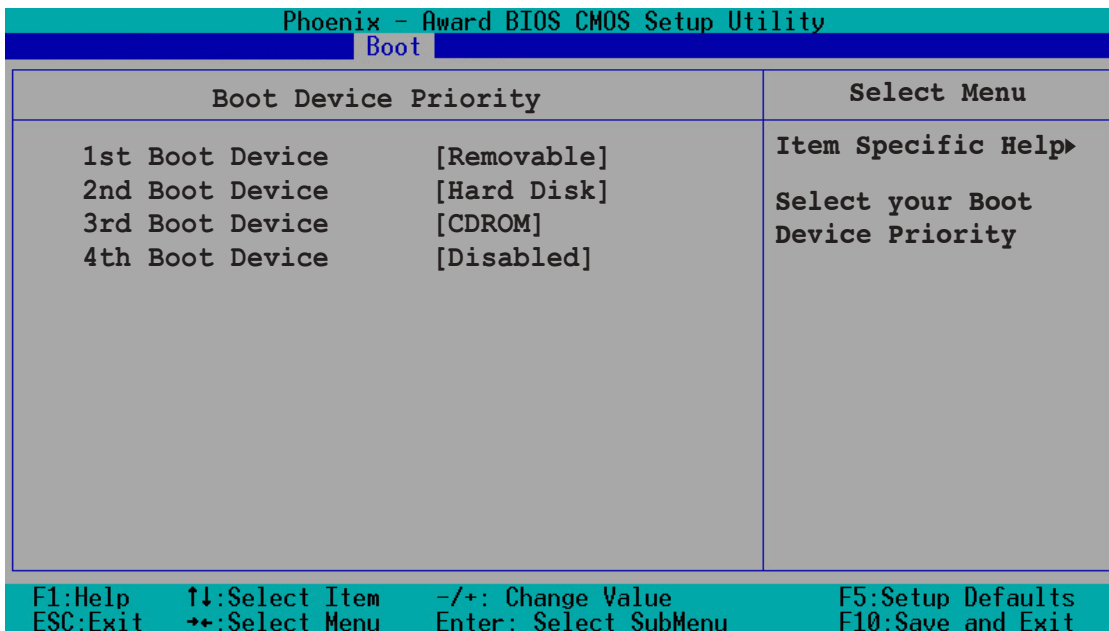

- 1st Boot Device [Removable]
- 2nd Boot Device [Hard Disk]
- 3rd Boot Device [CDROM]
- 4th Boot Device [Disabled]

These items allow you to select your boot device priority.
 Configuration options: [Removable] [Hard Disk] [CDROM] [Disabled]

5.6.2 Removable drives

Phoenix - Award BIOS CMOS Setup Utility			
Boot			
Removable Drives		Select Menu	
1. Floppy Disks		Item Specific Help ►►	
		Use <up> or <down> arrow to select a device, then press <+> to move it up, or <-> to move it down the list. Press <ESC> to exit this menu.	
F1:Help	↑↓:Select Item	-/+ : Change Value	F5:Setup Defaults
ESC:Exit	→←:Select Menu	Enter: Select SubMenu	F10:Save and Exit

5.6.3 Hard disk drives

Phoenix - Award BIOS CMOS Setup Utility			
Boot			
Hard Disk Drives		Select Menu	
1. Bootable Add-in Cards		Item Specific Help ►►	
		Use <up> or <down> arrow to select a device, then press <+> to move it up, or <-> to move it down the list. Press <ESC> to exit this menu.	
F1:Help	↑↓:Select Item	-/+ : Change Value	F5:Setup Defaults
ESC:Exit	→←:Select Menu	Enter: Select SubMenu	F10:Save and Exit

Boot Up Floppy Seek [Disabled]

When [Enabled], the BIOS will seek the floppy disk drive to determine whether the drive has 40 or 80 tracks. Configuration options: [Enabled] [Disabled]

Boot Up Num-Lock Status [On]

Allows you to select the power-on state for the NumLock. Configuration options: [On] [Off]

Typematic Rate Setting [Disabled]

Allows you to enable or disable the keyboard typematic rate setting. Set to [Enabled] to configure the Type Rate and Type Delay items. Configuration options: [Disabled] [Enabled]



The items **Typematic Rate (Chars/Sec)** and **Typematic Delay** become configurable only when the item Typematic Setting is enabled.

Typematic Rate (Chars/Sec) [6]

Allows you to select the rate at which character repeats when you hold a key. Configuration options: [6] [8] [10] [12] [15] [20] [24] [30]

Typematic Delay (Msec) [250]

Allows you to set the delay before key strokes begin to repeat. Configuration options: [250] [500] [750] [1000]

OS Select for DRAM > 64MB [Non-OS2]

Select [OS2] only when you are using an OS2 operating system with greater than 64MB RAM. Otherwise, set to [Non-OS2]. Configuration options: [Non-OS2] [OS2]

Halt On [All Errors]

Sets the system to halt on errors according to the system functions specified in each option. Configuration options: [All Errors] [No Errors] [All, But Keyboard] [All , But Diskette] [All, But Disk/Key]

5.6.6 Security

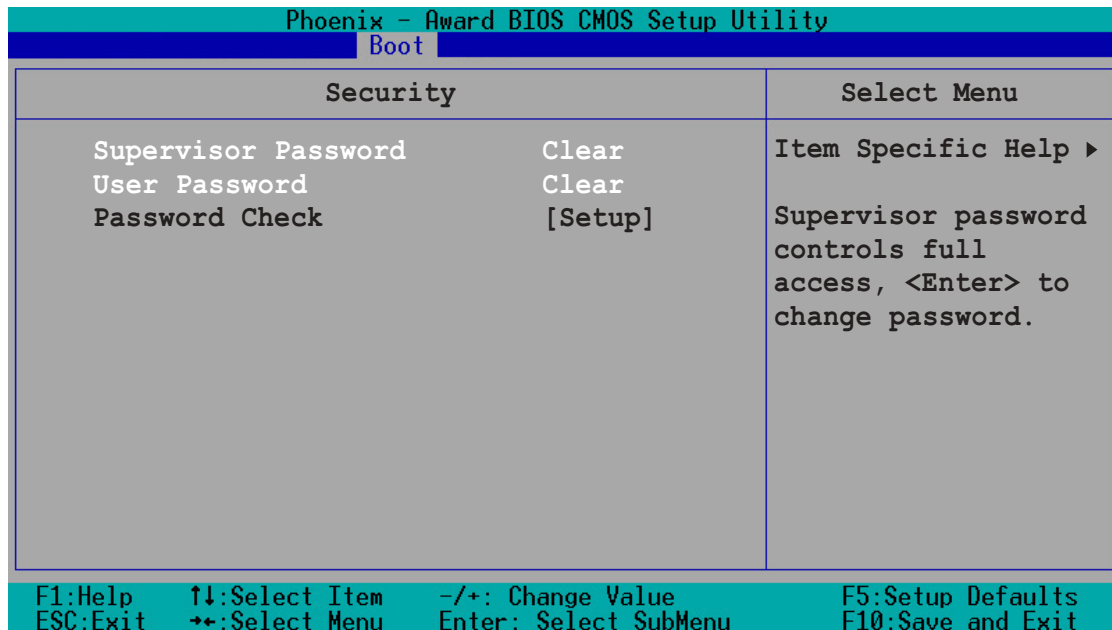

Supervisor Password [Clear] User Password [Clear]

These fields allow you to set passwords.

To set a password:

1. Highlight an item then press <Enter>.
2. Type in a password using eight (8) alphanumeric characters, then press <Enter>.
3. When prompted, confirm the password by typing the exact characters again, then press <Enter>. The password field setting is changed to [Set].

To clear the password:

1. Highlight the password field, and press <Enter> twice. The following message appears:
"PASSWORD DISABLED!!! Press any key to continue..."
2. Press any key to return to the menu.

A note about passwords

The Supervisor password is required to enter the BIOS Setup program preventing unauthorized access. The User password is required to boot the system preventing unauthorized use.

Forgot the password?

If you forget your password, you can clear it by erasing the CMOS Real Time Clock (RTC) RAM. The RAM data containing the password information is powered by the onboard button cell battery. If you need to erase the CMOS RAM, refer to section “4.3 Jumpers” for instructions.

Password Check [Setup]

This field requires you to enter the password before entering the BIOS setup or the system. Select [Setup] to require the password before entering the BIOS Setup. Select [System] to require the password before entering the system. Configuration options: [Setup] [System]

5.7 Exit menu

The Exit menu items allow you to load the BIOS setup default settings, save or discard any changes you made, or exit the Setup utility.

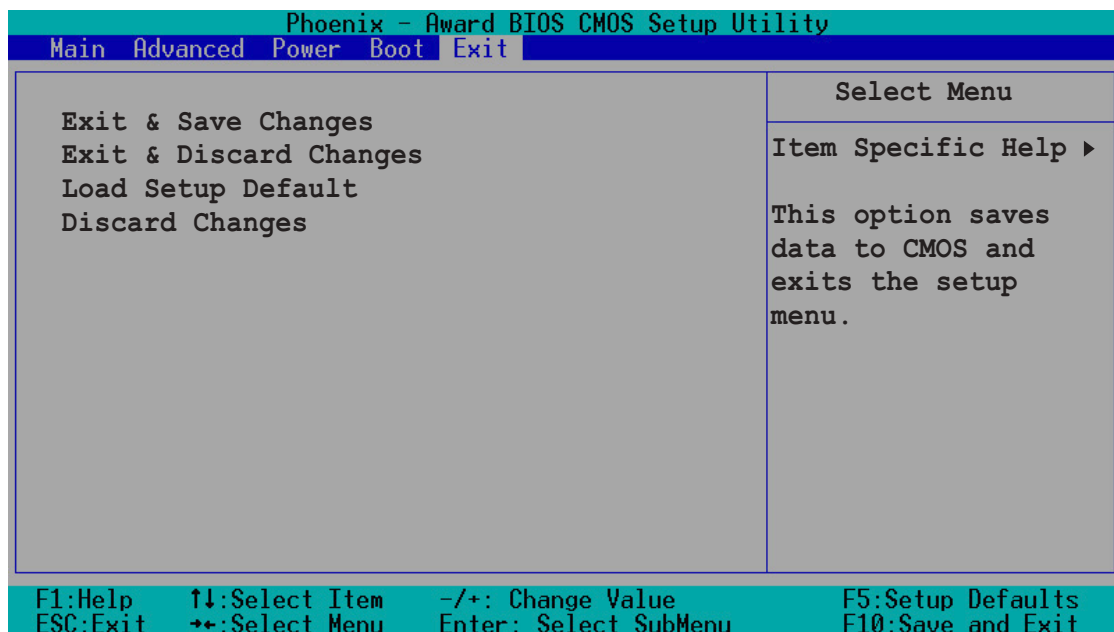

Exit & Save Changes

Select this option then press <Enter>, or simply press <F10>, to save your changes to CMOS before exiting the Setup utility.

When a confirmation window appears (with a blinking [Y]):

- press <Enter> to save and exit
- type [N], then press <Enter>, or simply press <Esc>, to cancel the command and return to the Exit menu

Exit & Discard Changes

Select this option only if you do not want to save the changes that you made to the Setup program. If you made changes to fields other than system date, system time, and password, the BIOS asks for a confirmation before exiting.

Load Setup Defaults

This option allows you to load the default values for each of the parameters on the Setup menus. When you select this option or if you press <F5>, a confirmation window appears. Select [Yes] to load default values. Select Exit Saving Changes or make other changes before saving the values to the non-volatile RAM.

Discard Changes

This option allows you to discard the selections you made and restore the previously saved values. After selecting this option, a confirmation appears. Select [Yes] to discard any changes and load the previously saved values.