

**K8N4-E**  
*Deluxe*

**ASUS**<sup>®</sup>

**Motherboard**

**E2009**

**Revision Edition V2**

**March 2005**

**Copyright © 2005 ASUSTeK COMPUTER INC. All Rights Reserved.**

No part of this manual, including the products and software described in it, may be reproduced, transmitted, transcribed, stored in a retrieval system, or translated into any language in any form or by any means, except documentation kept by the purchaser for backup purposes, without the express written permission of ASUSTeK COMPUTER INC. (“ASUS”).

Product warranty or service will not be extended if: (1) the product is repaired, modified or altered, unless such repair, modification or alteration is authorized in writing by ASUS; or (2) the serial number of the product is defaced or missing.

ASUS PROVIDES THIS MANUAL “AS IS” WITHOUT WARRANTY OF ANY KIND, EITHER EXPRESS OR IMPLIED, INCLUDING BUT NOT LIMITED TO THE IMPLIED WARRANTIES OR CONDITIONS OF MERCHANTABILITY OR FITNESS FOR A PARTICULAR PURPOSE. IN NO EVENT SHALL ASUS, ITS DIRECTORS, OFFICERS, EMPLOYEES OR AGENTS BE LIABLE FOR ANY INDIRECT, SPECIAL, INCIDENTAL, OR CONSEQUENTIAL DAMAGES (INCLUDING DAMAGES FOR LOSS OF PROFITS, LOSS OF BUSINESS, LOSS OF USE OR DATA, INTERRUPTION OF BUSINESS AND THE LIKE), EVEN IF ASUS HAS BEEN ADVISED OF THE POSSIBILITY OF SUCH DAMAGES ARISING FROM ANY DEFECT OR ERROR IN THIS MANUAL OR PRODUCT.

SPECIFICATIONS AND INFORMATION CONTAINED IN THIS MANUAL ARE FURNISHED FOR INFORMATIONAL USE ONLY, AND ARE SUBJECT TO CHANGE AT ANY TIME WITHOUT NOTICE, AND SHOULD NOT BE CONSTRUED AS A COMMITMENT BY ASUS. ASUS ASSUMES NO RESPONSIBILITY OR LIABILITY FOR ANY ERRORS OR INACCURACIES THAT MAY APPEAR IN THIS MANUAL, INCLUDING THE PRODUCTS AND SOFTWARE DESCRIBED IN IT.

Products and corporate names appearing in this manual may or may not be registered trademarks or copyrights of their respective companies, and are used only for identification or explanation and to the owners’ benefit, without intent to infringe.

# Contents

Notices .....	vii
Safety information .....	viii
About this guide .....	ix
K8N4-E Deluxe specifications summary .....	xi

## Chapter 1: Product introduction

1.1	Welcome! .....	1-1
1.2	Package contents .....	1-1
1.3	Special features .....	1-2
1.3.1	Product highlights .....	1-2
1.3.2	ASUS Proactive feature .....	1-5
1.3.3	Innovative ASUS features .....	1-5

## Chapter 2: Hardware information

2.1	Before you proceed .....	2-1
2.2	Motherboard overview .....	2-2
2.2.1	Placement direction .....	2-2
2.2.2	Screw holes .....	2-2
2.2.3	Motherboard layout .....	2-3
2.2.4	Layout Contents .....	2-4
2.3	Central Processing Unit (CPU) .....	2-6
2.4	System memory .....	2-8
2.4.1	Overview .....	2-8
2.4.2	Memory Configurations .....	2-8
2.4.3	Installing a DDR DIMM .....	2-12
2.4.4	Removing a DDR DIMM .....	2-12
2.5	Expansion slots .....	2-13
2.5.1	Installing an expansion card .....	2-13
2.5.2	Configuring an expansion card .....	2-13
2.5.3	Interrupt assignments .....	2-14
2.5.4	PCI slots .....	2-15
2.5.5	PCI Express x16 slot .....	2-15
2.5.6	PCI Express x1 slot .....	2-15

# Contents

2.6	Jumpers .....	2-16
2.7	Connectors .....	2-18
2.7.1	Rear panel connectors .....	2-18
2.7.2	Internal connectors.....	2-20

## Chapter 3: Powering up

3.1	Starting up for the first time .....	3-1
3.2	Powering off the computer .....	3-2
3.2.1	Using the OS shut down function .....	3-2
3.2.2	Using the dual function power switch .....	3-2
3.3	ASUS POST Reporter™ .....	3-3
3.3.1	Vocal POST messages .....	3-3
3.3.2	Winbond Voice Editor .....	3-5

## Chapter 4: BIOS setup

4.1	Managing and updating your BIOS .....	4-1
4.1.1	Creating a bootable floppy disk .....	4-1
4.1.2	AwardBIOS Flash Utility .....	4-2
4.1.3	ASUS EZ Flash utility .....	4-6
4.1.4	ASUS CrashFree BIOS 2 utility .....	4-7
4.1.5	ASUS Update utility .....	4-8
4.2	BIOS Setup program .....	4-11
4.2.1	BIOS menu bar .....	4-12
4.2.2	Legend bar .....	4-12
4.3	Main Menu .....	4-14
4.3.1	System Time .....	4-14
4.3.2	System Date .....	4-14
4.3.3	Language .....	4-14
4.3.4	Legacy Diskette A .....	4-14
4.3.5	HDD SMART Monitoring .....	4-15
4.3.6	Installed Memory .....	4-15
4.3.7	Primary and Secondary IDE Master/Slave .....	4-15
4.3.8	First, Second, Third, and Fourth SATA Master .....	4-17

# Contents

4.4	Advanced Menu .....	4-19
4.4.1	CPU configuration .....	4-20
4.4.2	PCI/PnP .....	4-22
4.4.3	Onboard device configuration .....	4-24
4.4.4	JumperFree Configuration .....	4-30
4.4.5	LAN Cable Status .....	4-32
4.4.6	PEG Link Mode .....	4-33
4.4.7	Speech Configuration .....	4-34
4.4.8	Instant Music .....	4-35
4.5	Power Menu .....	4-36
4.5.1	ACPI Suspend Type .....	4-36
4.5.2	ACPI APIC Support .....	4-36
4.5.3	APM configuration .....	4-37
4.5.4	Hardware monitor .....	4-40
4.6	Boot Menu .....	4-41
4.6.1	Boot Device Priority .....	4-41
4.6.2	Removable drives .....	4-42
4.6.3	Hard Disk Drives .....	4-42
4.6.4	CD-ROM drives .....	4-43
4.6.5	Boot settings configuration .....	4-43
4.6.6	Security .....	4-45
4.7	Exit menu .....	4-46

# Contents

## Chapter 5: Software support

5.1	Installing an operating system .....	5-1
5.2	Support CD information .....	5-1
5.2.1	Running the support CD .....	5-1
5.2.2	Drivers menu .....	5-2
5.2.3	Utilities menu .....	5-3
5.2.4	Manuals menu .....	5-5
5.2.5	ASUS Contact information .....	5-6
5.2.6	Other information .....	5-6
5.3	Software information .....	5-8
5.3.1	ASUS MyLogo2™ .....	5-8
5.3.2	AI NET2 .....	5-10
5.3.3	ASUS Instant Music .....	5-11
5.3.4	Cool 'n' Quiet!™ Technology .....	5-14
5.3.5	Audio configurations .....	5-17
5.3.6	Using the NVIDIA® Firewall™ .....	5-24
5.3.7	Using the NVIDIA® nTune™ utility .....	5-27
5.4	RAID configurations .....	5-31
5.4.1	Installing hard disks .....	5-32
5.4.2	NVIDIA® RAID configurations .....	5-33
5.4.3	Silicon Image RAID configurations .....	5-40
5.5	Creating a RAID driver disk .....	5-50

## Notices

### Federal Communications Commission Statement

This device complies with Part 15 of the FCC Rules. Operation is subject to the following two conditions:

- This device may not cause harmful interference, and
- This device must accept any interference received including interference that may cause undesired operation.

This equipment has been tested and found to comply with the limits for a Class B digital device, pursuant to Part 15 of the FCC Rules. These limits are designed to provide reasonable protection against harmful interference in a residential installation. This equipment generates, uses and can radiate radio frequency energy and, if not installed and used in accordance with manufacturer's instructions, may cause harmful interference to radio communications. However, there is no guarantee that interference will not occur in a particular installation. If this equipment does cause harmful interference to radio or television reception, which can be determined by turning the equipment off and on, the user is encouraged to try to correct the interference by one or more of the following measures:

- Reorient or relocate the receiving antenna.
- Increase the separation between the equipment and receiver.
- Connect the equipment to an outlet on a circuit different from that to which the receiver is connected.
- Consult the dealer or an experienced radio/TV technician for help.



---

The use of shielded cables for connection of the monitor to the graphics card is required to assure compliance with FCC regulations. Changes or modifications to this unit not expressly approved by the party responsible for compliance could void the user's authority to operate this equipment.

---

### Canadian Department of Communications Statement

This digital apparatus does not exceed the Class B limits for radio noise emissions from digital apparatus set out in the Radio Interference Regulations of the Canadian Department of Communications.

**This class B digital apparatus complies with Canadian ICES-003.**

# Safety information

## Electrical safety

- To prevent electrical shock hazard, disconnect the power cable from the electrical outlet before relocating the system.
- When adding or removing devices to or from the system, ensure that the power cables for the devices are unplugged before the signal cables are connected. If possible, disconnect all power cables from the existing system before you add a device.
- Before connecting or removing signal cables from the motherboard, ensure that all power cables are unplugged.
- Seek professional assistance before using an adapter or extension cord. These devices could interrupt the grounding circuit.
- Make sure that your power supply is set to the correct voltage in your area. If you are not sure about the voltage of the electrical outlet you are using, contact your local power company.
- If the power supply is broken, do not try to fix it by yourself. Contact a qualified service technician or your retailer.

## Operation safety

- Before installing the motherboard and adding devices on it, carefully read all the manuals that came with the package.
- Before using the product, make sure all cables are correctly connected and the power cables are not damaged. If you detect any damage, contact your dealer immediately.
- To avoid short circuits, keep paper clips, screws, and staples away from connectors, slots, sockets and circuitry.
- Avoid dust, humidity, and temperature extremes. Do not place the product in any area where it may become wet.
- Place the product on a stable surface.
- If you encounter technical problems with the product, contact a qualified service technician or your retailer.



## About this guide

This user guide contains the information you need when installing and configuring the motherboard.

## How this guide is organized

This user guide contains the following parts:

- **Chapter 1: Product introduction**  
This chapter describes the features of the motherboard and the new technology it supports.
- **Chapter 2: Hardware information**  
This chapter lists the hardware setup procedures that you have to perform when installing system components. It includes description of the switches, jumpers, and connectors on the motherboard.
- **Chapter 3: Powering up**  
This chapter describes the power up sequence, the vocal POST messages, and ways of shutting down the system.
- **Chapter 4: BIOS setup**  
This chapter tells how to change system settings through the BIOS Setup menus. Detailed descriptions of the BIOS parameters are also provided.
- **Chapter 5: Software support**  
This chapter describes the contents of the support CD that comes with the motherboard package.

## Where to find more information

Refer to the following sources for additional information and for product and software updates.

### 1. ASUS websites

The ASUS website provides updated information on ASUS hardware and software products. Refer to the ASUS contact information.

### 2. Optional documentation

Your product package may include optional documentation, such as warranty flyers, that may have been added by your dealer. These documents are not part of the standard package.

## Conventions used in this guide

To make sure that you perform certain tasks properly, take note of the following symbols used throughout this manual.



**DANGER/WARNING:** Information to prevent injury to yourself when trying to complete a task.



**CAUTION:** Information to prevent damage to the components when trying to complete a task.



**IMPORTANT:** Instructions that you **MUST** follow to complete a task.



**NOTE:** Tips and additional information to help you complete a task.

## Typography

**Bold text**

Indicates a menu or an item to select.

*Italics*

Used to emphasize a word or a phrase.

<Key>

Keys enclosed in the less-than and greater-than sign means that you must press the enclosed key.

Example: <Enter> means that you must press the Enter or Return key.

<Key1+Key2+Key3>

If you must press two or more keys simultaneously, the key names are linked with a plus sign (+).

Example: <Ctrl+Alt+D>

**Command**

Means that you must type the command exactly as shown, then supply the required item or value enclosed in brackets.

Example: At the DOS prompt, type the command line:

```
afudos /i[filename]
```

```
afudos /iK8N4-E.ROM
```

## K8N4-E Deluxe specifications summary

<b>CPU</b>	Socket 754 for AMD Athlon™ 64/AMD Sempron™ processors AMD64 architecture enables simultaneous 32- and 64-bit computing Supports AMD Cool 'n' Quiet™ Technology
<b>Chipset</b>	NVIDIA® nForce™4-4X
<b>System bus</b>	1 600 MT per second
<b>Memory</b>	3 x 184-pin DIMM sockets support unbuffered non-ECC 400/333/266 MHz DDR memory modules Supports up to 3GB system memory
<b>Expansion slots</b>	1 x PCI Express™ x16 slot for discrete graphics card 3 x PCI Express™ x1 slots 3 x PCI slots
<b>Storage</b>	NVIDIA® nForce™4-4X chipset supports: <ul style="list-style-type: none"> <li>- 4 x Ultra DMA 133/100/66/33 hard disks</li> <li>- 4 x Serial ATA hard disks with RAID 0, RAID 1, RAID 0+1, and JBOD configurations</li> </ul> Silicon Image Sil3114 RAID controller supports: <ul style="list-style-type: none"> <li>- 4 x Serial ATA 1 hard disks with RAID 0, RAID 1, RAID 10, and RAID 5 configurations</li> </ul>
<b>AI Audio</b>	Realtek® ALC850 High Definition Audio solution with 8-channel CODEC Audio Sensing and Enumeration Technology support 3 x Universal Audio Jacks (UAJ®) 1 x Coaxial S/PDIF out port 1 x Optical S/PDIF out port
<b>IEEE 1394a</b>	T1 IEEE 1394a controller supports two IEEE 1394a ports
<b>USB</b>	Supports up to 10 USB 2.0 ports
<b>LAN</b>	Marvell® 88E81111 Gigabit LAN PHY Supports Marvell® Virtual Cable Tester Technology
<b>BIOS features</b>	4 Mb Flash ROM, Phoenix-AWARD BIOS, PnP, DMI2.0, SM BIOS 2.3, WfM2.0
<b>ASUS AI Proactive Feature</b>	AI NET 2

*(continued on the next page)*

## K8N4-E Deluxe specifications summary

<b>Special features</b>	ASUS CrashFree BIOS 2 ASUS Instant Music ASUS Q-Fan 2 ASUS POST Reporter ASUS Multi-language BIOS ASUS MyLogo™ 2 NVIDIA® Firewall
<b>Overclocking features</b>	ASUS AI Overclocking (intelligent CPU frequency tuner) ASUS PEG Link for single graphics card ASUS C.P.R. (CPU Parameter Recall) Precision Tweaker: <ul style="list-style-type: none"> <li>- DIMM voltage: 9-step DRAM voltage control</li> <li>- vCore: Adjustable CPU voltage at 0.0125 increment</li> <li>- Stepless Frequency Selection (SFS) allows FSB tuning from 200 MHz up to 400 MHz at 1 MHz increment</li> <li>- PCIe Frequency allows PCI Express frequency adjustment from 100 MHz up to 200 MHz at 1 MHz increment</li> </ul>
<b>Internal connectors</b>	1 x Floppy disk drive connector 1 x Primary IDE connector 1 x Secondary IDE connector 4 x Serial ATA connectors 4 x Serial ATA RAID connectors 1 x CPU fan connector 1 x Chipset fan connector 2 x Chassis fan connectors 1 x Power fan connector 3 x USB 2.0 connectors 1 x IEEE 1394a connector 1 x 24-pin ATX power connector 1 x 4-pin ATX 12 V power connector 1 x CD audio connector 1 x AUX connector 1 x Game/MIDI port connector 1 x Chassis intrusion connector 1 x Front panel audio connector 1 x System panel connector

*(continued on the next page)*

## K8N4-E Deluxe specifications summary

<b>Rear panel</b>	1 x PS/2 mouse port 1 x Parallel port 1 x IEEE 1394a port 1 x LAN (RJ-45) port 4 x USB 2.0 ports 1 x Serial (COM1) port 1 x Optical S/PDIF out port 1 x Coaxial S/PDIF Out port 1 x PS/2 keyboard port 8-Channel audio ports
<b>Support CD contents</b>	Drivers ASUS PC Probe II ASUS Live Update ASUS Cool 'n' Quiet!™ utility NVIDIA® nTune™ utility Anti-virus software (OEM version)
<b>Form factor</b>	ATX form factor: 12 in x 9.6 in (30.5 cm x 24.5 cm)

\*Specifications are subject to change without notice.



This chapter describes the motherboard features and the new technologies it supports.

# Product introduction



# Chapter summary



1.1	Welcome! .....	1-1
1.2	Package contents .....	1-1
1.3	Special features .....	1-2



## 1.1 Welcome!

Thank you for buying an ASUS® K8N4-E Deluxe motherboard!

The motherboard delivers a host of new features and latest technologies, making it another standout in the long line of ASUS quality motherboards!

Before you start installing the motherboard, and hardware devices on it, check the items in your package with the list below.

## 1.2 Package contents

Check your motherboard package for the following items.

<b>Motherboard</b>	ASUS K8N4-E Deluxe motherboard
<b>I/O module</b>	1 x 2-port USB 2.0/Game module 1 x 4-port USB 2.0 module 1 x IEEE 1394a module
<b>Cables</b>	1 x 4-in-1 FDD/IDE/ATA cable 3 x Serial ATA signal cables 3 x Serial ATA power cable
<b>Accessory</b>	I/O shield
<b>Application CD</b>	ASUS motherboard support CD Intervideo® WinDVD® Suite (OEM version)
<b>Documentation</b>	User guide



If any of the above items is damaged or missing, contact your retailer.

## 1.3 Special features

### 1.3.1 Product highlights

#### Latest processor technology



The motherboard comes with a 754-pin surface mount, Zero Insertion Force (ZIF) socket that supports AMD Athlon™ 64/AMD Sempron™ processors. With an integrated low-latency high-bandwidth memory controller and a highly-scalable HyperTransport™ technology-based system bus, the motherboard provides a powerful platform for your diverse computing needs, increased office productivity, and enhanced digital media experience. See page 2-6.

#### NVIDIA® nForce™4-4X chipset



The NVIDIA® nForce™4-4X chipset supports the vital interfaces of the motherboard in a single chip architecture for 64-bit platforms. The NVIDIA® nForce™4-4X chipset features PCI Express™ support for the latest graphics and expansion cards, increased security with NVIDIA® Firewall™, and advanced storage solutions with NVIDIA® RAID technology for faster and more reliable computing.

#### Built-in NVFirewall™



The NVIDIA® Firewall™ (NVFirewall™) is an easy-to-use high-performance desktop firewall application that protects your system from intruders. Integrated into the NVIDIA® nForce4®-4X chipset with the NVIDIA® Gigabit Ethernet, it provides advanced anti-computer-hacking technologies, remote management capabilities, and a user-friendly setup wizard that improves overall system security. See page 5-24 for details.

#### AMD Cool 'n' Quiet!™ Technology



The motherboard supports the AMD Cool 'n' Quiet!™ Technology that dynamically and automatically changes the CPU speed, voltage, and amount of power depending on the task the CPU performs. See page 5-14 for details.

## PCI Express™ interface

The motherboard fully supports PCI Express, the latest I/O interconnect technology that speeds up the PCI bus. PCI Express features point-to-point serial interconnections between devices and allows higher clockspeeds by carrying data in packets. This high speed interface is software compatible with existing PCI specifications. See page 2-15 for details.

## S/PDIF digital sound ready

The motherboard supports the S/PDIF Out function through the S/PDIF interfaces on the rear panel and at midboard. The S/PDIF technology turns your computer into a high-end entertainment system with digital connectivity to powerful audio and speaker systems. See page 2-19 for details.

## 8-channel high definition audio

Onboard is the Realtek ALC850 High Definition Audio solution with 8-channel CODEC, featuring Audio Sensing and Enumeration Technology support. With the CODEC, 8-channel audio ports, and S/PDIF interfaces, you can connect your computer to home theater decoders to produce crystal-clear digital audio.

The Realtek ALC850 audio CODEC comes with a software application that features jack detection to monitor the plugging status of each jack, impedance sensing to determine audio device classes, and pre-defined equalization for various audio devices. See page 5-17 for details.

## Serial ATA technology

The motherboard supports the Serial ATA technology through the Serial ATA interfaces and the NVIDIA® nForce™4-4X chipset. The Serial ATA specification allows for thinner, more flexible cables with lower pin count, reduced voltage requirement, and up to 150 MB/s data transfer rate. See page 2-22 for details.

## Dual RAID solution



Onboard RAID controllers provide the motherboard with dual-RAID functionality that allows you to select the best RAID solution using Serial ATA devices.

The NVIDIA® nForce™4-4X chipset allows four Serial ATA hard disks with RAID 0, RAID 1, RAID 1+0, and JBOD configurations. See section “5.4.2 NVIDIA® RAID configurations” for details

The Silicon Image Sil3114 RAID controller supports RAID 0, RAID 1, RAID 0+1, and RAID 5 configurations for four Serial ATA hard disks. See page 2-23 and section “5.4.3 Silicon Image RAID configurations” for details.

## Gigabit LAN

The motherboard comes with a Gigabit LAN controller built into the NVIDIA® nForce™4-4X chipset to meet your growing networking needs. The controller uses the PCI Express segment to provide faster data bandwidth for your Internet, LAN, and file sharing requirements. See page 2-18 for details.

## IEEE 1394a support



The IEEE 1394a interface provides high-speed and flexible PC connectivity to a wide range of peripherals and devices compliant to IEEE 1394a standards. The IEEE 1394a interface allows up to 400 Mbps transfer rates through simple, low-cost, high-bandwidth asynchronous (real-time) data interfacing between computers, peripherals, and consumer electronic devices such as camcorders, VCRs, printers, TVs, and digital cameras. See pages 2-18 and 2-28 for details.

## USB 2.0 technology

The motherboard implements the Universal Serial Bus (USB) 2.0 specification, dramatically increasing the connection speed from the 12 Mbps bandwidth on USB 1.1 to a fast 480 Mbps on USB 2.0. USB 2.0 is backward compatible with USB 1.1. See pages 2-19 and 2-25 for details.

## 1.3.2 ASUS Proactive features

### AI NET 2

AI NET 2 is a BIOS-based diagnostic tool that detects and reports Ethernet cable faults and shorts. With this utility, you can easily monitor the condition of the Ethernet cable(s) connected to the LAN (RJ-45) port(s). During the bootup process, AI NET 2 immediately diagnoses the LAN cable(s) and reports shorts and faults up to 100 meters at 1 meter accuracy. See page 5-10 for details.

### AI Audio technology

The motherboard supports 8-channel audio through the onboard ALC850 CODEC with 16-bit DAC, a stereo 16-bit ADC, and an AC97 2.3 compatible multi-channel audio designed for PC multimedia systems. It also provides Jack-Sensing function, S/PDIF out support, interrupt capability and includes the Realtek® proprietary UAJ® (Universal Audio Jack) technology. See pages 2-18 and 5-17 for details.

## 1.3.3 Innovative ASUS features

### ASUS CrashFree BIOS 2

This feature allows you to restore the original BIOS data from the support CD in case when the BIOS codes and data are corrupted. This protection eliminates the need to buy a replacement ROM chip. See page 4-7 for details.

### ASUS Q-Fan 2 technology

The ASUS Q-Fan 2 technology smartly adjusts the CPU fan speed according to the system loading to ensure quiet, cool, and efficient operation. See page 4-40 for details.

## ASUS POST Reporter™



The motherboard offers a new exciting feature called the ASUS POST Reporter™ to provide friendly voice messages and alerts during the Power-On Self-Tests (POST) informing you of the system boot status and causes of boot errors, if any. The bundled Winbond Voice Editor software lets you to customize the voice messages in different languages. See page 3-3 for details.

## ASUS Multi-language BIOS



The multi-language BIOS allows you to select the language of your choice from the available options. The localized BIOS menus allow you to configure easier and faster. Visit the ASUS website for information on the supported languages. See page 4-14 for details.

## ASUS EZ Flash BIOS



With the ASUS EZ Flash, you can easily update the system BIOS even before loading the operating system. No need to use a DOS-based utility or boot from a floppy disk. See page 4-6 for details.

## ASUS MyLogo2™



This feature allows you to personalize and add style to your system with customizable boot logos. See page 4-44 for details.

## ASUS Instant Music



This unique feature allows you to play back audio files even before entering the operating system. Just press the ASUS Instant Music special function keys and enjoy the music! See page 5-11 for details.

## Intervideo® WinDVD® Suite



Bundled with the motherboard is Intervideo® WinDVD® Suite, the multimedia software package that includes the latest DVD playback, creator, and copy utilities.

This chapter lists the hardware setup procedures that you have to perform when installing system components. It includes description of the jumpers and connectors on the motherboard.

# Hardware information



## Chapter summary



2.1	Before you proceed .....	2-1
2.2	Motherboard overview .....	2-2
2.3	Central Processing Unit (CPU) .....	2-6
2.4	System memory .....	2-8
2.5	Expansion slots .....	2-13
2.6	Jumpers .....	2-16
2.7	Connectors .....	2-18



## 2.1 Before you proceed

Take note of the following precautions before you install motherboard components or change any motherboard settings.



- Unplug the power cord from the wall socket before touching any component.
- Use a grounded wrist strap or touch a safely grounded object or a metal object, such as the power supply case, before handling components to avoid damaging them due to static electricity
- Hold components by the edges to avoid touching the ICs on them.
- Whenever you uninstall any component, place it on a grounded antistatic pad or in the bag that came with the component.
- **Before you install or remove any component, ensure that the ATX power supply is switched off or the power cord is detached from the power supply.** Failure to do so may cause severe damage to the motherboard, peripherals, and/or components.

### Onboard LED

The motherboard comes with a standby power LED that lights up to indicate that the system is ON, in sleep mode, or in soft-off mode. This is a reminder that you should shut down the system and unplug the power cable before removing or plugging in any motherboard component. The illustration below shows the location of the onboard LED.

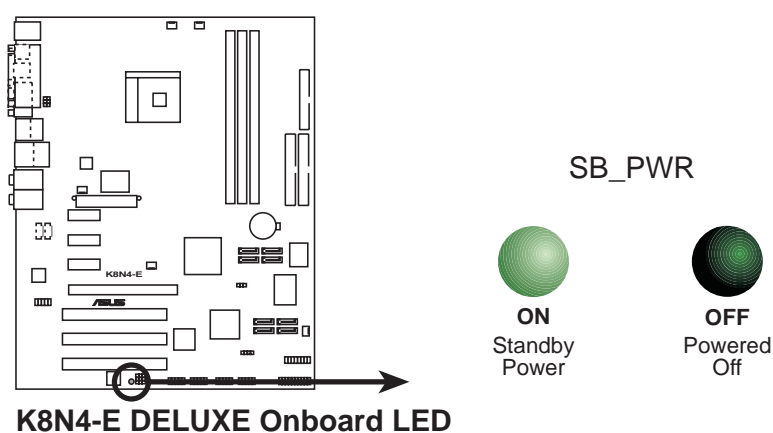

## 2.2 Motherboard overview

Before you install the motherboard, study the configuration of your chassis to ensure that the motherboard fits into it. Refer to the chassis documentation before installing the motherboard.



---

Make sure to unplug the power cord before installing or removing the motherboard. Failure to do so can cause you physical injury and damage motherboard components.

---

### 2.2.1 Placement direction

When installing the motherboard, make sure that you place it into the chassis in the correct orientation. The edge with external ports goes to the rear part of the chassis as indicated in the image below.

### 2.2.2 Screw holes

Place nine (9) screws into the holes indicated by circles to secure the motherboard to the chassis.



---

Do not overtighten the screws! Doing so can damage the motherboard.

---

Place this side towards  
the rear of the chassis

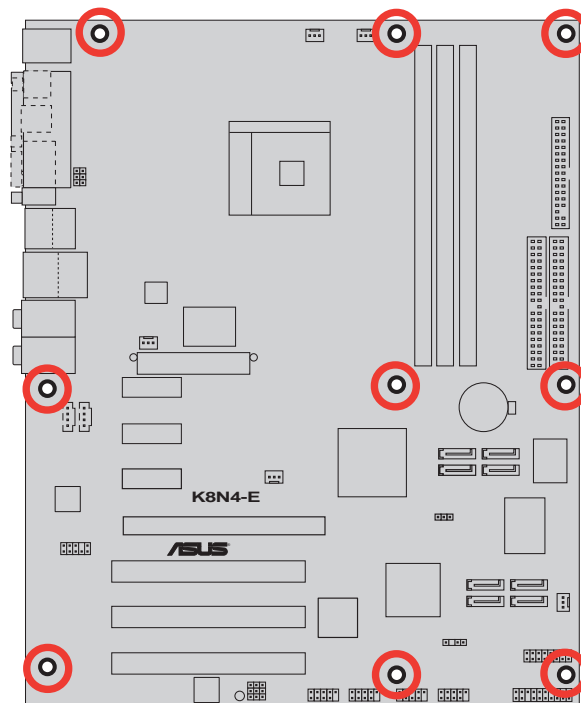

## 2.2.3 Motherboard layout

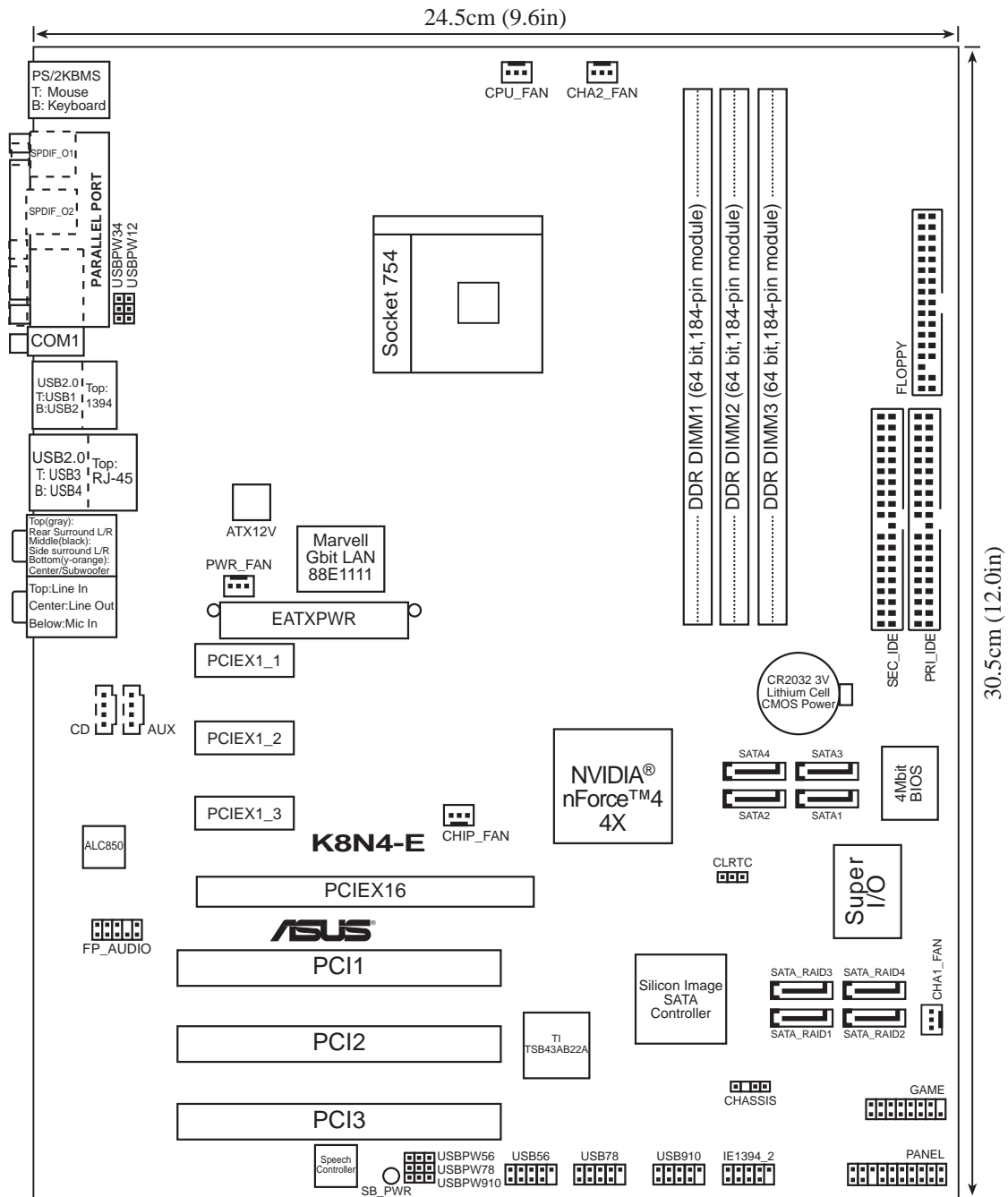

## 2.2.4 Layout Contents

Slots	Page
1. DDR DIMM slots	2-8
2. PCI slots	2-15
3. PCI Express slots	2-15

Jumpers	Page
1. Clear RTC RAM (3-pin CLRTC1)	2-16
2. USB device wake-up (3-pin USBPW12, USBPW34, USBPW56, USBPW78, USBPW910)	2-17

Rear panel connectors	Page
1. PS/2 mouse port	2-18
2. Parallel port	2-18
3. IEEE 1394a port	2-18
4. LAN (RJ-45) port	2-18
5. Rear Speaker Out port	2-18
6. Side Speaker Out port	2-18
7. Line In port	2-18
8. Line Out port	2-18
9. Microphone port	2-19
10. Center/Subwoofer port	2-19
11. USB 2.0 ports 3 and 4	2-19
12. USB 2.0 ports 1 and 2	2-19
13. Serial (COM1) port	2-19
14. Optical S/PDIF Out port	2-19
15. Coaxial S/PDIF Out port	2-19
16. PS/2 keyboard port	2-19

<b>Internal connectors</b>	<b>Page</b>
1. Floppy disk drive connector (34-1 pin FLOPPY)	2-20
2. IDE connectors (40-1 pin PRI_IDE, SEC_IDE)	2-21
3. Serial ATA connectors (7-pin SATA1 [black], SATA2 [black], SATA3 [black], SATA4 [black])	2-22
4. Serial ATA RAID connectors (7-pin SATA_RAID1 [red], SATA_RAID2 [red], SATA_RAID3 [red], SATA_RAID4 [red])	2-23
5. CPU fan connector (3-pin CPU_FAN)	2-24
6. Chassis fan connectors (3-pin CHA1_FAN, 3-pin CHA2_FAN)	2-24
7. Chipset fan connector (3-pin CHIP_FAN)	2-24
8. Power fan connector (3-pin PWR_FAN)	2-24
9. USB connectors (10-1 pin USB56, USB78, USB910)	2-25
10. ATX power connectors (24-pin EATXPWR, 4-pin ATX12V)	2-26
11. Internal audio connectors (4-pin CD, AUX)	2-27
12. GAME/MIDI port connector (16-1 pin GAME)	2-27
13. Chassis intrusion connector (4-1 pin CHASSIS)	2-28
14. IEEE 1394a connector (10-1 pin IE1394_2)	2-28
15. Front panel audio connector (10-1 pin 2 x 5-pin FP_AUDIO)	2-29
16. System panel connector (20-pin PANEL) - System Power LED (Green 3-pin PLED) - Hard Disk activity (Red 2-pin IDE_LED) - System warning speaker (Orange 4-pin SPEAKER) - Power/Soft-off button (Yellow 2-pin PWRSW) - Reset switch (Blue 2-pin RESET)	2-30

## 2.3 Central Processing Unit (CPU)

The motherboard comes with a surface mount 754-pin Zero Insertion Force (ZIF) socket designed for the AMD Athlon™ 64/AMD Sempron™ processor.

Take note of the marked corner (with gold triangle) on the CPU. This mark should match a specific corner on the socket to ensure correct installation.

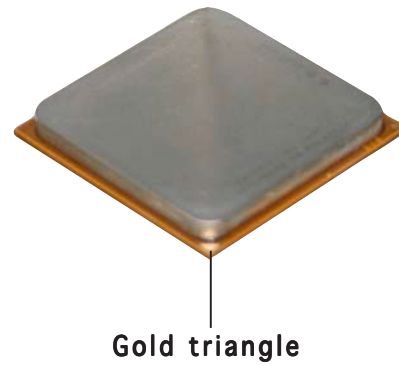

Incorrect installation of the CPU into the socket may bend the pins and severely damage the CPU!

### Installing the CPU

To install a CPU:

1. Locate the 754-pin ZIF socket on the motherboard.

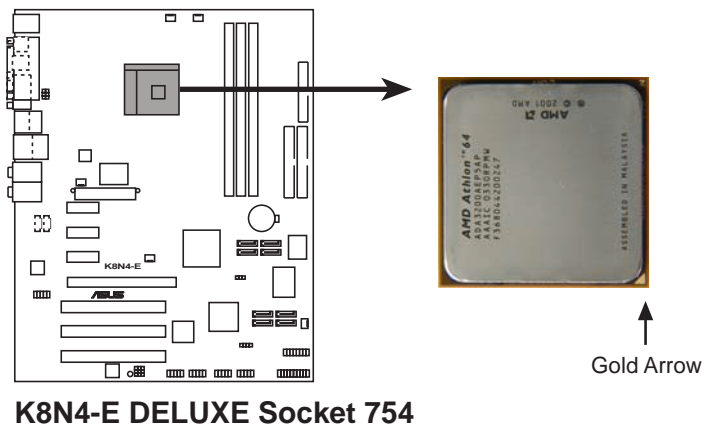

2. Unlock the socket by pressing the lever sideways, then lift it up to a 90°-100° angle.



Make sure that the socket lever is lifted up to 90°-100° angle; otherwise the CPU does not fit in completely.

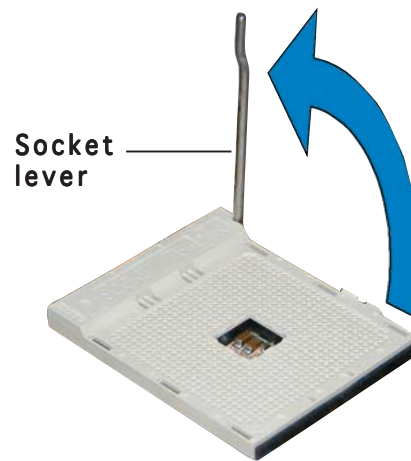

3. Position the CPU above the socket such that the CPU corner with the gold triangle matches the socket corner with a small triangle.

4. Carefully insert the CPU into the socket until it fits in place.

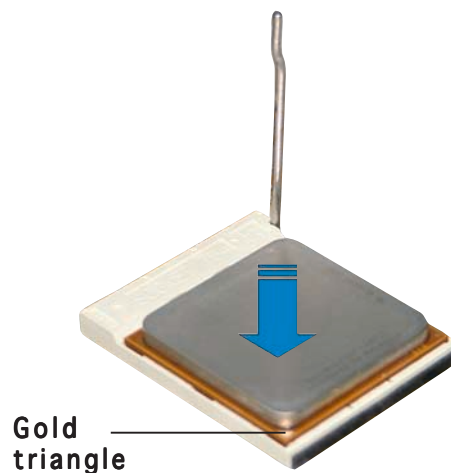

5. When the CPU is in place, push down the socket lever to secure the CPU. The lever clicks on the side tab to indicate that it is locked.

6. Install a CPU heatsink and fan following the instructions that came with the heatsink package.

7. Connect the CPU fan cable to the CPU\_FAN connector on the motherboard.

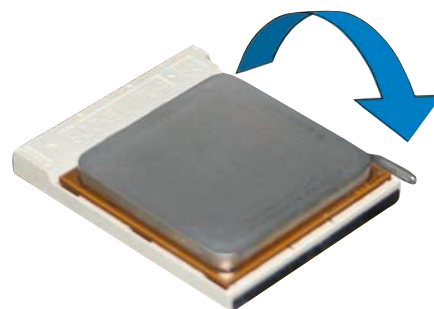

## 2.4 System memory

### 2.4.1 Overview

The motherboard comes with three 184-pin Double Data Rate (DDR) Dual Inline Memory Modules (DIMM) sockets.

The following figure illustrates the location of the sockets:

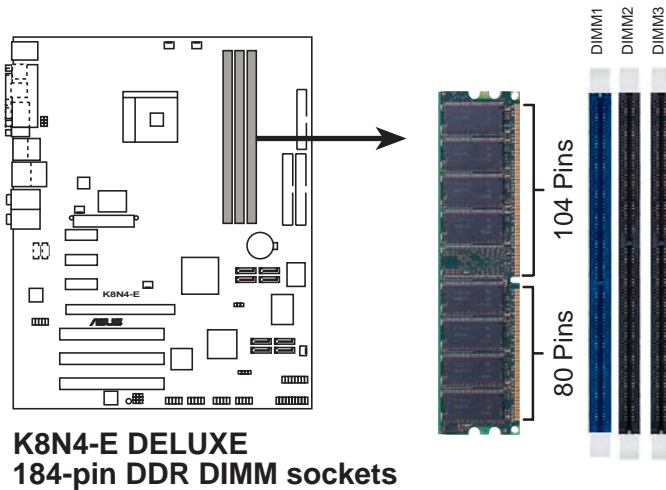

### 2.4.2 Memory Configurations

You may install 256 MB, 512 MB, and 1 GB unbuffered non-ECC DDR DIMMs into the DIMM sockets using the memory configurations in this section.



- Installing DDR DIMMs other than the recommended configurations may cause memory sizing error or system boot failure. Use any of the recommended configurations on the next page.
- Always install DIMMs with the same CAS latency. For optimum compatibility, we recommend that you obtain memory modules from the same vendor.
- Due to chipset resource allocation, the system may detect less than 3 GB system memory when you installed three 1 GB DDR memory modules.
- This motherboard does not support memory modules made up of 128 Mb chips or double sided x16 memory modules.



## Recommended DDR memory configurations

Number of DIMMs	DIMM slot			Max Speed
	DIMM1	DIMM2	DIMM3	
1	Single side	-	-	DDR 400
1	-	Single side	-	DDR 400
1	-	-	Single side	DDR 400
1	Double side	-	-	DDR 400
1	-	Double side	-	DDR 400
1	-	-	Double side	DDR 400
2	Single side	Single side	-	DDR 400
2	Single side	Double side	-	DDR 400
2	Single side	-	Single side	DDR 400
2	Single side	-	Double side	DDR 400
2	Double side	Single side	-	DDR 400
2	Double side	Double side	-	DDR 400
2	Double side	-	Single side	DDR 400
2	-	Single side	Single side	DDR 333
2	-	Single side	Double side	DDR 200
2	-	Double side	Single side	DDR 200
2	-	Double side	Double side	DDR 200
2	Double side	-	Double side	DDR 400
3	Single side	Single side	Single side	DDR 333
3	Single side	Single side	Double side	DDR 200
3	Single side	Double side	Single side	DDR 200
3	Single side	Double side	Double side	DDR 200
3	Double side	Single side	Single side	DDR 333
3	Double side	Single side	Double side	DDR 200
3	Double side	Double side	Single side	DDR 200
3	Double side	Double side	Double side	DDR 200

## DDR (400 MHz) Qualified Vendors List

							DIMM support
Size	Vendor	Model	Brand	Side/s*	Component	CL	
256MB	KINGSTON	KVR400X64C3A/256	Hynix	SS	HY5DU56822BT-D43	-	
512MB	KINGSTON	KVR400X64C3A/512	Hynix	DS	HY5DU56822BT-D43	-	
256MB	KINGSTON	KVR400X72C3A/256	Mosel	SS	V58C2256804SAT5(ECC)	-	
512MB	KINGSTON	KVR400X72C3A/512	Mosel	DS	V58C2256804SAT5(ECC)	-	
256MB	KINGSTON	KVR400X64C3A/256	Infineon	SS	HYB25D256800BT-5B	-	
512MB	KINGSTON	KVR400X64C3A/512	Infineon	DS	HYB25D256809BT-5B	-	
256MB	KINGSTON	KVR400X64C3A/256	KINGSTON	SS	D3208DL2T-5	-	
512MB	KINGSTON	KHX3200A/512	-	DS	-	3	
1024MB	KINGSTON	KVR400X64C3A/1G	-	DS	HYB25D512800BE-5B	3	
1024MB	KINGSTON	KHX3200ULK2/1G	-	DS	-	2	
256MB	SAMSUNG	M381L3223ETM-CCC	SAMSUNG	SS	K4H560838E-TCCC(ECC)	3ECC	
512MB	SAMSUNG	M381L6423ETM-CCC	SAMSUNG	DS	K4H560838E-TCCC(ECC)	-	
256MB	SAMSUNG	M368L3223ETM-CCC	SAMSUNG	SS	K4H560838E-TCCC	-	
256MB	SAMSUNG	M368L3223FTN-CCC	SAMSUNG	SS	K4H560838F-TCCC	4	
512MB	SAMSUNG	M368L6423FTN-CCC	SAMSUNG	DS	K4H560838F-TCCC	4	
512MB	SAMSUNG	M368L6523BTM-CCC	SAMSUNG	SS	K4H510838B-TCCC	4	
256MB	MICRON	MT8VDDT3264AG-40BCB	MICRON	SS	MT46V32M8TG-5BC	-	
512MB	MICRON	MT16VDDT6464AG-40BCB	MICRON	DS	MT46V32M8TG-5BC	-	
256MB	Infineon	HYS64D32300HU-5-C	Infineon	SS	HYB25D256800CE-5C	3	
512MB	Infineon	HYS64D64320HU-5-C	Infineon	DS	HYB25D256800CE-5C	-	
256MB	CORSAIR	CMX256A-3200C2PT	Winbond	SS	W942508BH-5	2	
512MB	CORSAIR	VS512MB400	VALUE seLecT	DS	VS32M8-5 2.5		
512MB	CORSAIR	CMX512-3200C2	-	DS	-	3	
1024MB	CORSAIR	TWINX2048-3200C2	-	DS	-	-	
256MB	Hynix	HYMD232645D8J-D43	Hynix	SS	HY5DU56822DT-D43	3	
512MB	Hynix	HYMD264646D8J-D43	Hynix	DS	HY5DU56822DT-D43	3	
256MB	TwinMOS	M2G9I08AIATT9F081AADT	TwinMOS	SS	TMD7608F8E50D	2.5	
512MB	TwinMOS	M2G9J16AJATT9F081AADT	TwinMOS	DS	TMD7608F8E50D	2.5	
256MB	TwinMOS	M2G9I08A8ATT9F081AADT	TwinMOS	SS	TMD7608F8E50D	2.5	
512MB	TwinMOS	M2G9J16A8ATT9F081AADT	TwinMOS	DS	TMD7608F8E50D	2.5	
256MB	Transcend	TS32MLD64V4F3	SAMSUNG	SS	K4H560838F-TCCC	3	
512MB	Transcend	TS64MLD64V4F3	SAMSUNG	DS	K4H560838F-TCCC	3	
1024MB	Transcend	TS128MLD64V4J	SAMSUNG	DS	K4H510838B-TCCC	3	
256MB	Apacer	77.10636.33G	Infineon	SS	HYB25D256800CE-5C	3	
512MB	Apacer	77.10736.33G	Infineon	DS	HYB25D256800CE-5C	3	
256MB	Apacer	77.10639.60G	ProMOS	SS	V58C2256804SCT5B	2.5	
512MB	Apacer	77.10739.60G	ProMOS	DS	V58C2256804SCT5B	2.5	
256MB	A DATA	MDOSS6F3G31Y0K1E0Z	SAMSUNG	SS	K4H560838E-TCCC	3	
512MB	A DATA	MDOSS6F3H41Y0N1E0Z	SAMSUNG	DS	K4H560838F-TCCC	3	
256MB	A DATA	MDOHY6F3G31Y0N1E0Z	Hynix	SS	HY5DU56822CT-D43	3	
512MB	A DATA	MDOHY6F3H41Y0N1E0Z	Hynix	DS	HY5DU56822CT-D43	3	
256MB	A DATA	MDOAD5F3G31Y0D1E02	-	SS	ADD8608A8A-5B	2.5	
512MB	A DATA	MDOAD5F3H41Y0D1E02	-	DS	ADD8608A8A-5B	2.5	
256MB	Winbond	W9425GCDB-5	Winbond	SS	W942508CH-5	3	
512MB	Winbond	W9451GCDB-5	Winbond	DS	W942508CH-5	-	
256MB	PSC	AL5D8B53T-5B1K	PSC	SS	A2S56D30BTP	2.5	

## DDR (400 MHz) Qualified Vendors List

							DIMM support
Size	Vendor	Model	Brand	Side/s*	Component	CL	
512MB	PSC	AL6D8B53T-5B1K	PSC	DS	A2S56D30BTP	2.5	
256MB	KINGMAX	MPXB62D-38KT3R	-	SS	KDL388P4LA-50	-	
512MB	KINGMAX	MPXC22D-38KT3R	-	DS	KDL388P4LA-50	-	
256MB	NANYA	NT256D64S88COG-5T	-	SS	NT5DS32M8CT-5T	3	
512MB	NANYA	NT512D64S8HCOG-5T	-	DS	NT5DS32M8CT-5T	3	
256MB	BRAIN POWER	B6U808-256M-SAM-400	SAMSUNG	SS	K4H560838D-TCC4	-	
512MB	BRAIN POWER	B6U808-512M-SAM-400	SAMSUNG	DS	K4H560838D-TCC4	-	
256MB	CENTURY	DXV6S8SSCCE3K27E	SAMSUNG	SS	K4H560838E-TCCC	-	
512MB	CENTURY	DXV2S8SSCCE3K27E	SAMSUNG	DS	K4H560838E-TCCC	-	
256MB	CENTURY	DXV6S8EL5BM3T27C	-	SS	DD2508AMTA	-	
512MB	CENTURY	DXV2S8EL5BM3T27C	-	DS	DD2508AMTA	-	
256MB	elixir	M2U25664DS88C3G-5T	-	SS	N2DS25680CT-5T	-	
512MB	elixir	M2U51264DS8HC1G-5T	-	DS	N2DS25680CT-5T	-	
256MB	Kreton	-	VT	SS	VT3225804T-5	-	
512MB	Kreton	-	VT	DS	VT3225804T-5	-	
256MB	Veritech	VT400FMV/2561103	VT	SS	VT56DD32M8PC-5	3	
512MB	Veritech	VT400FMV/5121003	VT	DS	VT56DD32M8PC-5	3	
256MB	Pmi	MD44256VIT3208GMHA01	MOSEL	SS	V58C2256804SAT5B	2.5	
512MB	Pmi	MD44512VIT3208GATA03	MOSEL	DS	V58C2256804SAT5B	2.5	
256MB	ProMOS	V826632K24SCTG-DO	-	SS	V58C2256804SCT5B	2.5	
512MB	ProMOS	V826664K24SCTG-DO	-	DS	V58C2256804SCT5B	2.5	
256MB	Deutron	AL5D8C53T-5B1T	PSC	SS	A2S56D30CTP	2.5	
512MB	Deutron	AL6D8C53T-5B1T	PSC	DS	A2S56D30CTP	2.5	
256MB	GEIL	GL5123200DC	-	SS	GL3LC32G88TG-35	-	
512MB	GEIL	GL1GB3200DC	-	DS	GL3LC32G88TG-35	-	
256MB	GEIL	GLX2563200UP	-	SS	GL3LC32G88TG-5A	-	
256MB	GEIL	GD3200-512DC	-	SS	WLCSP Package	-	
256MB	crucial	BL3264Z402.8TG	Ballistix	SS	-	2	
512MB	crucial	BL6464Z402.16TG	Ballistix	DS	-	2	
256MB	Novax	96M425653CE-40TB6	CEON	SS	C2S56D30TP-5	2.5	
512MB	Novax	96M451253CE-40TB6	CEON	DS	C2S56D30TP-5	2.5	

### Legend:

**SS** - Single-sided

**DS** - Double-sided

**CL** - CAS Latency



Visit the ASUS website ([www.asus.com](http://www.asus.com)) for the latest DDR 400 Qualified Vendors List.

## 2.4.3 Installing a DDR DIMM



Make sure to unplug the power supply before adding or removing DIMMs or other system components. Failure to do so may cause severe damage to both the motherboard and the components.

1. Unlock a DIMM socket by pressing the retaining clips outward.
2. Align a DIMM on the socket such that the notch on the DIMM matches the break on the socket.

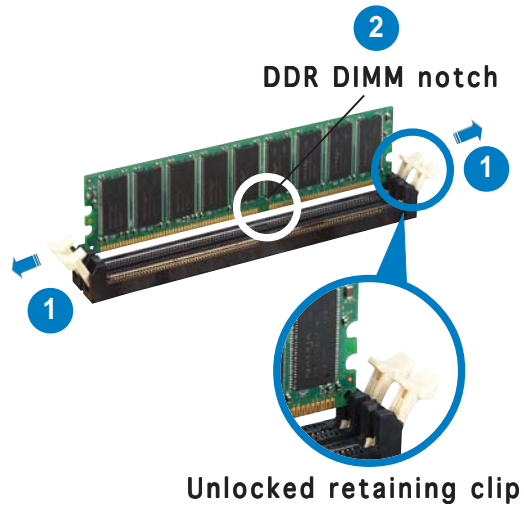

A DDR DIMM is keyed with a notch so that it fits in only one direction. **DO NOT** force a DIMM into a socket to avoid damaging the DIMM.

3. Firmly insert the DIMM into the socket until the retaining clips snap back in place and the DIMM is properly seated.

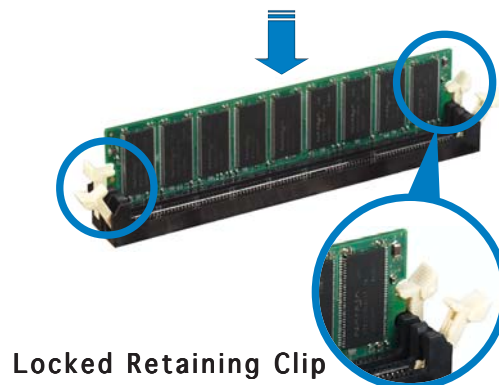

## 2.4.4 Removing a DDR DIMM

To remove a DIMM:

1. Simultaneously press the retaining clips outward to unlock the DIMM.

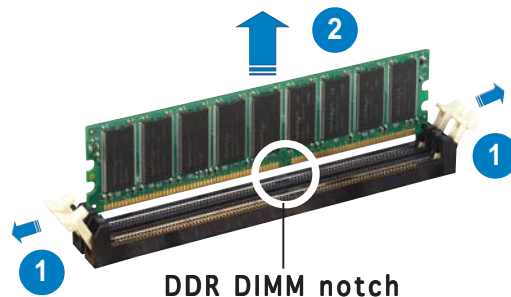

Support the DIMM lightly with your fingers when pressing the retaining clips. The DIMM might get damaged when it flips out with extra force.

2. Remove the DIMM from the socket.

## 2.5 Expansion slots

In the future, you may need to install expansion cards. The following sub-sections describe the slots and the expansion cards that they support.



---

Make sure to unplug the power cord before adding or removing expansion cards. Failure to do so may cause you physical injury and damage motherboard components.

---

### 2.5.1 Installing an expansion card

To install an expansion card:

1. Before installing the expansion card, read the documentation that came with it and make the necessary hardware settings for the card.
2. Remove the system unit cover (if your motherboard is already installed in a chassis).
3. Remove the bracket opposite the slot that you intend to use. Keep the screw for later use.
4. Align the card connector with the slot and press firmly until the card is completely seated on the slot.
5. Secure the card to the chassis with the screw you removed earlier.
6. Replace the system cover.

### 2.5.2 Configuring an expansion card

After installing the expansion card, configure it by adjusting the software settings.

1. Turn on the system and change the necessary BIOS settings, if any. See Chapter 4 for information on BIOS setup.
2. Assign an IRQ to the card. Refer to the tables on the next page.
3. Install the software drivers for the expansion card.

## 2.5.3 Interrupt assignments

### Standard interrupt assignments

IRQ	Priority	Standard Function
0	1	System Timer
1	2	Keyboard Controller
2	—	Programmable Interrupt
3*	11	IRQ holder for PCI steering
4*	12	Communications Port (COM1)
5*	13	IRQ holder for PCI steering
6	14	Floppy Disk Controller
7*	15	Printer Port (LPT1)
8	3	System CMOS/Real Time Clock
9*	4	IRQ holder for PCI steering
10*	5	IRQ holder for PCI steering
11*	6	IRQ holder for PCI steering
12*	7	PS/2 Compatible Mouse Port
13	8	Numeric Data Processor
14*	9	Primary IDE Channel
15*	10	Secondary IDE Channel

\* These IRQs are usually available for ISA or PCI devices.

### IRQ assignments for this motherboard

	A	B	C	D	E	F	G	H
PCI slot 1	shared	—	—	—	—	—	—	—
PCI slot 2	—	shared	—	—	—	—	—	—
PCI slot 3	—	—	shared	—	—	—	—	—
Onboard USB 2.0 controller	shared	—	—	—	—	—	—	—
Onboard LAN1	shared	—	—	—	—	—	—	—
Onboard PCI SATA RAID (SI)	—	—	—	shared	—	—	—	—
Onboard 1394a	shared	—	—	—	—	—	—	—



When using PCI cards on shared slots, ensure that the drivers support “Share IRQ” or that the cards do not need IRQ assignments. Otherwise, conflicts will arise between the two PCI groups, making the system unstable and the card inoperable.

## 2.5.4 PCI slots

The PCI slots support cards such as a LAN card, SCSI card, USB card, and other cards that comply with PCI specifications. The figure shows a LAN card installed on a PCI slot.

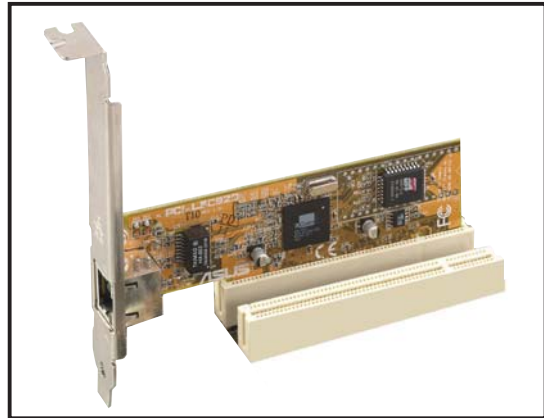

## 2.5.5 PCI Express x16 slot

This motherboard supports PCI Express x16 graphic cards that comply with the PCI Express specifications. The following figure shows a graphics card installed on the PCI Express x16 slot.

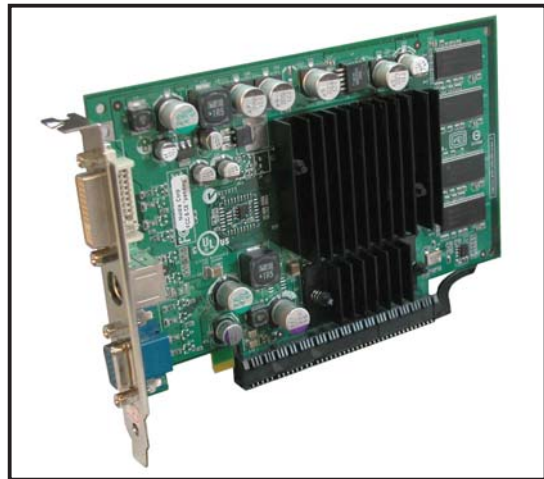

## 2.5.6 PCI Express x1 slot

This motherboard supports PCI Express x1 network cards, SCSI cards, and other cards that comply with the PCI Express specifications. The following figure shows a network card installed on the PCI Express x1 slot.



## 2.6 Jumpers

### 1. Clear RTC RAM (CLRRTC)

This jumper allows you to clear the Real Time Clock (RTC) RAM in CMOS. You can clear the CMOS memory of date, time, and system setup parameters by erasing the CMOS RTC RAM data. The onboard button cell battery powers the RAM data in CMOS, which include system setup information such as system passwords.

To erase the RTC RAM:

1. Turn OFF the computer and unplug the power cord.
2. Remove the onboard battery.
3. Move the jumper cap from pins 1-2 (default) to pins 2-3. Keep the cap on pins 2-3 for about 5~10 seconds, then move the cap back to pins 1-2.
4. Re-install the battery.
5. Plug the power cord and turn ON the computer.
6. Hold down the <Del> key during the boot process and enter BIOS setup to re-enter data.



---

Except when clearing the RTC RAM, never remove the cap on CLRRTC jumper default position. Removing the cap will cause system boot failure!

---

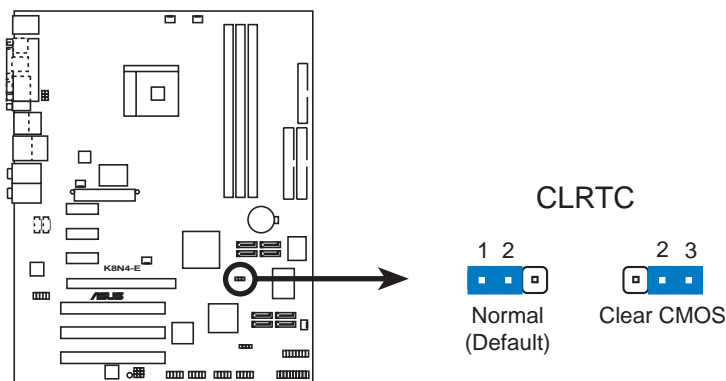

**K8N4-E DELUXE Clear RTC RAM**



---

You do not need to clear the RTC when the system hangs due to overclocking. For system failure due to overclocking, use the C.P.R. (CPU Parameter Recall) feature. Shut down and reboot the system so the BIOS can automatically reset parameter settings to default values.

---



## 2. USB device wake-up (3-pin USBPW12, USBPW34, USBPW56, USBPW78, USBPW910)

Set these jumpers to +5V to wake up the computer from S1 sleep mode (CPU stopped, DRAM refreshed, system running in low power mode) using the connected USB devices. Set to +5VSB to wake up from S3 and S4 sleep modes (no power to CPU, DRAM in slow refresh, power supply in reduced power mode).

The USBPW12 and USBPW34 jumpers are for the rear USB ports. The USBPW56, USBPW78, and USBPW910 jumpers are for the internal USB connectors that you can connect to additional USB ports.

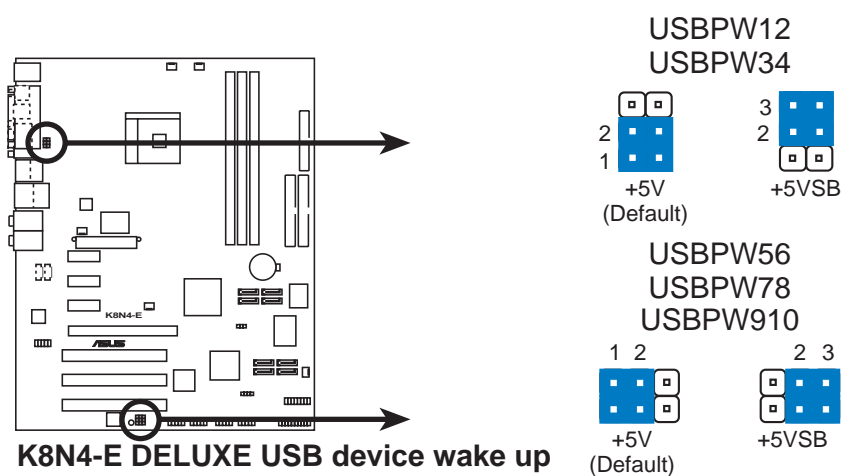

**K8N4-E DELUXE USB device wake up**



- The USB device wake-up feature requires a power supply that can provide 500mA on the +5VSB lead for each USB port; otherwise, the system would not power up.
- The total current consumed must NOT exceed the power supply capability (+5VSB) whether under normal condition or in sleep mode.

## 2.7 Connectors

### 2.7.1 Rear panel connectors

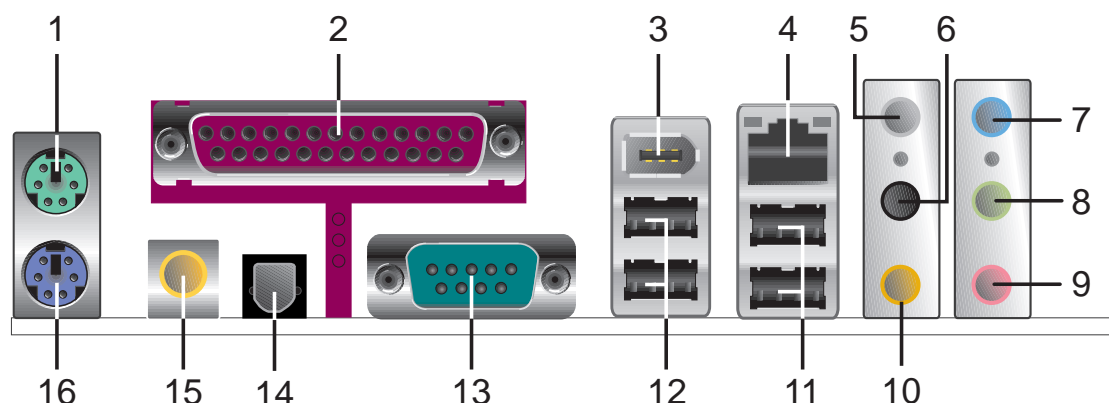

1. **PS/2 mouse port (green).** This port is for a PS/2 mouse.
2. **Parallel port.** This 25-pin port connects a parallel printer, a scanner, or other devices.
3. **IEEE 1394a port.** This 6-pin IEEE 1394a port provides high-speed connectivity for audio/video devices, storage peripherals, PCs, or portable devices.
4. **LAN (RJ-45) port.** This port allows Gigabit connection to a Local Area Network (LAN) through a network hub. Refer to the table below for the LAN port LED indications.

#### LAN port LED indications

ACT/LINK LED		SPEED LED	
Status	Description	Status	Description
OFF	No link	OFF	10Mbps connection
GREEN	Linked	ORANGE	100Mbps connection
BLINKING	Acting	GREEN	1Gbps connection

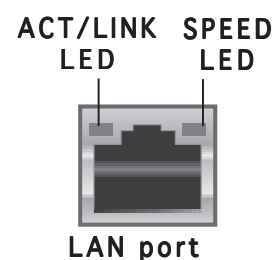

5. **Rear Speaker Out port (gray).** This port connects the rear speakers on a 4-channel, 6-channel, or 8-channel audio configuration.
6. **Side Speaker Out port (black).** This port connects the side speakers in an 8-channel audio configuration.
7. **Line In port (light blue).** This port connects a tape, CD, DVD player, or other audio sources.
8. **Line Out port (lime).** This port connects a headphone or a speaker. In 4-channel, 6-channel, and 8-channel configuration, the function of this port becomes Front Speaker Out.

- 9. Microphone port (pink).** This port connects a microphone.
- 10. Center/Subwoofer port (yellow orange).** This port connects the center/subwoofer speakers.



Refer to the audio configuration table for the function of the audio ports in 2, 4, 6, or 8-channel configuration.

### Audio 2, 4, 6, or 8-channel configuration

Port	Headset 2-channel	4-channel	6-channel	8-channel
Light Blue	Line In	Line In	Line In	Line In
Lime	Line Out	Front Speaker Out	Front Speaker Out	Front Speaker Out
Pink	Mic In	Mic In	Mic In	Mic In
Gray	-	Rear Speaker Out	Rear Speaker Out	Rear Speaker Out
Black	-	-	-	Side Speaker Out
Yellow Orange	-	-	Center/Subwoofer	Center/Subwoofer

- 11. USB 2.0 ports 3 and 4.** These two 4-pin Universal Serial Bus (USB) ports are available for connecting USB 2.0 devices.
- 12. USB 2.0 ports 1 and 2.** These two 4-pin Universal Serial Bus (USB) ports are available for connecting USB 2.0 devices.
- 13. Serial port.** This 9-pin COM1 port is for pointing devices or other serial devices.
- 14. Optical S/PDIF Out port.** This port connects an external audio output device via an optical S/PDIF cable.
- 15. Coaxial S/PDIF Out port.** This port connects an external audio output device via a coaxial S/PDIF cable.
- 16. PS/2 keyboard port (purple).** This port is for a PS/2 keyboard.

## 2.7.2 Internal connectors

### 1. Floppy disk drive connector (34-1 pin FLOPPY)

This connector is for the provided floppy disk drive (FDD) signal cable. Insert one end of the cable to this connector, then connect the other end to the signal connector at the back of the floppy disk drive.



---

Pin 5 on the connector is removed to prevent incorrect cable connection when using an FDD cable with a covered Pin 5.

---

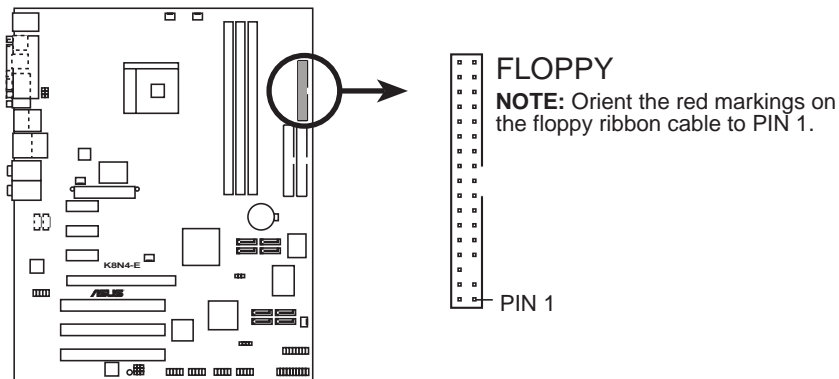

**K8N4-E DELUXE Floppy disk drive connector**

## 2. IDE connectors (40-1 pin PRI\_IDE, SEC\_IDE)

These connectors are for an Ultra DMA 133/100/66 signal cable. The Ultra DMA 133/100/66 signal cable has three connectors: a blue connector for the primary IDE connector on the motherboard, a black connector for an Ultra DMA 133/100/66 IDE slave device (optical drive/hard disk drive), and a gray connector for an Ultra DMA 133/100/66 IDE master device (hard disk drive). If you install two hard disk drives, you must configure the second drive as a slave device by setting its jumper accordingly. Refer to the hard disk documentation for the jumper settings.



- Pin 20 on the IDE connector is removed to match the covered hole on the Ultra DMA cable connector. This prevents incorrect insertion when you connect the IDE cable.
- Use the 80-conductor IDE cable for Ultra DMA 133/100/66 IDE devices.

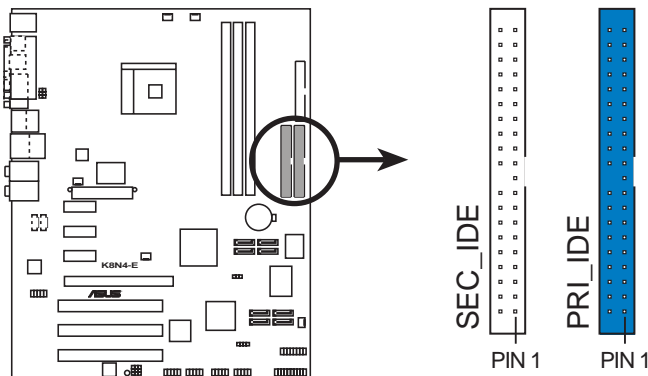

**NOTE:** Orient the red markings (usually zigzag) on the IDE ribbon cable to PIN 1.

**K8N4-E DELUXE IDE connectors**

### 3. Serial ATA connectors (7-pin SATA1 [black], SATA2 [black], SATA3 [black], SATA4 [black])

Supported by the NVIDIA® nForce4-4X chipset, these connectors are for the Serial ATA signal cables for Serial ATA hard disk drives that allow up to 3Gb/s of data transfer rate.

If you installed Serial ATA hard disk drives, you can create RAID 0, RAID 1, RAID 1+0, or JBOD configuration that spans across the Parallel ATA drives. Refer to Chapter 5 for details on how to set up RAID configurations.



These connectors are set to **SATA** by default. In SATA mode, you can connect Serial ATA boot or data hard disk drives to these connectors. If you intend to create a Serial ATA RAID set using these connectors, enable the **RAID** function of each port from the **NVRAID configuration** sub-item in the BIOS. See section “4.4.3 Onboard device configuration” for details.

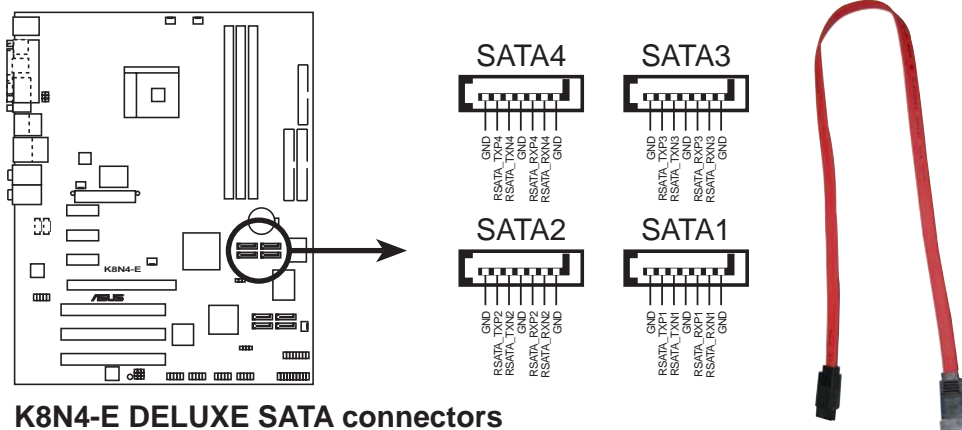

#### Important notes on Serial ATA

- The actual data transfer rate depends on the speed of Serial ATA hard disks installed.
- See the Appendix for instructions on how to install the Serial ATA extension module.

#### 4. Serial ATA RAID connectors (7-pin SATA\_RAID1 [red], SATA\_RAID2 [red], SATA\_RAID3 [red], SATA\_RAID4 [red])

These connectors are for Serial ATA signal cables. These connectors support up to four Serial ATA hard disk drives that you can configure as a disk array through the onboard SATA RAID controller. Refer to Chapter 5 for details on how to set up Serial ATA RAID configurations.



These connectors are set to **RAID Mode** by default. If you want to connect Serial ATA boot/data hard disk drives to these connectors, set the **Silicon SATA Controller** item in the BIOS to [Disabled]. See section “4.4.3 Onboard Device Configuration” for details.

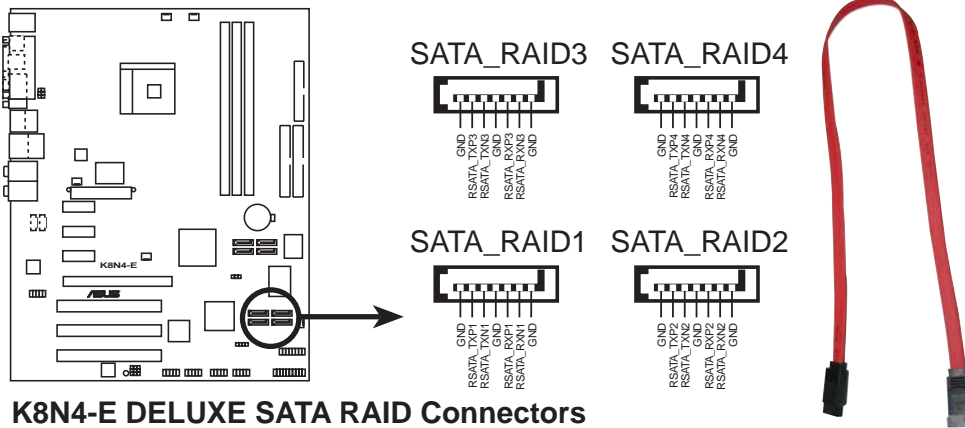

**K8N4-E DELUXE SATA RAID Connectors**



- Before creating a RAID set using Serial ATA hard disks, make sure that you have connected the Serial ATA signal cable and installed Serial ATA hard disk drives; otherwise, you cannot enter the Silicon Image RAID utility and SATA BIOS setup during POST.
- You can only create RAID 5 configuration using the SATALink™ SATA RAID Management software. See Chapter 5 for details. The RAID 5 feature is not Windows® Hardware Quality Labs (WHQL)-certified.

## 5. CPU, Chassis and Power fan connectors (3-pin CPU\_FAN, 3-pin CHA1\_FAN, 3-pin CHA2\_FAN, 3-pin CHIP\_FAN, 3-pin PWR\_FAN)

The fan connectors support cooling fans of 350 mA ~ 2000 mA (24 W max.) or a total of 1 A ~ 3.48 A (41.76 W max.) at +12 V. Connect the fan cables to the fan connectors on the motherboard, making sure that the black wire of each cable matches the ground pin of the connector.



Do not forget to connect the fan cables to the fan connectors. Insufficient air flow inside the system may damage the motherboard components. These are not jumpers! DO NOT place jumper caps on the fan connectors.

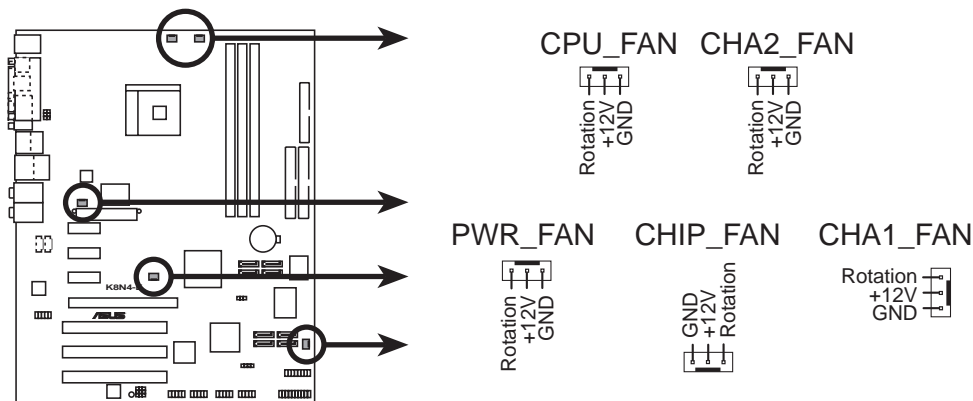

**K8N4-E DELUXE Fan connectors**



## 6. USB connectors (10-1 pin USB56, USB78, USB910)

These connectors are for USB 2.0 ports. Connect the USB/GAME module cable to any of these connectors, then install the module to a slot opening at the back of the system chassis. These USB connectors comply with USB 2.0 specification that supports up to 480 Mbps connection speed.

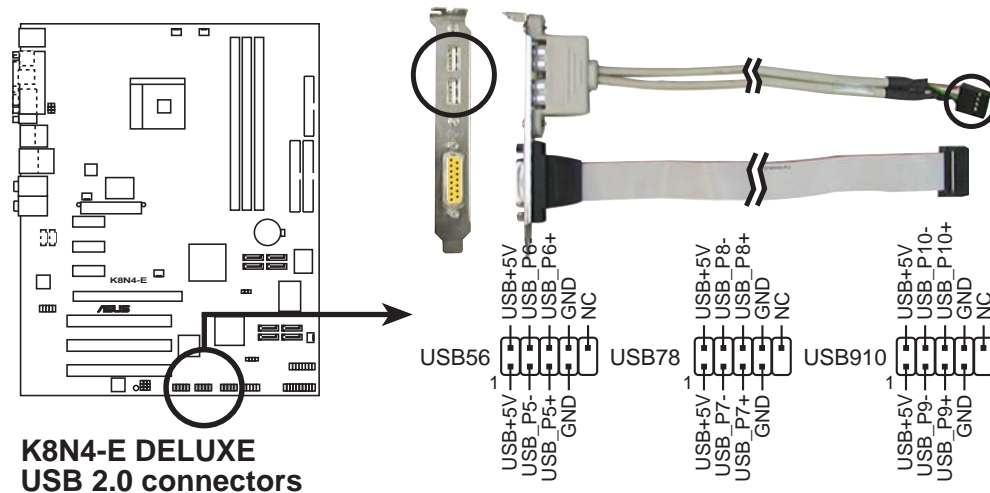

**K8N4-E DELUXE  
USB 2.0 connectors**



Never connect a **1394 cable** to the USB connectors. Doing so will damage the motherboard!

## 7. ATX power connectors (24-pin EATXPWR, 4-pin ATX12V)

These connectors are for an ATX power supply. The plugs from the power supply are designed to fit these connectors in only one orientation. Find the proper orientation and push down firmly until the connectors completely fit.



- 
- We recommend that you use an ATX 12 V Specification 2.0-compliant power supply unit (PSU) with a minimum of 350 W power rating. This PSU type has 24-pin and 4-pin power plugs.
  - If you intend to use a PSU with 20-pin and 4-pin power plugs, make sure that the 20-pin power plug can provide at least 15A on +12V and that the PSU has a minimum power rating of 350 W. The system may become unstable or may not boot up if the power is inadequate.
  - Do not forget to connect the 4-pin ATX +12 V power plug; otherwise, the system will not boot up.
  - We recommend that you use a PSU with higher power output when configuring a system with more power-consuming devices. The system may become unstable or may not boot up if the power is inadequate.
  - The ATX 12 V Specification 2.0-compliant PSU passed the motherboard power requirement test with the following configuration:

CPU	:	Intel® Pentium® 4 3.6 GHz
Memory	:	512 MB DDR (x 4)
Graphics card	:	PCI Express x16 Nvidia EN5900
Parallel ATA devices:	:	IDE hard disk drive (x 2)
Serial ATA device	:	SATA hard disk drive
Optical drives	:	CD-ROM (x 2)
SCSI devices	:	SCSI card and SCSI hard disk drive
  - You must install a PSU with a higher power rating if you intend to install additional devices.
-

## 8. Internal audio connectors (4-pin CD, AUX)

These connectors allow you to receive stereo audio input from sound sources such as a CD-ROM, TV tuner, or MPEG card.

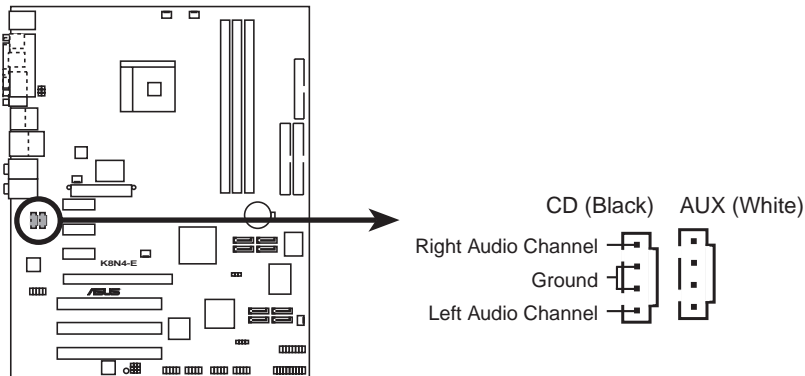

**K8N4-E DELUXE Internal audio connectors**

## 9. GAME/MIDI port connector (16-1 pin GAME)

This connector is for a GAME/MIDI port. Connect the USB/GAME module cable to this connector, then install the module to a slot opening at the back of the system chassis. The GAME/MIDI port connects a joystick or game pad for playing games, and MIDI devices for playing or editing audio files.

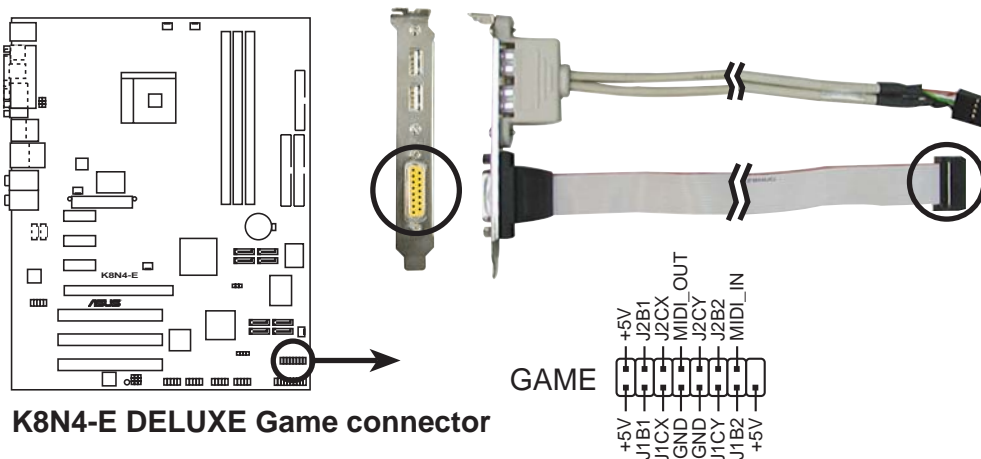

**K8N4-E DELUXE Game connector**

## 10. Chassis intrusion connector (4-1 pin CHASSIS)

This connector is for a chassis-mounted intrusion detection sensor or switch. Connect one end of the chassis intrusion sensor or switch cable to this connector. The chassis intrusion sensor or switch sends a high-level signal to this connector when a chassis component is removed or replaced. The signal is then generated as a chassis intrusion event.

By default, the pins labeled “Chassis Signal” and “Ground” are shorted with a jumper cap. Remove the jumper caps only when you intend to use the chassis intrusion detection feature.

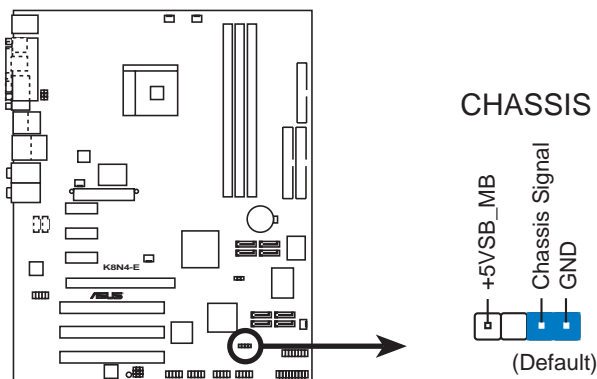

**K8N4-E DELUXE Chassis intrusion connector**

## 11. IEEE 1394a connector (10-1 pin IE1394\_2)

This connector is for an IEEE 1394a port. Connect the IEEE 1394a module cable to this connector, then install the module to a slot opening at the back of the system chassis.

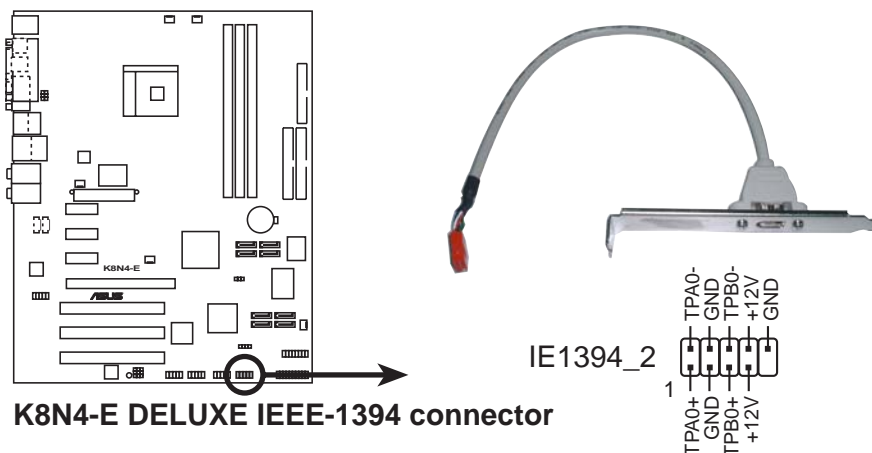

**K8N4-E DELUXE IEEE-1394 connector**



NEVER connect a **USB cable** to the IEEE 1394a connector. Doing so will damage the motherboard!

## 12. Front panel audio connector (10-1 pin 2 x 5-pin FP\_AUDIO)

This connector is for a chassis-mounted front panel audio I/O module that supports either HD Audio or legacy AC '97 audio standard. Connect one end of the front panel audio I/O module cable to this connector.

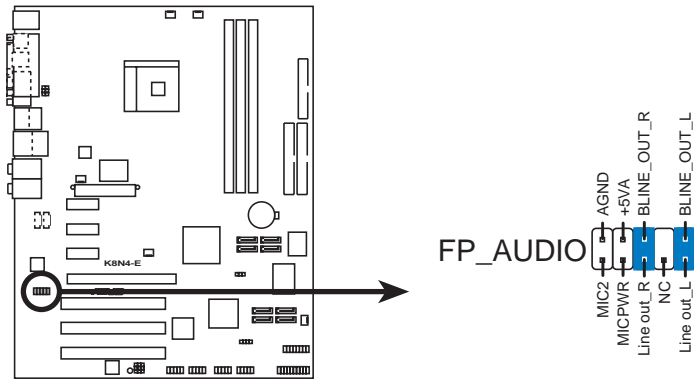

**K8N4-E DELUXE Front panel audio connector**



---

We recommend that you connect a high-definition front panel audio module to this connector to avail of the motherboard's high-definition audio capability.

---

### 13. System panel connector (20-pin PANEL)

This connector supports several chassis-mounted functions.

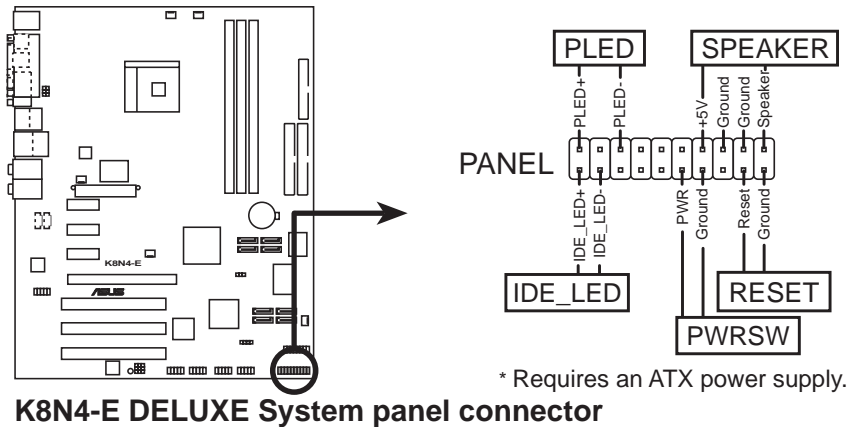

The system panel connector is color-coded for easy connection. Refer to the connector description below for details.

- **System power LED (Green 3-pin PLED)**  
This 3-pin connector is for the system power LED. Connect the chassis power LED cable to this connector. The system power LED lights up when you turn on the system power, and blinks when the system is in sleep mode.
- **Hard disk drive activity (Red 2-pin IDE\_LED)**  
This 2-pin connector is for the HDD Activity LED. Connect the HDD Activity LED cable to this connector. The IDE LED lights up or flashes when data is read from or written to the HDD.
- **System warning speaker (Orange 4-pin SPEAKER)**  
This 4-pin connector is for the chassis-mounted system warning speaker. The speaker allows you to hear system beeps and warnings.
- **Power/Soft-off button (Yellow 2-pin PWRSW)**  
This connector is for the system power button. Pressing the power button turns the system ON or puts the system in SLEEP or SOFT-OFF mode depending on the BIOS settings. Pressing the power switch for more than four seconds while the system is ON turns the system OFF.
- **Reset button (Blue 2-pin RESET)**  
This 2-pin connector is for the chassis-mounted reset button for system reboot without turning off the system power.

This chapter describes the power up sequence, the vocal POST messages, and ways of shutting down the system.

# Powering up

## Chapter summary



3.1	Starting up for the first time .....	3-1
3.2	Powering off the computer .....	3-2
3.3	ASUS POST Reporter™ .....	3-3
3.3.1	Vocal POST messages .....	3-3
3.3.2	Winbond Voice Editor .....	3-5



## 3.1 Starting up for the first time

1. After making all the connections, replace the system case cover.
2. Be sure that all switches are off.
3. Connect the power cord to the power connector at the back of the system chassis.
4. Connect the power cord to a power outlet that is equipped with a surge protector.
5. Turn on the devices in the following order:
  - a. Monitor
  - b. External SCSI devices (starting with the last device on the chain)
  - c. System power
6. After applying power, the system power LED on the system front panel case lights up. For systems with ATX power supplies, the system LED lights up when you press the ATX power button. If your monitor complies with “green” standards or if it has a “power standby” feature, the monitor LED may light up or switch between orange and green after the system LED turns on.

The system then runs the power-on self tests or POST. While the tests are running, the BIOS beeps (see BIOS beep codes table below) or additional messages appear on the screen. If you do not see anything within 30 seconds from the time you turned on the power, the system may have failed a power-on test. Check the jumper settings and connections or call your retailer for assistance.

7. At power on, hold down the <Delete> key to enter the BIOS Setup. Follow the instructions in Chapter 4.

## 3.2 Powering off the computer

### 3.2.1 Using the OS shut down function

If you are using Windows® 2000:

1. Click the **Start** button then click **Shut Down...**
2. Make sure that the **Shut Down** option button is selected, then click the **OK** button to shut down the computer.
3. The power supply should turn off after Windows® shuts down.

If you are using Windows® XP:

1. Click the **Start** button then select **Turn Off Computer.**
2. Click the **Turn Off** button to shut down the computer.
3. The power supply should turn off after Windows® shuts down.

### 3.2.2 Using the dual function power switch

While the system is ON, pressing the power switch for less than four seconds puts the system to sleep mode or to soft-off mode, depending on the BIOS setting. Pressing the power switch for more than four seconds lets the system enter the soft-off mode regardless of the BIOS setting. Refer to section “4.5 Power Menu” in Chapter 4 for details.

## 3.3 ASUS POST Reporter™

This motherboard includes the Winbond speech controller to support a special feature called the ASUS POST Reporter™. This feature gives you vocal POST messages and alerts you of system events and boot status. In case of a boot failure, you will hear the specific cause of the problem.

These POST messages are customizable using the Winbond Voice Editor software that came with your package. You can record your own messages to replace the default messages.

### 3.3.1 Vocal POST messages

Following is a list of the default POST messages and the corresponding actions you can take:

POST Message	Action
No CPU installed	<ul style="list-style-type: none"><li>• Install a supported processor into the CPU socket. See section “2.3 Central Processing Unit (CPU)” for supported processors.</li></ul>
System failed CPU test	<ul style="list-style-type: none"><li>• Check the CPU if properly installed.</li><li>• Call ASUS technical support for assistance. See the “ASUS contact information” on the inside front cover of this manual.</li></ul>
System failed memory test	<ul style="list-style-type: none"><li>• Install supported DDR DIMMs into the sockets.</li><li>• Check if the DIMMs on the DIMM sockets are properly installed.</li><li>• Make sure that your DIMMs are not defective.</li><li>• Refer to section “2.4 System memory” for instructions on installing a DIMM.</li></ul>
System failed VGA test	<ul style="list-style-type: none"><li>• Install a PCI VGA card into one of the PCI slots, or a 1.5V AGP card into the AGP slot.</li><li>• Make sure that your VGA/AGP card is not defective.</li></ul>
System failed due to CPU overclocking	<ul style="list-style-type: none"><li>• Check your CPU settings in the BIOS and set only to the recommended</li></ul>
No keyboard detected	<ul style="list-style-type: none"><li>• Check if your keyboard is properly connected to the purple PS/2 connector on the rear panel.</li><li>• See section “2.7.1 Rear panel connectors” for the location of the connector.</li></ul>
No IDE hard disk detected	<ul style="list-style-type: none"><li>• Make sure you have connected an IDE hard disk drive to one of the IDE connectors on the motherboard.</li></ul>

POST Message	Action
CPU temperature too high	<ul style="list-style-type: none"> <li>• Check if the CPU fan is working properly.</li> </ul>
CPU fan failed	<ul style="list-style-type: none"> <li>• Check the CPU fan and make sure it turns on after you apply power to the system.</li> <li>• Make sure that your CPU fan supports the fan speed detection function.</li> </ul>
CPU voltage out of range	<ul style="list-style-type: none"> <li>• Check your power supply and make sure it is not defective.</li> <li>• Call ASUS technical support for assistance. See the “ASUS contact information” on the inside front cover of this manual.</li> </ul>
System completed Power-On Self Test	<ul style="list-style-type: none"> <li>• No action required</li> </ul>
Computer now booting from operating system	<ul style="list-style-type: none"> <li>• No action required</li> </ul>



---

You can disable the ASUS POST Reporter™ in the BIOS setup. See section “4.4.7 Speech configuration.”

---

## 3.3.2 Winbond Voice Editor

The Winbond Voice Editor software allows you to customize the vocal POST messages. Install the software from the utilities menu of the support CD. See section “5.2.3 Utilities menu” for details.



---

To avoid conflicts, do not run the Winbond Voice Editor while running the ASUS PC Probe.

---

Follow these steps to use the Winbond Voice Editor.

### Launching the program

Launch the program either from the Winbond Voice Editor icon on your desktop, or from the Windows Start menu, select **Programs->Winbond Voice Editor->Voice Editor**.

The Winbond Voice Editor screen appears.

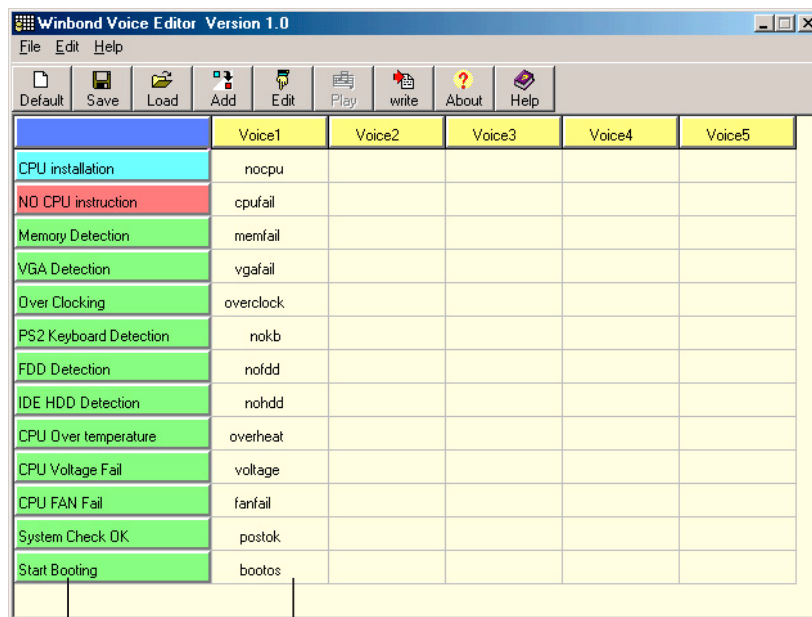

**POST Events    Default Messages**

### Playing the default wave files

To play the default wave files, simply click on a POST event on the left side of the screen, then click the Play button.



---

The default language setting is English.

---

## Changing the default language

1. Click the **Load** button. A window showing the available languages appears.
2. Select your desired language, then click **Open**. The event messages for the language you selected appear on the Voice Editor screen.

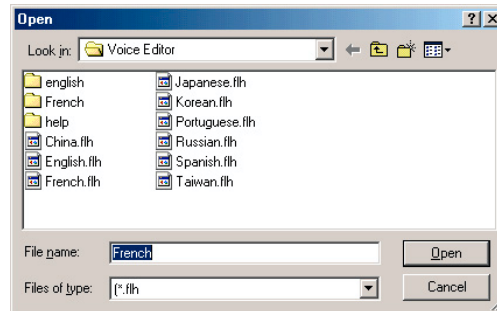

For some languages, not all events have a corresponding message due to file size constraints.

3. Click the **Write** button to update the EEPROM.
4. Click **Yes** on the confirmation window that appears.

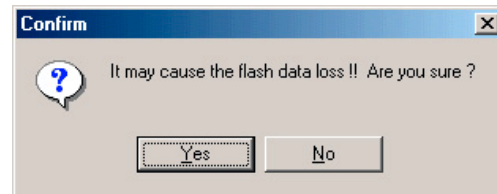

The next time you boot your computer, the POST messages are announced in the language that you selected .

## Customizing your POST messages

If your language is not in the selection or if you wish to record your own POST messages to replace the pre-installed wave files, you may easily do so.

Follow these steps to customize your POST messages.

1. Launch the Voice Editor and note the list of POST events on the leftmost column of the screen.
2. Prepare your message for each event.



The total compressed size for all the wave files must not exceed 1Mbit, so keep your messages as short as possible.

3. Use a recording software, such as Windows Recorder, to record your messages.
4. Save the messages as wave files (.WAV). To keep file sizes small, save your files at a low quality. For example, use 8-bit, mono quality at 22 Khz sampling rate.



You may want to create a separate folder for your wave files so you can locate them easily in one place.

5. From the Voice Editor screen, click the **Add** button to display the Add Wave File window.
6. Copy the wave files that you recorded to the database. Close the window when done.

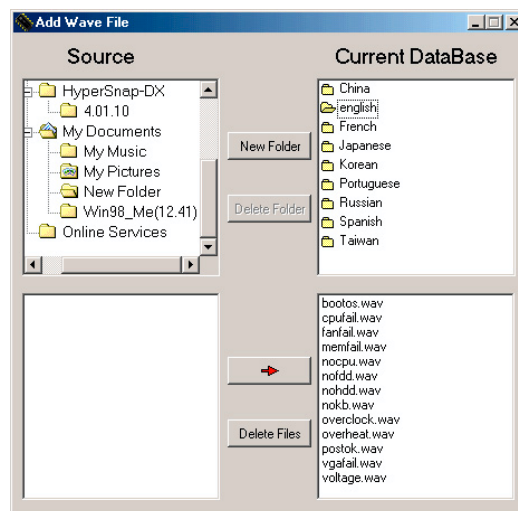

7. Select a POST event on the Voice Editor screen, then click the **Edit** button. The Event Sound Editor window appears.
8. Locate and select your wave file for the event, then click on the arrow opposite Voice1. The file you select appears on the space next to it.
9. Click **OK** to return to the Voice Editor screen.
10. Do steps 7 to 9 for the other events.
11. When done, click **Save**. A window appears prompting you to save your configuration.
12. Type a file name with an **.flh** extension, then click Save.
13. Click the **Write** button to compress the file and copy into the EEPROM.
14. Click **Yes** on the confirmation window that appears.

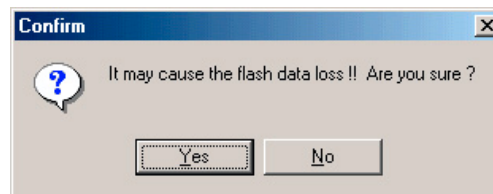
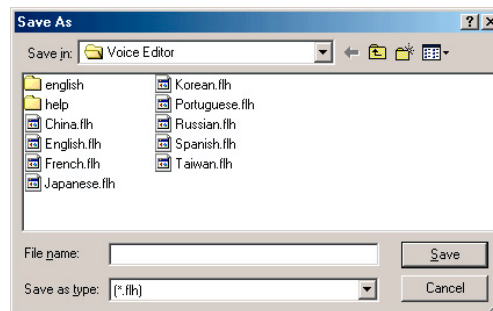
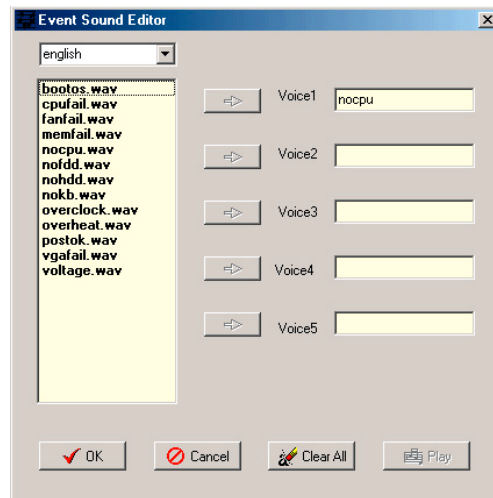

If you receive an error message telling you that the files exceed the total allowable size, do one or all of the following.

- Shorten your messages.
- Save the wave files at a lower quality
- Skip seldom-used events like FDD Detection, IDE HDD Detection, etc.



This chapter tells how to change the system settings through the BIOS Setup menus. Detailed descriptions of the BIOS parameters are also provided.

# BIOS setup

4.1	Managing and updating your BIOS .....	4-1
4.2	BIOS setup program .....	4-11
4.3	Main menu .....	4-14
4.4	Advanced menu .....	4-19
4.5	Power menu .....	4-36
4.6	Boot menu .....	4-41
4.7	Exit menu .....	4-46

## 4.1 Managing and updating your BIOS

The following utilities allow you to manage and update the motherboard Basic Input/Output System (BIOS) setup.

1. **AwardBIOS Flash Utility** (Updates the BIOS using a floppy disk during POST.)
2. **ASUS EZ Flash** (Updates the BIOS using a floppy disk during POST.)
3. **ASUS CrashFree BIOS Utility** (Updates the BIOS using a bootable floppy disk when the BIOS gets corrupted.)
4. **ASUS Update** (Updates the BIOS in Windows® environment.)

Refer to the corresponding section for details on these utilities.

### Important notes



- 
- Save a copy of the **original motherboard BIOS file** to a **bootable floppy disk** in case you need to restore the BIOS in the future. Copy the original motherboard BIOS using the ASUS Update or AFLASH utilities.
  - Visit the system builder's website and download the latest BIOS file for this motherboard using the ASUS Update utility.
- 

#### 4.1.1 Creating a bootable floppy disk

1. Do either one of the following to create a bootable floppy disk.

##### DOS environment

- a. Insert a 1.44 MB floppy disk into the drive.
- b. At the DOS prompt, type `format A:/S` then press <Enter>.

##### Windows® XP environment

- a. Insert a 1.44 MB floppy disk to the floppy disk drive.
- b. Click **Start** from the Windows® desktop, then select **My Computer**.
- c. Select the 3 1/2 Floppy Drive icon.
- d. Click **File** from the menu, then select **Format**. A **Format 3 1/2 Floppy Disk** window appears.
- e. Select **Create an MS-DOS startup disk** from the format options field, then click **Start**.

### Windows® 2000 environment

To create a set of boot disks for Windows® 2000:

- a. Insert a formatted, high density 1.44 MB floppy disk into the drive.
  - b. Insert the Windows® 2000 CD to the optical drive.
  - c. Click **Start**, then select **Run**.
  - d. From the Open field, type  
`D:\bootdisk\makeboot a:`  
assuming that D: is your optical drive.
  - e. Press <Enter>, then follow screen instructions to continue.
2. Copy the original or the latest motherboard BIOS file to the bootable floppy disk.

## 4.1.2 AwardBIOS Flash Utility

The Basic Input/Output System (BIOS) can be updated using the built-in Flash Memory Writer utility or using a bootable floppy disk with the executable Flash Memory Writer Utility (AWDFLASH.EXE). Follow these instructions to update the BIOS using this utility.



---

Save only the updated BIOS file in the floppy disk to avoid loading a wrong BIOS file.

---



---

The succeeding screens are for reference only. The actual displays may not exactly match what you see on your screen.

---

### Updating the BIOS file

1. Download the latest BIOS file from the system builder's website. .  
Rename the file to (BIOS file name on the support CD).BIN and save it to the bootable floppy disk you created earlier.
2. Copy the AwardBIOS Flash Utility (awdf flash.exe) from the Software folder of the support CD to the floppy disk with the latest BIOS file.
3. Boot the system in DOS mode using the bootable floppy disk you created earlier.

4. When the **A:>** appears, replace the bootable floppy disk with the floppy disk containing the new BIOS file and the Award BIOS Flash Utility.
5. At the prompt, type **awdf flash** then press <Enter>. The Award BIOS Flash Utility screen appears.

```
AwardBIOS Flash Utility for ASUS V1.09
(C) Phoenix Technologies Ltd. All Rights Reserved

For NF-CK804-K8N4-E-00      DATE: 12/16/2004
Flash Type - SST 49LF004A/B /3.3V

File Name to Program: 
```

Message: Please input File Name!

6. Type the BIOS file name in the **File Name to Program** field, then press <Enter>.

```
AwardBIOS Flash Utility for ASUS V1.09
(C) Phoenix Technologies Ltd. All Rights Reserved

For NF-CK804-K8N4-E-00      DATE: 12/16/2004
Flash Type - SST 49LF004A/B /3.3V

File Name to Program: 1231A.bin
```

Message: Do You Want To Save Bios (Y/N)

7. The utility prompts you to save the current BIOS file. Press <Y> to save the current BIOS file to the floppy disk, or <N> to continue.



---

If you intend to save the current BIOS file, make sure that the floppy disk has enough disk space to save the file. See the next section for details on saving the current BIOS file.

---

- The utility verifies the BIOS file in the floppy disk and starts flashing the BIOS file.

```
AwardBIOS Flash Utility for ASUS V1.09
(C) Phoenix Technologies Ltd. All Rights Reserved

For NF-CK804-K8N4-E-00      DATE: 12/16/2004
Flash Type - SST 49LF004A/B /3.3V

File Name to Program: 1231A.bin

Program Flashing Memory - OFE00 OK
████████████████████████████████████████████████████████████████████████████████
████████████████████████████████████████████████████████████████████████████████
████████████████████████████████████████████████████████████████████████████████
Write OK      No Update      Write Fail

Warning: Don't Turn Off Power Or Reset System!
```



---

Do not turn off or reset the system during the flashing process!

---

- The utility displays a **Flashing Complete** message indicating that you have successfully flashed the BIOS file. Remove the floppy disk then press <F1> to restart the system.

```
AwardBIOS Flash Utility for ASUS V1.09
(C) Phoenix Technologies Ltd. All Rights Reserved

For NF-CK804-K8N4-E-00      DATE: 12/16/2004
Flash Type - SST 49LF004A/B /3.3V

File Name to Program: 1231A.bin
Flashing Complete
Press <F1> to Continue
████████████████████████████████████████████████████████████████████████████████
████████████████████████████████████████████████████████████████████████████████
████████████████████████████████████████████████████████████████████████████████
Write OK      No Update      Write Fail

F1 Reset
```

## Saving the current BIOS file

You can use the AwardBIOS Flash Utility to save the current BIOS file. You can load the current BIOS file when the BIOS file gets corrupted during the flashing process.

To save the current BIOS file using the AwardBIOS Flash Utility:

1. Follow steps 1 to 6 of the previous section.
2. Press <Y> when the utility prompts you to save the current BIOS file. The following screen appears.

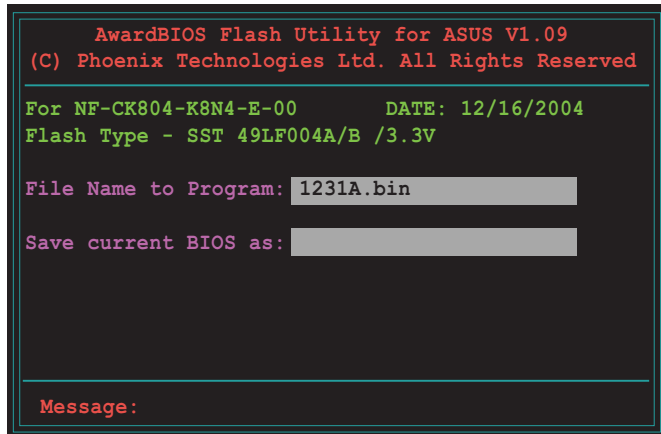

```
AwardBIOS Flash Utility for ASUS V1.09
(C) Phoenix Technologies Ltd. All Rights Reserved

For NF-CK804-K8N4-E-00      DATE: 12/16/2004
Flash Type - SST 49LF004A/B /3.3V

File Name to Program: 1231A.bin
Save current BIOS as:

Message:
```

3. Type a filename for the current BIOS file in the **Save current BIOS as** field, then press <Enter>.

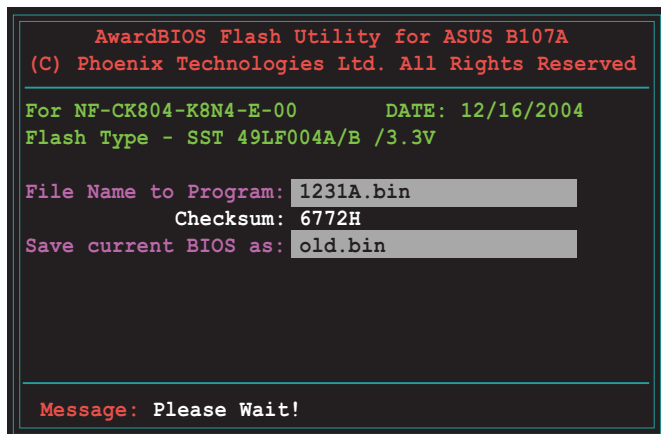

```
AwardBIOS Flash Utility for ASUS B107A
(C) Phoenix Technologies Ltd. All Rights Reserved

For NF-CK804-K8N4-E-00      DATE: 12/16/2004
Flash Type - SST 49LF004A/B /3.3V

File Name to Program: 1231A.bin
Checksum: 6772H
Save current BIOS as: old.bin

Message: Please Wait!
```

4. The utility saves the current BIOS file to the floppy disk, then returns to the BIOS flashing process.

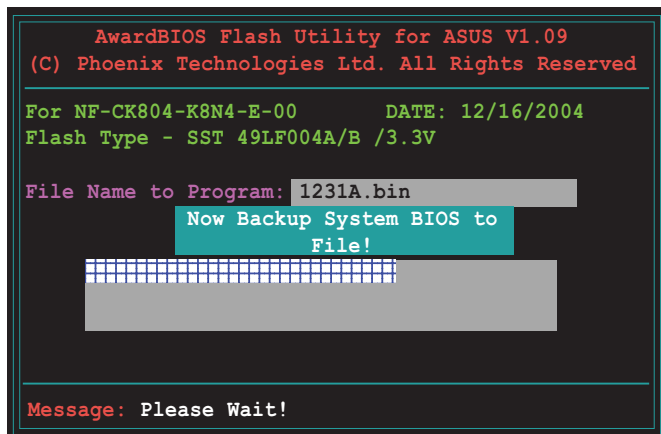

```
AwardBIOS Flash Utility for ASUS V1.09
(C) Phoenix Technologies Ltd. All Rights Reserved

For NF-CK804-K8N4-E-00      DATE: 12/16/2004
Flash Type - SST 49LF004A/B /3.3V

File Name to Program: 1231A.bin
Now Backup System BIOS to
File!

Message: Please Wait!
```

### 4.1.3 ASUS EZ Flash utility

The ASUS EZ Flash feature allows you to update the BIOS without having to go through the long process of booting from a floppy disk and using a DOS-based utility. The EZ Flash utility is built-in the BIOS chip so it is accessible by pressing <Alt> + <F2> during the Power-On Self Tests (POST).

To update the BIOS using EZ Flash:

1. Visit the ASUS website ([www.asus.com](http://www.asus.com)) to download the latest BIOS file for the motherboard and rename the same to **K8N4-E.ROM**.
2. Save the BIOS file to a floppy disk, then restart the system.
3. Press <Alt> + <F2> during POST to display the following.

```
EZFlash starting BIOS update
Checking for floppy...
```

4. Insert the floppy disk that contains the BIOS file to the floppy disk drive. When the correct BIOS file is found, EZ Flash performs the BIOS update process and automatically reboots the system when done.

```
EZFlash starting BIOS update
Checking for floppy...
Floppy found!
Reading file "K8N4-E.ROM". Completed.
Start erasing.....|
Start programming...|
Flashed successfully. Rebooting.
```



- Do not shut down or reset the system while updating the BIOS to prevent system boot failure!
- A “Floppy not found!” error message appears if there is no floppy disk in the drive. An “K8N4-E.ROM not found!” error message appears if the correct BIOS file is not found in the floppy disk. Make sure that you rename the BIOS file to K8N4-E.ROM.



## 4.1.4 ASUS CrashFree BIOS 2 utility

The ASUS CrashFree BIOS is an auto recovery tool that allows you to restore the BIOS file when it fails or gets corrupted during the updating process. You can update a corrupted BIOS file using the motherboard support CD or the floppy disk that contains the updated BIOS file.



- Prepare the floppy disk containing the updated motherboard BIOS before using this utility.
- Make sure that you rename the original or updated BIOS file in the floppy disk to **K8N4-E.ROM**.

### Recovering the BIOS from a floppy disk

To recover the BIOS from a floppy disk:

1. Turn on the system.
2. Insert the floppy disk with the original or updated BIOS file to the floppy disk drive.
3. The utility displays the following message and automatically checks the floppy disk for the original or updated BIOS file.

```
Bad BIOS checksum. Starting BIOS recovery...
Checking for floppy...
```

When found, the utility reads the BIOS file and starts flashing the corrupted BIOS file.

```
Bad BIOS checksum. Starting BIOS recovery...
Checking for floppy...
Floppy found!
Reading file "K8N4-E.ROM". Completed.
Start flashing...
```



DO NOT shut down or reset the system while updating the BIOS! Doing so can cause system boot failure!

4. Restart the system after the utility completes the updating process.

## 4.1.5 ASUS Update utility

The ASUS Update is a utility that allows you to manage, save, and update the motherboard BIOS in Windows® environment. The ASUS Update utility allows you to:

- Save the current BIOS file
- Download the latest BIOS file from the Internet
- Update the BIOS from an updated BIOS file
- Update the BIOS directly from the Internet, and
- View the BIOS version information.

This utility is available in the support CD that comes with the motherboard package.



---

ASUS Update requires an Internet connection either through a network or an Internet Service Provider (ISP).

---

## Installing ASUS Update

To install ASUS Update:

1. Place the support CD in the optical drive. The **Drivers** menu appears.
2. Click the **Utilities** tab, then click **Install ASUS Update VX.XX.XX**. See page 5-3 for the **Utilities** screen menu.
3. The ASUS Update utility is copied to your system.



---

Quit all Windows® applications before you update the BIOS using this utility.

---

## Updating the BIOS through the Internet

To update the BIOS through the Internet:

1. Launch the ASUS Update utility from the Windows® desktop by clicking **Start > Programs > ASUS > ASUSUpdate > ASUSUpdate**. The ASUS Update main window appears.

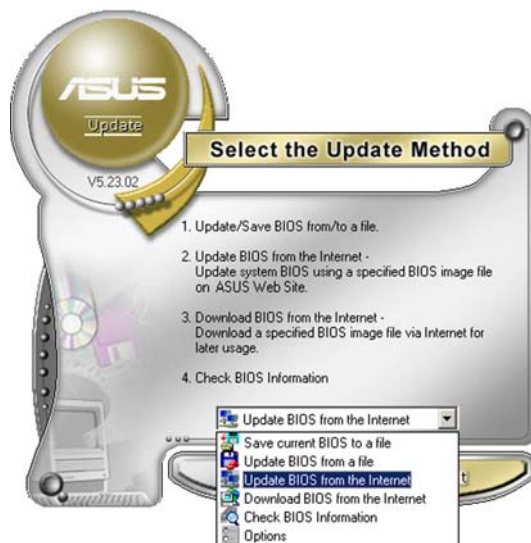
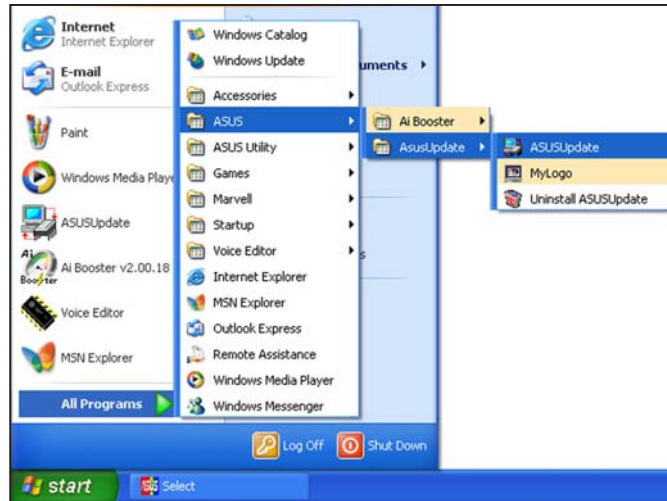

2. Select **Update BIOS from the Internet** option from the drop-down menu, then click **Next**.



3. Select the ASUS FTP site nearest you to avoid network traffic, or click **Auto Select**. Click **Next**.

- From the FTP site, select the BIOS version that you wish to download. Click Next.
- Follow the screen instructions to complete the update process.



The ASUS Update utility is capable of updating itself through the Internet. Always update the utility to avail all its features.



## Updating the BIOS through a BIOS file

To update the BIOS through a BIOS file:

- Launch the ASUS Update utility from the Windows® desktop by clicking **Start > Programs > ASUS > ASUSUpdate > ASUSUpdate**. The ASUS Update main window appears.
- Select **Update BIOS from a file** option from the drop-down menu, then click **Next**.

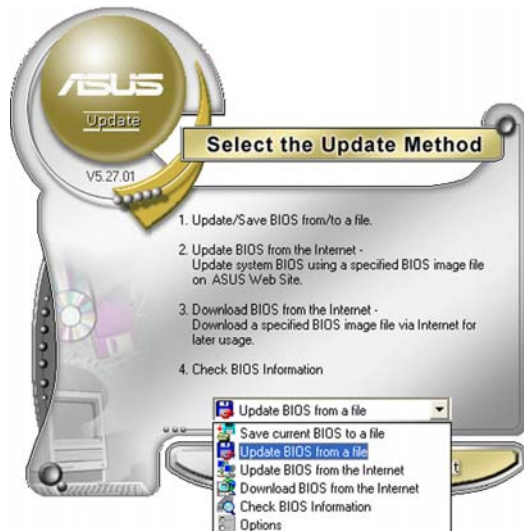

- Locate the BIOS file from the **Open** window, then click **Save**.
- Follow the screen instructions to complete the update process.

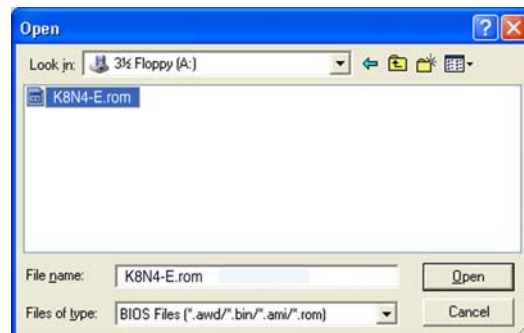

## 4.2 BIOS Setup program

This motherboard supports a programmable Flash ROM that you can update using the provided utility described in section 4.1 *Managing and updating your BIOS.*

Use the BIOS Setup program when you are installing a motherboard, reconfiguring your system, or prompted to “Run Setup.” This section explains how to configure your system using this utility.

Even if you are not prompted to use the Setup program, you may want to change the configuration of your computer in the future. For example, you may want to enable the security password feature or make changes to the power management settings. This requires you to reconfigure your system using the BIOS Setup program so that the computer can recognize these changes and record them in the CMOS RAM of the Flash ROM.

The Flash ROM on the motherboard stores the Setup utility. When you start up the computer, the system provides you with the opportunity to run this program. Press <Delete> during the Power-On Self Test (POST) to enter the Setup utility; otherwise, POST continues with its test routines.

To enter Setup after POST, restart the system by pressing <Ctrl> + <Alt> + <Delete>, or by pressing the reset button on the system chassis. You can also restart by turning the system off and then back on. Do this last option only if the first two failed.

The Setup program is designed to make it as easy to use as possible. It is a menu-driven program, which means you can scroll through the various sub-menus and make your selections among the predetermined choices.



---

Because the BIOS software is constantly being updated, the following BIOS setup screens and descriptions are for reference purposes only, and may not exactly match what you see on your screen.

---

## 4.2.1 BIOS menu bar

The top of the screen has a menu bar with the following selections:

<b>MAIN</b>	Use this menu to make changes to the basic system configuration.
<b>ADVANCED</b>	Use this menu to enable and make changes to the advanced features.
<b>POWER</b>	Use this menu to configure and enable Power Management features.
<b>BOOT</b>	Use this menu to configure the default system device used to locate and load the Operating System.
<b>EXIT</b>	Use this menu to exit the current menu or to exit the Setup program.

To access the menu bar items, press the right or left arrow key on the keyboard until the desired item is highlighted.

## 4.2.2 Legend bar

At the bottom of the Setup screen is a legend bar. The keys in the legend bar allow you to navigate through the various setup menus. The following table lists the keys found in the legend bar with their corresponding functions.

Navigation Key(s)	Function Description
<F1> or <Alt + H>	Displays the General Help screen from anywhere in the BIOS Setup
<Esc>	Jumps to the Exit menu or returns to the main menu from a sub-menu
Left or Right arrow	Selects the menu item to the left or right
Up or Down arrow	Moves the highlight up or down between fields
- (minus key)	Scrolls backward through the values for the highlighted field
+ (plus key) or spacebar	Scrolls forward through the values for the highlighted field
<Enter>	Brings up a selection menu for the highlighted field
<Home> or <PgUp>	Moves the cursor to the first field
<End> or <PgDn>	Moves the cursor to the last field
<F5>	Resets the current screen to its Setup Defaults
<F10>	Saves changes and exits Setup

## General help

In addition to the Item Specific Help window, the BIOS setup program also provides a General Help screen. You may launch this screen from any menu by simply pressing <F1>. The General Help screen lists the legend keys and their corresponding functions.

Saving changes and exiting the Setup program

See “4.7 Exit Menu” for detailed information on saving changes and exiting the setup program.

## Scroll bar

When a scroll bar appears to the right of a help window, it indicates that there is more information to be displayed that will not fit in the window. Use <PgUp> and <PgDn> or the up and down arrow keys to scroll through the entire help document. Press <Home> to display the first page, press <End> to go to the last page. To exit the help window, press <Enter> or <Esc>.

## Sub-menu

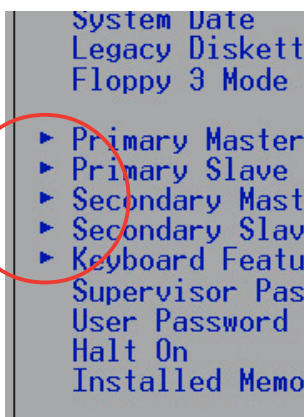

Note that a right pointer symbol (as shown on the left) appears to the left of certain fields. This pointer indicates that you can display a sub-menu from this field. A sub-menu contains additional options for a field parameter. To display a sub-menu, move the highlight to the field and press <Enter>. The sub-menu appears. Use the legend keys to enter values and move from field to field within a sub-menu as you would within a menu. Use the <Esc> key to return to the main menu.

Take some time to familiarize yourself with the legend keys and their corresponding functions. Practice navigating through the various menus and sub-menus. If you accidentally make unwanted changes to any of the fields, use the set default hot key <F5> to load the Setup default values. While moving around through the Setup program, note that explanations appear in the Item Specific Help window located to the right of each menu. This window displays the help text for the currently highlighted field.



## 4.3 Main Menu

When you enter the Setup program, the following screen appears.

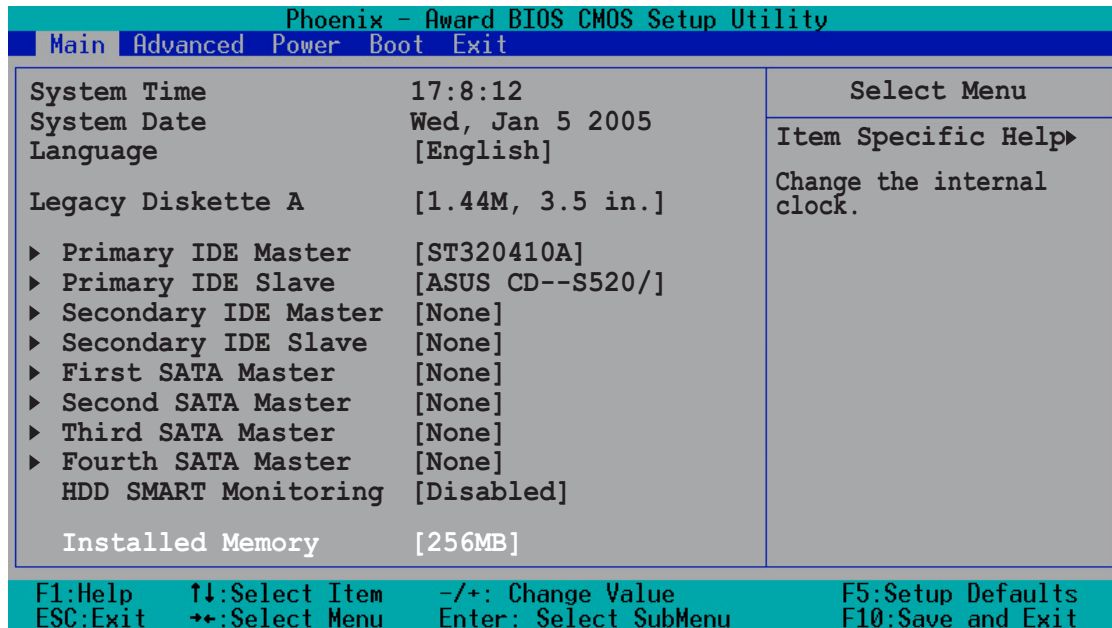

### 4.3.1 System Time [xx:xx:xx]

Sets the system to the time that you specify (usually the current time). The format is hour, minute, second. Valid values for hour, minute and second are Hour: (00 to 23), Minute: (00 to 59), Second: (00 to 59). Use the <Tab> key to move between the hour, minute, and second fields.

### 4.3.2 System Date [xx/xx/xxxx]

Sets the system to the date that you specify (usually the current date). The format is month, day, year. Valid values for month, day, and year are Month: (1 to 12), Day: (1 to 31), Year: (up to 2084). Use the <Tab> key to move between the month, day, and year fields.

### 4.3.3 Language [English]

Allows you to select the language. Configuration options: [English] [French] [Deutsch]

### 4.3.4 Legacy Diskette A [1.44M, 3.5 in.]

Sets the type of floppy drive installed. Configuration options: [Disabled] [360K, 5.25 in.] [1.2M, 5.25 in.] [720K, 3.5 in.] [1.44M, 3.5 in.] [2.88M, 3.5 in.]



### 4.3.5 HDD SMART Monitoring [Disabled]

Enables or disables Hard Disk SMART capability support.  
Configuration options: [Disabled] [Enabled]

### 4.3.6 Installed Memory [xxx MB]

This field automatically displays the amount of conventional memory detected by the system during the boot process.

### 4.3.7 Primary and Secondary IDE Master/Slave

Phoenix - Award BIOS CMOS Setup Utility		
Main		
Primary IDE Master		Select Menu
PIO Mode	[Auto]	Item Specific Help▶▶
UDMA Mode	[Auto]	Set a PIO Mode for the IDE device. Mode0 through 4 successive increase in performance.
Primary IDE Master Access Mode	[Auto]	
Capacity	20021 MB	
Cylinder	38792	
Head	16	
Sector	63	
Transfer Mode	UDMA 5	

F1:Help    ↑↓:Select Item    -/+ : Change Value    F5:Setup Defaults  
ESC:Exit    →+:Select Menu    Enter: Select SubMenu    F10:Save and Exit

#### PIO Mode [Auto]

This option lets you set a PIO (Programmed Input/Output) mode for the IDE device. Modes 0 through 4 provide successive increase in performance.  
Configuration options: [Auto] [Mode 0] [Mode 1] [Mode 2] [Mode 3] [Mode 4]

#### UDMA Mode [Auto]

Ultra DMA capability allows improved transfer speeds and data integrity for compatible IDE devices. Set to [Disabled] to suppress Ultra DMA capability.  
Configuration options: [Disabled] [Auto]

## Primary IDE Master [Auto]

Select [Auto] to automatically detect an IDE hard disk drive. If automatic detection is successful, Setup automatically fills in the correct values for the remaining fields on this sub-menu. If automatic detection fails, this may be because the hard disk drive is too old or too new. If the hard disk was already formatted on an older system, Setup may detect incorrect parameters. In these cases, select [Manual] to manually enter the IDE hard disk drive parameters. Refer to the next section for details. Configuration options: [None] [Auto] [Manual]



---

Before attempting to configure a hard disk drive, make sure you have the correct configuration information supplied by the drive manufacturer. Incorrect settings may cause the system to fail to recognize the installed hard disk.

---

## Access Mode [Auto]

This item allows the user to select the sector addressing mode. CHS (cylinder, head, sector) mode supports 528 MB hard disks. LBA (logical block addressing) mode supports hard disks up to 128 GB in size. Large mode (also called extended CHS mode) supports hard disks above 528 MB in size, but does not support LBA mode. Configuration options: [CHS] [LBA] [Large] [Auto]

## Capacity

Displays the auto-detected hard disk capacity. This item is not configurable.

## Cylinder

Shows the number of the hard disk cylinders. This item is not configurable.

## Head

Shows the number of the hard disk read/write heads. This item is not configurable.

## Sector

Shows the number of sectors per track. This item is not configurable.

## Transfer Mode

Shows the Transfer mode. This item is not configurable.



After entering the IDE hard disk drive information into BIOS, use a disk utility, such as FDISK, to partition and format new IDE hard disk drives. This is necessary so that you can write or read data from the hard disk. Make sure to set the partition of the Primary IDE hard disk drives to active.

### 4.3.8 First, Second, Third, and Fourth SATA Master

Phoenix - Award BIOS CMOS Setup Utility		
Main		
First SATA Master		Select Menu
Extended IDE Drive	[Auto]	Item Specific Help▶▶ Selects the type of fixed disk connected to the system.
Access Mode	[Auto]	
Capacity	0 MB	
Cylinder	0	
Head	0	
Precomp	0	
Landing Zone	0	
Sector	0	
F1:Help    ↑↓:Select Item    -/+ : Change Value    F5:Setup Defaults		F10:Save and Exit
ESC:Exit    →:Select Menu    Enter: Select SubMenu		

#### Extended IDE Drive [Auto]

Select [Auto] to automatically detect a SATA hard disk drive. If automatic detection is successful, Setup automatically fills in the correct values for the remaining fields on this sub-menu. Configuration options: [None] [Auto]

#### Access Mode [Auto]

Allows the user to select the sector addressing mode. Refer to the previous page for detailed descriptions of the different modes. Configuration options: [Large] [Auto]

#### Capacity

Displays the auto-detected hard disk capacity. This item is not configurable.

#### Cylinder

Shows the number of the hard disk cylinders. This item is not configurable.

## Head

Shows the number of the hard disk read/write heads. This item is not configurable.

## Precomp

Shows the number of precomp per track. This item is not configurable.

## Landing Zone

Shows the number of landing zone per track. This item is not configurable.

## Sector

Shows the number of sectors per track. This item is not configurable.



---

After entering the IDE hard disk drive information into BIOS, use a disk utility, such as FDISK, to partition and format new IDE hard disk drives. This is necessary so that you can write or read data from the hard disk. Make sure to set the partition of the Primary IDE hard disk drives to active.

---

## 4.4 Advanced Menu

The Advanced menu items allow you to change the settings for the CPU and other system devices.



Take caution when changing the settings of the Advanced menu items. Incorrect field values may cause the system to malfunction.

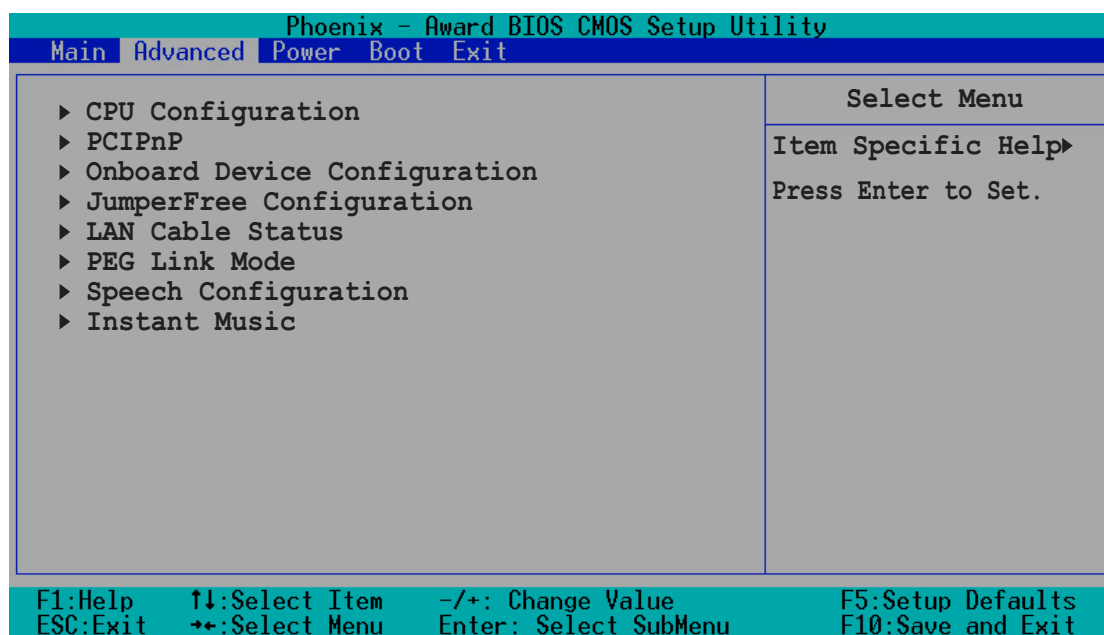

## 4.4.1 CPU configuration

The items in this menu show the CPU-related information auto-detected by the BIOS.

Phoenix - Award BIOS CMOS Setup Utility	
Advanced	
CPU Configuration	Select Menu
CPU Type AMD Athlon(tm) 64 Processor 3200+	Item Specific Help▶▶
CPU Speed 2000MHz	
Cache RAM 1024K	
▶ DRAM Configuration	
Hyper Transport Frequency [4x]	
AMD K8 Cool 'n' Quiet control [Enabled]	
F1:Help    ↑↓:Select Item    -/+ : Change Value    F5:Setup Defaults ESC:Exit    →←:Select Menu    Enter: Select SubMenu    F10:Save and Exit	

## DRAM Configuration

The items in this sub-menu show the DRAM-related information that the BIOS auto-detects.

Phoenix - Award BIOS CMOS Setup Utility	
Advanced	
DRAM Configuration	Select Menu
Timing Mode [Auto]	Item Specific Help▶▶
Memclock Index Value (MHz) [100MHz]	
CAS# Latency (Tcl) [2.5]	Places an artificial memory clock limit on the system.
Min RAS# active time (Tras) [8T]	Memory is prevented from running faster than this frequency.
RAS# to CAS# delay (Trcd) [4T]	
Row precharge time (Trp) [4T]	
1T/2T Memory Timing [2T]	
Master ECC Enable [Disabled]	
F1:Help    ↑↓:Select Item    -/+ : Change Value    F5:Setup Defaults ESC:Exit    →←:Select Menu    Enter: Select SubMenu    F10:Save and Exit	

Timing Mode [Auto]

Sets the timing mode.  
Configuration options: [Auto] [Manual]

Memclock Index Value (MHz) [100MHz]

Sets the maximum operating memory clock.  
Configuration options: [100MHz] [133MHz] [166MHz] [200MHz]

CAS# latency (Tcl) [2.5]

Sets the CAS# latency, which is the CAS # to read valid data.  
Configuration options: [2.0] [2.5] [3.0]

Min RAS# active time (Tras) [8T]

Sets the minimum RAS# active time.  
Configuration options: [5] [6] [7] [8] [9] [10] [11] [12] [13] [14] [15]

RAS# to CAS# delay (Trcd) [4T]

Sets the RAS# to CAS# delay to Read/Write command on the same bank. Configuration options: [2] [3] [4] [5] [6] [7]

Row precharge Time (Trp) [4T]

Sets the Row precharge time. Precharge to Active or Auto-Refresh of the same bank. Configuration options: [2] [3] [4] [5] [6]

1T/2T Memory Timing [2T]

Sets the memory timing. Configuration options: [1T] [2T]

Master ECC Enable [Disabled]

Enables or disables the master ECC function.  
Configuration options: [Disabled] [Enabled]

**Hyper Transport Frequency [4x]**

Sets the Hyper Transport frequency.  
Configuration options: [1x] [2x] [3x] [4x]

**AMD K8 Cool 'n' Quiet control [Enabled]**

Enables or disables the AMD K8 Cool 'n' Quiet!™ technology.  
Configuration options: [Disabled] [Enabled]

## 4.4.2 PCIPnP

The items in this menu show the PCIPnP configuration settings. Select an item then press <Enter> to display a pop-up menu with the configuration options.

Phoenix - Award BIOS CMOS Setup Utility	
Advanced	
PCIPnP	Select Menu
Plug & Play O/S [No]	Item Specific Help▶▶
Init Display First [PCI Slot]	Select Yes if you are using a Plug and Play capable system.
Resources Controlled By [Auto]	Select No if you need the BIOS to configure non-boot devices.
x IRQ Resources	
PCI/VGA Palette Snoop [Disabled]	

F1:Help    ↑↓:Select Item    -/+ : Change Value    F5:Setup Defaults  
ESC:Exit    →+:Select Menu    Enter: Select SubMenu    F10:Save and Exit

### Plug & Play OS [No]

When set to [No], the BIOS configures all the devices in the system. When set to [Yes] and if you install a Plug and Play operating system, the operating system configures the Plug and Play devices not required for boot. Configuration options: [No] [Yes]

### Init Display First [PCI Slot]

Allows you to select which graphics controller to use as the primary boot device. Configuration options: [PCI slot] [PCIEx]

### Resources Controlled By [Auto]

When set to [Auto], the BIOS automatically configures all the boot and Plug and Play devices. Set to [Manual] if you want to assign the IRQ DMA and memory base address fields. Configuration options: [Auto] [Manual]



When the item **Resources Controlled By** is set to [Auto], the item IRQ Resources is grayed out and is not user-configurable. Refer to the section “IRQ Resources” for information on how to enable this item.



## IRQ Resources

Phoenix - Award BIOS CMOS Setup Utility		
Advanced		
IRQ Resources		Select Menu
IRQ-3 assigned to	[PCI Device]	Item Specific Help▶▶
IRQ-5 assigned to	[PCI Device]	Legacy ISA for devices compliant with the original PC AT bus specification, PCI/ISA
IRQ-7 assigned to	[PCI Device]	PnP for devices compliant with the Plug and Play Standard
IRQ-9 assigned to	[PCI Device]	whether designed for PCI or ISA bus architecture.
IRQ-10 assigned to	[PCI Device]	
IRQ-11 assigned to	[PCI Device]	
IRQ-12 assigned to	[PCI Device]	
IRQ-14 assigned to	[PCI Device]	
IRQ-15 assigned to	[PCI Device]	

F1:Help    ↑↓:Select Item    -/+ : Change Value    F5:Setup Defaults  
 ESC:Exit    →←:Select Menu    Enter: Select SubMenu    F10:Save and Exit

### *IRQ-xx assigned to*

When set to [PCI Device], the specific IRQ is free for use of PCI/PnP devices. When set to [Reserved], the IRQ is reserved for legacy ISA devices. Configuration options: [PCI Device] [Reserved]

### **PCI/VGA Palette Snoop [Disabled]**

When set to [Enabled], the palette snooping feature informs the PCI devices that an ISA graphics device is installed in the system so that the latter can function correctly. Configuration options: [Disabled] [Enabled]

### 4.4.3 Onboard device configuration

The items in this menu show the onboard device configuration settings. Select an item then press <Enter> to display a pop-up menu with the configuration options.

Phoenix - Award BIOS CMOS Setup Utility	
Advanced	
Onboard Device Configuration	Select Menu
<ul style="list-style-type: none"> <li>▶ IDE Function Setup</li> <li>▶ NVRAID Configuration</li> <li>▶ USB Configuration</li> <li>Onboard 1394 [Enabled]</li> <li>Onboard Giga LAN [Enabled]</li> <li>Onboard LAN Boot ROM [Disabled]</li> <li>AC97 Audio [Enabled]</li> <li>Silicon SATA Controller [Enabled]</li> <li>Serial Port 1 Address [3F8/IRQ4]</li> <li>Parallel Port Address [378/IRQ7]</li> <li>Parallel Port Mode [ECP+EPP]</li> <li>ECP Mode Use DMA [3]</li> <li>Game Port Address [201]</li> <li>Midi Port Address [330]</li> <li>Midi Port IRQ 10</li> </ul>	Item Specific Help▶
F1:Help    ↑↓:Select Item    -/+: Change Value    F5:Setup Defaults ESC:Exit    →+:Select Menu    Enter: Select SubMenu    F10:Save and Exit	

### IDE Function Setup

This sub-menu contains IDE function-related items. Select an item then press <Enter> to edit.

Phoenix - Award BIOS CMOS Setup Utility	
Advanced	
IDE Function Setup	Select Menu
OnChip Channel0 [Enabled] OnChip IDE Channell [Enabled] IDE DMA transfer access [Enabled] SATA Port 1, 2 [Enabled] SATA DMA transfer [Enabled] SATA Port 3, 4 [Enabled] SATA2 DMA transfer [Enabled] IDE Prefetch Mode [Enabled]	Item Specific Help▶
F1:Help    ↑↓:Select Item    -/+: Change Value    F5:Setup Defaults ESC:Exit    →+:Select Menu    Enter: Select SubMenu    F10:Save and Exit	

OnChip IDE Channel0 [Enabled]

Allows you to enable or disable the onchip IDE channel 0 controller .  
Configuration options: [Disabled] [Enabled]

OnChip IDE Channel1 [Enabled]

Allows you to enable or disable the onchip IDE channel 1 controller .  
Configuration options: [Disabled] [Enabled]

IDE DMA transfer access [Enabled]

Allows you to enable or disable the IDE DMA transfer access.  
Configuration options: [Disabled] [Enabled]

SATA Port 1,2 [Enabled]

Allows you to enable or disable the SATA 1 and 2 ports.  
Configuration options: [Disabled] [Enabled]

SATA DMA transfer [Enabled]

Allows you to enable or disable the SATA DMA transfer access.  
Configuration options: [Disabled] [Enabled]

SATA Port 3, 4 [Enabled]

Allows you to enable or disable the SATA 3 and 4 ports.  
Configuration options: [Disabled] [Enabled]

SATA2 DMA transfer [Enabled]

Allows you to enable or disable the SATA2 DMA transfer access.  
Configuration options: [Disabled] [Enabled]

IDE Prefetch Mode [Enabled]

Allows you to enable or disable the IDE prefetch mode.  
Configuration options: [Disabled] [Enabled]

## NVRAID Configuration

This sub-menu contains NVRAID function-related items. Select an item then press <Enter> to edit.

Phoenix - Award BIOS CMOS Setup Utility			
Advanced			
NVRAID Configuration			Select Menu
RAID Enable		[Disabled]	Item Specific Help▶
x IDE Primary Master	RAID	Disabled	
x IDE Primary Slave	RAID	Disabled	
x IDE Secondary Master	RAID	Disabled	
x IDE Secondary Slave	RAID	Disabled	
x First SATA Master	RAID	Disabled	
x Second SATA Master	RAID	Disabled	
x Third SATA Master	RAID	Disabled	
x Fourth SATA Master	RAID	Disabled	

F1:Help    ↑↓:Select Item    -/+ : Change Value    F5:Setup Defaults  
ESC:Exit    →+:Select Menu    Enter: Select SubMenu    F10:Save and Exit

### RAID Enable [Disabled]

Enables or disables the onboard RAID controller.  
Configuration options: [Enabled] [Disabled]



The following items become user-configurable when the **RAID Enable** item is set to [Enabled].

### IDE Primary and Secondary Master/Slave RAID [Disabled]

Enables or disables the RAID function of the primary or secondary master or slave IDE. Configuration options: [Enabled] [Disabled]

### First, Second, Third, Fourth SATA Master RAID [Disabled]

Enables or disables the RAID function of the first, second, third, or fourth SATA master drive. Configuration options: [Enabled] [Disabled]

## USB configuration

The items in this menu show the USB configuration settings. Select an item then press <Enter> to display a pop-up menu with the configuration options.

Phoenix - Award BIOS CMOS Setup Utility	
Advanced	
USB Configuration	Select Menu
USB Controller [Enabled]	Item Specific Help▶▶
USB 2.0 Controller [Enabled]	
USB Legacy Support [Enabled]	

F1:Help    ↑↓:Select Item    -/+ : Change Value    F5:Setup Defaults  
ESC:Exit    →←:Select Menu    Enter: Select SubMenu    F10:Save and Exit

### USB Controller [Enabled]

Allows you to enable or disable the onchip USB controller.  
Configuration options: [Disabled] [Enabled]

### USB 2.0 Controller [Enabled]

Allows you to enable or disable the USB 2.0 controller.  
Configuration options: [Disabled] [Enabled]

### USB Legacy Support [Enabled]

Allows you to enable or disable support for USB devices on legacy operating systems (OS). Configuration options: [Disabled] [Enabled]

### **Onboard 1394 [Enabled]**

Allows you to enable or disable the onboard IEEE 1394a device support.  
Configuration options: [Disabled] [Enabled]

### **Onboard Giga LAN [Enabled]**

Allows you to enable or disable the onboard NVIDIA® Gigabit LAN controller.  
Configuration options: [Disabled] [Enabled]

### **Onboard LAN Boot ROM [Disabled]**

Allows you to enable or disable the boot ROM of the onboard LAN chip.  
Configuration options: [Enabled] [Disabled]

### **AC97 Audio [Enabled]**

Allows you to enable or disable the onboard AC`97 Audio controller.  
Configuration options: [Disabled] [Enabled]

### **Silicon SATA Controller [Enabled]**

Allows you to enable or disable the onboard Silicon Image RAID controller.  
Configuration options: [Disabled] [Enabled]

### **Serial Port1 Address [3F8/IRQ4]**

Allows you to select the Serial Port1 base address.  
Configuration options: [Disabled] [3F8/IRQ4] [2F8/IRQ3] [3E8/IRQ4]  
[2E8/IRQ3]

### **Parallel Port Address [378/IRQ7]**

Allows you to select the Parallel Port base addresses.  
Configuration options: [Disabled] [378/IRQ7] [278/IRQ5] [3BC/IRQ7]

### **Parallel Port Mode [ECP+EPP]**

Allows you to select the Parallel Port mode.  
Configuration options: [SPP] [EPP] [ECP] [ECP+EPP]

### **ECP Mode Use DMA [3]**

Allows you to select the ECP Mode. This item becomes configurable only if the **Parallel Port Mode** is set to [ECP] or [ECP+EPP]. Configuration options: [1] [3]

### **Game Port Address [201]**

Allows you to select the Game port address or to disable the port.

Configuration options: [Disabled] [201] [209]

### **Midi Port Address [330]**

Allows you to select the MIDI port address or to disable the port.

Configuration options: [Disabled] [330] [300]

### **Midi Port IRQ [10]**

Allows you to set the Midi port IRQ address. This item becomes configurable only if the **Midi Port Address** item is set to [300] or [330]

Configuration options: [5] [10]

## 4.4.4 JumperFree Configuration

Phoenix - Award BIOS CMOS Setup Utility		
Advanced		
JumperFree Configuration		Select Menu
Overclock Profile	[Auto]	Item Specific Help▶▶
x Overclock Options	Disabled	
x CPU Frequency	200.00	
x PCI Express Clock	100MHz	
x DDR Voltage	Auto	
x CPU Multiplier	Auto	
F1:Help	↑↓:Select Item	-/+ : Change Value
ESC:Exit	→+:Select Menu	Enter: Select SubMenu
		F5:Setup Defaults
		F10:Save and Exit

### Overclock Profile [Auto]

Allows selection of CPU overclocking options to achieve desired CPU internal frequency. Select either one of the preset overclocking configuration options:

<b>Manual</b>	Allows you to individually set overclocking parameters.
<b>Auto</b>	Loads the optimal settings for the system.
<b>Standard</b>	Loads the standard settings for the system.
<b>AI Overclock</b>	Loads overclocking profiles with optimal parameters for stability when overclocking.





---

The following items are user-configurable only when the Overclock Profile item is set to [Manual].

---

### **CPU Frequency [XXX] (value is auto-detected)**

Indicates the frequency sent by the clock generator to the system bus and PCI bus. The bus frequency (external frequency) multiplied by the bus multiple equals the CPU speed. The value of this item is auto-detected by BIOS. The values range from 200 to 400. Refer to the following table for the correct Front Side Bus and CPU External Frequency settings.



---

Selecting a very high CPU frequency may cause the system to become unstable! If this happens, revert to the default setting.

---

### **PCI Express Clock [100MHz]**

Allows you to set the PCI Express clock. Key-in a decimal value between 100-200 MHz. Configuration options: [100Mhz] [101Mhz~[145Mhz]

### **DDR Voltage [Auto]**

Sets the operating DDR voltage. Configuration options: [Auto] [2.60V] [2.65V] [2.70V] [2.75V] [2.80V] [2.85V] [2.90V] [2.95V] [3.00V]

### **CPU Multiplier [Auto]**

Sets the operating CPU multiplier. The configuration options vary depending on the type of CPU installed. Configuration options: [Auto] [x4] [x4.5] [x5] [x5.5] [x6] [x6.5] [x7] [x7.5] [x7.5] [x8] [x8.5] [x9] [x9.5] [x10] [x10.5] [x11] [x11.5] [x12] [x12.5] [x13] [x13.5] [x14] [x14.5] [x15] [x15.5] [x16] [x16.5] [x17] [x17.5] [x18] [x18.5] [x19] [x19.5] [x20]



The following item is user-configurable only when the AI Overclocking item is set to [AI Overclock].

## Overclock Options [Disabled]

Allows you to set the overlocking options.

Configuration options: [Disabled] [Overclock 3%] [Overclock 5%]  
[Overclock 8%] [Overclock 10%]

## 4.4.5 LAN Cable Status

The items in this menu displays the status of the Local Area Network (LAN) cable.

Phoenix - Award BIOS CMOS Setup Utility			
Advanced			
LAN Cable Status			Select Menu
POST Check LAN Cable [Disabled]			Item Specific Help▶▶
Pair	Status	Length	
1-2	Open	N/A	
3-6	Open	N/A	
4-5	Open	N/A	
7-8	Open	N/A	

F1:Help    ↑↓:Select Item    -/+ : Change Value    F5:Setup Defaults  
ESC:Exit    →+:Select Menu    Enter: Select SubMenu    F10:Save and Exit

## POST Check LAN cable [Disabled]

Enables or disables checking of the LAN cable during the Power-On Self-Test (POST). Configuration options: [Disabled] [Enabled]

## 4.4.6 PEG Link Mode

Phoenix - Award BIOS CMOS Setup Utility	
Advanced	
PEG Link Mode	Select Menu
PEG Link Mode [Auto]	Item Specific Help>>
PEG Root Control [Auto]	Enhance performance
PEG Buffer Length [Auto]	on PCIE serial graphic card

F1:Help    ↑↓:Select Item    -/+ : Change Value    F5:Setup Defaults  
ESC:Exit    →←:Select Menu    Enter: Select SubMenu    F10:Save and Exit

### PEG Link Mode [Auto]

Allows you to enhance the performance of your PCI Express graphics card.  
Configuration options: [Auto] [Disabled] [Normal] [Fast] [Faster]

### PEG Root Control [Auto]

Allows you to enable or disable the PCI Express graphics root control.  
Configuration options: [Auto] [Enabled] [Disabled]

### PEG Buffer Length [Auto]

Allows you to set the PCI Express graphics buffer length.  
Configuration options: [Auto] [Long] [Short]

## 4.4.7 Speech Configuration

Phoenix - Award BIOS CMOS Setup Utility	
Advanced	
Speech Configuration	Select Menu
Speech IC Reporter [Enabled]	Item Specific Help▶▶
Report IDE Error [Disabled]	
Report System Booting [Disabled]	
F1:Help    ↑↓:Select Item    -/+ : Change Value    F5:Setup Defaults ESC:Exit    →+:Select Menu    Enter: Select SubMenu    F10:Save and Exit	

### Speech IC Reporter [Enabled]

Allows you to enable or disable the ASUS POST Reporter™ feature.  
Configuration options: [Disabled] [Enabled]



The following items are user-configurable only when the item **Speech IC Reporter** is set to [Enabled].

### Report IDE Error [Disabled]

Allows you to enable or disable the report feature in the event of an IDE error. Configuration options: [Disabled] [Enabled]

### Report System Booting [Disabled]

Allows you to enable or disable the report after booting the system. Configuration options: [Disabled] [Enabled]

## 4.4.8 Instant Music

Phoenix - Award BIOS CMOS Setup Utility	
Advanced	
Instant Music	Select Menu
Instant Music [Disabled] x Instant Music CD-ROM Drive Primary Master	Item Specific Help>>
F1:Help    ↑↓:Select Item    -/+ : Change Value    F5:Setup Defaults ESC:Exit    →←:Select Menu    Enter: Select SubMenu    F10:Save and Exit	

### Instant Music [Disabled]

Allows you to enable or disable the ASUS Instant Music feature.

Configuration options: [Disabled] [Enabled]



Enabling Instant Music automatically disables the PS/2 keyboard power up feature.

### Instant Music CD-ROM Drive [Primary Master]

Allows you to select the CD-ROM drive that you wish to use for the Instant Music CD playback. This item is configurable only if the **Instant Music** item is set to [Enabled]. Configuration options: [Primary Master] [Primary Slave] [Secondary Master] [Secondary Slave]

## 4.5 Power Menu

The Power menu allows you to reduce power consumption. This feature turns off the video display and shuts down the hard disk after a period of inactivity.

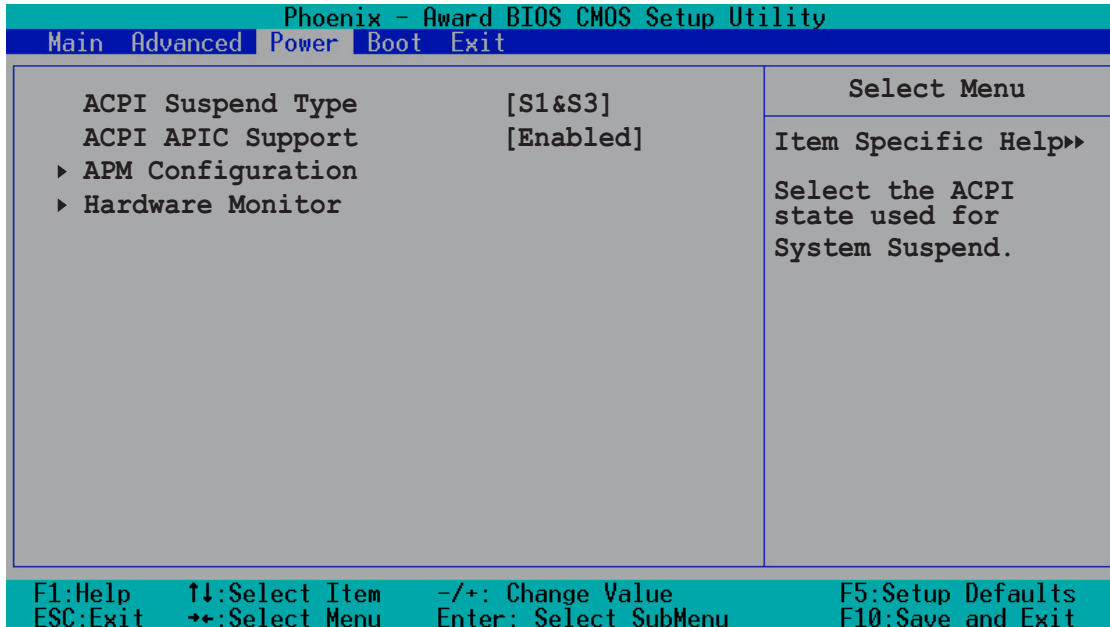

### 4.5.1 ACPI Suspend Type [S1&S3]

Allows you to select the ACPI state used for system suspend.

Configuration options: [S1(POS)] [S3(STR)] [S1&S3]

### 4.5.2 ACPI APIC Support [Enabled]

Allows you enable or disable the ACPI feature on the operating system.

Configuration options: [Disabled] [Enabled]

### 4.5.3 APM configuration

This menu shows the Advanced Power Management (APM) configuration settings. Select an item then press <Enter> to display a pop-up menu with the configuration options.

Phoenix - Award BIOS CMOS Setup Utility	
Power	
APM Configuration	Select Menu
Restore on AC Power Loss [Disabled]	Item Specific Help▶▶
PWR Button < 4 secs [Instant-Off]	
Power On by PCI Devices [Disabled]	
Power On by External Modems [Disabled]	
Power On by RTC Alarm [Disabled]	
x Date (of Month) 0	
x Resume Time (hh:mm:ss) 0 : 0 : 0	
PPower On by PS/2 Mouse [Disabled]	
Power On by PS/2 Keyboard [Disabled]	
F1:Help    ↑↓:Select Item    -/+ : Change Value    F5:Setup Defaults ESC:Exit    →+:Select Menu    Enter: Select SubMenu    F10:Save and Exit	

#### Restore on AC Power Loss [Disabled]

Allows you to enable or disable system reboot after power interruptions.  
Configuration options: [Disabled] [Enabled]

#### PWR Button < 4 secs [Instant-Off]

Allows you to set the event after the power button is pressed for more than 4 seconds. Configuration options: [Suspend] [Instant-Off]

#### Power On by PCI Devices [Disabled]

When set to [Enabled], this parameter allows you to turn on the system through a PCI LAN or modem card. This feature requires an ATX power supply that provides at least 1A on the +5VSB lead.  
Configuration options: [Disabled] [Enabled]

## Power On by External Modems [Disabled]

This allows either settings of [Enabled] or [Disabled] for powering up the computer when the external modem receives a call while the computer is in Soft-off mode. Configuration options: [Disabled] [Enabled]



---

The computer cannot receive or transmit data until the computer and applications are fully running. Thus, connectino cannot be made on the first try. Turning an external modem off and then back on while the computer is off causes an initialization string that turns the system power on.

---

## Power-On By Alarm [Disabled]

Allows you to enable or disable RTC to generate a wake event. When this item is set to Enabled, the items Date of Month Alarm and Time (hh:mm:ss) Alarm items become user-configurable with set values. Configuration options: [Disabled] [Enabled]



---

The two succeeding items become configurable only when the **Power-On By RTC Alarm** item is set to [Enabled].

---

## Day of Month Alarm [0]

To set the date of alarm, highlight this item and press <Enter> to display the Day of Month Alarm pop-up menu. Key-in a value within the specified range then press <Enter>. Configuration options: [Min=0] [Max=31]

## Time (hh:mm:ss) Alarm [0:0:0]

To set the time of alarm:

1. Highlight this item and press <Enter> to display a pop-up menu for the hour field.
2. Key-in a value (Min=0, Max=23), then press <Enter>.
3. Press <TAB> to move to the minutes field then press <Enter>.
4. Key-in a minute value (Min=0, Max=59), then press <Enter>.
5. Press <TAB> to move to the seconds field then press <Enter>.
6. Key-in a value (Min=0, Max=59), then press <Enter>.



### **Power On by PS/2 Mouse [Disabled]**

Allows you to disable the Power On by PS/2 keyboard function or set specific keys on the PS/2 keyboard to turn on the system. This feature requires an ATX power supply that provides at least 1A on the +5VSB lead. Configuration options: [Disabled] [Enabled]

### **Power On by PS/2 Keyboard [Disabled]**

This parameter allows you to turn on the system using specified keyboard keys. This feature requires an ATX power supply that provides at least 1A on the +5VSB lead. Configuration options: [Disabled] [Space Bar] [Ctrl+ESC] [Power key]

## 4.5.4 Hardware monitor

This menu shows the hardware monitor settings auto-detected by the BIOS.

Phoenix - Award BIOS CMOS Setup Utility		
Power		
Hardware Monitor		Select Menu
Q-Fan Controller	[Disabled]	Item Specific Help▶▶
Vcore Voltage	1.47V	
3.3V Voltage	3.15V	
5V Voltage	4.94V	
12V Voltage	11.45V	
CPU Temperature	48°C	
M/B Temperature	38°C	
CPU Fan Speed	3424 RPM	
CHA1 Fan Speed	0 RPM	
CHIP Fan Speed	5433 RPM	
x CPU Target Temperature	72°C	

F1:Help    ↑↓:Select Item    -/+ : Change Value    F5:Setup Defaults  
ESC:Exit    ++:Select Menu    Enter: Select SubMenu    F10:Save and Exit

### Q-Fan Controller [Disabled]

Allows you to enable or disable the Q-Fan controller.  
Configuration options: [Disabled] [Enabled]

### VCORE Voltage, 3.3V Voltage, 5V Voltage, 12V Voltage

The onboard hardware monitor automatically detects the voltage output through the onboard voltage regulators. These items are not user-configurable.

### CPU Temperature, M/B Temperature

The onboard hardware monitor automatically detects and displays the motherboard and CPU temperatures. These items are not user-configurable.

### CPU Fan Speed, Chassis Fan Speed, Power Fan Speed

The onboard hardware monitor automatically detects and displays the CPU, chassis, and power fan speeds in rotations per minute (RPM). If the fan is not connected to the motherboard, the field shows 0. These items are not user-configurable.

### CPU Target Temperature

Allows you to set the temperature threshold before the CPU fan rotates at full speed. Configuration options: [51°C] [54°C] [57°C] [60°C] [63°C] [66°C] [69°C] [72°C] [75°C] [78°C] [81°C]

## 4.6 Boot Menu

This Boot menu items allow you to change the system boot settings. Select an item then press <Enter> to display a pop-up menu with the configuration options.

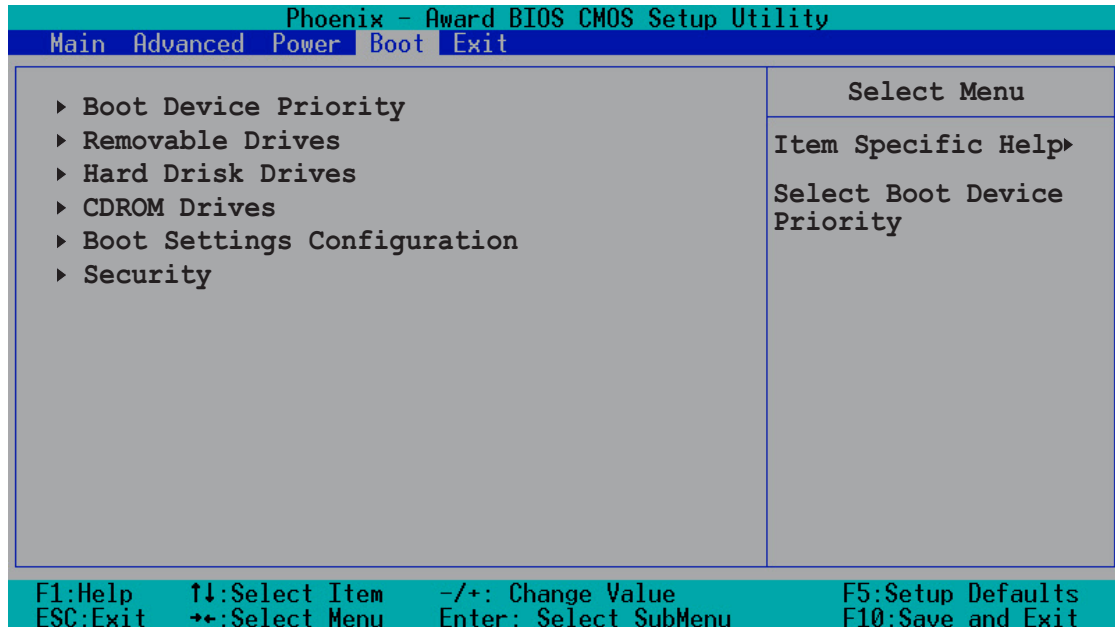

### 4.6.1 Boot Device Priority

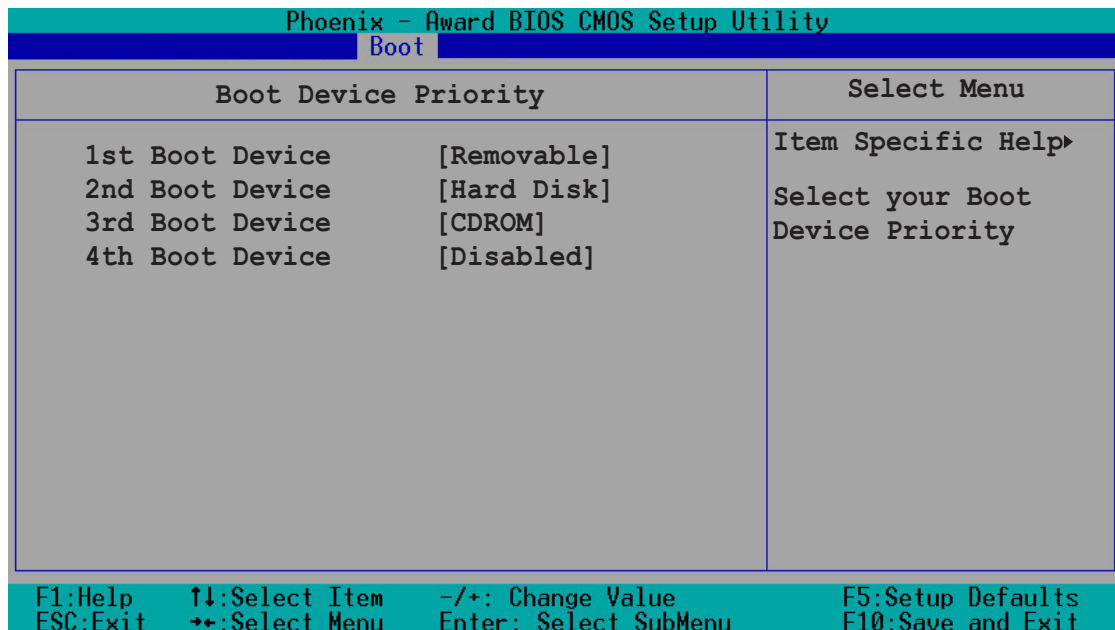

#### 1st ~ xth Boot Device

These items specify the boot device priority sequence from the available devices. The number of devices that appears on the screen depends on the number of devices installed in the system. Configuration options: [Removable] [Hard Disk] [CDROM] [Legacy LAN] [Disabled]

## 4.6.2 Removable drives

Phoenix - Award BIOS CMOS Setup Utility			
Boot		Select Menu	
Removable Drives		Select Menu	
1. Floppy Disks		Item Specific Help ▶▶	
		Use <up> or <down> arrow to select a device, then press <+> to move it up, or <-> to move it down the list. Press <ESC> to exit this menu.	
F1:Help	↑↓:Select Item	-/+ : Change Value	F5:Setup Defaults
ESC:Exit	→+:Select Menu	Enter: Select SubMenu	F10:Save and Exit

## 4.6.3 Hard Disk Drives

Phoenix - Award BIOS CMOS Setup Utility			
Boot		Select Menu	
Hard Disk Drives		Item Specific Help ▶▶	
1. 1st Master: ST320410A		Use <up> or <down> arrow to select a device, then press <+> to move it up, or <-> to move it down the list. Press <ESC> to exit this menu.	
2. Bootable Add-in Cards			
F1:Help	↑↓:Select Item	-/+ : Change Value	F5:Setup Defaults
ESC:Exit	→+:Select Menu	Enter: Select SubMenu	F10:Save and Exit

## 4.6.4 CD-ROM drives

Phoenix - Award BIOS CMOS Setup Utility	
Boot	
CDROM Drives	Select Menu
1. 1st Slave: ASUS CD-S520/A	Item Specific Help ▶  Use <up> or <down> arrow to select a device, then press <+> to move it up, or <-> to move it down the list. Press <ESC> to exit this menu.
F1:Help    ↑↓:Select Item    -/+ : Change Value    F5:Setup Defaults	ESC:Exit    →←:Select Menu    Enter: Select SubMenu    F10:Save and Exit

## 4.6.5 Boot settings configuration

Phoenix - Award BIOS CMOS Setup Utility	
Boot	
Boot Settings COnfiguration	Select Menu
Case Open Warning                    [Enabled]	Item Specific Help ▶
Quick Boot                            [Enabled]	
Boot Up Floppy Seek                 [Disabled]	Allows the system to skip certain tests while booting. This will decrease the time needed to boot the system.
Bootup Num-Lock                     [On]	
Typematic Rate Setting             [Disabled]	
x Typematic Rate (Chars/Sec)      6	
x Typematic Delay (Msec)          250	
OS Select for DRAM > 64MB        [Non-OS2]	
Full Screen LOGO                    [Enabled]	
Halt On                                [All Errors]	
F1:Help    ↑↓:Select Item    -/+ : Change Value    F5:Setup Defaults	ESC:Exit    →←:Select Menu    Enter: Select SubMenu    F10:Save and Exit

### Case Open Warning[Enabled]

Setting to [Enabled] allows the system to send off a warning if the case or chassis is opened. Configuration options: [Disabled] [Enabled]

### Quick Boot [Enabled]

Setting to [Enabled] allows the system to skip certain tests while booting, decreasing the time needed to boot the system.

Configuration options: [Disabled] [Enabled]

## Boot Up Floppy Seek [Disabled]

Enables or disables the chassis open status feature. Setting to Enabled, clears the chassis open status. Configuration options: [Disabled] [Enabled]

## Bootup Num-Lock [On]

Allows you to select the power-on state for the NumLock. Configuration options: [Off] [On]

## Typematic Rate Setting [Disabled]

Allows you to set the keystroke rate. Enable this item to configure the **Typematic Rate (Chars/Sec)** and the **Typematic Delay (Msec)**. Configuration options: [Disabled] [Enabled]



---

The items **Typematic Rate (Chars/Sec)** and **Typematic Delay (Msec)** becomes user-configurable only when the item Typematic Rate Setting is enabled.

---

## Typematic Rate (Chars/Sec) [6]

Allows you to select the rate at which a character repeats when you hold a key. Configuration options: [6] [8] [10] [12] [15] [20] [24] [30]

## Typematic Delay (Msec) [250]

Allows you to set the delay before keystrokes begin to repeat. Configuration options: [250] [500] [750] [1000]

## OS Select for DRAM > 64MB [Non-OS2]

Set this item to OS2 only when you are running on an OS/2 operating system with an installed RAM of greater than 64 KB. Configuration options: [Non-OS2] [OS2]

## Full Screen LOGO [Enabled]

Allows you to enable or disable the full screen logo display feature. Configuration options: [Disabled] [Enabled]



- 
- Make sure that the above item is set to [Enabled] if you want to use the ASUS MyLogo2™ feature.
  - See section “5.3.1 ASUS MyLogo2™” for details.
- 

## Halt On [All Errors]

Allows you to error report type. Configuration options: [All Errors] [No Errors] [All, But Keyboard] [All, But Diskette] [All, But Disk/Key]

## 4.6.6 Security

Phoenix - Award BIOS CMOS Setup Utility	
Boot	
Security	Select Menu
Supervisor Password      Clear	Item Specific Help ▶  Supervisor password controls full access, <Enter> to change password.
User Password              Clear	
Password Check            [Setup]	

F1:Help    ↑↓:Select Item    -/+ : Change Value    F5:Setup Defaults  
ESC:Exit    →←:Select Menu    Enter: Select SubMenu    F10:Save and Exit

### Supervisor Password [Clear] User Password [Clear]

These fields allow you to set passwords.

To set a password:

1. Highlight an item then press <Enter>.
2. Type in a password using eight (8) alphanumeric characters, then press <Enter>.
3. When prompted, confirm the password by typing the exact characters again, then press <Enter>. The password field setting is changed to [Set].

To clear the password:

1. Highlight the password field, and press <Enter> twice. The following message appears:  
“PASSWORD DISABLED!!! Press any key to continue...”
2. Press any key to return to the menu.

### A note about passwords

The Supervisor password is required to enter the BIOS Setup program preventing unauthorized access. The User password is required to boot the system preventing unauthorized use.

### Forgot the password?

If you forget your password, you can clear it by erasing the CMOS Real Time Clock (RTC) RAM. The RAM data containing the password information is powered by the onboard button cell battery. If you need to erase the CMOS RAM, refer to section “2.6 Jumpers” for instructions.

## Password Check [Setup]

This field requires you to enter the password before entering the BIOS setup or the system. Select [Setup] to require the password before entering the BIOS Setup. Select [System] to require the password before entering the system. Configuration options: [Setup] [System]

## 4.7 Exit menu

The Exit menu items allow you to load the BIOS setup default settings, save or discard any changes you made, or exit the Setup utility.

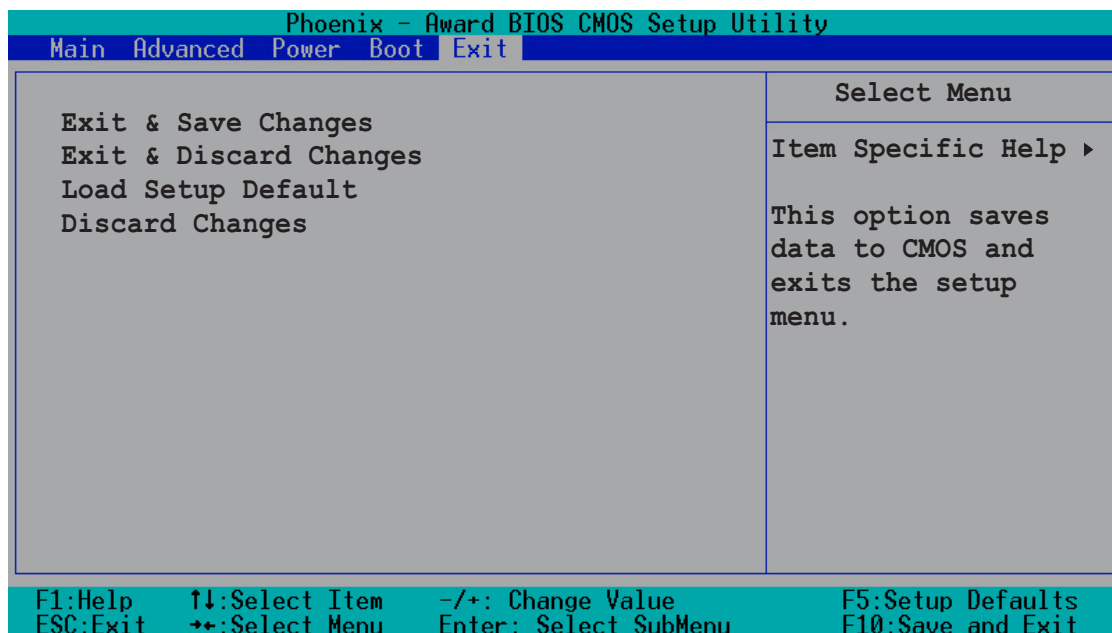

### Exit & Save Changes

Select this option then press <Enter>, or simply press <F10>, to save your changes to CMOS before exiting the Setup utility.

When a confirmation window appears (with a blinking [Y]):

- press <Enter> to save and exit
- type [N], then press <Enter>, or simply press <Esc>, to cancel the command and return to the Exit menu



## **Exit & Discard Changes**

Select this option only if you do not want to save the changes that you made to the Setup program. If you made changes to fields other than system date, system time, and password, the BIOS asks for a confirmation before exiting.

## **Load Setup Defaults**

This option allows you to load the default values for each of the parameters on the Setup menus. When you select this option or if you press <F5>, a confirmation window appears. Select [Yes] to load default values. Select Exit Saving Changes or make other changes before saving the values to the non-volatile RAM.

## **Discard Changes**

This option allows you to discard the selections you made and restore the previously saved values. After selecting this option, a confirmation appears. Select [Yes] to discard any changes and load the previously saved values.



This chapter describes the contents of the support CD that comes with the motherboard package.

# 5 Software support

5.1	Installing an operating system .....	5-1
5.2	Support CD information .....	5-1
5.3	Software information .....	5-8
5.4	RAID configurations .....	5-31
5.5	Creating a RAID driver disk .....	5-50

## 5.1 Installing an operating system

This motherboard supports Windows® 2000/2003 Server/XP operating systems (OS). Always install the latest OS version and corresponding updates to maximize the features of your hardware.



- Motherboard settings and hardware options vary. Use the setup procedures presented in this chapter for reference only. Refer to your OS documentation for detailed information.
- Make sure that you install Windows® 2000 Service Pack 4 or the Windows® XP Service Pack 1 or later versions before installing the drivers for better compatibility and system stability.

## 5.2 Support CD information

The support CD that came with the motherboard package contains the drivers, software applications, and utilities that you can install to avail all motherboard features.



The contents of the support CD are subject to change at any time without notice. Visit the ASUS website([www.asus.com](http://www.asus.com)) for updates.

### 5.2.1 Running the support CD

Place the support CD to the optical drive. The CD automatically displays the **Drivers** menu if Autorun is enabled in your computer.

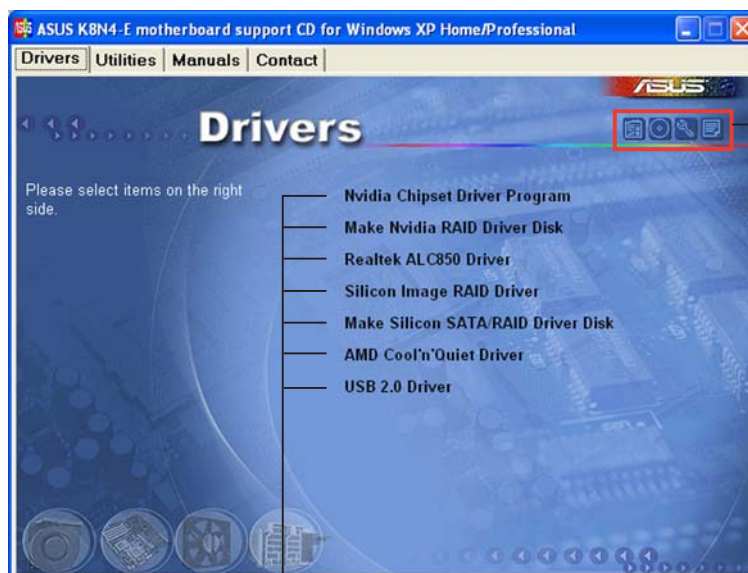

Click an icon to display support CD/motherboard information

Click an item to install



If **Autorun** is NOT enabled in your computer, browse the contents of the support CD to locate the file **ASSETUP.EXE** from the BIN folder. Double-click the **ASSETUP.EXE** to run the CD.

## 5.2.2 Drivers menu

The drivers menu shows the available device drivers if the system detects installed devices. Install the necessary drivers to activate the devices.

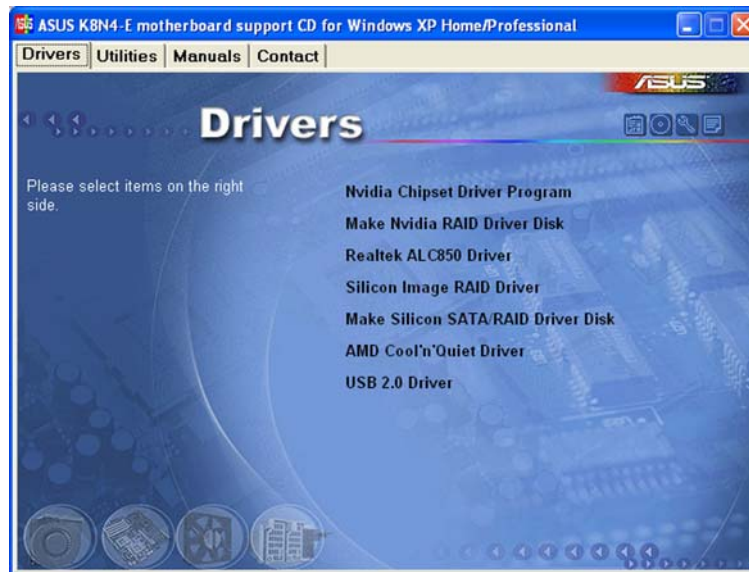

### **Nvidia Chipset Driver Program**

Installs the NVIDIA® chipset drivers for the NVIDIA® nForce™4-4X chipset.

### **Make an Nvidia Chipset Driver Disk**

Allows you to create the NVIDIA® driver disk for Serial ATA and RAID features.

### **Realtek ALC850 Driver**

Allows you to install the Realtek ALC850 driver.

### **Silicon Image RAID Driver**

Installs the Silicon Image RAID Driver. See section “5.4.2 Silicon Image RAID configurations” for details.

### **Make Silicon SATA/RAID Driver Disk**

Allows you to make a Silicon Image SATA Link™ Sil 3114 driver disk.

### **AMD Cool ‘n’ Quiet Driver**

Installs the AMD Cool ‘n’ Quiet!™ Technology driver. Cool ‘n’ Quiet!™ Technology allows the system to dynamically and automatically select the CPU speed, voltage, and power combination that matches the user’s performance requirements. See section “5.3.2 Cool ‘n’ Quiet!™ Technology” for details.

## USB 2.0 Driver

Installs the USB 2.0 driver.



The screen display and drivers options may not be the same for different operating system versions.

### 5.2.3 Utilities menu

The Utilities menu shows the applications and other software that the motherboard supports.



#### Nvidia Chipset nTune Utility

Installs the NVIDIA® nTune™ utility that allows easy and safe system tuning for optimum performance.

#### ASUS PC Probe II

This smart utility monitors the fan speed, CPU temperature, and system voltages, and alerts you of any detected problems. This utility helps you keep your computer in healthy operating condition.

## ASUS Update

The ASUS Update utility that allows you to update the motherboard BIOS in Windows® environment. This utility requires an Internet connection either through a network or an Internet Service Provider (ISP). See section “4.1.5 ASUS Update utility” for details.



---

Before using the ASUS Update, make sure that you have an Internet connection so you can connect to the ASUS website.

---

## ASUS AI Booster

The ASUS AI Booster application allows you to overclock the CPU speed in Windows® environment.

## Microsoft DirectX 9.0 Driver

Installs the Microsoft® DirectX 9.0 driver.

## Anti-virus utility

The anti-virus application scans, identifies, and removes computer viruses. View the online help for detailed information.

## ADOBE Acrobat Reader

Installs the Adobe® Acrobat® Reader V5.0 that allows you to open, view, and print documents in Portable Document Format (PDF).

## Winbond Voice Editor

This program is for recording and customizing wave files for the ASUS POST Reporter™. Use this program to change the default vocal POST messages. See section “3.3 Vocal POST Messages” for a list of the default messages.

## ASUS Screen Saver

Installs the ASUS screen saver.

## ASUS AMD Cool ‘n’ Quiet Software

Installs the AMD Cool ‘n’ Quiet!™ Technology software.



---

The screen display and utilities option may not be the same for different operating system versions.

---



## 5.2.4 Manuals menu

The **Manuals** menu contains the user manuals for third party components and applications.



- Most user manual files are in Portable Document Format (PDF). Install the Adobe® Acrobat® Reader from the **Utilities** menu before opening a user manual file.
- Some user manuals listed in this menu may not be applicable for this motherboard model.

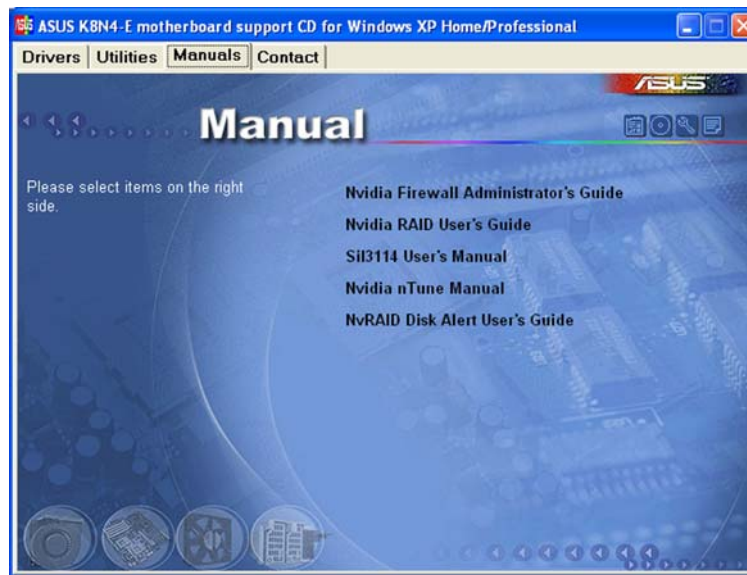

### **NVIDIA Firewall Administrator's Guide**

Allows you to open the NVIDIA® ForceWare Networking and Firewall Administrator's Guide.

### **NVIDIA RAID User's Guide**

Allows you to open the NVIDIA® RAID User's Guide.

### **Sil3114 User's Manual**

Allows you to open the Silicon Image SATAraid™ Serial ATA RAID Management Software user's manual.

### **NVIDIA nTune Manual**

Allows you to open the NVIDIA® nTune™ user's manual.

### **NvRAID Disk Alert User's Guide**

Allows you to open the NVIDIA® NvRAID™ user's manual.

## 5.2.5 ASUS Contact information

Click the **Contact** tab to display the ASUS contact information. You can also find this information on the inside front cover of this user guide.



## 5.2.6 Other information

The icons on the top right corner of the screen give additional information on the motherboard and the contents of the support CD. Click an icon to display the specified information.

### Motherboard Info

Displays the general specifications of the motherboard.

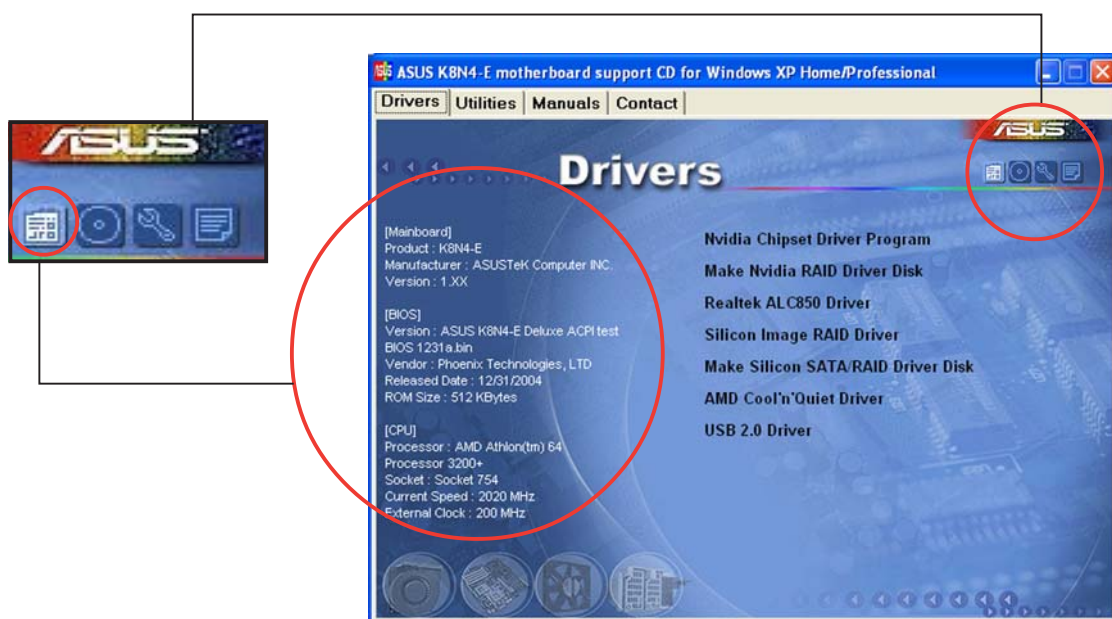

## Browse this CD

Displays the support CD contents in graphical format.

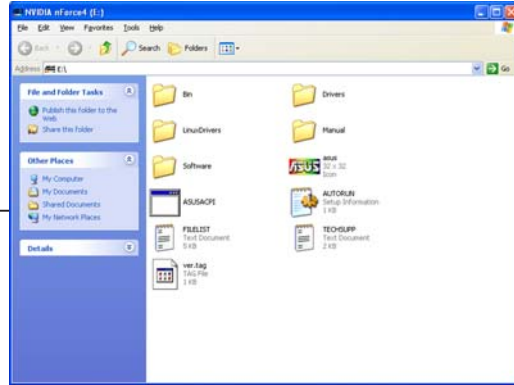

## Technical support Form

Displays the ASUS Technical Support Request Form that you have to fill out when requesting technical support.

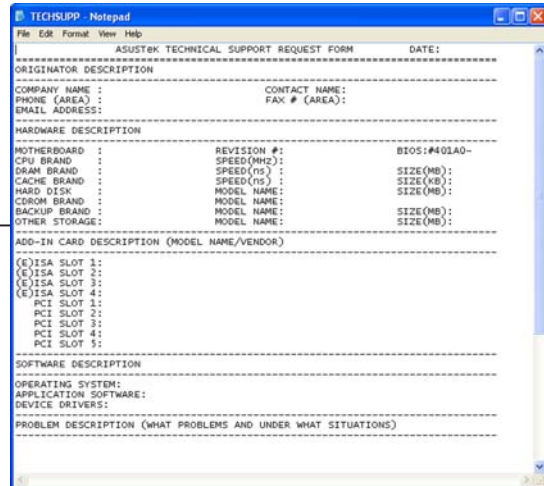
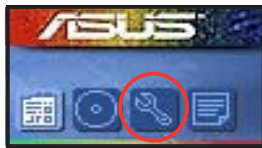

## Filelist

Displays the contents of the support CD and a brief description of each in text format.

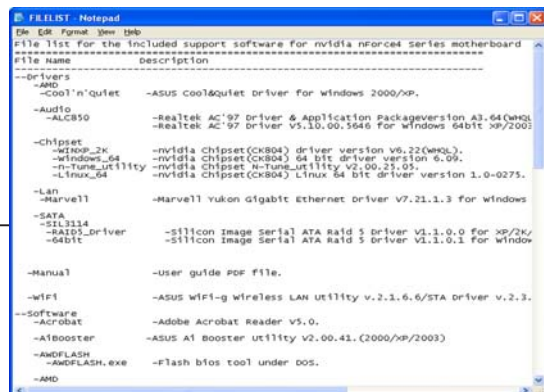
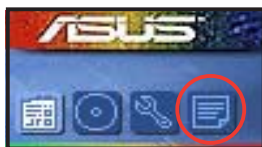

## 5.3 Software information

Most of the applications in the support CD have wizards that will conveniently guide you through the installation. View the online help or readme file that came with the software application for more information.

### 5.3.1 ASUS MyLogo2™

The ASUS MyLogo2™ utility lets you customize the boot logo. The boot logo is the image that appears on screen during the Power-On-Self-Tests (POST). The ASUS MyLogo2™ is automatically installed when you install the **ASUS Update** utility from the support CD. See section “5.2.3 Utilities menu” for details.



- Before using the ASUS MyLogo2™, use the AFUDOS utility to make a copy of your original BIOS file, or obtain the latest BIOS version from the ASUS website. See section “4.1.2 AwardBIOS Flash Utility.”
- Make sure that the BIOS item **Full Screen Logo** is set to [Enabled] if you wish to use ASUS MyLogo2. See section “4.6.5 Boot Settings Configuration.”
- You can create your own boot logo image in GIF, JPG, or BMP file formats.

To launch the ASUS MyLogo2™:

1. Launch the ASUS Update utility. Refer to section “4.1.5 ASUS Update utility” for details.
2. Select **Options** from the drop down menu, then click **Next**.
3. Check the option **Launch MyLogo to replace system boot logo before flashing BIOS**, then click **Next**.
4. Select **Update BIOS from a file** from the drop down menu, then click **Next**.
5. When prompted, locate the new BIOS file, then click **Next**. The ASUS MyLogo2 window appears.
6. From the left window pane, select the folder that contains the image you intend to use as your boot logo.



7. When the logo images appear on the right window pane, select an image to enlarge by clicking on it.



8. Adjust the boot image to your desired size by selecting a value on the **Ratio** box.



9. When the screen returns to the ASUS Update utility, flash the original BIOS to load the new boot logo.
10. After flashing the BIOS, restart the computer to display the new boot logo during POST.



## 5.3.2 AI NET2

The AI NET2 features the Marvell® Virtual Cable Tester™ (VCT). VCT is a cable diagnostic utility that reports LAN cable faults and shorts using the Time Domain Reflectometry (TDR) technology. The VCT detects and reports open and shorted cables, impedance mismatches, pair swaps, pair polarity problems, and pair skew problems of up to 64 ns at one meter accuracy.

The VCT feature reduces networking and support costs through a highly manageable and controlled network system. This utility can be incorporated in the network systems software for ideal field support as well as development diagnostics.

### Using the Virtual Cable Tester™

To use the the Marvell® Virtual Cable Tester™ utility:

1. Launch the VCT utility from the Windows® desktop by clicking **Start > All Programs > Marvell > Virtual Cable Tester**.
2. Click **Virtual Cable Tester** from the menu to display the screen below.

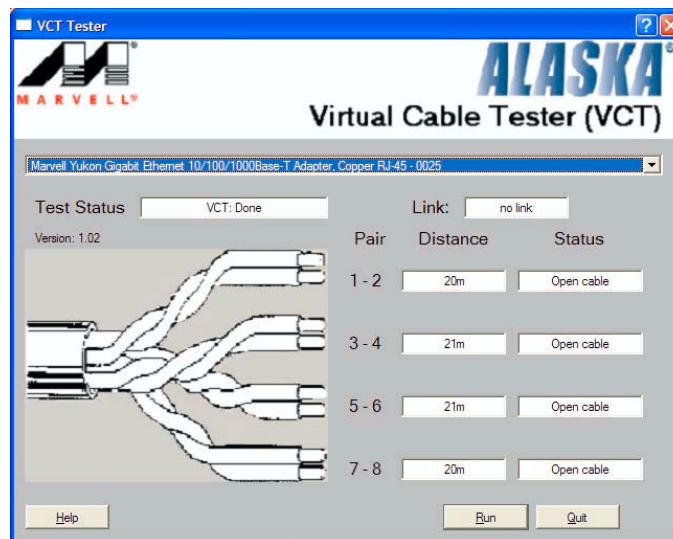

3. Click the **Run** button to perform a cable test.



- The VCT only runs on systems with Windows® XP or Windows® 2000 operating systems.
- The VCT utility only tests Ethernet cables connected to Gigabit LAN port(s).
- The **Run** button on the Virtual Cable Tester™ main window is disabled if no problem is detected on the LAN cable(s) connected to the LAN port(s).
- If you want the system to check the status of the LAN cable before entering the OS, enable the item **Post Check LAN Cable** in the BIOS Setup.

### 5.3.3 ASUS Instant Music

The motherboard is equipped with a BIOS-based audio playback feature called **Instant Music**. The onboard audio AC'97 CODEC supports this feature, which requires an optical drive (CD-ROM, DVD-ROM, or CD-RW).



- 
- Instant Music only supports CDs in audio format.
  - Instant Music does not work if you installed and enabled an add-on sound card.
  - Instant Music only supports PS/2 keyboard.
- 

To enable ASUS Instant Music:

1. Connect the analog audio cable from the optical drive (CD-ROM, DVD-ROM, or CD-RW drive) to the 4-pin CD-In connector (labeled CD) on the motherboard. See section “2.7 Connectors” for the location.



---

Make sure to connect the CD-ROM audio cable. Otherwise, you cannot control the audio volume using the Instant Music function keys.

---

2. Turn on the system and enter BIOS by pressing the **Delete** key during the Power On Self-Tests (POST).
3. From the BIOS screen select **Advanced** then **Instant Music Configuration**.
4. In the **Instant Music Configuration** menu, select the item **Instant Music** and set it to **Enabled**. See section “4.4.8 Instant Music.”
5. The **Instant Music CD-ROM Drive** item appears if you enabled Instant Music. Highlight the item then press <Enter> to display the CD-ROM options.
6. Save your changes and exit BIOS Setup.



- 
- The Scroll Lock LED is fixed to ON after enabling Instant Music.
  - The Caps Lock LED turns ON when you pause the CD playback.
  - When set to Instant Music mode, the system wake-up features (LAN, keyboard, mouse, USB) are deactivated. In this case, power up the system using the power switch.
  - If the system lost connection or did not detect any optical drive, the Instant Music feature turns OFF (disabled) automatically. A “beep” indicates this condition.
-

## To use ASUS Instant Music:

1. Ensure that the power cord is plugged to a grounded power source, so that the system has a standby power.
2. Use either one of the two sets of special function keys on your keyboard to play audio CDs. These keys only function as indicated if you enabled the Instant Music item in BIOS.

### Instant Music function keys (Set 1)

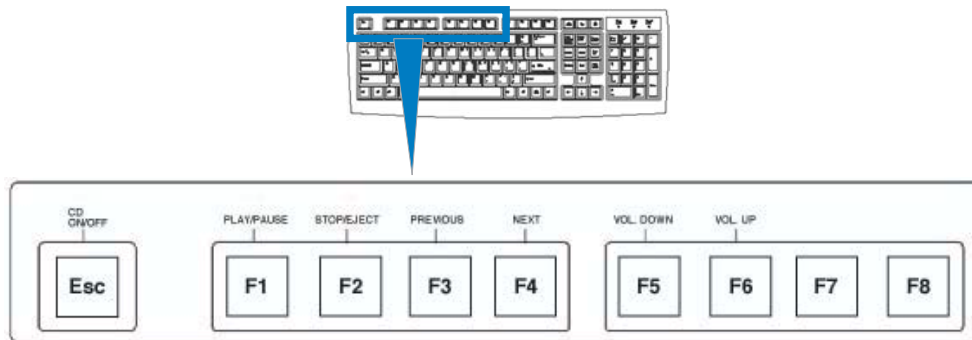

To guide you in using Instant Music, place the Instant Music label over the function keys on the keyboard. The Instant Music keyboard label comes with your motherboard package.

### Instant Music function keys (Set 2)

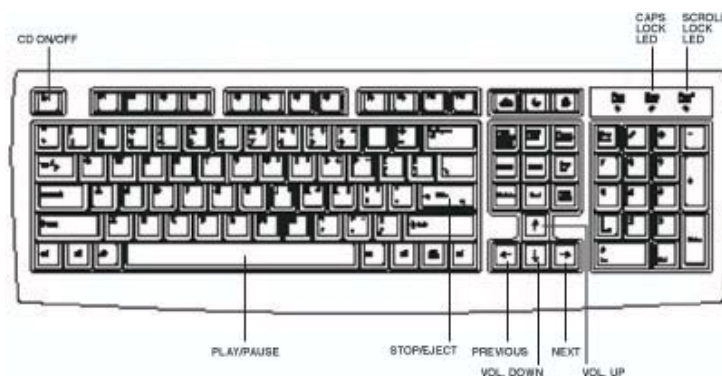

3. Connect speakers or a headphone to the Line Out (lime colored) port on the rear panel for audio output. You may also connect a headphone to the headphone jack on the CD-ROM drive front panel.
4. Press <Esc> to turn ON Instant Music.
5. Place an audio CD on the CD-ROM drive.
6. Press <F1> or the <Space Bar> to play the first track on the CD.





---

If there is no CD on the drive and you press **<F1>** or **<Space Bar>**, the drive tray ejects.

---

7. Refer to the Instant Music function key definitions on the previous page to select other tracks or control the volume.
8. Press **<F2>** or **<Enter>** once to stop playing the CD.  
Press **<F2>** or **<Enter>** *one more time* to eject the CD.

### 5.3.4 Cool ‘n’ Quiet!™ Technology

The motherboard supports the AMD Cool ‘n’ Quiet!™ Technology that dynamically and automatically change the CPU speed, voltage, and amount of power depending on the task the CPU performs.

#### Enabling Cool ‘n’ Quiet!™ Technology

To enable Cool ‘n’ Quiet!™ Technology:

1. Turn on the system and enter BIOS by pressing the <Del> key during the Power On Self-Tests (POST).
2. Go to **Advanced -> CPU Configuration -> AMD K8 Cool ‘n’ Quiet Control** and set it to [Enabled]. See section “4.4 Advanced Menu.”
3. In the **Power** menu, select the item **ACPI 2.0 Support** and set it to [Enabled]. See section “4.5 Power Menu.”
4. Save your changes and exit BIOS Setup.
5. Reboot your computer and set your Power Option Properties depending on your operating system.

#### Windows® 2000/XP

1. From the Windows® 2000/XP operating system, click the **Start** button. Select **Settings**, then **Control Panel**.
2. Make sure the Control Panel is set to Classic View.
3. Double-click the **Display** icon in the Control Panel then select the **Screen Saver** tab.
4. Click the **Power...** button. The following dialog box appears.
5. From the **Power schemes** combo list box, select **Minimal Power Management**.
6. Click **OK** to effect settings.



Make sure to install the Cool ‘n’ Quiet!™ driver and application before using this feature.

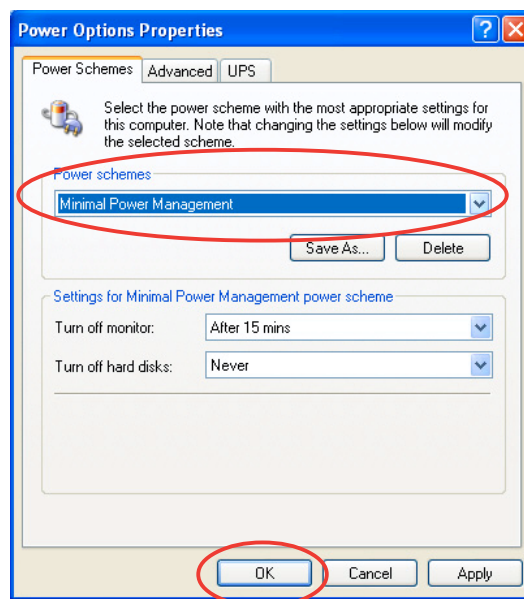

## Windows® 98 SE/Me

1. From the Windows® 98 SE/Me operating system, click the **Start** button. Select **Settings**, then **Control Panel**.
2. Double-click the **Display** icon in the Control Panel then select the **Screen Saver** tab.
3. From the **Energy saving features of monitor** group, click the **Settings...** button.

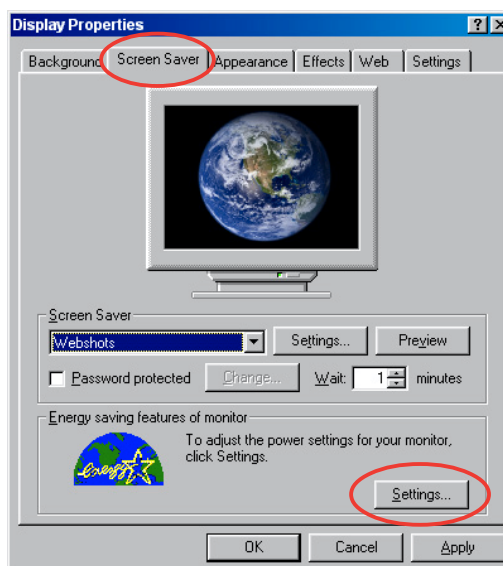

4. From the **Power Options Properties** dialog box, select the **AMD's Cool 'n' Quiet(tm) Technology** tab.
5. Click the **Performance** combo list box to select desired mode. Automatic Mode is the recommended setting.
6. Click **OK** to effect settings.

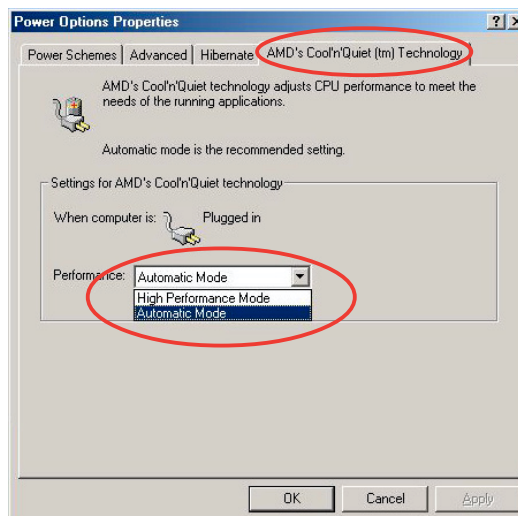

- Make sure to install the AMD Cool 'n' Quiet!™ driver and application before using this feature.
- The AMD Cool 'n' Quiet!™ technology feature works only with the AMD heatsink and fan assembly with monitor chip
- If you purchased a separate heatsink and fan package, use the ASUS Q-Fan technology feature to automatically adjust the CPU fan speed according to your system loading.

## Launching the Cool 'n' Quiet!™ software

The motherboard support CD includes the Cool 'n' Quiet!™ software that enables you to view your system's real-time CPU Frequency and voltage.



---

Make sure to install the Cool 'n' Quiet!™ software from the motherboard support CD. Refer to section "5.2.3 Utilities menu" for details.

---

To launch the Cool 'n' Quiet!™ program:

1. If you are using Windows® 98SE/Me/2000, click the **Start** button. Select **Programs-> ASUS -> Cool & Quiet -> Cool & Quiet.**
2. If you are using Windows® XP, click the **Start** button. Select **All Programs-> ASUS -> Cool & Quiet -> Cool & Quiet.**
3. The Cool 'n' Quiet!™ technology screen appears and displays the current CPU Frequency and CPU Voltage.

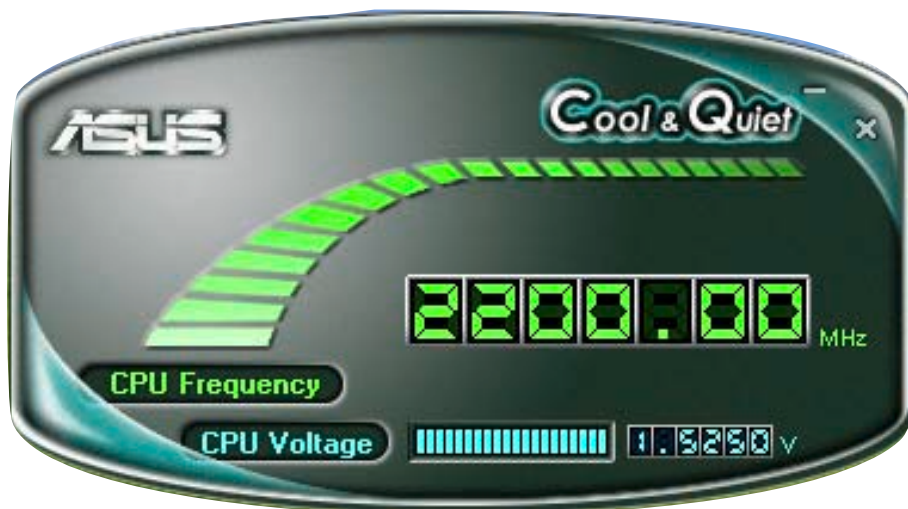

### 5.3.5 Audio configurations

The Realtek® ALC850 AC '97 audio CODEC provides 8-channel audio capability to deliver the ultimate audio experience on your PC. The software provides Jack-Sensing function (Line-In, Line-Out, Mic-In), S/PDIF out support and interrupt capability. The ALC850 also includes the Realtek® proprietary UAJ® (Universal Audio Jack) technology for three ports (Line-In, Line-Out and Mic-In), eliminating cable connection errors and giving users plug and play convenience.

Follow the installation wizard to install the **Realtek ALC850 Audio Driver and Application** from the support CD that came with the motherboard package.

If the Realtek audio software is correctly installed, you will find the SoundEffect icon on the taskbar.

From the taskbar, double-click on the **SoundEffect** icon to display the **Realtek Audio Control Panel**.



The Jack-sensing and UAJ® technology features are supported on the Line-In, Line-Out, and Mic jacks only.

#### Sound Effect options

The Realtek® ALC850 Audio CODEC allows you to set your listening environment, adjust the equalizer, set the karaoke, or select pre-programmed equalizer settings for your listening pleasure.

To set the sound effect options:

1. From the Realtek Audio Control Panel, click the **Sound Effect** button.
2. Click the shortcut buttons to change the acoustic environment, adjust the equalizer, or set the karaoke to your desired settings.
3. The audio settings take effect immediately after you click on the buttons.
4. Click the Exit (X) button on the upper-right hand corner of the window to exit.



## S/PDIF options

The Sony/Philips Digital Interface (S/PDIF) options allows you to change your S/PDIF output settings.

To set the S/PDIF options:

1. From the Realtek Audio Control Panel, click the **SPDIF** button.
2. Click the option buttons to change your S/PDIF out settings.
3. Click the Exit (X) button on the upper-right hand corner of the window to exit.





## Speaker Configuration

This option allows you to set your speaker configuration.

To set the speaker configuration:

1. From the Realtek Audio Control Panel, click the **Speaker Configuration** button.
2. Select from the combo list box your current speaker setup, then click **Auto Test** to test your settings.
3. Click the **UAJ Automatic** button to enable or disable the Universal Audio Jack(UAJ®) technology feature.
4. Click the Exit (X) button on the upper-right hand corner of the window to exit.



## AI Audio feature

The AI Audio feature works through the connector sensing option that allows you to check if your audio devices are connected properly.

To start the connector sensing:

1. From the Realtek Audio Control Panel, click the **Connector Sensing** button.
2. Click the **Bracket** button to display connected audio devices.
3. Click the **Option** button to change sensing options.
4. Click the **Start** button to start connection sensing. A progress bar displays current connector sensing status.



---

Make sure to exit all audio applications before starting this function.

---



5. When finished, the utility prompts the Realtek® EZ-connection dialog box showing your current audio connections. The text at the bottom of the box explains your audio connection status. An *X* mark denotes an incorrect connection.



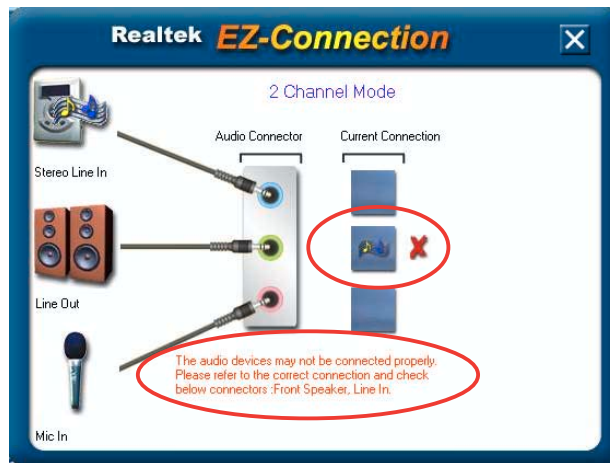

6. If there are detected problems, make sure that your audio cables are connected to the proper audio jack and repeat connector sensing.
7. Click the **X** button to exit EZ-connection dialog box.
8. Click the Exit (**X**) button on the upper-right hand corner of the window to exit audio control panel.

## HRTF Demo

This option shows a demo of the Head-Related Transfer Functions (HRTF).

To start the HRTF demo:

1. From the Realtek Audio Control Panel, click the **HRTF Demo** button.
2. Click the option buttons to change the sound, moving path or EAX settings.
3. Click the **Play** button to start or the **Stop** button to stop.
4. Click the Exit (**X**) button on the upper-right hand corner of the window to exit.



## General settings

This option shows the audio settings and allows you to change the language setting or toggle the SoundEffect icon display on the Windows taskbar.

To display the general settings:

1. From the Realtek Audio Control Panel, click the **General** button.
2. Click the option button to enable or disable the icon display on the Windows taskbar.
3. Click the **Language** combo list box to change language display.
4. Click the Exit (X) button on the upper-right hand corner of the window to exit.



## Rear panel audio ports function variation

The functions of the Line Out (lime), Line In (blue), Mic (pink), Center/Subwoofer (Yellow Orange), Rear Speaker Out (Black), and Side Speaker Out (Gray) ports on the rear panel change when you select the 4-channel, 6-channel or 8-channel audio configuration as shown in the following table.

## Audio 2, 4, 6, or 8-channel configuration

Port	Headset 2-channel	4-channel	6-channel	8-channel
Light Blue	Line In	Line In	Line In	Line In
Lime	Line Out	Front Speaker Out	Front Speaker Out	Front Speaker Out
Pink	Mic In	Mic In	Mic In	Mic In
Gray	-	Rear Speaker Out	Rear Speaker Out	Rear Speaker Out
Black	-	-	-	Side Speaker Out
Yellow Orange	-	-	Center/Subwoofer	Center/Subwoofer

### 5.3.6 Using the NVIDIA® Firewall™

The motherboard supports the NVIDIA® Firewall™ (NVFirewall™) application that protects your computer from intruders. The NVFirewall™ is classified as a personal firewall or desktop firewall that works at the device level to protect your system from malicious computer code by controlling the connections to and from your computer and alerting you for attempted intrusions. The following sections describe how to use the NVIDIA® Firewall™.

#### Launching the NVFirewall™ summary

After you install the NVFirewall™ application from the motherboard support CD, it is automatically activated with a **Medium** security profile as its default setting. The setup summary of NVFirewall™ is displayed in the summary menu.

To launch the NVFirewall™ summary menu:

1. Click the **NVIDIA® Firewall™ icon** from the Windows® taskbar.

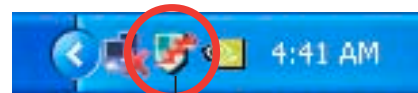

NVIDIA® Firewall™ icon

2. Double-click the icon to display the NVFirewall™ Summary menu.

Click to select firewall profile

Click to view profile details

Click to view the firewall log

Click to view the firewall stats

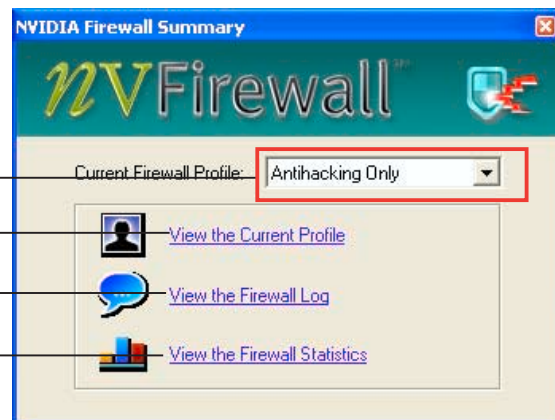

## Setting security profiles

The NVFirewall™ application allows several security profiles to match your system security needs. The following describes the NVFirewall™ security profiles:

- **Low** - allows safe incoming connections and deny those that are known to be dangerous connections. This profile also enables some anti-hacking features.
- **Medium** - blocks most incoming connections. Incoming connections to some ports must be set to allow file transfers using some online messaging applications. This profile also enables some anti-hacking features.
- **High** - allows the least traffic through. Only outbound connections are allowed. This profile also includes the “stealth mode” feature that makes your system invisible to intruders. This also enables some anti-hacking features.
- **Lockdown** - blocks all incoming and outgoing connections.
- **Anti-hacking only** - this profile enables all anti-hacking features but disables the firewall. This security profile is useful if you want to use a third-party firewall application.
- **Custom 1, 2, 3** - these are reserved for customized profiles.
- **Off** - deactivates the firewall.

To set a security profile:

1. From the NVFirewall™ summary menu, click the **Current Firewall Profile** combo list box then select a security profile.

The following confirmation box appears.



2. Click **Change Profile** to apply settings or **Don't Change Profile** to return to previous menu.



## Turning the NVFirewall™ off



Take caution when using this option. Your computer becomes vulnerable to viruses, hackers or intruders after you turn off the firewall.

To turn off the NVFirewall:

1. From the NVIDIA Firewall summary menu, click the **Current Firewall Profile** combo list box then select **Off**. The following confirmation box appears.



2. Click **Turn Firewall OFF**.

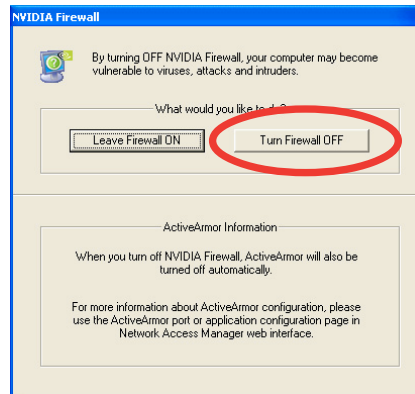

### 5.3.7 Using the NVIDIA® nTune™ utility

The motherboard supports the NVIDIA® nTune™ utility that allows easy and safe system tuning for optimum performance. This utility provides the safest and easiest way to tweak voltages or change system bus speeds and memory timings for maximum system performance.

Follow the **NVIDIA Chipset Driver Program** installation wizard to install the NVIDIA® nTune™ utility from the motherboard support CD.

After you have successfully installed the utility in your computer, launch the nTune™ utility from the Windows® desktop by clicking **Start > All Programs > NVIDIA Corporation > nTune > nTune** from the Windows® taskbar.

#### Managing your nForce™ system

The Manage my nForce™ system menu allows you to benchmark and automatically tune your system, manage your nTune™ profiles, monitor your system, troubleshoot performance, create a log, get online support, or update the BIOS. This menu also provides shortcuts to manage your nForceware™ settings.

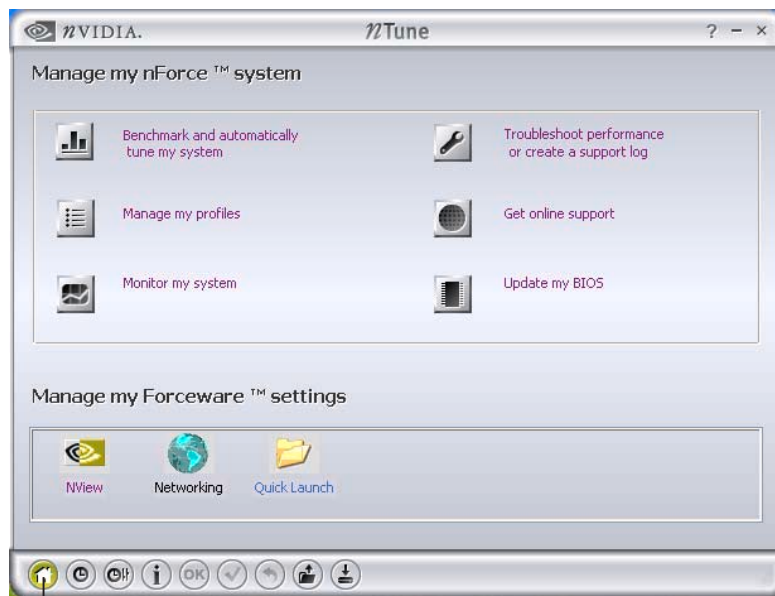

Click to launch **Manage my nForce™ system** menu

## Clock control

The Clock control menu allows dynamic modifications for system bus speeds and memory controller timing. The system bus speed includes the front side bus (FSB) and AGP bus.

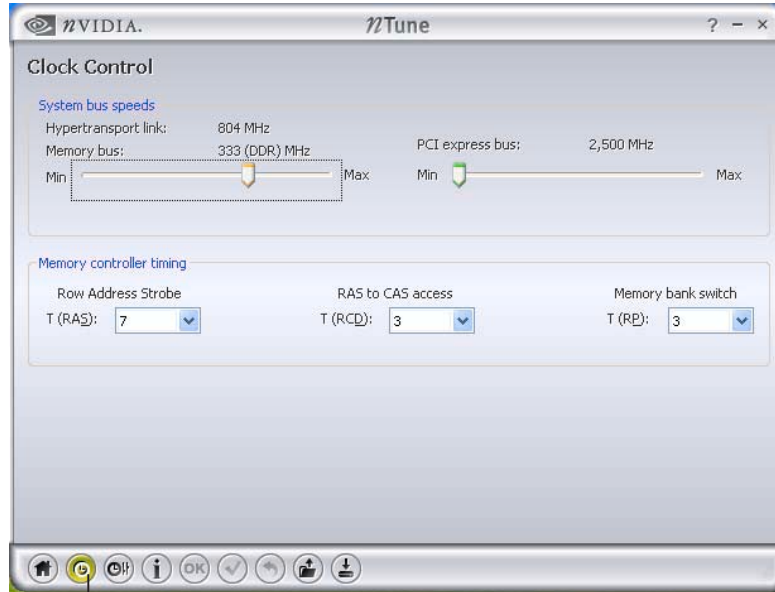

Click to launch the Clock control menu

## Voltage/Fan control

The Voltage/Fan control menu allows tweaking options for the CPU and memory voltage. This menu also allows dynamic modifications for the CPU and auxiliary fan speeds.

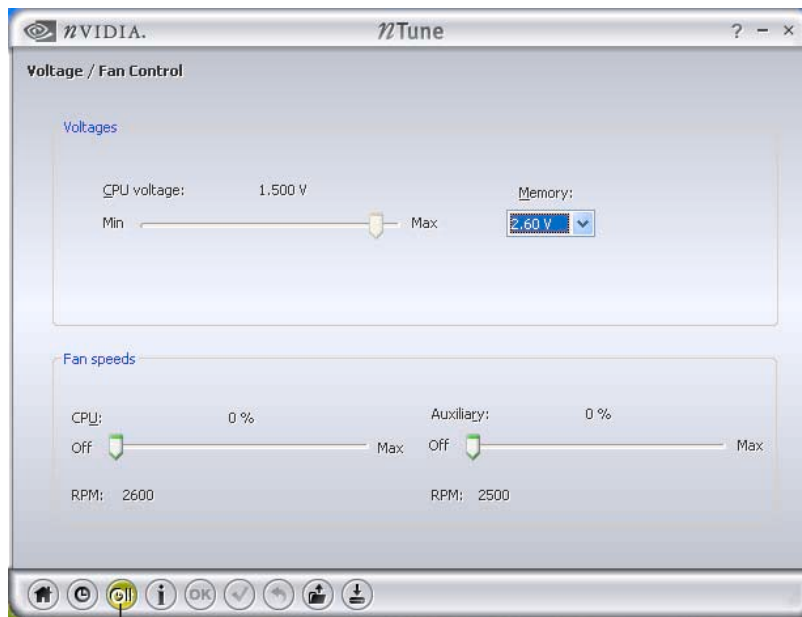

Click to launch the Voltage/Fan menu



## Information

The information page displays related information about the processor, memory, motherboard, nForce™ profile, version information, and the calculated system performance results.

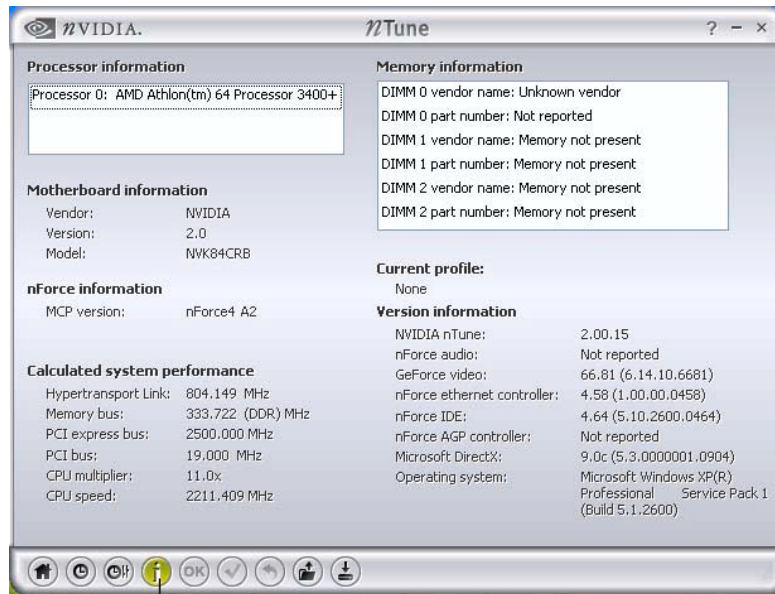

Click to launch the Information page

## Other options

Other option buttons allow you to easily save or revert your settings and save or load nTune™ profiles.



Click to save settings and exit

Click to save settings only

Click to revert changes

Click to load saved nTune™ profile

Click to save settings in a profile



## 5.4 RAID configurations

The motherboard comes with the NVIDIA® nForce4-4X chipset RAID controller and the Silicon Image RAID utility that allow you to configure Serial ATA hard disk drives as RAID sets. The motherboard supports the following RAID configurations.

**RAID 0** (*Data striping*) optimizes two identical hard disk drives to read and write data in parallel, interleaved stacks. Two hard disks perform the same work as a single drive but at a sustained data transfer rate, double that of a single disk alone, thus improving data access and storage. Use of two new identical hard disk drives is required for this setup.

**RAID 1** (*Data mirroring*) copies and maintains an identical image of data from one drive to a second drive. If one drive fails, the disk array management software directs all applications to the surviving drive as it contains a complete copy of the data in the other drive. This RAID configuration provides data protection and increases fault tolerance to the entire system. Use two new drives or use an existing drive and a new drive for this setup. The new drive must be of the same size or larger than the existing drive.

**RAID 0+1** is *data striping* and *data mirroring* combined without parity (redundancy data) having to be calculated and written. With the RAID 0+1 configuration you get all the benefits of both RAID 0 and RAID 1 configurations. Use four new hard disk drives or use an existing drive and three new drives for this setup.

**RAID 5** stripes both data and parity information across three or more hard disk drives. Among the advantages of RAID 5 configuration include better HDD performance, fault tolerance, and higher storage capacity. The RAID 5 configuration is best suited for transaction processing, relational database applications, enterprise resource planning, and other business systems. Use a minimum of three identical hard disk drives for this setup.

**RAID 10** is a striped configuration with RAID 1 segments whose segments are RAID 1 arrays. This configuration has the same fault tolerance as RAID 1, and has the same overhead for fault-tolerance as mirroring alone. RAID 10 achieves high input/output rates by striping RAID 1 segments. In some instances, a RAID 10 configuration can sustain multiple simultaneous drive failure. A minimum of four hard disk drives is required for this setup.

**JBOD** (*Spanning*) stands for **Just a Bunch of Disks** and refers to hard disk drives that are not yet configured as a RAID set. This configuration stores the same data redundantly on multiple disks that appear as a single disk on the operating system. Spanning does not deliver any advantage over using separate disks independently and does not provide fault tolerance or other RAID performance benefits.



---

If you use either Windows® XP or Windows® 2000 operating system (OS), copy first the RAID driver from the support CD to a floppy disk before creating RAID configurations. Refer to section “5.5 Creating a RAID driver disk” for details.

---

## 5.4.1 Installing hard disks

The motherboard supports Serial ATA hard disk drives. For optimal performance, install identical drives of the same model and capacity when creating a disk array.

### Installing Serial ATA (SATA) hard disks

To install the SATA hard disks for a RAID configuration:

1. Install the SATA hard disks into the drive bays.
2. Connect the SATA signal cables.
3. Connect a SATA power cable to the power connector on each drive.



- 
- If you are creating a **RAID 0 (striping)** array for performance, use two new drives.
  - If you are creating a **RAID 1 (mirroring)** array for protection, you can use two new drives or use an existing drive and a new drive (the new drive must be of the same size or larger than the existing drive).
  - If you are creating a **RAID 0+1** array for protection, you can use four new drives or use an existing drive and three new drives.
  - If you are creating a **RAID 10** array for very high reliability combined with high performance, a minimum of four disk drives is required.
  - If you are creating a **RAID 5** configuration, use a minimum of three disk drives; the maximum number of drives is set by controller. Use of disk drives with identical size and type is recommended.
-

## 5.4.2 NVIDIA® RAID configurations

The motherboard includes a high performance IDE RAID controller integrated in the NVIDIA® nForce™ 4-4X chipset. The chipset supports RAID 0, RAID 1, RAID 0+1, and JBOD configurations. Use the NVIDIA® RAID utility to configure a disk array.

### Setting the BIOS RAID items

After installing the hard disk drives, make sure to set the necessary RAID items in the BIOS before setting your RAID configuration.

To set the BIOS RAID items:

1. Boot the system and press <Del> during the Power-On Self-Test (POST) to enter the BIOS Setup Utility.
2. From the **Advanced > Onboard Devices Configuration > NVRAID Configuration** menu item in the BIOS set the **RAID Enabled** item to Enabled. The succeeding items become user-configurable.
3. Select and enable the IDE or SATA drive(s) that you want to configure as RAID. See section “4.4.3 Onboard Devices Configuration” for details.
4. Save your changes and Exit Setup.



---

For detailed descriptions on the NVIDIA® RAID configuration, refer to the “NVIDIA® RAID User’s Manual” found in your motherboard support CD.

---

## Entering the NVIDIA® RAID utility

To enter the NVIDIA® RAID utility:

1. Boot up your computer.
2. During POST, press <F10> to display the main menu of the utility.



The RAID BIOS setup screens shown in this section are for reference only, and may not exactly match the items on your screen.

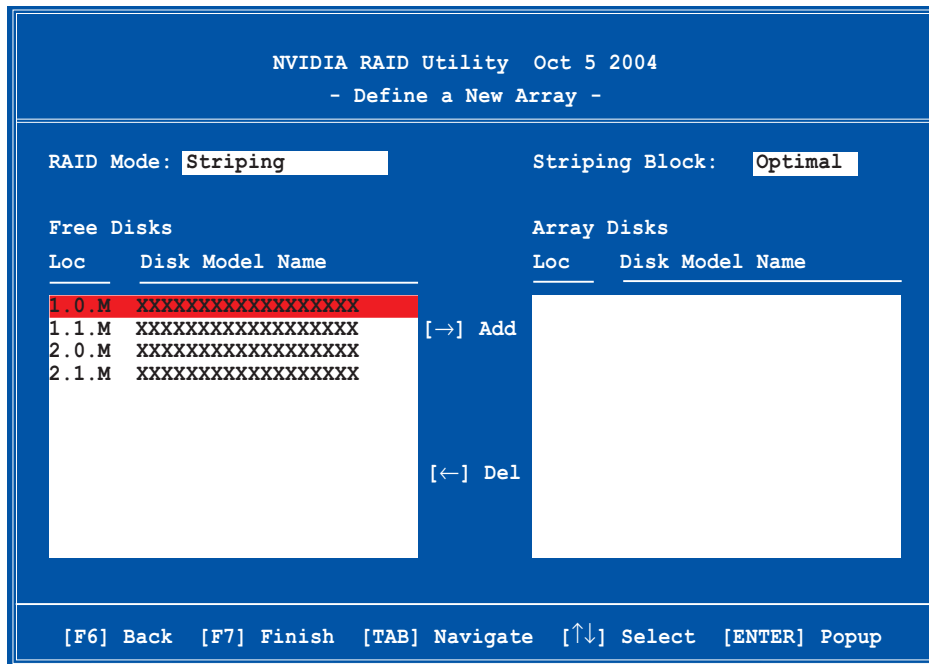

At the bottom of the screen are the navigation keys. These keys allow you to move through and select menu options.

## Creating a RAID Volume

To create a RAID volume:

1. From the NVIDIA® RAID utility Define a New Array menu, select **RAID Mode** then press <Enter>. The following submenu appears.

Use the up or down arrow keys to select a RAID mode then press <Enter>.

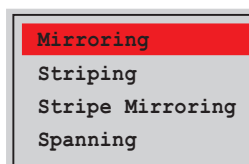

2. Press <TAB> select the Striping Block then press <Enter>. The following submenu appears:

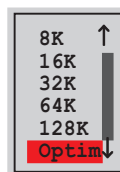

If you selected Striping or Stripe Mirroring, use the up or down arrow keys to select the stripe size for your RAID 0 array then press <Enter>. The available values range from 8 KB to 128 KB. The default selection is 128 KB. The strip value should be chosen based on the planned drive usage.

- 8 /16 KB - low disk usage
- 64 KB - typical disk usage
- 128 KB - performance disk usage



---

**TIP:** For server systems, use of a lower array block size is recommended. For multimedia computer systems used mainly for audio and video editing, a higher array block size is recommended for optimum performance.

---

3. Press <TAB> to select the Free Disks area. Use the left or right arrow keys to assign the array disks.
4. Press <F7> to create RAID set. The following message box appears.

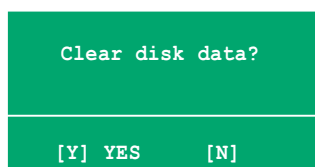

5. Press <Y> to clear the selected disks or <N> to proceed without clearing the disks. The following screen appears.



---

Take caution in using this option. All data on the RAID drives will be lost!

---

```

NVIDIA RAID Utility  Oct 5 2004
- Array List -

  Boot  Id  Status  Vendor  Array Model Name
  ----  -  -  -  -
No     4  Healthy  NVIDIA  MIRROR  XXX.XXG

[Ctrl-X]Exit  [↑↓]Select  [B]Set Boot  [N]New Array  [ENTER]Detail

```

A new set of navigation keys is displayed on the bottom of the screen.

6. Press <Ctrl+X> to save settings and exit.

## Rebuilding a RAID array

To rebuild a RAID array:

1. From the Array List menu, use the up or down arrow keys to select a RAID array then press <Enter>. The RAID Array details appear.

```

Array 1 : NVIDIA MIRROR  XXX.XXG
- Array Detail -

RAID Mode: Mirroring
Striping Width: 1          Striping Block: 64K

  Adapt  Channel  M/S  Index  Disk Model Name  Capacity
  ----  -  -  -  -  -
  2      1      Master  0      XXXXXXXXXXXXXXXXX  XXX.XXGB
  1      0      Master  1      XXXXXXXXXXXXXXXXX  XXX.XXGB

[R] Rebuild  [D] Delete  [C] Clear Disk  [ENTER] Return

```



A new set of navigation keys is displayed on the bottom of the screen.

2. Press <R> to rebuild a RAID array. The following screen appears.

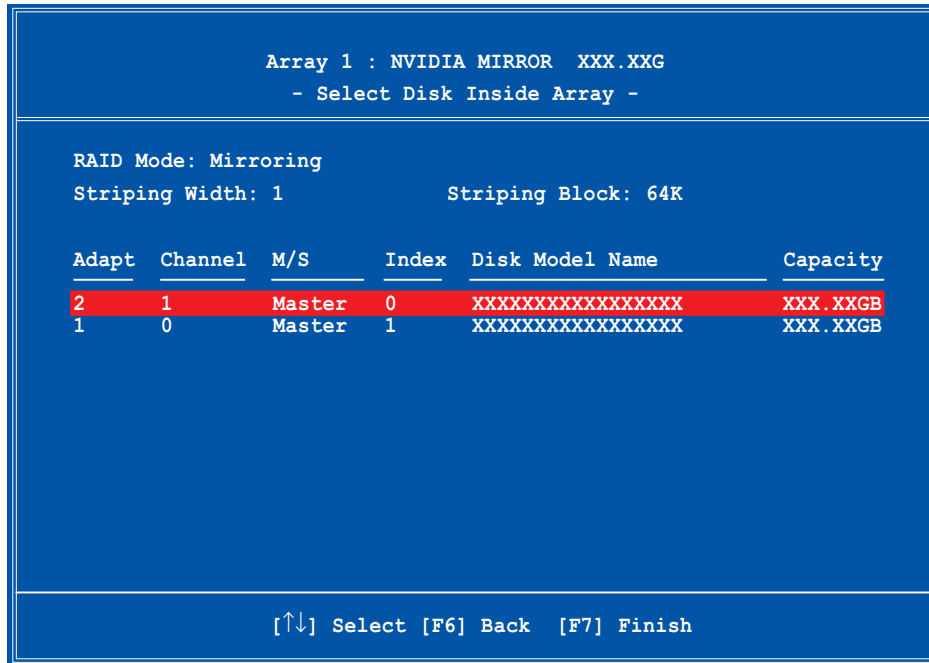

3. Use the up or down arrow keys to select a RAID array to rebuild, then press <F7>. The following confirmation message appears.



4. Press <Enter> to start rebuilding array or press <Esc> to cancel.
5. After the rebuild process, the Array list menu appears.

## Deleting a RAID array

To delete a RAID array:

1. From the Array List menu, use the up or down arrow keys to select a RAID array then press <Enter>. The RAID Array details appear.

```
Array 1 : NVIDIA MIRROR XXX.XXG
- Array Detail -

RAID Mode: Mirroring
Striping Width: 1          Striping Block: 64K

Adapt  Channel  M/S      Index  Disk Model Name      Capacity
-----  -
2       1         Master   0      XXXXXXXXXXXXXXXXXXXX  XXX.XXGB
1       0         Master   1      XXXXXXXXXXXXXXXXXXXX  XXX.XXGB

[R] Rebuild [D] Delete [C] Clear Disk [ENTER] Return
```

A new set of navigation keys is displayed on the bottom of the screen.

2. Press <D> to delete a RAID array. The following confirmation message appears.

```
Delete this array?

[Y] YES [N] No
```

3. Press <Y> to delete array or press <N> to cancel.



Take caution in using this option. All data on the RAID drives will be lost!

4. If you selected Yes, the Define a New Array menu appears.

## Clearing a disk data

To clear disk data:

1. From the Array List menu, use the up or down arrow keys to select a RAID array then press <Enter>. The RAID Array details appear.

```
Array 1 : NVIDIA MIRROR XXX.XXG
- Array Detail -

RAID Mode: Mirroring
Striping Width: 1          Striping Block: 64K

Adapt  Channel  M/S      Index  Disk Model Name      Capacity
-----  -
2       1          Master   0      XXXXXXXXXXXXXXXXXXXX XXX.XXGB
1       0          Master   1      XXXXXXXXXXXXXXXXXXXX XXX.XXGB

[R] Rebuild [D] Delete [C] Clear Disk [ENTER] Return
```

A new set of navigation keys is displayed on the bottom of the screen.

2. Press <C> to clear disk. The following confirmation message appears.

```
Clear disk data?

[Y] YES [N]
```

5. Press <Y> to clear the disk data or press <N> to cancel.



Take caution in using this option. All data on the RAID drives will be lost!

### 5.4.3 Silicon Image RAID configurations

The Silicon Image RAID controller supports RAID 0, RAID 1, RAID 10, and RAID 5 configurations. Use the Silicon Image RAID utility to configure a disk array.

#### Setting the BIOS RAID items

After installing the hard disk drives, make sure to set the necessary RAID items in the BIOS before setting your RAID configuration.

To set the BIOS RAID items:

1. Boot the system and press <Del> during the Power-On Self-Test (POST) to enter the BIOS Setup Utility.
2. From the **Advanced > Onboard Devices Configuration** menu item in the BIOS set the **Silicon Image Controller** item to RAID Mode. See section “4.4.3 Onboard Devices Configuration” for details.
3. Save your changes and Exit Setup.

#### Launching the Silicon Image Array Management Software

Launch the Silicon Image Array Management software from Windows® XP by clicking the **Start** button and selecting **All Programs > Silicon Image > Sam**



- 
- For details on the Silicon Image SATAraid™ RAID configuration, refer to the “Sil3114 User’s Manual” in your motherboard support CD.
  - You can only set the SATALink™ RAID 5 configuration using the SATALink™ SATA RAID Management Software.
  - Make sure to install the Silicon Image SATA Link Sil 3114 driver and the Silicon Image RAID 5 Array Management Utility from the support CD before using RAID 5 configuration.
-

## Entering the Silicon Image BIOS RAID Configuration Utility

To enter the Silicon Image BIOS RAID configuration utility:

1. Boot up your computer.
2. During POST, press <Ctrl+S> or <F4>.



The RAID BIOS setup screens shown in this section are for reference only, and may not exactly match the items on your screen.

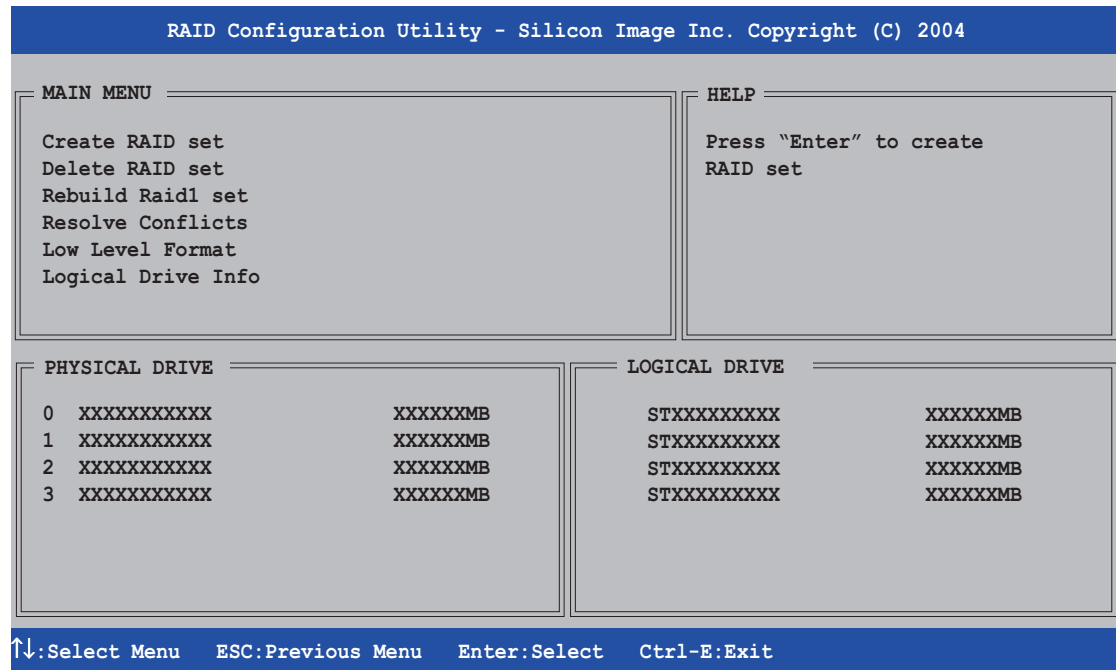

The Main Menu on the upper left corner allows you to select an operation to be performed. The Main Menu options include the following:

**Create RAID set** - creates a new legacy RAID set or allocates spare drives.

**Delete RAID set** - deletes a RAID set or deallocates a spare drive.

**Rebuild RAID1 set** - rebuilds a RAID 1 set (e.g. swapped drives).

**Resolve Conflicts** - automatically restores disrupted drives on a RAID set.

**Low Level Format** - creates a pattern of reference marks on a drive.

Formatting the disks erases all data previously stored in the drive.

**Logical Drive Info** - shows the current configuration of each RAID set.

On the upper right corner of the screen is the Help message box. The message describes the function of each menu item. At the bottom of the screen is the legend box. The keys on the legend box allow you to navigate through the setup menu options. The following lists the keys found in the legend box and their corresponding functions.

↑, ↓ : Select/Move to the next item

ESC : Previous Menu

Enter : Select

Ctrl-E : Exit

## Creating a RAID 0 set (Striped)

To create a RAID set:

1. From the Silicon Image configuration utility main menu, select **Create RAID set** then press <Enter> to display an option menu.

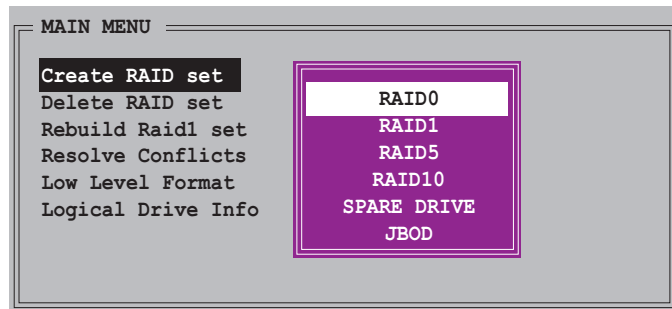

2. Select **RAID 0** then press <Enter> to display the following.

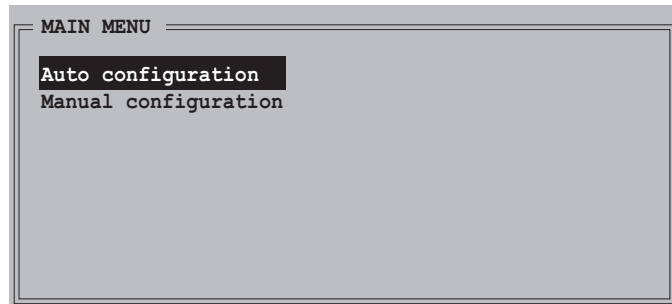

3. Select your desired method of configuration.  
**Auto configuration**
  - a. Select Auto Configuration the press <Enter>.
  - b. The utility prompts a message to input the RAID size, use the up or down arrow keys to set the RAID size then press <Enter>.
  - c. Press <Y> to confirm or <N> to return to the Main Menu.



By default, Auto configuration sets the stripe size to 64K and sets the logical drives based on the physical drives installed.

### Manual configuration

- a. Select **Manual configuration** and press <Enter>. The following pop-up menu appears.
- b. Use the up or down arrow keys to select a chunk size appropriate to your drive usage then press <Enter>.

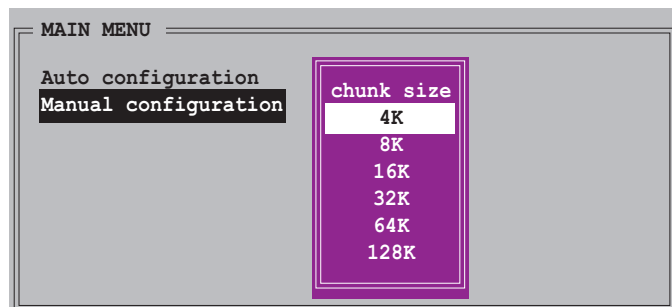



**TIP:** For server systems, use of a lower array block size is recommended. For multimedia computer systems used mainly for audio and video editing, a higher array block size is recommended for optimum performance.

- c. The selection bar moves to the Physical Drive menu. Using the up or down arrow keys, select a drive then press <Enter> to set the first drive of the RAID set.

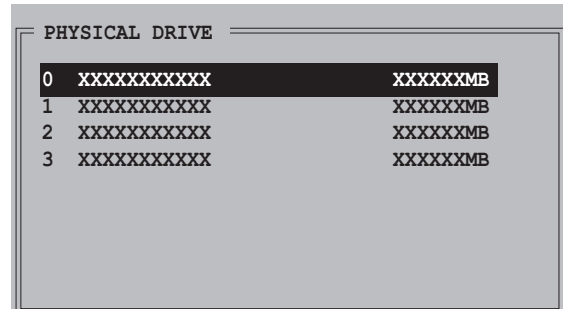

- d. Repeat step c to set the second, third, and fourth drive. The number of available drives depend on the installed and enabled physical drives in the system.
- e. The utility prompts a message to input the RAID size, use the up or down arrow keys to set the RAID size then press <Enter>.
- f. Press <Y> to confirm or <N> to return to the Main Menu.

## Creating a RAID 1 set (Mirrored)

To create a RAID 1 set:

1. From the Silicon Image configuration utility main menu, select **Create RAID set** then press <Enter>. The following sub-menu appears.

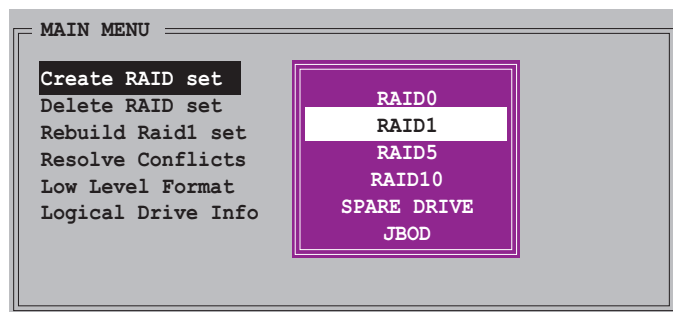

2. Select **RAID 1** then press <Enter> to display the following.

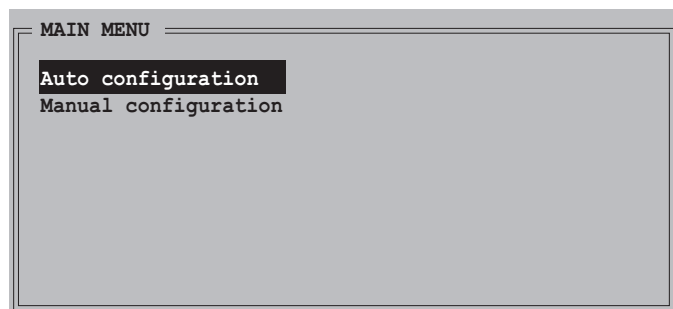

3. Select your desired method of configuration.

### Auto configuration

- a. Select Auto Configuration then press <Enter>.
- b. The utility prompts a message to input the RAID size, use the up or down arrow keys to set the RAID size then press <Enter>.
- c. Press <Y> to confirm or <N> to return to the Main Menu.



- Auto-configuration creates a RAID 1 set without a backup copy of the current source disk data.
- When migrating a single hard disk drive to a RAID 1 set, use of the Manual configuration is recommended.

### Manual configuration

- a. Select **Manual configuration** and press <Enter>. The selection bar moves to the Physical Drives menu.
- b. Using the up or down arrow keys, select the *source drive* and press <Enter>.
- c. Repeat step b to select the *target drive*.
- d. After selecting the source and target drives, the following pop-up menu appears.

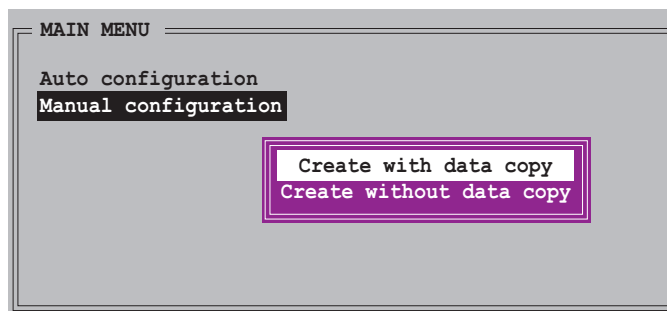
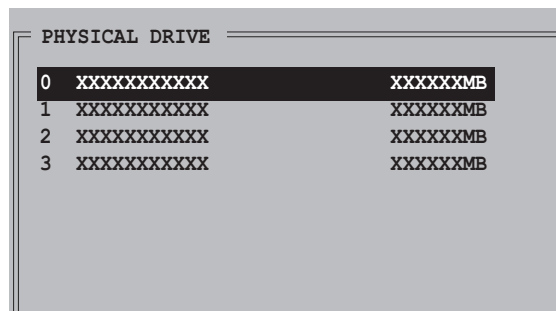

- The **Create with data copy** option allows you to copy the current data from the source drive to the mirror drive.
- Select **Create with data copy** if you have important data in your source drive.
- The **Create without data copy** option disables the disk copy function of the Mirrored set.
- If you selected **Create without data copy**, the RAID 1 set must be repartitioned and reformatted to guarantee the consistency of its contents.



- e. If you selected **Create with data copy**, the following pop-up menu appears.

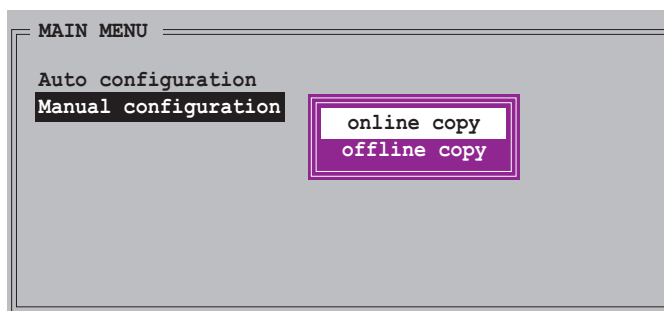

The **online copy** option automatically copies the data to the target drives on the background while writing to the source drives. The **offline copy** option allows you to copy the contents of the source drive to the target drives now.

- f. Use the up or down arrow keys to select desired copy method, then press <Enter>.
- g. The utility prompts a message to input the RAID size, use the up or down arrow keys to set the RAID size then press <Enter>.
- h. Press <Y> to confirm or <N> to return to the Main Menu.



A copy progress appears if you previously selected offline copy.

## Creating a RAID 5 set (Parity)

To create a RAID 5 set:

1. From the Silicon Image configuration utility main menu, select **Create RAID set** then press <Enter>. The following sub-menu appears.
2. Select **RAID 5** then press <Enter> to display the following.

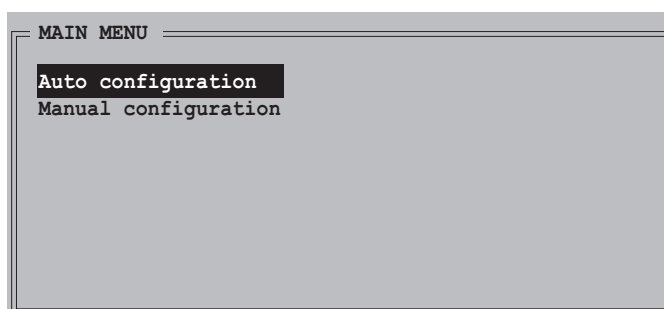
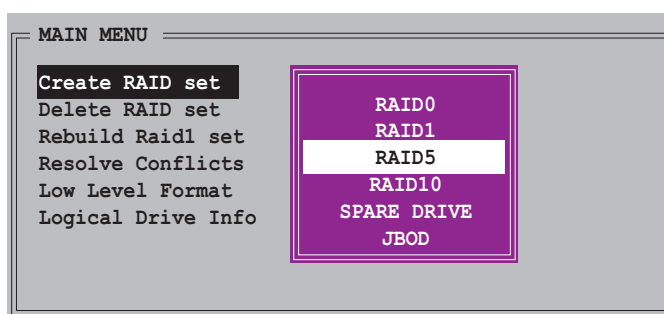

3. Select your desired method of configuration.

### Auto configuration

- a. Select Auto Configuration then press <Enter>.
- b. The utility prompts a message to input the RAID size, use the up or down arrow keys to set the RAID size then press <Enter>.
- c. Press <Y> to confirm or <N> to return to the Main Menu.

### Manual configuration

- a. Select **Manual configuration** and press <Enter>. The following pop-up menu appears.
- b. Use the up or down arrow keys to select a chunk size appropriate to your drive usage then press <Enter>.

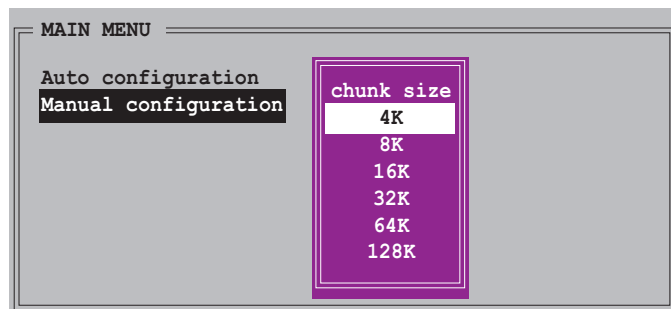

**TIP:** For server systems, use of a lower array block size is recommended. For multimedia computer systems used mainly for audio and video editing, a higher array block size is recommended for optimum performance.

- c. The selection bar moves to the Physical Drive menu. Using the up or down arrow keys, select a drive then press <Enter> to set the first drive of the RAID set.

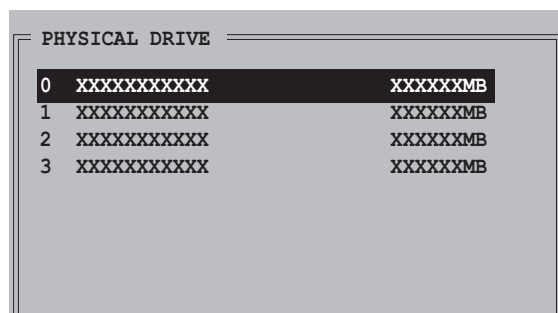

- d. Repeat step c to set the second, third and fourth drive. The number of available drives depend on the installed and enabled physical drives in the system.
- e. The utility prompts a message to input the RAID size, use the up or down arrow keys to set the RAID size then press <Enter>.
- f. Press <Y> to confirm or <N> to return to the Main Menu.

## Creating a RAID 10 set (Mirrored+Striped)

To create a RAID 10 set:

1. From the Silicon Image configuration utility main menu, select **Create RAID set** then press <Enter>. The following sub-menu appears.

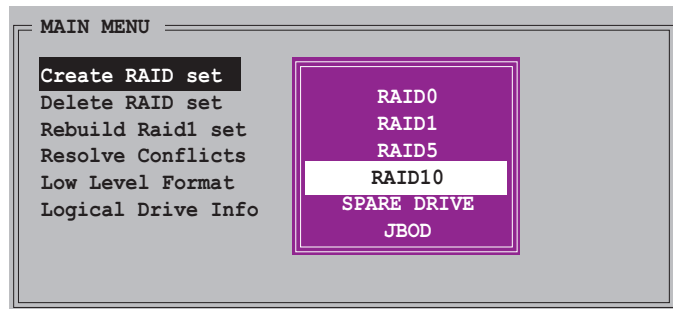

2. Select **RAID 10** then press <Enter> to display the following.

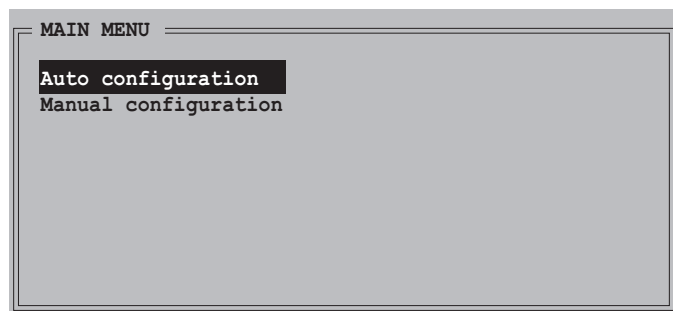

3. Select your desired method of configuration.  
**Auto configuration**
  - a. Select Auto Configuration then press <Enter>.
  - b. The utility prompts a message to input the RAID size, use the up or down arrow keys to set the RAID size then press <Enter>.
  - c. Press <Y> to confirm or <N> to return to the Main Menu.



Auto-configuration creates a RAID 10 set without a backup copy of the current source disk data.

### Manual configuration

- a. Select **Manual configuration** and press <Enter>. The following pop-up menu appears.
- b. Use the up or down arrow keys to select a chunk size appropriate to your drive usage then press <Enter>.

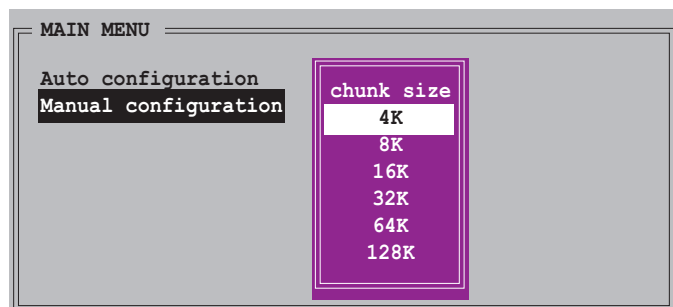



**TIP:** For server systems, use of a lower array block size is recommended. For multimedia computer systems used mainly for audio and video editing, a higher array block size is recommended for optimum performance.

- c. The selection bar moves to the Physical Drive menu. Using the up or down arrow keys, select a drive then press <Enter> to set the first drive of the RAID set.

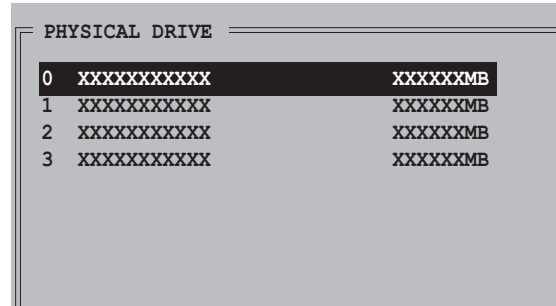

- d. Repeat step c to set the second, third, and fourth drive. The number of available drives depend on the installed and enabled physical drives in the system.
- e. After setting the RAID drives, the following pop-up menu appears.

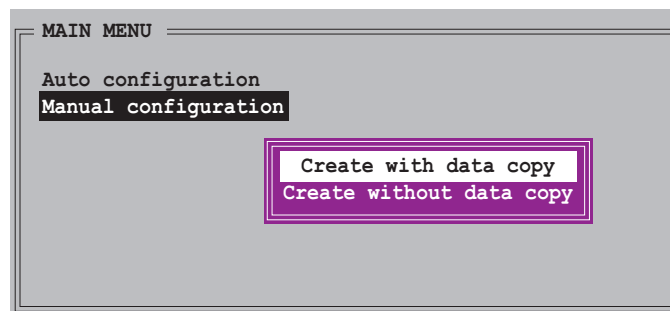

- The **Create with data copy** option allows you to copy the current data from the source drive to the mirror drive. The **Create without data copy** option disables the disk copy function of the Mirrored set.
- If you selected **Create without data copy**, the RAID 1 set must be repartitioned and reformatted to guarantee the consistency of its contents.
- Select **Create with data copy** if you have important data in your source drive.

- f. If you selected **Create with data copy**, the following pop-up menu appears.

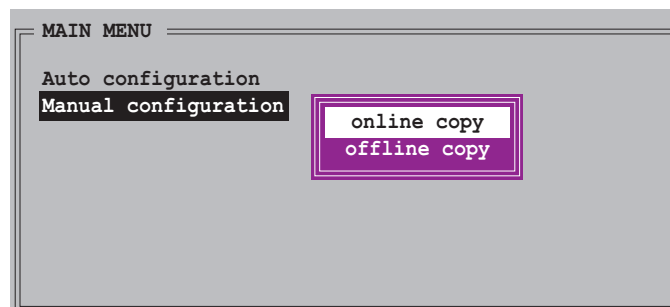



---

The **online copy** option automatically copies the data to the target drives on the background while writing to the source drives. The **offline copy** option allows you to copy the contents of the source drive to the target drives now.

---

- g. Use the up or down arrow keys to select desired copy method, then press <Enter>.
- h. The utility prompts a message to input the RAID size, use the up or down arrow keys to set the RAID size then press <Enter>.
- i. Press <Y> to confirm or <N> to return to the Main Menu. A copy progress appears if you previously selected offline copy.



- 
- You can also create a RAID set using the SATARAID5 GUI utility under a Windows® environment.
  - For details on the Silicon Image SATAraid™ RAID 5 configuration, refer to the “Sil3114 User’s Manual” found in your motherboard support CD.
-

## 5.5 Creating a RAID driver disk

A floppy disk with the RAID driver is required when installing Windows® 2000/XP operating system. You can create a RAID driver disk using your motherboard support CD.

To create a RAID driver disk:

1. Insert the motherboard support CD into the CD-ROM drive.
2. Insert a clean floppy disk into the floppy disk drive.
3. To create an NVIDIA® RAID driver disk, click **Make an Nvidia Chipset Driver Disk** item from the **Drivers** menu.

To create a Silicon Image SATAraid™ RAID driver disk, click **Make Silicon SATA/RAID Driver Disk** item from the **Drivers** menu.



---

Refer to section “5.2.2 Drivers menu” for details.

---

4. Follow succeeding screen information to complete process.
5. Write-protect the floppy disk to avoid computer virus infection.

To install the RAID driver:

1. During the OS installation, the system prompts you to press the **F 6** key to install third-party SCSI or RAID driver.
2. Press <F6> then insert the floppy disk with RAID driver into the floppy disk drive.
3. Follow the succeeding screen instructions to complete the installation.



---

For additional information on RAID installation and configuration, refer to the Manuals menu of the support CD.

---