

K8N

User Guide



Motherboard

E1868

Revised Edition V2

January 2005

Copyright © 2005 ASUSTeK COMPUTER INC. All Rights Reserved.

No part of this manual, including the products and software described in it, may be reproduced, transmitted, transcribed, stored in a retrieval system, or translated into any language in any form or by any means, except documentation kept by the purchaser for backup purposes, without the express written permission of ASUSTeK COMPUTER INC. ("ASUS").

Product warranty or service will not be extended if: (1) the product is repaired, modified or altered, unless such repair, modification or alteration is authorized in writing by ASUS; or (2) the serial number of the product is defaced or missing.

ASUS PROVIDES THIS MANUAL "AS IS" WITHOUT WARRANTY OF ANY KIND, EITHER EXPRESS OR IMPLIED, INCLUDING BUT NOT LIMITED TO THE IMPLIED WARRANTIES OR CONDITIONS OF MERCHANTABILITY OR FITNESS FOR A PARTICULAR PURPOSE. IN NO EVENT SHALL ASUS, ITS DIRECTORS, OFFICERS, EMPLOYEES OR AGENTS BE LIABLE FOR ANY INDIRECT, SPECIAL, INCIDENTAL, OR CONSEQUENTIAL DAMAGES (INCLUDING DAMAGES FOR LOSS OF PROFITS, LOSS OF BUSINESS, LOSS OF USE OR DATA, INTERRUPTION OF BUSINESS AND THE LIKE), EVEN IF ASUS HAS BEEN ADVISED OF THE POSSIBILITY OF SUCH DAMAGES ARISING FROM ANY DEFECT OR ERROR IN THIS MANUAL OR PRODUCT.

SPECIFICATIONS AND INFORMATION CONTAINED IN THIS MANUAL ARE FURNISHED FOR INFORMATIONAL USE ONLY, AND ARE SUBJECT TO CHANGE AT ANY TIME WITHOUT NOTICE, AND SHOULD NOT BE CONSTRUED AS A COMMITMENT BY ASUS. ASUS ASSUMES NO RESPONSIBILITY OR LIABILITY FOR ANY ERRORS OR INACCURACIES THAT MAY APPEAR IN THIS MANUAL, INCLUDING THE PRODUCTS AND SOFTWARE DESCRIBED IN IT.

Products and corporate names appearing in this manual may or may not be registered trademarks or copyrights of their respective companies, and are used only for identification or explanation and to the owners' benefit, without intent to infringe.

Contents

Notices	vi
Safety information	vii
About this guide	viii
Conventions used in this guide	viii
Typography	viii
K8N specifications summary	ix

Chapter 1: Product introduction

1.1 Welcome!	1-2
1.2 Package contents	1-2
1.3 Special features	1-3
1.3.1 Product Highlights	1-3
1.3.2 Unique ASUS features	1-4
1.4 Before you proceed	1-5
1.5 Motherboard overview	1-6
1.5.1 Motherboard layout	1-6
1.5.2 Placement direction	1-7
1.5.3 Screw holes	1-7
1.6 Central Processing Unit (CPU)	1-8
1.6.1 Overview	1-8
1.6.2 Installing the CPU	1-9
1.7 System memory	1-10
1.7.1 DIMM sockets location	1-10
1.7.2 Memory configurations	1-10
1.7.3 Installing a DIMM	1-12
1.8 Expansion slots	1-12
1.8.1 Standard interrupt assignments	1-12
1.8.2 IRQ assignments for this motherboard	1-13
1.8.3 PCI slots	1-13
1.8.4 AGP slot	1-14
1.9 Jumpers	1-15
1.10 Connectors	1-17
1.10.1 Rear panel connectors	1-17
1.10.2 Internal connectors	1-19

Contents

Chapter 2: BIOS Information

2.1	Managing and updating your BIOS	2-2
2.1.1	Creating a bootable floppy disk	2-2
2.1.2	Using AFUDOS to update the BIOS	2-3
2.1.3	Using AFUDOS to copy BIOS from PC	2-4
2.1.4	Using ASUS EZ Flash to update the BIOS	2-5
2.1.5	Recovering the BIOS with CrashFree BIOS 2	2-6
2.2	BIOS Setup program	2-8
2.2.1	BIOS menu screen	2-9
2.2.2	Menu bar	2-9
2.2.3	Navigation keys	2-9
2.2.4	Menu items	2-10
2.2.5	Sub-menu items	2-10
2.2.6	Configuration fields	2-10
2.2.7	Pop-up window	2-10
2.2.8	Scroll bar	2-10
2.2.9	General help	2-10
2.3	Main menu	2-11
2.3.1	System Time	2-11
2.3.2	System Date	2-11
2.3.3	Legacy Diskette A	2-11
2.3.4	Language	2-11
2.3.5	Primary and Secondary IDE Master/Slave	2-12
2.3.6	System Information	2-13
2.4	Advanced menu	2-14
2.4.1	Instant Music Configuration	2-14
2.4.2	JumperFree Configuration	2-15
2.4.3	CPU Configuration	2-16
2.4.4	Chipset	2-17
2.4.5	Onboard Devices Configuration	2-21
2.4.6	PCI PnP	2-22
2.5	Power menu	2-24
2.5.1	ACPI Suspend Mode	2-24
2.5.2	Repost Video on S3 Resume	2-24
2.5.3	ACPI 2.0 Support	2-24
2.5.4	ACPI APIC Support	2-24
2.5.5	APM Configuration	2-25
2.5.6	Hardware Monitor	2-26

Contents

2.6	Boot menu	2-28
2.6.1	Boot Device Priority	2-28
2.6.2	Hard Disk Drives	2-29
2.6.3	Boot Settings Configuration	2-29
2.6.4	Security	2-30
2.7	Exit menu	2-33

Chapter 3: Software support

3.1	Install an operating system	3-2
3.2	Support CD information	3-2
3.2.1	Running the support CD	3-2
3.2.2	Drivers menu	3-3
3.2.3	Utilities menu	3-4
3.2.4	Manual menu	3-5
3.2.5	ASUS Contact Information	3-6
3.3	ASUS Instant Music Lite	3-7
3.4	Cool 'n' Quiet!™ Technology	3-9

Notices

Federal Communications Commission Statement

This device complies with Part 15 of the FCC Rules. Operation is subject to the following two conditions:

- This device may not cause harmful interference, and
- This device must accept any interference received including interference that may cause undesired operation.



The use of shielded cables for connection of the monitor to the graphics card is required to assure compliance with FCC regulations. Changes or modifications to this unit not expressly approved by the party responsible for compliance could void the user's authority to operate this equipment.

Canadian Department of Communications Statement

This digital apparatus does not exceed the Class B limits for radio noise emissions from digital apparatus set out in the Radio Interference Regulations of the Canadian Department of Communications.

This class B digital apparatus complies with Canadian ICES-003.

Where to find more information

Refer to the following sources for additional information and for product and software updates.

1. **ASUS Websites**

The ASUS website provides updated information on ASUS hardware and software products. The ASUS websites are listed in the ASUS Contact Information on the inside front cover.

2. **Optional Documentation**

Your product package may include optional documentation, such as warranty flyers, that may have been added by your dealer. These documents are not part of the standard package.

Safety information

Electrical safety

- To prevent electrical shock hazard, disconnect the power cable from the electrical outlet before relocating the system.
- When adding or removing devices to or from the system, ensure that the power cables for the devices are unplugged before the signal cables are connected. If possible, disconnect all power cables from the existing system before you add a device.
- Before connecting or removing signal cables from the motherboard, ensure that all power cables are unplugged.
- Seek professional assistance before using an adapter or extension cord. These devices could interrupt the grounding circuit.
- Make sure that your power supply is set to the correct voltage in your area. If you are not sure about the voltage of the electrical outlet you are using, contact your local power company.
- If the power supply is broken, do not try to fix it by yourself. Contact a qualified service technician or your retailer.

Operation safety

- Before installing the motherboard and adding devices on it, carefully read all the manuals that came with the package.
- Before using the product, make sure all cables are correctly connected and the power cables are not damaged. If you detect any damage, contact your dealer immediately.
- To avoid short circuits, keep paper clips, screws, and staples away from connectors, slots, sockets and circuitry.
- Avoid dust, humidity, and temperature extremes. Do not place the product in any area where it may become wet.
- Place the product on a stable surface.
- If you encounter technical problems with the product, contact a qualified service technician or your retailer.

About this guide

Conventions used in this guide

To make sure that you perform certain tasks properly, take note of the following symbols used throughout this manual.



WARNING: Information to prevent injury to yourself when trying to complete a task.



CAUTION: Information to prevent damage to the components when trying to complete a task.



IMPORTANT: Information that you **MUST** follow to complete a task.



NOTE: Tips and additional information to aid in completing a task.

Typography

Bold text	Indicates a menu or an item to select.
<i>Italics</i>	Used to emphasize a word or a phrase.
<Key>	Keys enclosed in the less-than and greater-than sign indicates that you must press the enclosed key. Example: <Enter> indicates that you must press the Enter or Return key.
<Multiple key names>	If you must press two or more keys simultaneously, the key names are linked with a plus sign (+). Example: <Ctrl+Alt+D>
Command	Means that you must enter the command exactly as shown then supply the appropriate values that appear in brackets. Example: At the DOS prompt, type the command line: afudos /i[filename] In this example, you must supply a filename for [filename]. afudos /iK8N.ROM

K8N specifications summary

CPU	Socket 754 for AMD Athlon™ 64 and AMD Sempron™ CPUs Supports AMD 64 architecture that enables simultaneous 32-bit and 64-bit computing Supports AMD Cool 'n' Quiet!™ Technology
Chipset	NVIDIA® nForce™ 3 250
System Bus	800 MHz
Memory	3 x 184-pin DDR DIMM sockets for up to 3GB unbuffered ECC and non-ECC PC3200/PC2700/PC2100/PC1600 SDRAM memory
Expansion slots	1 x AGP 8X/4X 5 x PCI
Storage	NVIDIA® nForce™ 3 250 supports: - 2 x Ultra ATA 133 connector - 2 x Serial ATA connectors - RAID 0, RAID 1, RAID 0+1 and JBOD sets
LAN	IC Plus IP101 10/100 LAN PHY
AI Audio	Realtek® ALC850 8-channel CODEC Audio Sensing and Enumeration Technology Coaxial and Optical S/PDIF out support
AI BIOS	ASUS CrashFree BIOS 2
AI Overclocking	CPU, Memory and AGP voltage adjustable SFS (Stepless Frequency Selection) from 200 MHz up to 300 MHz at 1 MHz increment Adjustable FSB/DDR ratio. Fixed AGP/PCI frequencies ASUS JumperFree ASUS C.P.R. (CPU Parameter Recall)
USB	Maximum of eight USB 2.0 ports
Special features	ASUS MyLogo2™ ASUS Instant Music Lite ASUS EZ Flash Multi-Language BIOS
Back Panel I/O	1 x Parallel port 1 x Serial port 1 x PS/2 keyboard port 1 x PS/2 mouse port 4 x USB 2.0 ports 1 x RJ-45 port 1 x 8-channel audio I/O ports 1 x Optical S/PDIF Out port 1 x Coaxial S/PDIF Out port

(continued on the next page)

K8N specifications summary

Internal I/O	2 x USB 2.0 connector for 4 additional USB ports CPU/Chassis/Power fan connectors 20-pin/4-pin ATX 12V power connectors Chassis intrusion connector CD/AUX connectors GAME/MIDI connector Front Panel connector
BIOS features	4Mb Flash EEPROM AMI BIOS, PnP, DMI2.0, WfM2.0, Multi-Language BIOS, SM BIOS 2.3, ASUS EZ Flash, ASUS MyLogo2, ASUS CrashFree BIOS 2
Industry standard	PCI 2.2, USB 2.0
Manageability	WfM2.0, DMI 2.0, WOL by PME, WOR by PME, Chassis intrusion
Power Requirement	ATX power supply (with 4-pin 12V plug)
Form Factor	ATX form factor: 12 in x 9.6 in (30.5 cm x 24.4 cm)
Support CD contents	Device drivers ASUS PC Probe ASUS Live Update utility Anti-virus utility

* Specifications are subject to change without notice.

Chapter 1

This chapter describes the features of the motherboard. It includes brief descriptions of the motherboard components, and illustrations of the layout, jumper settings, and connectors.

Product introduction

1.1 Welcome!

Thank you for buying the ASUS® K8N motherboard!

The motherboard delivers a host of new features and latest technologies making it another standout in the long line of ASUS quality motherboards!

The motherboard combines the powers of the AMD Athlon™ 64 or AMD Sempron™ processor with the NVIDIA® nForce3 250 chipset to set a new benchmark for an effective desktop platform solution.

Supporting up to 3GB of system memory with PC3200/PC2700/PC2100/PC1600 DDR SDRAM, high-resolution graphics via an AGP 8X slot, Serial ATA RAID, USB 2.0, and 8-channel audio features, the motherboard takes you ahead in the world of power computing!

Before you start installing the motherboard, and hardware devices on it, check the items in your package with the list below.

1.2 Package contents

Check your motherboard package for the following items.

- ✓ ASUS K8N motherboard
- ✓ ASUS motherboard support CD
- ✓ 1 x Ultra DMA 133/100/66 cables
- ✓ 2 x Serial ATA cables
- ✓ 1 x Floppy disk cable
- ✓ I/O shield
- ✓ Bag of extra jumper caps
- ✓ User guide



If any of the above items is damaged or missing, contact your retailer.

1.3 Special features

1.3.1 Product Highlights

Latest processor technology



The motherboard supports the AMD Athlon™ 64 and AMD Sempron™ desktop processors. The AMD Athlon™ 64 is based on AMD's 64-bit architecture, which represents the landmark introduction of the industry's first x86-64 technology. This processor provides a dramatic leap forward in compatibility, performance, investment protection, and reduced total cost of ownership and development.

The AMD Sempron™ is a 32-bit processor that provides the performance needs of value-conscious buyers. This processor is designed to deliver best-in-class performance for everyday computing.

HyperTransport™ Technology



HyperTransport™ Technology is a high-speed, low latency, point-to-point link designed to increase the communication speed between integrated circuits in computers, networking and telecommunications equipment up to 48 times faster than other existing technologies.

Cool 'n' Quiet!™ Technology

The motherboard supports the AMD® Cool 'n' Quiet!™ Technology that dynamically and automatically changes the CPU speed, voltage and amount of power depending on the task the CPU performs.

Serial ATA solution



The motherboard supports two interfaces compliant to the Serial ATA (SATA) specification, an evolutionary replacement of the Parallel ATA storage interface. The Serial ATA specification allows for thinner, more flexible cables with lower pin count, reduced voltage requirement, up to 150 MB/s data transfer rate.

Serial ATA RAID solution

The motherboard provides an onboard high-performance Serial ATA RAID controller that enhance hard disk performance and data backup protection without the cost of additional RAID cards.

AI Audio technology



The motherboard supports 8-channel audio through the onboard ALC850 CODEC with 16-bit DAC, a stereo 16-bit ADC, and an AC97 2.3 compatible multi-channel audio designed for PC multimedia systems. It also features intelligent detection of plugged peripherals into the audio ports and identifies any incompatible devices.

AGP 8X support



AGP 8X (AGP 3.0) is the VGA interface specification that enables enhanced graphics performance with maximum bandwidth speeds of up to 2.12 GB/s.

S/PDIF out

The motherboard's S/PDIF out function turns your computer into a high-end entertainment system with digital connectivity to powerful speaker systems.

USB 2.0 technology



The motherboard implements the new Universal Serial Bus (USB) 2.0 specification, extending the connection speed from 12 Mbps on USB 1.1 to a fast 480 Mbps on USB 2.0 - supporting up to eight USB 2.0 ports. The higher bandwidth of USB 2.0 allows connection of devices such as high resolution video conferencing cameras, next generation scanners and printers, and fast storage units. USB 2.0 is backward compatible with USB 1.1.

1.3.2 Unique ASUS features

CrashFree BIOS 2

This feature allows you to restore the original BIOS data from the ASUS support CD in case when the BIOS codes and data are corrupted. This protection eliminates the need to buy a replacement ROM chip. See page 2-6.

C.P.R. (CPU Parameter Recall)

The C.P.R. feature of the motherboard BIOS allows automatic re-setting to the BIOS default settings in case the system hangs due to overclocking. When the system hangs due to overclocking, C.P.R. eliminates the need to open the system chassis and clear the RTC data. Simply shut down and reboot the system, and BIOS automatically restores the CPU previous setting for each parameter.

ASUS MyLogo2™

This new feature present in the motherboard allows you to personalize and add style to your system with customizable boot logos. See pages 2-31.

ASUS EZ Flash BIOS

With the ASUS EZ Flash, you can easily update the system BIOS even before loading the operating system. No need to use a DOS-based utility or boot from a floppy disk. See page 2-5.

Instant Music Lite

This unique feature allows you to playback audio CDs even without booting the system to Windows®. Just press the ASUS Instant Music special function keys and enjoy the music! See details on pages 2-25 and 3-5.

ASUS Multi-language BIOS

The multi-language BIOS allows you to select the language of your choice from the available options. The localized BIOS menus allow you to configure easier and faster. See details on page 2-11.

1.4 Before you proceed

Take note of the following precautions before you install motherboard components or change any motherboard settings.



1. Unplug the power cord from the wall socket before touching any component.
2. Use a grounded wrist strap or touch a safely grounded object or to a metal object, such as the power supply case, before handling components to avoid damaging them due to static electricity.
3. Hold components by the edges to avoid touching the ICs on them.
4. Whenever you uninstall any component, place it on a grounded antistatic pad or in the bag that came with the component.
5. Before you install or remove any component, ensure that the ATX power supply is switched off or the power cord is detached from the power supply. Failure to do so may cause severe damage to the motherboard, peripherals, and/or components.

Onboard LED

The motherboard comes with a stand-by power LED. When lit, this green LED indicates that the system is ON, in sleep mode, or in soft-off mode, a reminder that you should shut down the system and unplug the power cable before removing or plugging in any motherboard component. The illustration below shows the location of the onboard LED.

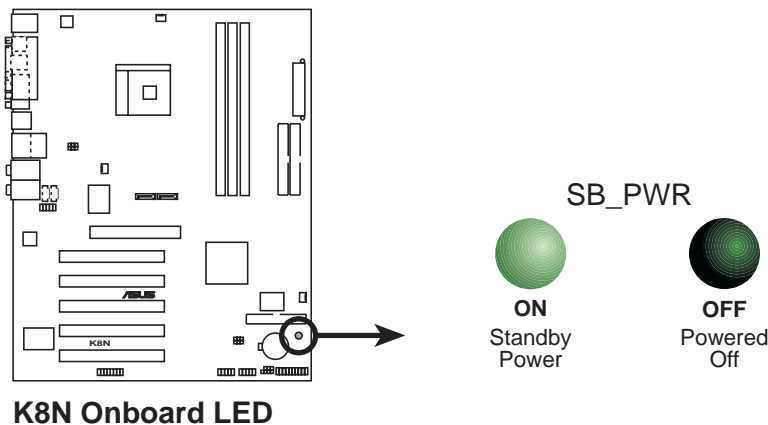

1.5 Motherboard overview

1.5.1 Motherboard layout

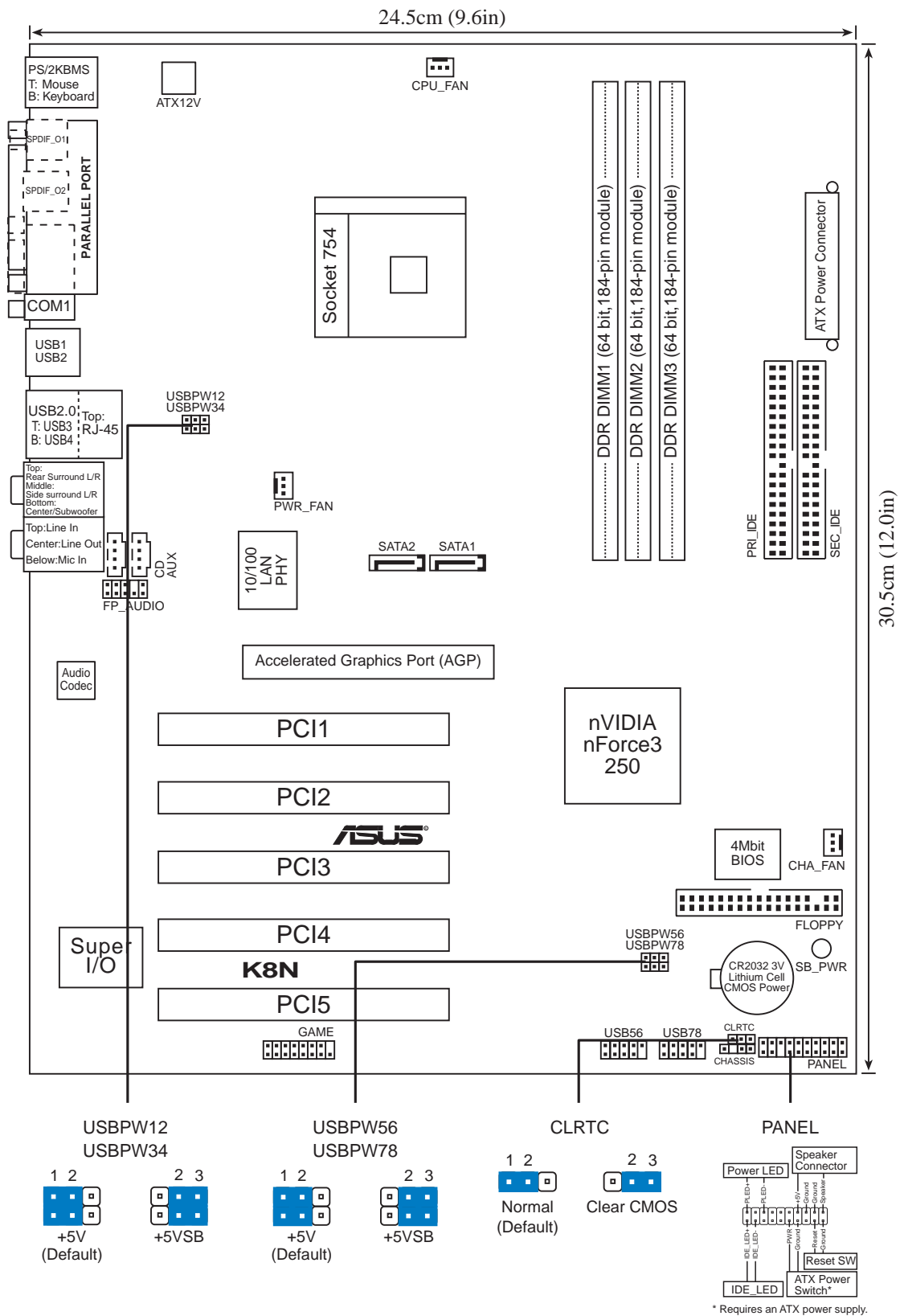

1.5.2 Placement direction

When installing the motherboard, make sure that you place it into the chassis in the correct orientation. The edge with external ports goes to the rear part of the chassis as indicated in the image below.

1.5.3 Screw holes

Place nine (9) screws into the holes indicated by circles to secure the motherboard to the chassis.



Do not overtighten the screws! Doing so may damage the motherboard.

Place this side towards the rear of the chassis

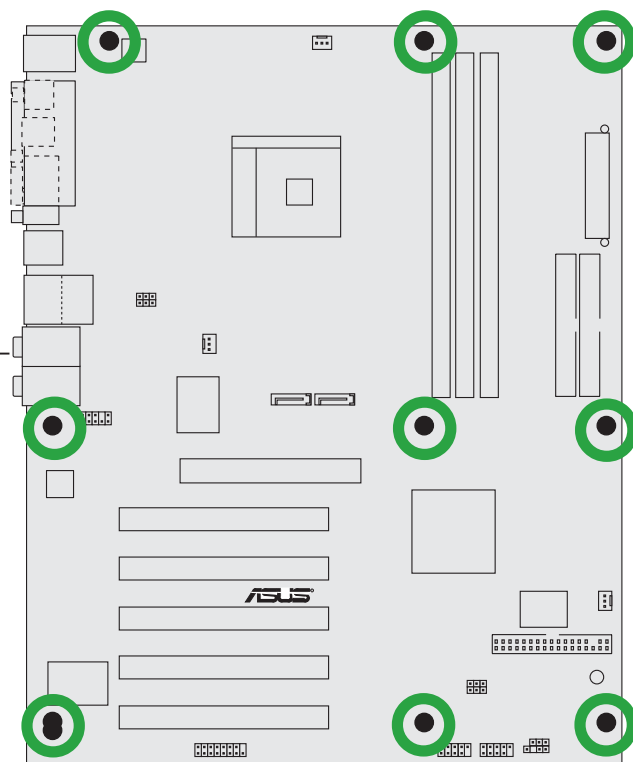

1.6 Central Processing Unit (CPU)

1.6.1 Overview

The motherboard comes with a surface mount 754-pin Zero Insertion Force (ZIF) socket designed for the AMD Athlon™ 64 and AMD Sempron™ processors.

The 128-bit-wide data paths of these processors can run applications faster than processors with only 32-bit or 64-bit wide data paths.

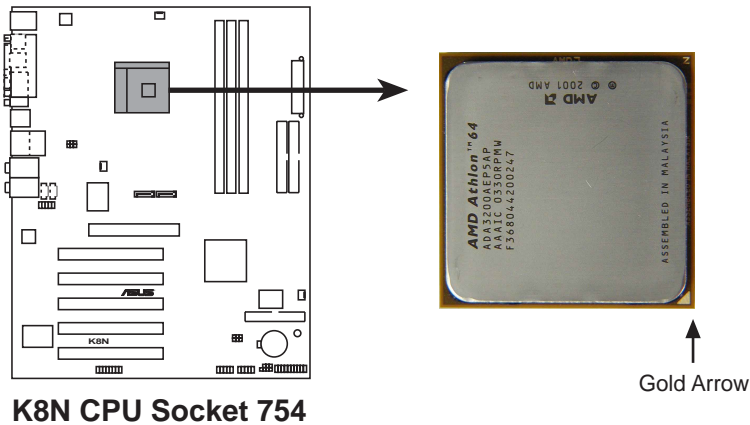

Incorrect installation of the CPU into the socket may bend the pins and severely damage the CPU!

1.6.2 Installing the CPU

Follow these steps to install a CPU.

1. Locate the 754-pin ZIF socket on the motherboard.
2. Unlock the socket by pressing the lever sideways, then lift it up to a 90°-100° angle.

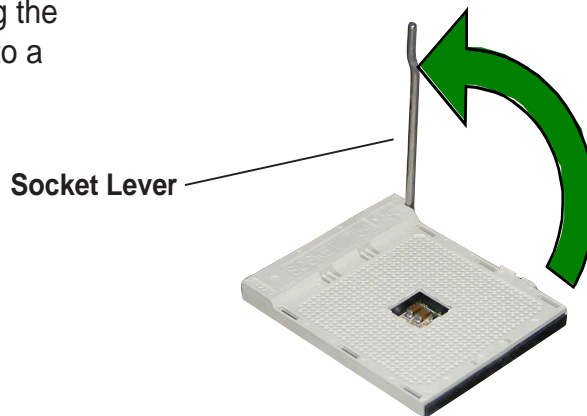

Make sure that the socket lever is lifted up to 90°-100° angle, otherwise the CPU does not fit in completely.

3. Position the CPU above the socket such that the CPU corner with the gold triangle matches the socket corner with a small triangle.
4. Carefully insert the CPU into the socket until it fits in place.

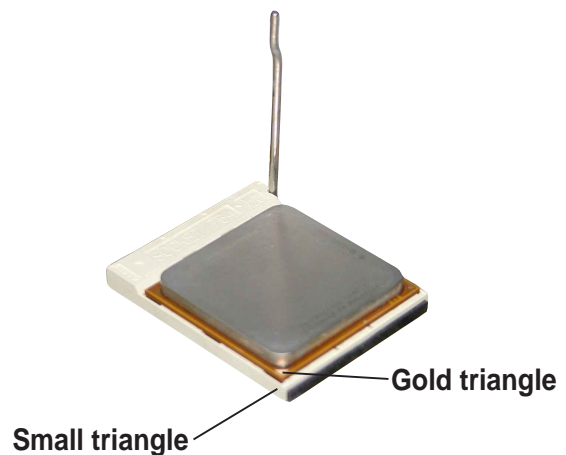

The CPU fits only in one correct orientation. DO NOT force the CPU into the socket to prevent bending the pins and damaging the CPU!

5. When the CPU is in place, push down the socket lever to secure the CPU. The lever clicks on the side tab to indicate that it is locked.
6. Install specifically designed heatsink and fan assembly.

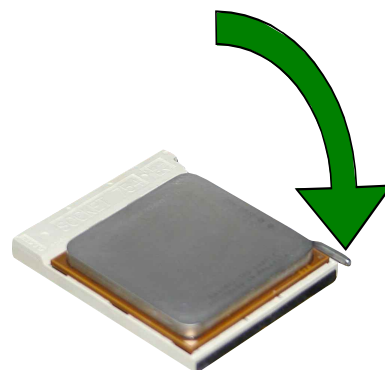

1.7 System memory

1.7.1 DIMM sockets location

The following figure illustrates the location of the DDR DIMM sockets.

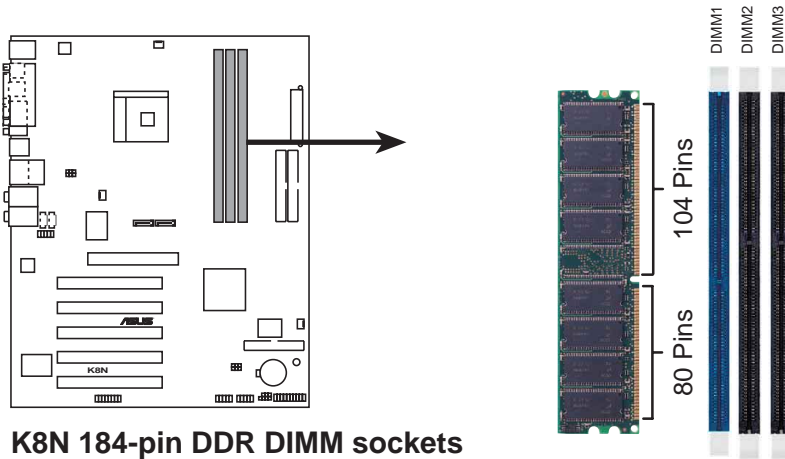

Make sure to unplug the power supply before adding or removing DIMMs or other system components. Failure to do so may cause severe damage to both the motherboard and the components.

1.7.2 Memory configurations

You may install 64MB, 128MB, 256MB, 512MB, and 1GB DDR DIMMs into the DIMM sockets using the memory configurations in this section.

Important notes



- Installing DDR DIMMs other than the given memory configurations may cause memory sizing error or system boot failure. Use any of the memory configurations in Table 1.
- For optimum compatibility, obtain memory modules from qualified vendors. See Qualified Vendors List on page 1-11.
- Use the blue DIMM slot first.
- Stacked RAM and DDR DIMM modules with more than 18 chips are not supported.
- Always install DIMMs with the same CAS Latency. For optimum compatibility, obtain memory modules from the same vendors. See Qualified Vendors List on page 1-11.



Obtain DDR DIMMs only from ASUS qualified vendors for better system performance. Visit the ASUS website (www.asus.com) for the latest DDR 400 Qualified Vendor List for this motherboard.

Table 1 Memory configurations

Number of DIMMs	DIMM Slot			Max Speed
	DIMM1	DIMM2	DIMM3	
1	Single Side	-	-	DDR 400
1	-	Single Side	-	DDR 400
1	-	-	Single Side	DDR 400
1	Double Side	-	-	DDR 400
1	-	Double Side	-	DDR 400
1	-	-	Double Side	DDR 400
2	Single Side	Single Side	-	DDR 400
2	Single Side	Double Side	-	DDR 400
2	Single Side	-	Single Side	DDR 400
2	Single Side	-	Double Side	DDR 400
2	Double Side	Single Side	-	DDR 400
2	Double Side	Double Side	-	DDR 400
2	Double Side	-	Single Side	DDR 400
2	-	Single Side	Single Side	DDR 333
2	-	Single Side	Double Side	DDR 200
2	-	Double Side	Single Side	DDR 200
2	-	Double Side	Double Side	DDR 200
2	Double Side	-	Double Side	DDR 400
3	Single Side	Single Side	Single Side	DDR 333
3	Single Side	Single Side	Double Side	DDR 200
3	Single Side	Double Side	Single Side	DDR 200
3	Single Side	Double Side	Double Side	DDR 200
3	Double Side	Single Side	Single Side	DDR 333
3	Double Side	Single Side	Double Side	DDR 200
3	Double Side	Double Side	Single Side	DDR 200
3	Double Side	Double Side	Double Side	DDR 200

DDR Qualified Vendors List

The following table lists the PC3200 (DDR400) memory modules that have been tested and qualified for use with this motherboard. Visit the ASUS website (www.asus.com) for the latest DDR 400 QVL for this motherboard.

DIMM Vendor	Chip Number	Chip Brand	SS/DS	Module Part Number	Size
KINGSTON	HY5DU56822BT-D43	Hynix	SS	KVR400X64C3A/256	256MB
KINGSTON	HY5DU56822BT-D43	Hynix	DS	KVR400X64C3A/512	512MB
KINGSTON	V58C2256804SAT5(ECC)	Mosel	SS	KVR400X72C3A/256	256MB
KINGSTON	V58C2256804SAT5(ECC)	Mosel	DS	KVR400X72C3A/512	512MB
KINGSTON	HYB25D256800BT-5B	Infineon	SS	KVR400X64C3A/256	256MB
KINGSTON	HYB25D256809BT-5B	Infineon	DS	KVR400X64C3A/512	512MB
KINGSTON	D3208DL2T-5	KINGSTON	SS	KVR400X64C3A/256	256MB
KINGSTON	D328DIB-50	KINGSTON	DS	KVR400X64C3A/512	512MB
KINGSTON	Heat-Sink Package	N/A	DS	KHX3200A/512	512MB
SAMSUNG	K4H560838E-TCCC(ECC)	SAMSUNG	SS	M381L3223ETM-CCC	256MB
SAMSUNG	K4H560838E-TCCC(ECC)	SAMSUNG	DS	M381L6423ETM-CCC	512MB
SAMSUNG	K4H560838E-TCCC	SAMSUNG	SS	M368L3223ETM-CCC	256MB
SAMSUNG	K4H560838E-TCCC	SAMSUNG	DS	M368L6423ETM-CCC	512MB
SAMSUNG	K4H560838F-TCCC	SAMSUNG	SS	M368L3223FTN-CCC	256MB
SAMSUNG	K4H560838F-TCCC	SAMSUNG	DS	M368L6423FTN-CCC	256MB
Hynix	HY5DU56822BT-D43	Hynix	SS	HYMD232646B8J-D43 AA	256MB
Hynix	HY5DU56822BT-D43	Hynix	DS	HYMD264646B8J-D43 AA	512MB
MICRON	MT46V32M8TG-5BC	MICRON	SS	MT8VDDT3264AG-40BCB	256MB
MICRON	MT46V32M8TG-5BC	MICRON	DS	MT16VDDT6464AG-40BCB	512MB
Infineon	HYB25D256800BT-5B	Infineon	SS	HYS64D32300GU-5-B	256MB
Infineon	HYB25D256800BT-5B	Infineon	DS	HYS64D64320GU-5-B	512MB
Infineon	HYB25D256800CE-5C	Infineon	SS	HYS64D32300HU-5-C	256MB
Infineon	HYB25D256800CE-5C	Infineon	DS	HYS64D64320HU-5-C	512MB
CORSAIR	W942508BH-5	Winbond	SS	CMX256A-3200C2PT	256MB
CORSAIR	Heat-Sink Package	Winbond	DS	CMX512-3200C2	512MB

Legend: SS - Single-Sided DIMMs

DS - Double-Sided DIMMs

1.7.3 Installing a DIMM

Follow these steps to install a DIMM.

1. Unlock a DIMM socket by pressing the retaining clips outward.
2. Align a DIMM on the socket such that the notch on the DIMM matches the break on the socket.
3. Firmly insert the DIMM into the socket until the retaining clips snap back in place and the DIMM is properly seated.

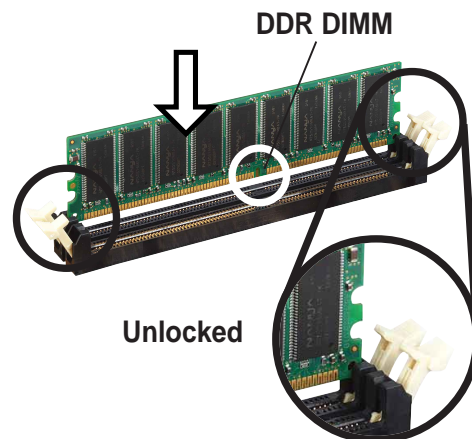

A DDR DIMM is keyed with a notch so that it fits in only one direction. DO NOT force a DIMM into a socket to avoid damaging the DIMM.

1.8 Expansion slots

To install and configure an expansion card:

1. Install an expansion card following the instructions that came with the chassis.
2. Turn on the system and change the necessary BIOS settings, if any. See Chapter 2 for BIOS information.
3. Assign an IRQ to the card. Refer to the tables next page.
4. Install the drivers and/or software applications for the expansion card according to the card documentation.

1.8.1 Standard interrupt assignments

IRQ	Priority	Standard Function
0	1	System Timer
1	2	Keyboard Controller
2	N/A	Programmable Interrupt
3*	11	IRQ holder for PCI steering
4*	12	Communications Port (COM1)
5*	13	IRQ holder for PCI steering
6	14	Floppy Disk Controller
7*	15	Printer Port (LPT1)
8	3	System CMOS/Real Time Clock
9*	4	IRQ holder for PCI steering
10*	5	IRQ holder for PCI steering
11*	6	IRQ holder for PCI steering
12*	7	PS/2 Compatible Mouse Port
13	8	Numeric Data Processor
14*	9	Primary IDE Channel
15*	10	Secondary IDE Channel

* These IRQs are usually available for ISA or PCI devices.

1.8.2 IRQ assignments for this motherboard

	INT A	INT B	INT C	INT D	INT E
PCI slot 1	shared	—	—	—	—
PCI slot 2	—	shared	—	—	—
PCI slot 3	—	—	shared	—	—
PCI slot 4	—	—	—	used	—
PCI slot 5	shared	—	—	—	—
Serial ATA	—	—	shared	—	—
AGP slot	—	—	—	—	used



When using PCI cards on shared slots, ensure that the drivers support “Share IRQ” or that the cards do not need IRQ assignments. Otherwise, conflicts will arise between the two PCI groups, making the system unstable and the card inoperable.

1.8.3 PCI slots

The PCI slots support PCI cards such as a LAN card, SCSI card, USB card, and other cards that comply with PCI specifications.

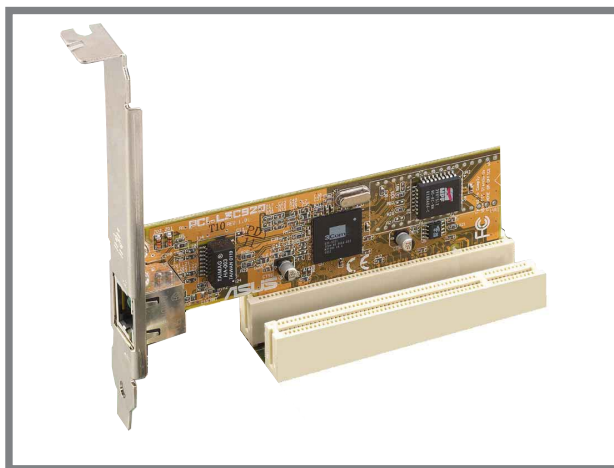

1.8.4 AGP slot

The Accelerated Graphics Port (AGP) slot supports AGP 8X/4X (+1.5V) cards. When you buy an AGP card, make sure that you ask for one with +1.5V specification.

Note the notches on the card golden fingers to ensure that they fit the AGP slot on the motherboard.



Install only +1.5V AGP cards.

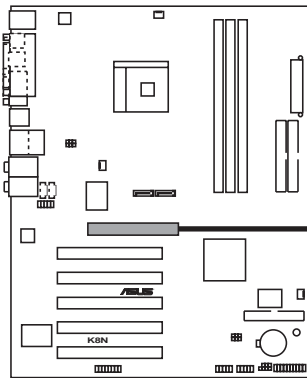

K8N Accelerated Graphics Port (AGP)

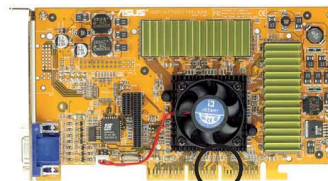

Keyed for 1.5v



If installing the ATi 9500 or 9700 Pro Series VGA cards, use only the card version **PN xxx-xxxx-30** or later, for optimum performance and overclocking stability.

1.9 Jumpers

1. Clear RTC RAM (CLRTC)

This jumper allows you to clear the Real Time Clock (RTC) RAM in CMOS. You can clear the CMOS memory of date, time, and system setup parameters by erasing the CMOS RTC RAM data. The RAM data in CMOS, that include system setup information such as system passwords, is powered by the onboard button cell battery.

To erase the RTC RAM:

1. Turn OFF the computer and unplug the power cord.
2. Move the jumper cap from pins 1-2 (default) to pins 2-3. Keep the cap on pins 2-3 for about 5~10 seconds, then move the cap back to pins 1-2.
3. Plug the power cord and turn ON the computer.
4. Hold down the **** key during the boot process and enter BIOS setup to re-enter data.



Except when clearing the RTC RAM, never remove the cap on the jumper default position. Removing the cap will cause system boot failure!

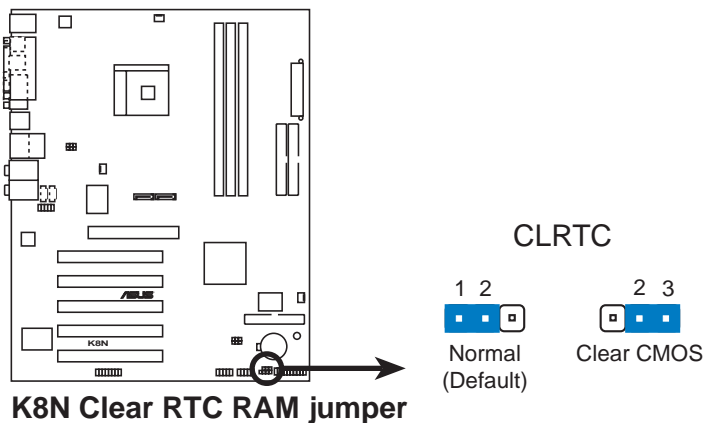

You do not need to clear the RTC when the system hangs due to overclocking. For system failure due to overclocking, use the C.P.R. (CPU Parameter Recall) feature. Shut down and reboot the system so BIOS can automatically reset parameter settings to its previous values.

2. USB device wake-up (3-pin USBPW12, USBPW34, USBPW56, USBPW78)

Set these jumpers to +5V to wake up the computer from S1 sleep mode (CPU stopped, DRAM refreshed, system running in low power mode) using the connected USB devices. Set to +5VSB to wake up from S3 and S4 sleep modes (no power to CPU, DRAM in slow refresh, power supply in reduced power mode).

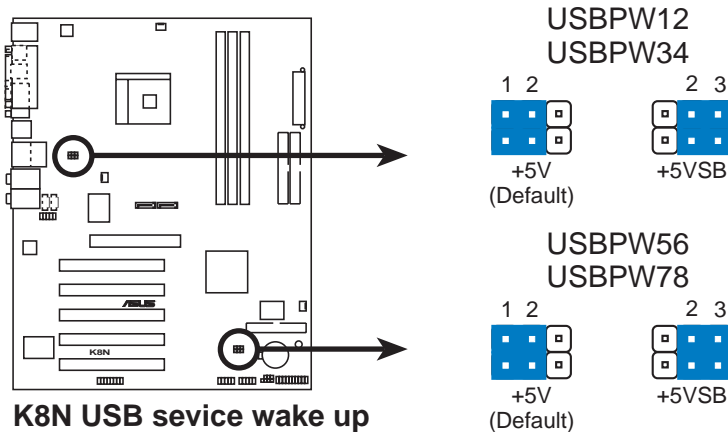

- The USB device wake-up feature requires a power supply that can provide 500mA on the +5VSB lead for each USB port. Otherwise, the system would not power up.
- The total current consumed must NOT exceed the power supply capability (+5VSB) whether under normal condition or in sleep mode.

1.10 Connectors

This section describes and illustrates the motherboard rear panel and internal connectors.

1.10.1 Rear panel connectors

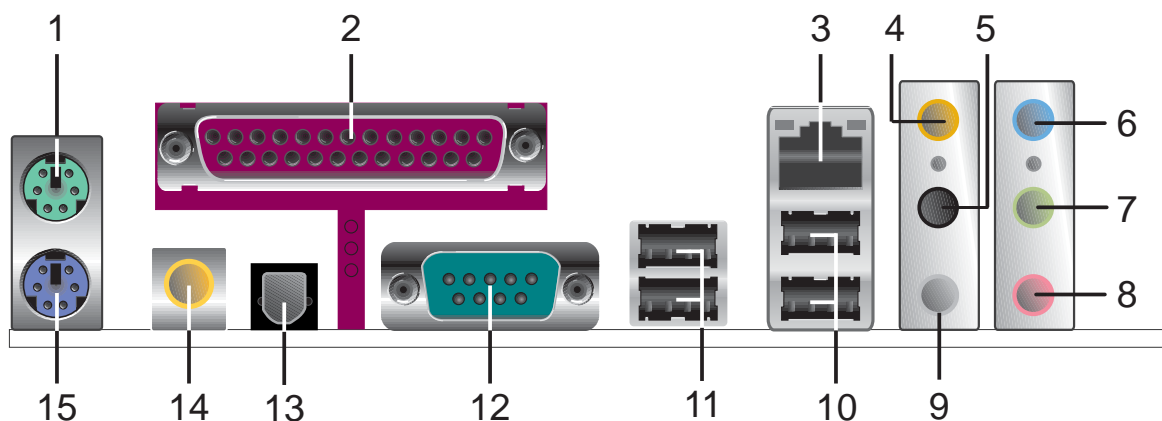

1. **PS/2 mouse port.** This green 6-pin connector is for a PS/2 mouse.
2. **Parallel port.** This 25-pin port connects a parallel printer, a scanner, or other devices.
3. **RJ-45 port.** This port allows 10/100 connection to a Local Area Network (LAN) through a network hub.

LAN port LED indications

100M LED		10M LED	
Status	Description	Status	Description
Yellow	Linked	Orange	Linked
Blinking	Data activity	Blinking	Data activity

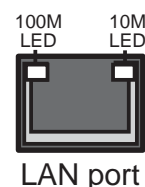

4. **Rear Speaker out port.** This Rear Speaker (gray) port connects to the rear speakers on a 4-channel, 6-channel or 8-channel audio configuration.
5. **Side Speaker out port.** This Side Speaker out (black) port connects to the side speakers in an 8-channel audio configuration.
6. **Line In port.** This Line In (light blue) port connects a tape player or other audio sources.
7. **Line Out port.** This Line Out (lime) port connects a headphone or a speaker. In 4-channel, 6-channel and 8-channel mode, the function of this jack becomes Front Speaker Out.
8. **Microphone port.** This Mic (pink) port connects a microphone.

9. **Center/Subwoofer port.** This Center/Subwoofer (yellow orange) port connects to the center/subwoofer speakers on a 6-channel or 8-channel audio configuration.

Audio 2, 4, 6, or 8-channel configuration

	Headset/ 2-channel	4-channel	6-channel	8-channel
Light Blue	Line In	Line In	Line In	Line In
Lime	Line Out	Front Speaker Out	Front Speaker Out	Front Speaker Out
Pink	Mic In	Mic In	Mic In	Mic In
Gray	-	Rear Speaker Out	Rear Speaker Out	Rear Speaker Out
Black	-	-	-	Side Speaker Out
Orange	-	-	Center/Subwoofer	Center/Subwoofer

10. **USB 2.0 ports 3 and 4.** These two 4-pin Universal Serial Bus (USB) ports are available for connecting USB 2.0 devices.
11. **USB 2.0 ports 1 and 2.** These two 4-pin Universal Serial Bus (USB) ports are available for connecting USB 2.0 devices.
12. **Serial connector.** This 9-pin COM1 port is for serial devices.
13. **S/PDIF optical out port.** This port connects to external audio output devices with optical cable connectors.
14. **S/PDIF coaxial out port.** This port connects to external audio output devices with coaxial cable connectors.
15. **PS/2 keyboard port.** This purple connector is for a PS/2 keyboard.

1.10.2 Internal connectors

1. IDE connectors (40-1 pin PRI_IDE, SEC_IDE)

This connector supports the provided UltraATA133 IDE hard disk ribbon cable. Connect the cable's blue connector to the primary (recommended) or secondary IDE connector, then connect the gray connector to the UltraATA133 slave device (hard disk drive) and the black connector to the UltraATA133 master device.



- Follow the hard disk drive documentation when setting the device in master or slave mode.
- Pin 20 on each IDE connector is removed to match the covered hole on the UltraATA cable connector. This prevents incorrect orientation when you connect the cables.
- The hole near the blue connector on the UltraATA cable is intentional.

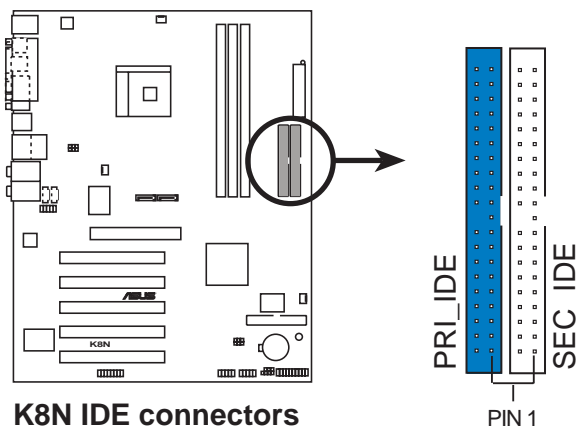

NOTE: Orient the red markings (usually zigzag) on the IDE ribbon cable to PIN 1.

2. Floppy disk drive connector (34-1 pin FLOPPY)

This connector supports the provided floppy drive ribbon cable. After connecting one end to the motherboard, connect the other end to the floppy drive. (Pin 5 is removed to prevent incorrect insertion when using ribbon cables with pin 5 plug).

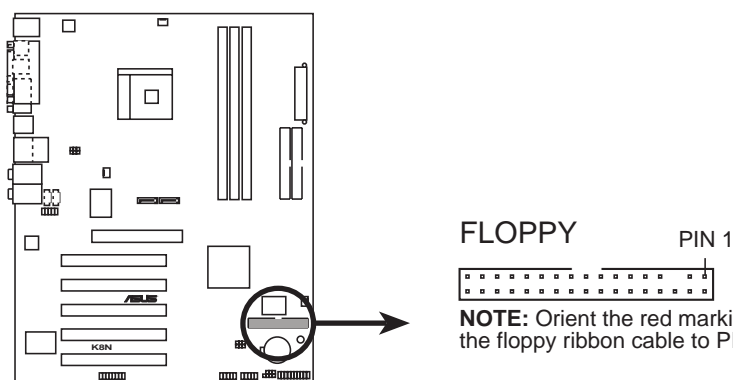

NOTE: Orient the red markings on the floppy ribbon cable to PIN 1.

K8N Floppy disk drive connector

3. ATX power connectors (20-pin ATXPWR, 4-pin ATX12V)

These connectors connect to an ATX 12V power supply. The plugs from the power supply are designed to fit these connectors in only one orientation. Find the proper orientation and push down firmly until the connectors completely fit.

In addition to the 20-pin ATX power connector, this motherboard requires that you connect the 4-pin ATX +12V power plug to provide sufficient power to the CPU.



Make sure that your ATX 12V power supply can provide 8A on the +12V lead and at least 1A on the +5-volt standby lead (+5VSB). The minimum recommended wattage is 300W or 350W for a fully configured system. The system may become unstable and may experience difficulty powering up if the power supply is inadequate.

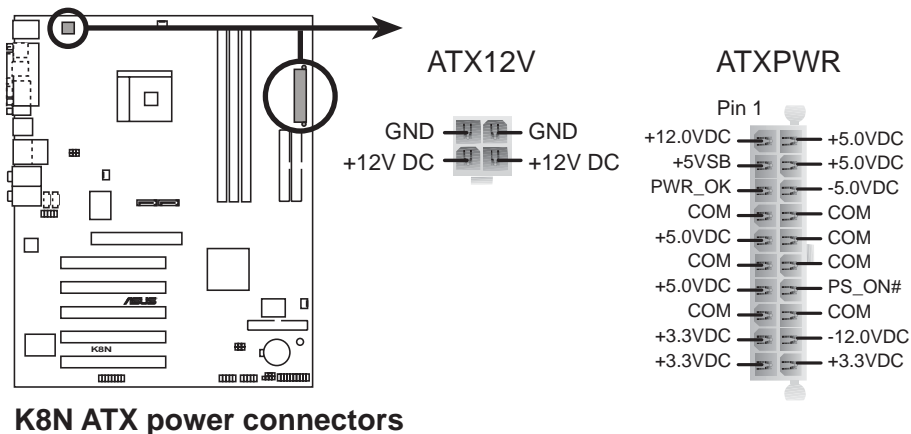

4. Internal audio connectors (4-pin CD, AUX)

These connectors allow you to receive stereo audio input from sound sources such as a CD-ROM, TV tuner, or MPEG card.

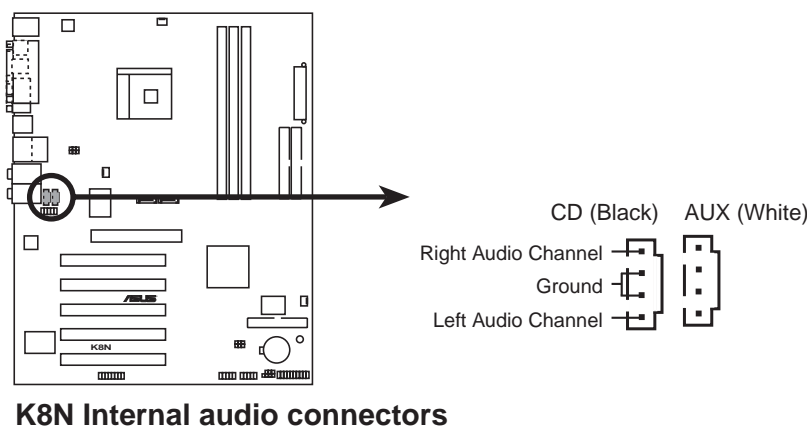

5. CPU and chassis fan connectors (3-pin CPU_FAN, CHA_FAN)

The fan connectors support cooling fans of 350mA~740mA (8.88W max.) or a total of 1A~2.22A (26.64W max.) at +12V. Connect the fan cables to the fan connectors on the motherboard, making sure that the black wire of each cable matches the ground pin of the connector.



Do not forget to connect the fan cables to the fan connectors. Lack of sufficient air flow within the system may damage the motherboard components. These are not jumpers! DO NOT place jumper caps on the fan connectors!

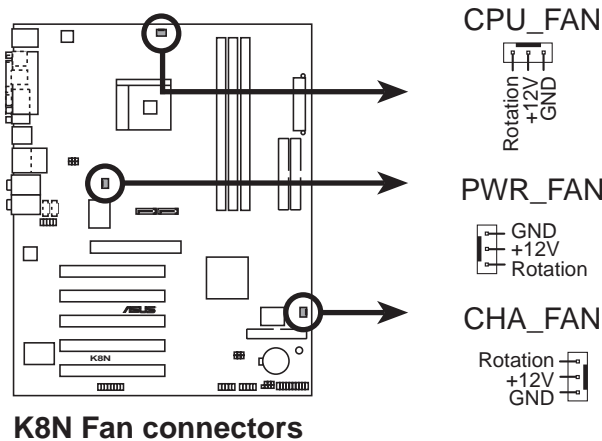

K8N Fan connectors

6. USB header (10-1 pin USB56, USB78)

If the USB ports on the rear panel are inadequate, a USB header is available for additional USB ports. Connect the USB cable of the USB 2.0 module to this header. You may install the USB module in the chassis front panel. The module has two USB 2.0 ports for connecting next generation USB peripherals such as high resolution cameras, scanners, and printers.

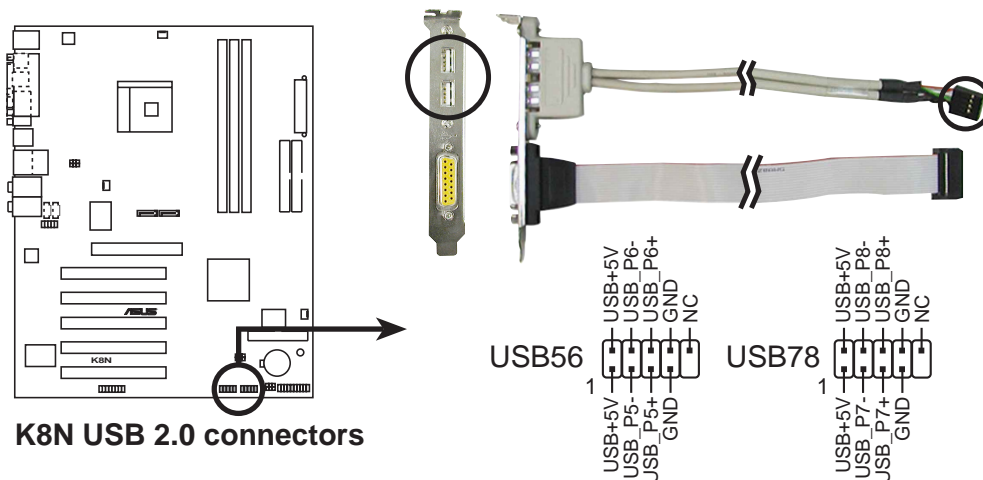

K8N USB 2.0 connectors



- The USB 2.0 module is purchased separately.
- Install the USB 2.0 driver before using the USB 2.0 feature.

7. Front panel audio connector (10-1 pin FP_AUDIO)

This is an interface for the front panel cable that allows convenient connection and control of audio devices.

By default, the pins labeled LINE OUT_R/BLINE_OUT_R and the pins LINE OUT_L/BLINE_OUT_L are shorted with jumper caps. Remove the caps only when you are connecting the front panel audio cable.

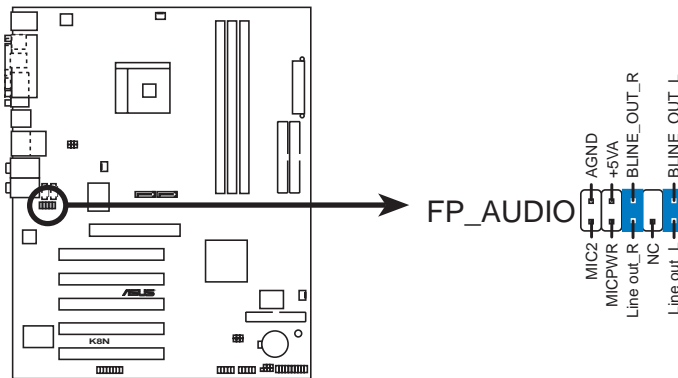

K8N Front panel audio connector

8. Chassis intrusion connector (4-1 pin CHASSIS)

This lead is for a chassis designed with intrusion detection feature. This requires an external detection mechanism such as a chassis intrusion sensor or microswitch. When you remove any chassis component, the sensor triggers and sends a high-level signal to this lead to record a chassis intrusion event.

By default, the pins labeled “Chassis Signal” and “Ground” are shorted with a jumper cap. If you wish to use the chassis intrusion detection feature, remove the jumper cap from the pins.

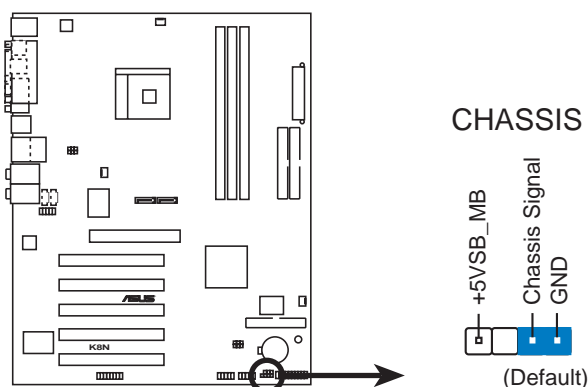

K8N Chassis intrusion connector

9. GAME/MIDI connector (16-1 pin GAME)

This connector supports a GAME/MIDI module. If a GAME/MIDI module is available, connect the GAME/MIDI cable to this connector. The GAME/MIDI port on the module connects a joystick or a game pad for playing games, and MIDI devices for playing or editing audio files.

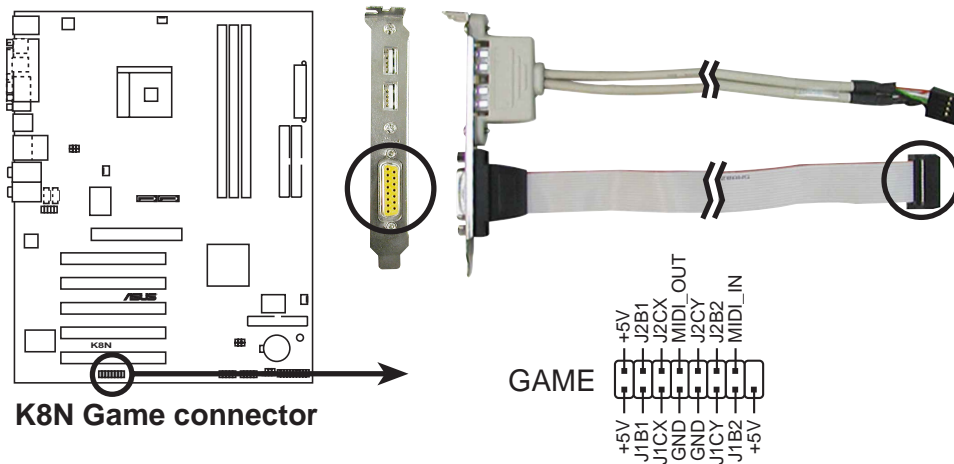

The GAME/MIDI module is purchased separately.

10. Serial ATA connectors (7-pin SATA1, SATA2)

These next generation connectors support the thin Serial ATA cables for primary internal storage devices. The current Serial ATA interface allows up to 150 MB/s data transfer rate, faster than the standard parallel ATA with 133MB/s (Ultra ATA/133).

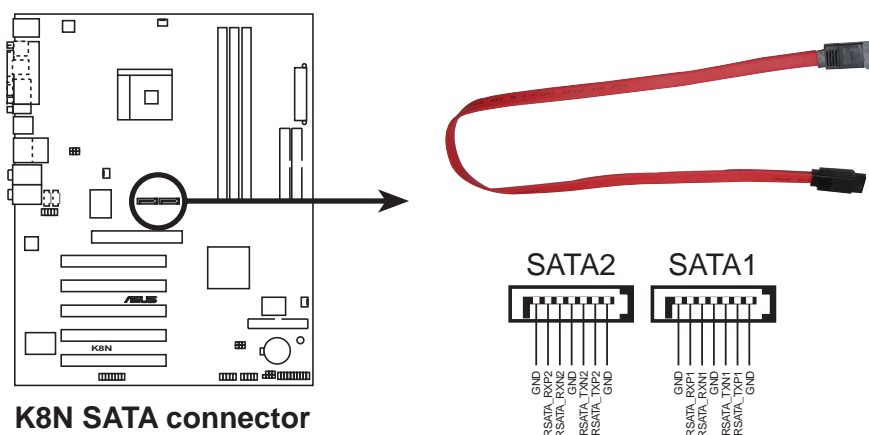

12. System panel connector (10-1 pin PANEL)

This connector accommodates several system front panel functions.

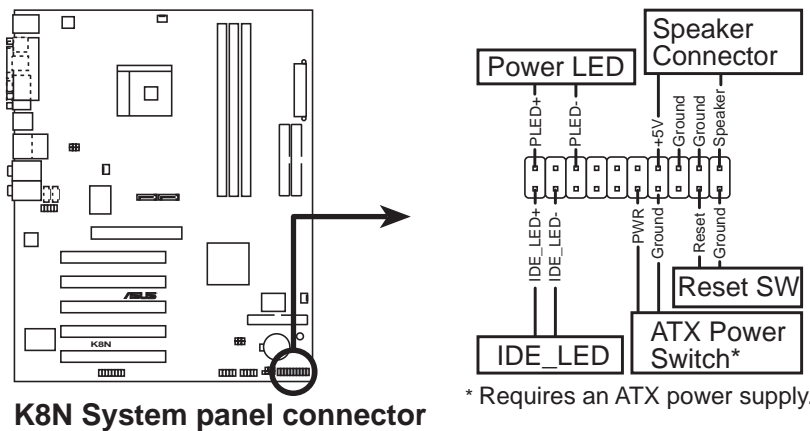

- **System Power LED Lead (Green 3-pin PLED)**

This 3-pin connector connects to the system power LED. The LED lights up when you turn on the system power, and blinks when the system is in sleep mode.

- **System Warning Speaker Lead (Orange 4-pin SPEAKER)**

This 4-pin connector connects to the case-mounted speaker and allows you to hear system beeps and warnings.

- **Reset Switch Lead (Blue 2-pin RESET)**

This 2-pin connector connects to the case-mounted reset switch for rebooting the system without turning off the system power.

- **ATX Power Switch / Soft-Off Switch Lead (Yellow 2-pin PWRSW)**

This connector connects a switch that controls the system power. Pressing the power switch turns the system between ON and SLEEP, or ON and SOFT OFF, depending on the BIOS or OS settings. Pressing the power switch while in the ON mode for more than 4 seconds turns the system OFF.

- **Hard disk activity LED (Red 2-pin IDE_LED)**

This connector supplies power to the hard disk activity LED. Any read or write activity of an IDE device cause this LED to light up.



The System Panel connector is color-coded for easy and foolproof connection. Take note of the specific connector colors as described.

Chapter 2

This chapter tells how to change system settings through the BIOS Setup menus. Detailed descriptions of the BIOS parameters are also provided.

BIOS information

2.1 Managing and updating your BIOS

The following utilities allow you to manage and update the motherboard Basic Input/Output System (BIOS) setup.

1. ASUS AFUDOS - Updates the BIOS using a bootable floppy disk in DOS mode.
2. ASUS EZ Flash - Updates the BIOS using a floppy disk during POST.
3. ASUS CrashFree BIOS 2 - Updates the BIOS using a bootable floppy disk or the motherboard support CD.

Refer to the corresponding sections for details on these utilities.

Important notes



-
- It is recommended that you save a copy of the **original motherboard BIOS file** to a **bootable floppy disk** in case you need to restore the BIOS in the future. Copy the original motherboard BIOS using AFUDOS (refer to section “2.1.3 Using AFUDOS to copy BIOS from PC”)
 - Visit the ASUS website and download the latest BIOS file for this motherboard using the ASUS Update utility.
-

2.1.1 Creating a bootable floppy disk

1. Do either one of the following to create a bootable floppy disk.

DOS environment

Insert a 1.44 MB floppy disk into the drive. At the DOS prompt, type:

```
format A: /S then press <Enter>.
```

Windows® 98SE/ME/XP environment

- a. Insert a 1.44 MB floppy disk into the floppy disk drive.
- b. From your Windows desktop, click on **Start**, then select **My Computer**.
- c. Select the **3 1/2 Floppy Drive** icon.
- d. Click **File** from the menu, then select **Format**. A **Format 3 1/2 Floppy Disk** window appears.
- e. If you are using Windows® XP, select **Create an MS-DOS startup disk** from the format options field, then click **Start**.

OR

If you are using Windows® 98SE/ME, select **Full** option button from the format type, then click **Start**.

Windows® 2000 environment

To create a set of boot disks for Windows® 2000, run the Makeboot.exe tool from the Windows® 2000 CD:

- a. Insert a 1.44 MB floppy disk into the floppy disk drive.
- b. Insert the Windows® 2000 CD into the CD-ROM drive.

- c. Click **Start**, then select **Run**.
 - d. From the Open box, type
`D:\bootdisk\makeboot a:` then press <Enter>, assuming that D: is your CD-ROM drive.
 - e. Follow succeeding screen instructions.
2. Copy the original (or the latest) motherboard BIOS to the bootable floppy disk.

2.1.2 Using AFUDOS to update the BIOS

To update the BIOS using the AFUDOS.EXE utility:

1. Visit the ASUS website (www.asus.com) to download the latest BIOS file for your motherboard. Save the BIOS file to a bootable floppy disk.



Write the BIOS file name on a piece of paper. You need to type the exact BIOS file name at the prompt.

2. Copy the AFUDOS.EXE utility from the support CD to the bootable floppy disk that contains the BIOS file.
3. Boot the system from the floppy disk.
4. At the DOS prompt, type the command line:

```
afudos /i[filename]
```

where **[filename]** means the latest (or original) BIOS file that you copied to the bootable floppy disk.

5. Press <Enter>. The succeeding screen displays the status of the update process.



The BIOS information on the screen is for reference only. What you see on your screen may not be exactly the same as shown.

```
A:\>afudos /iK8N.ROM
AMI Firmware Update Utility - Version 1.10
Copyright (C) 2002 American Megatrends, Inc. All rights reserved.

Reading file ..... done
Erasing flash .... done
Writing flash .... 0x0008CC00 (9%)
```



DO NOT shutdown or reset the system while updating the BIOS! Doing so may cause system boot failure!

When the BIOS update process is complete, the utility returns to the DOS prompt.

```
A:\>afudos /iK8N.ROM
AMI Firmware Update Utility - Version 1.10
Copyright (C) 2002 American Megatrends, Inc. All rights reserved.

Reading file ..... done
Erasing flash .... done
Writing flash .... 0x0008CC00 (9%)
Verifying flash .. done

A:\>
```

5. Reboot the system from the hard disk.

2.1.3 Using AFUDOS to copy BIOS from PC

You can use the AFUDOS.EXE utility to copy the current system BIOS to a floppy or hard disk and use it as a backup in case the system BIOS fails or gets corrupted.

To copy the BIOS from your PC using AFUDOS.EXE:

1. At the DOS prompt, type the command line:

```
afudos /o[filename]
```

where **[filename]** string of not more than eight (8) alpha-numeric characters for the main filename and three (3) alpha-numeric characters for the extension name.

2. Press <Enter>.



The BIOS information on the screen is for reference only. What you see on your screen may not be exactly the same as shown.

Main filename
Extension name

```
A:\>afudos /oMYBIOS03.rom
AMI Firmware Update Utility - Version 1.10
Copyright (C) 2002 American Megatrends, Inc. All rights reserved.

Reading flash ..... 0x0008CC00 (9%)
```

3. The utility will copy the current system BIOS by default to the floppy disk. Make sure that the floppy disk has at least 600KB of free disk space and is not write-protected.

```
A:\>afudos /oMYBIOS03.ROM
AMI Firmware Update Utility - Version 1.10
Copyright (C) 2002 American Megatrends, Inc. All rights reserved.

    Reading flash ..... done

A:\>
```

When the copy process is complete, the utility returns to the DOS prompt.

2.1.4 Using ASUS EZ Flash to update the BIOS

The ASUS EZ Flash feature allows you to easily update the BIOS without having to go through the long process of booting from a diskette and using a DOS-based utility. The EZ Flash is built-in the BIOS firmware so it is accessible by simply pressing **<Alt + F2>** during the Power-On Self Tests (POST).

To update the BIOS using ASUS EZ Flash:

1. Visit the ASUS website (www.asus.com) to download the latest BIOS file for your motherboard and rename the downloaded file as **K8N.ROM**. Save the BIOS file to a floppy disk.
2. Reboot the system.
3. To launch EZ Flash, press **<Alt+F2>** during POST to display the following.

```
User recovery requested. Starting BIOS recovery...

Checking for floppy...
```



- If there is no floppy disk in the drive, the error message "Floppy not found!" appears.
- If the correct BIOS file is not in the floppy disk, the error message "Floppy not found!" is displayed. Make sure to rename the downloaded BIOS file as "K8N.ROM".

4. Insert the floppy disk that contains the BIOS file. If all the necessary files are found in the floppy disk, EZ Flash performs the BIOS update process and automatically reboots the system when done.



DO NOT shutdown or reset the system while updating the BIOS! Doing so may cause system boot failure!

```
User recovery requested. Starting BIOS recovery...
Checking for floppy...
Floppy found!
Reading file "K8N.ROM". Completed.
Start flashing...
Flashed successfully. Rebooting.
```

2.1.5 Recovering the BIOS with CrashFree BIOS 2

The CrashFree BIOS 2 auto recovery tool allows you to restore BIOS from the motherboard support CD, or from a floppy disk that contains the BIOS file, in case the current BIOS on the motherboard fails or gets corrupted.



- Prepare the **support CD** that came with the motherboard or a **floppy disk that contains the motherboard BIOS** before proceeding with the BIOS update process.
- If you have saved a copy of the original motherboard BIOS to a bootable floppy disk, you may also use this disk to restore the BIOS. See section “2.1.1 Creating a bootable floppy disk.”

To recover the BIOS from a floppy disk:

1. Boot the system.
2. When a corrupted BIOS is detected, the following screen message appears.

```
Bad BIOS checksum. Starting BIOS recovery...
Checking for floppy...
```

3. Insert a floppy disk that contains the original or the latest BIOS file for this motherboard. If all the necessary files are found in the floppy disk, the BIOS update process continues.



Make sure that the BIOS file in the floppy disk is renamed as “**K8N.ROM**”.

```
Bad BIOS checksum. Starting BIOS recovery...
Checking for floppy...
Floppy found!
Reading file "K8N.ROM". Completed.
Start flashing...
```



DO NOT shut down or reset the system while updating the BIOS! Doing so may cause system boot failure!

2. When the BIOS update process is complete, reboot the system.

To recover the BIOS from the support CD:

1. Boot the system.
2. When a corrupted BIOS is detected, the following screen message appears.

```
Bad BIOS checksum. Starting BIOS recovery...
Checking for floppy...
```



If there is no floppy disk found in the drive, the system automatically checks the CD-ROM.

3. Place the support CD in the CD-ROM. The support CD contains the a working BIOS for this motherboard.

```
Bad BIOS checksum. Starting BIOS recovery...
Checking for floppy...
Floppy not found!
Checking for CD-ROM...
CD-ROM found.
Reading file "K8N.ROM". Completed.
Start flashing...
```



DO NOT shut down or reset the system while updating the BIOS! Doing so may cause system boot failure!

2. When the BIOS update process is complete, reboot the system.



The recovered BIOS may not be the latest BIOS version for this motherboard. Visit ASUS website (www.asus.com) to download the latest BIOS file.

2.2 BIOS Setup program

This motherboard supports a programmable firmware chip that you can update using the provided utility described in section “4.1 Managing and updating your BIOS.”

Use the BIOS Setup program when you are installing a motherboard, reconfiguring your system, or prompted to “Run Setup”. This section explains how to configure your system using this utility.

Even if you are not prompted to use the Setup program, you may want to change the configuration of your computer in the future. For example, you may want to enable the security password feature or change the power management settings. This requires you to reconfigure your system using the BIOS Setup program so that the computer can recognize these changes and record them in the CMOS RAM of the firmware hub.

The firmware hub on the motherboard stores the Setup utility. When you start up the computer, the system provides you with the opportunity to run this program. Press **** during the Power-On Self Test (POST) to enter the Setup utility. Otherwise, POST continues with its test routines.

If you wish to enter Setup after POST, restart the system by pressing **<Ctrl+Alt+Delete>**, or by pressing the reset button on the system chassis. You can also restart by turning the system off and then back on. Do this last option only if the first two failed.

The Setup program is designed to make it as easy to use as possible. It is a menu-driven program, which means you can scroll through the various sub-menus and make your selections from the available options using the navigation keys.



The default BIOS settings for this motherboard apply for most conditions to ensure optimum performance. If the system becomes unstable after changing any BIOS settings, load the default settings to ensure system compatibility and stability. Select the **Load Default Settings** item under the Exit Menu. See section “2.7 Exit Menu.”



The BIOS setup screens shown in this chapter are for reference purposes only, and may not exactly match what you see on your screen.

Visit the ASUS website (www.asus.com) to download the latest product and BIOS information.

2.2.1 BIOS menu screen

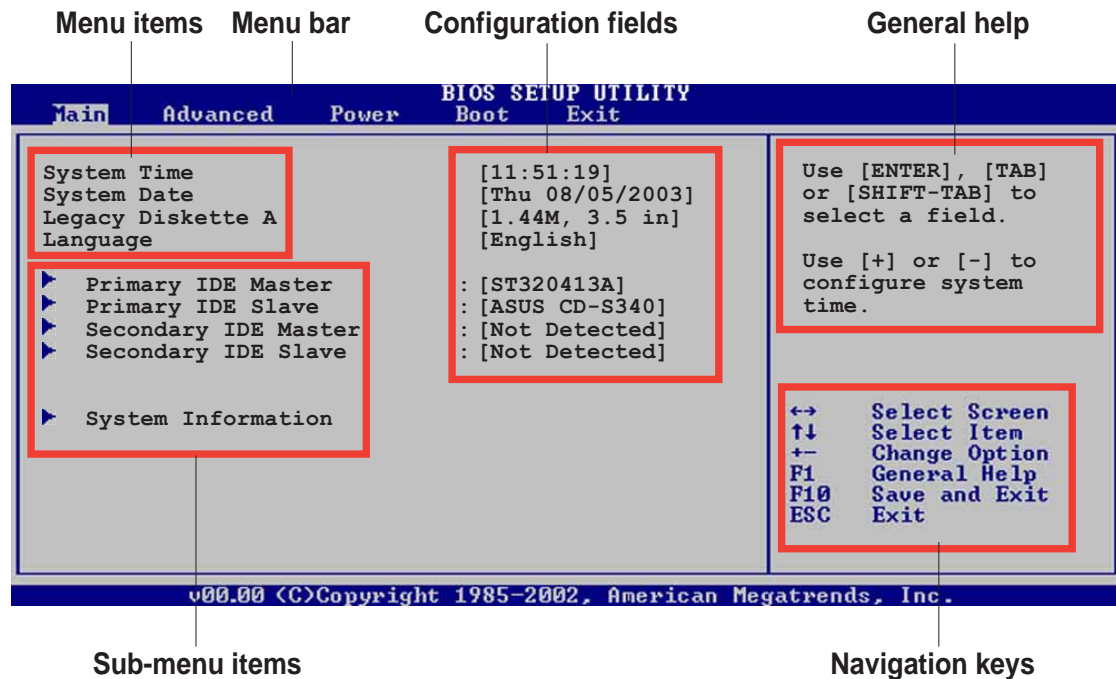

2.2.2 Menu bar

The menu bar on top of the screen has the following main items:

- Main** For changing the basic system configuration
- Advanced** For changing the advanced system settings
- Power** For changing the advanced power management (APM) configuration
- Boot** For changing the system boot configuration
- Exit** For selecting the exit options and loading default settings

To select an item on the menu bar, press the right or left arrow key on the keyboard until the desired item is highlighted.

2.2.3 Navigation keys

At the **bottom right corner** of a menu screen are the navigation keys for that particular menu. Use the navigation keys to select items in the menu and change the settings.



Some of the navigation keys differ from one screen to another.

2.2.4 Menu items

The highlighted item on the menu bar displays the specific items for that menu. For example, selecting **Main** shows the Main menu items.

The other items (Advanced, Power, Boot, and Exit) on the menu bar have their respective menu items.

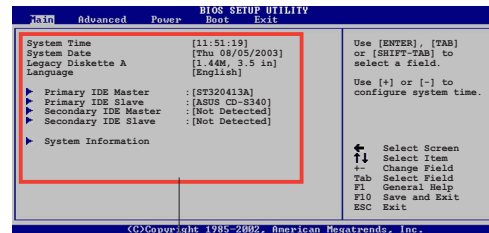

Main menu items

2.2.5 Sub-menu items

An item with a sub-menu on any menu screen is distinguished by a solid triangle before the item. To display the sub-menu, select the item and press <Enter>.

2.2.6 Configuration fields

These fields show the values for the menu items. If an item is user-configurable, you may change the value of the field opposite the item. You can not select an item that is not user-configurable.

A configurable field is enclosed in brackets, and is highlighted when selected. To change the value of a field, select it then press <Enter> to display a list of options. Refer to “2.2.7 Pop-up window.”

2.2.7 Pop-up window

Select a menu item then press <Enter> to display a pop-up window with the configuration options for that item.

2.2.8 Scroll bar

A scroll bar appears on the right side of a menu screen when there are items that do not fit on the screen. Press **Up/Down arrow keys** or **PageUp/PageDown keys** to display the other items on the screen.

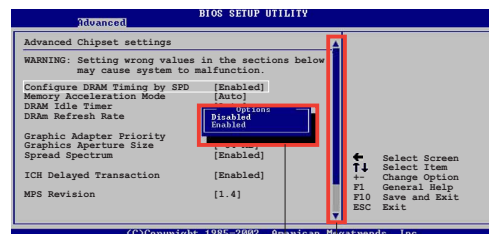

Pop-up window

Scroll bar

2.2.9 General help

At the top right corner of the menu screen is a brief description of the selected item.

2.3 Main menu

When you enter the BIOS Setup program, the Main menu screen appears, giving you an overview of the basic system information.



Refer to section “2.2.1 BIOS menu screen” for information on the menu screen items and how to navigate through them.

```
BIOS SETUP UTILITY
Main  Advanced  Power  Boot  Exit

System Time           [11:51:19]
System Date           [Thu 08/05/2003]
Legacy Diskette A     [1.44M, 3.5 in]
Language               [English]

▶ Primary IDE Master   : [ST320413A]
▶ Primary IDE Slave    : [ASUS CD-S340]
▶ Secondary IDE Master : [Not Detected]
▶ Secondary IDE Slave  : [Not Detected]
▶ Third IDE Master     : [Not Detected]
▶ Third IDE Slave      : [Not Detected]
▶ Fourth IDE Master    : [Not Detected]
▶ Fourth IDE Slave     : [Not Detected]

▶ System Information

Use [ENTER], [TAB]
or [SHIFT-TAB] to
select a field.

Use [+] or [-] to
configure system
time.

↔ Select Screen
↑↓ Select Item
+- Change Option
F1 General Help
F10 Save and Exit
ESC Exit

v00.00 (C)Copyright 1985-2002, American Megatrends, Inc.
```

2.3.1 System Time [xx:xx:xxxx]

Allows you to set the system time.

2.3.2 System Date [Day xx/xx/xxxx]

Allows you to set the system date.

2.3.3 Legacy Diskette A [1.44M, 3.5 in.]

Sets the type of floppy drive installed.

Configuration options: [Disabled] [360K, 5.25 in.] [1.2M, 5.25 in.] [720K, 3.5 in.] [1.44M, 3.5 in.] [2.88M, 3.5 in.]

2.3.4 Language [English]

Allows you to choose a BIOS language version.

Configuration options: [Français] [German] [English]

2.3.5 Primary and Secondary IDE Master/Slave

While entering Setup, BIOS auto-detects the presence of IDE devices. There is a separate sub-menu for each IDE device. Select a device item then press <Enter> to display the IDE device information.

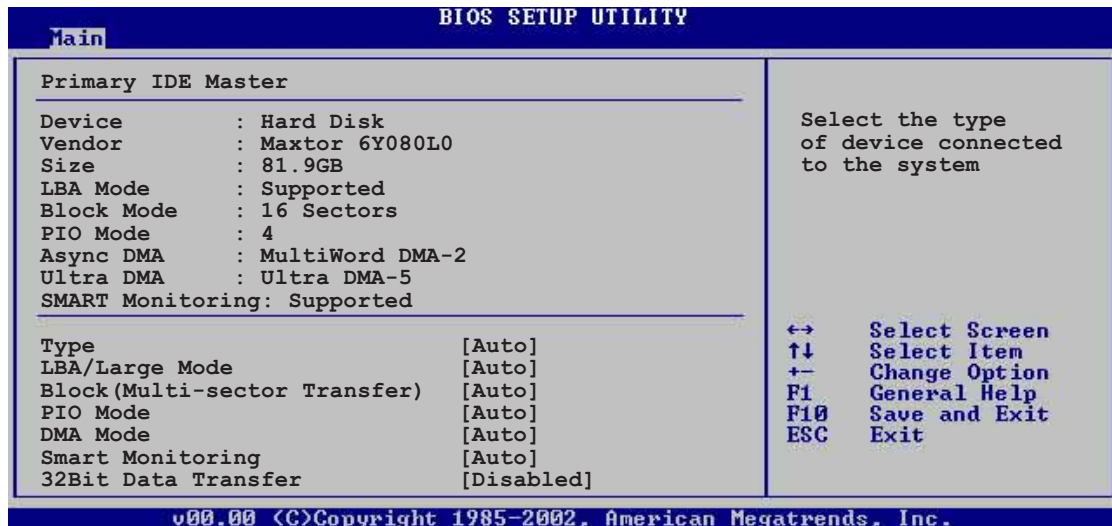

The values opposite the dimmed items (Device, Vendor, Size, LBA Mode, Block Mode, PIO Mode, Async DMA, Ultra DMA, and SMART monitoring) are auto-detected by BIOS and are not user-configurable. These items show N/A if no IDE device is installed in the system.

Type [Auto]

Selects the type of IDE drive. Setting to Auto allows automatic selection of the appropriate IDE device type. Select CDROM if you are specifically configuring a CD-ROM drive. Select ARMD (ATAPI Removable Media Device) if your device is either a ZIP, LS-120, or MO drive.

Configuration options: [Not Installed] [Auto] [CDROM] [ARMD]

LBA/Large Mode [Auto]

Enables or disables the LBA mode. Setting to Auto enables the LBA mode if the device supports this mode, and if the device was not previously formatted with LBA mode disabled. Configuration options: [Disabled] [Auto]

Block (Multi-sector Transfer) [Auto]

Enables or disables data multi-sectors transfers. When set to Auto, the data transfer from and to the device occurs multiple sectors at a time if the device supports multi-sector transfer feature. When set to Disabled, the data transfer from and to the device occurs one sector at a time.

Configuration options: [Disabled] [Auto]

PIO Mode [Auto]

Selects the PIO mode. Configuration options: [Auto] [0] [1] [2] [3] [4]

DMA Mode [Auto]

Selects the DMA mode. Configuration options: [Auto] [SWDMA0] [SWDMA1] [SWDMA2] [MWDMA0] [MWDMA1] [MWDMA2] [UDMA0] [UDMA1] [UDMA2] [UDMA3] [UDMA4] [UDMA5] [UDMA6]

SMART Monitoring [Auto]

Sets the Smart Monitoring, Analysis, and Reporting Technology.
Configuration options: [Auto] [Disabled] [Enabled]

32Bit Data Transfer [Disabled]

Enables or disables 32-bit data transfer.
Configuration options: [Disabled] [Enabled]

2.3.6 System Information

This menu gives you an overview of the general system specifications. The items in this menu are auto-detected by BIOS.

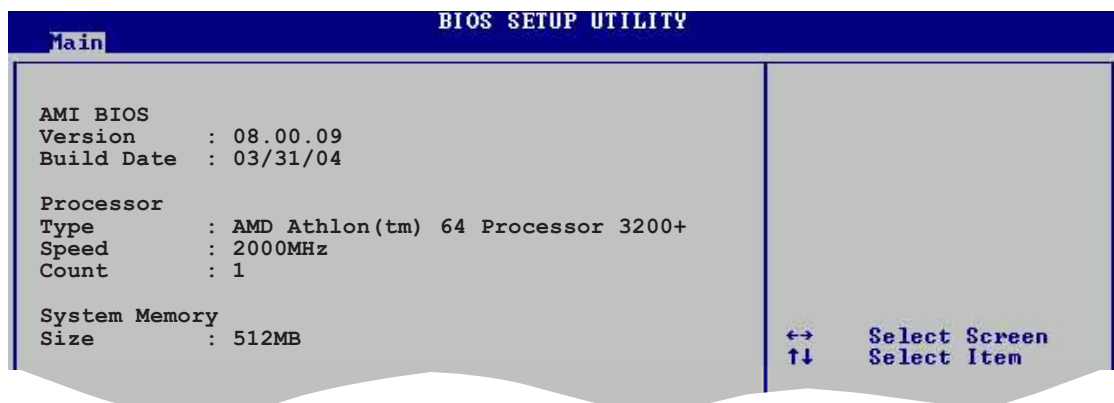

AMI BIOS

Displays the auto-detected BIOS information.

Processor

Displays the auto-detected processor information.

System Memory

Displays the auto-detected system memory.

2.4 Advanced menu

The Advanced menu items allow you to change the settings for the CPU and other system devices.



Take caution when changing the settings of the Advanced menu items. Incorrect field values may cause the system to malfunction.

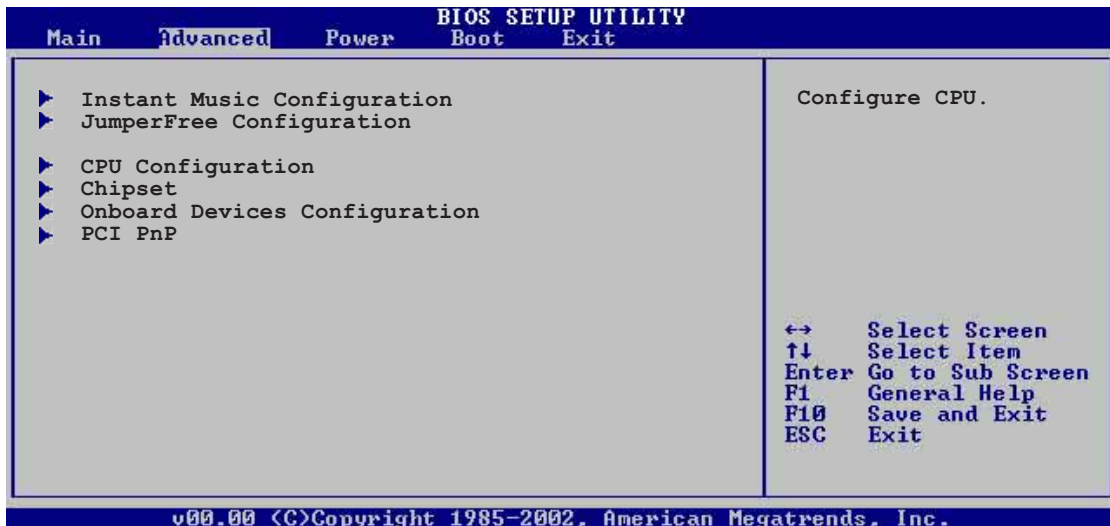

2.4.1 Instant Music Configuration



Instant Music [Disabled]

Allows you to enable or disable the Instant Music feature in BIOS. Configuration options: [Disabled] [Enabled]



Enabling Instant Music automatically disables the PS/2 keyboard power-up feature. See page 5-11 for details.

Instant Music CD-ROM Drive [IDE Secondary Master]

Allows you to select the CD-ROM drive that you wish to use for the Instant Music CD playback. Configuration options: [IDE Primary Master] [IDE Primary Slave] [IDE Secondary Master] [IDE Secondary Slave]



The above item appears only if you enable the Instant Music item.

2.4.2 JumperFree Configuration

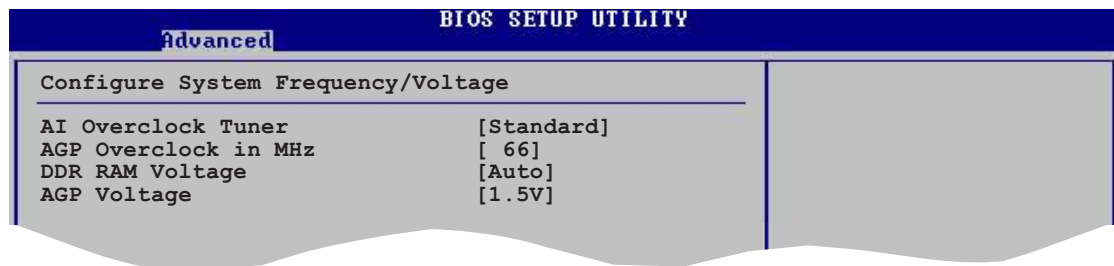

AI Overclock Tuner [Standard]

Allows selection of CPU overclocking options to achieve desired CPU internal frequency. Select either one of the preset overclocking options and the relevant parameters will appear. Configuration options: [Manual] [Standard] [Overclock 1%] [Overclock 3%] [Overclock 5%] [Overclock 10%]



The **CPU FSB Frequency** item appears only when the **AI Overclock Tuner** field is set to Manual.

CPU FSB Frequency [220]

Allows you to adjust the CPU FSB operating frequency. The FSB frequency configuration ranges from 200 to 300 MHz. Use the plus <+> or minus <-> keys to adjust the values.



Selecting a very high CPU frequency may cause the system to become unstable! If this happens, revert to the default setting.

AGP Overclock in MHz [66]

Allows you to adjust the AGP slot clock. The AGP frequency configuration ranges from 66 to 75 MHz. Use the plus <+> or minus <-> keys to adjust the values.

FID/VID Change [Auto]

When set to Auto, the Frequency ID and Voltage ID will be based on the rated frequency and voltage. If you want to adjust the Processor Frequency Multiplier and CPU voltage, set this item to Manual. Configuration options: [Auto] [Manual]

Processor Frequency Multiplier [xxxxMhz]

Allows you to set the processor frequency multiplier. The default value and configuration options depend on the CPU installed.

CPU Voltage [x.xxxx V]

Allows you to set the CPU voltage. The default value and configuration options depend on the CPU installed. This item appears only when the **Cool N' Quiet** feature is Enabled.

DDR RAM Voltage [Auto]

Allows you to automatically detect or select from a list the DDR operating voltage. Configuration options: [Auto] [2.5V] [2.6V] [2.7V]

AGP Voltage [1.5V]

Adjusts the AGP voltage setting. Configuration options: [1.5V] [1.6V] [1.7V]

2.4.3 CPU Configuration

The items in this menu show the CPU-related information auto-detected by BIOS.

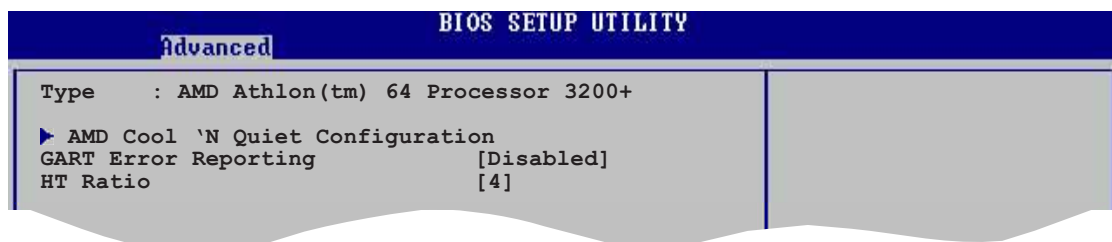

Type

Displays the processor type and properties installed in your system.

AMD Cool & Quiet Configuration

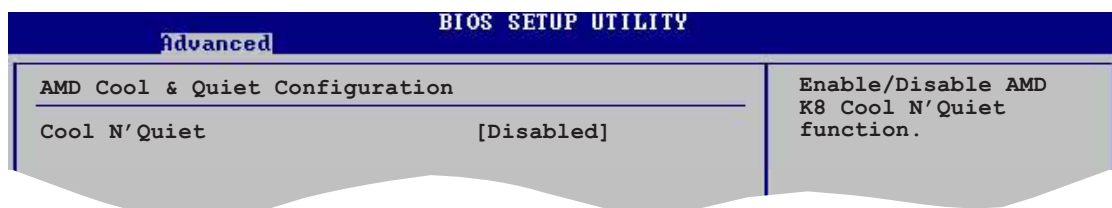

Cool N' Quiet [Disabled]

Allows you to enable or disable the AMD Cool 'n' Quiet!™ Technology feature. Configuration options: [Enabled] [Disabled]



- Make sure that the above item is set to **Enabled** if you want to use the AMD CPU Cool 'n' Quiet!™ Technology feature.
- This feature requires the AMD CPU heatsink and fan assembly with monitor chip. If you purchased a separate heatsink and fan package, use the ASUS Q-Fan Technology feature to automatically adjust the CPU fan speed according to your system loading.

GART Error Reporting [Disabled]

Enables or disables the GART Error Reporting feature. This option should always be disabled for normal operation. Device driver developers may enable it for testing purpose. Configuration options: [Disabled] [Enabled]

HT Ratio [4]

Sets the Hyper-Transport (HT) ratio. Configuration options: [1] [2] [3] [4]

2.4.4 Chipset

The items in this menu show the chipset-related information auto-detected by BIOS.



Memclock Mode [Auto]

Allows you to set the memory clock mode. Set by the code using [Auto] or select [Manual] to set using one of the standard values.

Configuration options: [Auto] [Manual]

MemClock Value [200 MHz]

Sets the Memory clock value. This item appears only when the **MemClock Mode** item is set to Manual. Configuration options: [200 MHz] [266 MHz] [333 MHz] [400 MHz]

CAS Latency (CL) [Auto]

Sets the CAS Latency value. Configuration options: [Auto] [2.0] [3.0] [2.5]

DRAM RAS TO CAS Delay [Auto]

Sets the DRAM RAS TO CAS Delay.

Configuration options: [Auto] [2 CLK] [3 CLK] [4 CLK] [5 CLK] [6 CLK]

DRAM RAS PRECHANGE Time [Auto]

Sets the DRAM RAS PRECHANGE Time.

Configuration options: [Auto] [2 CLK] [3 CLK] [4 CLK] [5 CLK] [6 CLK]

DRAM ACTIVE TIME [Auto]

Sets the DRAM ACTIVE TIME. Configuration options: [Auto] [5 CLK] [6 CLK]

[7 CLK] [8 CLK] [9 CLK] [10 CLK] [11 CLK] [12 CLK] [13 CLK] [14 CLK] [15 CLK]

1T/2T Timing [Auto]

Sets the DRAM command timing. When set to Auto, the DRAM timing is set to 2T if the CPU installed can support 2T timing. Configuration options: [1T] [Auto]

Master ECC Enable [Disabled]

Enables or disables support on all nodes for ECC error detect and correction.

Configuration options: [Disabled] [Enabled]

Audio CODEC Interface [Auto]

Allows you to set the onboard audio CODEC interface. [Auto] allows the BIOS to detect whether you are using any audio device.

Configuration options: [Enabled] [Disabled] [Auto]

Primary Video [PCI]

Switches the PCI Bus scanning order while searching for a video card. This allows you to select the type of Primary VGA in case of multiple video controllers.

Configuration options: [PCI] [AGP]

Aperture Size [128 MB]

Allows you to select the size of mapped memory for AGP graphic data.

Configuration options: [32 MB] [64 MB] [128 MB] [256 MB] [512 MB]

AGP FW Enable [Auto]

Disables or sets to automatic the AGP Fast Write feature.

Configuration options: [Auto] [Disabled]

AGP Sideband Address [Auto]

Disables or sets to automatic the AGP Sideband address.

Configuration options: [Auto] [Disabled]

Onboard Device

The items in this sub-menu allows you to change the settings of the onboard devices.

Advanced		BIOS SETUP UTILITY	
MAC Interface	[Enabled]		
Onboard LAN Boot ROM	[Disabled]		
Internal SATA IDE Interface	[Enabled]		
RAID Option ROM	[Disabled]		

MAC Interface [Enabled]

Allows you to enable or disable the internal 802.3 MAC interface.
Configuration options: [Enabled] [Disabled]

OnBoard LAN Boot ROM [Disabled]

Allows you to enable or disable the onboard LAN Boot ROM.
Configuration options: [Disabled] [Enabled]

Internal SATA IDE Interface [Enabled]

Allows you to enable or disable the onchip Serial ATA and IDE interface.
Configuration options: [Enabled] [Disabled]

RAID Option ROM [Disabled]

Allows you to enable or disable the onchip NVIDIA® Serial ATA boot ROM.
Configuration options: [Disabled] [Enabled]



The following items appear only when RAID Option ROM item is set to Enabled.

Primary Master as RAID [Disabled]

Enables or disables the use of the Primary IDE Master as RAID.
Configuration options: [Disabled] [Enabled]

Primary Slave as RAID [Disabled]

Enables or disables the use of the Primary IDE Slave as RAID.
Configuration options: [Disabled] [Enabled]

Secondary Master as RAID [Disabled]

Enables or disables the use of the Secondary IDE Master as RAID.
Configuration options: [Disabled] [Enabled]

Secondary Slave as RAID [Disabled]

Enables or disables the use of the Secondary IDE Slave as RAID.
Configuration options: [Disabled] [Enabled]

Third Master as RAID [Disabled]

Enables or disables the use of the Third IDE Master as RAID.
Configuration options: [Disabled] [Enabled]

Fourth Master as RAID [Disabled]

Enables or disables the use of the Fourth IDE Master as RAID.
Configuration options: [Disabled] [Enabled]

USB Configuration

The items in this menu allows you to change the USB-related features. Select an item then press <Enter> to display the configuration options.

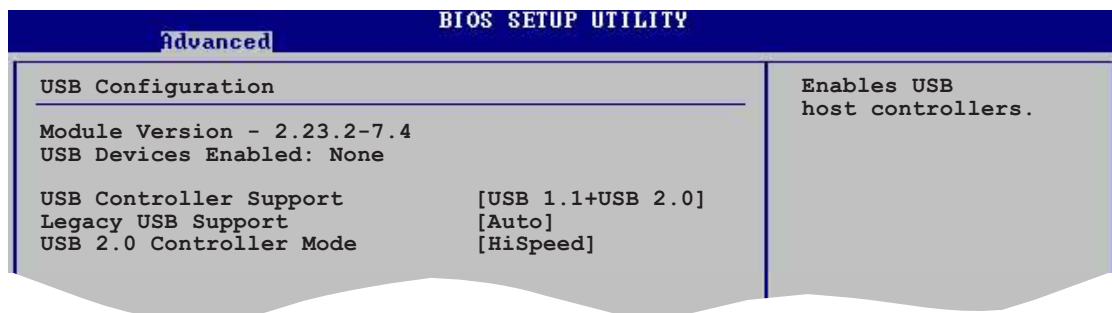

The Module Version and USB Devices Enabled items show the auto-detected values. If no USB device is detected, the item shows None.

USB Controller Support [USB 1.1+USB 2.0]

Allows you to disable or set the USB controller support type.
Configuration options: [Disabled] [USB 1.1 only] [USB 1.1+USB 2.0]

Legacy USB Support [Auto]

Allows you to enable or disable support for legacy USB devices. Setting to Auto allows the system to detect the presence of USB devices at startup. If detected, the USB controller legacy mode is enabled. If no USB device is detected, the legacy USB support is disabled. Configuration options: [Disabled] [Enabled] [Auto]

USB 2.0 Controller Mode [HiSpeed]

Allows you to configure the USB 2.0 controller in HiSpeed (480 Mbps) or Full Speed (12 Mbps). Configuration options: [HiSpeed] [Full Speed]

2.4.5 Onboard Devices Configuration

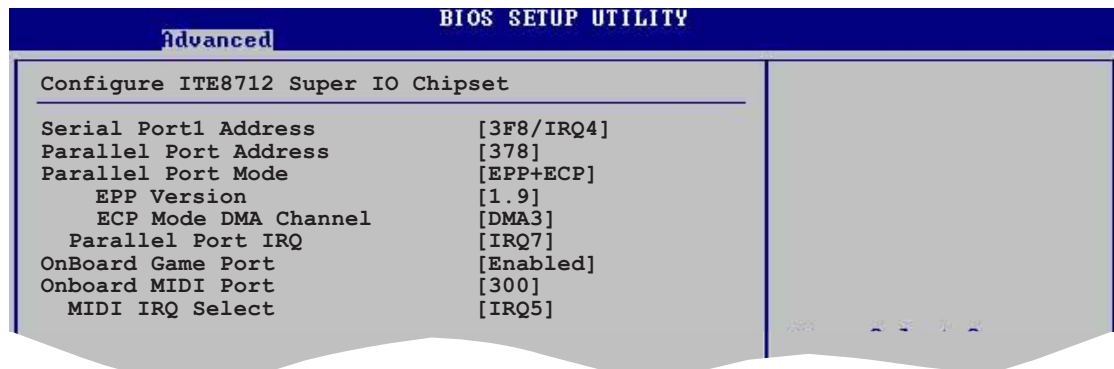

Serial Port1 Address [3F8/IRQ4]

Allows you to select the Serial Port1 base address.

Configuration options: [Disabled] [3F8/IRQ4] [3E8/IRQ4] [2E8/IRQ3]

Parallel Port Address [378]

Allows you to select the Parallel Port base addresses.

Configuration options: [Disabled] [378] [278]



The following items appear only when the Parallel Port Address item is set to Enabled.

Parallel Port Mode [EPP+ECP]

Allows you to select the Parallel Port mode. This item appears only when the **Parallel Port Address** is not Disabled.

Configuration options: [Normal] [EPP] [ECP] [EPP+ECP]

EPP Version [1.9]

Allows selection of the Parallel Port EPP version. This item appears only when the **Parallel Port Mode** is set to EPP. Configuration options: [1.9] [1.7]

ECP Mode DMA Channel [DMA3]

Allows you to set the Parallel Port ECP DMA. This item appears only when the **Parallel Port Mode** is set to ECP. Configuration options: [DMA0] [DMA1] [DMA3]

Parallel Port IRQ [IRQ7]

Sets the Parallel port IRQ. Configuration options: [IRQ5] [IRQ7]

Onboard Game Port [Enabled]

Enables or disables the onboard Game port.

Configuration options: [Disabled] [Enabled]

Onboard MIDI Port [300]

Disables or sets the onboard MIDI port.

Configuration options: [Disabled] [300] [330]

MIDI IRQ Select [IRQ5]

Sets the MIDI port IRQs.

Configuration options: [IRQ5] [IRQ7] [IRQ10] [IRQ11]

2.4.6 PCI PnP

The PCI PnP menu items allow you to change the advanced settings for PCI/PnP devices. The menu includes setting IRQ and DMA channel resources for either PCI/PnP or legacy ISA devices, and setting the memory size block for legacy ISA devices.



Take caution when changing the settings of the PCI PnP menu items. Incorrect field values may cause the system to malfunction.

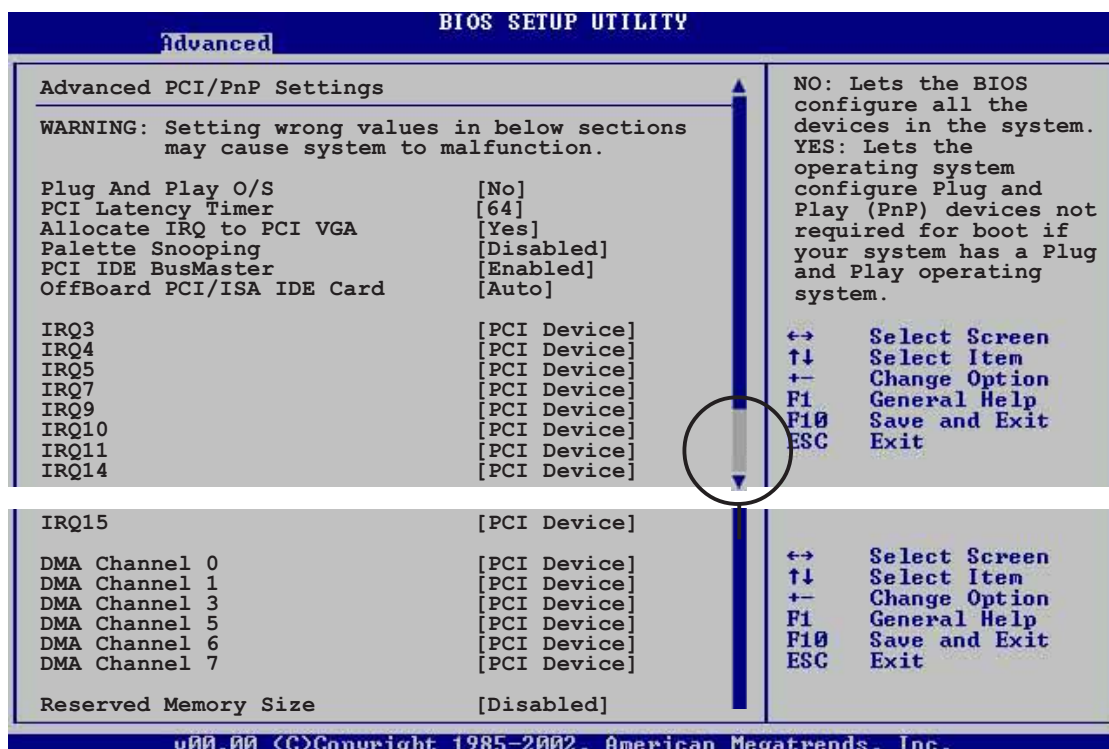

Plug and Play O/S [No]

When set to [No], the BIOS configures all the devices in the system. When set to [Yes] and if you installed a Plug & Play operating system (OS), the OS configures the Plug & Play devices not required for boot. Configuration options: [No] [Yes]

PCI Latency Timer [64]

Allows you to select the value in units of PCI clocks for the PCI device latency timer register. Configuration options: [32] [64] [96] [128] [160] [192] [224] [248]

Allocate IRQ to PCI VGA [Yes]

When set to [Yes], BIOS assigns an IRQ to PCI VGA card if the card requests for an IRQ. When set to [No], BIOS does not assign an IRQ to the PCI VGA card even if requested. Configuration options: [Yes] [No]

Palette Snooping [Disabled]

When set to [Enabled], the palette snooping feature informs the PCI devices that an ISA graphics device is installed in the system so that the latter can function correctly. Setting to [Disabled] deactivates this feature.
Configuration options: [Disabled] [Enabled]

PCI IDE BusMaster [Enabled]

Allows the BIOS to use PCI bus mastering when reading/writing to IDE devices.
Configuration options: [Disabled] [Enabled]

OffBoard PCI/ISA IDE Card [Auto]

Sets the OffBoard PCI/ISA IDE card slot. Some PCI IDE cards requires you to set the PCI slot number that is holding the card.
Configuration options: [Auto] [PCI Slot 1] [PCI Slot 2] [PCI Slot 3] [PCI Slot 4] [PCI Slot 5] [PCI Slot 6]

IRQ xx [PCI Device]

When set to [PCI Device], the specific IRQ is free for PCI/PnP devices to use. When set to [Reserved], the IRQ is reserved for legacy ISA devices.
Configuration options: [PCI Device] [Reserved]

DMA Channel x [PCI Device]

When set to [PCI Device], the specific IRQ is free for use of PCI/PnP devices. When set to [Reserved], the IRQ is reserved for legacy ISA devices.
Configuration options: [PCI Device] [Reserved]

Reserved Memory Size [Disabled]

Disables or sets the reserve memory size.
Configuration options: [Disabled] [16k] [32k] [64k]

2.5 Power menu

The Power menu items allow you to change the settings for the Advanced Power Management (APM) feature. Select an item then press <Enter> to display the configuration options.

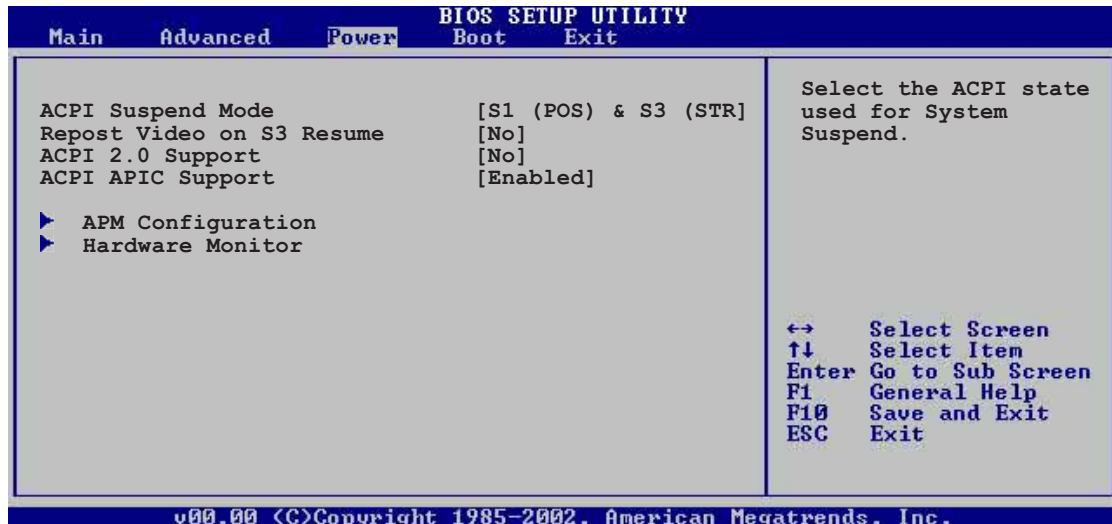

2.5.1 ACPI Suspend Mode [S3 only]

Allows you to select the ACPI state to be used for system suspend.
Configuration options: [S1 (POS) Only] [S3 Only]

2.5.2 Repost Video on S3 Resume [No]

Determines whether to invoke VGA BIOS POST on S3/STR resume.
Configuration options: [No] [Yes]

2.5.3 ACPI 2.0 Support [No]

Allows you to add more tables for ACPI 2.0 specifications.
Configuration options: [No] [Yes]

2.5.4 ACPI APIC Support [Enabled]

Enables or disables the ACPI support in the ASIC. When set to Enabled, the ACPI APIC table pointer is included in the RSDT pointer list.
Configuration options: [Disabled] [Enabled]

2.5.5 APM Configuration

BIOS SETUP UTILITY	
Power	
PME Resume	[Disabled]
RI Resume	[Disabled]
Onboard LAN Resume	[Disabled]
RTC Resume	[Disabled]
Resume On PS/2 Keyboard	[Disabled]
Restore On PS/2 Mouse	[Disabled]
Restore on AC Power Loss	[Power Off]

PME Resume [Disabled]

Allows you to enable or disable the PME# to generate a wake event. This feature requires an ATX power supply that provides at least 1A on the +5VSB lead.

Configuration options: [Disabled] [Enabled]

RI Resume [Disabled]

Allows you to enable or disable the RI to generate a wake event. This feature requires an ATX power supply that provides at least 1A on the +5VSB lead.

Configuration options: [Disabled] [Enabled]

Onboard LAN Resume [Disabled]

Allows you to enable or disable the onboard LAN to generate a wake event. This feature requires an ATX power supply that provides at least 1A on the +5VSB lead.

Configuration options: [Disabled] [Enabled]

RTC Resume [Disabled]

Allows you to enable or disable RTC to generate a wake event. When this item is set to Enabled, the items RTC Alarm Date, RTC Alarm Hour, RTC Alarm Minute, and RTC Alarm Second appear with set values. This feature requires an ATX power supply that provides at least 1A on the +5VSB lead.

Configuration options: [Disabled] [Enabled]

Resume On PS/2 Keyboard [Disabled]

Allows you to enable or disable the keyboard wake-up feature. This feature requires an ATX power supply that provides at least 1A on the +5VSB lead.

Configuration options: [Disabled] [Enabled]

Resume On PS/2 Mouse [Disabled]

When set to [Enabled], this parameter allows you to use the PS/2 mouse to resume the system. This feature requires an ATX power supply that provides at least 1A on the +5VSB lead. Configuration options: [Disabled] [Enabled]

Restore on AC Power Loss [Power Off]

When set to Power Off, the system goes into off state after an AC power loss. When set to Power On, the system goes on after an AC power loss. When set to Last State, the system goes into either off or on state whatever was the system state before the AC power loss. Configuration options: [Power Off] [Power On] [Last State]

2.5.6 Hardware Monitor

BIOS SETUP UTILITY	
Power	
Hardware Monitor	CPU Temperature
MB Temperature [35°C/95°F]	
CPU Temperature [48°C/118°F]	
CPU Fan Speed [3260RPM]	
Chassis Fan Speed [N/A]	
Power Fan Speed [N/A]	
VCORE Voltage [1.520V]	
3.3V Voltage [3.280V]	
5V Voltage [5.086V]	
12V Voltage [11.742V]	
Smart Q-Fan Control [Disabled]	
	←→ Select Screen
	↑↓ Select Item
	+− Change Option
	F1 General Help
	F10 Save and Exit
	ESC Exit

MB Temperature [xxx °C/xxx °F]

CPU Temperature [xxx °C/xxx °F]

The onboard hardware monitor automatically detects and displays the CPU and motherboard temperatures. Select Disabled if you do not wish to display the detected temperatures.

CPU Fan Speed [xxxxRPM] or [N/A]

Chassis Fan Speed [xxxxRPM] or [N/A]

Power Fan Speed [xxxxRPM] or [N/A]

The onboard hardware monitor automatically detects and displays the CPU, chassis, and power fan speeds in rotations per minute (RPM). If any of the fans is not connected to the motherboard, the specific field shows N/A.

VCORE Voltage, +3.3V Voltage, +5V Voltage, +12V Voltage

The onboard hardware monitor automatically detects the voltage output through the onboard voltage regulators.

Smart Q-FAN Function [Disabled]

Allows you to enable or disable the Smart Q-Fan feature that monitors the CPU temperature and smartly adjusts the fan speed according to the temperature.

Configuration options: [Disabled] [Enabled]



The following items appear only when the Smart Q-Fan Function item is set Enabled.

CPU Fan Start Voltage [5.0V]

Allows you to set the fan auto mode start voltage.

Configuration options: [4.0V] [4.5V] [5.0V] [5.5V] [6.0V]

CPU Fan Full Speed Temp [45°C]

Allows you to set the fan auto mode start speed temperature.

Configuration options: [35°C] ~ [75°C]

CPU Fan Start Fan Temp [40°C]

Allows you to set the fan auto mode full speed temperature.

Configuration options: [35°C] ~ [75°C]

2.6 Boot menu

The Boot menu items allow you to change the system boot options. Select an item then press <Enter> to display the sub-menu.

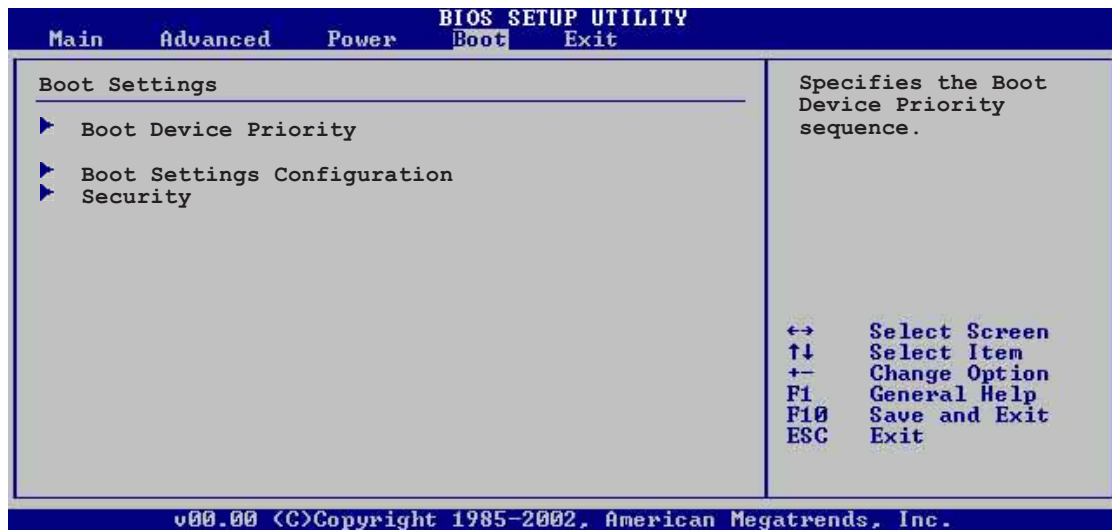

2.6.1 Boot Device Priority

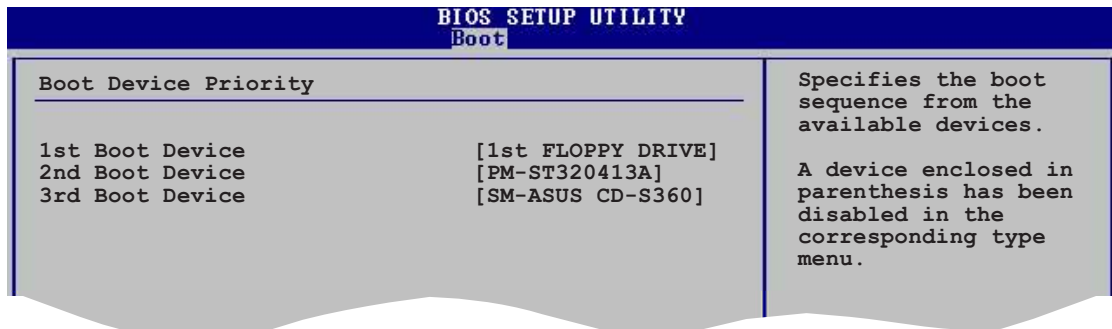

1st ~ xxth Boot Device [1st Floppy Drive]

These items specify the boot device priority sequence from the available devices. The number of device items that appear on the screen depends on the the number of devices installed in the system. Configuration options: [xxxxx Drive] [Disabled]

2.6.2 Hard Disk Drives

BIOS SETUP UTILITY	
Boot	
Hard Disk Drives	Specifies the boot sequence from the available devices.
1st Drive	[PM-ST330620A]
2nd Drive	[NVIDIA MIRROR 111.]

1st ~ xxth Drive [XXXXXXXXX]

These items specify the boot device priority sequence from the available devices. The number of device items that appear on the screen depends on the the number of devices installed in the system. Configuration options: [xxxxx Drive] [Disabled]

2.6.3 Boot Settings Configuration

BIOS SETUP UTILITY	
Boot	
Boot Settings Configuration	Allows BIOS to skip certain tests while booting. This will decrease the time needed to boot the system.
Quick Boot	[Enabled]
Full Screen Logo	[Enabled]
AddOn ROM Display Mode	[Force BIOS]
Bootup Num-Lock	[On]
PS/2 Mouse Support	[Auto]
Wait for 'F1' If Error	[Enabled]
Hit 'DEL' Message Display	[Enabled]
Interrupt 19 Capture	[Disabled]

Quick Boot [Enabled]

Enabling this item allows the BIOS to skip some Power On Self Tests (POST) while booting to decrease the time needed to boot the system. When set to [Disabled], BIOS performs all the POST items. Configuration options: [Disabled] [Enabled]

Full Screen Logo [Enabled]

Allows you to enable or disable the full screen logo display feature. Configuration options: [Disabled] [Enabled]



Make sure that the above item is set to [Enabled] if you wish to use the ASUS MyLogo2™ feature.

Add On ROM Display Mode [Force BIOS]

Sets the display mode for option ROM.
Configuration options: [Force BIOS] [Keep Current]

Bootup Num-Lock [On]

Allows you to select the power-on state for the NumLock.
Configuration options: [Off] [On]

PS/2 Mouse Support [Auto]

Allows you to enable or disable support for PS/2 mouse.
Configuration options: [Disabled] [Enabled] [Auto]

Wait for 'F1' If Error [Enabled]

When set to Enabled, the system waits for F1 key to be pressed when error occurs. Configuration options: [Disabled] [Enabled]

Hit 'DEL' Message Display [Enabled]

When set to Enabled, the system displays the message "Press DEL to run Setup" during POST. Configuration options: [Disabled] [Enabled]

Interrupt 19 Capture [Disabled]

When set to [Enabled], this function allows the option ROMs to trap Interrupt 19.
Configuration options: [Disabled] [Enabled]

2.6.4 Security

The Security menu items allow you to change the system security settings. Select an item then press <Enter> to display the configuration options.

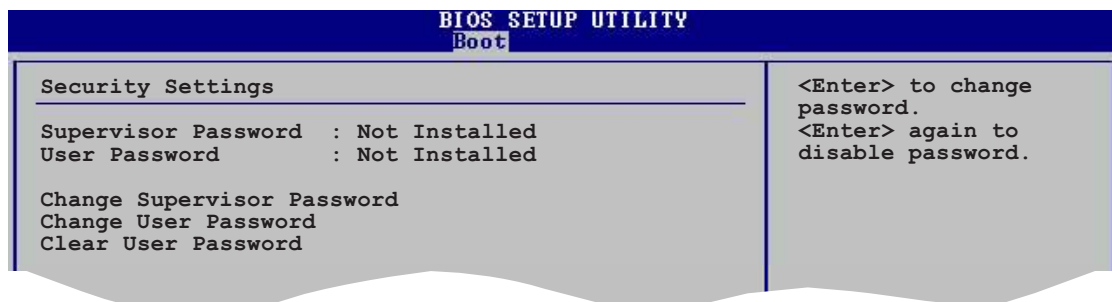

Change Supervisor Password

Select this item to set or change the supervisor password. The Supervisor Password item on top of the screen shows the default **Not Installed**. After you have set a password, this item shows **Installed**.

To set a Supervisor Password:

1. Select the Change Supervisor Password item and press <Enter>.
2. From the password box, type a password combination of at least six (6) letters and/or numbers, then press <Enter>.
3. Confirm the password when prompted.
The message "Password Installed" appears after you have successfully set your password.
The Supervisor Password item now shows **Installed**.

To change the supervisor password, follow the same steps as in setting a user password.

To clear the supervisor password, select the Change Supervisor Password then press <Enter>. The message "Password Uninstalled" appears.



If you forget your BIOS password, you can clear it by erasing the CMOS Real Time Clock (RTC) RAM. See section "2.6 Jumpers" for information on how to erase the RTC RAM.

After you have set a supervisor password, the other items appear to allow you to change other security settings.

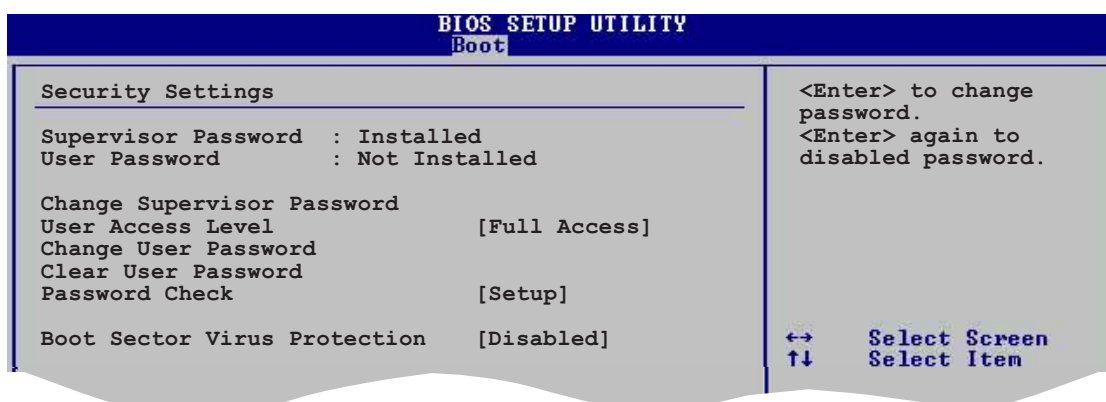

User Access Level (Full Access]

Allows you to select the access restriction to the Setup items. Configuration options: [No Access] [View Only] [Limited] [Full Access]

No Access prevents user access to the Setup utility.

View Only allows access but does not allow change to any field.

Limited allows change only to selected fields, such as Date and Time.

Full Access allows viewing and changing all the fields in the Setup utility.

Change User Password

Select this item to set or change the user password. The User Password item on top of the screen shows the default **Not Installed**. After you have set a password, this item shows **Installed**.

To set a User Password:

1. Select the Change User Password item and press <Enter>.
2. On the password box that appears, type a password combination of at least six (6) letters and/or numbers, then press <Enter>.
3. Confirm the password when prompted.
The message "Password Installed" appears after you have successfully set your password.
The User Password item now shows **Installed**.

To change the user password, follow the same steps as in setting a user password.

Clear User Password

Select this item if you wish to clear the user password.

Password Check [Setup]

When set to [Setup], BIOS checks for user password when accessing the Setup utility. When set to [Always], BIOS checks for user password both when accessing Setup and booting the system. Configuration options: [Setup] [Always]

2.7 Exit menu

The Exit menu items allow you to load the optimal or failsafe default values for the BIOS items, and save or discard your changes to the BIOS items.

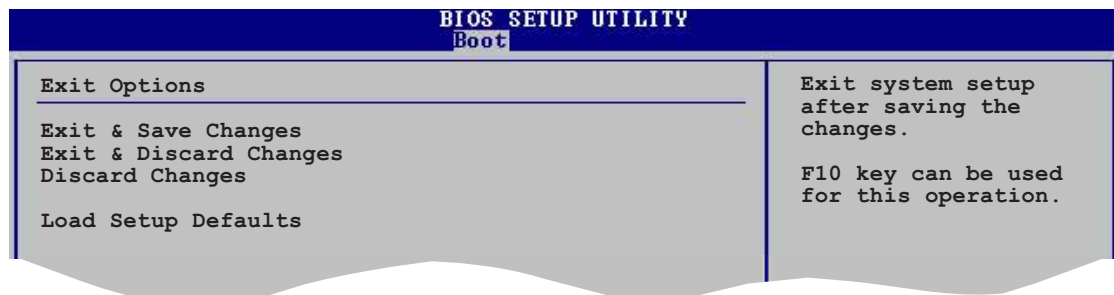

Pressing <Esc> does not immediately exit this menu. Select one of the options from this menu or <F10> from the legend bar to exit.

Exit & Save Changes

Once you are finished making your selections, choose this option from the Exit menu to ensure that the values you selected are saved to the CMOS RAM. An onboard backup battery sustains the CMOS RAM and stays on even when the PC is turned off. When you select this option, a confirmation window appears. Select **Ok** to save changes and exit.



If you attempt to exit the Setup program without saving your changes, the program prompts you with a message asking if you want to save your changes before exiting. Press <Enter> to save the changes while exiting.

Exit & Discard Changes

Select this option only if you do not want to save the changes that you made to the Setup program. If you made changes to fields other than System Date, System Time, and Password, the BIOS asks for a confirmation before exiting.

Discard Changes

Allows you to discard the selections you made and restore the previously saved values. After selecting this option, a confirmation appears. Select **Ok** to discard any changes and load the previously saved values.

Load Setup Defaults

This option allows you to load the default values for each of the parameters on the Setup menus. When you select this option or if you press <F5>, a confirmation window appears. Select **Ok** to load default values. Select **Exit and Save Changes** or make other changes before saving the values to the non-volatile RAM.

Chapter 3

This chapter describes the contents of the support CD that comes with the motherboard package.

Software support

3.1 Install an operating system

This motherboard supports Windows® 2000/XP/2003 Server operating system (OS). Always install the latest OS version and corresponding updates to maximize the features of your hardware.



Motherboard settings and hardware options vary, so use the setup procedures presented in this chapter for general reference only. Refer to your OS documentation for more information.

3.2 Support CD information

The support CD that came with the motherboard contains useful software and several utility drivers that enhance the motherboard features.



The contents of the support CD are subject to change at any time without notice. Visit the ASUS website for updates.

3.2.1 Running the support CD

To begin using the support CD, simply insert the CD into your CD-ROM drive. The CD automatically displays the **Drivers** menu if Autorun is enabled in your computer. Click on an item to install.

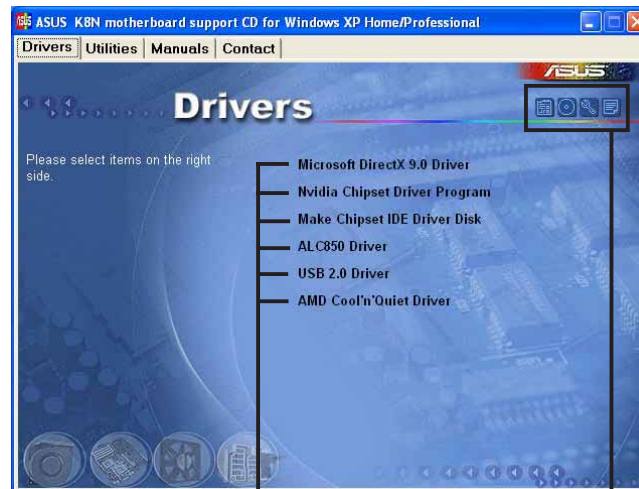

Click an item to install

Click an icon to display more information



If **Autorun** is NOT enabled in your computer, browse the contents of the support CD to locate the file **ASSETUP.EXE** from the **BIN** folder. Double-click the **ASSETUP.EXE** to run the CD.

3.2.2 Drivers menu

Microsoft DirectX 9.0 Driver

Installs the Microsoft® DirectX™ 9.0 driver.

Nvidia Chipset Driver Program

Installs the NVIDIA® Chipset drivers for the NVIDIA® nForce™ 3 250Gb chipset.



Make sure to install the Microsoft® DirectX™ 9.0 driver before installing the NVIDIA® Chipset drivers.

Make Chipset IDE Driver Disk

Creates the NVIDIA® driver disk for Serial ATA and RAID features.

ALC850 Driver

Installs the Realtek® ALC850 audio controller and application.

USB 2.0 Driver

Installs the Universal Serial Bus 2.0 (USB 2.0) driver.



For Windows® XP users, make sure to install Windows® XP Service Pack 1 to support USB 2.0.

AMD Cool 'n' Quiet Driver

Installs the AMD Cool 'n' Quiet!™ Technology driver.

3.2.3 Utilities menu

The Utilities menu shows the applications and other software that the motherboard supports.

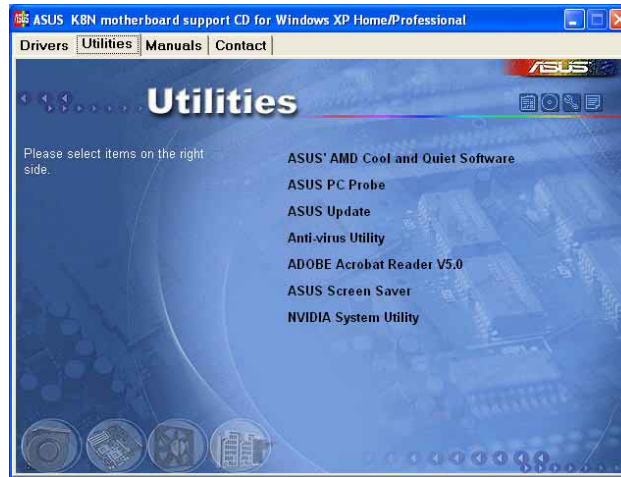

ASUS' AMD Cool 'n' Quiet Software

Installs the AMD Cool 'n' Quiet! Technology software.

ASUS PC Probe

This smart utility monitors the fan speed, CPU temperature, and system voltages, and alerts you on any detected problems. This utility helps you keep your computer at a healthy operating condition.

Install ASUS Update

This program allows you to download the latest version of the BIOS from the ASUS website. Before using the ASUS Update, make sure that you have an Internet connection so you can connect to the ASUS website. Installing ASUS Update also installs ASUS Mylogo2™.

Anti-virus Utility

The anti-virus application scans, identifies, and removes computer viruses. View the online help for detailed information.

Acrobat Reader

Installs the Adobe Acrobat® Reader V5.0. The Acrobat® Reader software is for viewing files saved in Portable Document Format (PDF).

ASUS Screen Saver

Installs the ASUS screen saver.

NVIDIA System Utility

Installs the NVIDIA® system utility.

3.2.4 Manual menu

The Manual menu contains a list of supplementary user manuals. Click an item to open the manual.

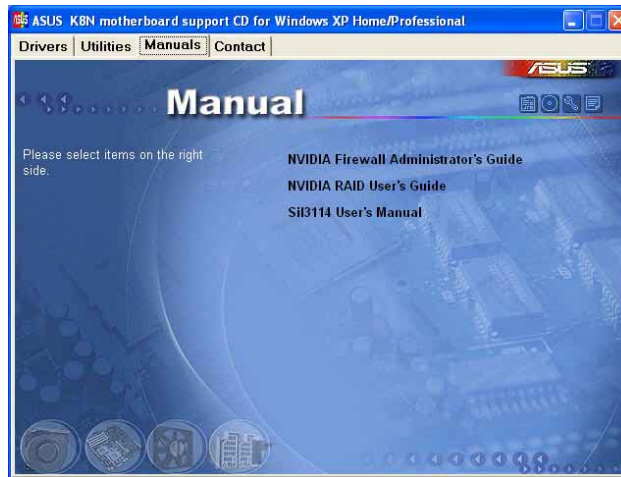

-
- Most user manual files are in Portable Document Format (PDF). Install the Adobe® Acrobat® Reader from the **Utilities menu** before opening a user manual file.
 - Some user manuals listed in this menu may not be applicable for this motherboard model.
-

3.2.5 ASUS Contact Information

Clicking the ASUS Contact Information tab displays as stated. You may also find this information on the inside front cover of this user guide.



3.3 ASUS Instant Music Lite

The motherboard is equipped with a BIOS-based audio playback feature called **Instant Music Lite**. This feature is supported by the onboard audio AC'97 Codec, and requires an optical drive (CD-ROM, DVD-ROM, or CD-RW).



-
- Instant Music Lite only supports CDs in audio format.
 - Instant Music Lite does not work if you installed and enabled an add-on sound card.
 - Instant Music Lite only supports PS/2 keyboard.
-

To enable ASUS Instant Music Lite:

1. Connect the analog audio cable from the optical drive (CD-ROM, DVD-ROM, or CD-RW drive) to the 4-pin CD-In connector (labeled CD1) on the motherboard. See section “1.10 Connectors” for the connector location.



Make sure to connect the CD-ROM audio cable. Otherwise, you cannot control the audio volume using the Instant Music Lite function keys.

2. Turn on the system and enter the BIOS by pressing the **** key during the Power On Self-Tests (POST).
3. In the **Advanced Configuration** menu, select the item **Instant Music** and set it to **Enabled**. See section “2.4 Advanced Menu” in the user guide.
4. Highlight the **Instant Music CDROM** item and press Enter to display the CD-ROM options. Select the CD-ROM drive that you wish to use for this feature. See section “2.4 Advanced Menu” in the user guide.



If you have only one optical drive (either CD-ROM, DVD-ROM, or CD-RW) installed in the system, you don't have to set Instant Music CDROM item. BIOS automatically detects and displays the installed drive type.

5. Save your changes and exit BIOS Setup.



-
- The Scroll Lock LED is fixed to ON after enabling Instant Music.
 - The Caps Lock LED is turns ON when you pause the CD playback.
 - When set to Instant Music Lite mode, the system wake-up features (LAN, keyboard, mouse, USB) are deactivated. In this case, power up the system using the power switch.
 - If the system loses connection or does not detect any optical drive, the Instant Music Lite feature turns OFF (disabled) automatically. A “beep” indicates this condition.
-

To use ASUS Instant Music Lite:

1. Ensure that the power cord is plugged to a grounded power source, so that the system has a standby power.
2. Use either one of the two sets of special function keys on your keyboard to play audio CDs. These keys only function as indicated if you enabled the Instant Music item in the BIOS.

Instant Music function keys (Set 1)

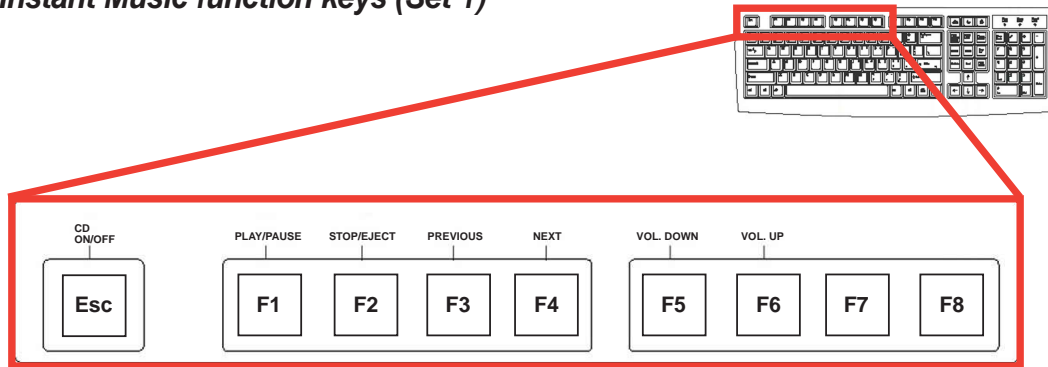

Instant Music function keys (Set 2)

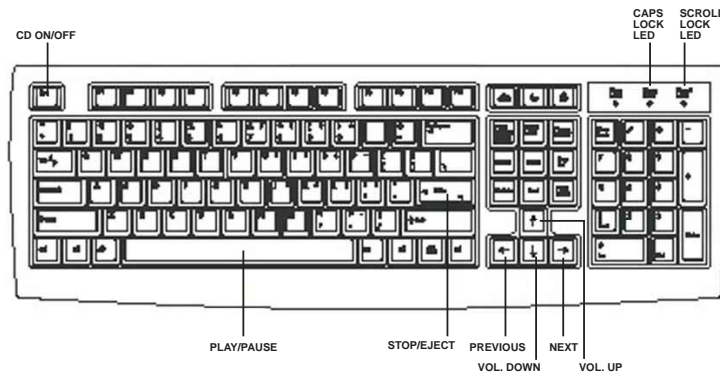

3. Connect speakers or a headphone to the Line Out (lime colored) port on the rear panel for audio output. You may also connect a headphone to the headphone jack on the CD-ROM drive front panel.
4. Press **<Esc>** to turn ON Instant Music Lite.
5. Place an audio CD into the drive.
6. Press **<F1>** or the **<Space Bar>** to play the first track on the CD.



If there is no CD in the drive and you press F1 or Space Bar, the drive tray ejects.

7. Refer to the Instant Music function key definitions on the previous page to select other tracks or control the volume.
8. Press **<F2>** or **<Enter>** *once* to stop playing the CD.
Press **<F2>** or **<Enter>** *one more time* to eject the CD.

3.4 Cool 'n' Quiet!™ Technology

The motherboard supports the AMD Cool 'n' Quiet!™ Technology that dynamically and automatically change the CPU speed, voltage and amount of power depending on the task the CPU performs.

3.4.1 Enabling Cool 'n' Quiet!™ Technology

To enable Cool 'n' Quiet!™ technology:

1. Turn on the system and enter BIOS by pressing the **** key during the Power On Self-Tests (POST).
2. In the **Advanced > CPU Configuration > AMD CPU Cool & Quiet Configuration** menu, select the item **Cool N'Quiet** and set it to **Enabled**. See section "2.4 Advanced Menu" for details.
3. In the **Power** menu, select the item **ACPI 2.0 Support** and set it to **Yes**. See section "2.5 Power Menu" for details.
4. Save your changes and exit BIOS Setup.
5. Reboot your computer and set your Power Option Properties depending on your operating system.

Windows® 2000/XP:

1. From the Windows® 2000/XP operating system, click the **Start** button. Select **Settings**, then **Control Panel**.
2. Make sure the Control Panel is set to Classic View.
3. Double-click the **Display** icon in the Control Panel then select the **Screen Saver** tab.
4. Click the **Power...** button. The following dialog box appears.
5. From the **Power schemes** combo list box, select **Minimal Power Management**.
6. Click **OK** to effect settings.

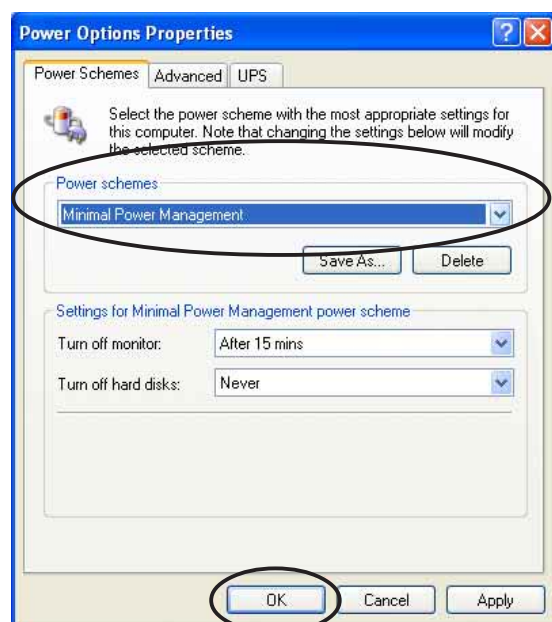

- Make sure to install the AMD Cool 'n' Quiet!™ driver and application before using this feature.
- The AMD Cool 'n' Quiet!™ Technology feature works only with the AMD heatsink and fan assembly with monitor chip.

3.4.2 Launching the Cool 'n' Quiet!™ software

The motherboard support CD includes the Cool 'n' Quiet!™ software that enables you to view your system's real-time CPU frequency and voltage.



Make sure to install the Cool 'n' Quiet!™ software from the motherboard support CD. Refer to section "3.2.3 Utilities" for details.

To launch the Cool 'n' Quiet!™ program:

1. If you are using Windows® 2000, click the **Start** button. Select **Programs > ASUS > Cool & Quiet > Cool & Quiet**.
2. If you are using Windows® XP, click the **Start** button. Select **All Programs > ASUS > Cool & Quiet > Cool & Quiet**.
3. The Cool 'n' Quiet!™ technology screen appears and displays the current CPU Frequency and CPU Voltage.

