



P4V533-MX

User Guide

Motherboard

E1457

Revised Edition V3

October 2003

Copyright © 2003 ASUSTeK COMPUTER INC. All Rights Reserved.

No part of this manual, including the products and software described in it, may be reproduced, transmitted, transcribed, stored in a retrieval system, or translated into any language in any form or by any means, except documentation kept by the purchaser for backup purposes, without the express written permission of ASUSTeK COMPUTER INC. ("ASUS").

Product warranty or service will not be extended if: (1) the product is repaired, modified or altered, unless such repair, modification or alteration is authorized in writing by ASUS; or (2) the serial number of the product is defaced or missing.

ASUS PROVIDES THIS MANUAL "AS IS" WITHOUT WARRANTY OF ANY KIND, EITHER EXPRESS OR IMPLIED, INCLUDING BUT NOT LIMITED TO THE IMPLIED WARRANTIES OR CONDITIONS OF MERCHANTABILITY OR FITNESS FOR A PARTICULAR PURPOSE. IN NO EVENT SHALL ASUS, ITS DIRECTORS, OFFICERS, EMPLOYEES OR AGENTS BE LIABLE FOR ANY INDIRECT, SPECIAL, INCIDENTAL, OR CONSEQUENTIAL DAMAGES (INCLUDING DAMAGES FOR LOSS OF PROFITS, LOSS OF BUSINESS, LOSS OF USE OR DATA, INTERRUPTION OF BUSINESS AND THE LIKE), EVEN IF ASUS HAS BEEN ADVISED OF THE POSSIBILITY OF SUCH DAMAGES ARISING FROM ANY DEFECT OR ERROR IN THIS MANUAL OR PRODUCT.

SPECIFICATIONS AND INFORMATION CONTAINED IN THIS MANUAL ARE FURNISHED FOR INFORMATIONAL USE ONLY, AND ARE SUBJECT TO CHANGE AT ANY TIME WITHOUT NOTICE, AND SHOULD NOT BE CONSTRUED AS A COMMITMENT BY ASUS. ASUS ASSUMES NO RESPONSIBILITY OR LIABILITY FOR ANY ERRORS OR INACCURACIES THAT MAY APPEAR IN THIS MANUAL, INCLUDING THE PRODUCTS AND SOFTWARE DESCRIBED IN IT.

Products and corporate names appearing in this manual may or may not be registered trademarks or copyrights of their respective companies, and are used only for identification or explanation and to the owners' benefit, without intent to infringe.

Contents

Notices	v
Safety information	vi
About this guide	vii
ASUS contact information	viii
P4V533-MX specifications summary	ix

Chapter 1: Product introduction

1.1 Welcome!	1-2
1.2 Package contents	1-2
1.3 Special features	1-3
1.4 Motherboard components	1-4
1.5 Motherboard layout	1-7
1.6 Before you proceed	1-8
1.7 Motherboard installation	1-9
1.7.1 Placement direction	1-9
1.7.2 Screw holes	1-9
1.8 Central Processing Unit (CPU)	1-10
1.8.1 Overview	1-10
1.8.2 Installing the CPU	1-11
1.9 System memory	1-12
1.9.1 Installing a DIMM	1-12
1.10 Expansion slots	1-13
1.10.1 Standard interrupt assignments	1-13
1.10.2 IRQ assignments for this motherboard	1-13
1.10.3 PCI slots	1-14
1.10.4 AGP slot	1-14
1.11 Jumper	1-15
1.12 Connectors	1-17

Chapter 2: BIOS information

2.1 Managing and updating your BIOS	2-2
2.1.1 Creating a bootable floppy disk	2-2
2.1.2 Using AFUDOS to update the BIOS	2-2
2.2 BIOS Setup program	2-4
2.2.1 BIOS menu screen	2-5
2.2.2 Menu bar	2-5
2.2.3 Navigation keys	2-5

Contents

2.2.4	Menu items	2-6
2.2.5	Sub-menu items	2-6
2.2.6	Configuration fields	2-6
2.2.7	Pop-up window	2-6
2.2.8	Scroll bar	2-6
2.2.9	General help	2-6
2.3	Main menu	2-7
2.3.1	System Time [xx:xx:xxxx]	2-7
2.3.2	System Date [Day xx/xx/xxxx]	2-7
2.3.3	Legacy Diskette A,B [1.44M, 3.5 in.]	2-7
2.3.4	Primary/Secondary/Third/Fourth IDE Master/Slave	2-8
2.3.5	System Information	2-9
2.4	Advanced menu	2-10
2.4.1	CPU Configuration	2-11
2.4.2	Chipset	2-11
2.4.3	Onboard Devices Configuration	2-13
2.4.4	PCI PnP	2-15
2.5	Power menu	2-16
2.5.1	Suspend Mode [Auto]	2-16
2.5.2	Repost Video on S3 Resume [No]	2-16
2.5.3	ACPI 2.0 Support [No]	2-16
2.5.4	ACPI APIC Support [Enabled]	2-16
2.5.5	APM Configuration	2-17
2.5.6	Hardware Monitor	2-19
2.6	Boot menu	2-20
2.6.1	Boot Device Priority	2-20
2.6.2	Boot Settings Configuration	2-21
2.6.3	Security	2-22
2.7	Exit menu	2-24

Chapter 3: Software support

3.1	Install an operating system	3-2
3.2	Support CD information	3-2

Notices

Federal Communications Commission Statement

This device complies with FCC Rules Part 15. Operation is subject to the following two conditions:

- This device may not cause harmful interference, and
- This device must accept any interference received including interference that may cause undesired operation.

This equipment has been tested and found to comply with the limits for a Class B digital device, pursuant to Part 15 of the FCC Rules. These limits are designed to provide reasonable protection against harmful interference in a residential installation. This equipment generates, uses and can radiate radio frequency energy and, if not installed and used in accordance with manufacturer's instructions, may cause harmful interference to radio communications. However, there is no guarantee that interference will not occur in a particular installation. If this equipment does cause harmful interference to radio or television reception, which can be determined by turning the equipment off and on, the user is encouraged to try to correct the interference by one or more of the following measures:

- Reorient or relocate the receiving antenna.
- Increase the separation between the equipment and receiver.
- Connect the equipment to an outlet on a circuit different from that to which the receiver is connected.
- Consult the dealer or an experienced radio/TV technician for help.



The use of shielded cables for connection of the monitor to the graphics card is required to assure compliance with FCC regulations. Changes or modifications to this unit not expressly approved by the party responsible for compliance could void the user's authority to operate this equipment.

Canadian Department of Communications Statement

This digital apparatus does not exceed the Class B limits for radio noise emissions from digital apparatus set out in the Radio Interference Regulations of the Canadian Department of Communications.

This class B digital apparatus complies with Canadian ICES-003.

Safety information

Electrical safety

- To prevent electrical shock hazard, disconnect the power cable from the electrical outlet before relocating the system.
- When adding or removing devices to or from the system, ensure that the power cables for the devices are unplugged before the signal cables are connected. If possible, disconnect all power cables from the existing system before you add a device.
- Before connecting or removing signal cables from the motherboard, ensure that all power cables are unplugged.
- Seek professional assistance before using an adapter or extension cord. These devices could interrupt the grounding circuit.
- Make sure that your power supply is set to the correct voltage in your area. If you are not sure about the voltage of the electrical outlet you are using, contact your local power company.
- If the power supply is broken, do not try to fix it by yourself. Contact a qualified service technician or your retailer.

Operation safety

- Before installing the motherboard and adding devices on it, carefully read all the manuals that came with the package.
- Before using the product, make sure all cables are correctly connected and the power cables are not damaged. If you detect any damage, contact your dealer immediately.
- To avoid short circuits, keep paper clips, screws, and staples away from connectors, slots, sockets and circuitry.
- Avoid dust, humidity, and temperature extremes. Do not place the product in any area where it may become wet.
- Place the product on a stable surface.
- If you encounter technical problems with the product, contact a qualified service technician or your retailer.

About this guide

Conventions used in this guide

To make sure that you perform certain tasks properly, take note of the following symbols used throughout this manual.



WARNING: Information to prevent injury to yourself when trying to complete a task.



CAUTION: Information to prevent damage to the components when trying to complete a task.



IMPORTANT: Information that you **MUST** follow to complete a task.



NOTE: Tips and additional information to aid in completing a task.

Where to find more information

Refer to the following sources for additional information and for product and software updates.

1. ASUS Websites

The ASUS websites worldwide provide updated information on ASUS hardware and software products. The ASUS websites are listed in the ASUS Contact Information on page viii.

2. Optional Documentation

Your product package may include optional documentation, such as warranty flyers, that may have been added by your dealer. These documents are not part of the standard package.

ASUS contact information

ASUSTeK COMPUTER INC. (Asia-Pacific)

Address: 150 Li-Te Road, Peitou, Taipei, Taiwan 112
General Tel: +886-2-2894-3447
General Fax: +886-2-2894-3449
Web Site: www.asus.com.tw

Technical Support

MB/Others (Tel): +886-2-2890-7121 (English)
Notebook (Tel): +886-2-2890-7122 (English)
Desktop/Server (Tel): +886-2-2890-7123 (English)
Support Fax: +886-2-2890-7698

ASUS COMPUTER INTERNATIONAL (America)

Address: 44370 Nobel Drive, Fremont, CA 94538, USA
General Fax: +1-502-933-8713
General Email: tmd1@asus.com
Web Site: usa.asus.com

Technical Support

Support Fax: +1-502-933-8713
General Support: +1-502-995-0883
Notebook Support: +1-510-739-3777 x5110
Support Email: tsd@asus.com

ASUS COMPUTER GmbH (Germany and Austria)

Address: Harkortstr. 25, 40880 Ratingen, BRD, Germany
General Email: sales@asuscom.de (for marketing requests only)
General Fax: +49-2102-9599-31
Web Site: www.asuscom.de

Technical Support

Components: +49-2102-9599-0
Notebook PC: +49-2102-9599-10
Support Fax: +49-2102-9599-11
Support Email: www.asuscom.de/support (for online support)

ASUSTeK COMPUTER (Middle East and North Africa)

Address: P.O. Box 64133, Dubai, U.A.E.
General Tel: +9714-283-1774
General Fax: +9714-283-1775
Web Site: www.ASUSarabia.com

P4V533-MX specifications summary

CPU	Socket 478 for Intel® Pentium® 4/Northwood/Willamette CPUs with speeds up to 2.8+GHz Supports Intel® Hyper-Threading Technology
Chipset	NorthBridge: VIA® VT8751A SouthBridge: VIA® VT8235
Front Side Bus (FSB)	533/400 MHz
Memory	2 x 184-pin DDR DIMM sockets for up to 2GB memory Supports PC2100/PC1600 unbuffered non-ECC DDR DIMMs
VGA	Integrated VIA ProSavage8 Graphics
Expansion slots	1 x AGP 4X 3 x PCI
Storage	2 x UltraDMA 133/100/66/33 connectors
Audio	Realtek ALC655 6-channel audio CODEC
LAN	VIA VT8235 integrated MAC + VIA VT6103 PHY
Rear panel I/O	1 x Parallel port 1 x Serial port 1 x VGA port 1 x PS/2 keyboard port 1 x PS/2 mouse port 4 x USB 2.0 ports 1 x RJ-45 port Line In/Line Out/Microphone ports
Internal I/O	1 x USB 2.0 connector for 2 additional USB ports CPU/Chassis fan connectors 20-pin ATX 12V power connectors CD/AUX connectors Front panel audio connector
BIOS features	2Mb Flash ROM, AMI BIOS, ACPI, PnP, SM BIOS 2.3, DMI2.0
Industry standard	PCI 2.2, USB 2.0/1.1
Manageability	WfM 2.0, DMI 2.0, WOL/WOR by PME, SMBus
Form Factor	ATX form factor: 9.6 in x 8.0 in (24.5 cm x 20.5 cm)
Support CD contents	Device drivers ASUS PC Probe ASUS LiveUpdate Trend Micro™ PC-cillin 2002 anti-virus software

Chapter 1

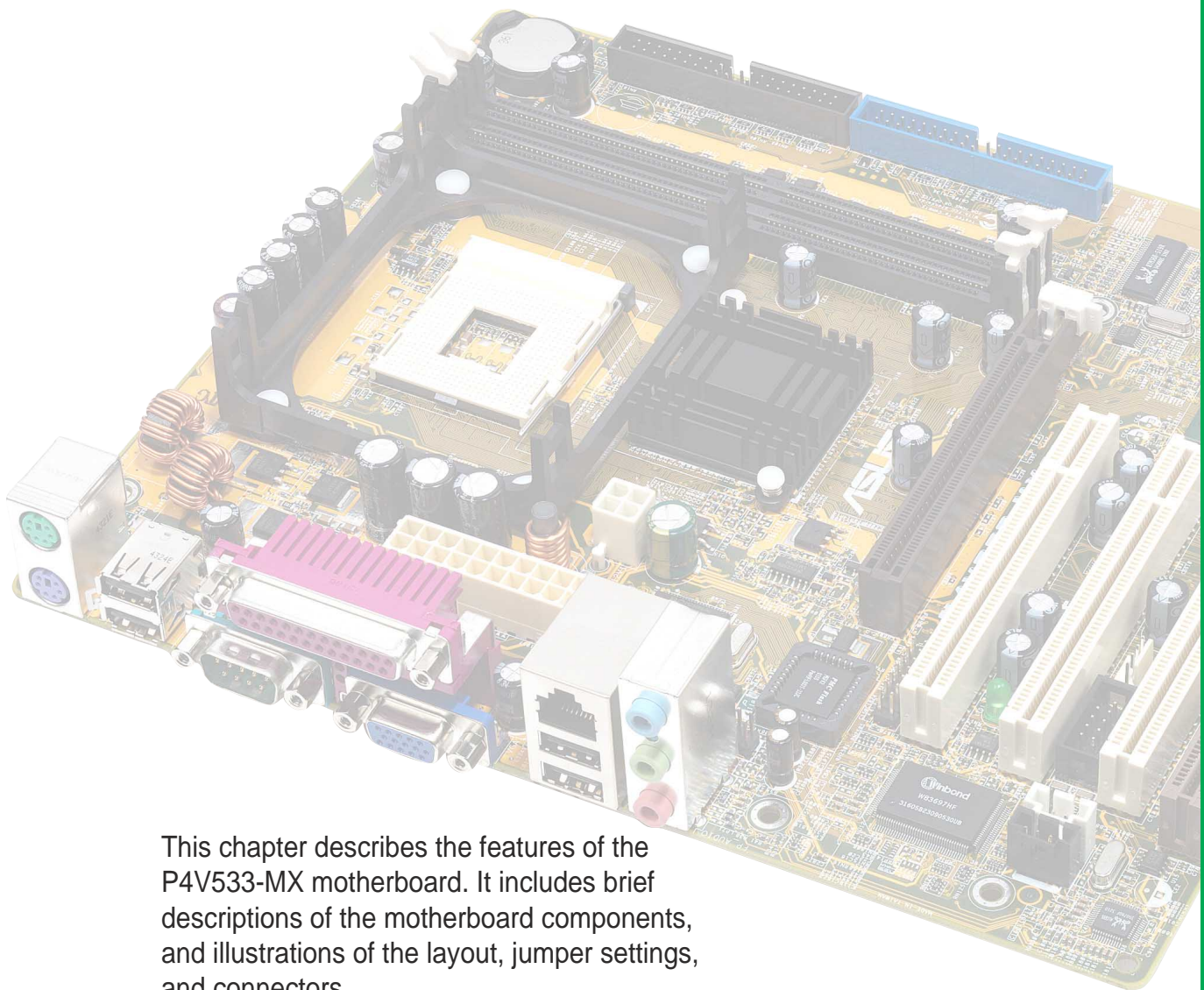

This chapter describes the features of the P4V533-MX motherboard. It includes brief descriptions of the motherboard components, and illustrations of the layout, jumper settings, and connectors.

Product introduction

1.1 Welcome!

Thank you for buying the ASUS® P4V533-MX motherboard!

The ASUS P4V533-MX motherboard delivers a host of new features and latest technologies making it another standout in the long line of ASUS quality motherboards!

The P4V533-MX incorporates the Intel® Pentium® 4 Processor in 478-pin package with support for Intel®'s Hyper-Threading Technology, coupled with the VIA® VT8751A and VIA® VT8235 chipsets to set a new benchmark for an effective desktop platform solution.

Supporting up to 2GB of system memory with PC2100/PC1600 DDR SDRAM, high-resolution graphics via integrated VIA ProSavage8 graphics and an AGP 4X slot, USB 2.0, and 6-channel audio features, the P4V533-MX is your affordable vehicle to enter the world of computing!

Before you start installing the motherboard, and hardware devices on it, check the items in your package with the list below.

1.2 Package contents

Check your P4V533-MX package for the following items.

- ✓ ASUS P4V533-MX motherboard
- ✓ ASUS P4V533-MX series support CD
- ✓ 1 x UltraDMA 133/100/66/33 cable
- ✓ 1 x Floppy disk cable
- ✓ I/O shield
- ✓ Bag of extra jumper caps
- ✓ User Guide



If any of the above items is damaged or missing, contact your retailer.

1.3 Special features

Latest processor technology

The P4V533-MX motherboard supports the latest Intel® Pentium® 4 Processor via a 478-pin surface mount ZIF socket. The Pentium 4 processor with 512KB L2 cache on 0.13 micron process includes a 533/400 MHz system bus and features the new Hyper-Threading technology and FMB2 power design that allow up to 2.8+ GHz core frequencies for up to 4.2GB/s data transfer rates. See page 1-10.

Integrated VIA ProSavage8 Graphics

The VIA® chipset integrates the VIA® ProSavage8 Graphics architecture to deliver realistic 3D/2D graphics with sharp images, fast rendering, smooth motion, and clearly defined details. See page 1-6.

Integrated 10/100 LAN

The VIA® VT8235 SouthBridge integrated MAC with the VIA® VT6103 PHY provides easy implementation of 10/100 Mbps Fast Ethernet LANs. See page 1-5.

USB 2.0 technology

The motherboard implements the new Universal Serial Bus (USB) 2.0 specification, extending the connection speed from 12 Mbps on USB 1.1 to a fast 480 Mbps on USB 2.0. See pages 1-6 and 1-20.

6-channel digital audio

The Realtek ALC655 AC'97 audio CODEC is onboard to provide 6-channel audio playback for 5.1 surround sound. See page 1-6.

BONUS!

Free bundled TrendMicro™ PC-cillin 2002 anti-virus software (OEM version)

1.4 Motherboard components

Before you install the motherboard, learn about its major components and available features to facilitate the installation and future upgrades. Refer to the succeeding pages for the component descriptions.

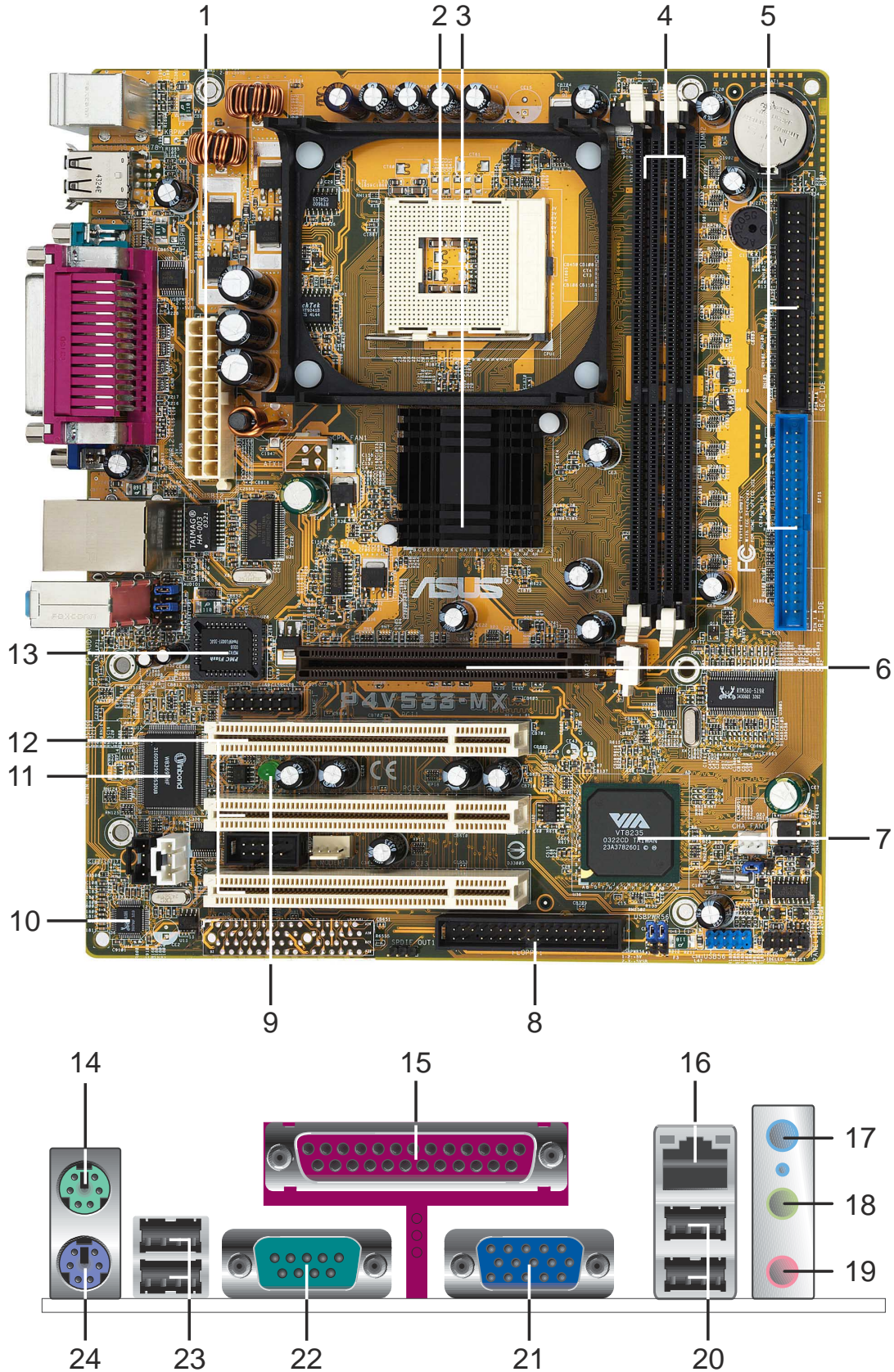

- 1 ATX power connector.** This 20-pin connector connects to an ATX power supply.
- 2 CPU socket.** A 478-pin surface mount, Zero Insertion Force (ZIF) socket for the Intel® Pentium® 4 Processor, with 533/400 MHz system bus that allows 4.2GB/s, and 3.2GB/s data transfer rates, respectively.
- 3 North bridge controller.** The VIA® VT8751A provides the processor interface with 533/400 MHz frequency, support for Intel® Hyper-Threading Technology, system memory interface at 266MHz operation, and 1.5V AGP interface that supports AGP 2.0 specification including 4X Fast Write protocol.
- 4 DDR DIMM sockets.** These two 184-pin DIMM sockets support up to 2GB system memory using unbuffered non-ECC PC2100/PC1600 DDR DIMMs.
- 5 IDE connectors.** These dual-channel bus master IDE connectors support Ultra DMA133/100/66/33, PIO Modes 3 & 4 IDE devices. Both the primary (blue) and secondary (black) connectors are slotted to prevent incorrect insertion of the IDE ribbon cable.
- 6 AGP 4X slot.** This Accelerated Graphics Port (AGP) slot supports 1.5V AGP 4X mode graphics cards for 3D graphical applications.
- 7 South bridge controller.** The VIA® VT8235 integrated peripheral controller supports various I/O functions including 2-channel ATA/133 bus master IDE controller, up to six USB 2.0 ports, LPC Super I/O interface, AC'97 interface and PCI 2.2 interface.
- 8 Floppy disk connector.** This connector accommodates the provided ribbon cable for the floppy disk drive. One side of the connector is slotted to prevent incorrect insertion of the floppy disk cable.
- 9 Standby power LED.** This LED lights up if there is a standby power on the motherboard. This LED acts as a reminder to turn off the system power before plugging or unplugging devices.
- 10 Audio CODEC.** The Realtek ALC655 is an AC'97 CODEC that allows 6-channel audio playback.
- 11 Super I/O controller.** This Low Pin Count (LPC) interface provides the commonly used Super I/O functionality. The chipset supports a high-performance floppy disk controller for a 360K/720K/1.44M/2.88M floppy disk drive, a multi-mode parallel port, a Game/MIDI port and a standard compatible UART.
- 12 PCI slots.** These 32-bit PCI 2.2 expansion slots support bus master PCI cards like SCSI or LAN cards with 133MB/s maximum throughput.
- 13 Flash ROM.** This 2Mb firmware contains the programmable BIOS program.
- 14 PS/2 mouse port.** This green 6-pin connector is for a PS/2 mouse.
- 15 Parallel port.** This 25-pin port connects a parallel printer, a scanner, or other devices.
- 16 RJ-45 port.** This port allows connection to a Local Area Network (LAN) through a network hub.

- 17** **Line In jack.** This Line In (light blue) jack connects a tape player or other audio sources. In 6-channel mode, the function of this jack becomes Bass/Center.
- 18** **Line Out jack.** This Line Out (lime) jack connects a headphone or a speaker. In 6-channel mode, the function of this jack becomes Front Speaker Out.
- 19** **Microphone jack.** This Mic (pink) jack connects a microphone. In 6-channel mode, the function of this jack becomes Rear Speaker Out.



The functions of the Line Out, Line In, and Microphone jacks change when you select the 6-channel audio configuration as shown in the following table:

Audio 2, 4 or 6-channel configuration

	Headphone/ 2-Speaker	4-Speaker	6-Speaker
Light Blue	Line In	Rear Speaker Out	Rear Speaker Out
Lime	Line Out	Front Speaker Out	Front Speaker Out
Pink	Mic In	Mic In	Bass/Center

- 20** **USB 2.0 ports 1 and 2.** These two 4-pin Universal Serial Bus (USB) ports are available for connecting USB 2.0 devices.
- 21** **Video Graphics Adapter port.** This 15-pin port is for a VGA monitor or other VGA-compatible devices.
- 22** **Serial port.** This 9-pin COM1 port is for pointing devices or other serial devices.
- 23** **USB 2.0 ports 3 and 4.** These two 4-pin Universal Serial Bus (USB) ports are available for connecting USB 2.0 devices.
- 24** **PS/2 keyboard port.** This purple connector is for a PS/2 keyboard.

1.5 Motherboard layout

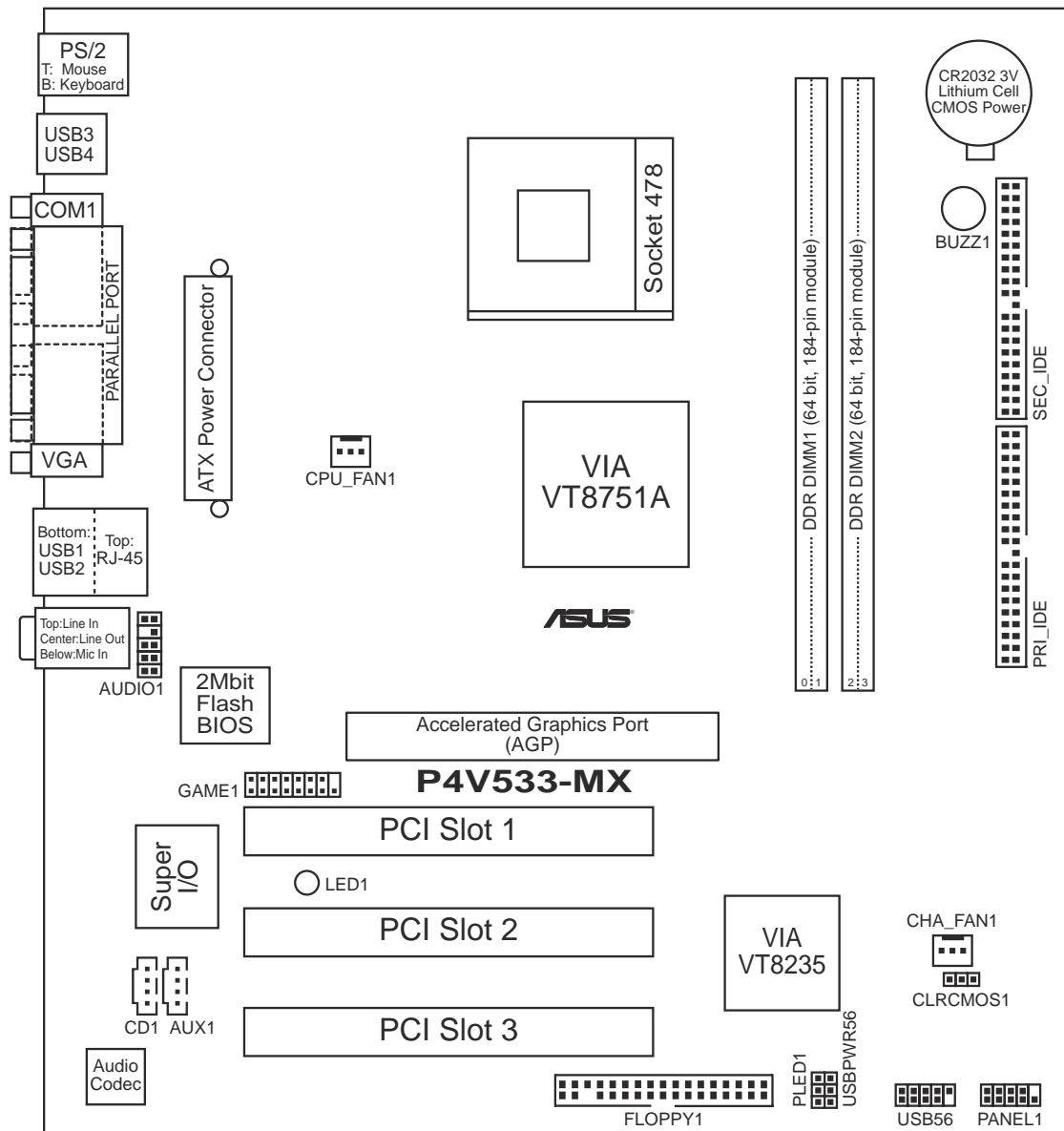

1.6 Before you proceed

Take note of the following precautions before you install motherboard components or change any motherboard settings.



1. Unplug the power cord from the wall socket before touching any component.
2. Use a grounded wrist strap or touch a safely grounded object or to a metal object, such as the power supply case, before handling components to avoid damaging them due to static electricity.
3. Hold components by the edges to avoid touching the ICs on them.
4. Whenever you uninstall any component, place it on a grounded antistatic pad or in the bag that came with the component.
5. **Before you install or remove any component, ensure that the ATX power supply is switched off or the power cord is detached from the power supply.** Failure to do so may cause severe damage to the motherboard, peripherals, and/or components.

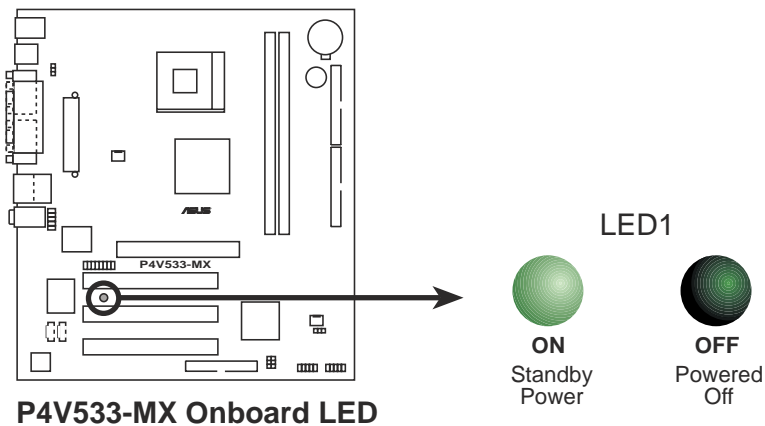

1.7 Motherboard installation

Before you install the motherboard, study the configuration of your chassis to ensure that the motherboard fits into it. The motherboard uses the micro-ATX form factor that measures 9.6 inches x 8.0 inches (24.5 cm x 20.5 cm).



Make sure to unplug the power cord before installing or removing the motherboard. Failure to do so may cause you physical injury and damage motherboard components.

1.7.1 Placement direction

When installing the motherboard, make sure that you place it into the chassis in the correct orientation. The edge with external ports goes to the rear part of the chassis as indicated in the image below.

1.7.2 Screw holes

Place seven (7) screws into the holes indicated by circles to secure the motherboard to the chassis.



Do not overtighten the screws! Doing so may damage the motherboard.

Place this side towards
the rear of the chassis

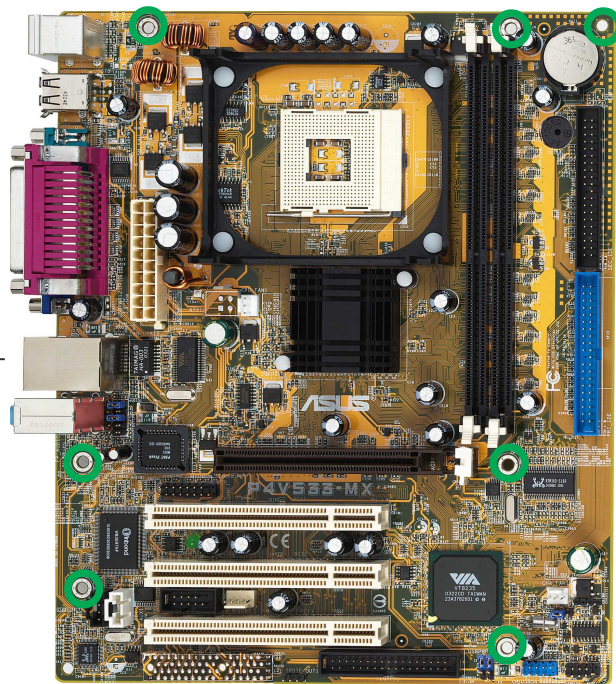

1.8 Central Processing Unit (CPU)

1.8.1 Overview

The motherboard comes with a surface mount 478-pin Zero Insertion Force (ZIF) socket. The socket is designed for the Intel® Pentium® 4 Processor in the 478-pin package with 512KB L2 cache. This processor supports 533/400MHz front side bus (FSB), and allows data transfer rates of up to 4.3GB/s.

Note in the illustration that the CPU has a gold triangular mark on one corner. This mark indicates the processor Pin 1 that should match a specific corner of the CPU socket.

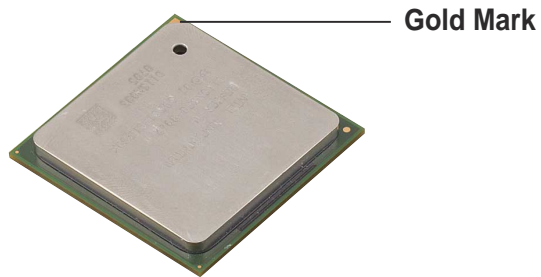

Incorrect installation of the CPU into the socket may bend the pins and severely damage the CPU!

Notes on Intel® Hyper-Threading Technology



1. This motherboard supports Intel Pentium 4 CPUs with Hyper-Threading Technology.
 2. It is recommended that you install WinXP Service Pack 1.
 3. For more information on Hyper-Threading Technology, visit www.intel.com/info/hyperthreading.
-

To use the Hyper-Threading Technology on this motherboard:

1. Buy an Intel Pentium 4 CPU that supports Hyper-Threading Technology. Install the CPU. The board will auto-detect the installed CPU with Hyper-Threading support.
2. Boot the computer.

1.8.2 Installing the CPU

Follow these steps to install a CPU.

1. Locate the 478-pin ZIF socket on the motherboard.
2. Unlock the socket by pressing the lever sideways, then lift it up to a 90°-100° angle.



Make sure that the socket lever is lifted up to 90°-100° angle, otherwise the CPU does not fit in completely.

Socket Lever

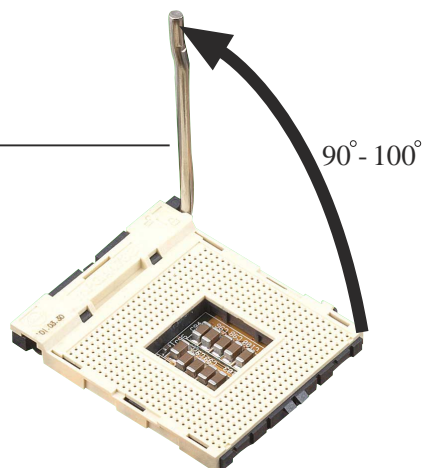

3. Position the CPU above the socket such that its marked corner matches the base of the socket lever.
4. Carefully insert the CPU into the socket until it fits in place.

Gold Mark

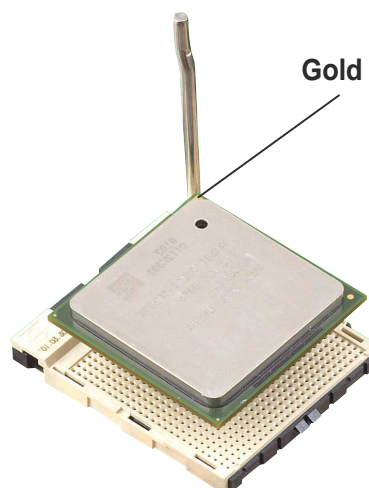

The CPU fits only in one correct orientation. **DO NOT** force the CPU into the socket to prevent bending the pins and damaging the CPU!

5. When the CPU is in place, push down the socket lever to secure the CPU. The lever clicks on the side tab to indicate that it is locked.
6. Install a CPU heatsink and fan following the instructions that came with the heatsink package.
7. Connect the CPU fan cable to the CPU_FAN1 connector on the motherboard.



1.9 System memory

The motherboard comes with two Double Data Rate (DDR) Dual Inline Memory Module (DIMM) sockets. These sockets support up to 2GB system memory using 184-pin unbuffered non-ECC PC2100/PC1600 DDR DIMMs. The following figure shows the location of the DDR DIMM sockets.

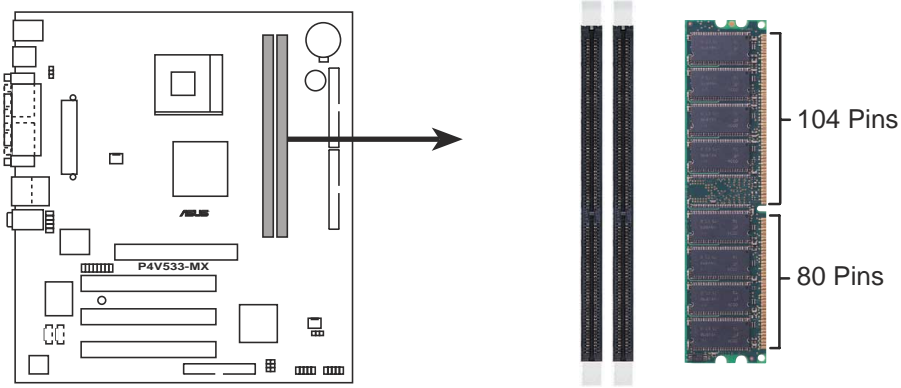

P4V533-MX 184-Pin DDR DIMM Sockets

1.9.1 Installing a DIMM



Make sure to unplug the power supply before adding or removing DIMMs or other system components. Failure to do so may cause severe damage to both the motherboard and the components.

Follow these steps to install a DIMM.

1. Unlock a DIMM socket by pressing the retaining clips outward.
2. Align a DIMM on the socket such that the notch on the DIMM matches the break on the socket.
3. Firmly insert the DIMM into the socket until the retaining clips snap back in place and the DIMM is properly seated.

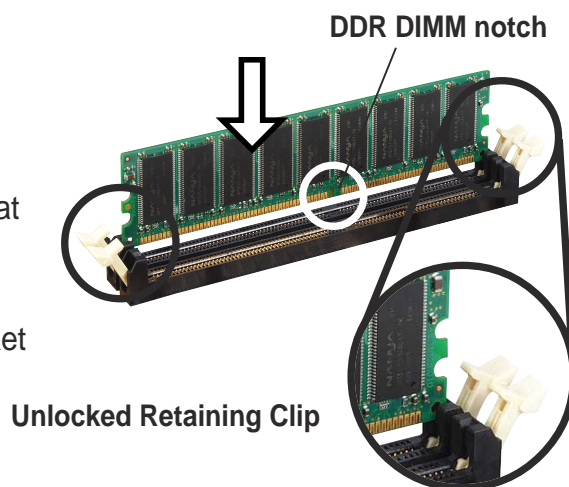

1.10 Expansion slots

The motherboard has three PCI slots and one Accelerated Graphics Port (AGP) slot.

To install and configure an expansion card:

1. Install an expansion card following the instructions that came with the chassis.
2. Turn on the system and change the necessary BIOS settings, if any. See Chapter 2 for BIOS information.
3. Assign an IRQ to the card. Refer to the tables below.
4. Install the drivers and/or software applications for the expansion card according to the card documentation.

1.10.1 Standard interrupt assignments

IRQ	Priority	Standard Function
0	1	System Timer
1	2	Keyboard Controller
2	N/A	Programmable Interrupt
4*	12	Communications Port (COM1)
5*	13	IRQ holder for PCI steering
6	14	Floppy Disk Controller
7*	15	Printer Port (LPT1)
8	3	System CMOS/Real Time Clock
9*	4	IRQ holder for PCI steering
10*	5	Advance AC'97 CODEC
11*	6	Standard PCI Graphics Adapter (VGA)
12*	7	PS/2 Compatible Mouse Port
13	8	Numeric Data Processor
14*	9	Primary IDE Channel
15*	10	Secondary IDE Channel

* These IRQs are usually available for ISA or PCI devices.

1.10.2 IRQ assignments for this motherboard

	A	B	C	D	E	F	G	H
PCI slot 1	—	used	—	—	—	—	—	—
PCI slot 2	—	—	used	—	—	—	—	—
PCI slot 3	—	—	—	used	—	—	—	—
AGP slot	used	—	—	—	—	—	—	—
Onboard USB controller HC0	—	—	—	—	shared	—	—	—
Onboard USB controller HC1	—	—	—	—	shared	—	—	—
Onboard USB controller HC3	—	—	—	—	shared	—	—	—
EHCI	—	—	—	—	shared	—	—	—
Onboard LAN	—	—	—	—	—	used	—	—
Onboard audio	—	—	—	—	—	—	used	—

1.10.3 PCI slots

There are three 32-bit PCI slots on this motherboard. The slots support PCI cards such as a LAN card, SCSI card, USB card, and other cards that comply with PCI specifications.



1.10.4 AGP slot

This motherboard has an Accelerated Graphics Port (AGP) slot that supports AGP 4X (3.3V/1.5V) cards.

Note the notches on the card golden fingers to ensure that they fit the AGP slot on your motherboard.

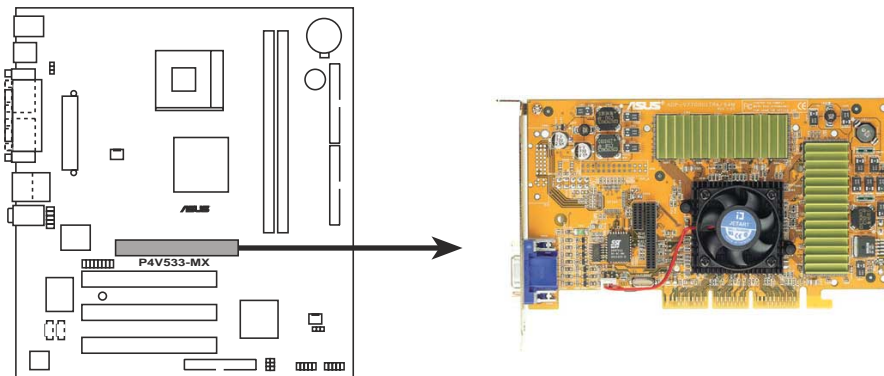

P4V533-MX Accelerated Graphics Port (AGP)

1.11 Jumper

1. Clear RTC RAM (CLRCMOS1)

This jumper allows you to clear the Real Time Clock (RTC) RAM in CMOS. You can clear the CMOS memory of date, time, and system setup parameters by erasing the CMOS RTC RAM data. The RAM data in CMOS, that include system setup information such as system passwords, is powered by the onboard button cell battery.

To erase the RTC RAM:

1. Turn OFF the computer and unplug the power cord.
2. Move the jumper cap from pins 1-2 (default) to pins 2-3. Keep the cap on pins 2-3 for about 5~10 seconds, then move the cap back to pins 1-2.
3. Plug the power cord and turn ON the computer.
4. Hold down the key during the boot process and enter BIOS setup to re-enter data.



Except when clearing the RTC RAM, never remove the cap on CLRTC1 jumper default position. Removing the cap will cause system boot failure!

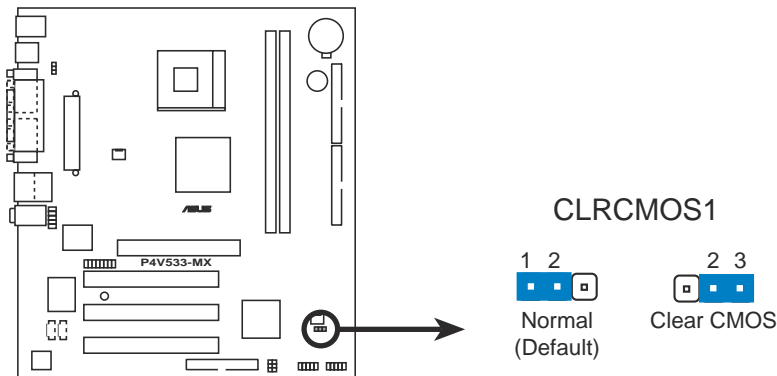

P4V533-MX Clear RTC RAM Setting

2. USB device wake-up (3-pin USBPWR56)

Set these jumpers to +5V to wake up the computer from S1 sleep mode (CPU stopped, DRAM refreshed, system running in low power mode) using the connected USB devices. Set to +5VSB to wake up from S3 sleep mode (no power to CPU, DRAM in slow refresh, power supply in reduced power mode). The USBPWR56 jumpers are for the internal USB header that you can connect to the front USB ports.



1. This feature requires a power supply that can provide at least 1A on the +5VSB lead when these jumpers are set to +5VSB. Otherwise, the system does not power up.
2. The total current consumed must NOT exceed the power supply capability (+5VSB) whether under normal or in sleep mode.

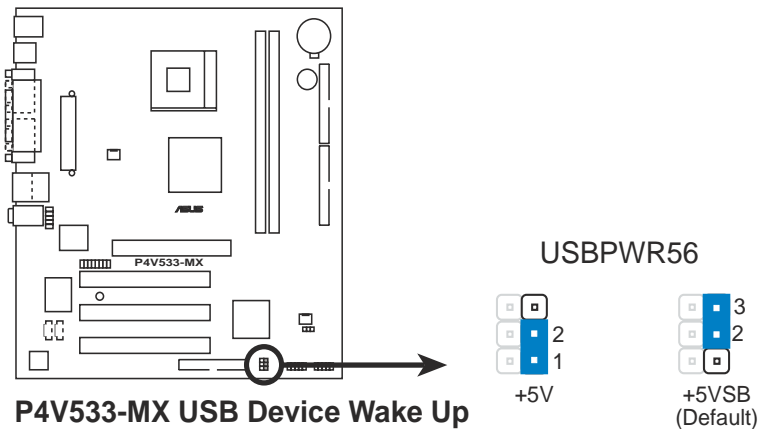

1.12 Connectors

This section describes and illustrates the internal connectors on the motherboard.

1. Floppy disk drive connector (34-1 pin FLOPPY1)

This connector supports the provided floppy drive ribbon cable. After connecting one end to the motherboard, connect the other end to the floppy drive. (Pin 5 is removed to prevent incorrect insertion when using ribbon cables with pin 5 plug).

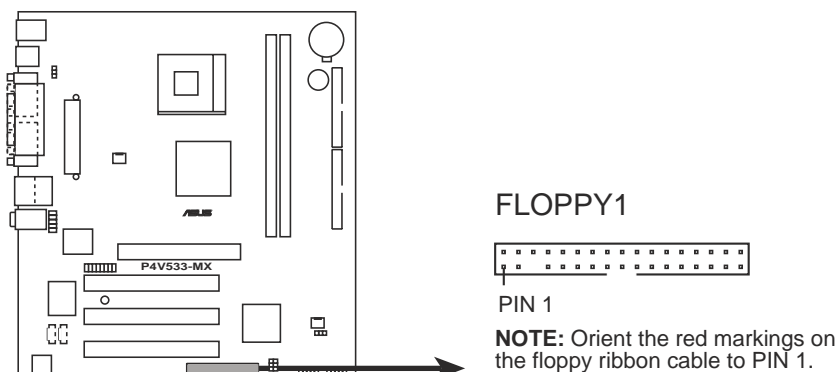

P4V533-MX Floppy Disk Drive Connector

2. GAME/MIDI connector (16-1 pin GAME1)

This connector supports a GAME/MIDI module. Connect the GAME/MIDI cable with yellow connector to the yellow header on board. The GAME/MIDI port on the module connects a joystick or a game pad for playing games, and MIDI devices for playing or editing audio files.

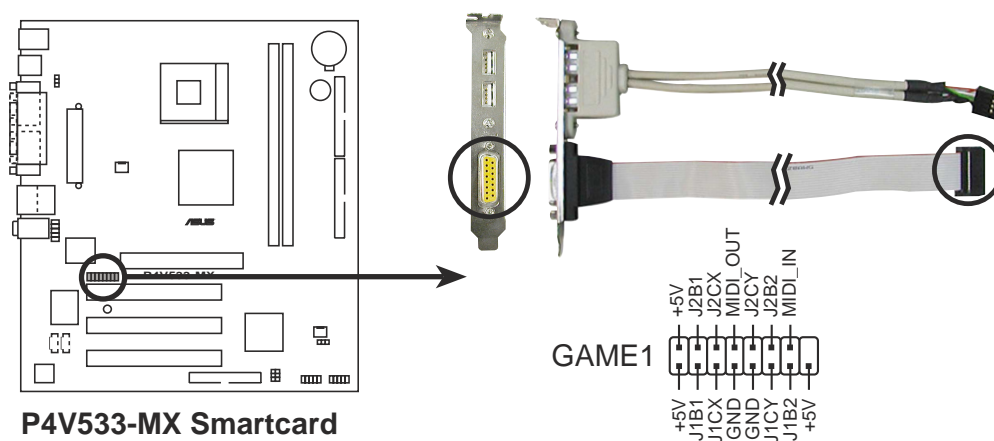

P4V533-MX Smartcard



The GAME/MIDI module is purchased separately.

3. IDE connectors (40-1 pin PRI_IDE, SEC_IDE)

This connector supports the provided UltraDMA133/100 IDE ribbon cable. Connect the cable's blue connector to the primary (recommended) or secondary IDE connector, then connect the gray connector to the UltraDMA133/100 slave device (hard disk drive) and the black connector to the UltraDMA133/100 master device. It is recommended that you connect non-UltraDMA133/100 devices to the secondary IDE connector. If you install two hard disks, you must configure the second drive as a slave device by setting its jumper accordingly. Refer to the hard disk documentation for the jumper settings. BIOS supports specific device bootup. If you have more than two UltraDMA133/100 devices, purchase another UltraDMA133/100 cable. You may configure two hard disks to be both master devices with two ribbon cables – one for the primary IDE connector and another for the secondary IDE connector.



1. Pin 20 on each IDE connector is removed to match the covered hole on the UltraDMA cable connector. This prevents incorrect orientation when you connect the cables.
2. The hole near the blue connector on the UltraDMA133/100/66 cable is intentional.
3. For UltraDMA133/100/66 IDE devices, use the 80-conductor IDE cable.

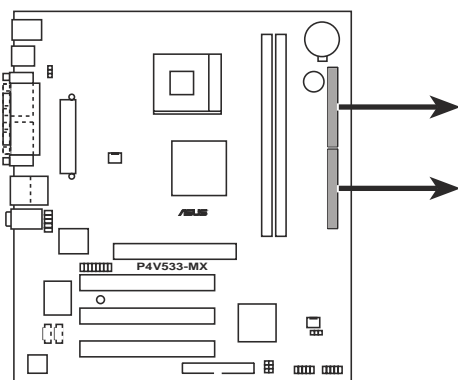

P4V533-MX IDE Connectors

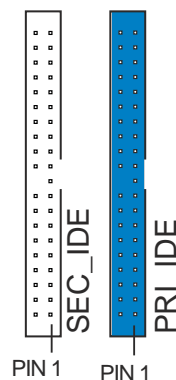

NOTE: Orient the red markings on the IDE ribbon cable to PIN 1

4. ATX power connectors (20-pin ATXPWR1)

These connectors connect to an ATX 12V power supply. The plugs from the power supply are designed to fit these connectors in only one orientation. Find the proper orientation and push down firmly until the connectors completely fit.



Make sure that your ATX 12V power supply can provide 8A on the +12V lead and at least 1A on the +5-volt standby lead (+5VSB). The minimum recommended wattage is 230W, or 300W for a fully configured system. The system may become unstable and may experience difficulty powering up if the power supply is inadequate.

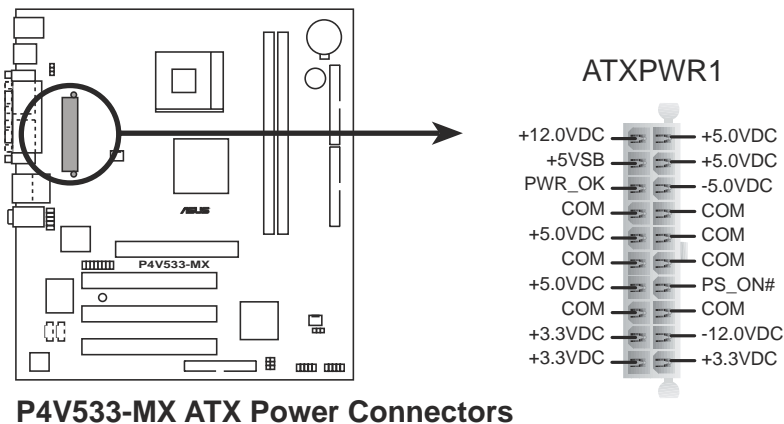

P4V533-MX ATX Power Connectors

5. CPU and chassis fan connectors (3-pin CPU_FAN1, CHA_FAN1)

The fan connectors support cooling fans of 350mA~740mA (8.88W max.) or a total of 1A~2.22A (26.64W max.) at +12V. Connect the fan cables to the fan connectors on the motherboard, making sure that the black wire of each cable matches the ground pin of the connector.



Do not forget to connect the fan cables to the fan connectors. Lack of sufficient air flow within the system may damage the motherboard components. These are not jumpers! DO NOT place jumper caps on the fan connectors!

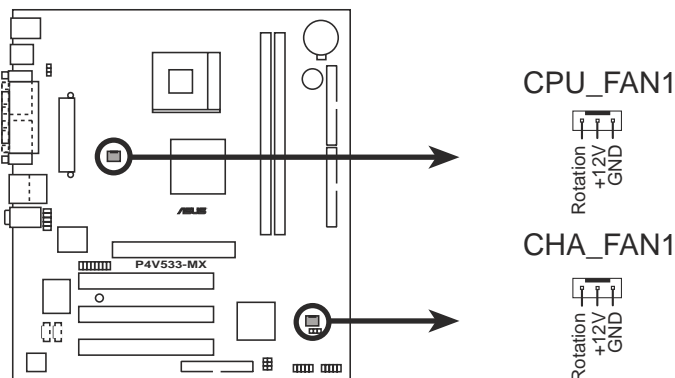

P4V533-MX 12-Volt Cooling Fan Power

6. Internal audio connectors (4-pin CD IN, AUX IN)

These connectors allow you to receive stereo audio input from sound sources such as a CD-ROM, TV tuner, or MPEG card.

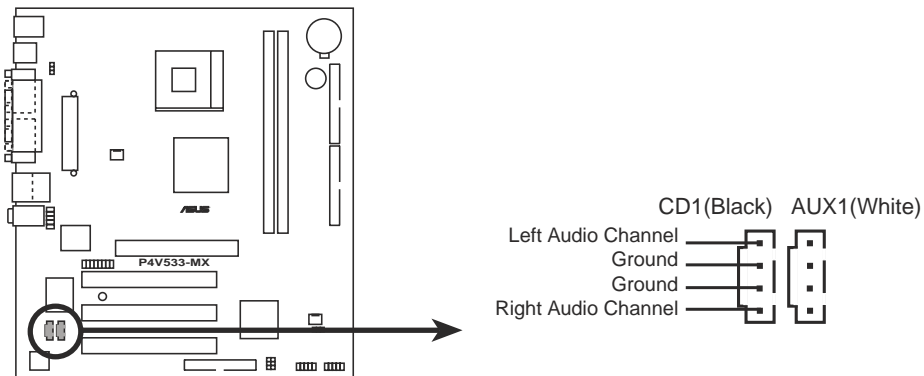

P4V533-MX Internal Audio Connectors

7. USB header (10-1 pin USB56)

If the USB ports on the rear panel are inadequate, two USB headers are available for additional USB ports. The USB header complies with USB 2.0 specification that supports up to 480 Mbps connection speed. This speed advantage over the conventional 12 Mbps on USB 1.1 allows faster Internet connection, interactive gaming, and simultaneous running of high-speed peripherals.

Connect an optional USB 2.0/GAME module to this header. The module has two USB 2.0 ports that support the next generation USB peripherals such as high resolution cameras, scanners, and printers.



You must install the driver before you can use the USB 2.0 capability.

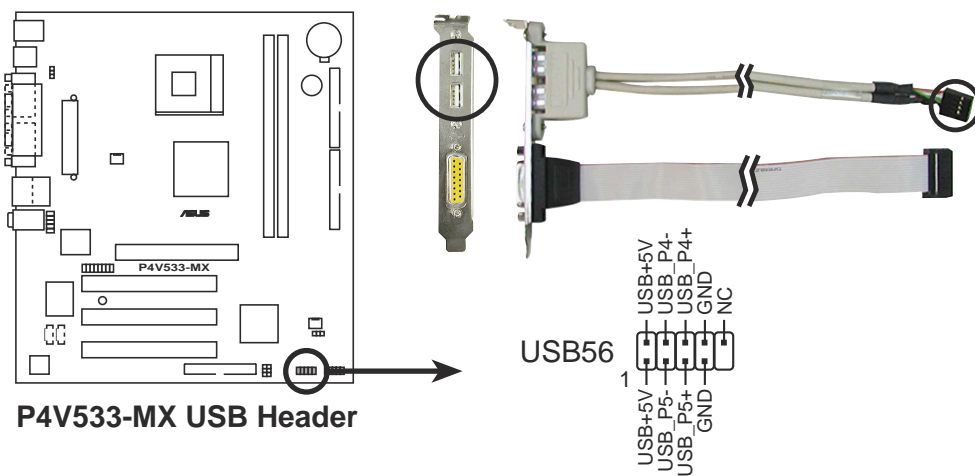

P4V533-MX USB Header



The USB2.0 module is purchased separately.

8. System Power LED connector (3-pin PWLED1)

This 3-pin connector connects to the system power LED. If your case supports a 3-pin connector, use this connector instead of the power LED connector in the system panel.

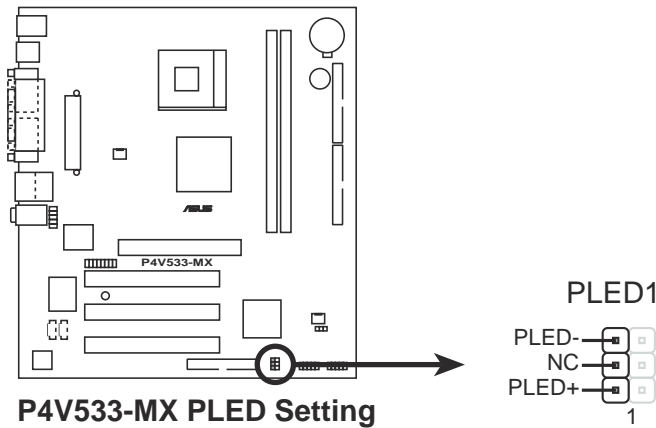

The 3-pin power LED connector is available only from motherboard PCB 1.03 or later versions. The motherboard PCB version is located as a subscript beside the motherboard model name.

9. Front panel audio connector (10-1 pin FP_AUDIO)

This is an interface for the Intel front panel audio cable that allow convenient connection and control of audio devices.

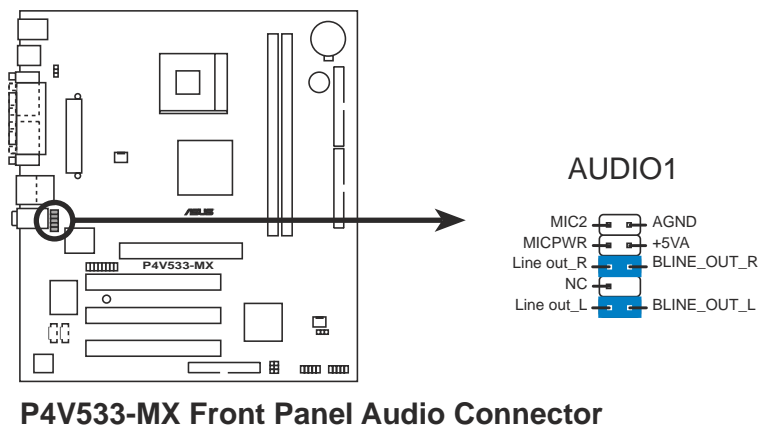

10. System panel connector (10-1 pin PANEL1)

This connector accommodates several system front panel functions.

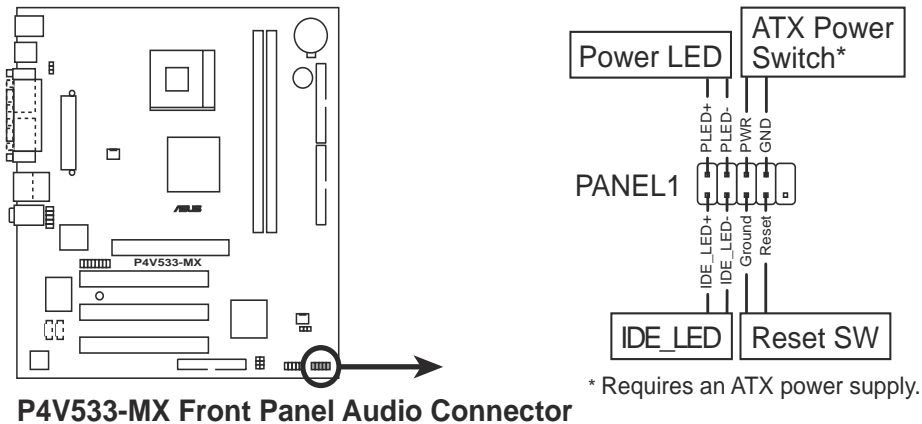

- **System Power LED Lead (2-pin PWR LED)**

This 2-1 pin connector connects to the system power LED. The LED lights up when you turn on the system power, and blinks when the system is in sleep mode.

- **Hard disk activity LED (2-pin HD LED)**

This 2-pin connector supplies power to the hard disk activity LED. The read and write activities of any device connected to the primary or secondary IDE connector cause this LED to light up.

- **ATX Power Switch / Soft-Off Switch Lead (2-pin PWR BTN)**

This connector connects a switch that controls the system power. Pressing the power switch turns the system between ON and SLEEP, or ON and SOFT OFF, depending on the BIOS or OS settings. Pressing the power switch while in the ON mode for more than 4 seconds turns the system OFF.

- **Reset Switch Lead (2-pin RESET)**

This 2-pin connector connects to the case-mounted reset switch for rebooting the system without turning off the system power.

Important Note:

A system buzzer (BUZZ1) is added to the motherboard. The system buzzer allows you to hear system warning beeps when a PC speaker is not available.

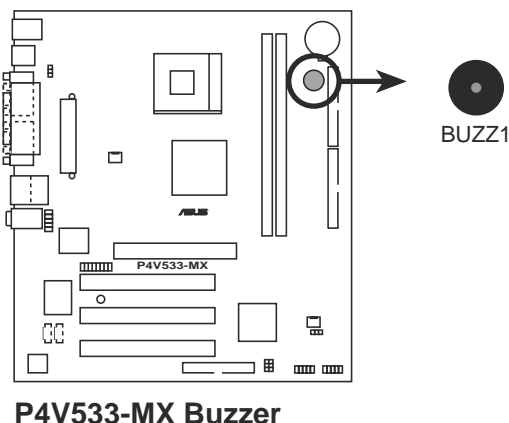

Chapter 2

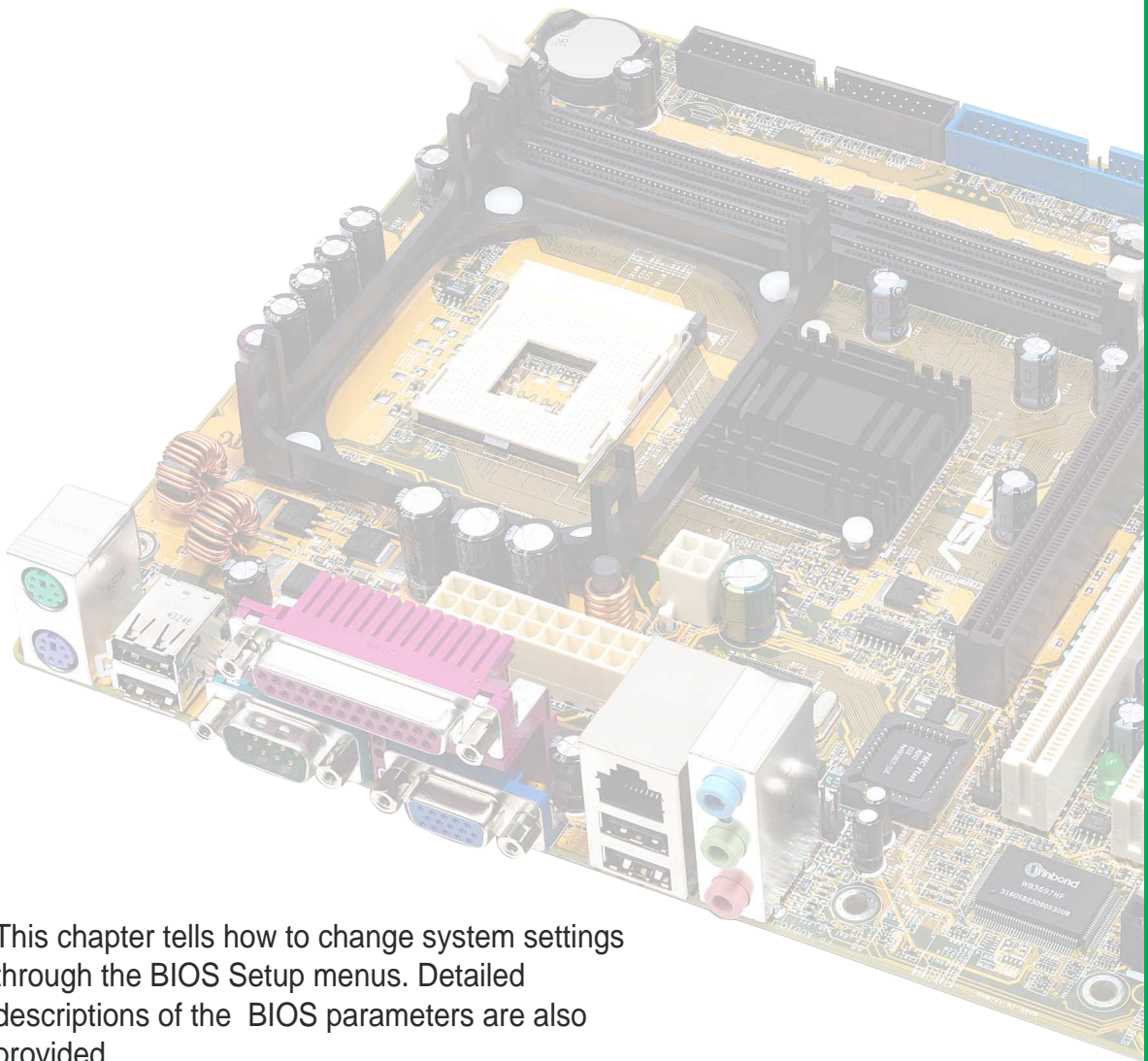

This chapter tells how to change system settings through the BIOS Setup menus. Detailed descriptions of the BIOS parameters are also provided.

BIOS information

2.1 Managing and updating your BIOS

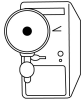

The **original BIOS file** for this motherboard is in the support CD.

Copy the original BIOS to a **bootable floppy disk** in case you need to restore the BIOS in the future.

2.1.1 Creating a bootable floppy disk

1. Do either one of the following to create a bootable floppy disk.

DOS environment

Insert a 1.44 MB floppy disk into the drive. At the DOS prompt, type:

```
format A:/S <Enter>
```

Windows environment

- a. From your Windows desktop, click on **Start**, point to **Settings**, then click on **Control Panel**.
 - b. Double-click on **Add/Remove Programs** icon from the Control Panel window.
 - c. Click on the **Startup Disk** tab, then on **Create Disk...** button.
 - d. Insert a 1.44 MB floppy disk when prompted. Follow the succeeding screen instructions to complete the process.
2. Copy the original (or the latest) motherboard BIOS to the bootable floppy disk.

2.1.2 Using AFUDOS to update the BIOS

Update the BIOS using the AFUDOS.EXE utility in DOS environment.

1. Visit the ASUS website (www.asus.com) to download the latest BIOS file for your motherboard. Save the BIOS file to a bootable floppy disk.



Write down the BIOS file name to a piece of paper. You need to type the **exact BIOS file name** at the prompt.

2. Copy the AFUDOS.EXE utility from the support CD to the bootable floppy disk that contains the BIOS file.
3. Boot the system from the floppy disk.

4. At the DOS prompt, type the command line:

afudos /i<filename.rom>

where “filename.rom” means the latest (or original) BIOS file that you copied to the bootable floppy disk.

The screen displays the status of the update process.

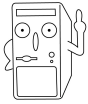

The BIOS information on the screen is for reference only. What you see on your screen may not be exactly the same as shown.

```
A:\>afudos /ip4v533-mx.rom
AMI Firmware Update Utility - Version 1.10
Copyright (C) 2002 American Megatrends, Inc. All rights reserved.

Reading file ..... done
Erasing flash .... done
Writing flash .... 0x0008CC00 (9%)
```



DO NOT shutdown or reset the system while updating the BIOS! Doing so may cause system boot failure!

When the BIOS update process is complete, the utility returns to the DOS prompt.

```
A:\>afudos /ip4v533-mx.rom
AMI Firmware Update Utility - Version 1.10
Copyright (C) 2002 American Megatrends, Inc. All rights reserved.

Reading file ..... done
Erasing flash .... done
Writing flash .... 0x0008CC00 (9%)
Verifying flash .. done

A:\>
```

5. Reboot the system from the hard disk.

2.2 BIOS Setup program

This motherboard supports a programmable firmware hub (FWH) that you can update using the provided utility described in section “2.1 Managing and updating your BIOS.”

Use the BIOS Setup program when you are installing a motherboard, reconfiguring your system, or prompted to “Run Setup”. This section explains how to configure your system using this utility.

Even if you are not prompted to use the Setup program, you may want to change the configuration of your computer in the future. For example, you may want to enable the security password feature or change the power management settings. This requires you to reconfigure your system using the BIOS Setup program so that the computer can recognize these changes and record them in the CMOS RAM of the firmware hub.

The firmware hub on the motherboard stores the Setup utility. When you start up the computer, the system provides you with the opportunity to run this program. Press <Delete> during the Power-On Self Test (POST) to enter the Setup utility. Otherwise, POST continues with its test routines.

If you wish to enter Setup after POST, restart the system by pressing <Ctrl> + <Alt> + <Delete>, or by pressing the reset button on the system chassis. You can also restart by turning the system off and then back on. Do this last option only if the first two failed.

The Setup program is designed to make it as easy to use as possible. It is a menu-driven program, which means you can scroll through the various sub-menus and make your selections from the available options using the navigation keys.

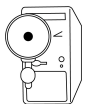

If the system becomes unstable after changing any BIOS settings, load the default settings to ensure system stability. Select the **Load Default Settings** item under the Exit Menu. See section “2.7 Exit Menu.”



The BIOS setup screens shown in this chapter are for reference purposes only, and may not exactly match what you see on your screen.

Visit the ASUS website (www.asus.com) to download the latest product and BIOS information.

2.2.1 BIOS menu screen

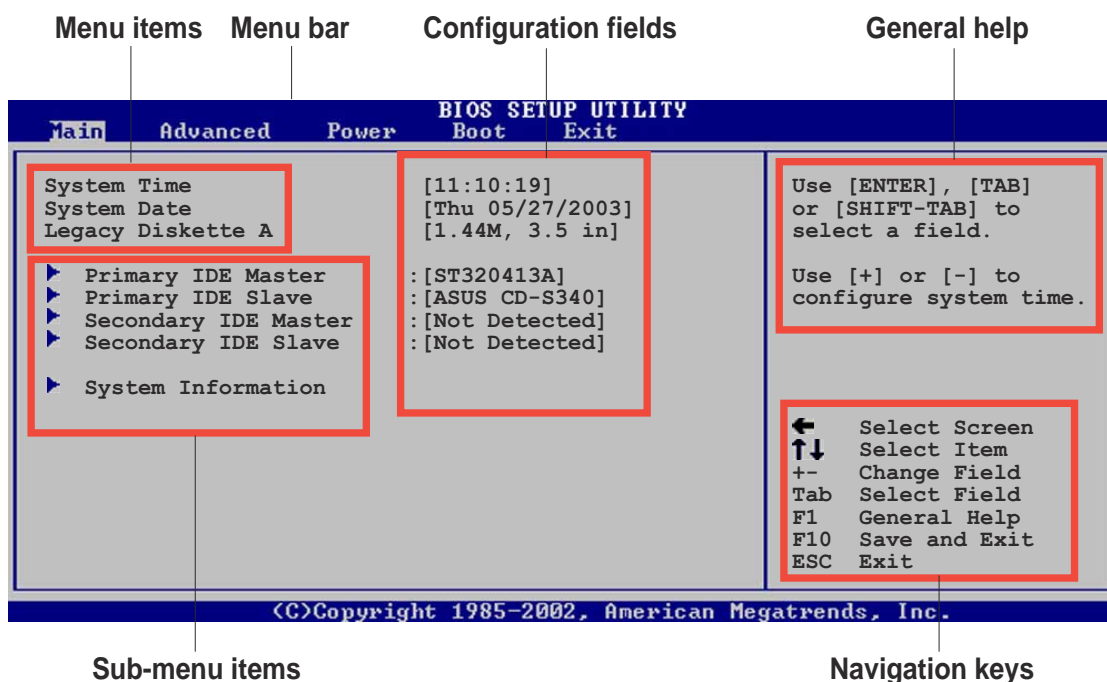

2.2.2 Menu bar

The menu bar on top of the screen has the following main items:

Main	For changing the basic system configuration
Advanced	For changing the advanced system settings
Power	For changing the advanced power management (APM) configuration
Boot	For changing the system boot configuration
Exit	For selecting the exit options and loading default settings

To select an item on the menu bar, press the right or left arrow key on the keyboard until the desired item is highlighted.

2.2.3 Navigation keys

At the **bottom right corner** of a menu screen are the navigation keys for that particular menu. Use the navigation keys to select items in the menu and change the settings.



Some of the navigation keys differ from one screen to another.

2.2.4 Menu items

The highlighted item on the menu bar displays the specific items for that menu. For example, selecting **Main** shows the Main menu items.

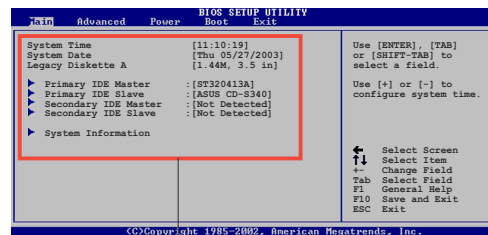

Main menu items

The other items (Advanced, Power, Boot, and Exit) on the menu bar have their respective menu items.

2.2.5 Sub-menu items

An item with a sub-menu on any menu screen is distinguished by a solid triangle before the item. To display the sub-menu, select the item and press Enter.

2.2.6 Configuration fields

These fields show the values for the menu items. If an item is user-configurable, you may change the value of the field opposite the item. You can not select an item that is not user-configurable.

A configurable field is enclosed in brackets, and is highlighted when selected. To change the value of a field, select it then press Enter to display a list of options. Refer to “2.2.7 Pop-up window.”

2.2.7 Pop-up window

Select a menu item then press Enter to display a pop-up window with the configuration options for that item.

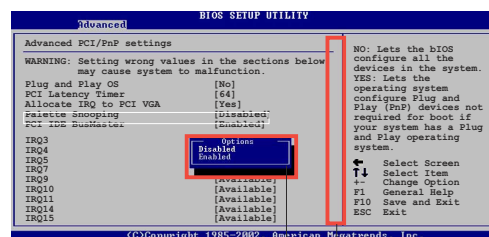

Pop-up window

Scroll bar

2.2.8 Scroll bar

A scroll bar appears on the right side of a menu screen when there are items that do not fit on the screen. Press **Up/Down arrow keys** or **PageUp/PageDown keys** to display the other items on the screen.

2.2.9 General help

At the top right corner of the menu screen is a brief description of the selected item.

2.3 Main menu

When you enter the BIOS Setup program, the Main menu screen appears giving you an overview of the basic system information.



Refer to section “2.2.1 BIOS menu screen” for information on the menu screen items and how to navigate through them.

```
BIOS SETUP UTILITY
Main  Advanced  Power  Boot  Exit

System Time           [11:10:19]
System Date           [Thu 05/27/2003]
Legacy Diskette A     [1.44M, 3.5 in]

▶ Primary IDE Master   : [ST320413A]
▶ Primary IDE Slave    : [ASUS CD-S340]
▶ Secondary IDE Master : [Not Detected]
▶ Secondary IDE Slave  : [Not Detected]
▶ System Information

Use [ENTER], [TAB]
or [SHIFT-TAB] to
select a field.

Use [+] or [-] to
configure system time.

← Select Screen
↑↓ Select Item
+- Change Field
Tab Select Field
F1 General Help
F10 Save and Exit
ESC Exit

(C)Copyright 1985-2002, American Megatrends, Inc.
```

2.3.1 System Time [xx:xx:xxxx]

This item allows you to set the system time.

2.3.2 System Date [Day xx/xx/xxxx]

This item allows you to set the system date.

2.3.3 Legacy Diskette A, B [1.44M, 3.5 in.]

Sets the type of floppy drive installed. Configuration options: [Disabled]
[360K, 5.25 in.] [1.2M, 5.25 in.] [720K, 3.5 in.] [1.44M, 3.5 in.] [2.88M, 3.5 in.]

2.3.4 Primary/Secondary/Third/Fourth IDE Master/Slave

While entering Setup, BIOS auto-detects the presence of IDE devices. There is a separate sub-menu for each IDE device. Select a device item then press Enter to display the IDE device information.

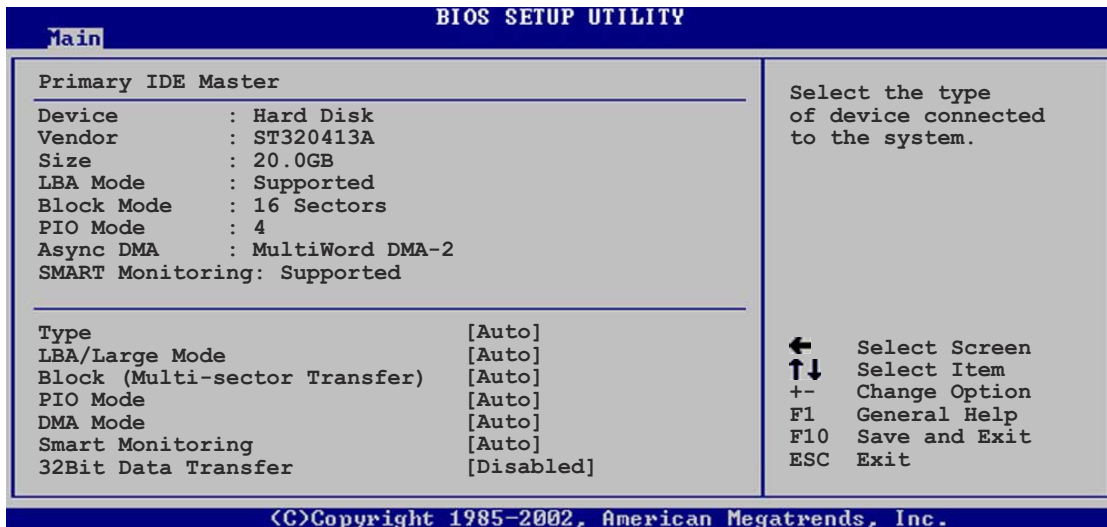

The values opposite the dimmed items (Device, Vendor, Size, LBA Mode, Block Mode, PIO Mode, Async DMA, Ultra DMA, and SMART monitoring) are auto-detected by BIOS and are not user-configurable. These items show N/A if no IDE device is installed in the system.

Type [Auto]

Selects the type of IDE drive. Configuration options: [Not Installed] [Auto] [CDROM] [ARMD]

LBA/Large Mode [Auto]

Enables or disables the LBA mode. Setting to Auto enables the LBA mode if the device supports this mode, and if the device was not previously formatted with LBA mode disabled. Configuration options: [Disabled] [Auto]

Block (Multi-sector Transfer) [Auto]

Enables or disables data multi-sectors transfers. When set to Auto, the data transfer from and to the device occurs multiple sectors at a time if the device supports multi-sector transfer feature. When set to Disabled, the data transfer from and to the device occurs one sector at a time. Configuration options: [Disabled] [Auto]

PIO Mode [Auto]

Selects the PIO mode. Configuration options: [Auto] [0] [1] [2] [3] [4]

SMART Monitoring [Auto]

Sets the Smart Monitoring, Analysis, and Reporting Technology. Configuration options: [Auto] [Disabled] [Enabled]

32Bit Data Transfer [Disabled]

Enables or disables 32-bit data transfer. Configuration options: [Disabled] [Enabled]

2.3.5 System Information

This menu gives you an overview of the general system specifications. The items in this menu are auto-detected by BIOS.

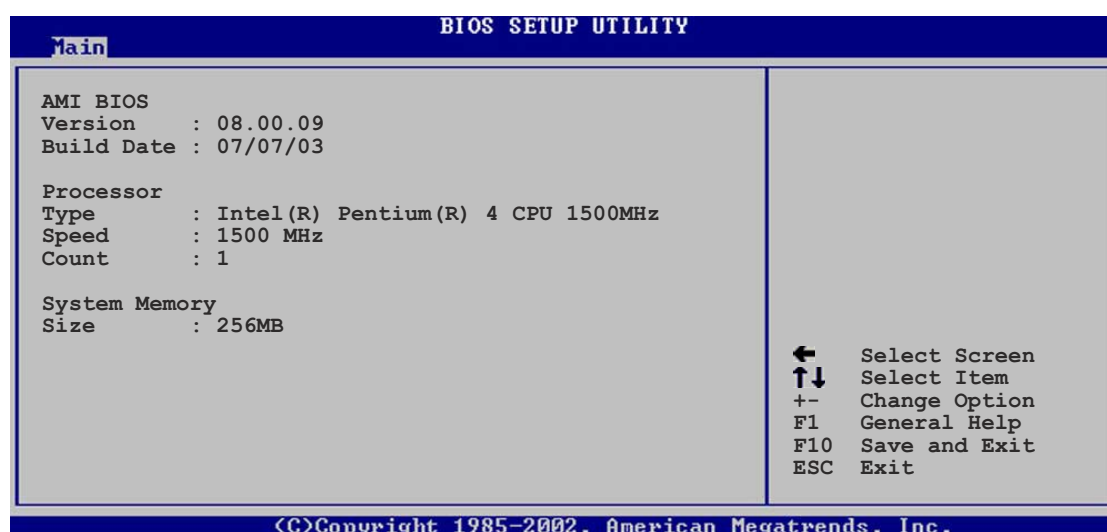

AMI BIOS

This item displays the auto-detected BIOS information.

Processor

This item displays the auto-detected CPU specification.

System Memory

This item displays the auto-detected system memory.

2.4 Advanced menu

The Advanced menu items allow you to change the settings for the CPU and other system devices.



Take caution when changing the settings of the Advanced menu items. Incorrect field values may cause the system to malfunction.

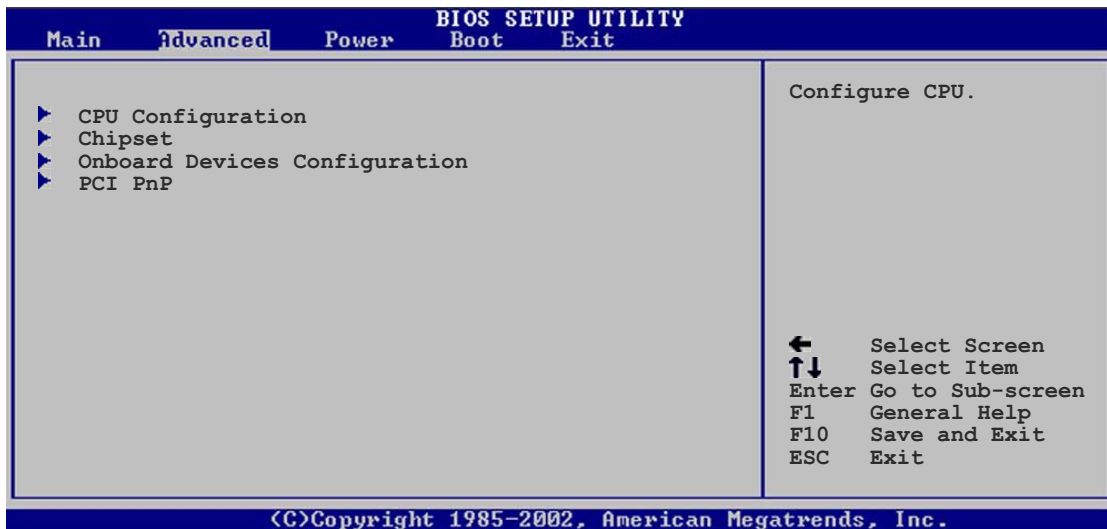

2.4.1 CPU Configuration

The items in this menu show the CPU-related information auto-detected by BIOS.

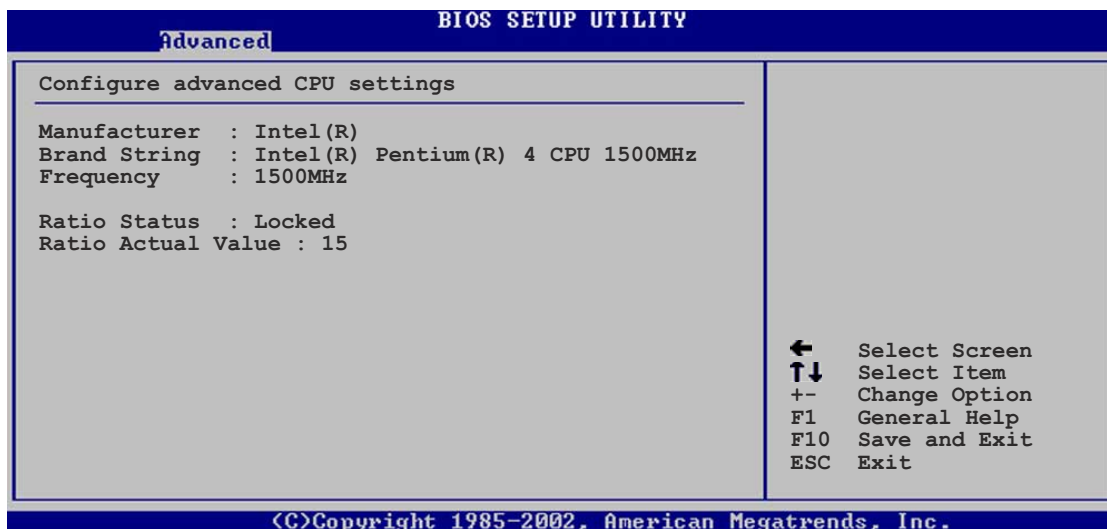

2.4.2 Chipset

The Chipset menu items allow you to change the advanced chipset settings. Select an item then press Enter to display the sub-menu.

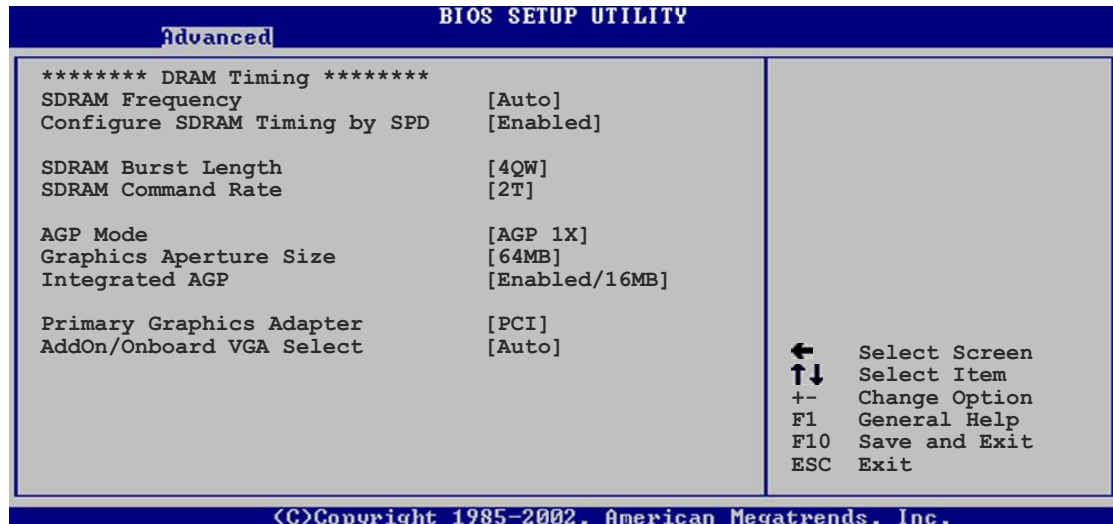

SDRAM Frequency [Auto]

This item allows you to set the SDRAM operating frequency.
Configuration options: [Auto] [200Mhz] [266Mhz]

Configure DRAM Timing by SPD [Enabled]

When this item is enabled, the DRAM timing parameters are set according to the DRAM SPD (Serial Presence Detect). When disabled, you can manually set the DRAM timing parameters through the DRAM sub-items. Configuration options: [Disabled] [Enabled]



The following sub-items appear when the item **Configure DRAM Timing by SPD** is set to Disabled.

CAS# Latency [2.5]

This item controls the latency between the SDRAM read command and the time the data actually becomes available.
Configuration options: [2.0 Clocks] [2.5 Clocks]

Precharge to Active (Trp) [3T]

Configuration options: [2T] [3T]

Active to Precharge (Tras) [6T]

Configuration options: [5T] [6T]

Active to CMD (Trcd) [3T]

Configuration options: [2T] [3T]

SDRAM Bank Interleave [Disabled]

This item controls the latency between the SDRAM read command and the time the data actually becomes available.

Configuration options: [Disabled] [2-Way] [4-Way]

SDRAM Burst Length [4QW]

Configuration options: [8QW] [4QW]

SDRAM Command Rate [2T]

Configuration options: [2T] [1T]

AGP Mode [4X]

Allows you to set the AGP mode setting.

Configuration options: [AGP 4X] [AGP 2X] AGP 1X]

Graphics Aperture Size [64MB]

Allows you to to select the size of mapped memory for AGP graphic data.

Configuration options: [256MB] [128MB] [64MB] [32MB] [16MB] [8MB] [4MB]

Integrated AGP [Enabled/16MB]

Allows you to disable or enable and set the integrated AGP operating memory size.

Configuration options: [Disabled] [Enabled/8MB] [Enabled/16MB] [Enabled/32MB]

Primary Graphics Adapter [PCI]

This item sets the primary graphics adapter. Configuration options: [PCI] [AGP]

AddOn/Onboard VGA Select [Auto]

This item allows you to set the onboard VGA port for use or set to [Auto] to detect an add-on VGA card. Configuration options: [Onboard VGA] [Auto]

2.4.3 Onboard Devices Configuration

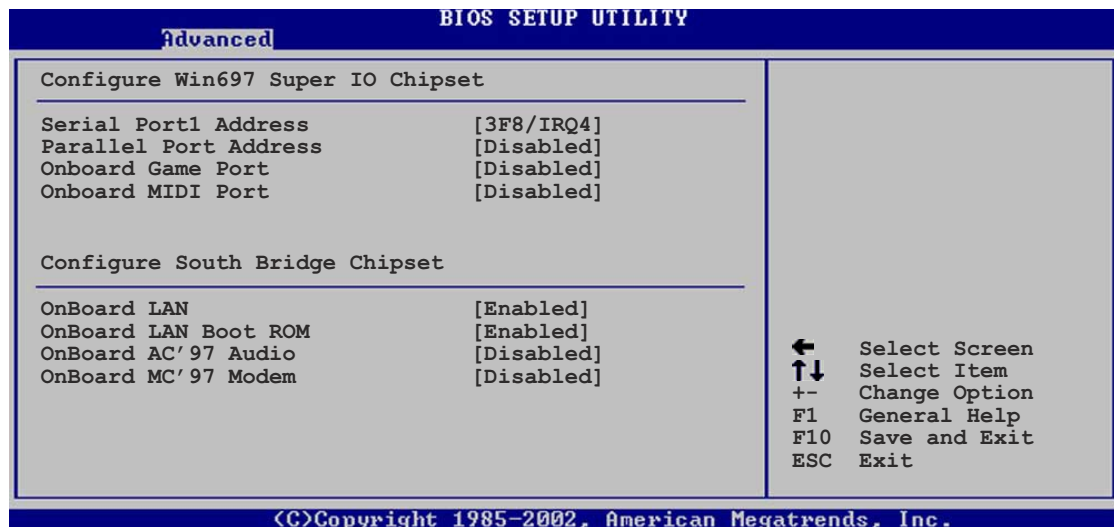

Configure Win697 Super IO Chipset

Serial Port1 Address [3F8/IRQ4]

Allows you to select the Serial Port1 base address. Configuration options: [Disabled] [3F8/IRQ4] [2F8/IRQ3] [3E8/IRQ4] [2E8/IRQ3]

Parallel Port Address [378]

Allows you to select the Parallel Port base addresses. Configuration options: [Disabled] [378] [278] [3BC]

Parallel Port Mode [Normal]

This item appears only when the Parallel Port Address is not disabled. When set, this item allows you to select the Parallel Port mode.

Configuration options: [Bi-directional] [EPP] [ECP]

ECP Mode DMA Channel [DMA3]

Allows selection of the Parallel Port ECP DMA channel. This item appears only when the **Parallel Port Mode** is set to **ECP**. Configuration options: [DMA0] [DMA1] [DMA3]

EPP Version [1.9]

Allows selection of the EPP version. This item appears only when the **Parallel Port Mode** is set to **EPP**. Configuration options: [DMA0] [DMA1] [DMA3]

Parallel Port IRQ [IRQ7]

Allows you to select the Parallel Port IRQ. Configuration options: [IRQ5] [IRQ7]

OnBoard Game Port [Enabled]

This item enable or disables the onboard Game port.

Configuration options: [Disabled] [Enabled]

OnBoard MIDI Port [300]

This item enable or disables the onboard MIDI port.

Configuration options: [Disabled] [300] [200/330] [330]

MIDI IRQ Select [IRQ10]

Allows you to select the MIDI Port IRQs.

Configuration options: [IRQ5] [IRQ7] [IRQ10]

Configure South Bridge Chipset

OnBoard LAN [Enabled]

This item enables or disables the onboard LAN controller.

Configuration options: [Disabled] [Enabled]

OnBoard LAN Boot ROM [Disabled]

This item enables or disables the onboard LAN Boot ROM.

Configuration options: [Disabled] [Enabled]

OnBoard AC'97 Audio [Enabled]

This item enables or disables the onboard AC'97 audio CODEC.

Configuration options: [Disabled] [Enabled]

OnBoard MC'97 Modem [Disabled]

This item enables, disables or set to auto the onboard MC'97 modem controller.

Configuration options: [Disabled] [Auto]

2.4.4 PCI PnP

The PCI PnP menu items allow you to change the advanced settings for PCI/PnP devices. The menu includes setting IRQ and DMA channel resources for either PCI/PnP or legacy ISA devices, and setting the memory size block for legacy ISA devices.



Take caution when changing the settings of the PCI PnP menu items. Incorrect field values may cause the system to malfunction.

Advanced		BIOS SETUP UTILITY	
Advanced PCI/PnP settings			
WARNING: Setting wrong values in the sections below may cause system to malfunction.			
Plug and Play OS	[No]	NO: Lets the BIOS configure all the devices in the system. YES: Lets the operating system configure Plug and Play (PnP) devices not required for boot if your system has a Plug and Play operating system. ← Select Screen ↑↓ Select Item +- Change Option F1 General Help F10 Save and Exit ESC Exit	
PCI Latency Timer	[64]		
Allocate IRQ to PCI VGA	[Yes]		
Palette Snooping	[Disabled]		
PCI IDE BusMaster	[Enabled]		
IRQ3	[Available]		
IRQ4	[Available]		
IRQ5	[Available]		
IRQ7	[Available]		
IRQ9	[Available]		
IRQ10	[Available]		
IRQ11	[Available]		
IRQ14	[Available]		
IRQ15	[Available]		
©Copyright 1985-2002, American Megatrends, Inc.			

Plug and Play O/S [No]

When set to [No], BIOS configures all the devices in the system. When set to [Yes] and if you installed a Plug & Play operating system, the operating system configures the Plug & Play devices not required for boot.

Configuration options: [No] [Yes]

PCI Latency Timer [64]

Allows you to select the value in units of PCI clocks for the PCI device latency timer register. Configuration options: [32] [64] [96] [128] [160] [192] [224] [248]

Allocate IRQ to PCI VGA [Yes]

When set to [Yes], BIOS assigns an IRQ to PCI VGA card if the card requests for an IRQ. When set to [No], BIOS does not assign an IRQ to the PCI VGA card even if requested. Configuration options: [Yes] [No]

IRQ xx [Available]

When set to [Available], the specific IRQ is free for use of PCI/PnP devices. When set to [Reserved], the IRQ is reserved for legacy ISA devices.

Configuration options: [Available] [Reserved]

2.5 Power menu

The Power menu items allow you to change the settings for the Advanced Power Management (APM). Select an item then press Enter to display the configuration options.

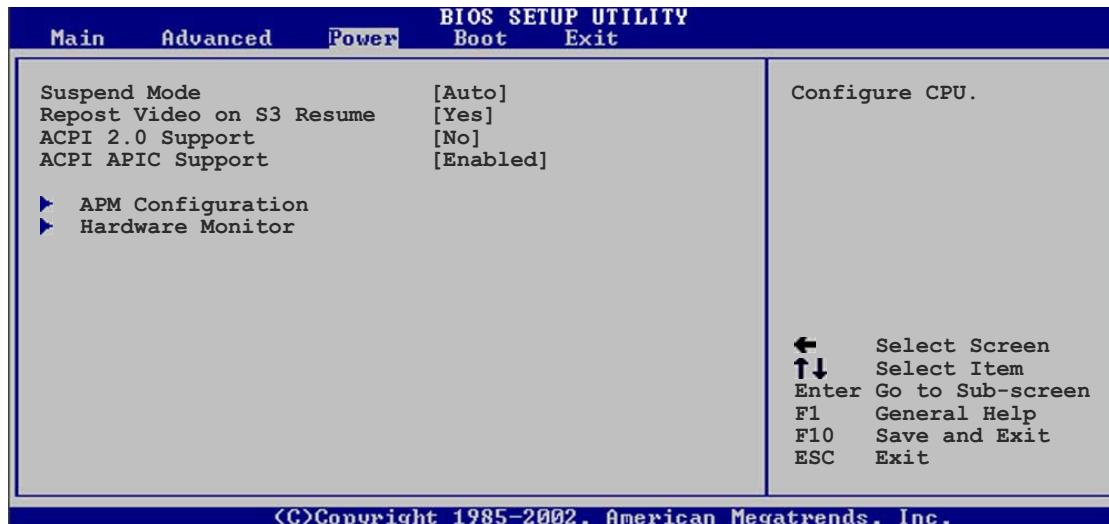

2.5.1 Suspend Mode [Auto]

Allows you to select the ACPI state to be used for system suspend.
Configuration options: [S1 Only] [S3 Only] [Auto]

2.5.2 Repost Video on S3 Resume [Yes]

This item determines whether to invoke the VGA BIOS post on S3/STR resume.
Configuration options: [Yes] [No]

2.5.3 ACPI 2.0 Support [No]

Allows you to add more tables for ACPI 2.0 specifications.
Configuration options: [No] [Yes]

2.5.4 ACPI APIC Support [Enabled]

Allows you to enable or disable the ACPI support in the ASIC. When set to Enabled, the ACPI APIC table pointer is included in the RSDT pointer list.
Configuration options: [Disabled] [Enabled]

2.5.5 APM Configuration

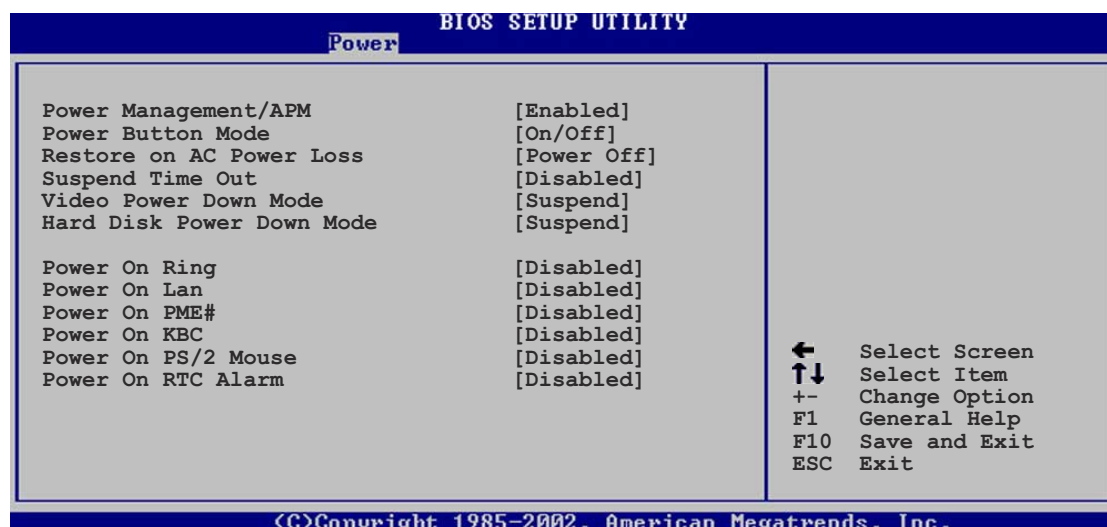

Power Management/APM [Enabled]

Allows you to enable or disable the Advanced Power Management (APM) feature. Configuration options: [Disabled] [Enabled]



The following items appear only if the Power Management/APM item is set to [Enabled]

Power Button Mode [On/Off]

Allows the system to go into On/Off mode or suspend mode when the power button is pressed. Configuration options: [On/Off] [Standby] [Suspend]

Restore on AC Power Loss [Power Off]

This item sets the system status after restore on AC power loss. Configuration options: [Power Off] [Power On] [Last State]

Suspend Time Out [Disabled]

Allows you to select the specified time at which the system goes on suspend. Configuration options: [Disabled] [1 Min] [2 Min] [4 Min] [8 Min] [10 Min] [20 Min] [30 Min] [40 Min] [50 Min] [60 Min]

Video Power Down Mode [Suspend]

Allows you to select the video power down mode. Configuration options: [Disabled] [Standby] [Suspend]

Hard Disk Power Down Mode [Suspend]

Allows you to set the hard disk power down mode. Configuration options: [Disabled] [Standby] [Suspend]

Power On Ring [Disabled]

This allows either settings of [Enabled] or [Disabled] for powering up the computer when the external modem receives a call while the computer is in Soft-off mode.

Configuration options: [Disabled] [Enabled]



The computer cannot receive or transmit data until the computer and applications are fully running. Thus, connection cannot be made on the first try. Turning an external modem off and then back on while the computer is off causes an initialization string that turns the system power on.

Power On LAN [Disabled]

Allows you to enable or disable the onboard LAN to generate PME in SoftOFF mode. Configuration options: [Disabled] [Enabled]

Power On PME# [Disabled]

When set to [Enabled], this parameter allows you to turn on the system through a PCI LAN or modem card. This feature requires an ATX power supply that provides at least 1A on the +5VSB lead. Configuration options: [Disabled] [Enabled]

Power On KBC [Disabled]

This parameter allows you to use specific keys on the keyboard to turn on the system. When set to [S5], the item Wake-up Key is enabled. This feature requires an ATX power supply that provides at least 1A on the +5VSB lead. Configuration options: [Disabled] [S3] [S3/S4/S5]

Power On By PS/2 Mouse [Disabled]

When set to [Enabled], this parameter allows you to use the PS/2 mouse to resume the system. This feature requires an ATX power supply that provides at least 1A on the +5VSB lead. Configuration options: [Disabled] [S3] [S3/S4/S5]

Power On RTC Alarm [Disabled]

Allows you to enable or disable RTC to generate a wake event. When this item is set to Enabled, the items RTC Alarm Date, RTC Alarm Hour, RTC Alarm Minute, and RTC Alarm Second appear with set values.

Configuration options: [Disabled] [Enabled]

2.5.6 Hardware Monitor

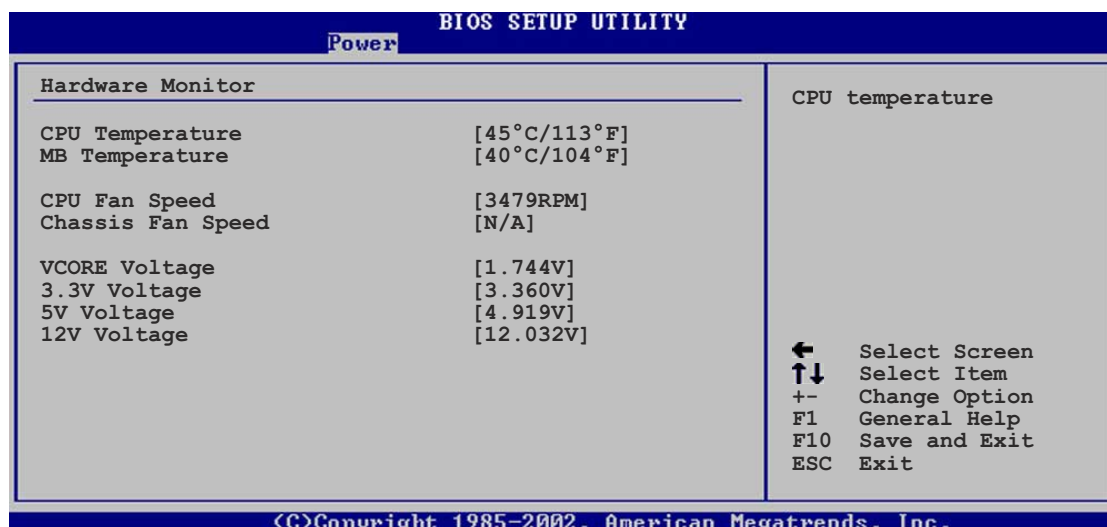

CPU Temperature [xxx°C/xxxF]

MB Temperature [xxx°C/xxxF]

The onboard hardware monitor automatically detects and displays the motherboard and CPU temperatures.

CPU Fan Speed [xxxxRPM] or [N/A]

Chassis Fan Speed [xxxxRPM] or [N/A]

The onboard hardware monitor automatically detects and displays the CPU and chassis fan speeds in rotations per minute (RPM). If any of the fans is not connected to the motherboard, the specific field shows N/A.

VCORE Voltage, +3.3V Voltage, +5V Voltage, +12V Voltage

The onboard hardware monitor automatically detects the voltage output through the onboard voltage regulators.



If any of the monitored items is out of range, the following error message appears: "Hardware Monitor found an error. Enter Power setup menu for details". You will then be prompted to "Press F1 to continue or DEL to enter SETUP".

2.6 Boot menu

The Boot menu items allow you to change the system boot options. Select an item then press Enter to display the sub-menu.

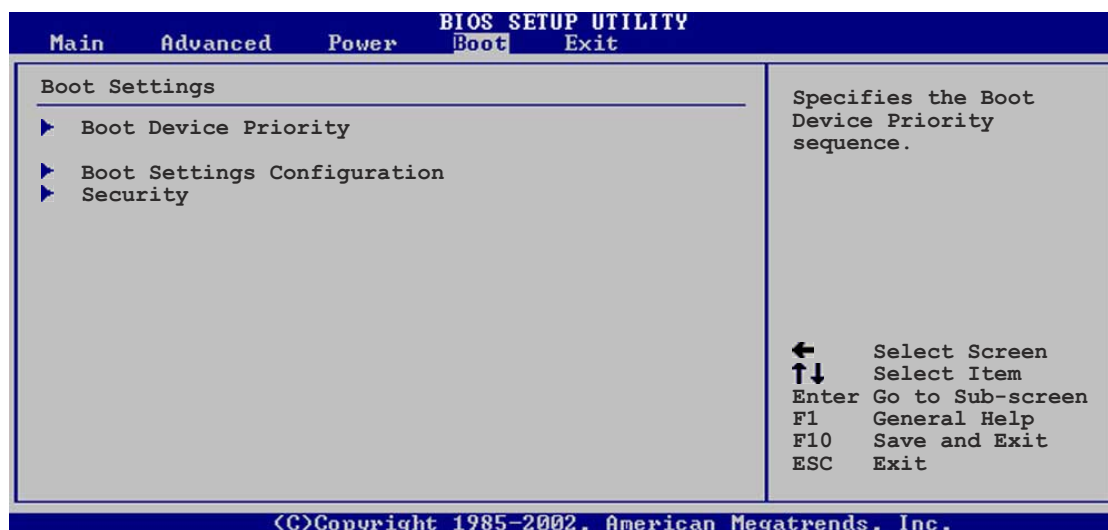

2.6.1 Boot Device Priority

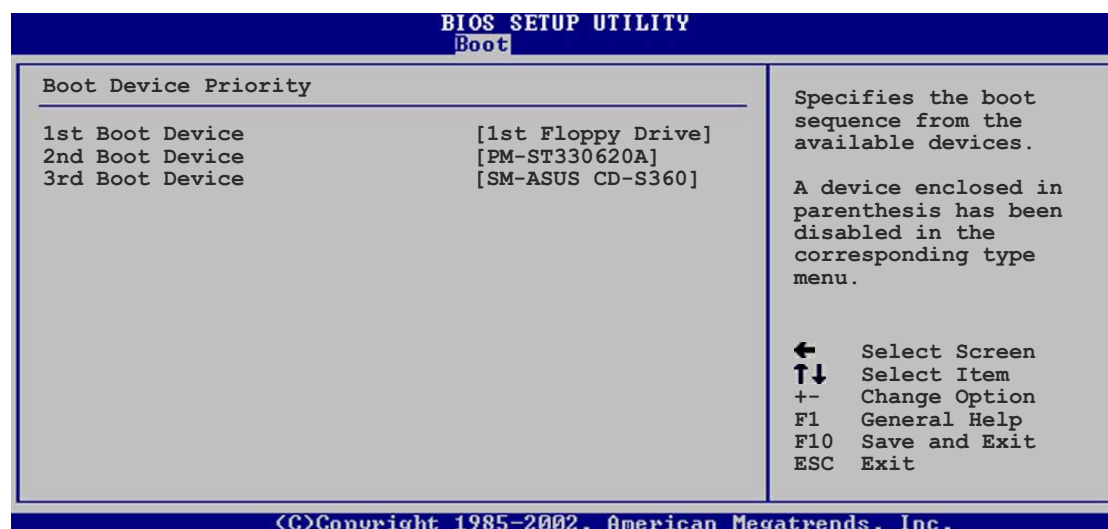

1st ~ xxth Boot Device [1st Floppy Drive]

These items specify the boot device priority sequence from the available devices. The number of device items that appear on the screen depends on the the number of devices installed in the system. Configuration options: [xxxxx Drive] [Disabled]

2.6.2 Boot Settings Configuration

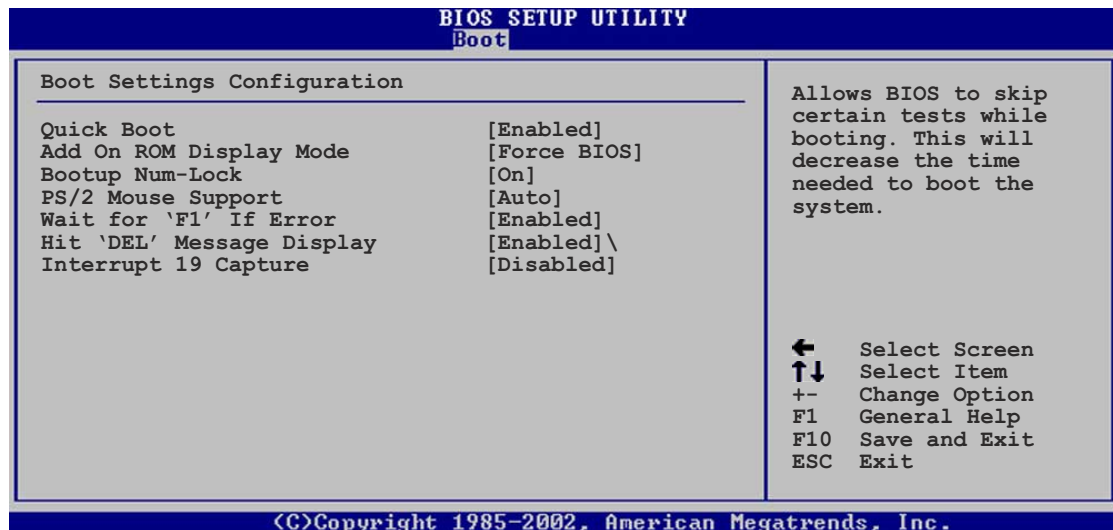

Quick Boot [Enabled]

Enabling this item allows BIOS to skip some power on self tests (POST) while booting to decrease the time needed to boot the system. When set to [Disabled], BIOS performs all the POST items. Configuration options: [Disabled] [Enabled]

Add On ROM Display Mode [Force BIOS]

Sets the display mode for option ROM. Configuration options: [Force BIOS] [Keep Current]

Bootup Num-Lock [On]

Allows you to select the power-on state for the NumLock. Configuration options: [Off] [On]

PS/2 Mouse Support [Auto]

Allows you to enable or disable support for PS/2 mouse. Configuration options: [Disabled] [Enabled] [Auto]

Wait for 'F1' If Error [Enabled]

When set to Enabled, the system waits for F1 key to be pressed when error occurs. Configuration options: [Disabled] [Enabled]

Hit 'DEL' Message Display [Enabled]

When set to Enabled, the system displays the message "Press DEL to run Setup" during POST. Configuration options: [Disabled] [Enabled]

Interrupt 19 Capture [Disabled]

When set to Enabled, the system allows option ROMs to trap interrupt 19. This is required by some PCI cards that provide a ROM based setup utility. Configuration options: [Disabled] [Enabled]

2.6.3 Security

The Security menu items allow you to change the system security settings. Select an item then press Enter to display the configuration options.

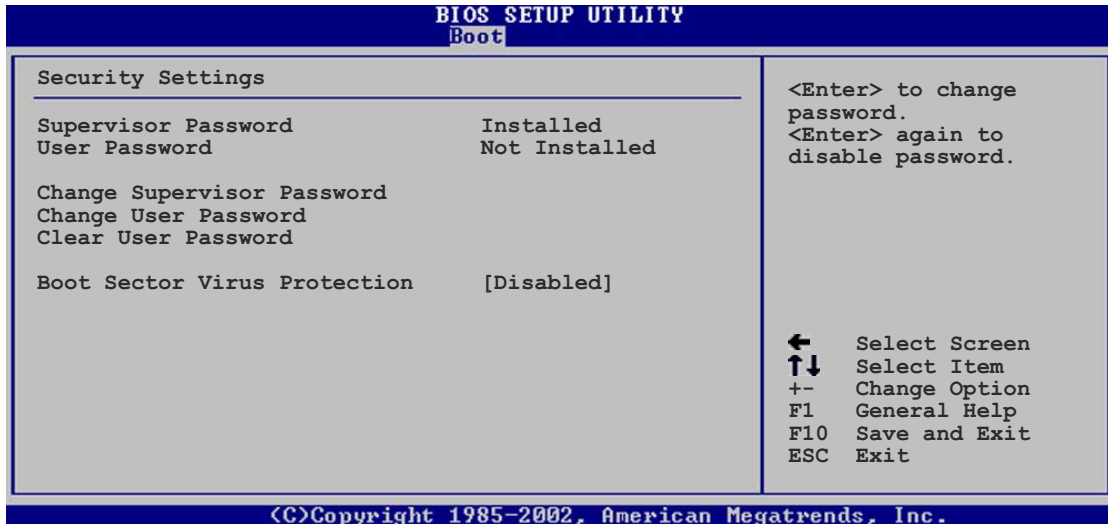

Set a Supervisor Password

Select this item to set or change the supervisor password. The Supervisor Password item on top of the screen shows the default **Not Installed**. After you have set a password, this item shows **Installed**.

To set a Supervisor Password:

1. Select the Change Supervisor Password item and press Enter.
2. On the password box that appears, type a password composed of letters and/or numbers, then press Enter. Your password should have at least six characters.
3. Confirm the password when prompted.
The message "**Password Installed**" appears after you have successfully set your password.

The Supervisor Password item now shows **Installed**.

Change the Supervisor Password

To change the supervisor password, follow the same steps as in setting a user password.

To clear the supervisor password, select the Change Supervisor Password then press Enter. The message "**Password Uninstalled**" appears.

After you have set a supervisor password, the other items appear to allow you to change other security settings.

Change User Password

Select this item to set or change the user password. The User Password item on top of the screen shows the default **Not Installed**. After you have set a password, this item shows **Installed**.

To set a User Password:

1. Select the Change User Password item and press Enter.
2. On the password box that appears, type a password composed of letters and/or numbers, then press Enter. Your password should have at least six characters.
3. Confirm the password when prompted.
The message "Password Installed" appears after you have successfully set your password.

The User Password item now shows **Installed**.

To change the user password, follow the same steps as in setting a user password.

Clear User Password

Select this item if you wish to clear the user password.

Boot Sector Virus Protection [Disabled]

Allows you to enable or disable the boot sector virus protection. Configuration options: [Disabled] [Enabled]

2.7 Exit menu

The Exit menu items allow you to load the optimal or failsafe default values for the BIOS items, and save or discard your changes to the BIOS items.

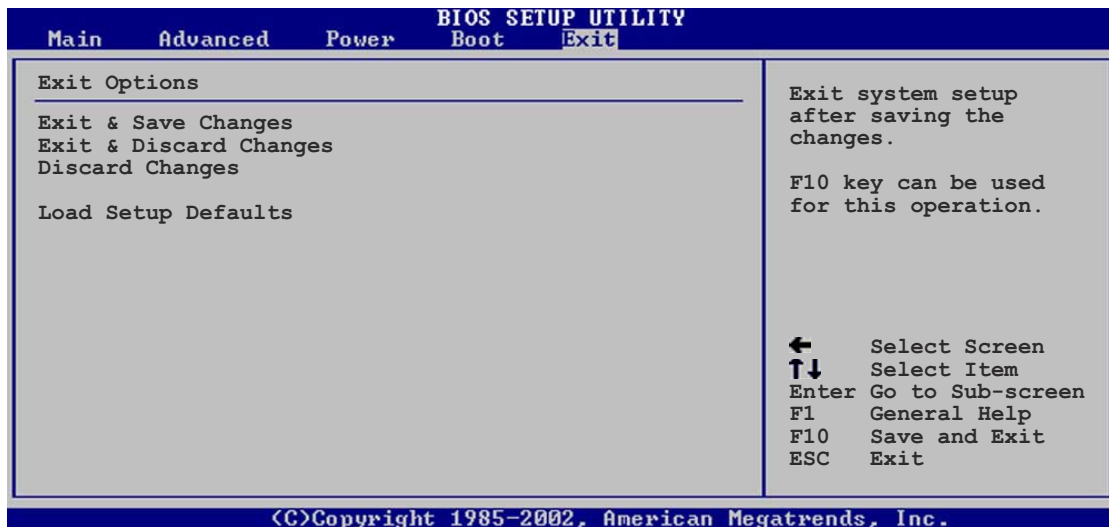

Pressing <Esc> does not immediately exit this menu. Select one of the options from this menu or <F10> from the legend bar to exit.

Exit & Save Changes

Once you are finished making your selections, choose this option from the Exit menu to ensure the values you selected are saved to the CMOS RAM. The CMOS RAM is sustained by an onboard backup battery and stays on even when the PC is turned off. When you select this option, a confirmation window appears. Select [Yes] to save changes and exit.



If you attempt to exit the Setup program without saving your changes, the program prompts you with a message asking if you want to save your changes before exiting. Pressing <Enter> saves the changes while exiting.

Exit & Discard Changes

Select this option only if you do not want to save the changes that you made to the Setup program. If you made changes to fields other than system date, system time, and password, the BIOS asks for a confirmation before exiting.

Discard Changes

This option allows you to discard the selections you made and restore the previously saved values. After selecting this option, a confirmation appears. Select [Yes] to discard any changes and load the previously saved values.

Load Setup Defaults

This option allows you to load the default values for each of the parameters on the Setup menus. When you select this option or if you press <F5>, a confirmation window appears. Select [Yes] to load default values. Select Exit Saving Changes or make other changes before saving the values to the non-volatile RAM.

Chapter 3

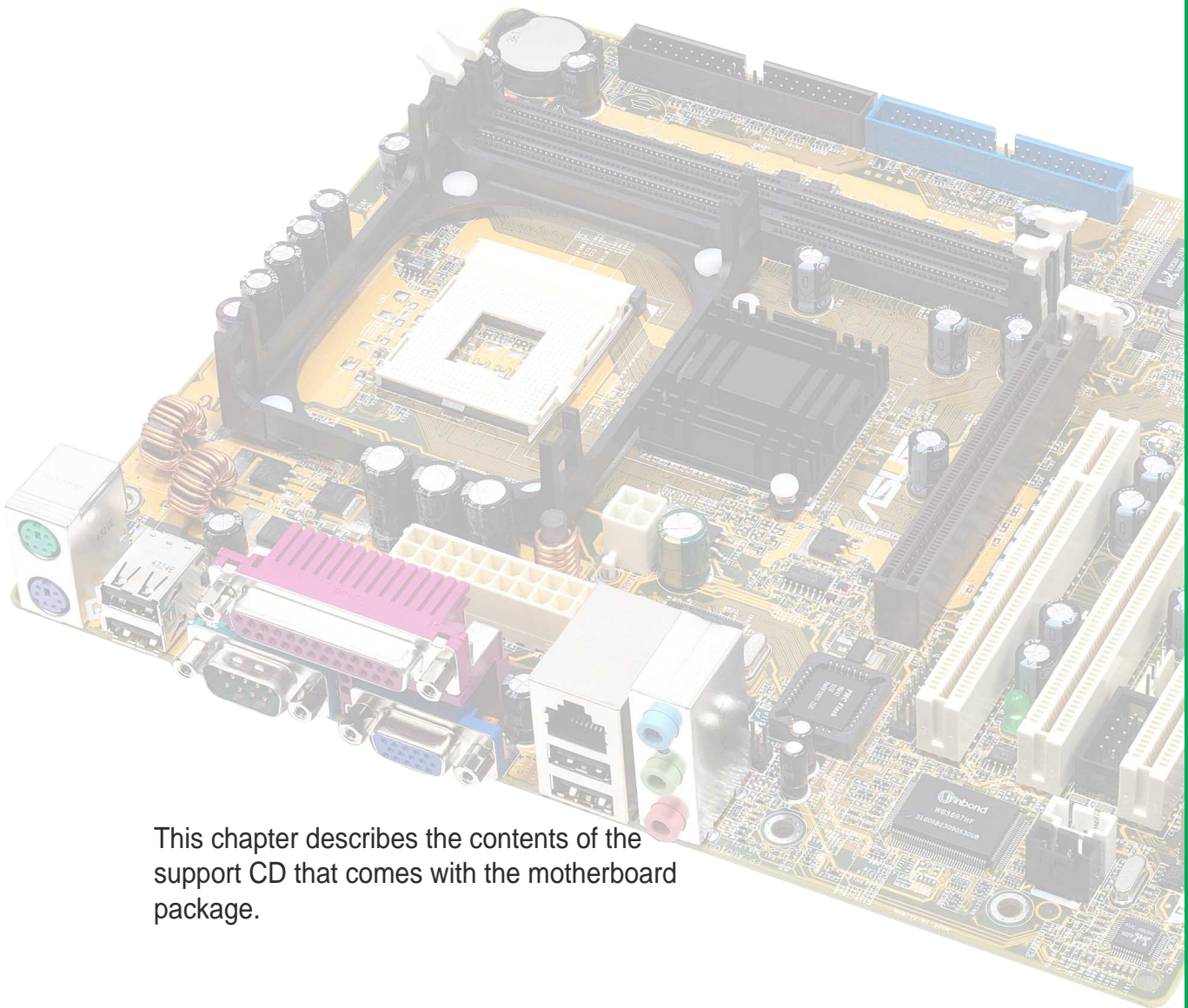

This chapter describes the contents of the support CD that comes with the motherboard package.

Software support

3.1 Install an operating system

This motherboard supports Windows 98SE/ME/NT/2000/XP operating system (OS). Always install the latest OS version and corresponding updates so you can maximize the features of your hardware.



Because motherboard settings and hardware options vary, use the setup procedures presented in this chapter for general reference only. Refer to your OS documentation for more information.

3.2 Support CD information

The support CD that came with the motherboard contains useful software and several utility drivers that enhance the motherboard features.



The contents of the support CD are subject to change at any time without notice. Visit the ASUS website for updates.

3.2.1 Running the support CD

To begin using the support CD, simply insert the CD into your CD-ROM drive. The CD automatically displays the **Drivers** menu if Autorun is enabled in your computer.



Click an item to install

Click an icon to display more information



If **Autorun** is NOT enabled in your computer, browse the contents of the support CD to locate the file **ASSETUP.EXE** from the **BIN** folder. Double-click the **ASSETUP.EXE** to run the CD.

3.2.2 Drivers menu

The drivers menu shows the available device drivers if the system detects installed devices. Install the necessary drivers to activate the devices.

VIA 4 in 1 drivers

This item installs the following drivers:

- VIA Registry (INF) driver
- VIA AGP VxD driver
- VIA ATAPI vendor support driver
- VIA PCI IRQ Miniport driver

Realtek AC'97 Audio Driver

This item installs the Realtek AC'97 compliant audio controller and application.

VIA 10/100Mb LAN Driver

This item installs the VIA 10/100Mbps Fast Ethernet driver to support 10/100 Mbps networking.

USB 2.0 Driver

This item installs the USB 2.0 driver.

3.2.3 Utilities menu

The Utilities menu shows the applications and other software that the motherboard supports.



ASUS PC Probe

This smart utility monitors the fan speed, CPU temperature, and system voltages, and alerts you on any detected problems. This utility helps you keep your computer at a healthy operating condition.

Install ASUS Update

This program allows you to download the latest version of the BIOS from the ASUS website. Before using the ASUS Update, make sure that you have an Internet connection so you can connect to the ASUS website.

PC-CILLIN 2002

This item installs the PC-cillin 2002 anti-virus program. View the PC-cillin online help for detailed information.

Adobe Acrobat Reader

This item installs the Adobe Acrobat Reader V5.0. The Acrobat Reader software is for viewing files saved in Portable Document Format (PDF).

ASUS Screen Saver

This item installs the ASUS screen saver.

3.2.4 ASUS Contact Information

Clicking the ASUS Contact Information tab displays as stated. You may also find this information on page viii of this user guide.

