



***P4C800-E***  
***Deluxe***

User Guide

**Motherboard**

**E1347**

**Revised edition V2**

**June 2003**

**Copyright © 2003 ASUSTeK COMPUTER INC. All Rights Reserved.**

No part of this manual, including the products and software described in it, may be reproduced, transmitted, transcribed, stored in a retrieval system, or translated into any language in any form or by any means, except documentation kept by the purchaser for backup purposes, without the express written permission of ASUSTeK COMPUTER INC. ("ASUS").

Product warranty or service will not be extended if: (1) the product is repaired, modified or altered, unless such repair, modification or alteration is authorized in writing by ASUS; or (2) the serial number of the product is defaced or missing.

ASUS PROVIDES THIS MANUAL "AS IS" WITHOUT WARRANTY OF ANY KIND, EITHER EXPRESS OR IMPLIED, INCLUDING BUT NOT LIMITED TO THE IMPLIED WARRANTIES OR CONDITIONS OF MERCHANTABILITY OR FITNESS FOR A PARTICULAR PURPOSE. IN NO EVENT SHALL ASUS, ITS DIRECTORS, OFFICERS, EMPLOYEES OR AGENTS BE LIABLE FOR ANY INDIRECT, SPECIAL, INCIDENTAL, OR CONSEQUENTIAL DAMAGES (INCLUDING DAMAGES FOR LOSS OF PROFITS, LOSS OF BUSINESS, LOSS OF USE OR DATA, INTERRUPTION OF BUSINESS AND THE LIKE), EVEN IF ASUS HAS BEEN ADVISED OF THE POSSIBILITY OF SUCH DAMAGES ARISING FROM ANY DEFECT OR ERROR IN THIS MANUAL OR PRODUCT.

SPECIFICATIONS AND INFORMATION CONTAINED IN THIS MANUAL ARE FURNISHED FOR INFORMATIONAL USE ONLY, AND ARE SUBJECT TO CHANGE AT ANY TIME WITHOUT NOTICE, AND SHOULD NOT BE CONSTRUED AS A COMMITMENT BY ASUS. ASUS ASSUMES NO RESPONSIBILITY OR LIABILITY FOR ANY ERRORS OR INACCURACIES THAT MAY APPEAR IN THIS MANUAL, INCLUDING THE PRODUCTS AND SOFTWARE DESCRIBED IN IT.

Products and corporate names appearing in this manual may or may not be registered trademarks or copyrights of their respective companies, and are used only for identification or explanation and to the owners' benefit, without intent to infringe.

# Contents

Notices .....	vi
Safety information .....	vii
About this guide .....	viii
ASUS contact information .....	x
P4C800-E Deluxe specifications summary .....	xi

## Chapter 1: Product introduction

1.1 Welcome! .....	1-1
1.2 Package contents .....	1-1
1.3 Special features .....	1-2
1.3.1 Product highlights .....	1-2
1.3.2 Value-added solutions .....	1-5
1.4 Motherboard overview .....	1-6
1.4.1 Major components .....	1-6
1.4.2 Core specifications .....	1-8

## Chapter 2: Hardware information

2.1 Motherboard installation .....	2-1
2.1.1 Placement direction .....	2-1
2.1.2 Screw holes .....	2-1
2.2 Motherboard layout .....	2-2
2.3 Before you proceed .....	2-3
2.4 Central Processing Unit (CPU) .....	2-4
2.4.1 Overview .....	2-4
2.4.2 Installing the CPU .....	2-5
2.4.3 Installing the heatsink and fan .....	2-7
2.4.4 Connecting the CPU fan cable .....	2-9
2.5 System memory .....	2-10
2.5.1 Overview .....	2-10
2.5.2 Memory configurations .....	2-10
2.5.3 Installing a DIMM .....	2-13
2.5.4 Removing a DIMM .....	2-13
2.6 Expansion slots .....	2-14
2.6.1 Installing an expansion card .....	2-14
2.6.2 Configuring an expansion card .....	2-14
2.6.3 PCI slots .....	2-16
2.6.4 AGP Pro slot .....	2-17
2.6.5 Wi-Fi slot .....	2-18

# Contents

2.7	Jumpers .....	2-19
2.8	Connectors .....	2-21

## Chapter 3: Powering up

3.1	Starting up for the first time .....	3-1
3.2	Vocal POST Messages .....	3-2
3.3	Powering off the computer .....	3-4

## Chapter 4: BIOS setup

4.1	Managing and updating your BIOS .....	4-1
4.1.1	Creating a bootable floppy disk .....	4-1
4.1.2	Using AFUDOS to update the BIOS .....	4-1
4.1.3	Using ASUS EZ Flash to update the BIOS .....	4-3
4.1.4	Recovering the BIOS with CrashFree BIOS 2 .....	4-4
4.2	BIOS Setup program .....	4-6
4.2.1	BIOS menu screen .....	4-7
4.2.2	Menu bar .....	4-7
4.2.3	Navigation keys .....	4-7
4.2.4	Menu items .....	4-8
4.2.5	Sub-menu items .....	4-8
4.2.6	Configuration fields .....	4-8
4.2.7	Pop-up window .....	4-8
4.2.8	Scroll bar .....	4-8
4.2.9	General help .....	4-8
4.3	Main menu .....	4-9
4.3.1	System Time [xx:xx:xxxx] .....	4-9
4.3.2	System Date [Day xx/xx/xxxx] .....	4-9
4.3.3	Legacy Diskette A [1.44M, 3.5 in.] .....	4-9
4.3.4	Language [English] .....	4-9
4.3.5	Primary and Secondary IDE Master/Slave .....	4-10
4.3.6	IDE Configuration .....	4-11
4.3.7	System Information .....	4-13
4.4	Advanced menu .....	4-14
4.4.1	JumperFree Configuration .....	4-14
4.4.2	CPU Configuration .....	4-17
4.4.3	Chipset .....	4-18
4.4.4	Onboard Devices Configuration .....	4-20
4.4.5	PCI PnP .....	4-22
4.4.6	USB Configuration .....	4-23

# Contents

4.4.7	Speech Configuration .....	4-25
4.4.8	Instant Music Configuration .....	4-26
4.5	Power menu .....	4-27
4.5.1	Suspend Mode [Auto] .....	4-27
4.5.2	Repost Video on S3 Resume [No] .....	4-27
4.5.3	ACPI 2.0 Support [No] .....	4-27
4.5.4	ACPI APIC Support [Enabled] .....	4-27
4.5.5	BIOS -> AML ACPI Table [Enabled] .....	4-27
4.5.6	APM Configuration .....	4-28
4.5.7	Hardware Monitor .....	4-30
4.6	Boot menu .....	4-32
4.6.1	Boot Device Priority .....	4-32
4.6.2	Boot Settings Configuration .....	4-33
4.6.3	Security .....	4-35
4.7	Exit menu .....	4-38

## Chapter 5: Software support

5.1	Install an operating system .....	5-1
5.2	Support CD information .....	5-1
5.2.1	Running the support CD .....	5-1
5.2.2	Drivers menu .....	5-2
5.2.3	Utilities menu .....	5-3
5.2.4	ASUS Contact Information .....	5-4
5.2.5	Other information .....	5-5
5.3	Software information .....	5-7
5.3.1	ASUS Update .....	5-7
5.3.2	ASUS MyLogo2™ .....	5-8
5.3.3	ASUS PC Probe .....	5-10
5.3.4	Winbond Voice Editor .....	5-15
5.3.5	SoundMAX® 4 XL software .....	5-19
5.3.6	ASUS Instant Music .....	5-22
5.4	Promise RAID configurations .....	5-25
5.5	Intel® RAID for Serial ATA .....	5-33

## Quick Reference Card

# Notices

## Federal Communications Commission Statement

This device complies with FCC Rules Part 15. Operation is subject to the following two conditions:

- This device may not cause harmful interference, and
- This device must accept any interference received including interference that may cause undesired operation.

This equipment has been tested and found to comply with the limits for a Class B digital device, pursuant to Part 15 of the FCC Rules. These limits are designed to provide reasonable protection against harmful interference in a residential installation. This equipment generates, uses and can radiate radio frequency energy and, if not installed and used in accordance with manufacturer's instructions, may cause harmful interference to radio communications. However, there is no guarantee that interference will not occur in a particular installation. If this equipment does cause harmful interference to radio or television reception, which can be determined by turning the equipment off and on, the user is encouraged to try to correct the interference by one or more of the following measures:

- Reorient or relocate the receiving antenna.
- Increase the separation between the equipment and receiver.
- Connect the equipment to an outlet on a circuit different from that to which the receiver is connected.
- Consult the dealer or an experienced radio/TV technician for help.



---

The use of shielded cables for connection of the monitor to the graphics card is required to assure compliance with FCC regulations. Changes or modifications to this unit not expressly approved by the party responsible for compliance could void the user's authority to operate this equipment.

---

## Canadian Department of Communications Statement

This digital apparatus does not exceed the Class B limits for radio noise emissions from digital apparatus set out in the Radio Interference Regulations of the Canadian Department of Communications.

**This class B digital apparatus complies with Canadian ICES-003.**

# Safety information

## Electrical safety

- To prevent electrical shock hazard, disconnect the power cable from the electrical outlet before relocating the system.
- When adding or removing devices to or from the system, ensure that the power cables for the devices are unplugged before the signal cables are connected. If possible, disconnect all power cables from the existing system before you add a device.
- Before connecting or removing signal cables from the motherboard, ensure that all power cables are unplugged.
- Seek professional assistance before using an adapter or extension cord. These devices could interrupt the grounding circuit.
- Make sure that your power supply is set to the correct voltage in your area. If you are not sure about the voltage of the electrical outlet you are using, contact your local power company.
- If the power supply is broken, do not try to fix it by yourself. Contact a qualified service technician or your retailer.

## Operation safety

- Before installing the motherboard and adding devices on it, carefully read all the manuals that came with the package.
- Before using the product, make sure all cables are correctly connected and the power cables are not damaged. If you detect any damage, contact your dealer immediately.
- To avoid short circuits, keep paper clips, screws, and staples away from connectors, slots, sockets and circuitry.
- Avoid dust, humidity, and temperature extremes. Do not place the product in any area where it may become wet.
- Place the product on a stable surface.
- If you encounter technical problems with the product, contact a qualified service technician or your retailer.

# About this guide

This user guide contains the information you need when installing and configuring the motherboard.

## How this guide is organized

This manual contains the following parts:

- **Chapter 1: Product introduction**

This chapter describes the features of the P4C800-E Deluxe motherboard. It includes brief descriptions of the special attributes of the motherboard and the new technology it supports.
- **Chapter 2: Hardware information**

This chapter lists the hardware setup procedures that you have to perform when installing system components. It includes description of the switches, jumpers, and connectors on the motherboard.
- **Chapter 3: Powering up**

This chapter describes the power up sequence and gives information on the BIOS beep codes.
- **Chapter 4: BIOS setup**

This chapter tells how to change system settings through the BIOS Setup menus. Detailed descriptions of the BIOS parameters are also provided.
- **Chapter 5: Software support**

This chapter describes the contents of the support CD that comes with the motherboard package.



## Conventions used in this guide

To make sure that you perform certain tasks properly, take note of the following symbols used throughout this manual.



**WARNING:** Information to prevent injury to yourself when trying to complete a task.



**CAUTION:** Information to prevent damage to the components when trying to complete a task.



**IMPORTANT:** Information that you **MUST** follow to complete a task.



**NOTE:** Tips and additional information to aid in completing a task.

## Where to find more information

Refer to the following sources for additional information and for product and software updates.

### 1. ASUS Websites

The ASUS websites worldwide provide updated information on ASUS hardware and software products. The ASUS websites are listed in the ASUS Contact Information on page x.

### 2. Optional Documentation

Your product package may include optional documentation, such as warranty flyers, that may have been added by your dealer. These documents are not part of the standard package.

# ASUS contact information

## ASUSTeK COMPUTER INC. (Asia-Pacific)

Address: 150 Li-Te Road, Peitou, Taipei, Taiwan 112  
General Tel: +886-2-2894-3447  
General Fax: +886-2-2894-3449  
General Email: info@asus.com.tw

### *Technical Support*

MB/Others (Tel): +886-2-2890-7121 (English)  
Notebook (Tel): +886-2-2890-7122 (English)  
Desktop/Server (Tel): +886-2-2890-7123 (English)  
Support Fax: +886-2-2890-7698  
Web Site: www.asus.com.tw

## ASUS COMPUTER INTERNATIONAL (America)

Address: 44370 Nobel Drive, Fremont, CA 94538, USA  
General Fax: +1-502-933-8713  
General Email: tmd1@asus.com

### *Technical Support*

Support Fax: +1-502-933-8713  
General Support: +1-502-995-0883  
Notebook Support: +1-510-739-3777 x5110  
Web Site: usa.asus.com  
Support Email: tsd@asus.com

## ASUS COMPUTER GmbH (Germany and Austria)

Address: Harkortstr. 25, 40880 Ratingen, BRD, Germany  
General Email: sales@asuscom.de (for marketing requests only)  
General Fax: +49-2102-9599-31

### *Technical Support*

Support Hotlines: (Components) +49-2102-9599-0  
(Notebook PC) +49-2102-9599-10  
Support Fax: +49-2102-9599-11  
Support Email: www.asuscom.de/support (for online support)  
Web Site: www.asuscom.de

# P4C800-E Deluxe specifications summary

CPU	<p>Socket 478 for Intel® Pentium® 4/Celeron with speeds up to 3.2+ GHz</p> <p>On-die 512KB/256KB L2 cache with full speed</p> <p>Supports Intel® Hyper-Threading Technology</p> <p>New power design supports next generation Intel Prescott CPU</p>
Chipset	<p>Intel 875P MCH (features the <b>Intel Performance Acceleration Technology</b>)</p> <p>Intel ICH5R</p>
Front Side Bus (FSB)	800/533/400 MHz
Memory	<p>Dual-channel memory architecture</p> <p>4 x 184-pin DDR DIMM sockets for up to 4GB memory</p> <p>Supports PC3200/2700/2100 unbuffered ECC or non-ECC DDR DIMMs</p>
Expansion slots	<p>1 x AGP Pro/8X</p> <p>5 x PCI</p> <p>1 x Wi-Fi</p>
Storage	<p>Supported by South Bridge (ICH5R)</p> <ul style="list-style-type: none"> <li>- 2 x UltraDMA100 connectors</li> <li>- 2 x Serial ATA connectors (supports RAID0 configuration under Windows XP)</li> </ul> <p>Supported by Promise® PDC20378 controller (optional)</p> <ul style="list-style-type: none"> <li>- 1 x UltraDMA 133 connector</li> <li>- 2 x Serial ATA connectors</li> <li>- RAID0, RAID1, RAID0+1, Multi-RAID configurations</li> </ul>
IEEE 1394	<p>VIA 6307 IEEE 1394 controller</p> <ul style="list-style-type: none"> <li>- supports 2 x IEEE 1394 connectors</li> </ul>
LAN	Intel 82547EI Gigabit LAN controller
AI Audio	ADI AD1985 6-channel audio CODEC
AI BIOS	<p>AI BIOS solutions:</p> <ul style="list-style-type: none"> <li>ASUS CrashFree BIOS 2</li> <li>ASUS Q-Fan Technology</li> <li>ASUS POST Reporter™</li> </ul>
AI Overclocking	<p>Intelligent CPU frequency tuner</p> <p>ASUS JumperFree</p> <p>Adjustable CPU V<sub>CORE</sub>, memory, and AGP voltages</p> <p>SFS (Stepless Frequency Selection) from 100MHz to 400MHz at 1MHz increments</p> <p>C. P. R. (CPU Parameter Recall)</p>

*(continued on the next page)*

# P4C800-E Deluxe specifications summary

<b>Special features</b>	ASUS MyLogo2 ASUS EZ Flash ASUS Instant Music Power Loss Restart Multi-language BIOS
<b>Rear panel I/O</b>	1 x Parallel port 1 x Serial port 1 x PS/2 keyboard port 1 x PS/2 mouse port 1 x S/PDIF Out 1 x IEEE 1394 port (on 1394 models only) 4 x USB 2.0 ports 1 x RJ-45 port Line In/Line Out/Microphone ports
<b>Internal I/O</b>	2 x USB 2.0 connectors for 4 additional USB ports CPU/Power/Chassis fan connectors 20-pin/4-pin ATX 12V power connectors IDE LED/Power LED connectors Chassis intrusion connector 1 x IEEE 1394 connector (on 1394 models only) GAME/MIDI connector S/PDIF Out connector CD/AUX/Modem audio connectors Front panel audio connector Serial port 2 (COM2) connector
<b>BIOS features</b>	4Mb Flash ROM, AMI BIOS, PnP, DMI2.0, WfM2.0, SM BIOS2.3, Multi-language BIOS, ASUS EZ Flash, CrashFree BIOS 2, ASUS C.P.R., ASUS MyLogo2, ASUS Instant Music
<b>Industry standard</b>	PCI 2.2, PCI 2.3, USB 2.0
<b>Manageability</b>	WfM 2.0, DMI 2.0, WOL/WOR by PME, chassis intrusion
<b>Power requirement</b>	ATX power supply (with 4-pin 12V plug)
<b>Form Factor</b>	ATX form factor: 12 in x 9.6 in (30.5 cm x 24.5 cm)
<b>Support CD contents</b>	Device drivers ASUS PC Probe ASUS LiveUpdate Trend Micro™ PC-cillin 2002 anti-virus software

*Specifications are subject to change without notice.*

# *Chapter 1*

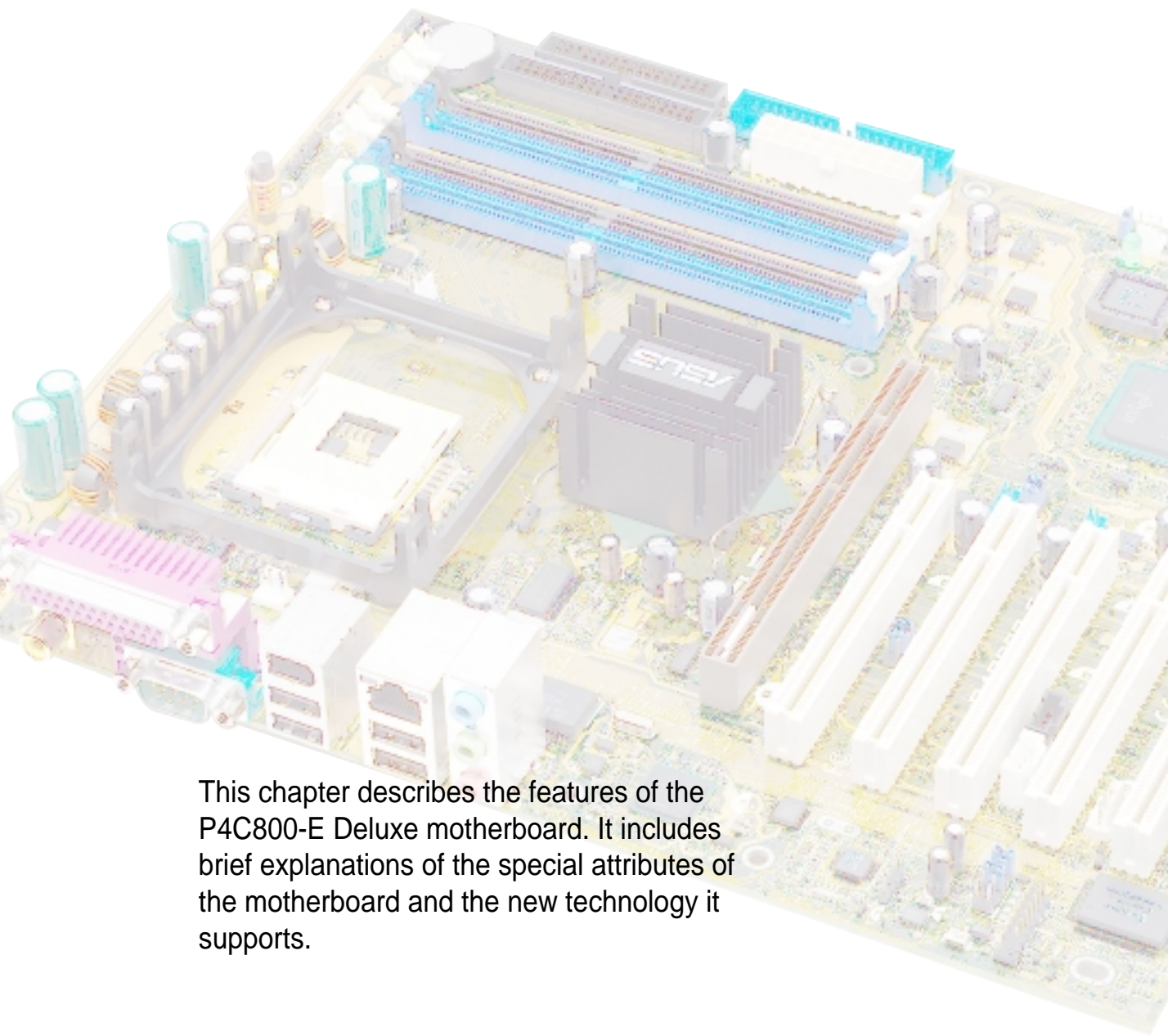

This chapter describes the features of the P4C800-E Deluxe motherboard. It includes brief explanations of the special attributes of the motherboard and the new technology it supports.

## **Product introduction**

## **Chapter summary**

<b>1.1</b>	<b>Welcome! .....</b>	<b>1-1</b>
<b>1.2</b>	<b>Package contents .....</b>	<b>1-1</b>
<b>1.3</b>	<b>Special features .....</b>	<b>1-2</b>
<b>1.4</b>	<b>Motherboard overview .....</b>	<b>1-6</b>

# 1.1 Welcome!

## Thank you for buying the ASUS® P4C800-E Deluxe motherboard!

The ASUS P4C800-E Deluxe motherboard delivers a host of new features and latest technologies making it another standout in the long line of ASUS quality motherboards!

The motherboard incorporates the Intel® Pentium® 4 Processor in 478-pin package coupled with the Intel® 875P chipset to set the latest trend for a powerful desktop platform solution.

Supporting 800 MHz FSB, up to 4GB of system memory with PC3200/2700/2100 DDR SDRAM, high-resolution graphics via an AGP Pro/8X slot, Serial ATA support, IEEE 1394, USB 2.0, and 6-channel audio features, the P4C800-E Deluxe is your perfect vehicle to get ahead in the world of power computing!

Before you start installing the motherboard, and hardware devices on it, check the items in your package with the list below.

## 1.2 Package contents

Check your P4C800-E Deluxe package for the following items.

- ✓ ASUS P4C800-E Deluxe motherboard
- ✓ ASUS support CD
- ✓ InterVideo WinDVD Suite *(retail boxes only)*
- ✓ 4 x SATA cable
- ✓ SATA power cable *(retail boxes only)*
- ✓ 2 x 80-conductor ribbon cables for UltraDMA133/100/66 IDE drives
- ✓ 40-conductor IDE cable
- ✓ Ribbon cable for a 3.5-inch floppy drive
- ✓ IEEE 1394 module
- ✓ 4-port USB2.0/GAME module
- ✓ I/O shield
- ✓ Bag of extra jumper caps
- ✓ User Guide
- ✓ Quick Reference Card *(last page of the User Guide)*
- ✓ Quick Setup Guide *(retail boxes only)*
- ✓ Jumpers and Connectors Sticker *(retail boxes only)*
- ✓ Instant Music keyboard label *(retail boxes only)*



---

If any of the above items is damaged or missing, contact your retailer.

---

## 1.3 Special features

### 1.3.1 Product highlights

#### Latest processor technology



The motherboard supports the latest Intel® Pentium® 4 Processor via a 478-pin surface mount ZIF socket. The Pentium 4 processor with 512KB L2 cache includes a 800/533/400 MHz system bus and features the Intel Hyper-Threading Technology and new power design that allow up to 3.2+GHz core frequencies. See page 2-4 for more information.

The motherboard will also support the next generation Intel Prescott CPU when available.

#### Dual-channel DDR400 memory support



Employing the dual-channel DDR memory architecture, the motherboard provides a solution that doubles the system memory bandwidth to boost system performance. The motherboard supports up to 4GB of system memory using PC3200/2700/2100 ECC or non-ECC DDR DIMMs to deliver up to 6.4GB/s data transfer rate for the latest 3D graphics, multimedia, and Internet applications. See page 2-10.

#### Intel Performance Acceleration Technology (PAT)



Incorporating the Intel PAT, which is a turbo mode enabled in the Intel 875P to work with DDR 400 memory and boost system performance, the motherboard delivers a new level of performance to beat.

#### Serial ATA technology



The motherboard supports the new Serial ATA technology through the SATA interfaces and the Intel ICH5R onboard, and allows RAID 0 configuration. The SATA specification allows for thinner, more flexible cables with lower pin count, reduced voltage requirement, and up to 150MB/s data transfer rate. See page 2-23.

#### Multi-RAID solution



The motherboard has the Promise® PDC20378 controller to support multi-RAID solution using Serial ATA/150 and Ultra ATA/133 hard disks. The RAID0 (striping), RAID1 (mirroring), and RAID 0+1 provide a cost-effective high-performance solution for added system performance and reliability.



## AGP 8X support

The motherboard supports the latest graphic architecture, the AGP Pro/8X interface (a.k.a. AGP 3.0), offering 2.1GB/s bandwidth which is twice that of its predecessor AGP 4X.

## Gigabit LAN solution

The Intel® 82547EI Gigabit Ethernet controller allows full-duplex Gigabit performance on LAN on Motherboard (LOM) applications through the Communication Streaming Architecture (CSA). Instead of connecting to the PCI bus, the controller connects to the dedicated CSA bus on the Memory Controller Hub (MCH) thus reducing the PCI bottlenecks by freeing the PCI bus for other I/O operations.

## AI Audio technology

The SoundMAX-class ADI AD1985 AC '97 audio CODEC supports 6-channel 5.1 surround sound output, stereo microphone input, variable Sample Rate Conversion (SRC), professional quality 103-dB out put with 94-dB SNR, and analog enumeration capability. The SoundMAX 4 XL software features the AudioESP™ (Audio Enumeration and Sensing Process) that allows intelligent detection of the peripherals plugged into the audio ports and identifies the incompatible devices, if any.

## AI Overclocking

This feature allows convenient overclocking up to 30% (depending on the installed CPU and DRAM) to enhance system performance while still maintaining system stability. See section “4.4.1 JumperFree Configuration” to set the BIOS items for overclocking.

## AI BIOS solution

The AI BIOS is a combination of three ASUS intelligent solutions: CrashFree BIOS2, Q-Fan, and POST Reporter.

## CrashFree BIOS 2

This feature allows you to restore the original BIOS data from the support CD, or from a bootable floppy disk, when the BIOS codes and data are corrupted. This protection eliminates the need to buy a replacement ROM chip. See page 4-4.

## ASUS Q-Fan technology



The ASUS Q-Fan technology smartly adjusts the fan speeds according to the system loading to ensure quiet, cool, and efficient operation.

## ASUS POST Reporter™



The motherboard offers a new exciting feature called the ASUS POST Reporter™ to provide friendly voice messages and alerts during the Power-On Self-Tests (POST) informing you of the system boot status and causes of boot errors, if any. The bundled Winbond Voice Editor software lets you to customize the voice messages in different languages.

## IEEE 1394 support



The IEEE 1394 interfaces and the VIA 6307 controller onboard provide high-speed and flexible PC connectivity to a wide range of peripherals and devices compliant to IEEE 1394a standards. The IEEE 1394 allows up to 400Mbps transfer rates through simple, low-cost, high-bandwidth asynchronous (real-time) data interfacing between computers, peripherals, and consumer electronic devices such as camcorders, VCRs, printers, TVs, and digital cameras. See page 2-31.

## USB 2.0 technology



The motherboard implements the Universal Serial Bus (USB) 2.0 specification, dramatically increasing the connection speed from the 12 Mbps bandwidth on USB 1.1 to a fast 480 Mbps on USB 2.0. USB 2.0 is backward compatible with USB 1.1. See page 2-30.

## C.P.R. (CPU Parameter Recall)



The C.P.R. feature of the motherboard BIOS allows automatic re-setting to the BIOS default settings in case the system hangs due to overclocking. When the system hangs due to overclocking, C.P.R. eliminates the need to open the system chassis and clear the RTC data. Simply shut down and reboot the system, and BIOS automatically restores the CPU default setting for each parameter.

## ASUS Instant Music



This unique feature allows you to playback audio files even before entering the operating system. Just press the ASUS Instant Music special function keys and enjoy the music!

## ASUS Multi-language BIOS



The multi-language BIOS allows you to select the language of your choice from the available options. The localized BIOS menus allow you to configure easier and faster. Visit the ASUS website for information on the supported languages.

## ASUS MyLogo2™



This new feature present in the motherboard allows you to personalize and add style to your system with customizable boot logos.

## ASUS EZ Flash BIOS



With the ASUS EZ Flash, you can easily update the system BIOS even before loading the operating system. No need to use a DOS-based utility or boot from a floppy disk.

## 1.3.2 Value-added solutions

### Temperature, fan, and voltage monitoring

The CPU temperature is monitored by the ASIC (integrated in the Winbond Super I/O) to prevent overheating and damage. The system fan rotations per minute (RPM) is monitored for timely failure detection. The system voltage levels are monitored to ensure stable supply of current for critical components.

### ACPI ready

The Advanced Configuration power Interface (ACPI) provides more energy saving features for operating systems that support OS Directed Power Management (OSPM).

### Chassis intrusion detection

The motherboard supports chassis intrusion monitoring through the Winbond ASIC. A chassis intrusion event is retained in CMOS for more protection.

### ASUS Update

This utility allows you to update the motherboard BIOS through a user-friendly interface. Connect to the Internet then to the ASUS FTP site nearest you to obtain the latest BIOS version for your motherboard.

## 1.4 Motherboard overview

Before you install the motherboard, familiarize yourself with its physical configuration and available features to facilitate the motherboard installation and future upgrades. A sufficient knowledge of the motherboard specifications will also help you avoid mistakes that may damage the board and its components.

### 1.4.1 Major components

The following are the major components of the P4C800-E Deluxe motherboard as pointed out in the picture on page 1-7.

- |                                     |                               |
|-------------------------------------|-------------------------------|
| 1. CPU socket                       | 18. Wi-Fi slot                |
| 2. North Bridge controller          | 19. Super I/O controller      |
| 3. ATX12V power connector           | 20. PCI slots                 |
| 4. DDR DIMM sockets                 | 21. Audio CODEC               |
| 5. Floppy disk connector            | 22. Gigabit LAN controller    |
| 6. IDE connectors                   | 23. PS/2 mouse port           |
| 7. ATX power connector              | 24. Parallel port             |
| 8. AGP Pro/8X slot                  | 25. IEEE 1394 port (optional) |
| 9. Standby power LED                | 26. RJ-45 port                |
| 10. Flash ROM                       | 27. Line In jack              |
| 11. Speech controller               | 28. Line Out jack             |
| 12. RAID Ultra ATA133 connector     | 29. Microphone jack           |
| 13. SATA connectors                 | 30. USB 2.0 ports 3 and 4     |
| 14. SATA RAID connectors            | 31. USB 2.0 ports 1 and 2     |
| 15. RAID/SATA/IDE controller        | 32. Serial port               |
| 16. South Bridge controller         | 33. S/PDIF out port           |
| 17. IEEE 1394 controller (optional) | 34. PS/2 keyboard port        |



---

See page 1-8 for the specifications of each component. Refer to Chapter 2 for detailed information on the components.

---

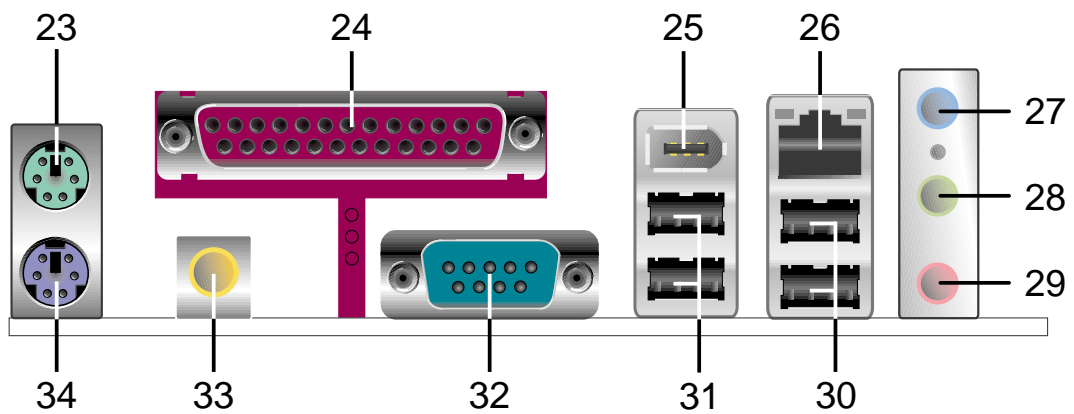
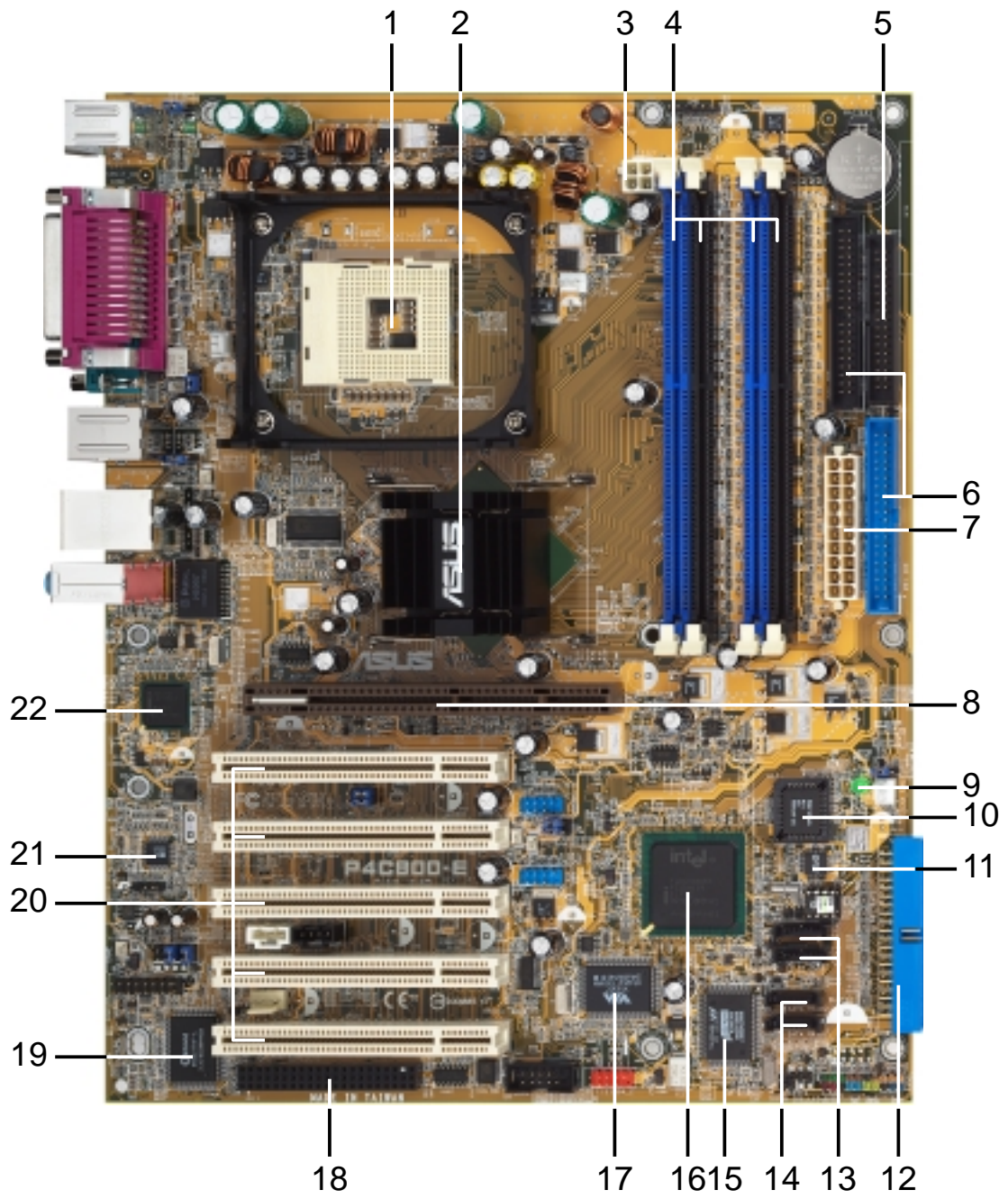

## 1.4.2 Core specifications

- 1 CPU socket.** A 478-pin surface mount, Zero Insertion Force (ZIF) socket for the Intel® Pentium® 4 Processor, with 800/533/400 MHz system bus that allows 6.4GB/s, 4.3GB/s, and 3.2GB/s data transfer rates, respectively. The socket will support the Intel Prescott CPU when available.
- 2 North bridge controller.** The Intel® 875P Memory Controller Hub (MCH) provides the CPU interface, DDR interface, AGP interface, and Hub Interface. The MCH manages the flow of information between these interfaces. Designed for use with the Intel® Pentium 4/Celeron processor, the MCH provides the processor interface with 800/533/400 MHz frequency, system memory interface with up to 6.4GB/s bandwidth in dual-channel mode, and 0.8V/1.5V AGP Interface Specification 3.0 that supports 8X/4X Fast Write protocol. The MCH interconnects to the south bridge ICH5R via the Intel® proprietary Hub Interface.
- 3 ATX 12V connector.** This power connector connects the 4-pin 12V plug from the ATX 12V power supply.
- 4 DDR DIMM sockets.** These four 184-pin DIMM sockets support up to 4GB system memory using unbuffered ECC or non-ECC PC3200/PC2700/PC2100 DDR DIMMs.
- 5 Floppy disk connector.** This connector accommodates the provided ribbon cable for the floppy disk drive. One side of the connector is slotted to prevent incorrect insertion of the floppy disk cable.
- 6 IDE connectors.** These dual-channel bus master IDE connectors support Ultra DMA/100/66, PIO Modes 3 & 4 IDE devices. Both the primary (blue) and secondary (black) connectors are slotted to prevent incorrect insertion of the IDE ribbon cable.
- 7 ATX power connector.** This 20-pin connector connects to an ATX 12V power supply. The power supply must have at least 1A on the +5V standby lead (+5VSB).
- 8 AGP Pro/8X slot.** This Accelerated Graphics Port (AGP) Pro slot supports 0.8V/1.5V AGP 8X mode graphics cards for 3D graphical applications and delivers up to 2.1GB/s bandwidth.
- 9 Standby power LED.** This LED lights up if there is a standby power on the motherboard. This LED acts as a reminder to turn off the system power before plugging or unplugging devices.
- 10 Flash ROM.** This 4Mb firmware hub (FWH) contains the programmable BIOS program.

- 11** **Speech controller.** This Winbond speech controller supports the ASUS POST Reporter™ for configurable vocal POST alerts.
- 12** **RAID Ultra ATA133 connector.** This connector supports two Ultra ATA133 HDDs. On RAID models, the HDDs on this connector may be configured as RAID0, RAID1, or RAID0+1 together with the Serial ATA HDDs on the SATA RAID connectors.
- 13** **SATA connectors.** These connectors support Serial ATA HDDs and allows for up to 150MB/s data transfer rate using the thin 4-conductor SATA cables. The HDDs may be configured as RAID 0 level storage under Windows XP operating system.
- 14** **SATA RAID connectors.** These connectors support Serial ATA HDDs and may be configured as RAID0, RAID1, RAID0+1. Together with the UltraDMA133 devices, if present, the SATA RAID devices may be set up as a multi-RAID configuration. *(on RAID models only)*
- 15** **RAID/SATA/IDE controller.** The Promise® PDC20378 RAID controller provides high-performance RAID0/RAID1/RAID0+1 functionality and complies with the Serial ATA and UltraDMA 133 specifications. *(on RAID models only)*
- 16** **South bridge controller.** The fifth-generation Intel I/O Controller Hub (ICH5R) is a subsystem that integrates various I/O functions including 2-channel ATA/100 bus master IDE controller, SATA RAID controller, up to eight USB 2.0/1.1 ports, I/O APIC, LPC interface, AC'97 2.3 interface, and PCI 2.2/2.3 interface. The ICH5 also contains the necessary arbitration and buffering for efficient utilization of these interfaces.
- 17** **IEEE 1394 controller.** The VIA VT6307 controller chipset supports two low power IEEE 1394 connectors to allow 100Mbps, 200Mbps, and 400Mbps data transfers between the 1394 devices. *(on 1394 models only)*
- 18** **Wi-Fi slot.** The Wi-Fi (**Wireless Fidelity**) slot connects a Wi-Fi equipment for wireless networking that allows 11Mbps transmission (with a fallback to 5.5, 2, and 1 Mbps) in the 2.4 GHz band. Wi-Fi networks use radio technologies known as IEEE 802.11b (or later) to provide a fast reliable wireless connectivity.
- 19** **Super I/O controller.** This Winbond Low Pin Count (LPC) interface provides the commonly used Super I/O functionality. The chipset supports a high-performance floppy disk controller for a 360K/720K/1.44M/2.88M floppy disk drive, a multi-mode parallel port, two standard compatible UARTs, and a Flash ROM interface. This controller also integrates the ASIC for PC health monitoring.

- 20** **PCI slots.** These five 32-bit PCI 2.2 expansion slots support bus master PCI cards like SCSI or LAN cards with 133MB/s maximum throughput.
- 21** **Audio CODEC.** The AD1985 AC '97 2.3 stereo audio CODEC provides a 6-channel audio capability. The CODEC supports surround sound output, variable sample rate conversion, analog enumeration capability, and other major audio technologies for a complete integrated audio solution.
- 22** **Gigabit LAN controller.** The Intel® 82547EI Gigabit Ethernet controller allows full-duplex Gigabit performance on LAN on Motherboard (LOM) applications through the Communication Streaming Architecture (CSA). The controller combines Intel's fifth-generation Gigabit MAC design integrated with physical layer circuitry (PHY) to support 1000BASE-T, 100BASE-TX, and 10BASE-T applications.
- 23** **PS/2 mouse port.** This green 6-pin connector is for a PS/2 mouse.
- 24** **Parallel port.** This 25-pin port connects a parallel printer, a scanner, or other devices.
- 25** **IEEE 1394 port.** This port connects IEEE 1394-compliant devices like camcorders, VCRs, printers, or digital cameras. *(on 1394 models only)*
- 26** **RJ-45 port.** This port allows connection to a Local Area Network (LAN) through a network hub.
- 27** **Line In jack.** This Line In (light blue) jack connects a tape player or other audio sources. In 6-channel mode, the function of this jack becomes Rear Speaker Out.
- 28** **Line Out jack.** This Line Out (lime) jack connects a headphone or a speaker. In 6-channel mode, the function of this jack becomes Front Speaker Out.
- 29** **Microphone jack.** This Mic (pink) jack connects a microphone. In 6-channel mode, the function of this jack becomes Bass/Center.
- 30** **USB 2.0 ports 3 and 4.** These 4-pin Universal Serial Bus (USB) ports are available for connecting USB 2.0 devices.
- 31** **USB 2.0 ports 1 and 2.** These 4-pin Universal Serial Bus (USB) ports are available for connecting USB 2.0 devices.
- 32** **Serial port.** This 9-pin COM1 port is for pointing devices or other serial devices.
- 33** **S/PDIF out port.** This connector supports S/PDIF devices that provides 5.1-channel surround sound and 3D audio.
- 34** **PS/2 keyboard port.** This purple connector is for a PS/2 keyboard.



# *Chapter 2*

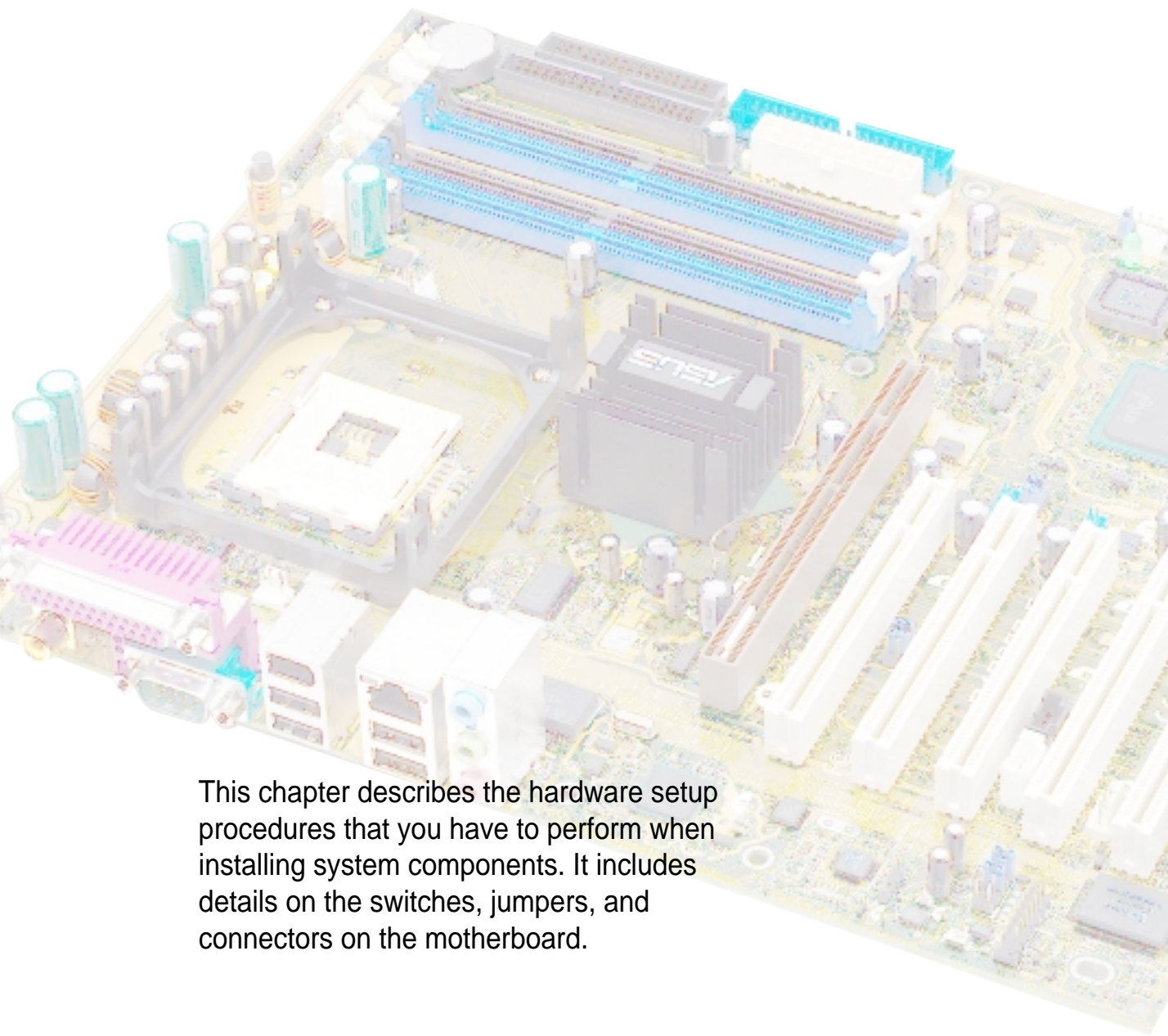

This chapter describes the hardware setup procedures that you have to perform when installing system components. It includes details on the switches, jumpers, and connectors on the motherboard.

## **Hardware information**

## **Chapter summary**

<b>2.1</b>	<b>Motherboard installation .....</b>	<b>2-1</b>
<b>2.2</b>	<b>Motherboard layouts .....</b>	<b>2-2</b>
<b>2.3</b>	<b>Before you proceed .....</b>	<b>2-3</b>
<b>2.4</b>	<b>Central Processing Unit (CPU) .....</b>	<b>2-4</b>
<b>2.5</b>	<b>System memory .....</b>	<b>2-10</b>
<b>2.6</b>	<b>Expansion slots .....</b>	<b>2-14</b>
<b>2.7</b>	<b>Jumpers .....</b>	<b>2-19</b>
<b>2.8</b>	<b>Connectors .....</b>	<b>2-21</b>

## 2.1 Motherboard installation

Before you install the motherboard, study the configuration of your chassis to ensure that the motherboard fits into it. The motherboard uses the ATX form factor that measures 12 inches x 9.6 inches (30.5 x 24.5 cm).



Make sure to unplug the power cord before installing or removing the motherboard. Failure to do so may cause you physical injury and damage motherboard components.

### 2.1.1 Placement direction

When installing the motherboard, make sure that you place it into the chassis in the correct orientation. The edge with external ports goes to the rear part of the chassis as indicated in the image below.

### 2.1.2 Screw holes

Place nine (9) screws into the holes indicated by circles to secure the motherboard to the chassis.



Do not overtighten the screws! Doing so may damage the motherboard.

Place this side towards  
the rear of the chassis

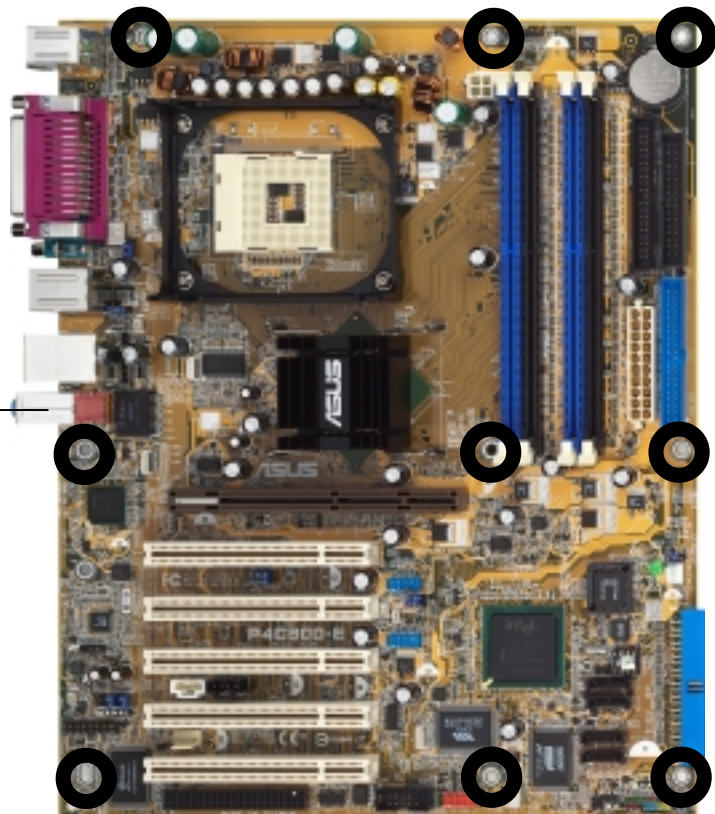

## 2.2 Motherboard layout

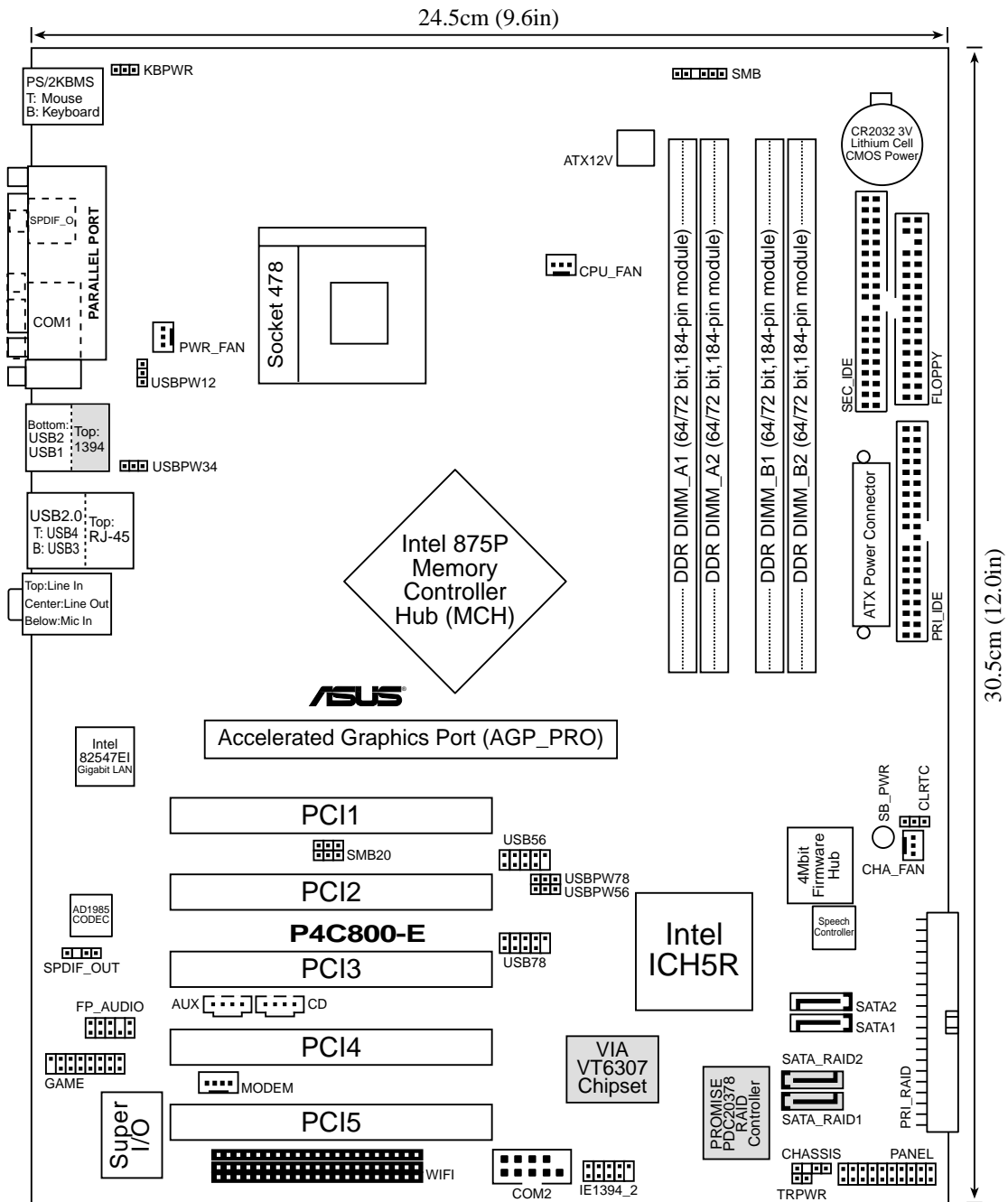

The RAID and 1394 features are optional. These components are grayed out in the above motherboard layout.

## 2.3 Before you proceed

Take note of the following precautions before you install motherboard components or change any motherboard settings.



1. Unplug the power cord from the wall socket before touching any component.
2. Use a grounded wrist strap or touch a safely grounded object or to a metal object, such as the power supply case, before handling components to avoid damaging them due to static electricity.
3. Hold components by the edges to avoid touching the ICs on them.
4. Whenever you uninstall any component, place it on a grounded antistatic pad or in the bag that came with the component.
5. **Before you install or remove any component, ensure that the ATX power supply is switched off or the power cord is detached from the power supply.** Failure to do so may cause severe damage to the motherboard, peripherals, and/or components.



When lit, the green LED (SB\_PWR) indicates that the system is ON, in sleep mode, or in soft-off mode, a reminder that you should shut down the system and unplug the power cable before removing or plugging in any motherboard component.

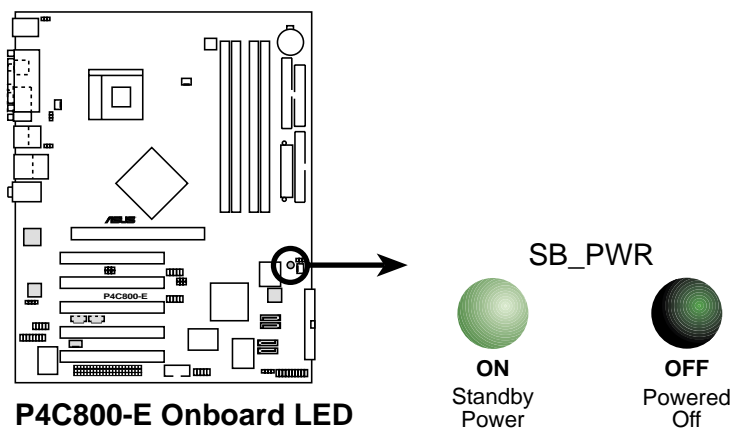

## 2.4 Central Processing Unit (CPU)

### 2.4.1 Overview

The motherboard comes with a surface mount 478-pin Zero Insertion Force (ZIF) socket. The socket is designed for the Intel® Pentium® 4 Processor in the 478-pin package with 512KB L2 cache. The Pentium 4 processor features the Intel® NetBurst™ micro-architecture, Hyper-Threading Technology, and 800/533/400MHz system bus. Together, these attributes improve system performance by allowing higher core frequencies, faster execution of integer instructions, and data transfer rates up to 6.4GB/s. The socket will also support the Intel Prescott CPU when available.

Note in the illustration that the CPU has a gold triangular mark on one corner. This mark indicates the processor Pin 1 that should match a specific corner of the CPU socket.

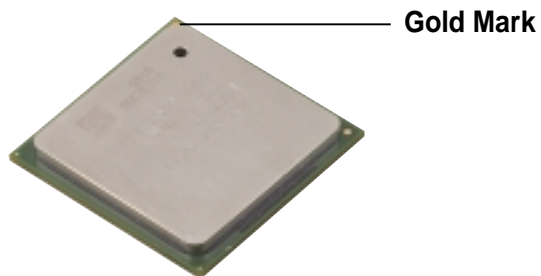

---

Incorrect installation of the CPU into the socket may bend the pins and severely damage the CPU!

---

### Notes on Intel® Hyper-Threading Technology



1. This motherboard supports Intel Pentium 4 CPUs with Hyper-Threading Technology.
  2. Hyper-Threading Technology is supported under **Windows XP** and **Linux 2.4.x (kernel)** and later versions only. Under Linux, use the Hyper-Threading compiler to compile the code. If you are using any other operating systems, disable the Hyper-Threading Technology item in BIOS to ensure system stability and performance.
  3. It is recommended that you install WinXP Service Pack 1.
  4. Make sure to enable the Hyper-Threading Technology item in BIOS before installing a supported operating system.
  5. For more information on Hyper-Threading Technology, visit [www.intel.com/info/hyperthreading](http://www.intel.com/info/hyperthreading).
-

## To use the Hyper-Threading Technology on this motherboard:

1. Buy an Intel Pentium 4 CPU that supports Hyper-Threading Technology. Install the CPU.
2. Power up the system and enter BIOS Setup (see Chapter 4). Under the Advanced Menu, make sure that the item **Hyper-Threading Technology** is set to Enabled. The item appears only if you installed a CPU that supports Hyper-Threading Technology.
3. Reboot the computer.

### 2.4.2 Installing the CPU

Follow these steps to install a CPU.

1. Locate the 478-pin ZIF socket on the motherboard.

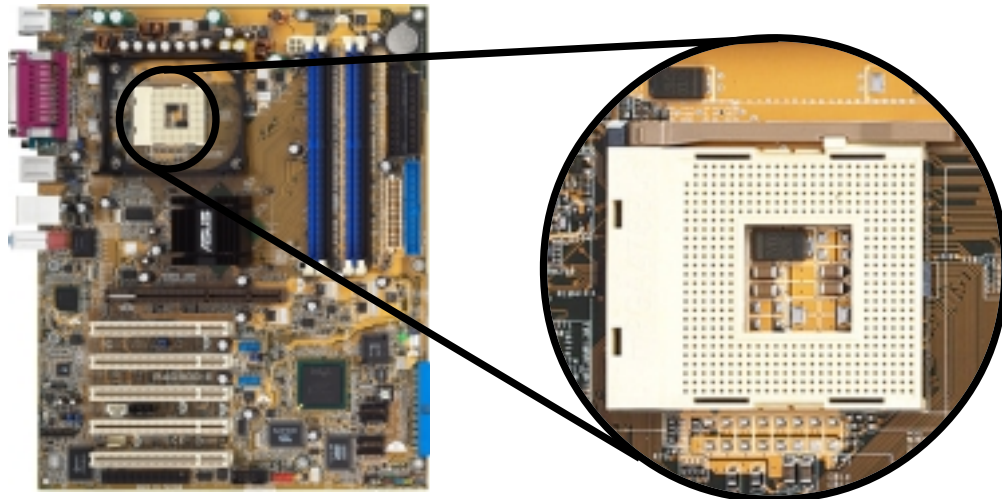

2. Unlock the socket by pressing the lever sideways, then lift it up to a 90°-100° angle.

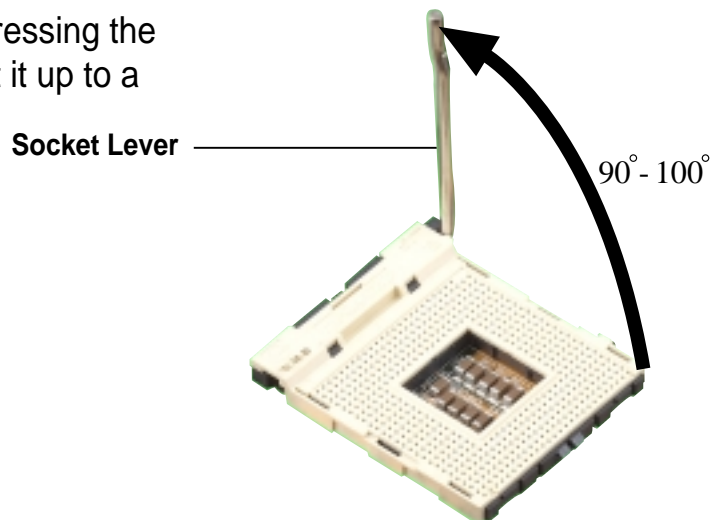

Make sure that the socket lever is lifted up to 90°-100° angle, otherwise the CPU does not fit in completely.

3. Position the CPU above the socket such that its marked corner matches the base of the socket lever.
4. Carefully insert the CPU into the socket until it fits in place.

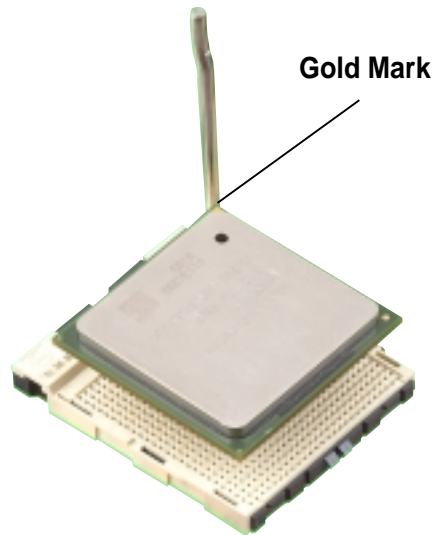

---

The CPU fits only in one correct orientation. **DO NOT** force the CPU into the socket to prevent bending the pins and damaging the CPU!

---

5. When the CPU is in place, push down the socket lever to secure the CPU. The lever clicks on the side tab to indicate that it is locked.

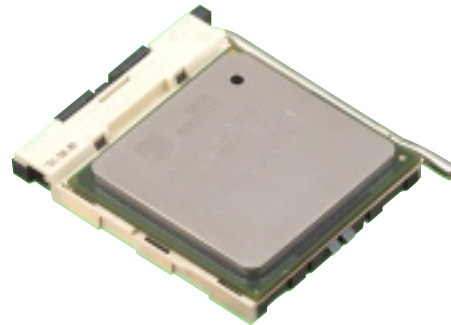



## 2.4.3 Installing the heatsink and fan

The Intel® Pentium® 4 Processor requires a specially designed heatsink and fan assembly to ensure optimum thermal condition and performance.



---

When you buy a boxed Intel Pentium 4 Processor, the package includes the heatsink, fan, and retention mechanism.

In case you buy a CPU separately, make sure that you use only Intel certified heatsink and fan.

---

Follow these steps to install the CPU heatsink and fan.

1. Place the heatsink on top of the installed CPU, making sure that the heatsink fits properly on the retention module base.



---

The retention module base is already installed on the motherboard upon purchase.

You do not have to remove the retention module base when installing the CPU or installing other motherboard components.

---

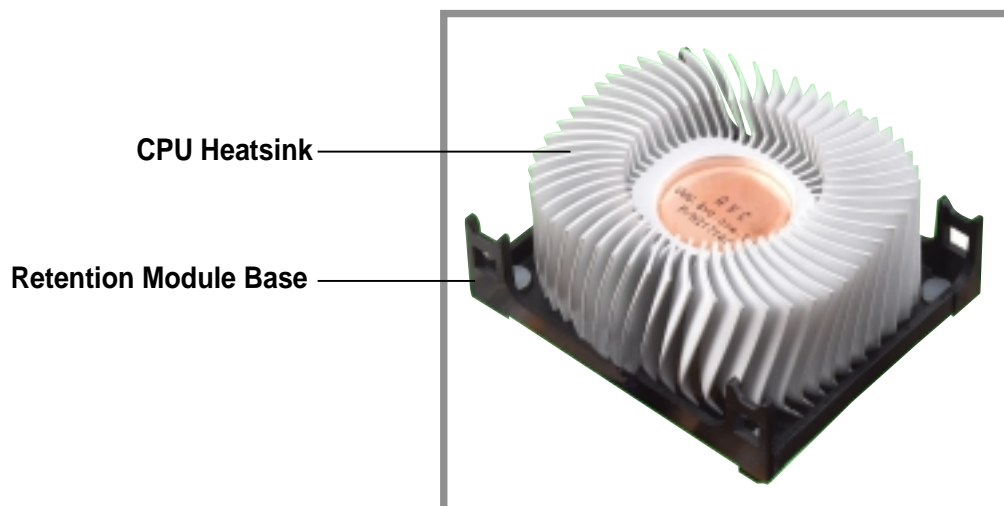

---

Your boxed Intel Pentium 4 Processor package should come with installation instructions for the CPU, heatsink, and the retention mechanism. If the instructions in this section do not match the CPU documentation, follow the latter.

---

2. Position the fan with the retention mechanism on top of the heatsink. Align and snap the four hooks of the retention mechanism to the holes on each corner of the module base.



---

Make sure that the fan and retention mechanism assembly perfectly fits the heatsink and module base, otherwise you cannot snap the hooks into the holes.

---

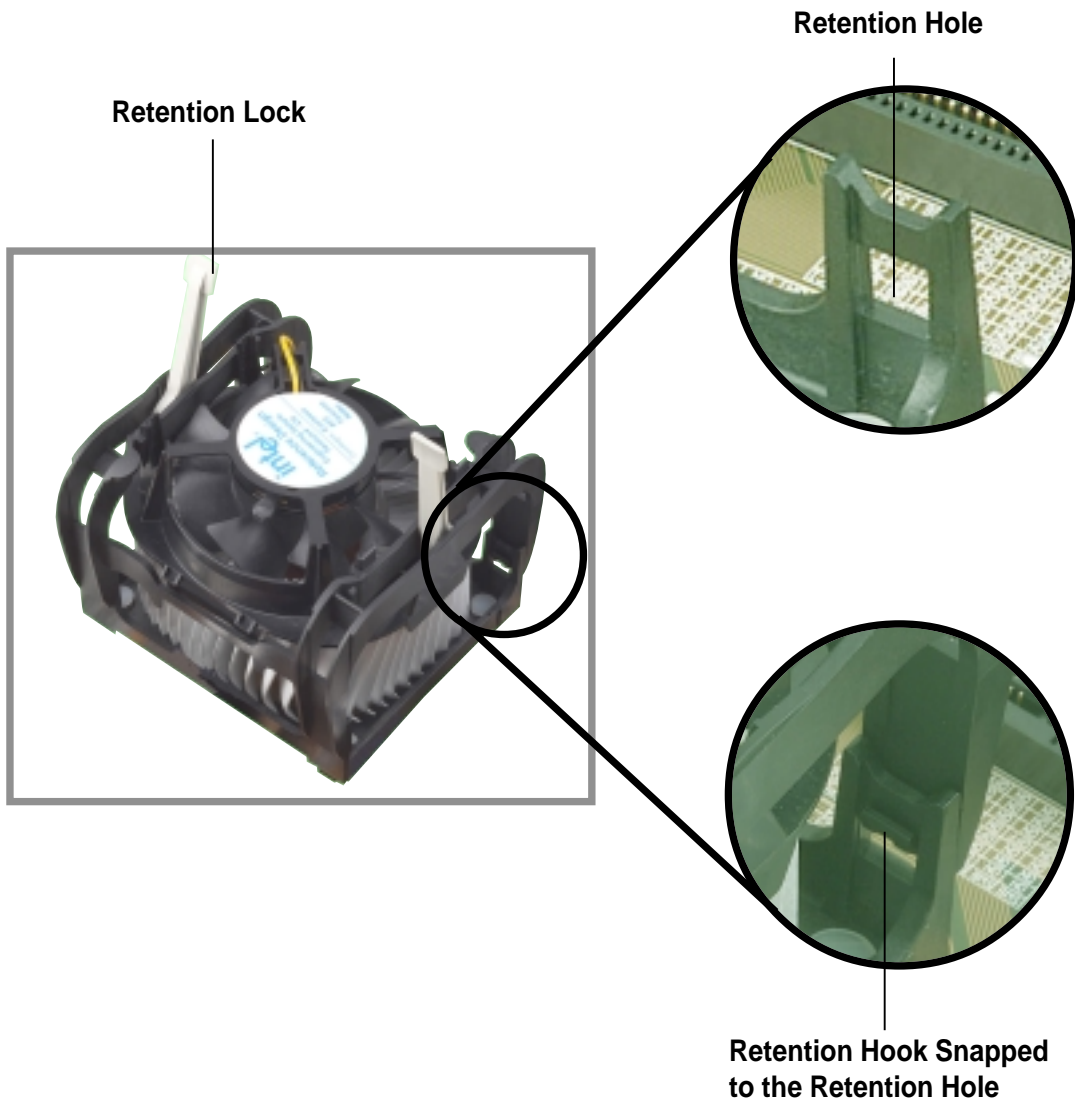

---

Keep the retention locks lifted upward while fitting the retention mechanism to the module base.

---

3. Push down the locks on the retention mechanism to secure the heatsink and fan to the module base.



---

When secure, the retention locks should point to opposite directions.

---



## 2.4.4 Connecting the CPU fan cable

When the fan, heatsink, and the retention mechanism are in place, connect the CPU fan cable to the connector on the motherboard labeled CPU\_FAN.

CPU Fan Connector  
(CPU\_FAN)

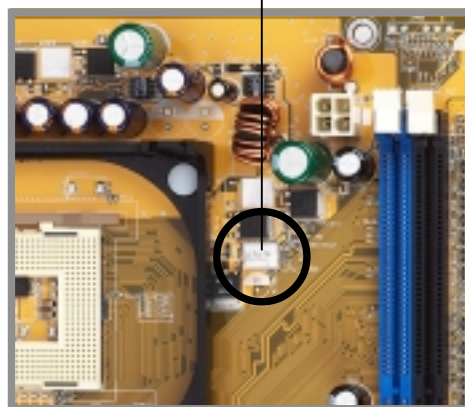

---

Don't forget to connect the CPU fan connector! Hardware monitoring errors may occur if you fail to plug this connector.

---

## 2.5 System memory

### 2.5.1 Overview

The motherboard comes with four Double Data Rate (DDR) Dual Inline Memory Module (DIMM) sockets. These sockets support up to 4GB system memory using 184-pin unbuffered ECC or non-ECC PC3200/PC2700/PC2100 DDR DIMMs, and allow up to 6.4GB/s data transfer rate.

The following figure illustrates the location of the DDR DIMM sockets.

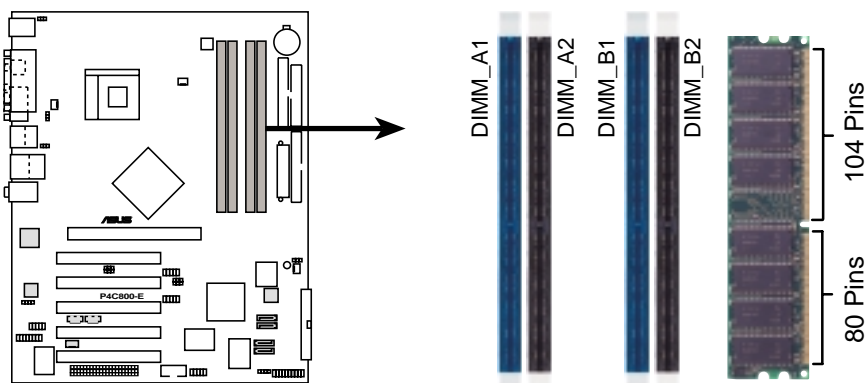

P4C800-E 184-Pin DDR DIMM Sockets

### 2.5.2 Memory configurations

You may install 64MB, 128MB, 256MB, 512MB, and 1GB DDR DIMMs into the DIMM sockets using the memory configurations in this section.

#### Important notes



1. Installing DDR DIMMs other than the recommended configurations may cause memory sizing error or system boot failure. Use any of the recommended configurations in Table 1.
2. In dual-channel configurations, install only **identical** (the same type and size) DDR DIMM pairs for each channel.
3. Always install DIMMs with the same CAS latency. For optimum compatibility, it is recommended that you obtain memory modules from the same vendor.
4. Make sure that the memory frequency matches the CPU FSB (Front Side Bus). Refer to Table 2.
5. DIMMs installed into **any three** sockets will function in single-channel mode.
6. When all four sockets are populated with 1GB DIMMs (total 4GB), the system may detect only 3+GB (a little less than 4GB) due to ICH5R resource allocation.

**Table 1 Recommended memory configurations**

Mode		Sockets			
		DIMM_A1 (blue)	DIMM_A2 (black)	DIMM_B1 (blue)	DIMM_B2 (black)
Single-channel	(1)	Populated	—	—	—
	(2)	—	Populated	—	—
	(3)	—	—	Populated	—
	(4)	—	—	—	Populated
Dual-channel	(1)	Populated	—	Populated	—
	(2)	—	Populated	—	Populated
	(3)*	Populated	Populated	Populated	Populated

\* For dual-channel configuration (3), you may:

- install identical DIMMs in all four sockets
- or*
- install identical DIMM pair in DIMM\_A1 and DIMM\_B1 (blue sockets) and identical DIMM pair in DIMM\_A2 and DIMM\_B2 (black sockets)

**Table 2 Memory frequency/CPU FSB synchronization**

CPU FSB	DDR DIMM Type	Memory Frequency
800 MHz	PC3200/PC2700*/PC2100	400/333*/266 MHz
533 MHz	PC2700/PC2100	333/266 MHz
400 MHz	PC2100	266 MHz



\*When using 800MHz CPU FSB, PC2700 DDR DIMMs may run only at 320MHz (not 333MHz) due to chipset limitation.

**Table 3 DDR400 Qualified Vendor List (QVL)**

Size	Vendor	Model	Brand	Component	Max. DIMMs
256MB	Transcend	TS32MLD64V4F3	Samsung	K4H560838D-TCC4	2
512MB	Transcend	TS64MLD64V4F3	Samsung	K4H560838D-TCC4	2
256MB	Transcend	TS32MLD64V4F3	Mosel	V58C2256804SAT5	4
512MB	Transcend	TS64MLD64V4F3	Mosel	V58C2256804SAT5	2
256MB	Kingston	KVR400X64C25/256	Winbond	W942508BH-5	4
512MB	Kingston	KVR400X64C25/512	Winbond	W942508BH-5	2
256MB	Kingston	KVR400X72C25/256	Winbond	W942508BH-5(ECC)	2
512MB	Kingston	KVR400X72C25/512	Winbond	W942508BH-5(ECC)	2
256MB	Winbond	W9425GCDB-5	Winbond	W942508CH-5	4
512MB	Winbond	W9451GCDB-5	Winbond	W942508CH-5	4
128MB	Infineon	HYS64D16301GU-5-B	Infineon	HYB25D256160BT-5B	4
256MB	Infineon	HYS64D32300GU-5-B	Infineon	HYB25D256800BT-5B	4
512MB	Infineon	HYS64D64320GU-5-B	Infineon	HYB25D256800BT-5B	2
256MB	Samsung	M381L3223ETM-CCC	Samsung	K4H560838E-TCCC(ECC)	4
512MB	Samsung	M381L6423ETM-CCC	Samsung	K4H560838E-TCCC(ECC)	4
128MB	Micron	MT8VDDT1664AG-403B2	Micron	MT46V16M8-5ESB	1
256MB	Micron	MT16VDDT3264AG-403B2	Micron	MT46V16M8-5ESB	1
256MB	Micron	MT16VDDT3264AG-403B5	Micron	MT46V16M8-5TESB	2
256MB	Hynix	HYMD232646B8J-D43 AA	Hynix	HY5DU56822BT-D43	4
512MB	Hynix	HYMD264646B8J-D43 AA	Hynix	HY5DU56822BT-D43	4
256MB	TwinMos	M2G9I08AFATT9F081AA4T	TwinMos	TMD7608F8E50D	1
512MB	TwinMos	M2G9J16AGATT9F081AA4T	TwinMos	TMD7608F8E50D	1
256MB	Apacer	77.10636.465	Samsung	K4H560838D-TCC4	4
512MB	Apacer	77.10736.464	Samsung	K4H560838D-TCC4	2
256MB	ADATA	MDOAD5F3G315B1ECZ	ADATA	ADD8608A8A-5B	2
256MB	ADATA	MDOSS6F3G31JB1EAE	Samsung	K4H560838D-TCC4	2
256MB	ADATA	MDOWB5F3G316B1EAE	Winbond	W942508BH-5	4
512MB	PSC	AL6D8A53T1-5B	PSC	A2S56D30ATP	4
256MB	CORSAIR	CMX256A-3500C2	Winbond	W942508BH-5	2
512MB	CORSAIR	CMX512-3500C2	Winbond	W942508BH-5	2
512MB	KINGMAX	MPXC22D-38KT3R	Kingmax	KDL388P4EA-50	1
256MB	Micron	MT8VDDT3264AG-40BC4	Micron	MT46V32M8TG-5BC	4
512MB	Micron	MT16VDDT6464AG-40BC4	Micron	MT46V32M8TG-5BC	4
256MB	ATP	AG32L64T8SQC4S	Samsung	K4H560838D-TCC4	1
512MB	ATP	AG64L64T8SQC4S	Samsung	K4H560838D-TCC4	1
512MB	TAKEMS	MS64D64020U-5	TAKEMS	MS25D25680S-5	2
256MB	OCZ	N/A	OCZ	X4W560840A-40	2



Obtain DDR DIMMs only from ASUS qualified vendors for better system performance. Visit the ASUS website ([www.asus.com](http://www.asus.com)) for the latest QVL.

## 2.5.3 Installing a DIMM



Make sure to unplug the power supply before adding or removing DIMMs or other system components. Failure to do so may cause severe damage to both the motherboard and the components.

Follow these steps to install a DIMM.

1. Unlock a DIMM socket by pressing the retaining clips outward.
2. Align a DIMM on the socket such that the notch on the DIMM matches the break on the socket.

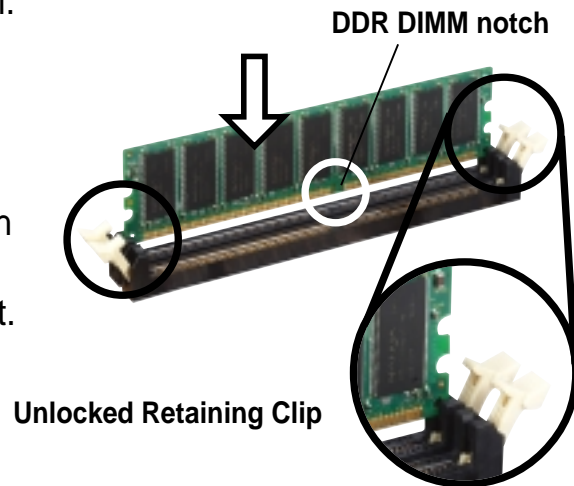

A DDR DIMM is keyed with a notch so that it fits in only one direction. DO NOT force a DIMM into a socket to avoid damaging the DIMM.

3. Firmly insert the DIMM into the socket until the retaining clips snap back in place and the DIMM is properly seated.

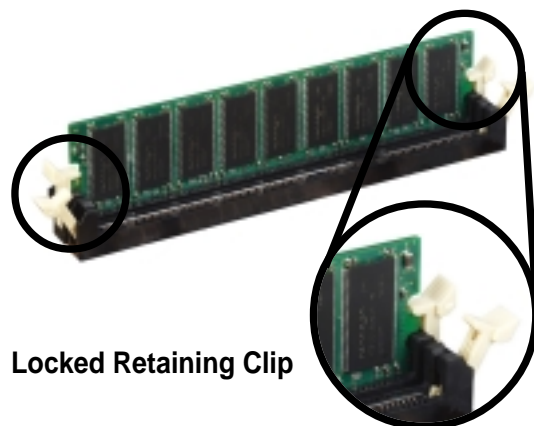

## 2.5.4 Removing a DIMM

Follow these steps to remove a DIMM.

1. Simultaneously press the retaining clips outward to unlock the DIMM.

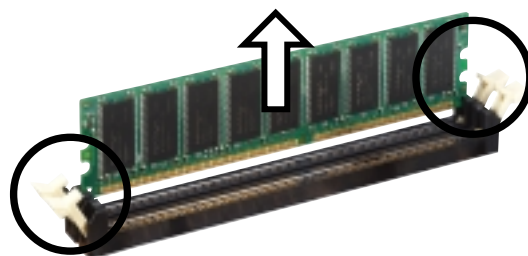

Support the DIMM lightly with your fingers when pressing the retaining clips. The DIMM might get damaged when it flips out with extra force.

2. Remove the DIMM from the socket.

## 2.6 Expansion slots

In the future, you may need to install expansion cards. The motherboard has five PCI slots, one Accelerated Graphics Port (AGP) Pro slot, and a Wi-Fi slot. The following sub-sections describe the slots and the expansion cards that they support.



---

Make sure to unplug the power cord before adding or removing expansion cards. Failure to do so may cause you physical injury and damage motherboard components.

---

### 2.6.1 Installing an expansion card

Follow these steps to install an expansion card.

1. Before installing the expansion card, read the documentation that came with it and make the necessary hardware settings for the card.
2. Remove the system unit cover (if your motherboard is already installed in a chassis).
3. Remove the bracket opposite the slot that you intend to use. Keep the screw for later use.
4. Align the card connector with the slot and press firmly until the card is completely seated on the slot.
5. Secure the card to the chassis with the screw you removed earlier.
6. Replace the system cover.

### 2.6.2 Configuring an expansion card

After installing the expansion card, configure the it by adjusting the software settings.

1. Turn on the system and change the necessary BIOS settings, if any. See Chapter 4 for information on BIOS setup.
2. Assign an IRQ to the card. Refer to the tables on the next page.
3. Install the software drivers for the expansion card.



## Standard Interrupt Assignments

IRQ	Priority	Standard Function
0	1	System Timer
1	2	Keyboard Controller
2	N/A	Programmable Interrupt
3*	11	Communications Port (COM2)
4*	12	Communications Port (COM1)
5*	13	Sound Card (sometimes LPT2)
6	14	Floppy Disk Controller
7*	15	Printer Port (LPT1)
8	3	System CMOS/Real Time Clock
9*	4	ACPI Mode when used
10*	5	IRQ Holder for PCI Steering
11*	6	IRQ Holder for PCI Steering
12*	7	PS/2 Compatible Mouse Port
13	8	Numeric Data Processor
14*	9	Primary IDE Channel
15*	10	Secondary IDE Channel

\* These IRQs are usually available for ISA or PCI devices.

## IRQ assignments for this motherboard

	A	B	C	D	E	F	G	H
PCI slot 1	—	—	—	—	—	shared	—	—
PCI slot 2	—	—	—	—	—	—	shared	—
PCI slot 3	—	—	—	—	—	—	—	shared
PCI slot 4	—	—	—	—	shared	—	—	—
PCI slot 5	—	—	—	—	—	shared	—	—
AGP Pro slot	shared	used	—	—	—	—	—	—
Onboard USB controller HC0	shared	—	—	—	—	—	—	—
Onboard USB controller HC1	—	—	—	used	—	—	—	—
Onboard USB controller HC2	—	—	used	—	—	—	—	—
Onboard USB controller HC3	shared	—	—	—	—	—	—	—
Onboard USB 2.0 controller	—	—	—	—	—	—	—	shared
Onboard LAN (optional)	—	—	—	—	—	—	shared	—
Onboard SATA (optional)	—	—	—	—	—	—	—	shared
Onboard 1394 (optional)	—	—	—	—	shared	—	—	—



When using PCI cards on shared slots, ensure that the drivers support “Share IRQ” or that the cards do not need IRQ assignments.

Otherwise, conflicts will arise between the two PCI groups, making the system unstable and the card inoperable.

## 2.6.3 PCI slots

There are five 32-bit PCI slots on this motherboard. The slots support PCI cards such as a LAN card, SCSI card, USB card, and other cards that comply with PCI specifications.

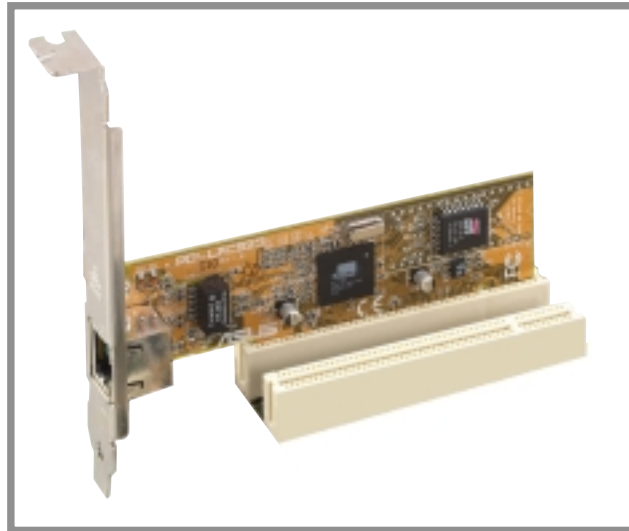

- 
1. The PCI 5 slot and the Wi-Fi slot may not be used at the same time.
  2. When installing long PCI cards, it is recommended that you install them in PCI slots 1, 2, or 5. Long PCI cards installed in PCI slots 3 and 4 may interfere with the SATA and GAME connectors.
-

## 2.6.4 AGP Pro slot

This motherboard has an Accelerated Graphics Port (AGP) Pro slot that supports AGP 8X (+0.8V) cards and AGP 4X (+1.5V) cards. When you buy an AGP card, make sure that you ask for one with +0.8V or +1.5V specification.

Note the notches on the card golden fingers to ensure that they fit the AGP slot on your motherboard.



---

Install only +0.8V or +1.5V AGP cards. This motherboard does not support 3.3V AGP cards.

---

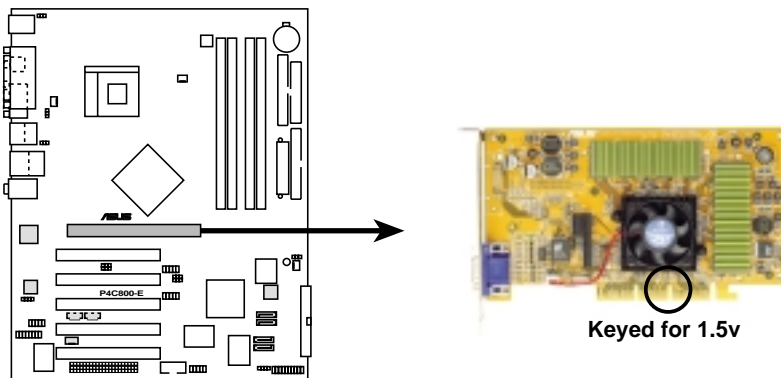

**P4C800-E Accelerated Graphics Port (AGP)**



---

If installing the ATi 9500 or 9700 Pro Series VGA cards, use only the card version **PN xxx-xxxxx-30** or later, for optimum performance and overclocking stability.

---



## 2.6.5 Wi-Fi slot

The Wi-Fi (Wireless Fidelity) slot will support the ASUS Wi-Fi module when available. Visit the ASUS website ([www.asus.com](http://www.asus.com)) for product updates.

The Wi-Fi slot conforms to the Institute of Electrical and Electronics Engineers (IEEE) 802.11b standard for wireless devices operating in the 2.4 GHz frequency band.

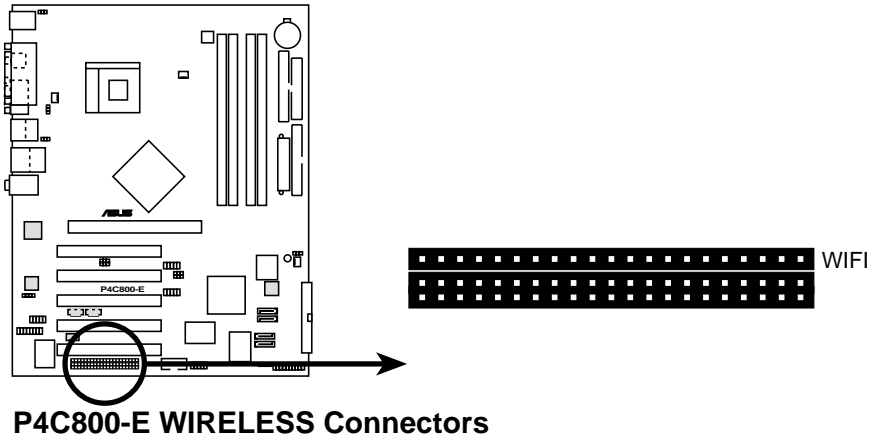

---

The PCI 5 slot and the Wi-Fi slot may not be used at the same time.

---

### IEEE 802.11b introduction

The IEEE 802.11b standard includes provisions for three radio technologies: direct sequence spread spectrum, frequency hopping spread spectrum, and infrared. Devices that comply with the 802.11b standard operate at data rates of up to 11 Mbps for direct sequence spread spectrum.

The IEEE 802.11b specification allocates the 2.4 GHz frequency band into 14 overlapping operating channels. Each Channel corresponds to a different set of frequencies. If operating multiple 802.11b wireless PCI cards in the same vicinity, the distance between the center frequencies must be at least 25 MHz to avoid interference.

The channels available to an 802.11b wireless PCI card will vary from country to country. In the United States, the 802.11b standard allocates 11 operating channels for direct sequence devices. Channels 1, 6, and 11 are independent and do not overlap with each other.

## 2.7 Jumpers

### 1. Keyboard power (3-pin KBPWR)

This jumper allows you to enable or disable the keyboard wake-up feature. Set this jumper to pins 2-3 (+5VSB) if you wish to wake up the computer when you press a key on the keyboard (the default is the Space Bar). This feature requires an ATX power supply that can supply at least 1A on the +5VSB lead, and a corresponding setting in the BIOS (see section 4.5.1 Power Up Control).

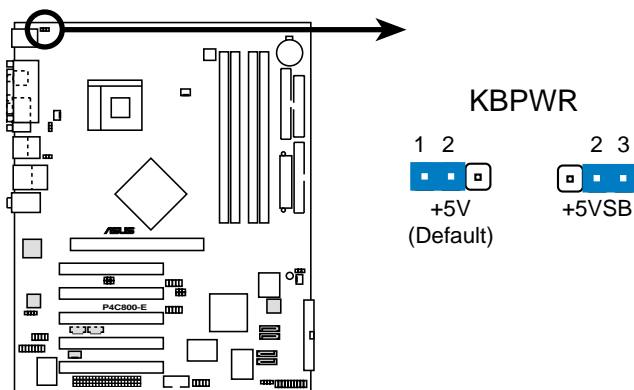

**P4C800-E Keyboard Power Setting**

### 2. Clear RTC RAM (CLRTC)

This jumper allows you to clear the Real Time Clock (RTC) RAM in CMOS. You can clear the CMOS memory of date, time, and system setup parameters by erasing the CMOS RTC RAM data. The RAM data in CMOS, that include system setup information such as system passwords, is powered by the onboard button cell battery.

To erase the RTC RAM:

1. Turn OFF the computer and unplug the power cord.
2. Move the jumper cap from pins 1-2 (default) to pins 2-3. Keep the cap on pins 2-3 for about 5~10 seconds, then move the cap back to pins 1-2.
3. Plug the power cord and turn ON the computer.
4. Hold down the <Del> key during the boot process and enter BIOS setup to re-enter data.



---

Except when clearing the RTC RAM, never remove the cap on CLRTC jumper default position. Removing the cap will cause system boot failure!

---

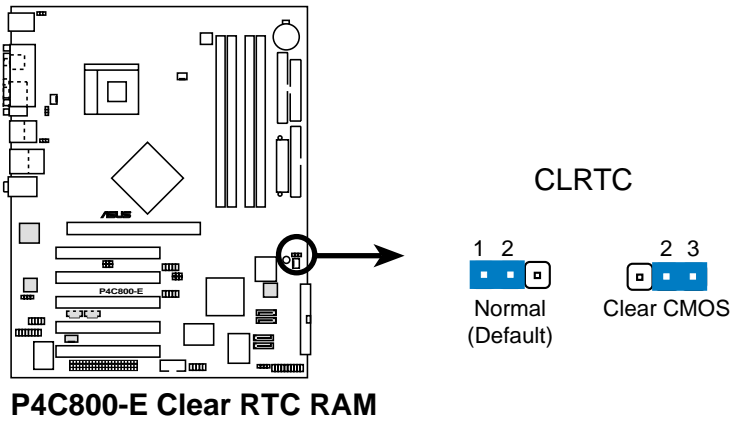

You do not need to clear the RTC when the system hangs due to overclocking. For system failure due to overclocking, use the C.P.R. (CPU Parameter Recall) feature. Shut down and reboot the system so BIOS can automatically reset parameter settings to default values.

### 3. USB device wake-up (3-pin USBPW12, USBPW34, USBPW56, USBPW78)

Set these jumpers to +5V to wake up the computer from S1 sleep mode (CPU stopped, DRAM refreshed, system running in low power mode) using the connected USB devices. Set to +5VSB to wake up from S3 and S4 sleep modes (no power to CPU, DRAM in slow refresh, power supply in reduced power mode).

The USBPWR12 and USBPWR34 jumpers are for the rear USB ports. The USBPWR56 and USBPWR78 jumper is for the internal USB header that you can connect to the front USB ports.

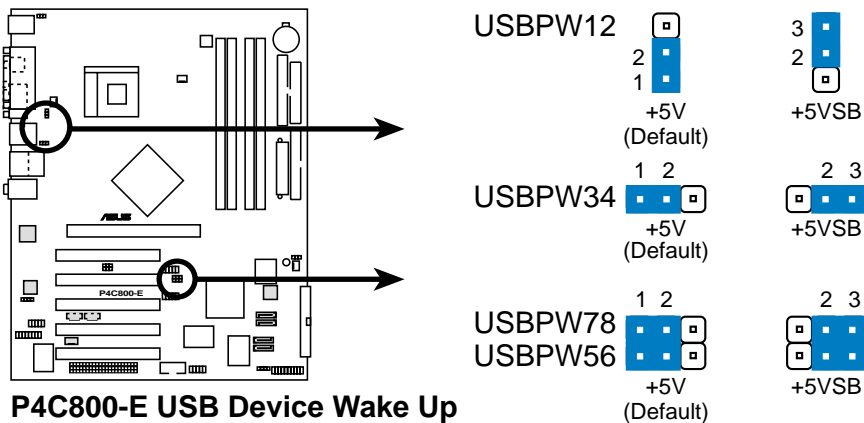

1. The USB device wake-up feature requires a power supply that can provide 500mA on the +5VSB lead for each USB port. Otherwise, the system would not power up.
2. The total current consumed must NOT exceed the power supply capability (+5VSB) whether under normal condition or in sleep mode.

#### 4. SMB2.0 (two 3-pin SMB20)

These jumpers allow you to enable or disable the SMBus 2.0 feature supported on the motherboard. By default, pins 2-3 are shorted (jumper caps on) to disable the feature. If you wish to install PCI devices that comply with SMBus 2.0 specification, move the jumper caps to pins 1-2 of both jumpers to enable the SMBus 2.0 feature.

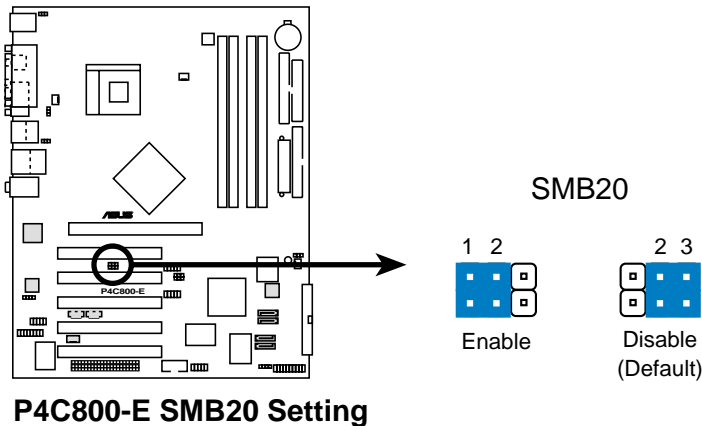

## 2.8 Connectors

This section describes and illustrates the internal connectors on the motherboard.



---

Always connect ribbon cables with the red stripe to Pin 1 on the connectors. Pin 1 is usually on the side closest to the power connector on hard drives and CD-ROM drives, but may be on the opposite side on floppy disk drives.

---

#### 1. Floppy disk drive connector (34-1 pin FLOPPY)

This connector supports the provided floppy drive ribbon cable. After connecting one end to the motherboard, connect the other end to the floppy drive. (Pin 5 is removed to prevent incorrect insertion when using ribbon cables with pin 5 plug).

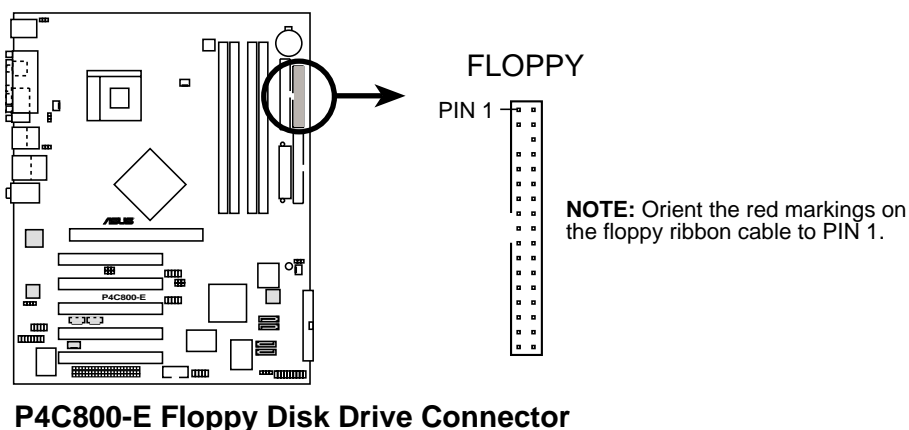

## 2. IDE connectors (40-1 pin PRI\_IDE[blue], SEC\_IDE [black])

This connector supports the provided UltraDMA/100/66 IDE hard disk ribbon cable. Connect the cable's blue connector to the primary (recommended) or secondary IDE connector, then connect the gray connector to the UltraDMA/100/66 slave device (hard disk drive) and the black connector to the UltraDMA/100/66 master device. It is recommended that you connect non-UltraDMA/100/66 devices to the secondary IDE connector. If you install two hard disks, you must configure the second drive as a slave device by setting its jumper accordingly. Refer to the hard disk documentation for the jumper settings. BIOS supports specific device bootup. You may configure two hard disks to be both master devices with two ribbon cables – one for the primary IDE connector and another for the secondary IDE connector.



1. Pin 20 on each IDE connector is removed to match the covered hole on the UltraDMA cable connector. This prevents incorrect orientation when you connect the cables.
2. The hole near the blue connector on the UltraDMA/100/66 cable is intentional.
3. For UltraDMA/100/66 IDE devices, use the 80-conductor IDE cable.

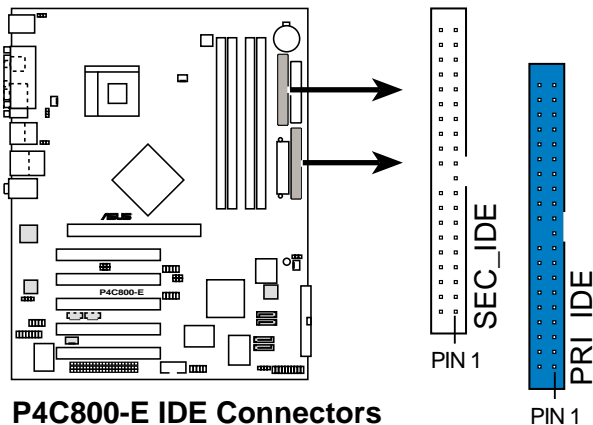

**NOTE:** Orient the red markings (usually zigzag) on the IDE ribbon cable to PIN 1.



### Important note when using legacy OS

Refer to page 2-24 on how to configure P-ATA and S-ATA devices if you installed a legacy operating system (e.g. MS-DOS, Windows 98/Me/NT4.0).



### 3. Serial ATA connectors (7-pin SATA1, SATA2)

These next generation connectors support the thin Serial ATA cables for Serial ATA hard disks. The current Serial ATA interface allows up to 150 MB/s data transfer rate, faster than the standard parallel ATA with 133 MB/s (Ultra ATA/133).

If you installed Serial ATA hard disks, you may create a RAID 0 configuration using the RAID feature of the Intel ICH5R chipset. See section “5.4 Intel RAID for Serial ATA” for information on creating a RAID.

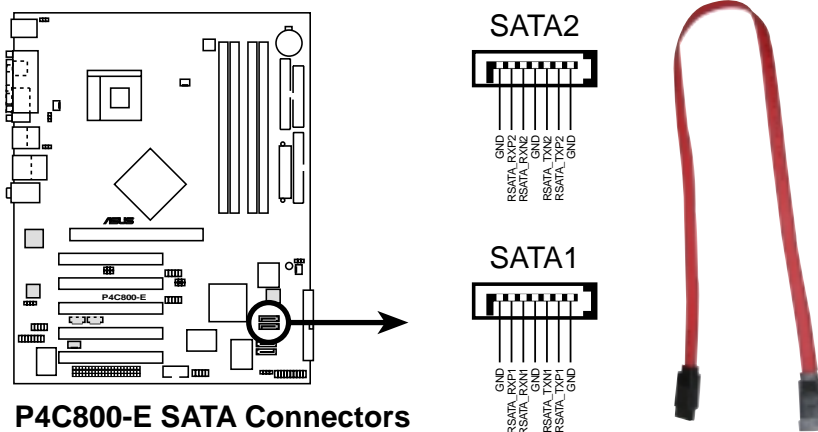

#### Important notes on Serial ATA

1. In a legacy operating system (DOS, Windows 98, Windows Me, Windows NT) environment, using the Serial ATA connectors will disable the ICH5R chipset support to one of the IDE channels (either primary or secondary channel).
2. The Serial ATA RAID feature (RAID 0) is available only if you are using Windows XP.

## Parallel ATA and Serial ATA device configurations

Following are the Parallel ATA and Serial ATA device configurations supported by Intel ICH5 specifications.

**Native** operating systems (OS) are Windows 2000/XP. ICH5 supports a maximum of six (6) devices using these OS.

**Legacy** OS are MS-DOS, Windows 98/Me/NT4.0. ICH5 supports a maximum of four (4) devices using these OS.

Operating System	P-ATA		S-ATA	
	Primary (2 devices)	Secondary (2 devices)	Port 0 (1 device)	Port 1 (1 device)
1. Windows 2000/XP	✓	✓	✓	✓
2. Windows 98/Me/NT4.0				
Configuration A	✓	—	✓	✓
Configuration B	—	✓	✓	✓
Configuration C	✓	✓	—	—

**Legend:**

✓ Supported  
— Disabled

## Required IDE Configuration settings in BIOS

Refer to the following table for the appropriate BIOS settings of the above P-ATA and S-ATA device configurations. See section “4.3.6 IDE Configuration” for details on the related BIOS items.

BIOS item	Windows 2000/XP	Windows 98/Me/NT4.0		
		A	B	C
Onboard IDE Operate Mode	Enhanced Mode	Compatible Mode	Compatible Mode	Compatible Mode
Enhanced Mode Support On	S-ATA	—	—	—
IDE Port Settings	—	Primary P-ATA+S-ATA	Sec. P-ATA+S-ATA	P-ATA Ports Only

#### 4. Serial ATA RAID connectors (7-pin SATA\_RAID1, SATA\_RAID2) (on RAID models only)

These Serial ATA connectors support SATA hard disks that you may configure as a RAID set. Through the onboard Promise® PDC20378 RAID controller, you may create a RAID0, RAID1, RAID0+1, or multi-RAID configuration together with the RAID ATA133 connector. See Chapter 5 for details on RAID configuration.

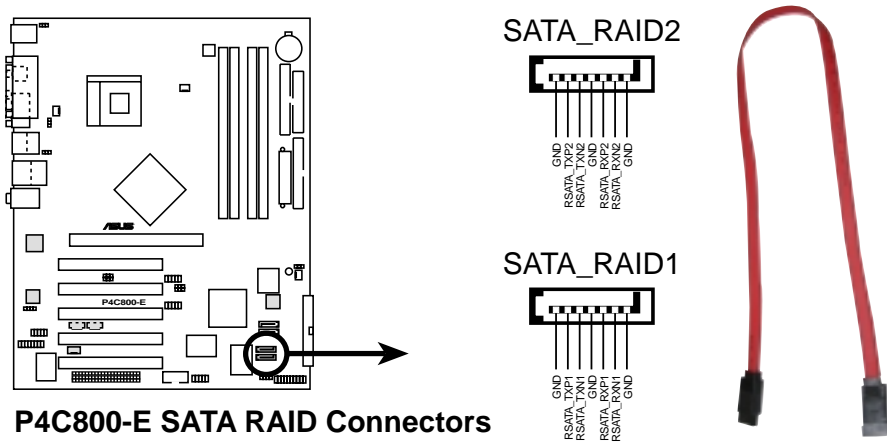

1. If you wish to create a RAID set, make sure that you have connected the SATA cable and installed Serial ATA devices. You cannot enter the SATA RAID™ utility and SATA BIOS setup during POST if there are no connected Serial ATA devices.
2. The Promise PDC20376 RAID controller does not support ATAPI devices such as CD-ROMs, DVD-ROMs, etc.

## 5. RAID ATA/133/100/66/33 connector (40-1 pin PRI\_RAID)

(on RAID models only)

This connector supports either RAID 0 or RAID 1 configuration through the onboard Promise® PDC20378 controller. You can connect two UltraATA133 hard disks to this connector and set up a disk array configuration. You may also set up the UltraATA133 hard disks with the Serial ATA hard disks on the Serial ATA RAID connectors to create a multi-RAID configuration. See Chapter 5 for details on RAID configuration.

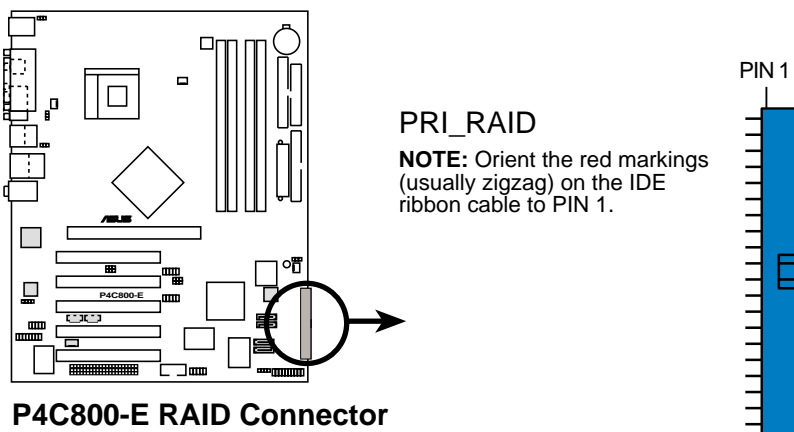

**P4C800-E RAID Connector**



1. If you wish to create a RAID set using UltraATA hard disks, make sure that you have connected the UltraATA cable and installed UltraATA 133 hard disks.
2. The Promise PDC20376 RAID controller does not support ATAPI devices such as CD-ROMs, DVD-ROMs, etc.

## 6. SMBus connector (6-1 pin SMB)

This connector allows you to connect SMBus (System Management Bus) devices. Devices communicate with an SMBus host and/or other SMBus devices using the SMBus interface.

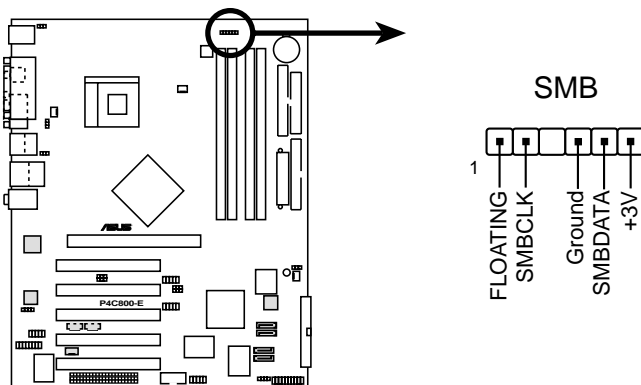

**P4C800-E SMBus Connector**

## 7. Chassis intrusion connector (4-1 pin CHASSIS)

This lead is for a chassis designed with intrusion detection feature. This requires an external detection mechanism such as a chassis intrusion sensor or microswitch. When you remove any chassis component, the sensor triggers and sends a high-level signal to this lead to record a chassis intrusion event.

By default, the pins labeled “Chassis Signal” and “Ground” are shorted with a jumper cap. If you wish to use the chassis intrusion detection feature, remove the jumper cap from the pins.

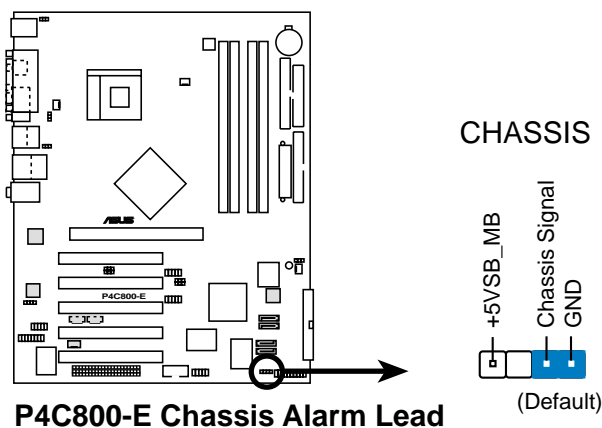

## 8. CPU, Chassis, and Power Fan Connectors (3-pin CPU\_FAN, PWR\_FAN, CHA\_FAN)

The fan connectors support cooling fans of 350mA~740mA (8.88W max.) or a total of 1A~2.22A (26.64W max.) at +12V. Connect the fan cables to the fan connectors on the motherboard, making sure that the black wire of each cable matches the ground pin of the connector.



Do not forget to connect the fan cables to the fan connectors. Lack of sufficient air flow within the system may damage the motherboard components. These are not jumpers! DO NOT place jumper caps on the fan connectors!

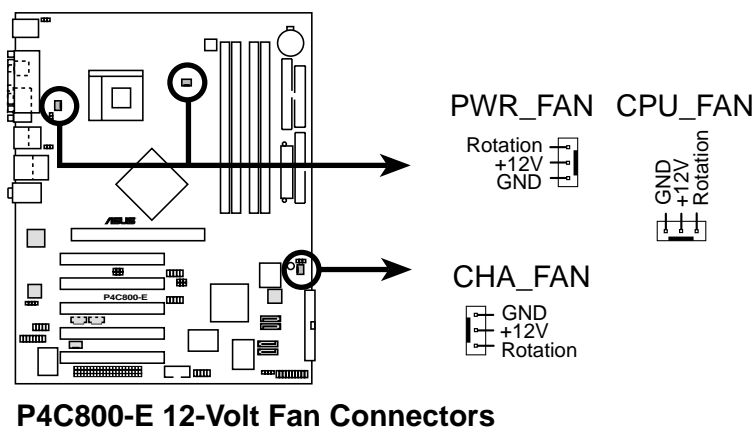

## 9. ATX power connectors (20-pin ATXPWR, 4-pin ATX12V)

These connectors connect to an ATX 12V power supply. The plugs from the power supply are designed to fit these connectors in only one orientation. Find the proper orientation and push down firmly until the connectors completely fit.

In addition to the 20-pin ATXPWR connector, this motherboard requires that you connect the 4-pin ATX +12V power plug to provide sufficient power to the CPU.



1. Do not forget to connect the 4-pin ATX +12V power plug. Otherwise, the system does not boot up.
2. Make sure that your ATX 12V power supply can provide 8A on the +12V lead and at least 1A on the +5-volt standby lead (+5VSB). The minimum recommended wattage is 230W, or 300W for a fully configured system. The system may become unstable or may not boot up if the power is inadequate.

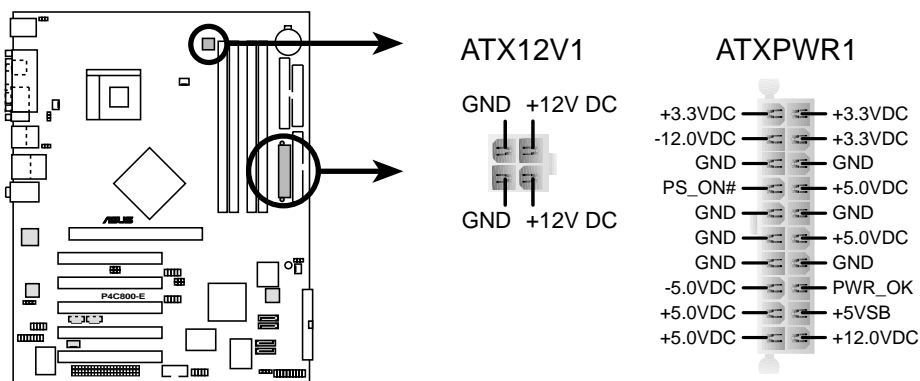

**P4C800-E ATX Power Connector**

## 10. Power supply thermal connector (2-pin TRPWR)

If your power supply has a thermal monitoring feature, connect its thermal sensor cable to this connector.

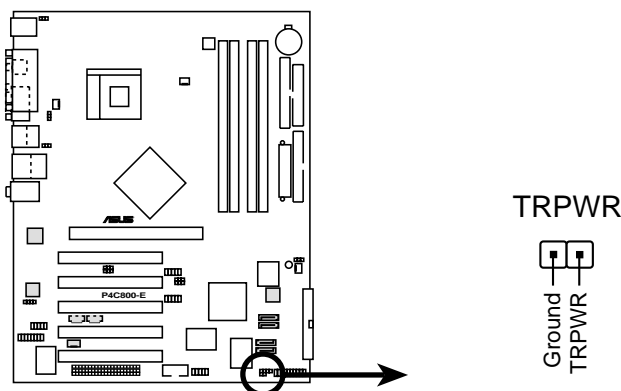

**P4C800-E Power Supply Thermal Connector**

## 11. Digital audio connector (4-1 pin SPDIF\_OUT)

In addition to the S/PDIF Out port on the rear panel, an S/PDIF Out connector is available for an S/PDIF audio module. Connect one end of the S/PDIF audio cable this connector and the other end to the S/PDIF module.



The S/PDIF module is purchased separately.

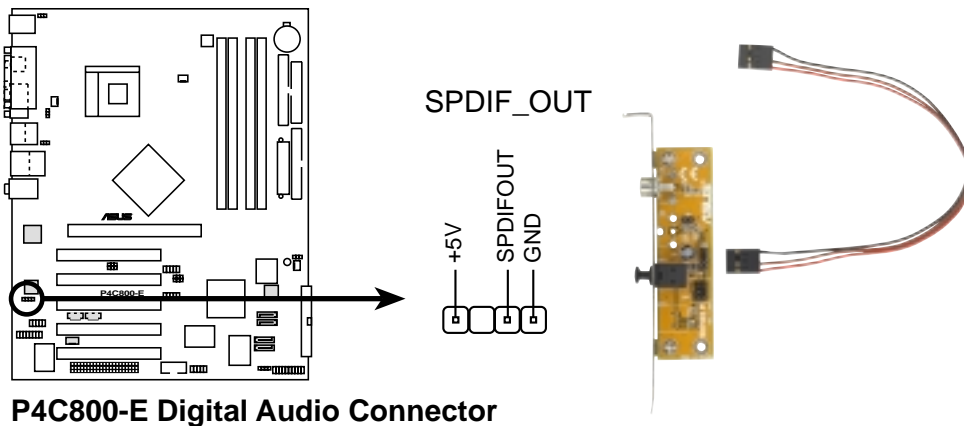

## 12. GAME/MIDI connector (16-1 pin GAME)

This connector supports an optional GAME/MIDI module. Connect the GAME/MIDI cable to this connector. The GAME/MIDI port on the module connects a joystick or a game pad for playing games, and MIDI devices for playing or editing audio files.

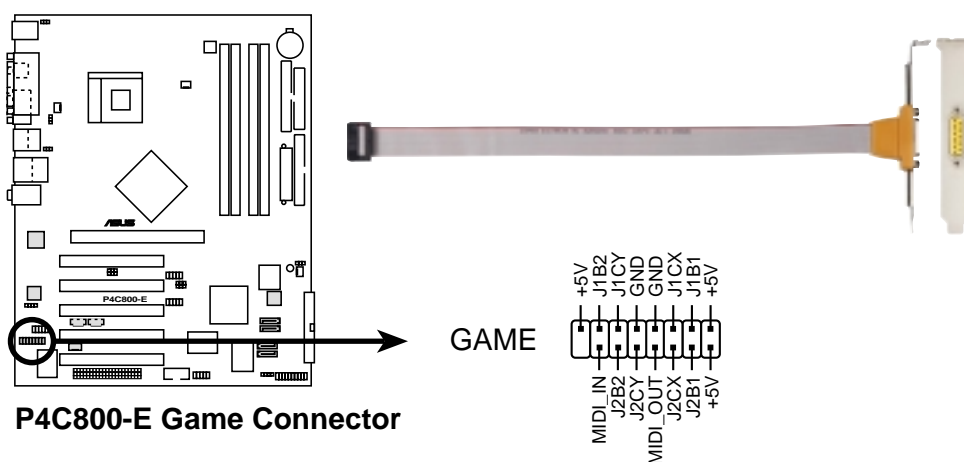

### 13. USB headers (10-1 pin USB56, USB78)

If the USB ports on the rear panel are inadequate, two USB headers are available for additional USB ports. The USB header complies with USB 2.0 specification that supports up to 480 Mbps connection speed. This speed advantage over the conventional 12 Mbps on USB 1.1 allows faster Internet connection, interactive gaming, and simultaneous running of high-speed peripherals.

Connect an optional USB 2.0/GAME module to this header. The module has two USB 2.0 ports that support the next generation USB peripherals such as high resolution cameras, scanners, and printers.

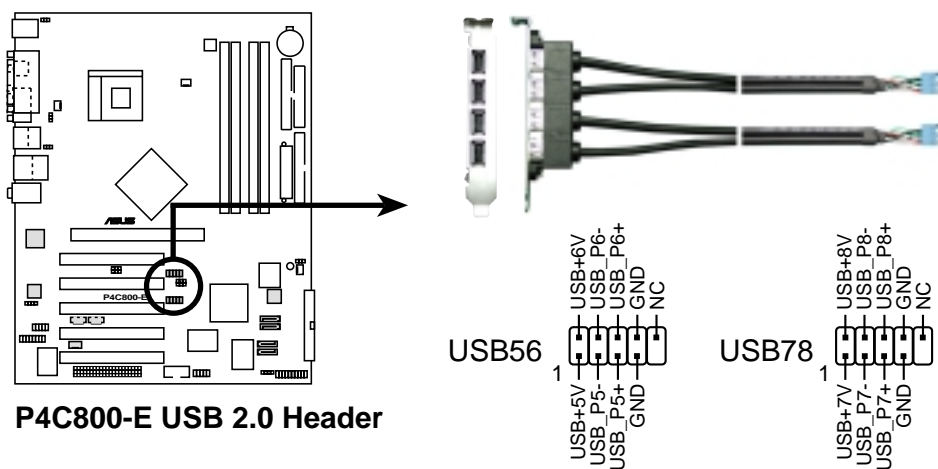

NEVER connect a **1394 cable** to the either USB56 or USB78 connector. Doing so will damage the motherboard!



## 14. Internal audio connectors (4-pin CD, AUX, MODEM)

These connectors allow you to receive stereo audio input from sound sources such as a CD-ROM, TV tuner, or MPEG card. The MODEM connector allows the onboard audio to interface with a voice modem card with a similar connector. It also allows the sharing of mono\_in (such as a phone) and a mono\_out (such as a speaker) between the audio and a voice modem card.

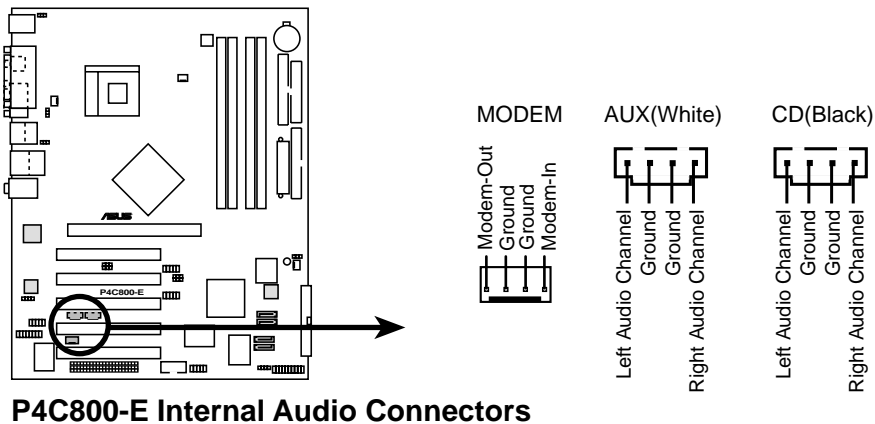

## 15. IEEE 1394 connector (10-1 pin IE1394\_2) (on 1394 models only)

This connector is for an optional 1394 module. Attach the 10-1 pin 1394 cable plug from the module to this connector. You may also connect a 1394-compliant internal hard disk to this connector.

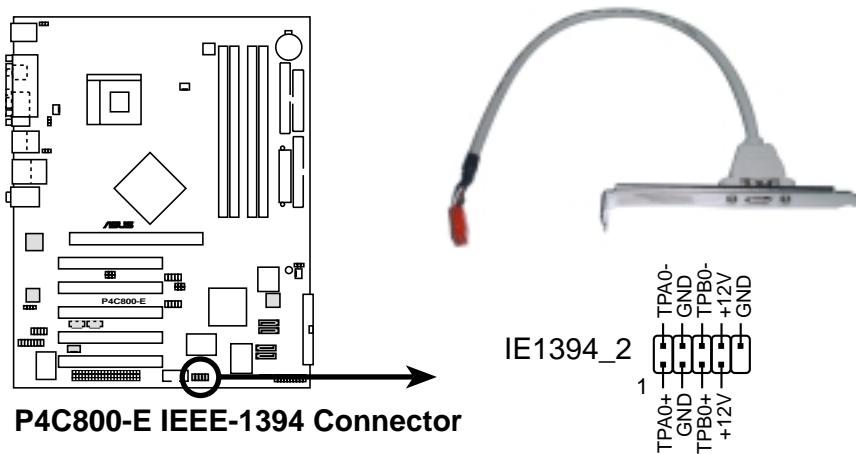

NEVER connect a **USB cable** to the IEEE 1394 connector. Doing so will damage the motherboard!

## 16. Front panel audio connector (10-1 pin FP\_AUDIO)

This is an interface for the Intel front panel audio cable that allow convenient connection and control of audio devices.

By default, the pins labeled LINE OUT\_R/BLINE\_OUT\_R and the pins LINE OUT\_L/BLINE\_OUT\_L are shorted with jumper caps. Remove the caps only when you are connecting the front panel audio cable.

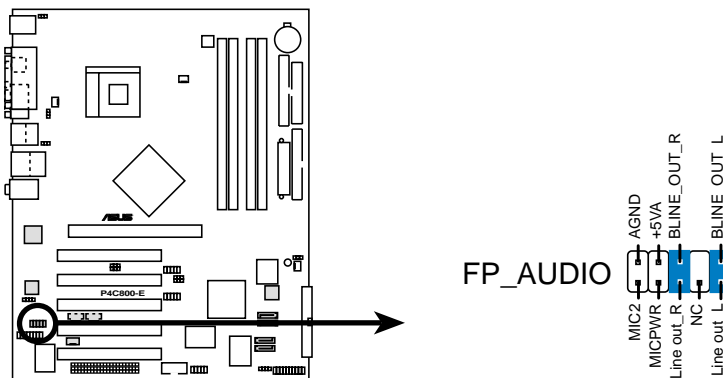

**P4C800-E Front Panel Audio Connector**

## 17. Serial port 2 connector (10-1 pin COM2)

This connector accommodates a second serial port using an optional serial port bracket. Connect the bracket cable to this connector then install the bracket into a slot opening at the back of the system chassis.



The serial port bracket (COM2) is purchased separately.

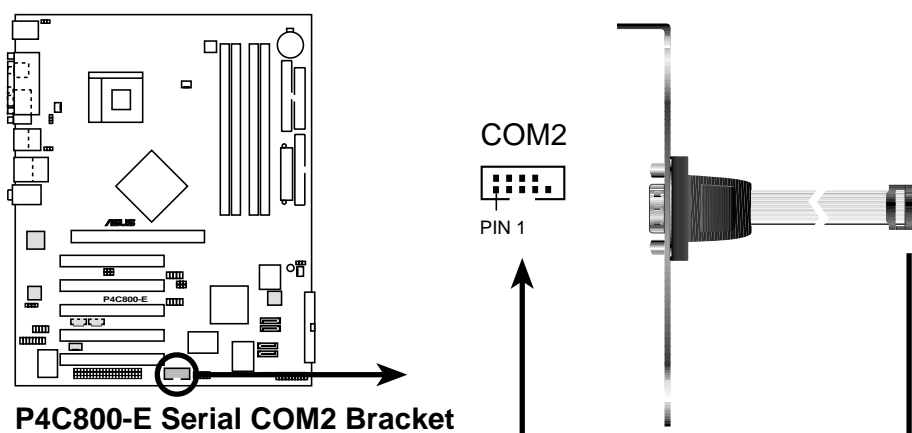

**P4C800-E Serial COM2 Bracket**

## 18. System panel connector (20-pin PANEL)

This connector accommodates several system front panel functions.

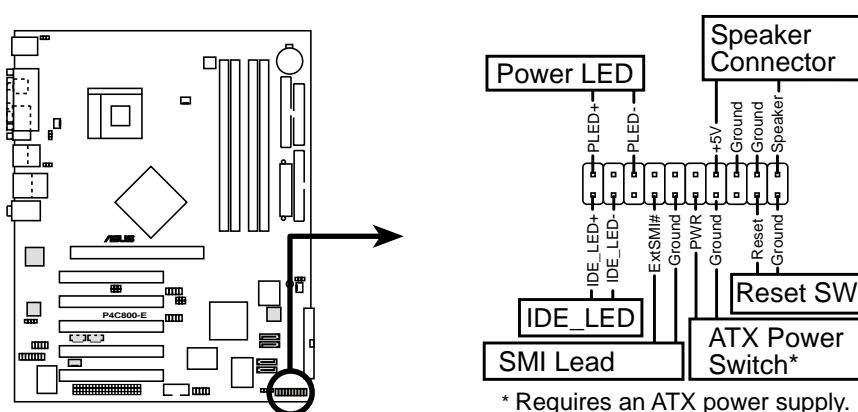

**P4C800-E System Panel Connectors**

- **System Power LED Lead (3-1 pin PLED)**

This 3-1 pin connector connects to the system power LED. The LED lights up when you turn on the system power, and blinks when the system is in sleep mode.

- **Hard Disk Activity Lead (2-pin IDELED)**

This 2-pin connector is for the HDD LED cable. The read or write activities of the device connected to the any of IDE connectors cause the IDE LED to light up.

- **System Warning Speaker Lead (4-pin SPKR)**

This 4-pin connector connects to the case-mounted speaker and allows you to hear system beeps and warnings.

- **System Management Interrupt Lead (2-pin SMI)**

This 2-pin connector allows you to manually place the system into a suspend mode, or “green” mode, where system activity is instantly decreased to save power and to expand the life of certain system components. Attach the case-mounted suspend switch to this 2-pin connector.

- **ATX Power Switch / Soft-Off Switch Lead (2-pin PWRBTN)**

This connector connects a switch that controls the system power. Pressing the power switch turns the system between ON and SLEEP, or ON and SOFT OFF, depending on the BIOS or OS settings. Pressing the power switch while in the ON mode for more than 4 seconds turns the system OFF.

- **Reset Switch Lead (2-pin RESET)**

This 2-pin connector connects to the case-mounted reset switch for rebooting the system without turning off the system power.



# ***Chapter 3***

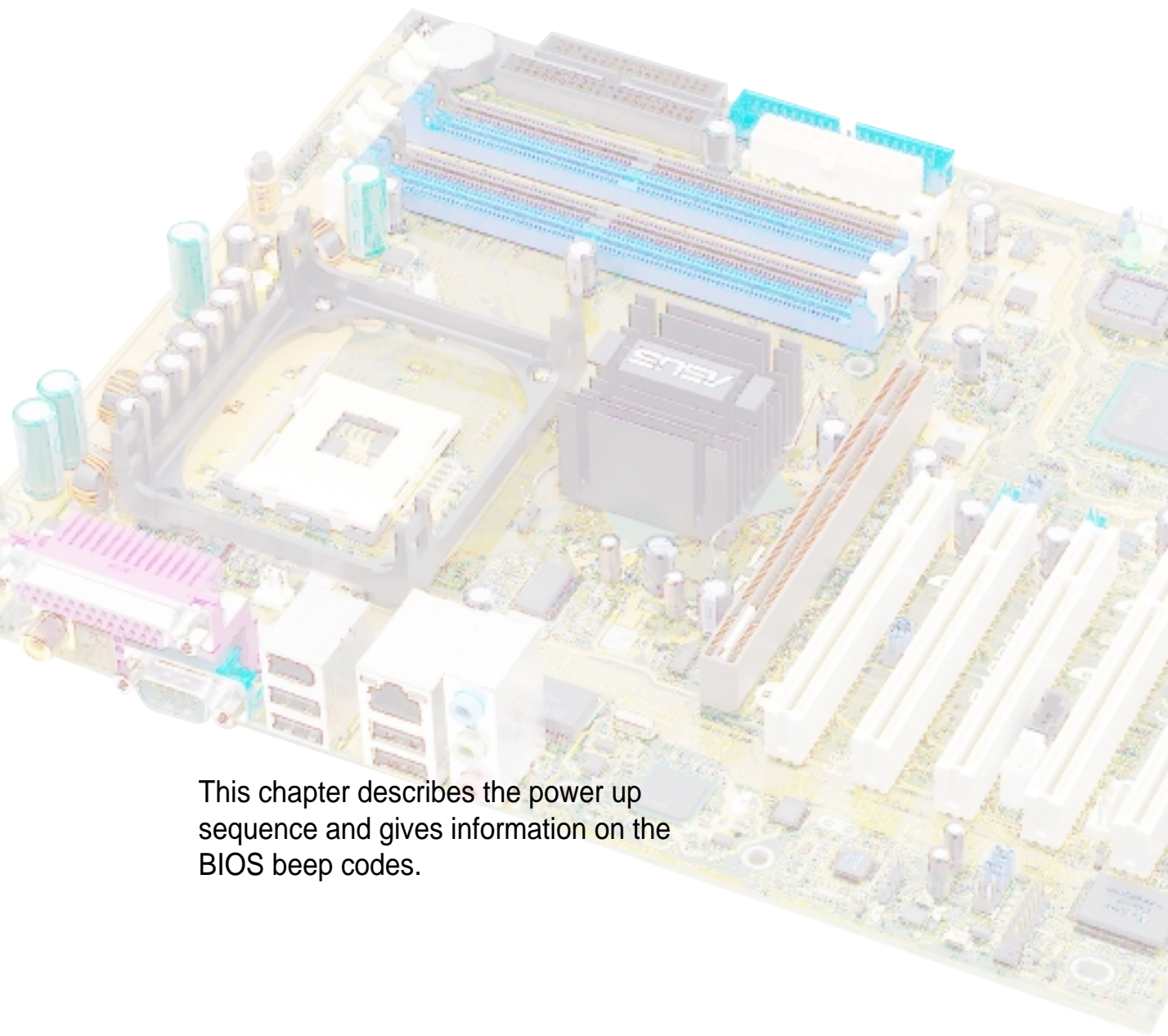

This chapter describes the power up sequence and gives information on the BIOS beep codes.

## **Powering up**

## **Chapter summary**

- 3.1 Starting up for the first time ..... 3-1**
- 3.2 Vocal POST Messages ..... 3-2**
- 3.3 Powering off the computer ..... 3-4**

## 3.1 Starting up for the first time

1. After making all the connections, replace the system case cover.
2. Be sure that all switches are off.
3. Connect the power cord to the power connector at the back of the system chassis.
4. Connect the power cord to a power outlet that is equipped with a surge protector.
5. Turn on the devices in the following order:
  - a. Monitor
  - b. External SCSI devices (starting with the last device on the chain)
  - c. System power
6. After applying power, the power LED on the system front panel case lights up. For ATX power supplies, the system LED lights up when you press the ATX power switch. If your monitor complies with “green” standards or if it has a “power standby” feature, the monitor LED may light up or switch between orange and green after the system LED turns on. The system then runs the power-on tests. While the tests are running, the BIOS beeps (see BIOS beep codes table below) or additional messages appear on the screen. If you do not see anything within 30 seconds from the time you turned on the power, the system may have failed a power-on test. Check the jumper settings and connections or call your retailer for assistance.

### AMI BIOS beep codes

No. of Beeps	Description
2	Parity error
3	Main memory read/write test error
4	Motherboard timer not operational
6	Keyboard controller BAT test error
7	General exception error
8	Display memory error
10	CMOS shutdown register read/write error

7. At power on, hold down <Delete> to enter BIOS Setup. Follow the instructions in Chapter 4.

## 3.2 Vocal POST Messages

This motherboard includes the Winbond speech controller to support a special feature called the ASUS POST Reporter™. This feature gives you vocal POST messages and alerts to inform you of system events and boot status. In case of a boot failure, you will hear the specific cause of the problem.

These POST messages are customizable using the Winbond Voice Editor software that came with your package. You can record your own messages to replace the default messages.

Following is a list of the default POST messages and their corresponding actions, if any.

POST Message	Action
No CPU installed	<ul style="list-style-type: none"><li>• Install an Intel Pentium 4 Processor into the CPU socket.</li></ul>
System failed CPU test	<ul style="list-style-type: none"><li>• Check the CPU if properly installed.</li><li>• Call ASUS technical support for assistance. See the “ASUS contact information” on page x.</li></ul>
System failed memory test	<ul style="list-style-type: none"><li>• Install 184-pin unbuffered PC3200/2700/2100 DIMMs into the DIMM sockets.</li><li>• Check if the DIMMs on the DIMM sockets are properly installed.</li><li>• Make sure that your DIMMs are not defective.</li><li>• Refer to section “2.5 System memory” for instruction on installing a DIMM.</li></ul>
System failed VGA test	<ul style="list-style-type: none"><li>• Install a PCI VGA card into one of the PCI slots, or a +0.8V/1.5V AGP card into the AGP slot.</li><li>• Make sure that your VGA/AGP card is not defective.</li></ul>
System failed due to CPU over-clocking	<ul style="list-style-type: none"><li>• Check your CPU settings in BIOS and make sure you only set to the recommended settings.</li></ul>



POST Message	Action
No keyboard detected	<ul style="list-style-type: none"> <li>• Check your keyboard if properly connected to the purple PS/2 connector on the rear panel.</li> <li>• See section “1.4.1 Major components” for the location of the connector.</li> </ul>
No floppy disk detected	<ul style="list-style-type: none"> <li>• Make sure you have connected a floppy disk to the floppy disk connector on the motherboard.</li> <li>• See section “2.8 Connectors.”</li> </ul>
No IDE hard disk detected	<ul style="list-style-type: none"> <li>• Make sure you have connected an IDE hard disk drive to the one of the IDE connectors on the motherboard.</li> <li>• See section “2.8 Connectors.”</li> </ul>
CPU temperature too high	<ul style="list-style-type: none"> <li>• Check CPU fan if working properly.</li> </ul>
CPU fan failed	<ul style="list-style-type: none"> <li>• Check the CPU fan and make sure it turns on after you applied power to the system.</li> <li>• Make sure that your CPU fan supports the fan speed detection function.</li> </ul>
CPU voltage out of range	<ul style="list-style-type: none"> <li>• Check your power supply and make sure it is not defective.</li> <li>• Call ASUS technical support for assistance. See the “ASUS contact information” on page x.</li> </ul>
System completed Power-On Self Test	<ul style="list-style-type: none"> <li>• No action required</li> </ul>
Computer now booting from operating system	<ul style="list-style-type: none"> <li>• No action required</li> </ul>

## 3.3 Powering off the computer

You must first exit the operating system and shut down the system before switching off the power. For ATX power supplies, you can press the ATX power switch after exiting or shutting down the operating system.



---

The message “You can now safely turn off your computer” does not appear when shutting down with an ATX power supply.

---

### Using the dual function power switch

While the system is ON, pressing the power switch for less than 4 seconds puts the system to sleep mode or to soft-off mode, depending on the BIOS setting. Pressing the power switch for more than 4 seconds lets the system enter the soft-off mode regardless of the BIOS setting. See section “4.5 Power Menu” in Chapter 4.

### Using the OS shut down function

If you use Windows 98SE/ME/2000/XP, click the **Start** button, click **Shut Down**, then the **OK** button to shut down the computer. The power supply should turn off after Windows shuts down.

# *Chapter 4*

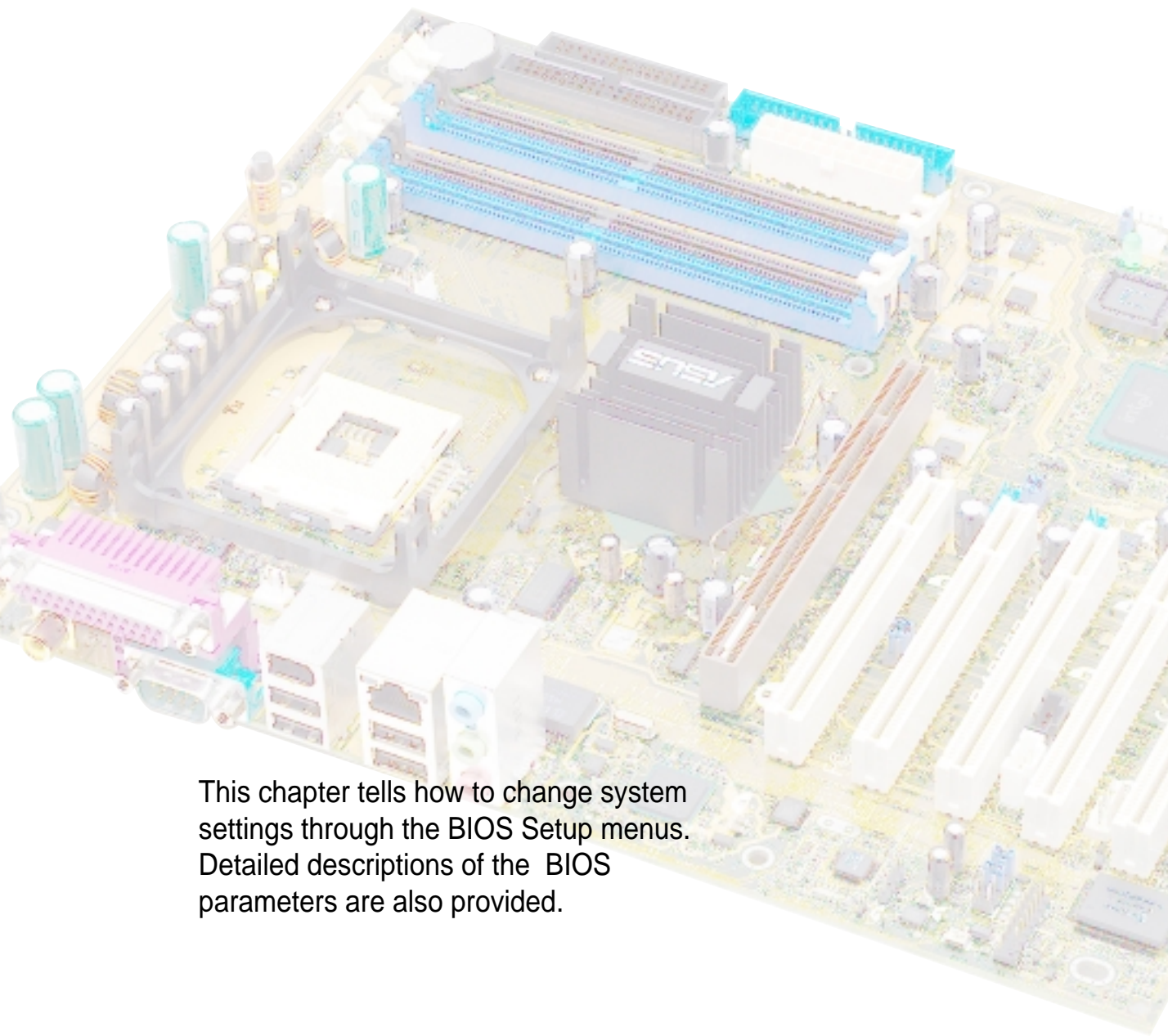

This chapter tells how to change system settings through the BIOS Setup menus. Detailed descriptions of the BIOS parameters are also provided.

## **BIOS setup**

## **Chapter summary**

<b>4.1</b>	<b>Managing and updating your BIOS .....</b>	<b>4-1</b>
<b>4.2</b>	<b>BIOS Setup program .....</b>	<b>4-6</b>
<b>4.3</b>	<b>Main menu .....</b>	<b>4-9</b>
<b>4.4</b>	<b>Advanced menu .....</b>	<b>4-14</b>
<b>4.5</b>	<b>Power menu .....</b>	<b>4-27</b>
<b>4.6</b>	<b>Boot menu .....</b>	<b>4-32</b>
<b>4.7</b>	<b>Exit menu .....</b>	<b>4-38</b>

## 4.1 Managing and updating your BIOS



---

The **original BIOS file** for this motherboard is in the support CD.

Copy the original BIOS to a **bootable floppy disk** in case you need to restore the BIOS in the future.

---

### 4.1.1 Creating a bootable floppy disk

1. Do either one of the following to create a bootable floppy disk.

#### DOS environment

Insert a 1.44 MB floppy disk into the drive. At the DOS prompt, type:

```
format A:/S <Enter>
```

#### Windows environment

- a. From your Windows desktop, click on **Start**, point to **Settings**, then click on **Control Panel**.
  - b. Double-click on **Add/Remove Programs** icon from the Control Panel window.
  - c. Click on the **Startup Disk** tab, then on **Create Disk...** button.
  - d. Insert a 1.44 MB floppy disk when prompted. Follow the succeeding screen instructions to complete the process.
2. Copy the original (or the latest) motherboard BIOS to the bootable floppy disk.

### 4.1.2 Using AFUDOS to update the BIOS

Update the BIOS using the AFUDOS.EXE utility in DOS environment.

1. Visit the ASUS website ([www.asus.com](http://www.asus.com)) to download the latest BIOS file for your motherboard. Save the BIOS file to a bootable floppy disk.



---

Write down the BIOS file name to a piece of paper. You need to type the **exact BIOS file name** at the prompt.

---

2. Copy the AFUDOS.EXE utility from the support CD to the bootable floppy disk that contains the BIOS file.
3. Boot the system from the floppy disk.

4. At the DOS prompt, type the command line:

**afudos /i<filename.rom>**

where “filename.rom” means the latest (or original) BIOS file that you copied to the bootable floppy disk.

The screen displays the status of the update process.



---

The BIOS information on the screen is for reference only. What you see on your screen may not be exactly the same as shown.

---

```
A:\>afudos /iP4C800E.rom
AMI Firmware Update Utility - Version 1.10
Copyright (C) 2002 American Megatrends, Inc. All rights reserved.

Reading file ..... done
Erasing flash .... done
Writing flash .... 0x0008CC00 (9%)
```



---

**DO NOT** shutdown or reset the system while updating the BIOS! Doing so may cause system boot failure!

---

When the BIOS update process is complete, the utility returns to the DOS prompt.

```
A:\>afudos /iP4C800E.rom
AMI Firmware Update Utility - Version 1.10
Copyright (C) 2002 American Megatrends, Inc. All rights reserved.

Reading file ..... done
Erasing flash .... done
Writing flash .... 0x0008CC00 (9%)
Verifying flash .. done

A:\>
```

5. Reboot the system from the hard disk.

### 4.1.3 Using ASUS EZ Flash to update the BIOS

The ASUS EZ Flash feature allows you to easily update the BIOS without having to go through the long process of booting from a diskette and using a DOS-based utility. The EZ Flash is built-in the BIOS firmware so it is accessible by simply pressing <Alt> + <F2> during the Power-On Self Tests (POST).

#### To update the BIOS using ASUS EZ Flash:

1. Visit the ASUS website ([www.asus.com](http://www.asus.com)) to download the latest BIOS file for your motherboard and rename it to **P4C800ED.ROM**. Save the BIOS file to a floppy disk.
2. Reboot the system.
3. To launch EZ Flash, press <Alt> + <F2> during POST to display the following.

```
User recovery requested. Starting BIOS recovery...
Checking for floppy...
```



---

If there is no floppy disk found in the drive, the error message “**Floppy not found!**” appears.

If the correct BIOS file is not found in the floppy disk, the error message “**P4C800ED.ROM not found!**”

---

4. Insert the floppy disk that contains the BIOS file. If the **P4C800ED.ROM** file is found in the floppy disk, EZ Flash performs the BIOS update process and automatically reboots the system when done.



---

**DO NOT** shutdown or reset the system while updating the BIOS! Doing so may cause system boot failure!

---

```
User recovery requested. Starting BIOS recovery...
Checking for floppy...
Floppy found!
Reading file "P4C800ED.rom". Completed.
Start flashing...
Flashed successfully. Rebooting.
```

## 4.1.4 Recovering the BIOS with CrashFree BIOS 2

The CrashFree BIOS 2 auto recovery tool allows you to restore BIOS from the motherboard support CD, or from a floppy disk that contains the BIOS file, in case the current BIOS on the motherboard fails or gets corrupted.



1. Prepare the **support CD** that came with the motherboard or a **floppy disk that contains the motherboard BIOS** (P4C800ED.ROM) before proceeding with the BIOS update process.
2. If you have saved a copy of the original motherboard BIOS to a bootable floppy disk, you may also use this disk to restore the BIOS. See section “4.1.1 Creating a bootable floppy disk.”

### To recover the BIOS from a floppy disk:

1. Boot the system.
2. When a corrupted BIOS is detected, the following message appears.

```
Bad BIOS checksum. Starting BIOS recovery...
Checking for floppy...
```

3. Insert a floppy disk that contains the original, or the latest, BIOS file for this motherboard (P4C800ED.ROM). If the BIOS file that you downloaded from the ASUS website has a different filename (e.g. P4C800ED11.ROM), rename it to **P4C800ED.ROM**. The BIOS update process continues when the P4C800ED.ROM is found.

```
Bad BIOS checksum. Starting BIOS recovery...
Checking for floppy...
Floppy found!
Reading file "P4C800ED.rom". Completed.
Start flashing...
```



DO NOT shutdown or reset the system while updating the BIOS! Doing so may cause system boot failure!

4. When the BIOS update process is complete, reboot the system.



## To recover the BIOS from the support CD:

1. Boot the system.
2. When a corrupted BIOS is detected, the following screen message appears.

```
Bad BIOS checksum. Starting BIOS recovery...  
Checking for floppy...
```



---

If there is no floppy disk found in the drive, the system automatically checks the CD-ROM.

---

3. Place the support CD in the CD-ROM. The support CD contains the original BIOS for this motherboard.

```
Bad BIOS checksum. Starting BIOS recovery...  
Checking for floppy...  
Floppy not found!  
Checking for CD-ROM...  
CD-ROM found.  
Reading file "P4C800ED.rom". Completed.  
Start flashing...
```



---

**DO NOT** shutdown or reset the system while updating the BIOS! Doing so may cause system boot failure!

---

4. When the BIOS update process is complete, reboot the system.



---

The recovered BIOS may not be the latest BIOS version for this motherboard. Visit the ASUS website ([www.asus.com](http://www.asus.com)) to download the latest BIOS file.

---

## 4.2 BIOS Setup program

This motherboard supports a programmable firmware hub (FWH) that you can update using the provided utility described in section “4.1 Managing and updating your BIOS.”

Use the BIOS Setup program when you are installing a motherboard, reconfiguring your system, or prompted to “Run Setup”. This section explains how to configure your system using this utility.

Even if you are not prompted to use the Setup program, you may want to change the configuration of your computer in the future. For example, you may want to enable the security password feature or change the power management settings. This requires you to reconfigure your system using the BIOS Setup program so that the computer can recognize these changes and record them in the CMOS RAM of the firmware hub.

The firmware hub on the motherboard stores the Setup utility. When you start up the computer, the system provides you with the opportunity to run this program. Press <Delete> during the Power-On Self Test (POST) to enter the Setup utility. Otherwise, POST continues with its test routines.

If you wish to enter Setup after POST, restart the system by pressing <Ctrl> + <Alt> + <Delete>, or by pressing the reset button on the system chassis. You can also restart by turning the system off and then back on. Do this last option only if the first two failed.

The Setup program is designed to make it as easy to use as possible. It is a menu-driven program, which means you can scroll through the various sub-menus and make your selections from the available options using the navigation keys.



---

If the system becomes unstable after changing any BIOS settings, load the default settings to ensure system stability. Select the **Load Default Settings** item under the Exit Menu. See section “4.7 Exit Menu.”

---



---

The BIOS setup screens shown in this chapter are for reference purposes only, and may not exactly match what you see on your screen.

Visit the ASUS website ([www.asus.com](http://www.asus.com)) to download the latest product and BIOS information.

---

## 4.2.1 BIOS menu screen

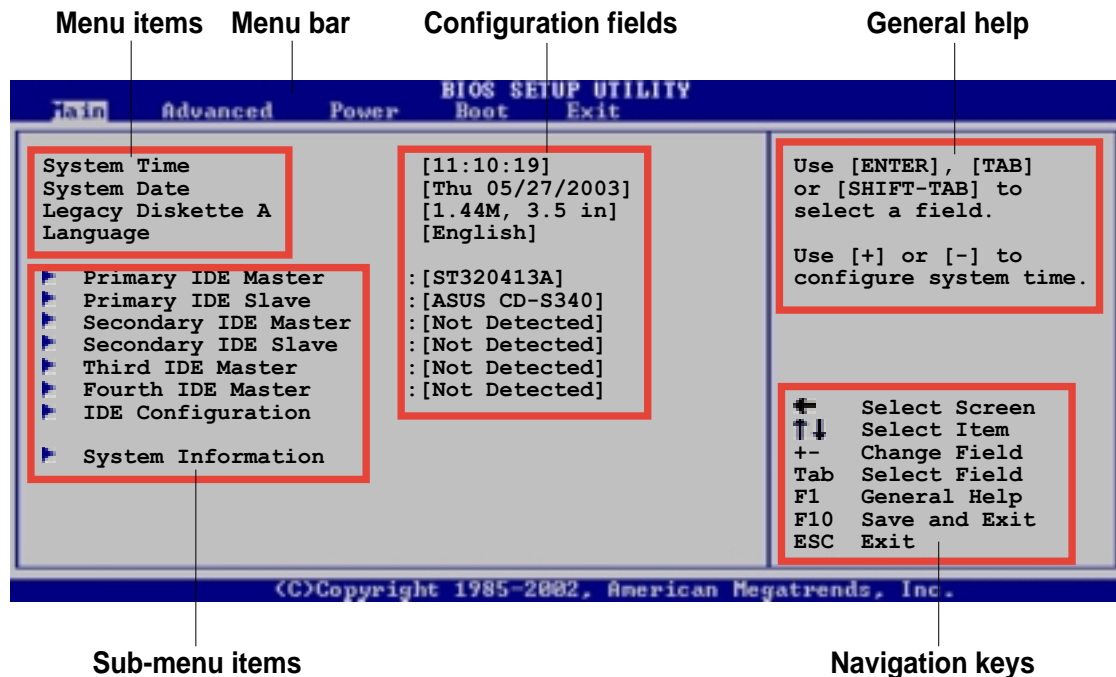

## 4.2.2 Menu bar

The menu bar on top of the screen has the following main items:

- Main** For changing the basic system configuration
- Advanced** For changing the advanced system settings
- Power** For changing the advanced power management (APM) configuration
- Boot** For changing the system boot configuration
- Exit** For selecting the exit options and loading default settings

To select an item on the menu bar, press the right or left arrow key on the keyboard until the desired item is highlighted.

## 4.2.3 Navigation keys

At the **bottom right corner** of a menu screen are the navigation keys for that particular menu. Use the navigation keys to select items in the menu and change the settings.



Some of the navigation keys differ from one screen to another.

## 4.2.4 Menu items

The highlighted item on the menu bar displays the specific items for that menu. For example, selecting **Main** shows the Main menu items.

The other items (Advanced, Power, Boot, and Exit) on the menu bar have their respective menu items.

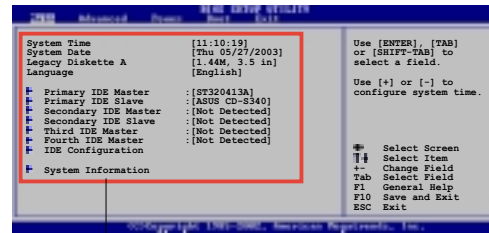

Main menu items

## 4.2.5 Sub-menu items

An item with a sub-menu on any menu screen is distinguished by a solid triangle before the item. To display the sub-menu, select the item and press Enter.

## 4.2.6 Configuration fields

These fields show the values for the menu items. If an item is user-configurable, you may change the value of the field opposite the item. You can not select an item that is not user-configurable.

A configurable field is enclosed in brackets, and is highlighted when selected. To change the value of a field, select it then press Enter to display a list of options. Refer to “4.2.7 Pop-up window.”

## 4.2.7 Pop-up window

Select a menu item then press Enter to display a pop-up window with the configuration options for that item.

## 4.2.8 Scroll bar

A scroll bar appears on the right side of a menu screen when there are items that do not fit on the screen. Press **Up/Down arrow keys** or **PageUp/PageDown keys** to display the other items on the screen.

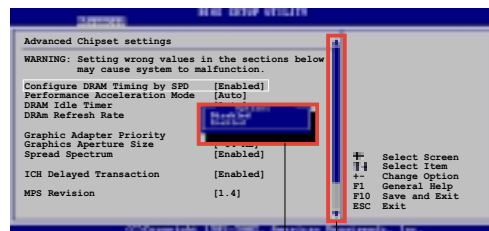

Pop-up window

Scroll bar

## 4.2.9 General help

At the top right corner of the menu screen is a brief description of the selected item.

## 4.3 Main menu

When you enter the BIOS Setup program, the Main menu screen appears giving you an overview of the basic system information.



Refer to section “4.2.1 BIOS menu screen” for information on the menu screen items and how to navigate through them.

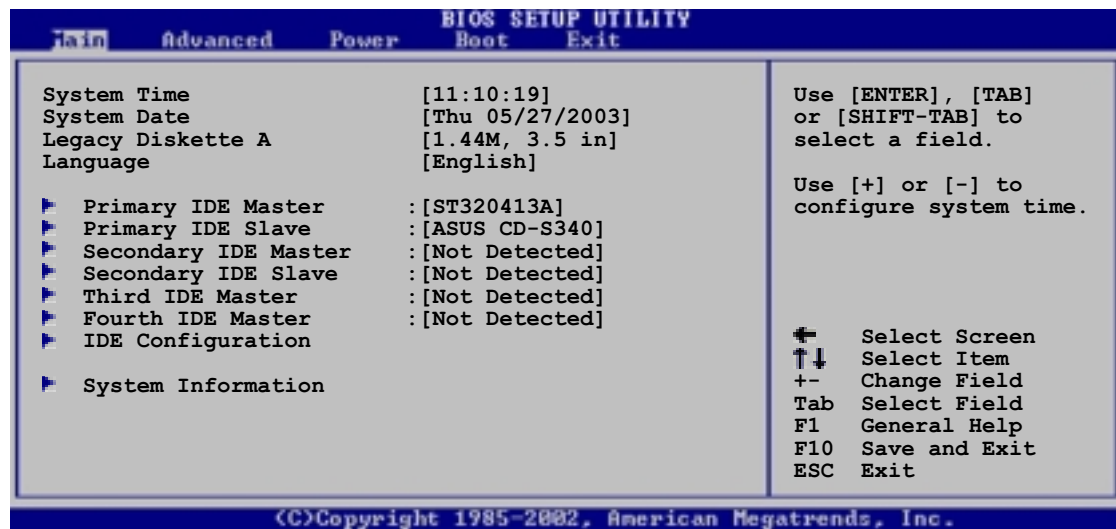

### 4.3.1 System Time [xx:xx:xxxx]

This item allows you to set the system time.

### 4.3.2 System Date [Day xx/xx/xxxx]

This item allows you to set the system date.

### 4.3.3 Legacy Diskette A [1.44M, 3.5 in.]

Sets the type of floppy drive installed. Configuration options: [Disabled] [360K, 5.25 in.] [1.2M , 5.25 in.] [720K , 3.5 in.] [1.44M, 3.5 in.] [2.88M, 3.5 in.]

### 4.3.4 Language [English]

This field allows you to choose the BIOS language version from the available options.

## 4.3.5 Primary and Secondary IDE Master/Slave

While entering Setup, BIOS auto-detects the presence of IDE devices. There is a separate sub-menu for each IDE device. Select a device item then press Enter to display the IDE device information.

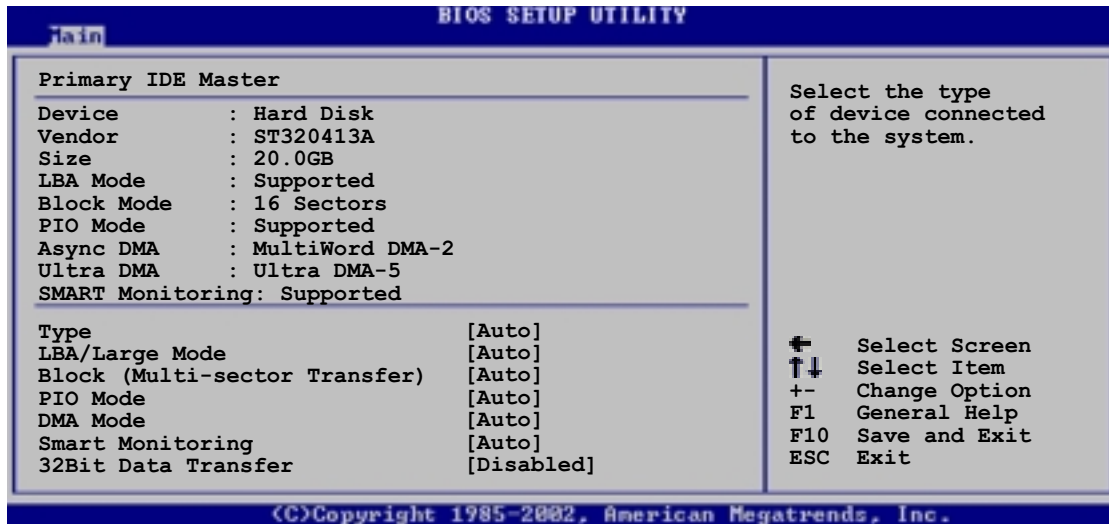

The values opposite the dimmed items (Device, Vendor, Size, LBA Mode, Block Mode, PIO Mode, Async DMA, Ultra DMA, and SMART monitoring) are auto-detected by BIOS and are not user-configurable. These items show N/A if no IDE device is installed in the system.

### Type [Auto]

Selects the type of IDE drive. Setting to Auto allows automatic selection of the appropriate IDE device type. Select CDROM if you are specifically configuring a CD-ROM drive. Select ARMD (ATAPI Removable Media Device) if your device is either a ZIP, LS-120, or MO drive. Configuration options: [Not Installed] [Auto] [CDROM] [ARMD]

### LBA/Large Mode [Auto]

Enables or disables the LBA mode. Setting to Auto enables the LBA mode if the device supports this mode, and if the device was not previously formatted with LBA mode disabled. Configuration options: [Disabled] [Auto]

### Block (Multi-sector Transfer) [Auto]

Enables or disables data multi-sectors transfers. When set to Auto, the data transfer from and to the device occurs multiple sectors at a time if the device supports multi-sector transfer feature. When set to Disabled, the data transfer from and to the device occurs one sector at a time. Configuration options: [Disabled] [Auto]

### PIO Mode [Auto]

Selects the PIO mode. Configuration options: [Auto] [0] [1] [2] [3] [4]

### DMA Mode [Auto]

Selects the DMA mode. Configuration options: [Auto] [SWDMA0] [SWDMA1] [SWDMA2] [MWDMA0] [MWDMA1] [MWDMA2] [UDMA0] [UDMA1] [UDMA2] [UDMA3] [UDMA4] [UDMA5]

### SMART Monitoring [Auto]

Sets the Smart Monitoring, Analysis, and Reporting Technology. Configuration options: [Auto] [Disabled] [Enabled]

### 32Bit Data Transfer [Disabled]

Enables or disables 32-bit data transfer. Configuration options: [Disabled] [Enabled]

## 4.3.6 IDE Configuration

The items in this menu allow you to set or change the configurations for the IDE devices installed in the system. Select an item then press Enter if you wish to configure the item.

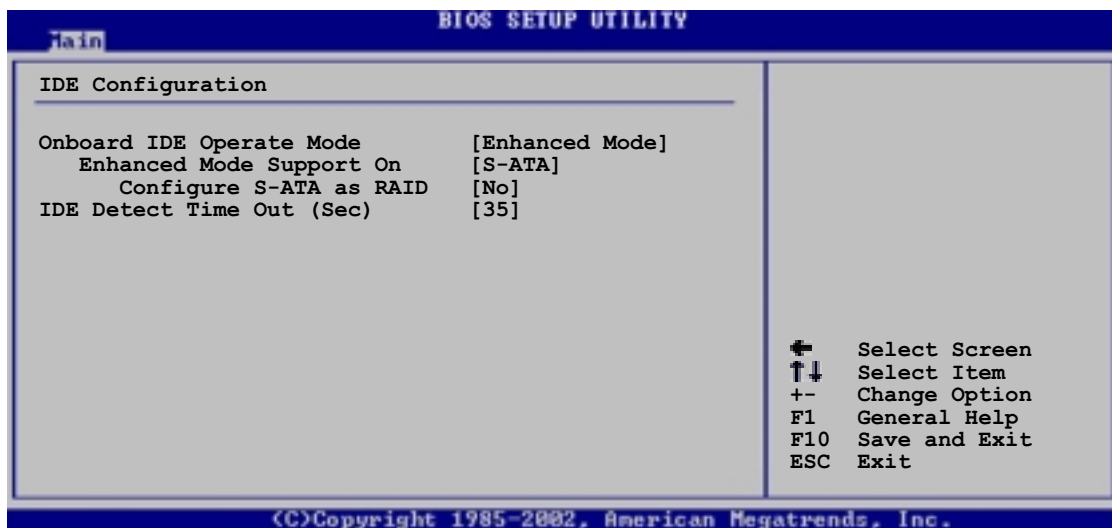

### **Onboard IDE Operate Mode [Enhanced Mode]**

Allows selection of the IDE operation mode depending on the operating system (OS) that you installed. Set to Enhanced Mode if you are using native OS, such as Windows 2000/XP. Set to Compatible Mode if you are using legacy OS including MS-DOS, Windows ME/98/NT4.0.

Configuration options: [Compatible Mode] [Enhanced Mode]



---

Refer to the section “Parallel ATA and Serial ATA device configurations” on page 2-24 for the appropriate settings of the IDE Configuration items under different operating systems.

---

### Enhanced Mode Support On [S-ATA]

The default setting S-ATA allows you to use native OS on Serial ATA and Parallel ATA ports. We recommend that you do not change the default setting for better OS compatibility. In this setting, you may use legacy OS on the Parallel ATA ports **only if** you did not install any Serial ATA device.

The P-ATA+S-ATA and P-ATA options are for advanced users only. If you set to any of these options and encounter problems, revert to the default setting **S-ATA**.

Configuration options: [P-ATA+S-ATA] [S-ATA] [P-ATA]



---

The **Enhanced Mode Support On** appears only when the item **Onboard IDE Operate Mode** is set to **Enhanced Mode**.

---

### Configure SATA as RAID [No]

Allows you to configure the S-ATA channels to function either as standard IDE or as RAID. Configuration options: [Yes] [No]

### Serial ATA BOOTROM [Disabled]

Allows you to enable or disable the Serial ATA boot ROM.

Configuration options: [Disabled] [Enabled]



---

The **Serial ATA BOOTROM** appears only when the item **Configure SATA as RAID** is set to **Yes**.

---

### IDE Port Settings [Primary P-ATA+S-ATA]

Allows selection of the IDE ports to activate if you are using a **legacy** operating system. Set to [Primary P-ATA+S-ATA] if you wish to use the primary Parallel ATA and Serial ATA ports, or set to [Secondary P-ATA+SATA] to enable the secondary P-ATA port instead. Setting to [P-ATA Ports Only] disables the two Serial ATA ports supported by ICH5. Configuration options: [Primary P-ATA+S-ATA] [Secondary P-ATA+S-ATA] [P-ATA Ports Only]



---

The **IDE Port Settings** appears only when the item **Onboard IDE Operate Mode** is set to **Compatible Mode**.

---



## IDE Detect Time Out [35]

Selects the time out value for detecting ATA/ATAPI devices. Configuration options: [0] [5] [10] [15] [20] [25] [30] [35]

## 4.3.7 System Information

This menu gives you an overview of the general system specifications. The items in this menu are auto-detected by BIOS.

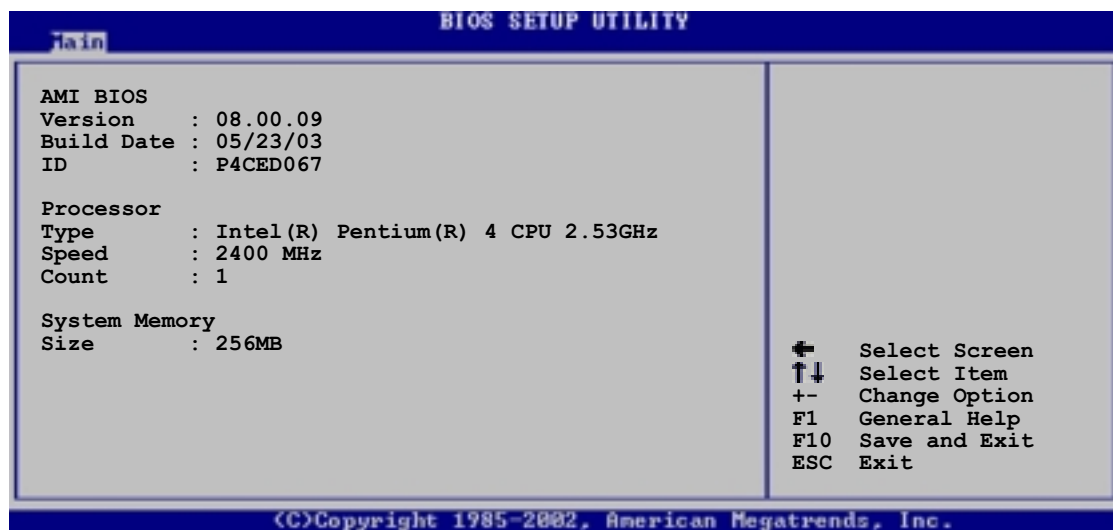

### AMI BIOS

This item displays the auto-detected BIOS information.

### Processor

This item displays the auto-detected CPU specification.

### System Memory

This item displays the auto-detected system memory.

## 4.4 Advanced menu

The Advanced menu items allow you to change the settings for the CPU and other system devices.



Take caution when changing the settings of the Advanced menu items. Incorrect field values may cause the system to malfunction.

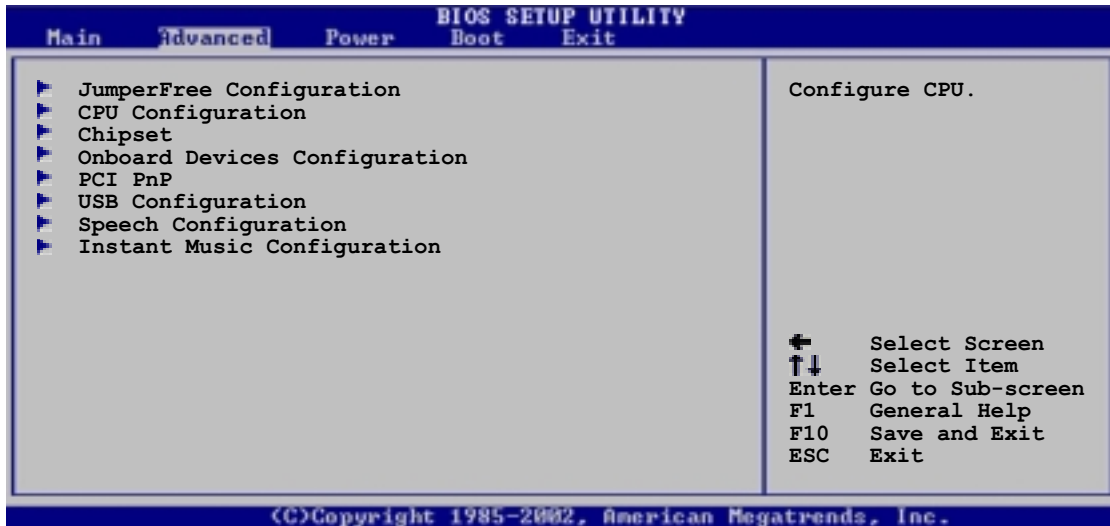

### 4.4.1 JumperFree Configuration

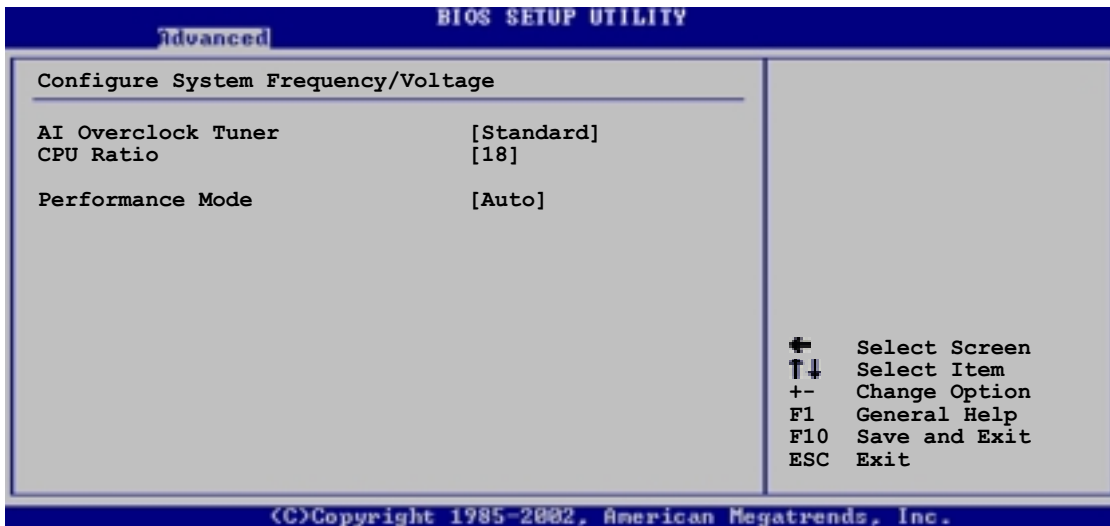

#### AI Overclock Tuner [Standard]

Allows selection of CPU overclocking options to achieve desired CPU internal frequency. Select either one of the preset overclocking options. Configuration options: [Manual] [Standard] [Overclock 5%] [Overclock 10%] [Overclock 20%] [Overclock 30%]



Selecting a very high CPU frequency may cause the system to become unstable! If this happens, revert to the default setting.

## CPU Ratio [18]

Sets the ratio between the CPU core clock and the FSB frequency.



This item appears only if you are using an unlocked CPU. You may select your desired ratio from the available options.

## Performance Mode [Auto]

Allows enhanced system performance. Configuration options: [Auto] [Standard] [Turbo]



Setting to **Turbo** may cause the system to become unstable! If this happens, revert to the default setting Auto.

When you set the **AI Overclocking Tuner** item to [Manual], the related overclocking items appear.

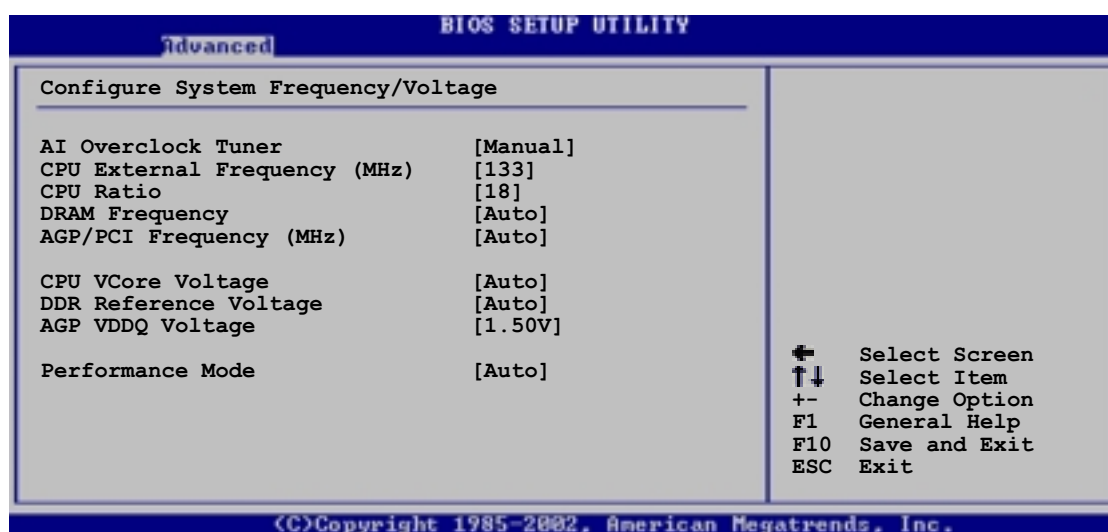

## CPU External Frequency (MHz) [XXX] (value is auto-detected)

Indicates the frequency sent by the clock generator to the system bus and PCI bus. The bus frequency (external frequency) multiplied by the bus multiple equals the CPU speed. The value of this item is auto-detected by BIOS. The values range from 100 to 400.

## DRAM Frequency [Auto]

Allows you to set the DDR operating frequency. Configuration options: [266 MHz] [333 MHz] [400 MHz] [Auto]

### **AGP/PCI Frequency (MHz) [Auto]**

Allows you to adjust to a higher AGP/PCI frequency for better system performance and overclocking capability. Configuration options: [Auto] [66.66/33.33] [72.73/36.36] [80.00/40.00]



---

Selecting a very high AGP/PCI frequency may cause the system to become unstable! If this happens, revert to the default setting.

---

### **CPU VCore Voltage [Auto]**

Allows you to select a specific CPU VCore voltage. Configuration options: [Auto] [1.6000V] ... [1.4750V]



---

Refer to the CPU documentation before setting the CPU VCore voltage. A very high Vcore voltage may severely damage the CPU!

---

### **DDR Reference Voltage [Auto]**

Allows selection of the DDR SDRAM operating voltage. Configuration options: [2.85V] [2.75V] [2.65V] [2.55V] [Auto]

### **AGP VDDQ voltage [1.50V]**

Allows selection of the AGP operating voltage. Configuration options: [1.80V] [1.70V] [1.60V] [1.50V]

## 4.4.2 CPU Configuration

The items in this menu show the CPU-related information auto-detected by BIOS.

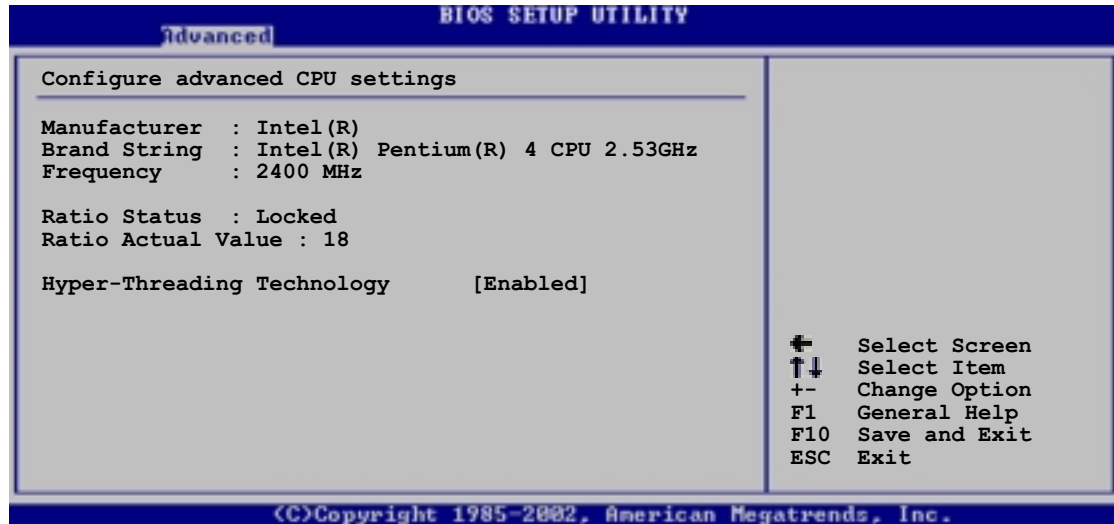

### Hyper-Threading Technology [Enabled]

This item allows you to enable or disable the processor Hyper-Threading Technology. Configuration options: [Disabled] [Enabled]



The item **Hyper-Threading Technology** appears only if you installed an Intel Pentium 4 CPU that supports this feature.

## 4.4.3 Chipset

The Chipset menu items allow you to change the advanced chipset settings. Select an item then press Enter to display the sub-menu.

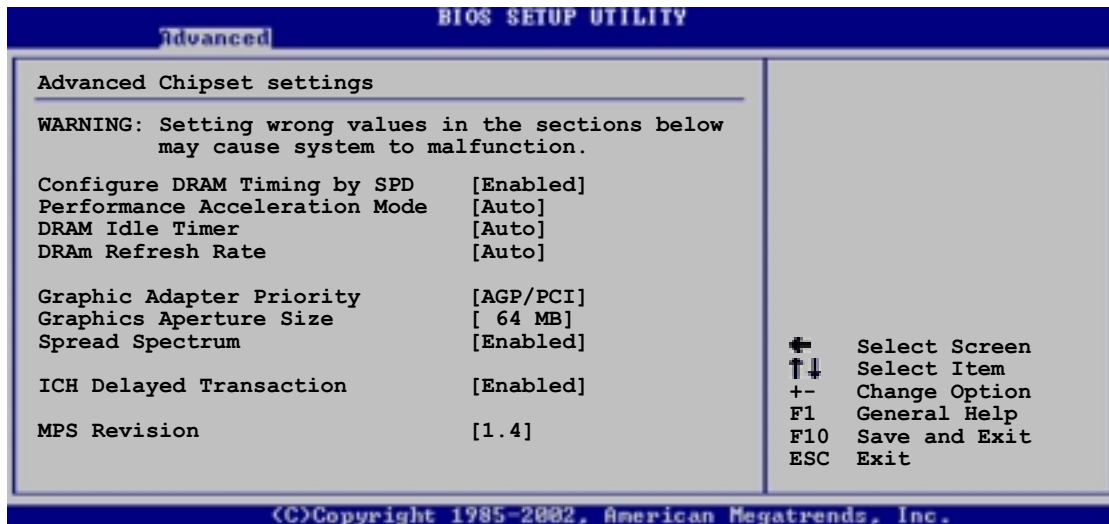

### Configure DRAM Timing by SPD [Enabled]

When this item is enabled, the DRAM timing parameters are set according to the DRAM SPD (Serial Presence Detect). When disabled, you can manually set the DRAM timing parameters through the DRAM sub-items. Configuration options: [Disabled] [Enabled]

### Performance Acceleration Mode [Auto]

Allows boost in system performance. Configuration options: [Auto] [Enabled]

### DRAM Idle Timer [Auto]

Configuration options: [Infinite] [0T] [8T] [16T] [64T] [Auto]

### DRAM Refresh Mode [Auto]

Configuration options: [Auto] [15.6 uSec] [7.8 uSec] [64 uSec] [64T]



If the system becomes unstable after changing the settings of any of the above items, revert to the default settings.



---

The following sub-items appear only when the item **Configure DRAM Timing by SPD** is set to Disabled.

---

**DRAM CAS# Latency [2.5 Clocks]**

This item controls the latency between the SDRAM read command and the time the data actually becomes available. Configuration options: [2.0 Clocks] [2.5 Clocks] [3.0 Clocks]

**DRAM RAS# Precharge [4 Clocks]**

This item controls the idle clocks after issuing a precharge command to the DDR SDRAM. Configuration options: [4 Clocks] [3 Clocks] [2 Clocks]

**DRAM RAS# to CAS# Delay [4 Clocks]**

This item controls the latency between the DDR SDRAM active command and the read/write command. Configuration options: [4 Clocks] [3 Clocks] [2 Clocks]

**DRAM Precharge Delay [8 Clocks]**

Configuration options: [8 Clocks] [7 Clocks] [6 Clocks] [5 Clocks]

**DRAM Burst Length [4 Clocks]**

Configuration options: [4 Clocks] [8 Clocks]

**Graphic Adapter Priority [AGP/PCI]**

Allows selection of the graphics controller to use as primary boot device. Configuration options: [AGP/PCI] [PCI/AGP]

**Graphics Aperture Size [64MB]**

Allows you to select the size of mapped memory for AGP graphic data. Configuration options: [4MB] [8MB] [16MB] [32MB] [64MB] [128MB] [256MB]

**Spread Spectrum [Enabled]**

Configuration options: [Disabled] [Enabled]

**ICH Delayed Transaction [Enabled]**

Configuration options: [Disabled] [Enabled]

**MPS Revision [1.4]**

Configuration options: [1.1] [1.4]

## 4.4.4 Onboard Devices Configuration

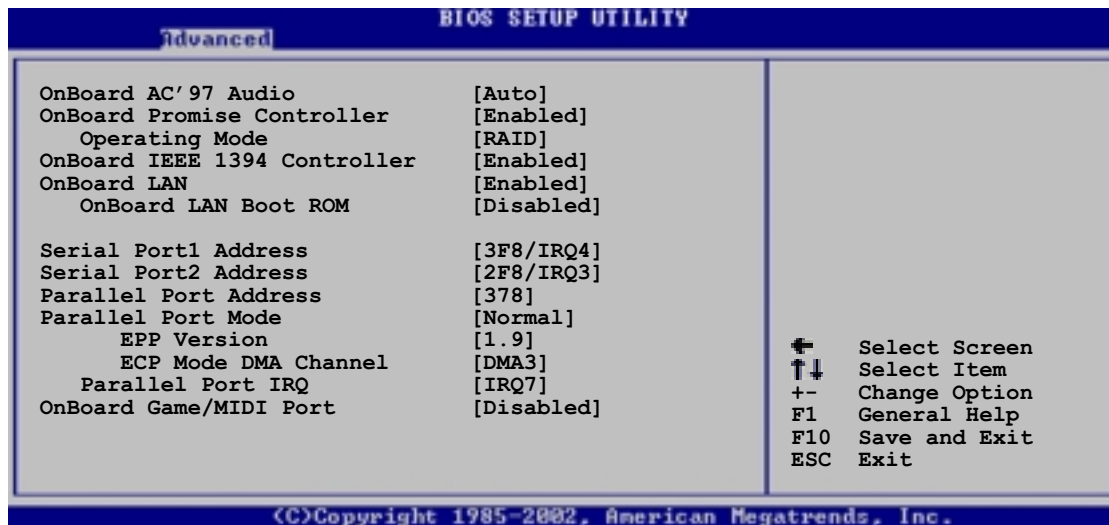

### OnBoard AC'97 Audio [Auto]

[Auto] allows the BIOS to detect whether you are using any audio device. If an audio device is detected, the onboard audio controller is enabled; if no audio device is detected, the controller is disabled. Configuration options: [Disabled] [Auto]

### OnBoard Promise Controller [Enabled]

Allows you to enable or disable the onboard RAID controller. Configuration options: [Disabled] [Enabled]

#### Operating Mode [RAID]

Allows you to set the Promise RAID controller operating mode. This item appears only when the item **Onboard Promise Controller** is set to Enabled. Configuration options: [RAID] [IDE]

### OnBoard IEEE 1394 Controller [Enabled]

Allows you to enable or disable the onboard IEEE 1394 controller. Configuration options: [Disabled] [Enabled]

### OnBoard LAN [Enabled]

Allows you to enable or disable the onboard LAN controller. Configuration options: [Disabled] [Enabled]

#### OnBoard LAN Boot ROM [Disabled]

Allows you to enable or disable the option ROM in the onboard LAN controller. This item appears only when the Onboard LAN item is set to Enabled. Configuration options: [Disabled] [Enabled]



### **Serial Port1 Address [3F8/IRQ4]**

Allows you to select the Serial Port1 base address. Configuration options: [Disabled] [3F8/IRQ4] [3E8/IRQ4] [2E8/IRQ3]

### **Serial Port2 Address [2F8/IRQ3]**

Allows you to select the Serial Port2 base address. Configuration options: [Disabled] [2F8/IRQ3] [3E8/IRQ4] [2E8/IRQ3]

### **Parallel Port Address [378]**

Allows you to select the Parallel Port base addresses. Configuration options: [Disabled] [378] [278] [3BC]

### **Parallel Port Mode [ECP]**

Allows you to select the Parallel Port mode. When the item **Parallel Port Address** is set to **3BC**, the Parallel Port Mode options are only Normal, Bi-directional, and ECP. Configuration options: [Normal] [Bi-directional] [EPP] [ECP]

#### *EPP Version [1.9]*

Allows selection of the Parallel Port EPP version. This item appears only when the **Parallel Port Mode** is set to **EPP**. Configuration options: [1.9] [1.7]

#### *ECP Mode DMA Channel [DMA3]*

Allows selection of the Parallel Port ECP DMA channel. This item appears only when the **Parallel Port Mode** is set to **ECP**. Configuration options: [DMA0] [DMA1] [DMA3]

#### *Parallel Port IRQ [IRQ7]*

Allows you to select the Parallel Port IRQ. Configuration options: [IRQ5] [IRQ7]

### **Onboard Game/MIDI Port [Disabled]**

Allows you to select the Game Port address or to disable the port. Configuration options: [Disabled] [200/300] [200/330] [208/300] [208/330]

## 4.4.5 PCI PnP

The PCI PnP menu items allow you to change the advanced settings for PCI/PnP devices. The menu includes setting IRQ and DMA channel resources for either PCI/PnP or legacy ISA devices, and setting the memory size block for legacy ISA devices.



Take caution when changing the settings of the PCI PnP menu items. Incorrect field values may cause the system to malfunction.

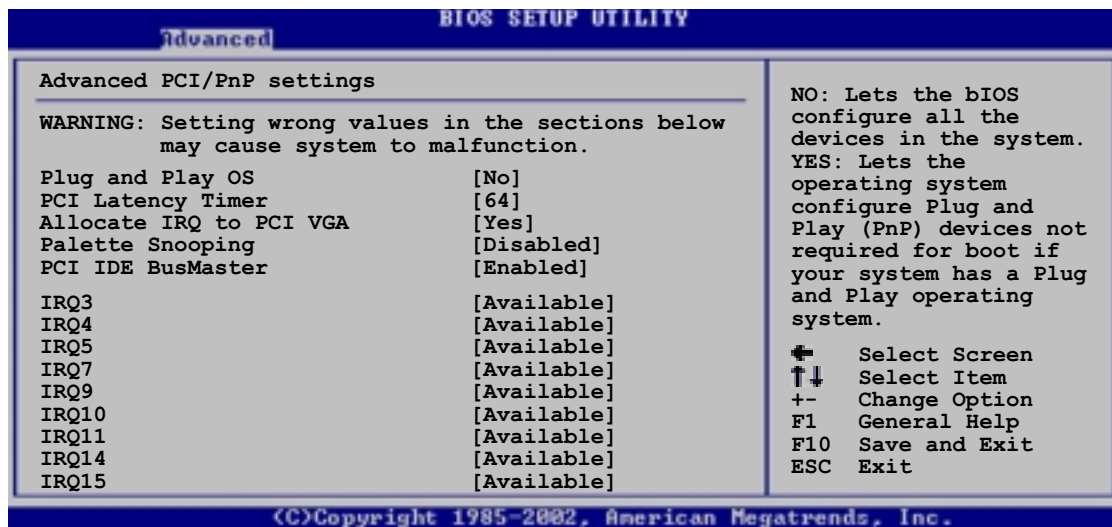

### Plug and Play O/S [No]

When set to [No], BIOS configures all the devices in the system. When set to [Yes] and if you installed a Plug & Play operating system, the operating system configures the Plug & Play devices not required for boot.

Configuration options: [No] [Yes]

### PCI Latency Timer [64]

Allows you to select the value in units of PCI clocks for the PCI device latency timer register. Configuration options: [32] [64] [96] [128] [160] [192] [224] [248]

### Allocate IRQ to PCI VGA [Yes]

When set to [Yes], BIOS assigns an IRQ to PCI VGA card if the card requests for an IRQ. When set to [No], BIOS does not assign an IRQ to the PCI VGA card even if requested. Configuration options: [No] [Yes]

## Pallete Snooping [Disabled]

When set to [Enabled], the pallete snooping feature informs the PCI devices that an ISA graphics device is installed in the system so that the latter can function correctly. Setting to [Disabled] deactivates this feature. Configuration options: [Disabled] [Enabled]

## PCI IDE BusMaster [Enabled]

Allows BIOS to use PCI bus mastering when reading/writing to IDE devices. Configuration options: [Disabled] [Enabled]

## IRQ xx [Available]

When set to [Available], the specific IRQ is free for use of PCI/PnP devices. When set to [Reserved], the IRQ is reserved for legacy ISA devices. Configuration options: [Available] [Reserved]

## 4.4.6 USB Configuration

The items in this menu allows you to change the USB-related features. Select an item then press Enter to display the configuration options.

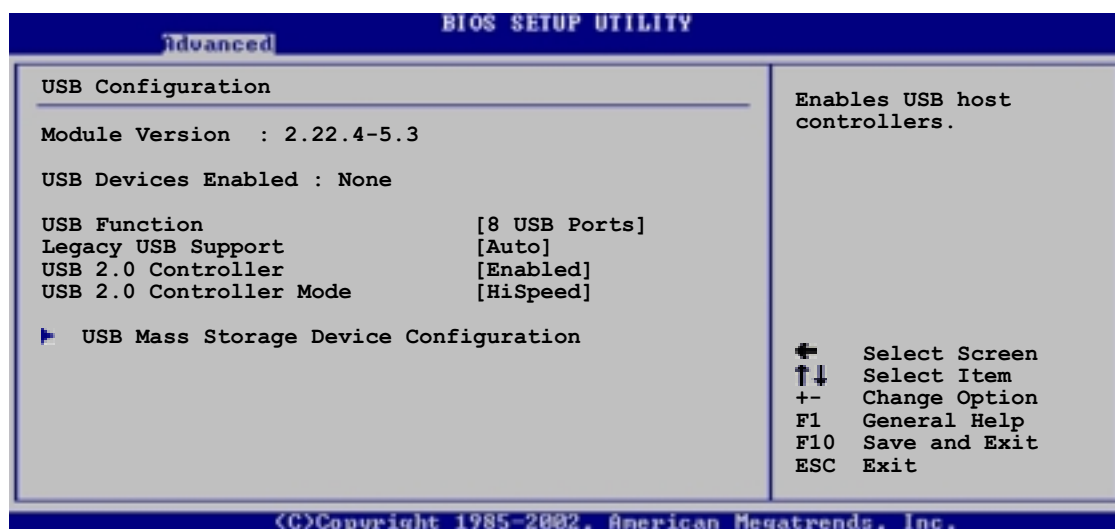

The Module Version and USB Devices Enabled items show the auto-detected values. If no USB device is detected, the item shows None.

## USB Function [8 USB Ports]

Allows you to set the number of USB ports to activate. Configuration options: [Disabled] [2 USB Ports] [4 USB Ports] [6 USB Ports] [8 USB Ports]

## Legacy USB Support [Auto]

Allows you to enable or disable support for legacy USB devices. Setting to Auto allows the system to detect the presence of USB devices at startup. If detected, the USB controller legacy mode is enabled. If no USB device is detected, the legacy USB support is disabled. Configuration options: [Disabled] [Enabled] [Auto]

## USB 2.0 Controller [Enabled]

Allows you to enable or disable the USB 2.0 controller. Configuration options: [Disabled] [Enabled]

## USB 2.0 Controller Mode [HiSpeed]

Allows you to configure the USB 2.0 controller in HiSpeed (480 Mbps) or Full Speed (12 Mbps). Configuration options: [HiSpeed] [Full Speed]

## USB Mass Storage Device Configuration

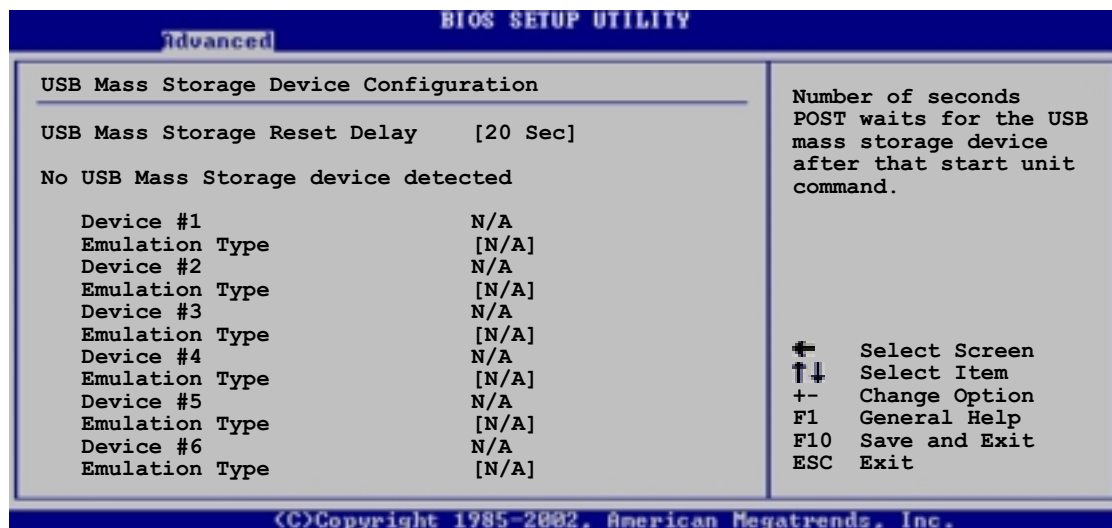

### USB Mass Storage Reset Delay [20 Sec]

Allows you to select the number of seconds POST waits for the USB mass storage device after the start unit command. The message “No USB mass storage device detected” appears if none is installed in the system. Configuration options: [10 Sec] [20 Sec] [30 Sec] [40 Sec]

### Emulation Type [N/A]

When set to Auto, USB devices less than 530MB will be emulated as floppy drive, and the remaining drives as hard drives. Forced FDD option can be used to force an HDD formatted drive to boot as FDD (for example, ZIP drive).



The Device and Emulation Type items appear only when there are installed USB devices.

## 4.4.7 Speech Configuration

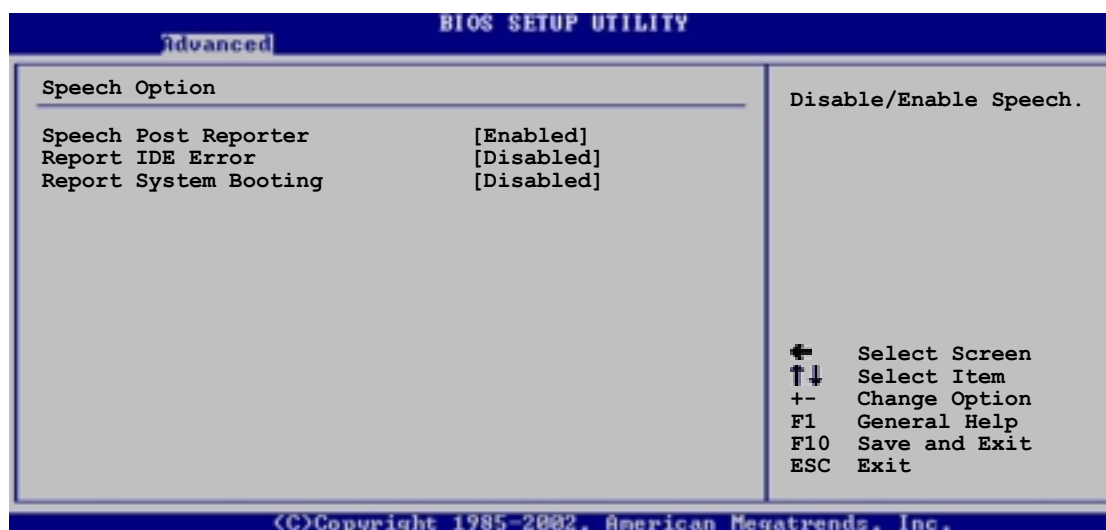

### Speech POST Reporter [Enabled]

Allows you to enable or disable the ASUS Speech POST Reporter™ feature. Configuration options: [Disabled] [Enabled]



---

The following items appear only when Speech POST Reporter is set to Enabled.

---

### Report IDE Error [Disabled]

Configuration options: [Disabled] [Enabled]

### Report System Booting [Disabled]

Configuration options: [Disabled] [Enabled]

## 4.4.8 Instant Music Configuration



### Instant Music [Disabled]

Allows you to enable or disable the Instant Music feature in BIOS.

Configuration options: [Disabled] [Enabled]



When Instant Music is enabled, the PS/2 keyboard power up feature is automatically disabled.

### Instant Music CD-ROM Drive [IDE Secondary Master]

Allows you to select the CD-ROM drive that you wish to use for the Instant Music CD playback. Configuration options: [IDE Primary Master] [IDE Primary Slave] [IDE Secondary Master] [IDE Secondary Slave]



The above item appears only if you enabled the Instant Music item.

## 4.5 Power menu

The Power menu items allow you to change the settings for the Advanced Power Management (APM). Select an item then press Enter to display the configuration options.

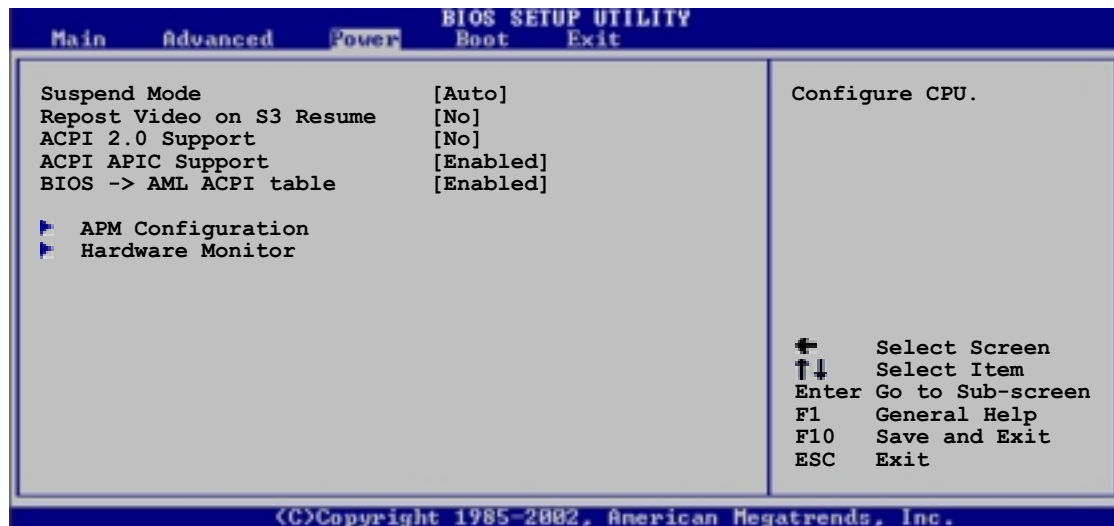

### 4.5.1 Suspend Mode [Auto]

Allows you to select the ACPI state to be used for system suspend.  
Configuration options: [S1 (POS) Only] [S3 Only] [Auto]

### 4.5.2 Repost Video on S3 Resume [No]

Determines whether to invoke VGA BIOS POST on S3/STR resume.  
Configuration options: [No] [Yes]

### 4.5.3 ACPI 2.0 Support [No]

Allows you to add more tables for ACPI 2.0 specifications. Configuration options: [No] [Yes]

### 4.5.4 ACPI APIC Support [Enabled]

Allows you to enable or disable the ACPI support in the ASIC. When set to Enabled, the ACPI APIC table pointer is included in the RSDT pointer list.  
Configuration options: [Disabled] [Enabled]

### 4.5.5 BIOS -> AML ACPI Table [Enabled]

Allows you to enable or disable the inclusion of the BIOS ->AML exchange pointer to (X)RSDT pointer list. Configuration options: [Disabled] [Enabled]

## 4.5.6 APM Configuration

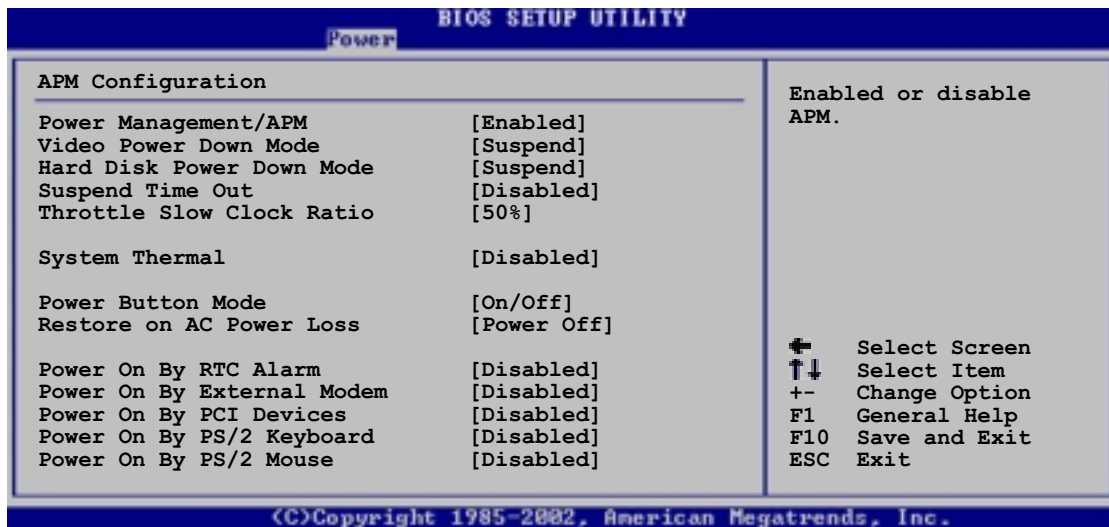

### Power Management/APM [Enabled]

Allows you to enable or disable the Advanced Power Management (APM) feature. Configuration options: [Disabled] [Enabled]

### Video Power Down Mode [Suspend]

Allows you to select the video power down mode. Configuration options: [Disabled] [Standby] [Suspend]

### Hard Disk Power Down Mode [Suspend]

Allows you to select the hard disk power down mode. Configuration options: [Disabled] [Standby] [Suspend]

### Suspend Time Out [Disabled]

Allows you to select the specified time at which the system goes on suspend. Configuration options: [Disabled] [1-2 Min] [2-3 Min] [4-5 Min] [8-9 Min] [10 Min] [20 Min] [30 Min] [40 Min] [50 Min] [60 Min]

### Throttle Slow Clock Ratio [50%]

Allows you to select the duty cycle in throttle mode. Configuration options: [87.5%] [75.0%] [62.5%] [50%] [37.5%] [25%] [12.5%]

### System Thermal [Disabled]

Allows you to enable or disable the system thermal feature to generate a power management event. Configuration options: [Disabled] [Enabled]



### **Power Button Mode [On/Off]**

Allows the system to go into On/Off mode or suspend mode when the power button is pressed. Configuration options: [On/Off] [Suspend]

### **Restore on AC Power Loss [Power Off]**

When set to Power Off, the system goes into off state after an AC power loss. When set to Power On, the system goes on after an AC power loss. When set to Last State, the system goes into either off or on state whatever was the system state before the AC power loss. Configuration options: [Power Off] [Power On] [Last State]

### **Power On By RTC Alarm [Disabled]**

Allows you to enable or disable RTC to generate a wake event. When this item is set to Enabled, the items RTC Alarm Date, RTC Alarm Hour, RTC Alarm Minute, and RTC Alarm Second appear with set values. Configuration options: [Disabled] [Enabled]

### **Power On By External Modem [Disabled]**

This allows either settings of [Enabled] or [Disabled] for powering up the computer when the external modem receives a call while the computer is in Soft-off mode. Configuration options: [Disabled] [Enabled]



---

The computer cannot receive or transmit data until the computer and applications are fully running. Thus, connection cannot be made on the first try. Turning an external modem off and then back on while the computer is off causes an initialization string that turns the system power on.

---

### **Power On By PCI Devices [Disabled]**

When set to [Enabled], this parameter allows you to turn on the system through a PCI LAN or modem card. This feature requires an ATX power supply that provides at least 1A on the +5VSB lead. Configuration options: [Disabled] [Enabled]

### **Power On By PS/2 Keyboard [Disabled]**

This parameter allows you to use specific keys on the keyboard to turn on the system. This feature requires an ATX power supply that provides at least 1A on the +5VSB lead. Configuration options: [Disabled] [Enabled]

## Power On By PS/2 Mouse [Disabled]

When set to [Enabled], this parameter allows you to use the PS/2 mouse to turn on the system. This feature requires an ATX power supply that provides at least 1A on the +5VSB lead. Configuration options: [Disabled] [Enabled]

## 4.5.7 Hardware Monitor

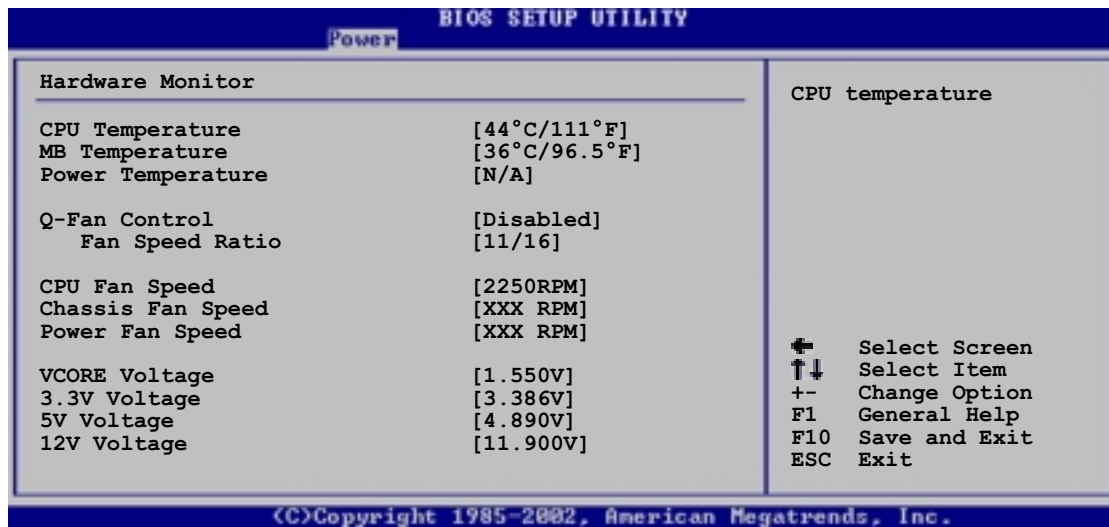

### MB Temperature [xxxC/xxxF]

### CPU Temperature [xxxC/xxxF]

### POWER Temperature [N/A]

The onboard hardware monitor automatically detects and displays the motherboard, CPU, and power supply temperatures. Select Disabled if you do not wish to display the detected temperatures.

### Q-Fan Control [Disabled]

This item allows you to enable or disable the ASUS Q-Fan feature that smartly adjusts the fan speeds for more efficient system operation. When this field is set to [Enabled], the **Fan Speed Ratio** item appears to allow selection of the appropriate fan speed ratio. Configuration options: [Disabled] [Enabled]

## Fan Speed Ratio [11/16]

This item allows you to select the appropriate fan speed ratio for the system. The default [11/16] is the minimum fan speed ratio. Select a higher ratio if you installed additional devices and the system requires more ventilation. Configuration options: [11/16] [12/16] [13/16] [14/16] [15/16]



---

The above item appears only when the **Q-Fan Control** item is set to Enabled.

---

## CPU Fan Speed [xxxxRPM] or [N/A] Chassis Fan Speed [xxxxRPM] or [N/A] Power Fan Speed [xxxxRPM] or [N/A]

The onboard hardware monitor automatically detects and displays the CPU, chassis, and power fan speeds in rotations per minute (RPM). If any of the fans is not connected to the motherboard, the specific field shows N/A.

## VCORE Voltage, +3.3V Voltage, +5V Voltage, +12V Voltage

The onboard hardware monitor automatically detects the voltage output through the onboard voltage regulators.



---

If any of the monitored items is out of range, the following error message appears: "Hardware Monitor found an error. Enter Power setup menu for details". You will then be prompted to "Press F1 to continue or DEL to enter SETUP".

---

## 4.6 Boot menu

The Boot menu items allow you to change the system boot options. Select an item then press Enter to display the sub-menu.

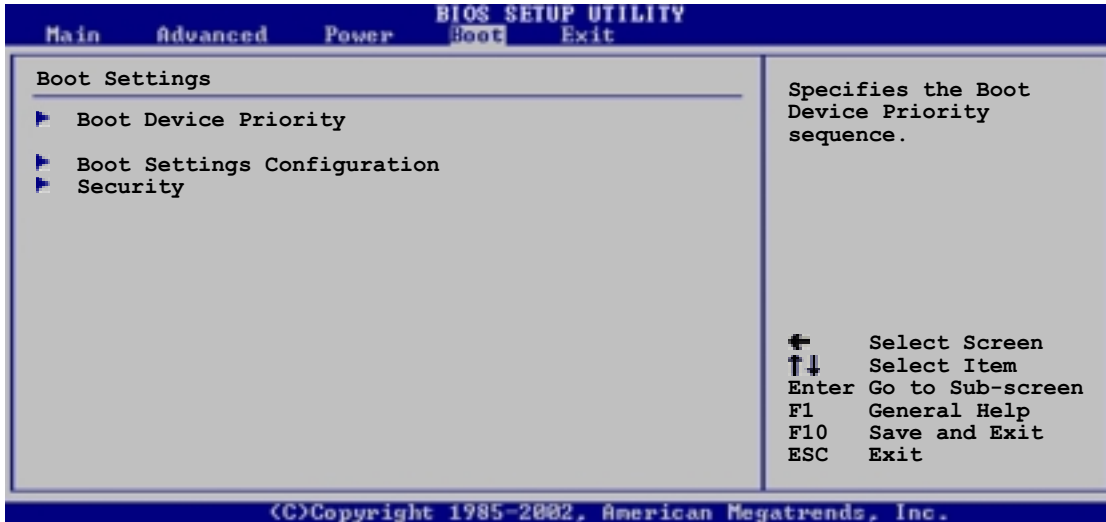

### 4.6.1 Boot Device Priority

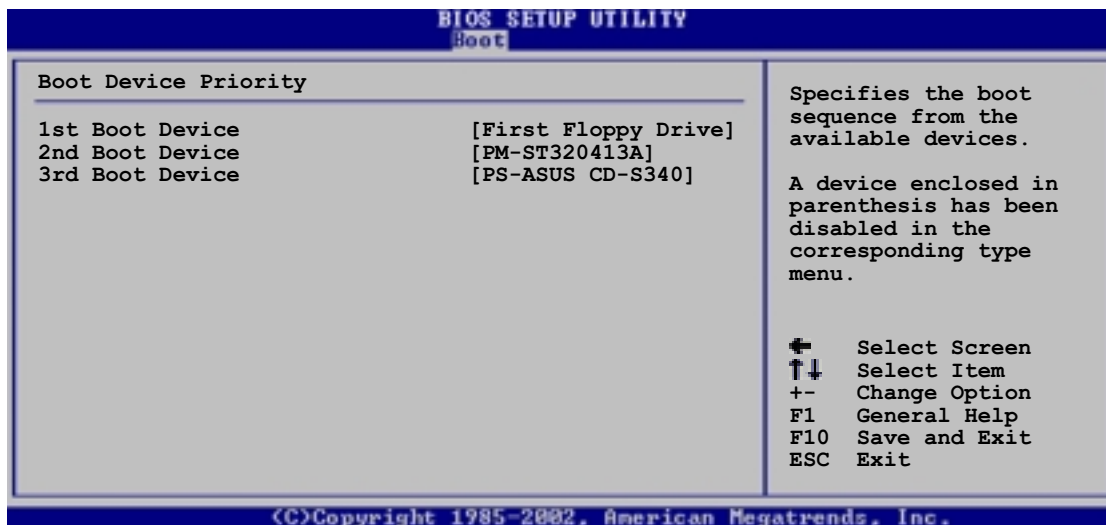

#### 1st ~ xxth Boot Device [1st Floppy Drive]

These items specify the boot device priority sequence from the available devices. The number of device items that appear on the screen depends on the the number of devices installed in the system. Configuration options: [xxxxx Drive] [Disabled]

## 4.6.2 Boot Settings Configuration

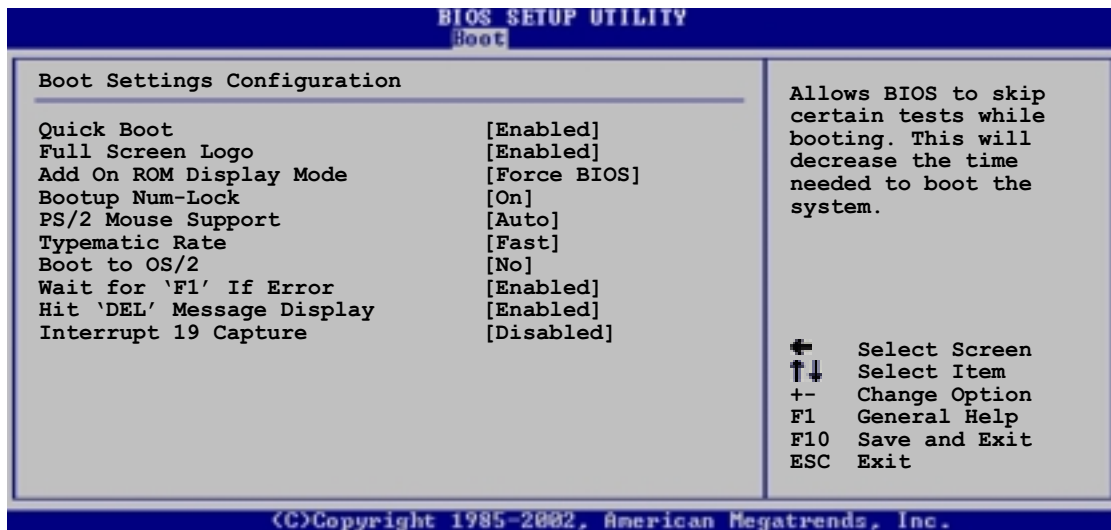

### Quick Boot [Enabled]

Enabling this item allows BIOS to skip some power on self tests (POST) while booting to decrease the time needed to boot the system. When set to [Disabled], BIOS performs all the POST items. Configuration options: [Disabled] [Enabled]

### Full Screen Logo [Enabled]

Setting to [Disabled] displays the normal POST messages. Setting to [Enabled] displays the OEM logo instead of the POST messages. Configuration options: [Disabled] [Enabled]

### Add On ROM Display Mode [Force BIOS]

Sets the display mode for option ROM. Configuration options: [Force BIOS] [Keep Current]

### Bootup Num-Lock [On]

Allows you to select the power-on state for the NumLock. Configuration options: [Off] [On]

### PS/2 Mouse Support [Auto]

Allows you to enable or disable support for PS/2 mouse. Configuration options: [Disabled] [Enabled] [Auto]

**Typematic Rate [Fast]**

Allows you to select the keyboard typematic rate. Configuration options:  
[Slow] [Fast]

**Boot to OS/2 [No]**

Allows you to specify the OS/2 compatibility mode. Configuration options:  
[No] [Yes]

**Wait for 'F1' If Error [Enabled]**

When set to Enabled, the system waits for F1 key to be pressed when error occurs. Configuration options: [Disabled] [Enabled]

**Hit 'DEL' Message Display [Enabled]**

When set to Enabled, the system displays the message "Press DEL to run Setup" during POST. Configuration options: [Disabled] [Enabled]

**Interrupt 19 Capture [Disabled]**

When set to [Enabled], this function allows the option ROMs to trap Interrupt 19. Configuration options: [Disabled] [Enabled]

## 4.6.3 Security

The Security menu items allow you to change the system security settings. Select an item then press Enter to display the configuration options.



### Change Supervisor Password

Select this item to set or change the supervisor password. The Supervisor Password item on top of the screen shows the default **Not Installed**. After you have set a password, this item shows **Installed**.

To set a Supervisor Password:

1. Select the Change Supervisor Password item and press Enter.
2. On the password box that appears, type a password composed of letters and/or numbers, then press Enter. Your password should have at least six characters.
3. Confirm the password when prompted.  
The message "Password Installed" appears after you have successfully set your password.

The Supervisor Password item now shows **Installed**.

To change the supervisor password, follow the same steps as in setting a user password.

To clear the supervisor password, select the Change Supervisor Password then press Enter. The message "Password Uninstalled" appears.



If you forget your BIOS password, you can clear it by erasing the CMOS Real Time Clock (RTC) RAM. See section “2.7 Jumpers” for information on how to erase the RTC RAM.

After you have set a supervisor password, the other items appear to allow you to change other security settings.

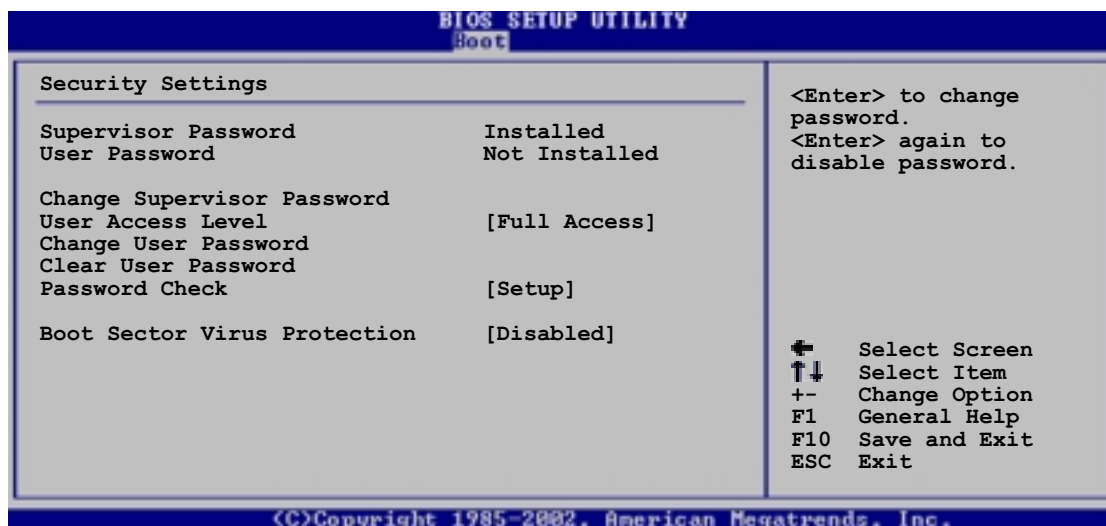

### User Access Level (Full Access)

This item allows you to select the access restriction to the Setup items. Configuration options: [No Access] [View Only] [Limited] [Full Access]

**No Access** prevents user access to the Setup utility.

**View Only** allows access but does not allow change to any field.

**Limited** allows change to only selected fields, such as Date and Time.

**Full Access** allows viewing and changing all the fields in the Setup utility.



## Change User Password

Select this item to set or change the user password. The User Password item on top of the screen shows the default **Not Installed**. After you have set a password, this item shows **Installed**.

To set a User Password:

1. Select the Change User Password item and press Enter.
2. On the password box that appears, type a password composed of letters and/or numbers, then press Enter. Your password should have at least six characters.
3. Confirm the password when prompted.  
The message "Password Installed" appears after you have successfully set your password.

The User Password item now shows **Installed**.

To change the user password, follow the same steps as in setting a user password.

## Clear User Password

Select this item if you wish to clear the user password.

## Password Check [Setup]

When set to [Setup], BIOS checks for user password when accessing the Setup utility. When set to [Always], BIOS checks for user password both when accessing Setup and booting the system. Configuration options:  
[Setup] [Always]

## Boot Sector Virus Protection [Disabled]

Allows you to enable or disable the boot sector virus protection.  
Configuration options: [Disabled] [Enabled]

## 4.7 Exit menu

The Exit menu items allow you to load the optimal or failsafe default values for the BIOS items, and save or discard your changes to the BIOS items.



Pressing <Esc> does not immediately exit this menu. Select one of the options from this menu or <F10> from the legend bar to exit.

### Exit & Save Changes

Once you are finished making your selections, choose this option from the Exit menu to ensure the values you selected are saved to the CMOS RAM. The CMOS RAM is sustained by an onboard backup battery and stays on even when the PC is turned off. When you select this option, a confirmation window appears. Select [Yes] to save changes and exit.



If you attempt to exit the Setup program without saving your changes, the program prompts you with a message asking if you want to save your changes before exiting. Pressing <Enter> saves the changes while exiting.

### Exit & Discard Changes

Select this option only if you do not want to save the changes that you made to the Setup program. If you made changes to fields other than system date, system time, and password, the BIOS asks for a confirmation before exiting.

## **Discard Changes**

This option allows you to discard the selections you made and restore the previously saved values. After selecting this option, a confirmation appears. Select [Yes] to discard any changes and load the previously saved values.

## **Load Setup Defaults**

This option allows you to load the default values for each of the parameters on the Setup menus. When you select this option or if you press <F5>, a confirmation window appears. Select [Yes] to load default values. Select Exit Saving Changes or make other changes before saving the values to the non-volatile RAM.



# *Chapter 5*

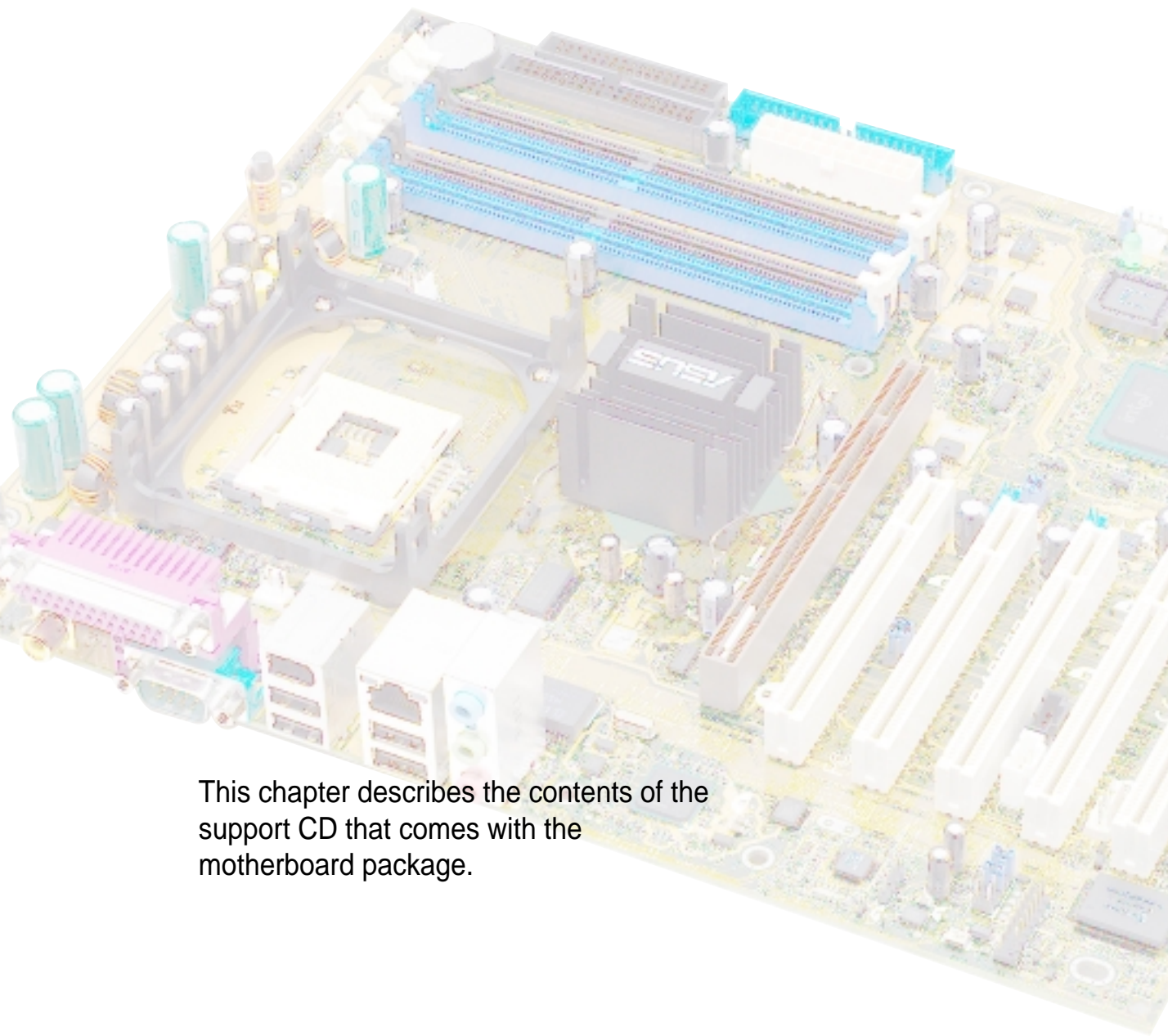

This chapter describes the contents of the support CD that comes with the motherboard package.

## **Software support**

## **Chapter summary**

<b>5.1</b>	<b>Install an operating system .....</b>	<b>5-1</b>
<b>5.2</b>	<b>Support CD information .....</b>	<b>5-1</b>
<b>5.3</b>	<b>Software information .....</b>	<b>5-7</b>
<b>5.4</b>	<b>Promise RAID configurations .....</b>	<b>5-25</b>
<b>5.5</b>	<b>Intel RAID for Serial ATA .....</b>	<b>5-33</b>

## 5.1 Install an operating system

This motherboard supports Windows 98SE/ME/2000/XP operating system (OS). Always install the latest OS version and corresponding updates so you can maximize the features of your hardware.



Because motherboard settings and hardware options vary, use the setup procedures presented in this chapter for general reference only. Refer to your OS documentation for more information.

## 5.2 Support CD information

The support CD that came with the motherboard contains useful software and several utility drivers that enhance the motherboard features.



The contents of the support CD are subject to change at any time without notice. Visit the ASUS website for updates.

### 5.2.1 Running the support CD

To begin using the support CD, simply insert the CD into your CD-ROM drive. The CD automatically displays the **Drivers** menu if Autorun is enabled in your computer.

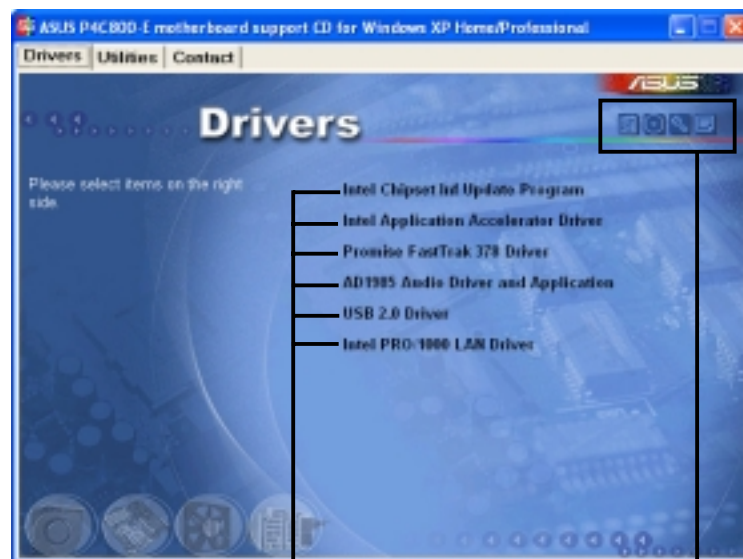

Click an item to install

Click an icon to display more information



If **Autorun** is NOT enabled in your computer, browse the contents of the support CD to locate the file **ASSETUP.EXE** from the **BIN** folder. Double-click the **ASSETUP.EXE** to run the CD.

## 5.2.2 Drivers menu

The drivers menu shows the available device drivers if the system detects installed devices. Install the necessary drivers to activate the devices.

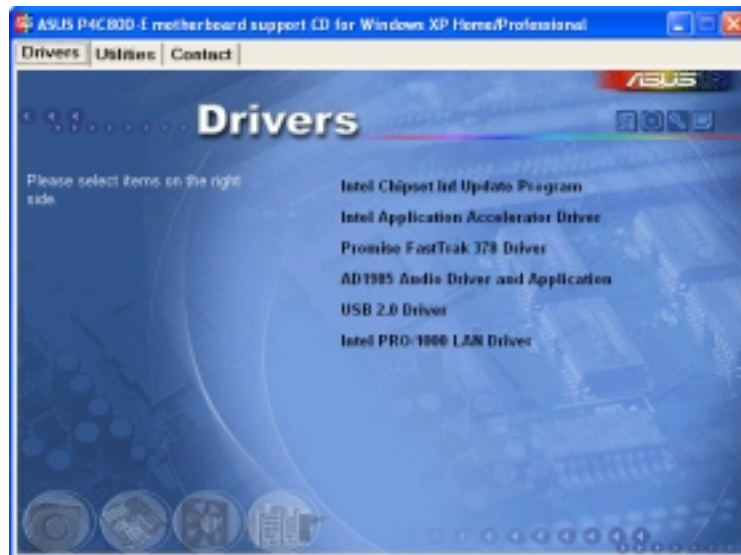

### Intel Chipset Inf Update program

This item installs the Intel® Chipset INF Update Program that enables Plug-n-Play INF support for Intel chipset components. This utility installs to the target system the Windows INF files that outline to the operating system how the chipset components will be configured.

You may install this utility in three modes: interactive, silent, and unattended preload. The interactive mode requires user input during installation. This is not required in the silent and unattended preload modes.

Refer to the online help or readme file that came with the utility.

### Intel Application Accelerator Driver

This item installs the Intel Application Accelerator driver. If you are using Windows® XP, this driver allows RAID 0 configuration for the Serial ATA channels.

### Promise FastTrak 378 Driver

This item installs the Promise FastTrak 378 driver for the Serial ATA and RAID features.

### AD1985 Audio Driver and Application

This item installs the AC'97 AD1985 audio driver and application to activate the 6-channel audio feature.



## USB 2.0 Driver

This item installs the USB 2.0 driver.

## Intel PRO/1000 LAN Driver

This item installs the Intel PRO/1000 driver for the Gigabit LAN solution that provides up to 1000Mbps data transfer rates.

## 5.2.3 Utilities menu

The Utilities menu shows the applications and other software that the motherboard supports.

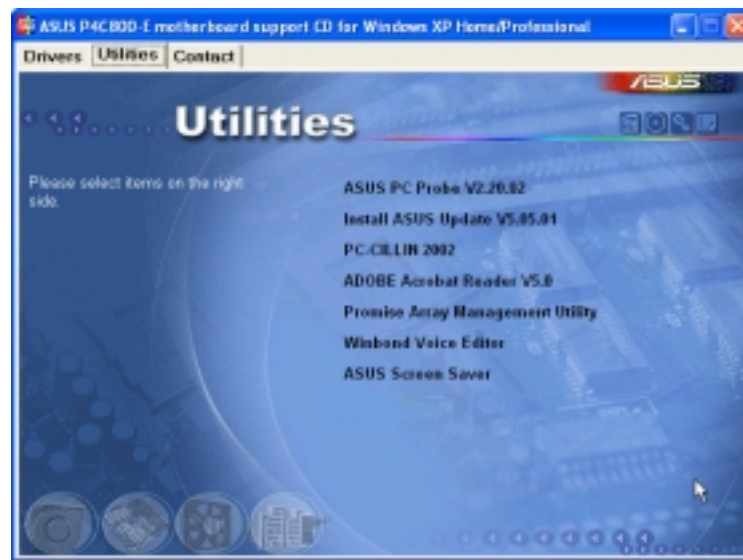

### ASUS PC Probe

This smart utility monitors the fan speed, CPU temperature, and system voltages, and alerts you on any detected problems. This utility helps you keep your computer at a healthy operating condition.

### Install ASUS Update

This program allows you to download the latest version of the BIOS from the ASUS website. Installing ASUS Update also installs ASUS MyLogo2.



---

Before using the ASUS Update, make sure that you have an Internet connection so you can connect to the ASUS website.

---

### PC-CILLIN 2002

This item installs the PC-cillin 2002 anti-virus program. View the PC-cillin online help for detailed information.

## Microsoft Direct X Driver

This item installs the Microsoft Direct X driver under Windows 98SE/ME/2000 operating system.



Windows XP already includes the Microsoft Direct X driver. You do not need to install the driver under this operating system.

## Adobe Acrobat Reader

This item installs the Adobe Acrobat Reader V5.0. The Acrobat Reader software is for viewing files saved in Portable Document Format (PDF).

## Promise Array Management Utility

This item installs the RAID utility for monitoring or performing maintenance to a FastTrak Mirrored (RAID 1) or Striped/Mirrored (RAID 0/1) disk array.

## Winbond Voice Editor

This program is for recording and customizing wave files for the ASUS POST Reporter™. Use this program if you wish to change the default vocal POST messages. See section “3.2 Vocal POST messages” for a list of the default messages.

## ASUS Screen Saver

This item installs the ASUS screen saver.

## 5.2.4 ASUS Contact Information

Clicking the ASUS Contact Information tab displays as stated. You may also find this information on page x of this user guide.



## 5.2.5 Other information

The icons on the top right corner of the screen give additional information on the motherboard and the contents of the support CD. Click an icon to display the specified information.

### Motherboard Info

The window displays the general specifications of the motherboard.

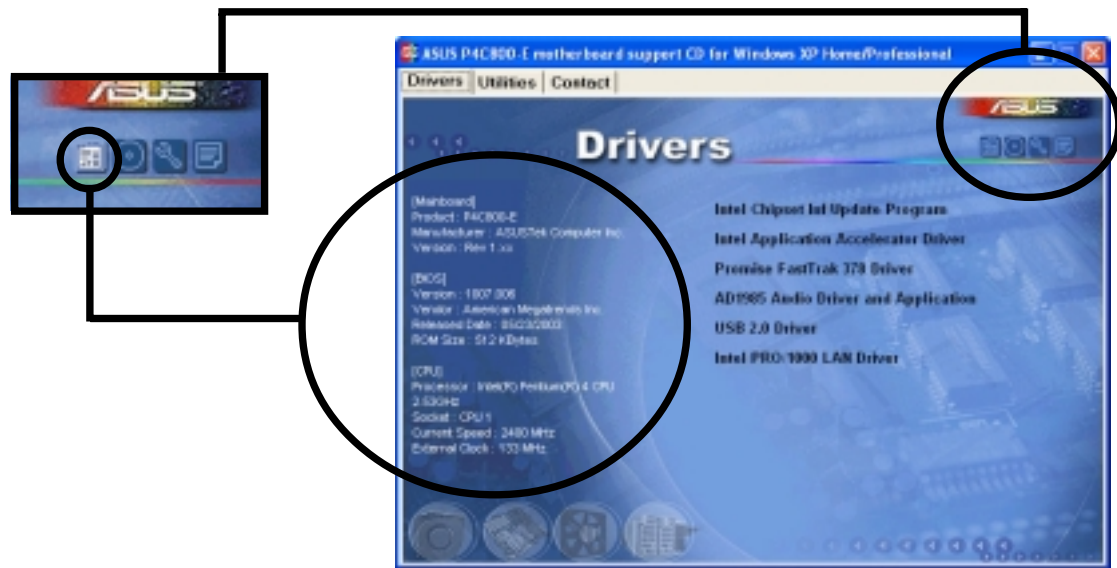

### Browse this CD

The window displays the support CD contents in graphical format.

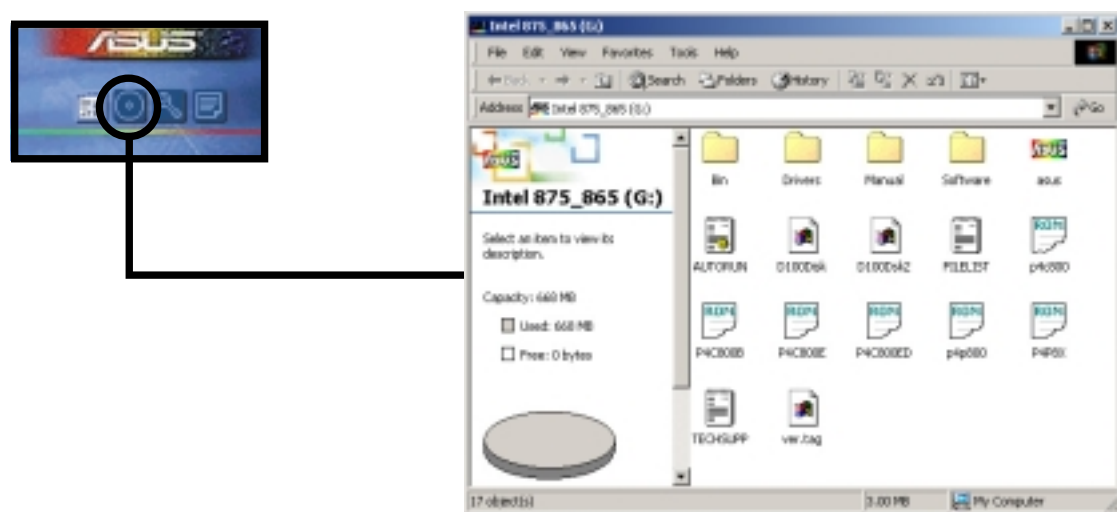

## Technical Support Form

The window displays the ASUS Technical Support Request Form that you have to fill up when requesting technical support.

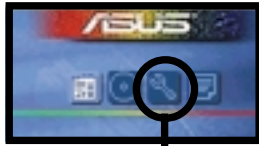

The screenshot shows a Notepad window titled "Techsupp - Notepad" containing the "ASUS TECHNICAL SUPPORT REQUEST FORM". The form is divided into several sections:

- ORIGINATOR DESCRIPTION**: Fields for COMPANY NAME, CONTACT NAME, PHONE (AREA), FAX # (AREA), and EMAIL ADDRESS.
- HARDWARE DESCRIPTION**: Fields for MOTHERBOARD, CPU BRAND, CPU SPEED, CACHE BRAND, CACHE SPEED, HARD DISK, CD/DVD BRAND, DVD/CD BRAND, and OTHER STORAGE. Each field includes sub-fields for REVISION #, SPEED, MODEL NAME, and SIZE.
- ADD-IN CARD DESCRIPTION (MODEL NAME/RENDER)**: Fields for PCI SLOT 1 through PCI SLOT 6.
- SOFTWARE DESCRIPTION**: Fields for OPERATING SYSTEM, APPLICATION SOFTWARE, and DEVICE DRIVERS.
- PROBLEM DESCRIPTION (WHAT PROBLEMS AND UNDER WHAT SITUATIONS)**: A large text area for describing the issue.

## Filelist

The window displays the contents of the support CD and a brief description of each in text format.

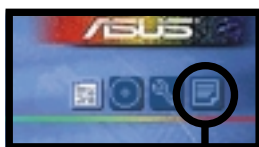

The screenshot shows a Notepad window titled "FILELIST - Notepad" containing a list of files for the P4C800-E motherboard. The list is organized by category and includes file names and descriptions.

File Name	Description
<b>Drivers</b>	
-Audio	
-AD1985	-SoundMAX Audio Driver version 5.12.01.353B.
<b>Chipset</b>	
-IAA	-Intel(R) Application Accelerator RAID Edition for Windows XP.
-Inf	-Intel(R) Chipset Software Installation Utility 5.0 Alpha build 100B.
<b>Display</b>	
-Win2k_xp	-Intel(R) Extreme Graphics Driver 13.0 Alpha Candidate 1.5.
-Win2k	-Windows 2000/XP Driver V6.13.01.3461.
-Win2k	-Windows 98SE/ME Driver V4.13.01.3461.
-Winnt4	-Windows NT 4.0 Driver V4.03.1381.461.
<b>LAN</b>	
-Intel	-Intel(R) Network Adapter Software: Version 6.5.
-3Com	-3com Gigabit LOM (3C940) Driver V1.0.0.27.
<b>Promise</b>	
-VIA	-VIA VT6410 RAID driver V1.00
<b>USB2</b>	
-2K	-USB 2.0 Driver for Windows 2000.
-XP	-USB 2.0 Driver for Windows XP.

## 5.3 Software information

Most of the applications in the support CD have wizards that will conveniently guide you through the installation. View the online help or readme file that came with the software for more information.

This section provides details on the software applications that the motherboard supports.

### 5.3.1 ASUS Update

The ASUS Update is a utility that allows you to update the motherboard BIOS. This utility requires an Internet connection either through a network or an Internet Service Provider (ISP).

Follow these steps to use the ASUS Update.

1. Launch the utility from your Windows Start menu:

**Programs/AsusUpdate Vx.xx.xx/  
AsusUpdate**

The ASUS Update initial screen appears.

2. Select your desired update method, then click Next.



3. If you selected updating/downloading from the Internet, select the ASUS FTP site nearest you to avoid network traffic, or choose Auto Select. Click Next.





- From the selection that appears, choose a logo image. Click Next.



If you wish, you may create your own boot logo image in GIF, JPG, or BMP file formats.



- When you click on an image, it displays larger on the MyLogo2 screen.



If you wish to make the logo image smaller, click on the arrow on the Ratio item and select your desired scale.



- The next screen prompts you to flash the original BIOS to update it with the new boot logo. Click Flash to update the BIOS.
- When finished, click Exit, then reboot your computer. Your system boots with the new boot logo.



Instead of starting from ASUS Update, you may also launch ASUS MyLogo2 directly from the Windows Start menu to change your BIOS boot logo. After you have modified the BIOS file with the new logo, use the ASUS Update utility to upload the new BIOS.

### 5.3.3 ASUS PC Probe

The ASUS PC Probe is a convenient utility to continuously monitor the vital system information, such as fan rotations, voltages, and temperatures. This utility also allows you to check other information about your computer, including hard disk space, memory usage, and CPU type, CPU speed, and internal/external frequencies through the DMI Explorer.

#### Starting ASUS PC Probe

When ASUS PC Probe starts, a splash screen appears allowing you to select whether to show the screen again when you open PC Probe or not. To bypass this startup screen, clear the **Show up in next execution** check box.



To launch **ASUS PC Probe**, click the Windows **Start** button, point to **Programs**, and then **ASUS Utility**, and then click **Probe Vx.xx**.



The PC Probe icon  appears on the taskbar system tray indicating that ASUS PC Probe is running. Clicking the icon allows you to see the status of your PC.





## Using ASUS PC Probe

### Monitoring

#### Monitor Summary

Shows a summary of the items being monitored.



#### Temperature Monitor

Shows the PC temperature (for supported processors only).

Temperature Warning threshold adjustment  
(Move the slider up to increase the threshold level or down to decrease the threshold level)



#### Fan Monitor

Shows the PC fan rotation.

Fan Warning threshold adjustment  
(Move the slider up to increase the threshold level or down to decrease the threshold level)



#### Voltage Monitor

Shows the PC voltages.

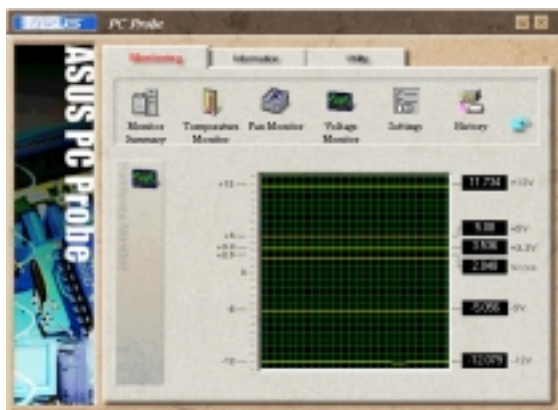

## Settings

Lets you set threshold levels and polling intervals or refresh times of the PC's temperature, fan rotation, and voltages.

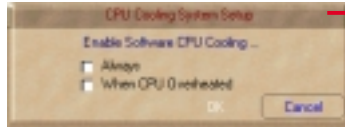

### CPU Cooling System Setup

Lets you select when to enable software CPU cooling. When **When CPU Overheated** is selected, the CPU cooling system is enabled whenever the CPU temperature reaches the threshold value.

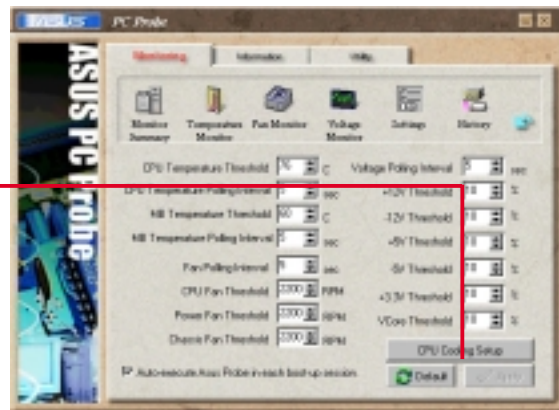

## History

Lets you record the monitoring activity of a certain component of your PC for future reference.

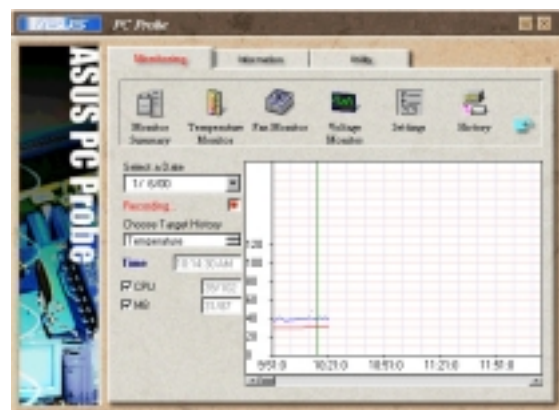

## Fan Control

Lets you enable/disable Smart Fan Control. Smart Fan Control adjusts the fan speed automatically based on the current CPU temperature and predefined threshold.



## Hard Drives

Shows the used and free space of the PC's hard disk drives and the file allocation table or file system used.



## Information

### Memory

Shows the PC memory load, memory usage, and paging file usage.



### Device Summary

Shows a summary of devices present in your PC.



### DMI Explorer

Shows information pertinent to the PC, such as CPU type, CPU speed, and internal/external frequencies, and memory size.

The screenshot shows the DMI Explorer tab in ASUS PC Probe. It displays a list of system information items on the left and a table of properties on the right.

Item	Name	Property
BIOS	Version	Award/Softmark, Inc.
System	Version	AGES P40-F ACR 9605 P4
Motherboard	Manufacturer	FBIS
Chassis	Serial Number	00 921 999
Processor	Release Date	28K
Cache	PCID Size	Supported
Memory Controller	ISA	Not Supported
Port Connectors	PCI	Not Supported
System Slots	PCI	Supported
System Information	PDMAPI	Not Supported
System Configuration	PIF	Supported
BIOS Language	APM	Supported
	BIOS is Upgradable	Supported
	BIOS Flashing	Supported
	VL-MS DA	Not Supported

## Utility

Lets you run programs outside of the ASUS Probe modules. To run a program, click **Execute Program**. **NOTE:** This feature is currently unavailable.

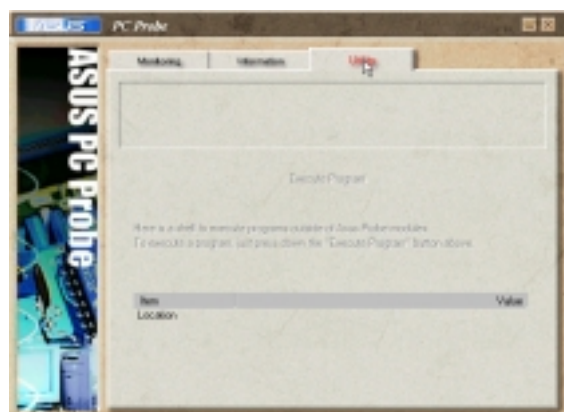

## ASUS PC Probe Task Bar Icon

Right clicking the PC Probe icon brings up a menu to open or exit ASUS PC Probe and pause or resume all system monitoring.



When the ASUS PC Probe senses a problem with your PC, portions of the ASUS PC Probe icon change to red, the PC speaker beeps, and the ASUS PC Probe monitor appears.

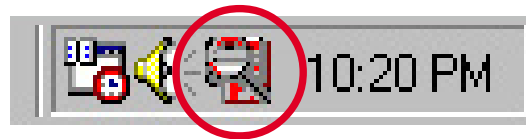

## 5.3.4 Winbond Voice Editor

The Winbond Voice Editor software allows you to customize the vocal POST messages. Install the software from the software menu in the support CD. See section “5.2.3 Software menu”.



---

To avoid conflicts, do not run the Winbond Voice Editor while running the ASUS PC Probe.

---

Follow these steps to use the Winbond Voice Editor.

### Launching the program

Launch the program either from the Winbond Voice Editor icon on your desktop, or from the Windows Start menu, **Programs/Winbond Voice Editor/Voice Editor**.

The Winbond Voice Editor screen appears.

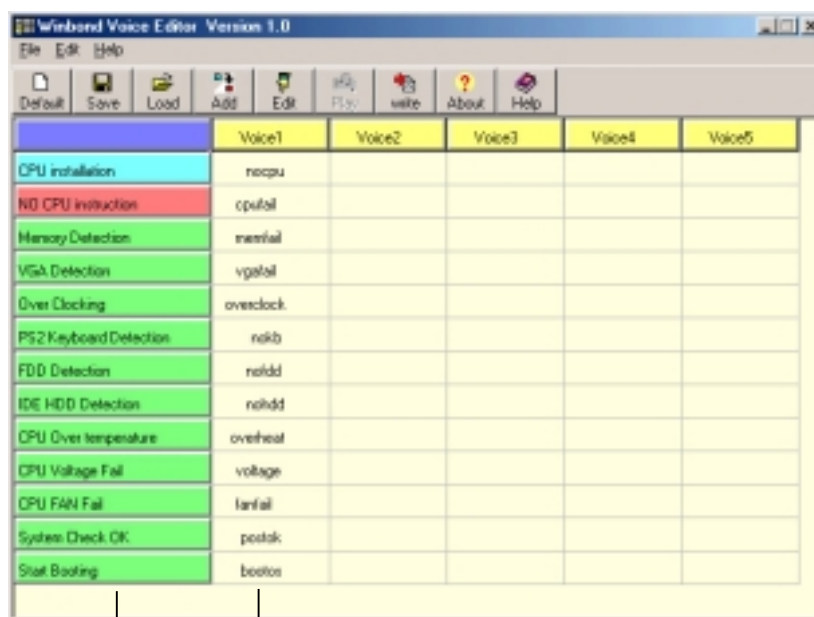

Default Messages

POST Events

### Playing the default wave files

To play the default wave files, simply click on a POST event on the left side of the screen, then click the Play button.



---

The default language setting is English.

---

## Changing the default language

1. Click on the Load button. a window showing the available languages appears.
2. Select your desired language then click Open. The event messages for the language you selected appear on the Voice Editor screen.

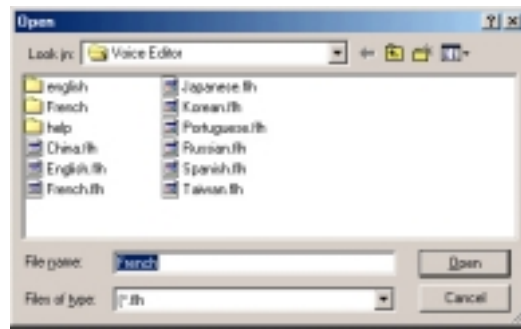

For some languages, not all events have a corresponding message due to file size constraints.

3. Click on the Write button to update the EEPROM.
4. Click Yes on the confirmation window that appears.

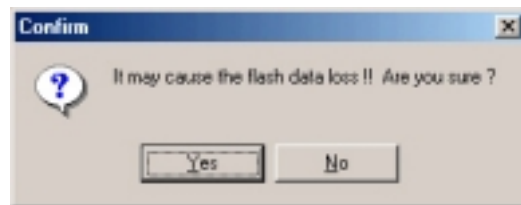

The next time you boot your computer, the POST messages are announced in the language that you selected .

## Customizing your POST messages

If your language is not in the selection or if you wish to record your own POST messages to replace the pre-installed wave files, you may easily do so.

Follow these steps to customize your POST messages.

1. Launch the Voice Editor and take note of the list of POST events on the leftmost column of the screen.
2. Prepare your message for each event.



---

The total compressed size for all the wave files must not exceed 1Mbit, so make your messages as short as possible.

---

3. Use a recording software, such as Windows Recorder, to record your messages.
4. Save the messages as wave files (.WAV). It is recommended that you save your files in low quality to keep them small. For example, use 8-bit, mono quality at 22Khz sampling rate.



---

You may want to create a separate folder for your wave files so you can locate them easily in one place.

---

5. From the Voice Editor screen, click on the Add button to display the Add Wave File window.
6. Copy the wave files that you recorded to the database. Close the window when done.



7. Click a POST event on the Voice Editor screen, then on the Edit button. The Event Sound Editor window appears.
8. Locate and select your wave file for the event then click on the arrow opposite Voice1. The file you selected appears on the space next to it.
9. Click OK to return to the Voice Editor screen.
10. Do steps 7 to 9 for the other events.
11. When done, click the Save button. A window appears prompting you to save your configuration.
12. Type a file name with a .flh extension, then click Save.
13. Click on the Write button to compress the file and copy into the EEPROM.
14. Click Yes on the confirmation window that appears.

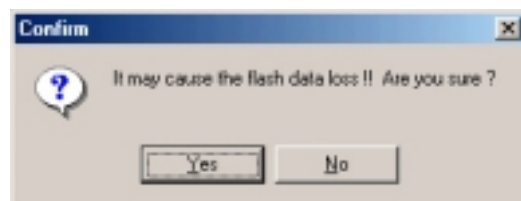
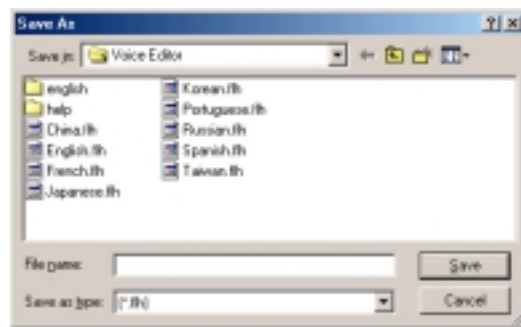
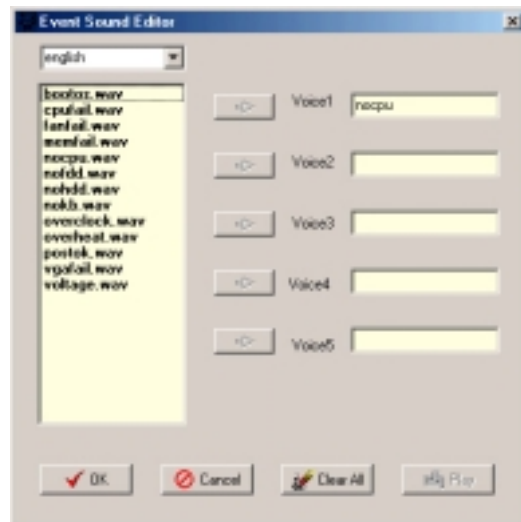

If you receive an error message telling you that the files exceed the total allowable size, do one or all of the following.

- Try to modify your messages to make them shorter
- Save the wave files at a lower quality
- Skip lesser used events like FDD Detection, IDE HDD Detection, etc.



## 5.3.5 SoundMAX® 4 XL software

The ADI AD1985 AC '97 audio CODEC provides 6-channel audio capability through the SoundMAX4 XL with AudioESP™ software to deliver the ultimate audio experience on your PC. The software implements high quality audio synthesis/rendering, 3D sound positioning, and advanced voice-input technologies.

Follow the installation wizard to install the **AD1985 Audio Driver and Application** from the support CD that came with the motherboard package to activate the 6-channel audio feature.



You must use 4-channel or 6-channel speakers for this setup.

SoundMAX 4 XL requires Microsoft Windows 98SE/ME/2000/XP. Make sure that one of these operating systems is installed before installing SoundMAX.

If the SoundMAX4 XL software is correctly installed, you will find the SoundMAX4 XL icon on the taskbar.



SoundMAX4 XL icon

From the taskbar, double-click on the **SoundMAX4 XL** icon to display the **SoundMAX Control Panel**.



## Setup wizards

Use the speaker and microphone setup wizards to fine tune the gain/attenuation of the inputs/outputs for optimal audio performance. You may launch the setup wizards by clicking the Configuration button when AudioESP detects and verifies a newly connected peripheral, or by clicking on the  icon from the SoundMAX control panel.

### Speaker wizard

Follow the screen instructions to configure the speakers to your desired settings.



### Microphone wizard

Follow the screen instructions to configure the microphone to your desired settings.



## Audio preferences

The Preferences page of the SoundMAX4 XL allows you to change various audio settings.

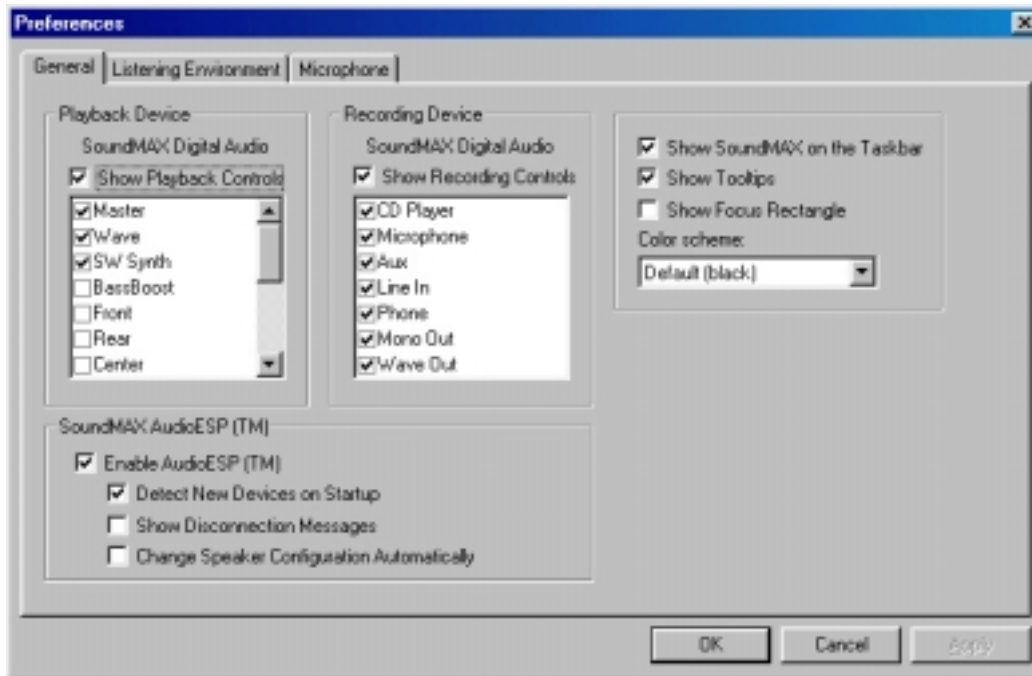

## Listening environment options

The SoundMAX4 XL support several audio technologies including SoundMAX SPX™ Animated Audio, 3DPA™, MultiDrive™ 5.1, EnvironmentFC™, MacroFX/ZoomFX™, and Virtual Theater Surround.

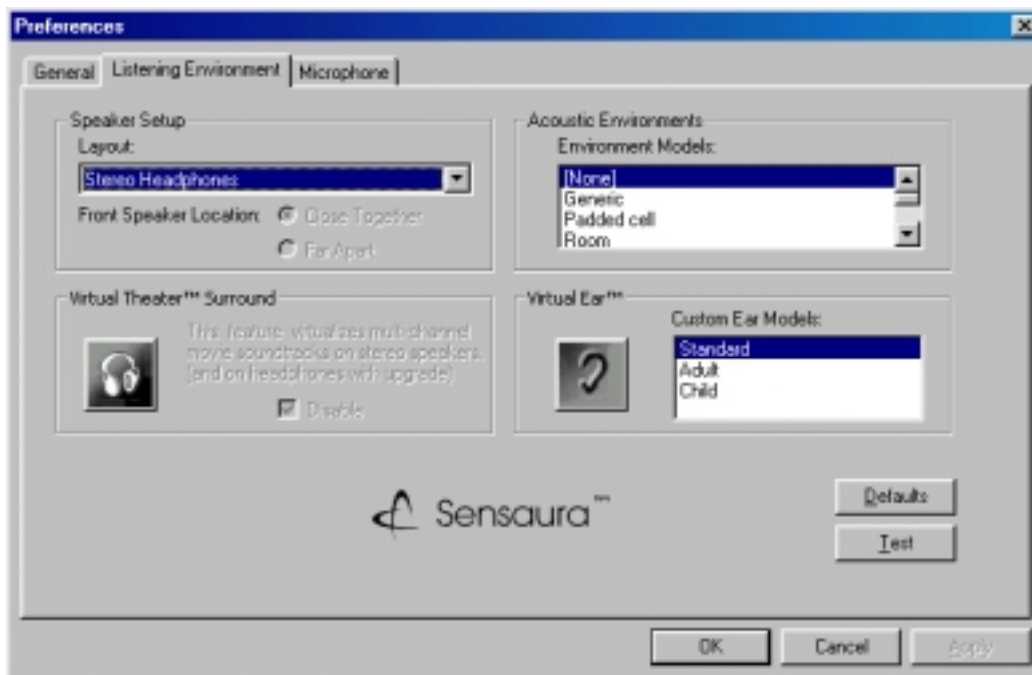

## Rear panel audio ports function variation

The functions of the Line Out (lime), Line In (blue), and Mic (pink) ports on the rear panel change when you select the 4-channel or 6-channel audio configuration as shown in the following table.

	Headphone/ 2-Speaker	4-Speaker	6-Speaker
Light Blue	Line In	Rear Speaker Out	Rear Speaker Out
Lime	Line Out	Front Speaker Out	Front Speaker Out
Pink	Mic In	Mic In	Bass/Center



Windows 98SE only supports 4.1-channel speaker setting.

### 5.3.6 ASUS Instant Music

The motherboard is equipped with a BIOS-based audio playback feature called **Instant Music**. This feature is supported by the onboard audio AC'97 CODEC, and requires an optical drive (CD-ROM, DVD-ROM, or CD-RW).



1. Instant Music only supports CDs in audio format.
2. Instant Music does not work if you installed and enabled an add-on sound card.
3. Instant Music only supports PS/2 keyboard.

#### To enable ASUS Instant Music:

1. Connect the analog audio cable from the optical drive (CD-ROM, DVD-ROM, or CD-RW drive) to the 4-pin CD-In connector (labeled CD) on the motherboard. See section "2.8 Connectors" for the location.



Make sure to connect the CD-ROM audio cable. Otherwise, you cannot control the audio volume using the Instant Music function keys.

2. Turn on the system and enter BIOS by pressing the **Delete** key during the Power On Self-Tests (POST).

3. In the **Instant Music Configuration** menu, select the item **Instant Music** and set it to **Enabled**. See section “4.4.8 Instant Music Configuration.”
4. The **Instant Music CD-ROM Drive** item appears if you enabled Instant Music. Highlight the item then press Enter to display the CD-ROM options.
5. Save your changes and exit BIOS Setup.



1. The Scroll Lock LED is fixed to ON after enabling Instant Music.
2. The Caps Lock LED turns ON when you pause the CD playback.
3. When set to Instant Music mode, the system wake-up features (LAN, keyboard, mouse, USB) are deactivated. In this case, power up the system using the power switch.
4. If the system lost connection or did not detect any optical drive, the Instant Music feature turns OFF (disabled) automatically. A “beep” indicates this condition.

### To use ASUS Instant Music:

1. Ensure that the power cord is plugged to a grounded power source, so that the system has a standby power.
2. Use either one of the two sets of special function keys on your keyboard to play audio CDs. These keys only function as indicated if you enabled the Instant Music item in BIOS.

#### *Instant Music function keys (Set 1)*

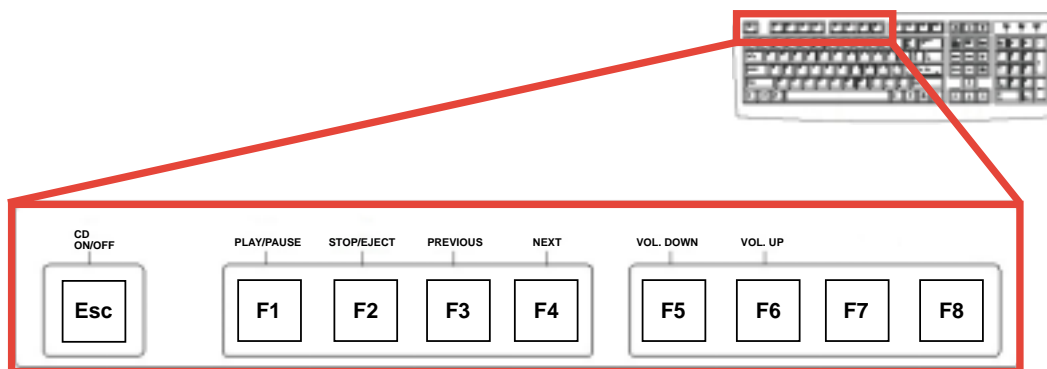

To guide you in using Instant Music, place the Instant Music label over the function keys on the keyboard. The Instant Music keyboard label comes with your motherboard package.

### Instant Music function keys (Set 2)

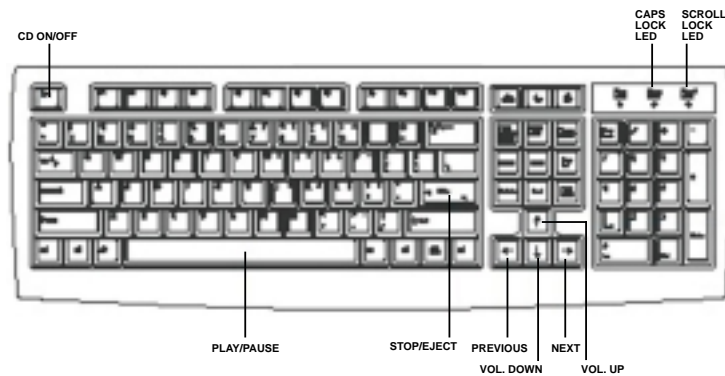

3. Connect speakers or a headphone to the Line Out (lime colored) port on the rear panel for audio output. You may also connect a headphone to the headphone jack on the CD-ROM drive front panel.
4. Place an audio CD on the drive.
5. Press **Esc** to turn ON Instant Music.
6. Press **F1** or the **Space Bar** to play the first track on the CD.



---

If there is no CD on the drive and you press F1 or Space Bar, the drive tray ejects.

---

7. Refer to the Instant Music function key definitions on the previous page to select other tracks or control the volume.
8. Press **F2** or **Enter** *once* to stop playing the CD.  
Press **F2** or **Enter** *one more time* to eject the CD.

## 5.4 Promise® RAID configurations

The motherboard includes the Promise® PDC20378 controller chipset to support Redundant Array of Independent Disks (RAID) configurations. Using two Serial ATA hard disks on SATA\_RAID1/SATA\_RAID2 interfaces, and two ATA133 hard disks on the PRI\_RAID interface, you may set up RAID0, RAID1, RAID0+1, and Multi-RAID configurations. Use the MBFastTrak378™ BIOS and the FastBuild™ utility to configure a disk array.

**RAID 0** (called *data striping*) optimizes two identical hard disk drives to read and write data in parallel, interleaved stacks. Two hard disks perform the same work as a single drive but at a sustained data transfer rate, double that of a single disk alone, thus improving data access and storage.

**RAID 1** (called *data mirroring*) copies and maintains an identical image of data from one drive to a second drive. If one drive fails, the disk array management software directs all applications to the surviving drive as it contains a complete copy of the data in the other drive. This RAID configuration provides data protection and increases fault tolerance to the entire system.

**RAID 0+1** is *data striping* and *data mirroring* combined without parity (redundancy data) having to be calculated and written. The advantage of RAID 0 + 1 is fast data access (like RAID 0), but with the ability to lose one drive and have a complete duplicate surviving drive or set of drives (like RAID 1).



- 
1. If you use either Windows XP or Windows 2000 operating system (OS), copy first the **Promise FastTrak 378 Driver** from the support CD to a floppy disk before creating RAID configurations.
  2. Refer to the **FastTrak 378 Quick Start Guide** and **SATA Quick Start Guide** in the support CD for detailed information on RAID configurations under different operating systems.
-

## 5.4.1 Install the hard disks

The PDC20378 chipset supports Ultra ATA/133/100/66 hard disk drives. For optimal performance, install identical drives of the same model and capacity when creating a disk array.

- If you are creating a **RAID 0 (striping)** array for performance, use two new drives.
- If you are creating a **RAID 1 (mirroring)** array for protection, you can use two new drives or use an existing drive and a new drive (the new drive must be of the same size or larger than the existing drive).

Follow these steps to install the hard disks for RAID configuration.

1. Set the jumpers of each hard disk as Master/Slave.
2. Install the hard disks into the drive bays.
3. Connect the HDD cables. These connection options are available for creating a RAID 0 or RAID 1 array:
  - a) Connect two Parallel ATA HDDs to PRI\_RAID connector and one Serial ATA HDD to either one of the two Serial ATA connectors, using separate parallel ATA or serial ATA cables.
  - b) Connect one Serial ATA HDD to each Serial ATA connector, using separate serial ATA cables.
4. Connect the power cable to the power connector on each drive.
5. Boot the system and enter the BIOS Setup Utility.
6. Go to the **Advanced** menu in BIOS and set the appropriate IDE configuration settings.
7. Save your changes and Exit Setup.
8. Proceed to section 5.4.2 for the next procedure.



## 5.4.2 Enter the MBFastBuild™ utility

1. Boot the system.

If this is the first time you boot the system with the new hard disks installed and connected to the ATAIDE connectors on the motherboard, the MBFastTrak378™ BIOS displays the following:

```
MBFastTrak378 (tm) BIOS version 1.00
(c)2000-2005 Promise Technology, Inc. All Rights Reserved.

No Array defined...

Press <Ctrl-F> to enter FastBuild (tm) Utility
Or press <ESC> key to continue booting.
```

2. Press <Ctrl-F> simultaneously to display the FastBuild™ utility main menu.

```
FastBuild (tm) Utility 2.00 (c) 2002-2005 Promise Technology, Inc.
[ Main Menu ]

Auto Setup . . . . . [ 1 ]
View Drive Assignments . . . . [ 2 ]
Define Array . . . . . [ 3 ]
Delete Array . . . . . [ 4 ]
Rebuild Array. . . . . [ 5 ]

[ Keys Available ]

Press 1..5 to select Option [ESC] Exit
```

## 5.4.3 Creating a RAID 0 array (Performance)

1. In the FastBuild™ utility main menu, press “1” to select Auto Setup. The following screen appears.

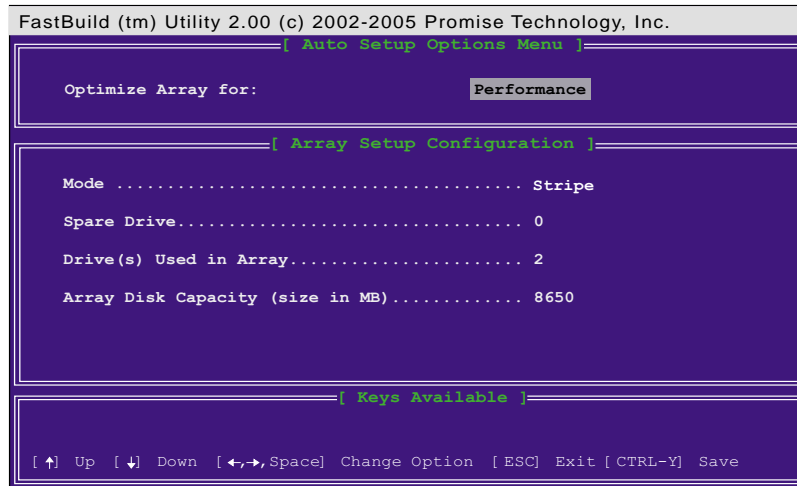

2. Use the arrow keys to go to the field **Optimize Array for** and select “Performance” with the space bar. The **Mode** field displays “Stripe”.
3. After making a selection, press <Ctrl-Y> to save and create a RAID 0 array.
4. Press any key to reboot the system. During the boot process, the MBFastTrak378 BIOS checks and displays the disk array information.



5. Once the array is created, use the FDISK utility to format the array as a single hard drive.
6. After you have formatted the arrayed drives, install an operating system (OS). The OS will treat the RAID 0 array as a single drive unit.
7. Install the RAID driver from the support CD that came with the motherboard package.



Depending on the operating system you are installing, you may need to install the RAID driver during or after the OS installation.

## 5.4.4 Creating a RAID 1 array (Security)

### Creating a Security Array with New Drives

1. In the FastBuild™ utility main menu, press “1” to select Auto Setup.

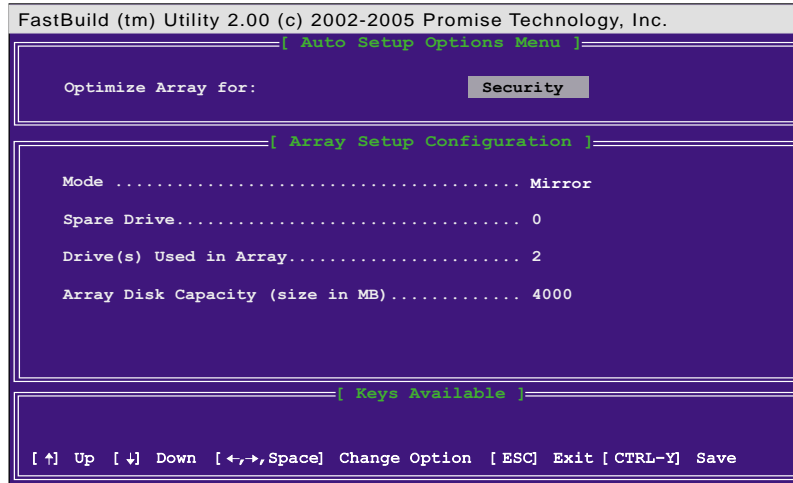

2. Use the arrow keys to go to the field **Optimize Array for** and select “*Security*” with the space bar. The **Mode** field displays “*Mirror*”.
3. Press <Ctrl-Y> to save your selection.
4. The following message appears:

```
Do you want the disk image to be duplicated to another? (Yes/No)
Y - Create and Duplicate
N - Create Only
```

5. Press **N** for the *Create Only* option. A message appears confirming that your Security array has been created.

```
Array has been created.
<Press any key to reboot>
```

6. Press any key to reboot the system. During the boot process, the MBFastTrak376 BIOS checks and displays the disk array information.



7. Use the FDISK utility and follow the format procedure for installing a new hard drive. After you have formatted the arrayed drives, install an operating system (OS).
8. Install the RAID driver from the support CD that came with the motherboard package.



---

Depending on the operating system you are installing, you may need to install the RAID driver during or after the OS installation.

---

## Creating a Security Array with Existing Data Drive

If you would like to use an existing drive that already contains data and/or is the bootable drive in your system, make sure that the new hard drive you will use in the array has the same or larger capacity as the existing drive.



---

Backup all important data before creating an array. Failure to do so may cause data loss.

---

1. In the FastBuild™ utility main menu, press “1” to select Auto Setup.
2. Use the arrow keys to go to the field **Optimize Array for** and select “*Security*” with the space bar. The **Mode** field displays “*Mirror*”.
3. Press <Ctrl-Y> to save your selection. The following message appears:

```
Do you want the disk image to be duplicated to another? (Yes/No)

Y - Create and Duplicate
N - Create Only
```

5. Press **Y** for the *Create and Duplicate* option. The next window prompts you to select the source drive to use.
6. Use the arrow keys to select the source drive. The FastBuild utility will copy all the data from the source drive to the target drive.
7. Press <Ctrl-Y> to save the selection and start the duplication. The following message appears:

```
Start to duplicate the image...
Do you want to continue? (Yes/No)

Y - Continue    N - Abort
```

8. Select **Y** to continue. Select **N** to return to the main menu.
9. When the duplication process is completed, a message appears confirming that your Security array has been created.
10. Press any key to reboot the system.
11. Install the RAID driver from the support CD that came with the motherboard package.



---

Depending on the operating system you are installing (or that is already installed), the RAID driver installation sequence may vary.

---

## 5.4.5 Other FastBuild Utility Commands

Command options 3-6 on the FastBuild™ Utility main menu are not required for setting up an array, but they are useful for reconfiguring an array.

**View Array (3):** This command allows you to view the drive assignments of hard disks in an array.

**Delete Array (4):** This command deletes an array to reconfigure the system. Deleting an array does not remove information on the hard disks. If an array is deleted by mistake, recover it immediately by redefining it as the deleted array.

**Rebuild Array (5):** This command restores the array and system data after faults on RAID 1 arrays.

Follow these steps to rebuild and restore data in the array:

1. On boot-up, an error message notifies of a system failure.
2. Press <**Ctrl-F**> to enter the FastBuild™ Main Menu.
3. Select <3> for View Array to verify the ID of the defunct hard disk.
4. Power off the system and replace the hard disk with an identical model.
5. Reboot and enter the FastBuild™ Main Menu again.
6. Select <5> for Rebuild Array. The malfunctioning array is highlighted. Press **Enter** to select.

```

FastBuild (tm) Utility 2.00 (c) 2002-2005 Promise Technology, Inc.
----- [ Rebuild Array Menu ] -----
  Array No   RAID Mode   Total Drv   Capacity   Status
-----
  Array 1    Mirror/Stripe  4           7999      Critical
  Array 2    -----
  Array 3    -----
  Array 4    -----

----- [ Keys Available ] -----
[ ↑ ] Up [ ↓ ] Down [ ESC ] Exit [ Enter ] Select

```

7. Select the replacement drive. Press <Enter>.

```

FastBuild (tm) Utility 2.00 (c) 2002-2005 Promise Technology, Inc.
----- [ View Array Definition Menu ] -----
  Array No   RAID Mode   Total Drv   Status
-----
  Array 1    Mirror/Stripe  4           Critical

  Stripe Block: Not Available           Gigabyte Boundary: ON

----- [ Select Drive for Rebuild ] -----
  Channel: ID      Drive Model      Capacity (MB)
-----
  3:Mas FUJITSU MPD3043AT      4325

----- [ Keys Available ] -----
[ ↑ ] Up [ ↓ ] Down [ ESC ] Exit [ Enter ] Select

```

8. Confirm the command to copy data from the intact source hard disk onto a new replacement hard disk. A progress gauge displays the copy progress for the duration of the task.
9. After the rebuild process is complete, the user is prompted to reboot the system.

**Controller Configuration (6):** This command shows the default for Controller Configuration. The default value is [Enabled].

## 5.5 Intel® RAID for Serial ATA

The Intel® ICH5R chipset supports Redundant Array of Independent Disks (RAID) configuration. Using two Serial ATA hard disks on SATA1 and SATA2 connectors onboard, you may set up a RAID 0 level storage configuration.

**RAID 0** (called *data striping*) optimizes two identical hard disk drives to read and write data in parallel, interleaved stacks. Two hard disks perform the same work as a single drive but at a sustained data transfer rate, double that of a single disk alone, thus improving data access and storage.

### 5.5.1 BIOS configuration

Follow these steps to set the BIOS items related to the RAID function.

1. Enter the BIOS Setup utility by pressing <Delete> during the Power-On Self Test (POST). See section “4.2 BIOS Setup program” for more information on entering the Setup utility.
2. From the Main menu, select IDE Configuration to display the sub-menu items.
3. Set the IDE Configuration items as follows:

Onboard IDE Operate Mode	[Enhanced Mode]
Enhanced Mode Support On	[S-ATA]
Configure S-ATA as RAID	[Yes]
Serial ATA BOOTROM	[Enabled]



When creating a RAID, make sure that the item **Configure S-ATA as RAID** is set to **Yes**, and the item **Serial ATA BOOTROM** enabled, to load the Intel RAID Option ROM upon boot up. The Intel RAID Option ROM provides the pre-operating system user interface for the Intel RAID implementation.

4. Press <F10> to save your changes and exit the Setup utility.



For more information on the Intel RAID for Serial ATA, refer to the Intel Application Accelerator (RAID Edition) User's Manual in the motherboard support CD. See path **\\Manual\IAA RAID Manual.doc**.

## 5.5.2 Installing Serial ATA hard disks



1. A Serial ATA hard disk requires SATA data (4-conductor) and power cables. Make sure that you have the appropriate SATA cables before you proceed with the installation.
2. Carefully follow other hard disk installation instructions that came with the Serial ATA hard disks.

Follow these steps to install a Serial ATA hard disk.

1. Install the hard disk into the drive bay.
2. Connect one end of the SATA data cable to an SATA connector on the motherboard, then connect the other end to the hard disk.
3. Connect a 4-pin power cable to the power connector on the hard disk.

## 5.5.3 Creating, Deleting, and Resetting RAID Sets

Use the Intel® Integrated RAID for Serial ATA - RAID Configuration Utility to configure your Serial ATA hard disks as RAID. Launch the utility by pressing <Ctrl-I> when the message “**Press <Ctrl-I> to enter RAID Configuration Utility**” appears during the Power-On Self Test (POST).

Pressing <Ctrl-I> displays the Main Menu of the RAID Configuration utility.

```
Intel(R) Integrated RAID for Serial ATA - RAID Configuration Utility
Copyright(C) 2003 Intel Corporation. All Rights Reserved. v3.x.x.xxxx

[ MAIN MENU ]

1. Create RAID Volume
2. Delete RAID Volume
3. Reset Disks to Non-RAID
4. Exit

[ DISK/VOLUME INFORMATION ]

RAID Volumes:
None defined.

Non-RAID Disks:
Port Drive Model          Serial #          Size           Status          Bootable
0 ST320413A               xxxxxxxx         18.6GB        Normal          Yes
1 ST320413A               xxxxxxxx         18.6GB        Normal          Yes

[ ↓↑ ] -Select      [ ESC ] Exit      [ Enter ] -Select Menu
```



## 5.5.4 Creating a RAID Volume

To create a RAID 0 volume:

1. Select the option **1. Create RAID Volume** from the Main menu, then press <Enter>. The Create Array menu appears.

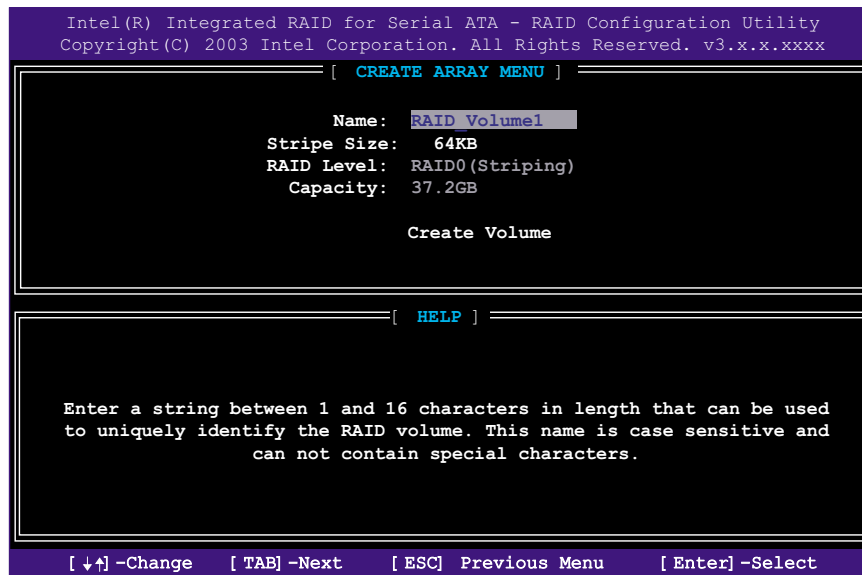

2. Type a name for your RAID volume using 1 to 16 characters (letters and/or numbers, no special characters). Press <Enter>.
3. Use the Up and Down arrow keys to select the stripe size for the RAID 0 array. Press <Enter> to make the selection.  
The available values range from 8 KB to 128 KB. The default is 64 KB. Select a stripe value from the following suggestions depending on your planned drive usage.
  - 16 KB - low disk usage
  - 64 KB - typical disk usage
  - 128 KB - performance disk usage
4. Highlight **Create Volume** then press <Enter> to create the array. Press **Y** when a confirmation message appears.

```
Are you sure you want to create this volume (Y/N)
```

5. Scroll down to option **4. Exit** and press <Enter> to exit the RAID configuration utility. Press **Y** when a confirmation message appears.

## 5.5.5 Deleting a RAID Volume



Take caution when deleting a RAID volume. Deleting a RAID volume erases all data on the RAID drives!

```
Intel(R) Integrated RAID for Serial ATA - RAID Configuration Utility
Copyright(C) 2003 Intel Corporation. All Rights Reserved. v3.x.x.xxxx

[ DELETE ARRAY MENU ]

Name          Level          Drives    Capacity  Status    Bootable
RAID_Volume1  RAID0(Stripe)  2         37.2GB   Normal    Yes

[ HELP ]

Deleting a volume will destroy the volume data on the drive(s) and
cause any member disks to become available as non-RAID disks.

WARNING: EXISTING DATA WITHING THIS VOLUME WILL BE LOST AND NON-RECOVERABLE

[ ↑↓ ]-Change  [ TAB ]-Next  [ <ESC> ]-Previous Menu  [ <DEL> ]-Delete Volume
```

To delete a RAID volume:

1. Select the option **2. Delete RAID Volume** and press <Enter> to delete the RAID volume.
2. When a confirmation message appears, press **Y** to permanently delete the RAID volume.

```
[ VOLUME DELETE VERIFICATION ]

Are you sure you want to delete this volume?
ALL DATA IN THE VOLUME WILL BE LOST!!

Are you sure you want to delete volume "RAID_Volume1"? (Y/N)
```

## 5.5.6 Resetting a RAID to non-RAID



Take caution when resetting a RAID to non-RAID. Resetting all RAID data will remove any internal RAID structures from all RAID disks!

```
Intel(R) Integrated RAID for Serial ATA - RAID Configuration Utility
Copyright(C) 2003 Intel Corporation. All Rights Reserved. v3.x.x.xxxx

[ MAIN MENU ]

1. Create RAID Volume
2. Delete RAID Volume
3. Reset Disks to Non-RaID
4. Exit

[ DISK/VOLUME INFORMATION ]

RAID Volumes:
None defined.

Non-RAID Disks:
Port Drive Model      Serial #      Size      Status      Bootable
0 ST320413A           xxxxxxxx     18.6GB    Normal      Yes
1 ST320413A           xxxxxxxx     18.6GB    Normal      Yes

[ ↓↑ ] -Select      [ ESC ] Exit      [ Enter ] -Select Menu
```

To reset a RAID to non-RAID structure:

1. Select the option **3. Reset Disks to Non-RAID** and press <Enter>.
2. When a confirmation message appears, press **Y** to revert to non-RAID hard disk structure.

```
[ RESET ALL DATA RAID DATA ]

Resetting all RAID data will remove any internal RAID structures
from all RAID disks, including disks with working volumes. These
structures are used to maintain the RAID volumes. By removing
these structures, the drive will revert back to a Non-RAID disk
that can then be used or reallocated to a new RAID volume.

WARNING: Selecting "Yes" will cause all data on any RAID disk
(RAID Volume or Other RAID Disk) to be lost.

Are you sure you want to destroy all RAID data (Y/N):
```



# QUICK REFERENCE CARD

## P4C800-E

ASUS Motherboard

Refer to the Quick Setup Guide when installing components or devices for the items indicated in this reference card.

