

**TS-AWE3
TS-AWH3
USER'S MANUAL
Intel® Socket 370 Celeron™ /
Pentium® III FC-PGA Series**

Transcend

*Your Supplier, Your Partner,
Your Friend.*

TS-AWH3 / TS-AWE3 Motherboard

Supporting Intel® Pentium® III / Celeron™ Series Processor
66/100/133MHz Front Side Bus

Intel® 810-DC100 / 810E Chipset

Welcome !!

Congratulations on your purchase of this great value motherboard, with its range of special features and innovative onboard functions, built around the advanced architecture of the new Intel® 810-DC100 / 810E Chipset. More details to follow later in this manual.

Our Website

Please come and visit us at our website on <http://www.transcendusa.com/> You'll find plenty of interesting information about this and many other quality Transcend products.

Your User's Manual

This User's Manual is designed to help end users and system manufacturers to set up and install the motherboard. All of the information within has been carefully checked for accuracy. However, Transcend Information, Inc. (hereafter referred to as "Transcend") carries no responsibility or liability for any errors or inaccuracies which this manual may contain. This includes references to products and software. In addition, the information and specifications are subject to change without prior notice.

Disclaimer

Transcend provides this manual "as is" without any warranty of any kind, either expressed or implied, including – but not limited to – the implied warranties, conditions of merchantability or fitness for a particular purpose. Transcend, its management, employees, distributors and agents are in no way liable for any indirect special, incidental or consequential damages, including loss of profits, loss of business and the like. This is even if Transcend has been advised of the possibility of such damages arising from any defect or error in this manual or product.

Trademarks

All brands, product names and trademarks mentioned in this document are the property of their respective owners or companies and are used solely for identification or explanation. It is Transcend policy to respect all product rights.

Copyright

This manual may not, in whole or in part, be photocopied, reproduced, transcribed, translated or transmitted, in whatever form or language, without the written consent of the manufacturer, except for copies retained by the purchaser for personal archiving purposes.

Manual Version: 1.00

Release Date: April 2000

Copyright © 2000 Transcend Information, Inc.

Table of Contents

CHAPTER 1 INTRODUCTION	1
1.1 Essential Handling Precautions.....	1
1.2 Package Contents.....	2
1.3 Specifications and Features.....	2
CHAPTER 2 HARDWARE INSTALLATION	5
2.1 Transcend's TS-AWH3/TS-AWE3 Motherboard.....	5
2.2 Layout of Transcend's TS-AWH3/TS-AWE3 Motherboard.....	6
2.3 66/100/133MHz System configuration.....	7
2.4 Memory Configuration.....	8
2.5 Keyboard Wake Up.....	9
2.6 Primary / Secondary IDE Connectors.....	10
2.7 Floppy Disk Drive Connector.....	11
2.8 Fan Power Connectors.....	12
2.9 Wake-on-LAN Connector.....	13
2.10 IrDA-Compliant Infrared Module Connector.....	14
2.11 Panel Connectors.....	15
2.12 Power Connector.....	17
2.13 External Back Panel I/O Ports.....	18
2.14 Using Jumper JPS to clear CMOS.....	19
2.15 FWH Lock Jumper.....	20
2.16 Onboard Audio Setting.....	21
2.17 Internal Audio Connector.....	22
2.18 Internal Serial Port Connector COMB	23

CHAPTER 3 BIOS SETUP	24
3.1 BIOS Setup	24
3.2 The Main Menu	24
3.3 Standard CMOS Features.....	26
3.4 Advanced BIOS Features.....	29
3.5 Advanced Chipset Features	32
3.6 Integrated Peripherals	34
3.7 Power Management Setup.....	38
3.8 PnP/PCI Configuration Setup.....	41
3.9 PC Health Status	43
3.10 Frequency/Voltage Control.....	44
3.11 Load Fail-Safe Default.....	45
3.12 Load Optimized Defaults.....	45
3.13 Supervisor Password.....	46
3.14 User Password.....	47
3.15 Save & Exit Setup.....	47
3.16 Exit Without Saving	48
CHAPTER 4 SOFTWARE SETUP	49
4.1 INF Update for 810 Chipset	49
4.2 VGA Driver Setup.....	50
4.3 Intel Security Controller Driver.....	51
4.4 Audio Driver Setup.....	52
CHAPTER 5 BIOS UPGRADE	57
5.1 How to Check Your BIOS File Name and Version	57
5.2 How to Download Correct BIOS File from Web.....	57
5.3 How to Update Your Motherboard BIOS	58

CHAPTER 1 INTRODUCTION

1.1 Essential Handling Precautions

IMPORTANT. Read this page before unpacking your motherboard!

- **Power Supply**

Be careful! Always ensure that the computer is disconnected from the power supply when working on the motherboard and its components.

- **Static Electricity**

Static electricity may cause damage to the delicate integrated circuit chips on your motherboard. Before handling the motherboard outside of its protective packaging, ensure that there is no static electric charge in your body. To avoid this risk, please observe these simple precautions while handling the motherboard and other computer components:

1. If possible, wear an anti-static wrist strap. This fits around your wrist and is connected to a natural earth ground.
2. Touch a grounded or anti-static surface, or a metal fixture such as a pipe or the chassis of your system, before touching the motherboard.
3. When you have removed the motherboard from its anti-static packaging, try to hold it only by the edges, without touching any components.
4. Avoid contacting the components on add-on cards, motherboards, and modules with the golden fingers (gold-colored connectors) which plug into the expansion slots.
5. It is safest to handle system components only by their mounting brackets.
6. Keep components which are not connected to the system in the anti-static packaging whenever possible.

These precautions help to reduce the risk of static build-up and ensure any static discharge is harmless to your equipment.

- **Battery Replacement**

The battery which holds the system settings memory on your motherboard should not require replacement for at least five years, and probably much longer. In picture 2.2, it is located near the bottom right hand corner.

Please replace your battery only with the same type, or a similar type recommended by the manufacturer. If the battery is replaced incorrectly, there is a risk of a short circuit or explosion. Used batteries should be disposed of according to the manufacturer's instructions.

• **Electric Screwdrivers**

To reduce the risk of damage to the motherboard due to excessive torque, avoid setting electric screwdrivers above 7.5 kg/cm.

1.2 Package Contents

This motherboard package should contain the following items. Please check them as soon as you unpack. If you find any damaged or missing items, please contact your retailer.

- TS-AWH3/TS-AWE3 motherboard
- 1 X CD-ROM
- 1 X FDD cable
- User's Manual
- COM port cable x 1
- Ultra DMA / 66 cable x 1

1.3 Specifications and Features

• **CPU**

- Supports Intel® Pentium III / Celeron™ Series

• **Chipset**

- TS-AWH3 : Intel® 810-DC100 Chipset (GMCH, ICH); FSB:66/100 MHz
- TS-AWE3 : Intel® 810E Chipset (GMCHE, ICH); FSB: 66/100/133 MHz

• **Display Cache Memory**

- 4MB Display Cache SDRAM

• **DRAM Memory**

- Supports Synchronous DRAM
 - 3 X 168-pin DIMM module sockets on board
 - 8~512MB memory size
 - 8/16/32/64/128/256MB SDRAM DIMM
 - 64 data bits structure only
-

- **I/O Bus Slot**

- 5 X Master / Slave PCI Bus slots (PCI 2.2 compliant)
- 1 X AMR (Audio/MODEM Riser) slot

- **Award BIOS**

- Supports PC99, Plug-and-Play
- Supports ACPI, APM, DMI, Green Feature

- **I/O Functions**

- Support PIO Mode 3,4 ATAPI devices and Ultra DMA/33/66
- Supports 2 high speed UART 16550 COM ports
- Supports SPP/EPP/ECP LPT port
- Supports 3 mode/1.44/2.88MB floppy drive
- Supports PS/2 Mouse and PS/2 Keyboard
- Supports IrDA port
- Supports 2 USB (Universal Serial Bus) ports
- Supports VGA port
- Supports Line-out, Line-in and MIC-in jack
- Supports Game/MIDI port

- **Switching Voltage Regulator**

- Intel VRM 8.4 compliant

- **Other Features**

- Year 2000 compliant
 - Power failure resume
 - FWH (Firmware Hub) supports security manageability
 - BIOS Virus protection (warning)
 - PS/2 Mouse and Keyboard Wake Up
 - Support Wake-on-LAN function
 - Remote Ring Wake Up
 - Time Wake Up
 - Board voltage monitors for CPU core, +3.3V, +/-5.0V, +/-12.0V, VTT and VBAT
 - CPU overheat alarm
 - CPU fan auto-off in sleep mode
-

- **PCB Dimensions**

- ATX form factor, 4-layer PCB, 20.4cm x 30.5cm (8 inch x 12 inch)



CHAPTER 2 HARDWARE INSTALLATION

2.1 Transcend's TS-AWE3/TS-AWH3 Motherboard

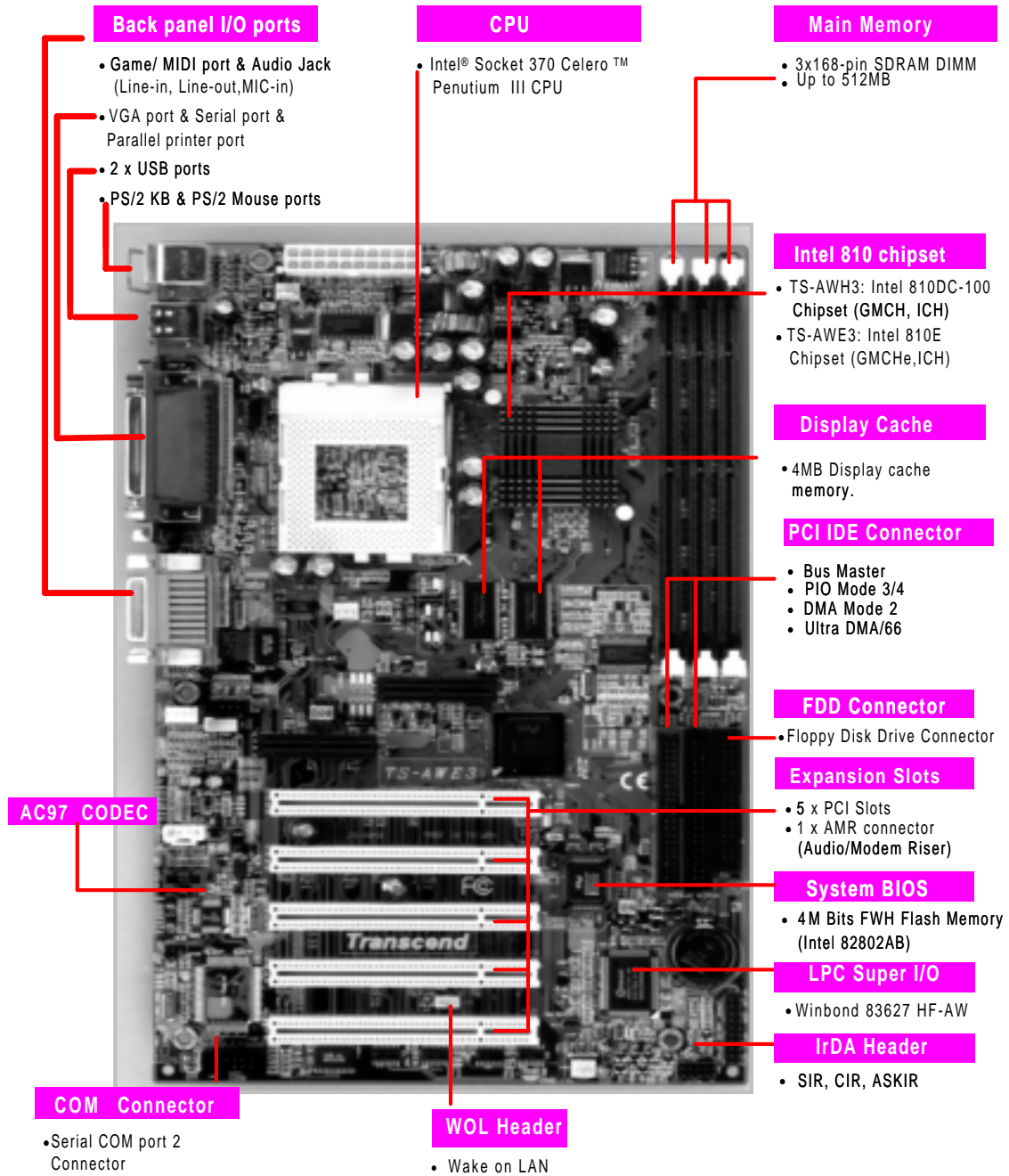

HARDWARE INSTALLATION

2.2 Layout of Transcend's TS-AWE3/TS-AWH3 Motherboard

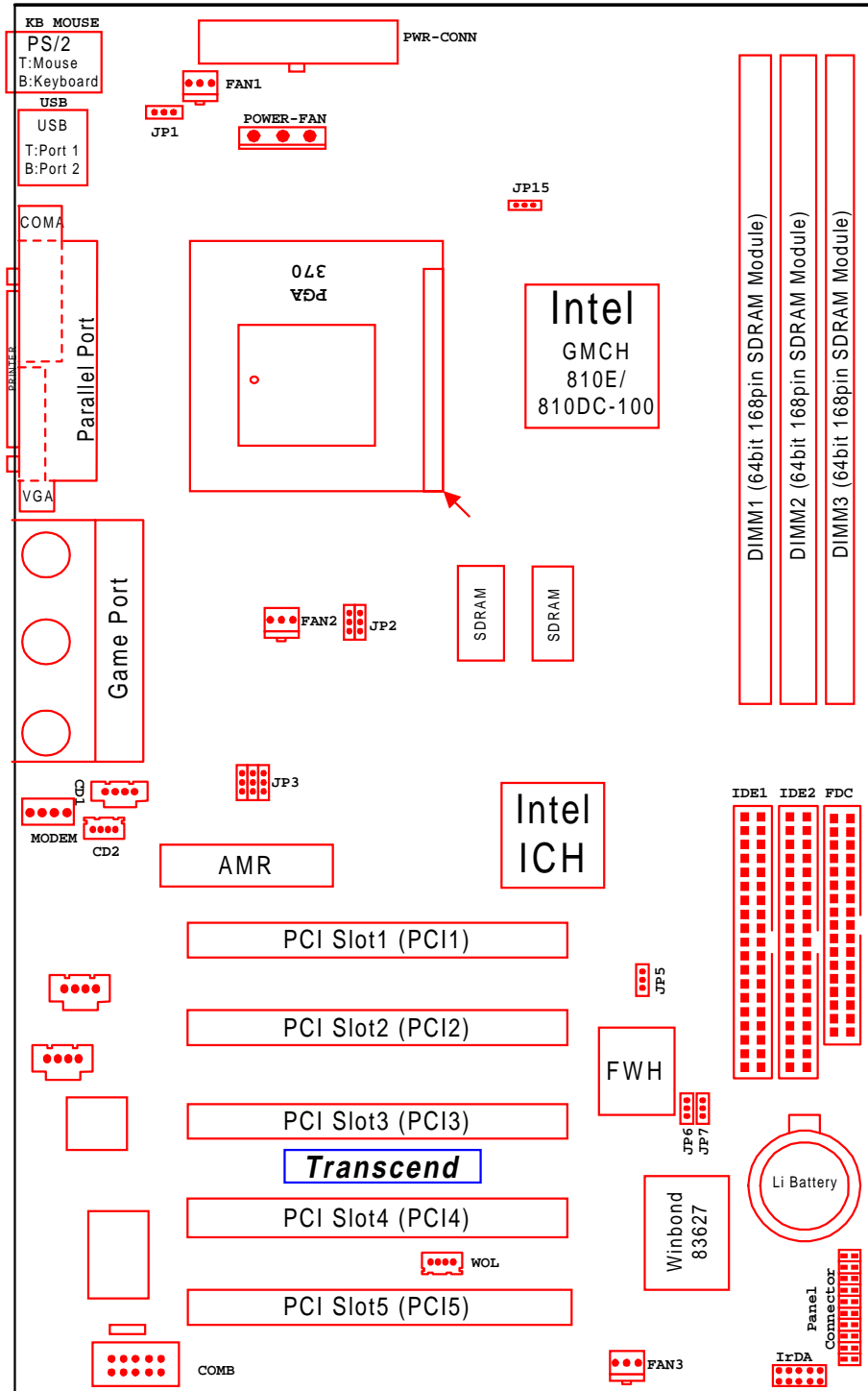

2.3 66/100/133 MHz System Configuration

The JP2 Jumper allows you to set the FSB (Front Side Bus) to either 66/100/133MHz configuration. When you set the FSB to 66MHz, you can select a system bus frequency from 66MHz to 75MHz through “CPU Host/PCI Clock” of “Frequency/Voltage Control” in the BIOS Setup menu (please refer to page 44). When you set the FSB to 100MHz, you can select a system bus frequency from 100MHz to 124MHz through “CPU Host/PCI Clock” of “Frequency/Voltage Control” in the BIOS Setup menu (please refer to page 44). When you set the FSB to 133MHz, you can select a system bus frequency from 133MHz to 150MHz through “CPU HOST / PCI Clock” of “Frequency / Voltage Control” in the BIOS Setup menu (please refer to page 44).

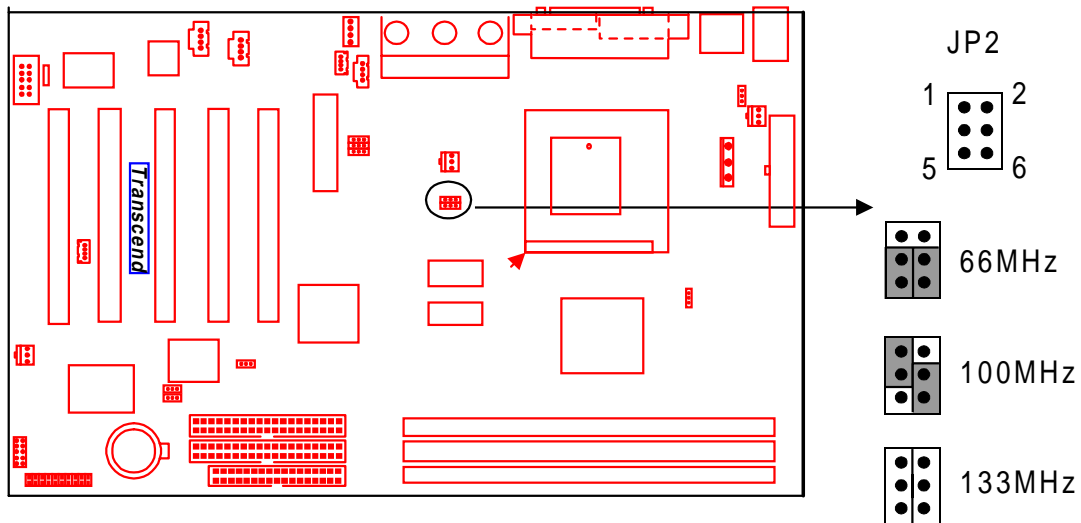

66/100/133MHz FSB Configuration Jumper

2.4 Memory Configuration

This motherboard must be installed with PC100 / PC133 SDRAM DIMM. If you install one DIMM, place it in the DIMM1 slot. If you install two DIMMs, place them in slots DIMM1 and DIMM2. If you install three DIMMs, you can only install **single sided DIMMs** onto the DIMM2 and DIMM3 slots, not double-sided DIMMs. Install memory in any combination as follows:

Number of Memory modules	DIMM1	DIMM2	DIMM3
1	Double-Sided / Single-Sided	Do not install any DIMM	Do not install any DIMM
2	Double-Sided / Single-Sided	Double-Sided / Single-Sided	Do not install any DIMM
3	Double-Sided / Single-Sided	Single-Sided	Single-Sided

NOTE: This motherboard supports memory module with 8/16/32/64/128/256MB. If you have more than one RAM module, you should install them from DIMM1 to DIMM3 in order.

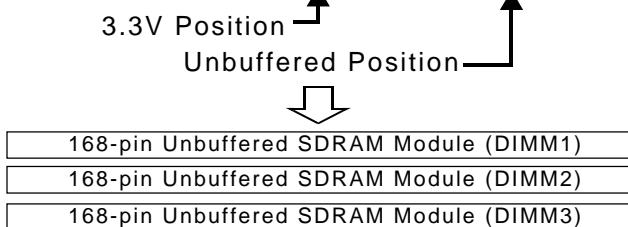
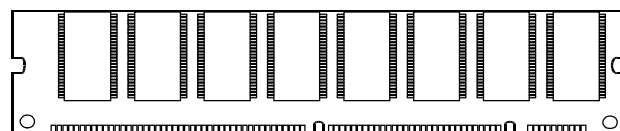
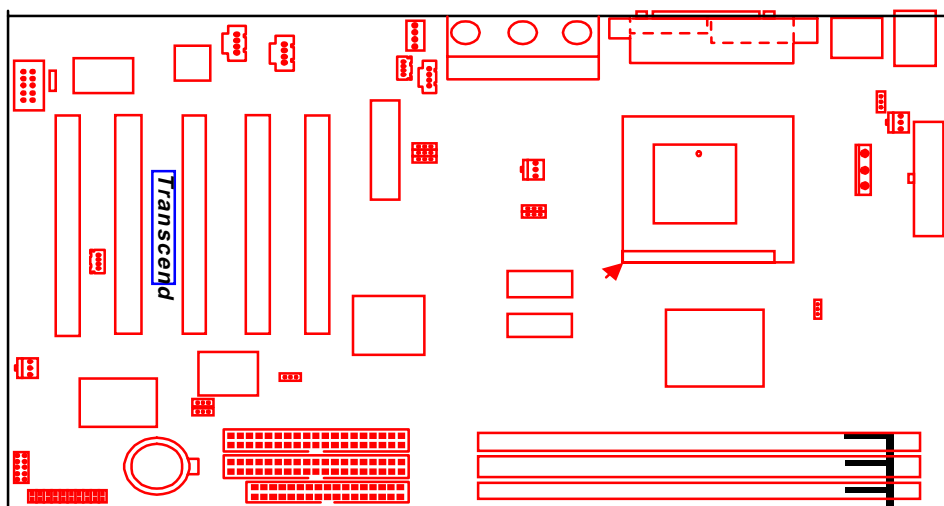

168Pin Memory DIMM Sockets

2.5 Keyboard Wake Up (3-pin KB-AWK)

This function makes the Keyboard Power Up the system. Set this jumper to “Enable” if you’d like your Keyboard to Power Up your computer. Then, go to the “Power On Function” in the “Integrated Peripherals” (please refer to page 35~36), and choose the setting you prefer.

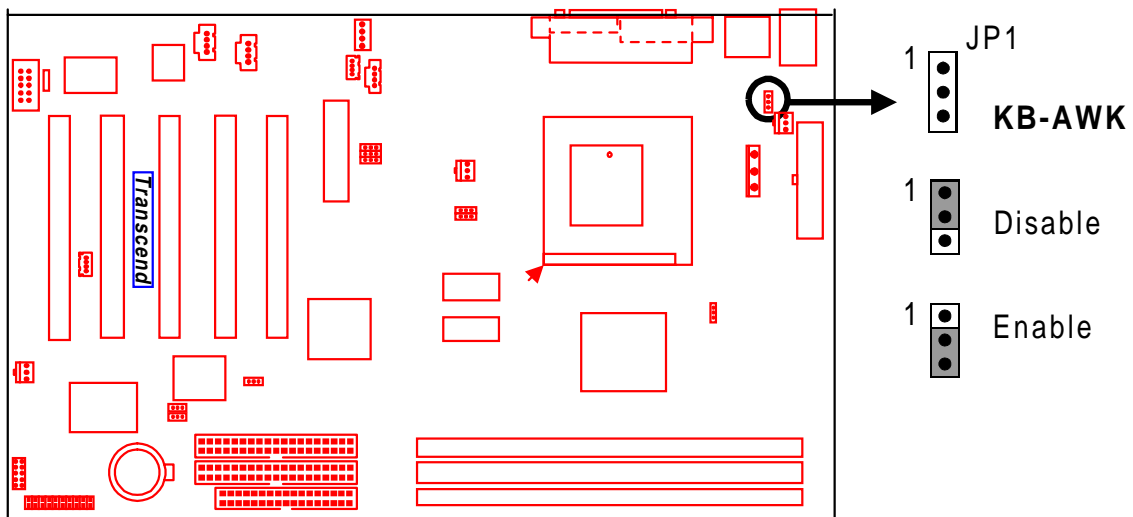

Keyboard Wake Up

2.6 Primary / Secondary IDE Connectors (Two 40-pin IDE)

This motherboard supports two 40-pin IDE connectors marked as IDE1 (primary channel) and IDE2 (secondary channel). Each channel supports two IDE devices, making a total of four devices.

Connect your Hard Disk (the main one if you are using more than one) to the “Master” connector (at the end of the cable) and connect it to IDE1 (see important note below). If your HDD supports Ultra DMA/66, you must use an 80-wire cable, otherwise the HDD won’t be able to reach this speed.

If you intend to operate two IDE devices from the same channel, one device must be set to “Master” mode, the other to “Slave” mode. A Hard Disk, CD ROM or other IDE device can have either setting, depending on device’s jumper. Please refer to the device’s manual for more information.

NOTE: The Connectors must be attached to the IDE channels the right way round. Make sure that the red stripe on one edge of the ribbon cable (this may be faint and could also be a dotted line) is the nearest to PIN 1 (on the left as the motherboard is shown in the picture below).

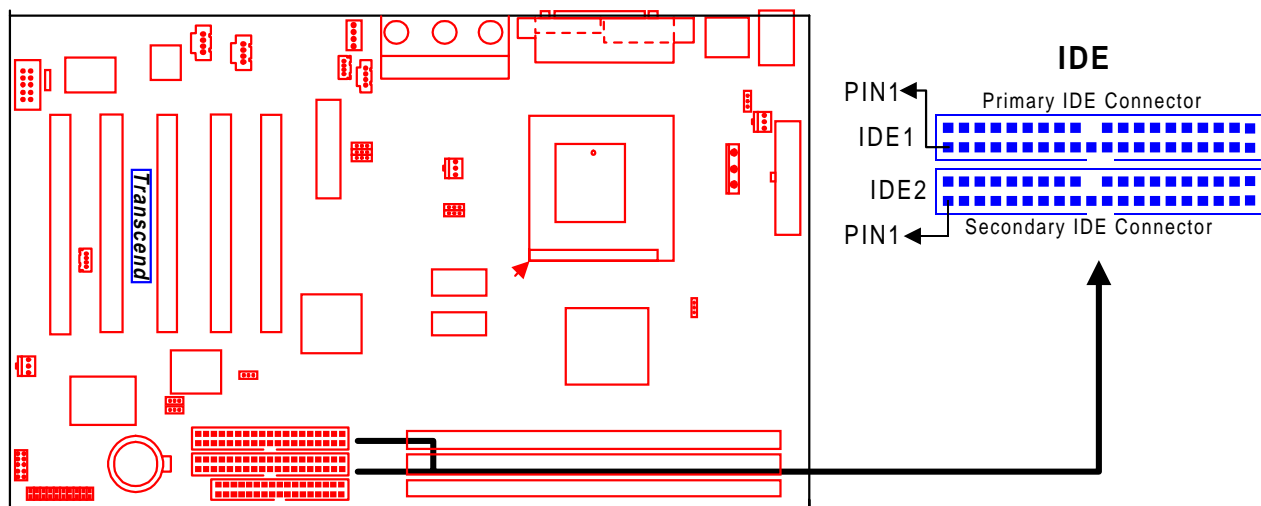

IDE Connectors

2.7 Floppy Disk Drive Connector (34-pin FDC)

This connector supports the floppy disk drive ribbon cable which is one of the items in your motherboard package. After connecting the single end to the board, connect the two plugs at the other end to the floppy drives. Remember, as in the last section, the red stripe on the edge of the ribbon cable must be the nearest to PIN 1, otherwise your connection won't work. This means it must be on the left as the motherboard is shown below.

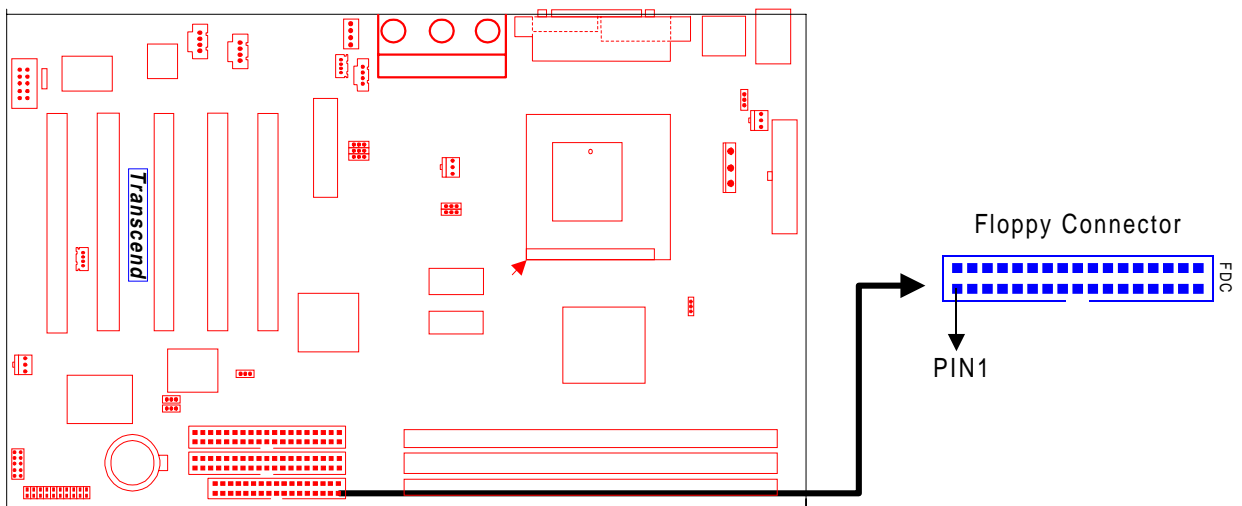

Floppy Disk Drive Connector

2.8 Fan Power Connectors

There are three fan power connectors on the motherboard: CPU-FAN, POWER-FAN, and CASE-FAN. Each connector provides +12V power. The cables can only be attached a certain way: If you try to put them in the wrong way, they won't fit. These connectors support cooling fans of 500 mA (6W) or less.

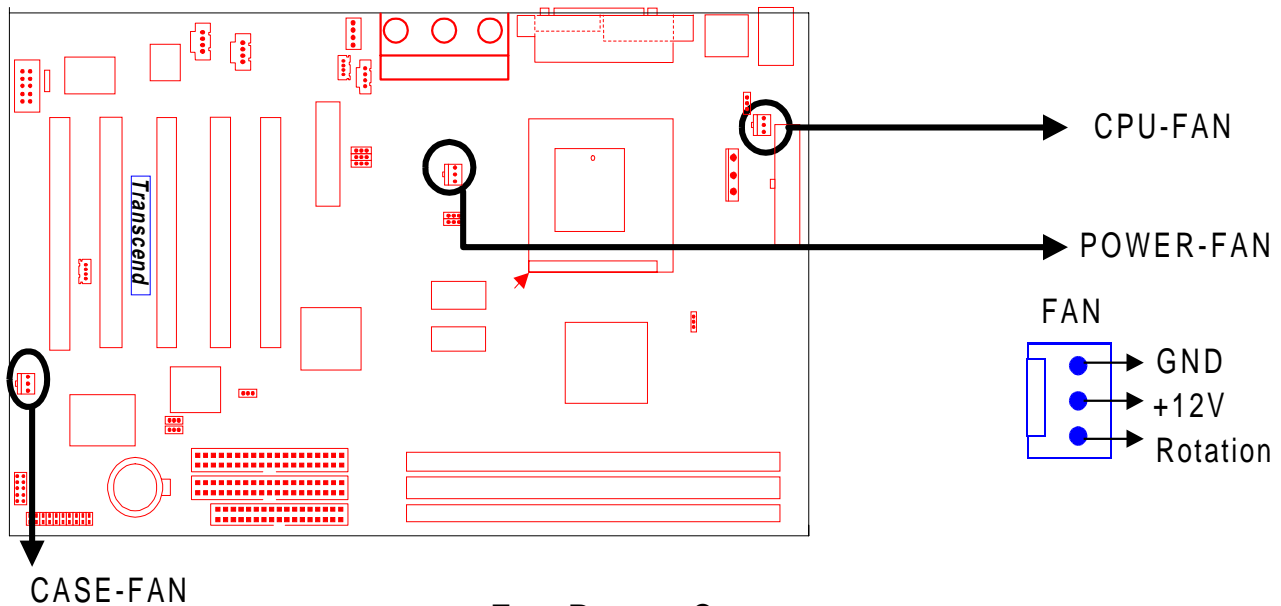

2.9 Wake-on-LAN Connector (3-pin WOL)

This connector connects to LAN cards with a Wake-on-LAN output. The system can be Powered Up when a wakeup packet or signal is received from the LAN card.

NOTE:This function requires that the “Wake-Up by PCI & WOL” function in the “Power Management Setup” is set to “Enabled” and that your system has an ATX power supply with at least 720mA +5V standby power.

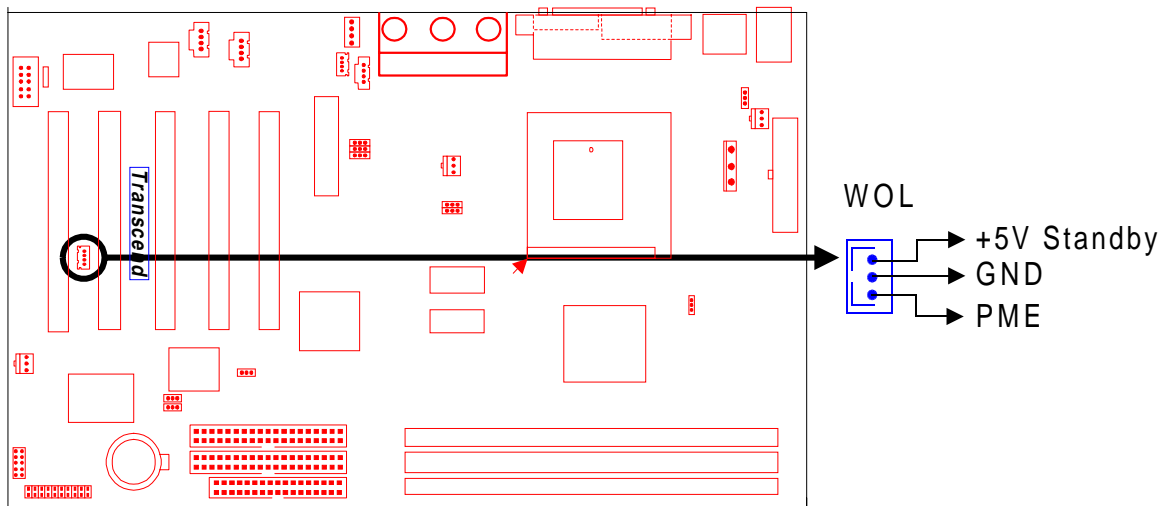

Wake-on-LAN Connector

2.10 IrDA-Compliant Infrared Module Connector (10-pin IrDA)

The IrDA connector can be configured to support a wireless infrared module. With this module and application software such as Laplink or Win95 Direct Cable Connection, users can transfer files to or from laptops (notebooks), PDAs and printers. You must also configure the setting through “UART Mode Select” in the “Integrated Peripherals” (please refer to page 34) to select “IrDA”. Connect the Standard IR (SIR) device to the onboard SIR connector according to the pin definitions. An optional Consumer Infrared (CIR) set connects to the CIR and SIR connectors simultaneously for both wireless transmitting and remote control functions through one external infrared module.

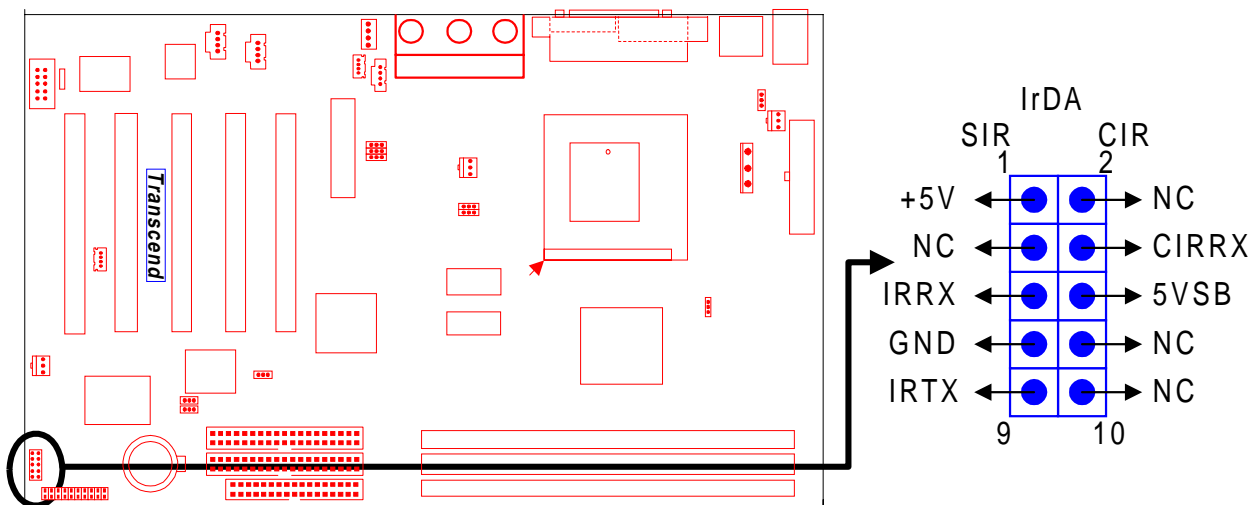

IrDA Connector

2.11 Panel Connectors

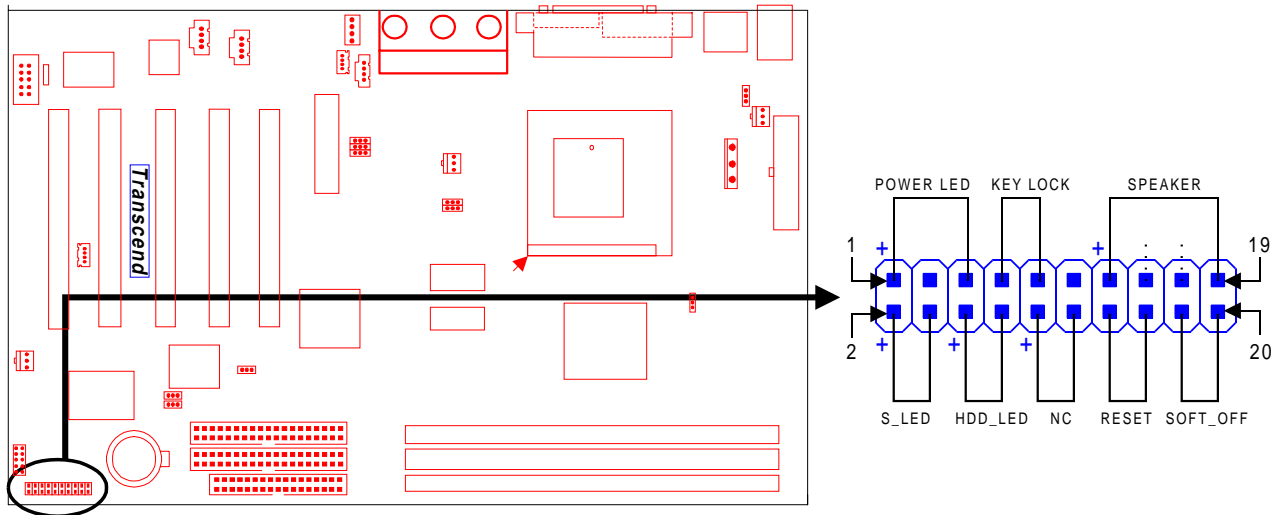

Panel Connector

Power LED Lead (3-pin POWER LED)

This 3-pin connector attaches to the power LED.

Pin1 : +5V

Pin3 : NC

Pin5 : GND

Keylock Lead (2-pin KEYLOCK)

Use the keylock to enable or disable the Keyboard.

Pin7 : KEYLOCK

Pin9 : GND

Speaker Lead (4-pin SPEAKER)

This 4-pin connector connects to the case-mounted speaker.

Pin13 : +5V

Pin15 : GND

Pin17 : NC

Pin19 : SPK

Suspend Mode LED Lead (2-pin S_LED)

The S_LED will light when the suspend mode works.

Pin2 : +5V

Pin4 : GND

Hard disk LED Lead (2-pin HDD_LED)

This 2-pin connector connects to the LED of the hard disk. The LED lights up when a HDD is active.

Pin6 : +5V

Pin8 : GND

Reset Switch Lead (2-pin RESET)

This 2-pin connector connects to the case-mounted reset switch for rebooting your computer without turning on your power switch.

Pin14 & Pin16

Software Power-Off Lead (2-pin SOFT_OFF)

Attach the SOFT_OFF switch of the panel to this connector. Use the switch to Power On/Off your system.

Pin18 & Pin20

2.12 Power Connector (20-pin PWR-CONN)

Make sure you plug the ATX power supply connector in the right direction. The pin definition is shown below. **Make sure that your ATX power supply can support at least 720mA +5V standby power for the Advanced Configuration and Power Interface (ACPI) functions.**

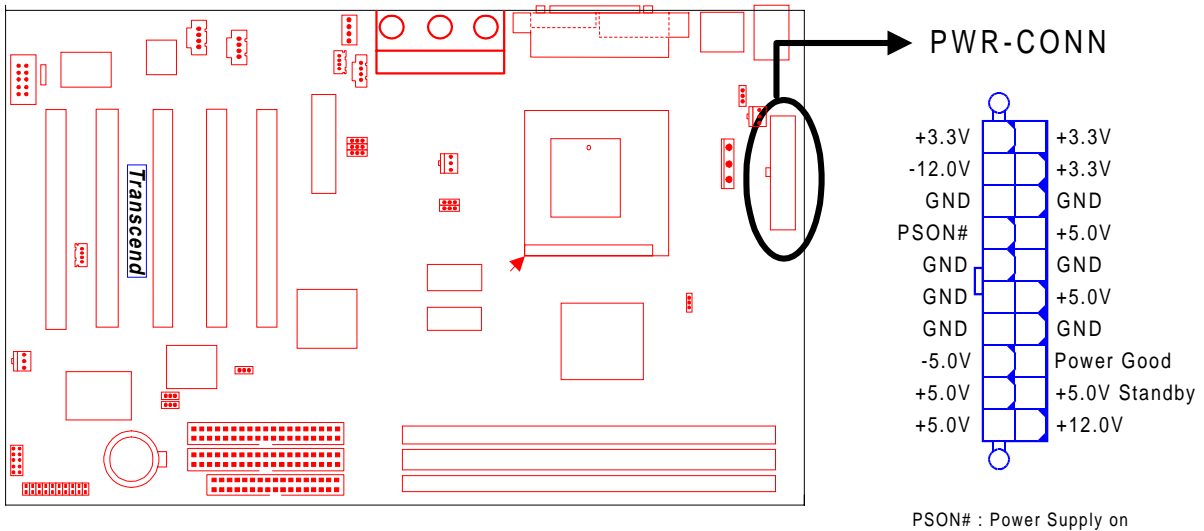

Power Connector

2.13 External Back Panel I/O Ports

There are 10 kinds of external connectors on the back panel of the motherboard.

The view angle of drawing shown here is from the back panel of the housing.

1. PS/2 Mouse Port (Green 6-pin MOUSE)

The onboard PS/2 Mouse port is a 6-pin Mini-Din connector marked "MOUSE".

2. PS/2 Keyboard Port (Purple 6-pin KB)

The onboard PS/2 Keyboard port is a 6-pin Mini-Din connector marked "KB".

3. USB (Universal Serial Bus) Ports 1 & 2 (Black two 4-pin USBs)

You can plug any USB device into the USB ports. The motherboard contains two USB ports, which are marked "USB".

4. Parallel Port (Burgundy 25-pin PRN)

The onboard printer port is a 25-pin D-type connector marked "PRN".

5. Serial Port COMA (Turquoise 9-pin COMA)

The first onboard serial port is a 9-pin D-type connector marked "COMA". (The second onboard serial port COMB is a 10-pin header connector. Please refer to page 26 for the location and details).

6. Display VGA Port (Blue 15-pin VGA)

The onboard VGA port is a 15-pin D-type connector marked "VGA".

7. Game Port / MIDI Port (Gold 15-pin GAME)

The onboard Game port / MIDI Port is a 15-pin D-type connector marked "GAME".

8. Line_out (Lime Green 1/8" LINE_OUT)

The onboard Line_out connector is a 1/8" stereo audio jack marked "LINE_OUT".

9. Line_in (Light blue 1/8" LINE_IN)

The onboard Line_in connector is a 1/8" stereo audio jack marked "LINE_IN".

10. MIC_in (Pink 1/8" MIC)

The onboard MIC_in connector is a 1/8" stereo audio jack connector marked "MIC".

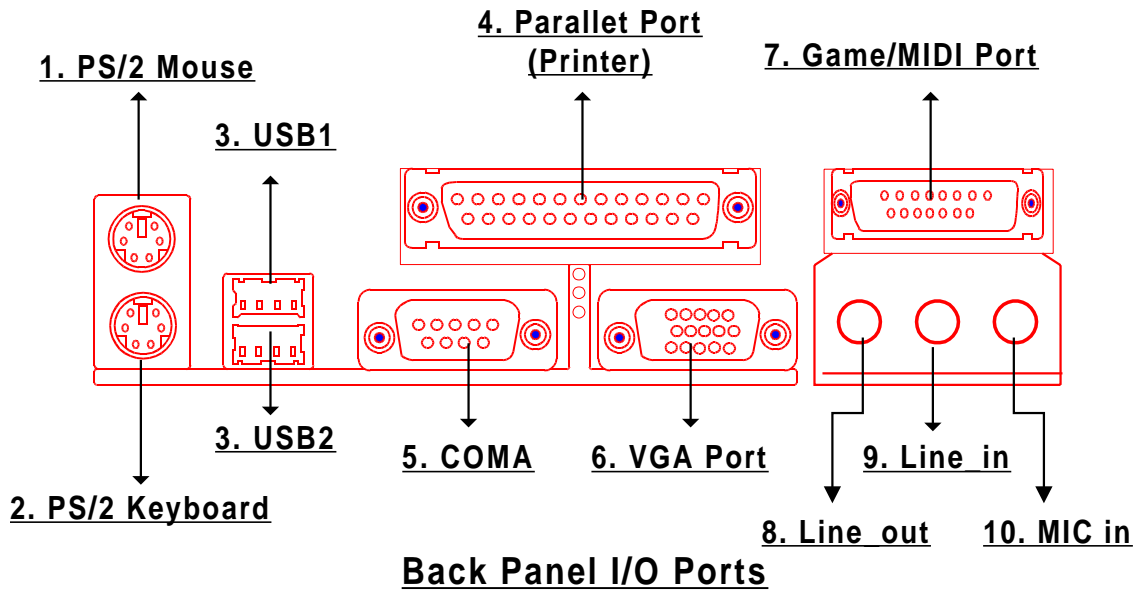

2.14 Using Jumper JPS to clear CMOS

To clear the CMOS data, you should turn off your computer's power and short pin1 and pin2 in JP5.

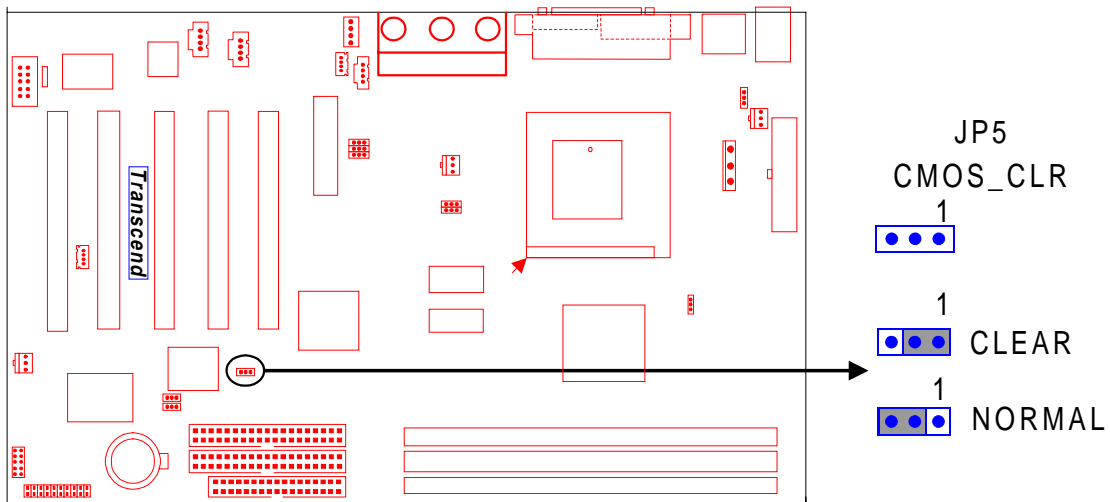

Clear CMOS Jumper

2.15 FWH Lock Jumper (JP6)

This jumper controls the Firmware Hub (FWH) lock-function. When set to “LOCK”, it prevents programming or block erase to the top block of FWH. There are 8 blocks of addressable space controlled by the FWH. The top block (block 7, also called “Boot Block”) stores some critical codes. To guard against accidents (such as a virus, program bug etc.), we recommend that you lock this block. Even if other blocks were erased, you could still recover your system easily by following the 2 steps below:

1. Reboot with a DOS (95/98) system boot floppy disk.
2. Reflash BIOS according to section 5.3, Step 5 (Page 58).

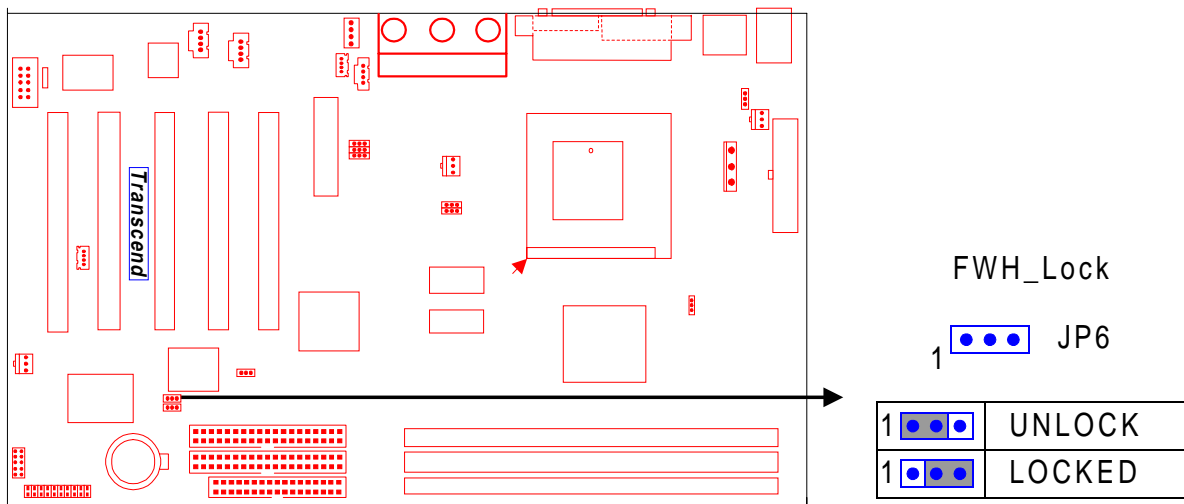

FWH Lock Jumper

2.16 Onboard Audio Setting (JP3 ON-BOARD AUDIO)

For the external AMR card, the onboard audio CODEC can be enabled or disabled via this jumper. Please disable the onboard audio CODEC, if you want to use a PCI Sound Card or an AMR Card.

JP3 Setting

Enable
onboard audio

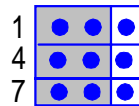

JP3 Setting

Disable
onboard audio

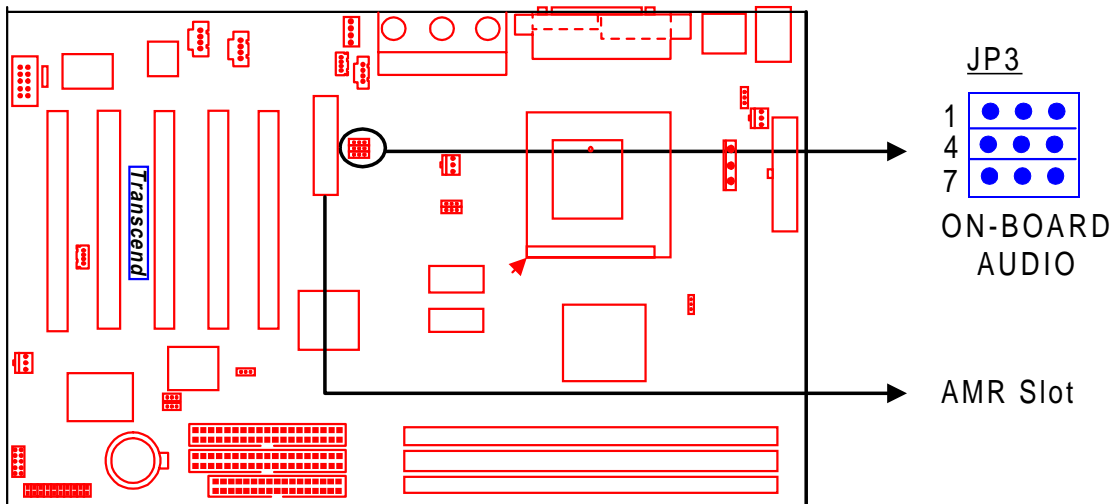
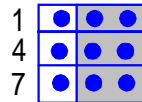

Audio Selection Jumper

2.17 Internal Audio Connector

These connectors allow you to receive stereo audio input from sound sources such as a CD-ROM, TV tuner, or MPEG card. The MODEM connector allows the onboard audio to interface a voice modem card with a matched connector. It also allows the sharing of mono_in (such as a phone) and mono_out (such as a speaker) between the onboard audio and the voice modem card.

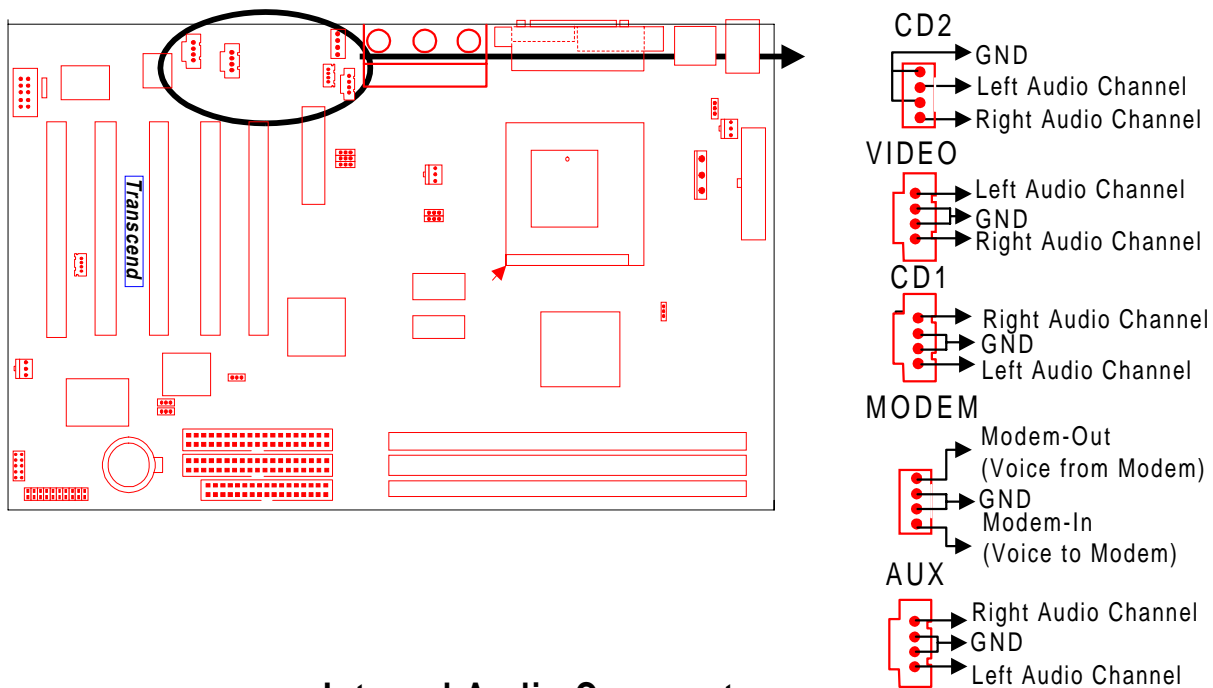

Internal Audio Connectors

2.18 Internal Serial Port Connector COMB

You can use the provided serial port bracket to add a serial port for additional serial devices. Regarding the onboard COMA, please refer to Section 2.14 “External Back Panel I/O Ports” (page 20).

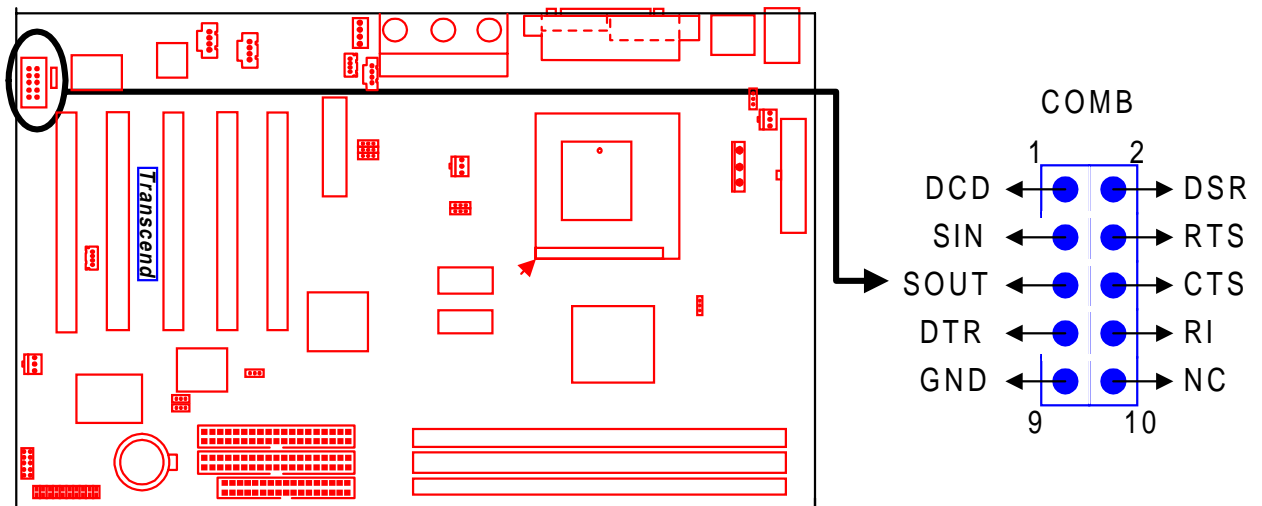

Internal Serial Port Connector COMB

Congratulations, you have now completed Hardware Setup! This means that you can move on to Chapter 3, the BIOS Setup section and turn on your PC.

CHAPTER 3 BIOS SETUP

3.1 BIOS Setup

Award BIOS has a built-in Setup program that allows users to modify the basic system configuration. This information is stored in CMOS RAM, so it can retain the Setup information when the power is turned off. When the battery of CMOS fails, it will cause the data to be lost. If that happens, please set up your configuration parameters again after replacing the battery. Please refer to Section 1.1, Essential Handling Precautions (Page 1).

3.2 The Main Menu

As you turn on or reboot the system, the BIOS is immediately activated. It will read the system configuration information, and check the system through Power On Self Test (POST). During the POST process, press the [Del] key, and you can enter the Award BIOS configuration system. The following screen will appear.

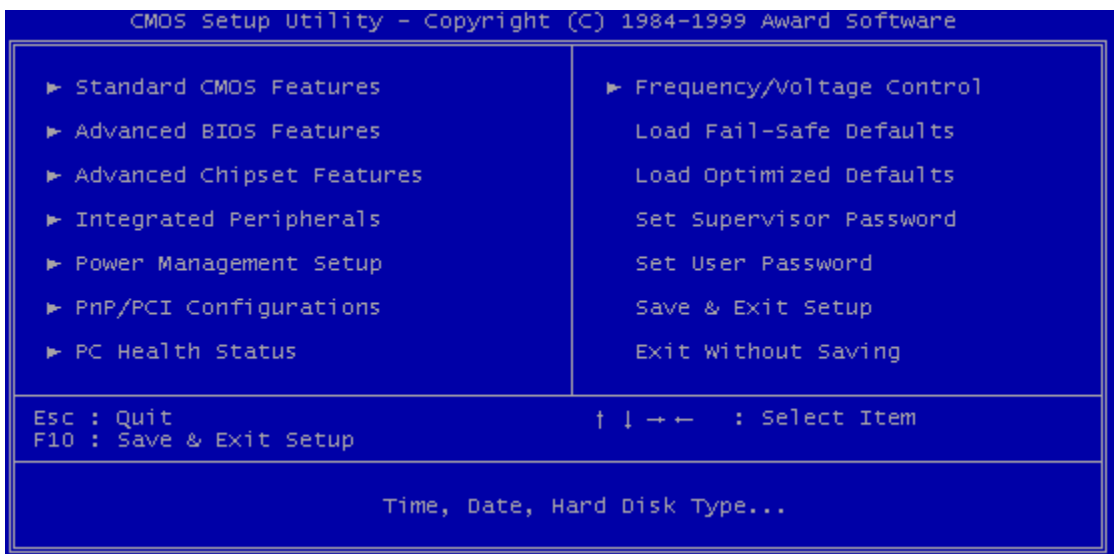

In the Award BIOS system, you can use the arrows (↑ ↓ → ←) to highlight an item, and press the [Enter] key to enter the sub-menu. The following keys help you navigate in Setup.

[Esc] Main Menu: Quit and not save changes into CMOS RAM

Other pages: Exit current page and return to Main Menu

[PgUp] Increase the numeric value or make changes

[PgDn] Decrease the numeric value or make changes

- [+] Increase the numeric value or make changes
- [-] Decrease the numeric value or make changes
- [F1] General help on setup navigation keys
- [F5] Load previous values from CMOS
- [F6] Load the Fail-Safe Defaults from BIOS default table
- [F7] Load the Optimized Defaults
- [F10] Save all the CMOS changes, and exit

The Following is a brief summary of each setup category.

- **Standard CMOS Features**

- Options in the original PC AT-compatible BIOS

- **Advanced BIOS Features**

- Award enhanced BIOS options

- **Advanced Chipset Features**

- Available options specific to your system Chipset

- **Integrated Peripherals**

- I/O subsystems that depend on the integrated peripheral controllers in your system

- **Power Management Setup**

- Advanced Power Management (APM) and Advanced Configuration Power Interface (ACPI) options

- **PnP/PCI Configurations**

- Plug and Play standard and PCI Local Bus configuration options

- **PC Health Status**

- To display the fan status, CPU temperature, system temperature, etc., and provide the temperature monitoring option

- **Frequency / Voltage Control**

- To control the frequency and voltage of the CPU

- **Load Fail-Safe Defaults**

- To load the most basic BIOS default values required for your system to operate

- **Load Optimized Defaults**

- To load the BIOS default values that are factory settings for optimal system performance

- **Set Supervisor / User Password**

To change, set, or disable a password

- **Save & Exit Setup**

To save settings in nonvolatile CMOS RAM and exit Setup

- **Exit Without Saving**

To abandon all changes and exit Setup

3.3 Standard CMOS Features

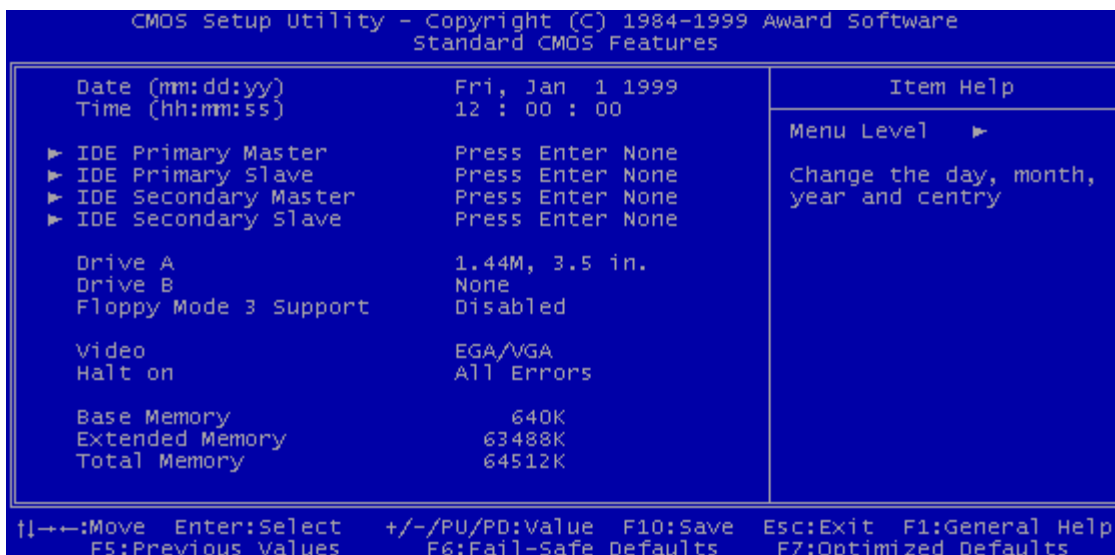

- **Date (mm:dd:yy) / Time (hh:mm:ss)**

Highlight the items and use [PageUp] / [PageDown] to change the value of Date/Time.

- **IDE Primary / Secondary Master / Slave**

Press [Enter] to enter the sub menu.

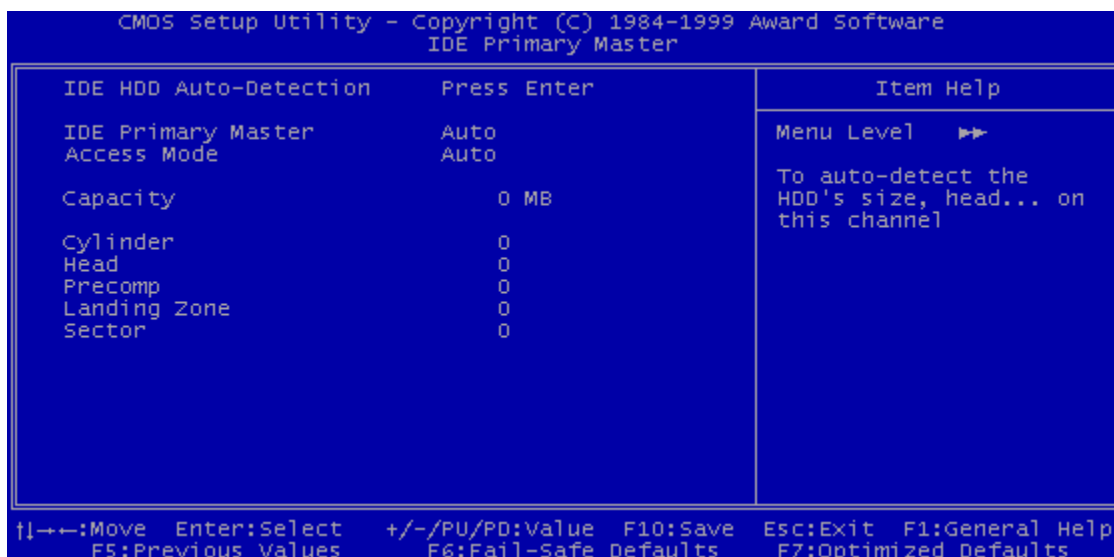

- IDE HDD Auto-Detection : Detect the HDD on this channel. If the detection is successful, it fills the remaining fields on this menu.
- IDE Primary / Secondary Master / Slave : We recommend that you select type “AUTO” for all drives. The BIOS can automatically detect the specifications during POST (Power On Self Test) while the system boots. You can also choose “Manual” to set the specifications by yourself. As to “None”, it means there is no device installed on this IDE channel.
- Access Mode : “Normal”, “LBA”, “Large”, or “Auto”.
 - Normal : Maximum number of cylinders, heads, and sectors supported are 1024, 16, and 63 respectively.
 - LBA (Logical Block Addressing) : During drive access, the IDE controller transforms the data address described by sector, head, and cylinder number into a physical block address. This will significantly improve data transfer rates for drives with more than 1024 cylinders.
 - Large : For drives that do not support LBA and have more than 1024 cylinders.
 - Auto : The BIOS automatically determines the optimal access mode.
- Capacity : Disk drive capacity. Note that this size is slightly greater than the size of formatted disk given by a disk-checking program.
- Cylinder : Number of cylinders
- Head : Number of heads

- Precomp : Write precompensation cylinder
- Landing Zone : Landing zone
- Sector : Number of sectors

• Drive A / Drive B

Select the correct types of diskette drive(s) installed in the computer.

- None : No diskette drive installed
- 360K, 5.25 in. : 5-1/4 inch standard drive; 360 kilobyte capacity
- 1.2M, 5.25 in. : 5-1/4 inch high-density drive; 1.2 megabyte capacity
- 720K, 3.5 in. : 3-1/2 inch double-sided drive; 720 kilobyte capacity
- 1.44M, 3.5 in. : 3-1/2 inch double-sided drive; 1.44 megabyte capacity
- 2.88M, 3.5 in. : 3-1/2 inch double-sided drive; 2.88 megabyte capacity

• Floppy Mode 3 Support

Supports some particular Japanese floppy drives (3-1/2 inch drive with 1.2 megabyte capacity).

• Video

Select the type of primary video subsystem in your computer. The BIOS will detect the correct video type automatically. The BIOS supports a secondary video subsystem, but do not select it in this Setup.

- EGA/VGA : Enhanced Graphics Adapter/Video Graphics Array. For EGA, VGA, SEGA, SVGA or PGA monitor adapters.
- CGA 40 : Color Graphics Adapter, powers up in 40-column mode.
- CGA 80 : Color Graphics Adapter, powers up in 80-column mode.
- MONO : Monochrome adapter, including high resolution.

• Halt On

During the Power On Self Test (POST), the computer stops if the BIOS detects a hardware error. You can set the BIOS to ignore certain errors during POST and continue the boot-up process. The followings are the selections.

- All Errors : If the BIOS detects any non-fatal errors, POST stops and prompts you to take corrective action.
 - No Errors : POST does not stop for any error.
 - All, But Keyboard : If the BIOS detects any non-fatal errors except keyboard, POST stops and prompts you to take corrective action.
-

- All, But Diskette : If the BIOS detects any non-fatal error except floppy disk drive, POST stops and prompts you to take corrective action.
- All, But Disk / Key : If the BIOS detects any non-fatal error except floppy disk drive or keyboard, POST stops and prompts you to take corrective action.

3.4 Advanced BIOS Features

This “Advanced BIOS Features” option allows you to improve your system performance and set up system features according to your preference.

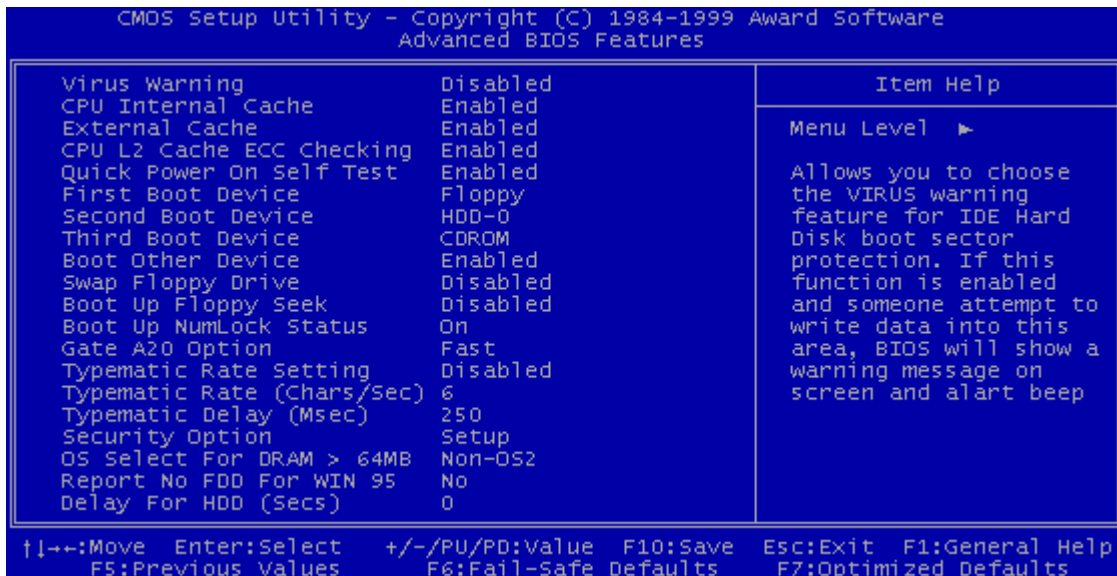

- **Virus Warning**

When this function is enabled, you will receive a warning message if a program (specifically, a virus) attempts to write to the boot sector or the partition table of the hard disk drive. You should then execute an anti-virus program. Keep in mind that this feature protects the boot sector only, not the entire hard drive.

NOTE: Many disk diagnostic programs that access the boot sector table can trigger the virus warning message. If you plan to run such a program, we recommend that you first disable the virus warning.

- **CPU Internal Cache / External Cache**

Cache memory is additional memory that is much faster than conventional DRAM (system memory). CPUs from 486-type and higher contain internal cache memory. Most, but not all, modern PCs have additional (external) cache memory. When the CPU requests data, the system transfers the requested data from the main DRAM into cache memory for even faster access by the CPU. The “External Cache” field may not appear if your system does not have external cache memory.

- **CPU L2 Cache ECC Checking**

Select “Enabled” to make sure the data is accurate.

- **Processor Number Feature**

Make the CPU Serial number function active. (Only in PIII CPU)

- **Quick Power On Self Test**

Select “Enabled” to reduce the amount of time required to run the Power On Self Test (POST). The Quick POST skips certain steps. We recommend that you normally disable Quick POST. It’s better to find a problem during POST than to lose data during your work.

- **First / Second / Third / Other Boot Device**

The original IBM PCs load the DOS operating system from drive A (floppy disk). So, IBM PC-compatible systems are designed to search for an operating system first on drive A, and then on drive C (hard disk). However, the BIOS attempts to load the operating system from the devices in the sequence selected in these fields. In addition to the traditional drives A (“Floppy”) and C (“HDD-0”), options include “HDD-1”, “HDD-2”, “HDD-3”, and “CD-ROM”; plus a “SCSI” hard drive, a “LS/ZIP” drive and a “LAN” drive. If your boot device is not included in the list, you can set the “Boot Other Device” field to “Enabled”, and let the system detect the drive automatically.

- **Swap Floppy Drive**

This field is effective only in systems with two floppy drives. Selecting “Enabled” assigns physical drive B to logical drive A, and physical drive A to logical drive B.

- **Boot Up Floppy Seek**

When you select “Enabled”, the BIOS tests (seeks) floppy drives to determine whether they have 40 or 80 tracks. Only 360-KB floppy drives have 40 tracks; drives with 720KB, 1.2MB, and 1.44MB capacity all have 80 tracks. Because very few modern PCs have 40-track floppy drives, we recommend that you set this field to “Disabled” to save time.

- **Boot Up NumLock Status**

Toggle between “On” and “Off” to control the state of the NumLock key when the system boots. When toggled “On”, the numeric keypad generates numbers instead of controlling cursor operations.

- **Gate A20 Option**

Choose “Fast” (default) or “Normal”. “Fast” allows RAM access above 1MB to use the fast Gate A20 line.

- **Typematic Rate Setting**

When this function is disabled, the following two items (Typematic Rate and Typematic Delay) are irrelevant. Keystrokes repeat at a rate determined by the keyboard controller in your system. When this function is enabled, you can select a typematic rate and typematic delay.

- **Typematic Rate (Chars/Sec)**

When the Typematic Rate setting is enabled, you can select a typematic rate (the rate at which character repeats) when you hold down a key of “6”, “8”, “10”, “12”, “15”, “20”, “24” or “30” characters per second.

- **Typematic Delay (Msec)**

When the Typematic Delay setting is enabled, you can select a typematic delay (the delay before key strokes begin to repeat) of “250”, “500”, “750” or “1000” milliseconds.

- **Security Option**

If you have set a password, you can select whether the password is required while the system boots, or only when you enter “Setup”.

- **OS Select for DRAM > 64MB**

Select “OS2” only if you are running OS/2 operating system with more than 64 MB of RAM on your system.

- **Report No FDD For WIN 95**

Select “Yes” to release IRQ6 when there is no floppy disk drive, for compatibility with WIN 95 logo certification.

- **Delay For HDD (Secs)**

Generally, you can set this field as “0”, but for some old Hard Disk Drives, you may need to increase the delay time for BIOS to detect what type it is.

3.5 Advanced Chipset Features

This option will change the values of the chipset registers and the system setting will alter. Do not change any values if you are unfamiliar with the chipset.

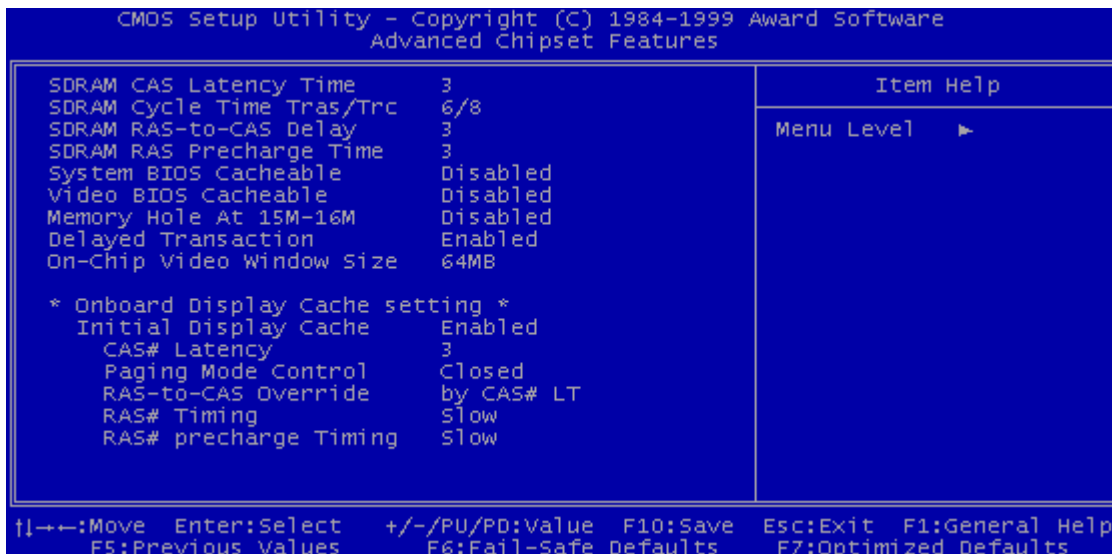

- **SDRAM CAS Latency Time**

This controls the SDRAM performance: default is 3 clocks. If your SDRAM DIMM specification is 2 CAS latency, change “3” to “2” for better performance.

- **SDRAM Cycle Time Tras / Trc**

Select the number of SDRAM clocks used per access cycle.

- **SDRAM RAS-to-CAS Delay**

This controls the latency between SDRAM active command and the read/write command. Leave it on the default setting.

- **SDRAM RAS Precharge Time**

This controls the idle clocks after issuing a precharge command to SDRAM. Leave it on the default setting.

- **System BIOS Cacheable**

Selecting “Enabled” allows caching of the system BIOS. This action can increase system performance.

- **Video BIOS Cacheable**

Selecting “Enabled” allows caching of the video BIOS. This action can increase system performance.

- **Memory Hole At 15M-16M**

Enabling this feature reserves memory address space (between 15 and 16MB) to ISA expansion cards that specifically require this setting. This makes between 15 and 16MB of memory unavailable to the system. Expansion cards can only access memory up to 16MB. The default setting is “Disabled”.

- **Delayed Transaction**

PCI access speed is faster than ISA. So PCI will release the master bus to the ISA interface for accessing data. Then the master bus control will go back to PCI again.

- **On-Chip Video Window Size**

You can select the size of mapped memory for the VGA / AGP driver to use. The choices: “64MB”, “32MB”, and “Disabled”.

Local Memory Frequency

Onboard Display Cache Setting (Only 810E Chipset)

This field is displayed only if there is onboard display cache on the system.

- **Initial Display Cache**

Select “Enabled” if you want to use the on-board display cache. The suggested selection is “Enable”

- **CAS# Latency**

- Set the CAS Latency of the onboard display cache memory.

- **Paging Mode Control**

- Open or close the paging mode control of the onboard display cache memory.

- **RAS-to-CAS Override**

- The default value, “by CAS# LT”, will let this field have the same configuration as the value of the field “CAS# Latency”. Another option, “Override(2)”, will set the value of this field to 2.

- **RAS# Timing**

- Set the RAS timing of the onboard display cache memory.

- **RAS# Precharge Timing**

- Set the RAS precharge timing of the onboard display cache memory.

3.6 Integrated Peripherals

This option will load the default BIOS values. Choose the option and the following message appears.

```

CMOS Setup Utility - Copyright (C) 1984-1999 Award Software
Integrated Peripherals

On-Chip Primary PCI IDE Enabled
On-Chip Secondary PCI IDE Enabled
IDE Primary Master PIO Auto
IDE Primary Slave PIO Auto
IDE Secondary Master PIO Auto
IDE Secondary Slave PIO Auto
IDE Primary Master UDMA Auto
IDE Primary Slave UDMA Auto
IDE Secondary Master UDMA Auto
IDE Secondary Slave UDMA Auto
USB Controller Enabled
USB Keyboard Support Disabled
Init Display First PCI Slot
AC97 Audio Auto
AC97 MODEM Auto
IDE HDD Block Mode Enabled
Power On Function BUTTON ONLY
X KB Power On Password Enter
X Hot Key Power On Ctrl-F1
Onboard FDC Controller Enabled
Onboard Serial Port1 3F8/IRQ4
Onboard Serial Port2 2F8/IRQ3
UART Mode Select Normal
X RXD , TXD Active Hi,Hi
X IR Transmission Delay Enabled
Onboard Parallel Port 378/IRQ7
Parallel Port Mode ECP+EPP
X EPP Mode Select EPP1.9
X ECP Mode Use DMA 3
PWRON After PWR-Fail Off
Game Port Address 201
Midi Port Address 330
X Midi Port IRQ 5

Item Help
Menu Level ▶

↑↓←→:Move Enter:Select +/-/PU/PD:Value F10:Save Esc:Exit F1:General Help
F5:Previous Values F6:Fail-Safe Defaults F7:Optimized Defaults

```

- **On-Chip Primary / Secondary PCI IDE**

The chipset contains a PCI IDE interface which supports two IDE channels. Select “Enabled” to activate the first and/or second IDE interface. Select “Disabled” to deactivate this interface, when you install a primary and/or secondary add-in IDE interface.

- **IDE Primary/Secondary Master/Slave PIO**

The four IDE PIO (Programmed Input/Output) fields let you set a PIO mode (0-4) for each of the four IDE devices that the onboard IDE interface supports. Mode 0 through 4 provide successively increased performance. In “Auto” mode, the system automatically determines the best one for each device.

- **IDE Primary/Secondary Master/Slave UDMA**

Ultra DMA/33(66) implementation is possible only if your IDE hard drive can support it, and if the operating environment includes a DMA driver (Windows 95 OSR2 or a third-party IDE bus master driver). If both your hard disk drive and your system software can support Ultra DMA/33(66), select "Auto" to enable BIOS support.

- **USB Controller**

Select "Enabled" if your system contains a Universal Serial Bus (USB) controller and USB peripheral(s).

- **USB Keyboard Support**

Select "Enabled" if you use a USB Keyboard.

- **Init Display First**

This item allows you to decide whether to activate either the PCI Slot or the AGP first.

- **AC97 Audio / MODEM**

If you select "Enabled", BIOS will detect whether you are using any Audio / MODEM devices. When an Audio / MODEM device is detected, the onboard Audio / MODEM controller will be enabled. If you want to use your own Audio / MODEM card, set these fields to "Disabled". If not, set these fields "Enabled".

- **IDE HDD Block Mode**

Block Mode is also called Block Transfer, Multiple Commands, or Multiple Sector Read/Write. If your IDE hard drive supports Block Mode (most new drives do), select "Enabled" for automatic detection of the optimal number of Block Read / Write per sector the drive can support.

- **Power On Function**

- Password : Power On only if you key in correct password.
 - Hot Key : You can use the hot key to Power On the system.
 - Mouse Left : Power On with the Mouse Left Button.
 - Mouse Right : Power On with the Mouse Right Button.
-

- Any Key : Press any key to Power On the system.
- Button only : Power On only by pushing the button on the case (Default).
- Keyboard 98 : You can Power On system by pushing the [Power-On] key of Keyboard 98.

● **KB Power On Password**

Enter the Power On Password here. **Activated only when “Password” item is selected in the Power On Function Menu.**

NOTE: If you want to use this function, please make sure that the “KB-AWK” jumper is set to “Enabled”.

● **Hot Key Power On**

Choose [CTRL] + [F1] ~ [F12] as a hot key to Power On the system. **Activated only when “Hot Key” is selected on the Power On Function Menu.**

● **Onboard FDC Controller**

You can use this function to enable or disable the onboard FDC controller.

● **Onboard Serial Port 1 / Port 2**

Select an address and the corresponding interrupt for each of the first and second serial ports. The Choices: “Disabled”, “3F8/IRQ4”, “2F8/IRQ3”, “3E8/IRQ4”, “2F8/IRQ3”, and “Auto”.

The second serial port shares the resources (address and IRQ) with IrDA.

● **UART Mode Select**

Choose the right type of infrared device:

- Normal : Normal operation
- IrDA : IrDA compliant serial infrared port
- ASKIR : Amplitude Shift Keyed Infrared Port

● **RxD, TxD Active**

Consult your IR peripheral documentation to select the combination of RxD and TxD.

● **IR Transmission Delay**

Consult your IR peripheral documentation to select “Enabled” or “Disabled” of the IR Transmission Delay.

● **Onboard Parallel Port**

Select a logical LPT port name and matching address for the physical parallel (printer) port. The choices: “378/IRQ7”, “278/IRQ5”, “3BC/IRQ7” and “Disabled”.

- **Parallel Port Mode**

This field allows you to set the operation mode of the parallel port.

- SPP : Allows normal-speed operation, but in one direction only.
- EPP : Allows bi-directional parallel port operation at maximum speed.
- ECP : Allows DMA and bi-directional operation. It is faster than EPP mode.
- ECP + EPP : Allows normal speed operation in two-way mode.

- **EPP Mode Select**

Select EPP port type "1.7" or "1.9".

- **ECP Mode Use DMA**

Assign DMA channel "1" or "3" to the port for ECP mode operation.

- **PWR-ON After PWR-Fail**

Choose if you want the system to automatically Power On after the power has failed.

- Off : Disable this function
- On : Enable this function
- Former-Sts : Not only to Power On the system, but also to return it to its former status.

- **Game Port Address**

Set Joystick Game Port Address. The choices : "Disabled", "201" and "209".

- **Midi Port Address**

Set Midi Port Address. The choices : "Disabled", "330", "300" and "290"

- **Midi Port IRQ**

Assign IRQ 5 or 10 to the Midi Port.

3.7 Power Management Setup

The Power Management Setup allows you to configure your system to minimize energy consumption, according to your own style of computer use.

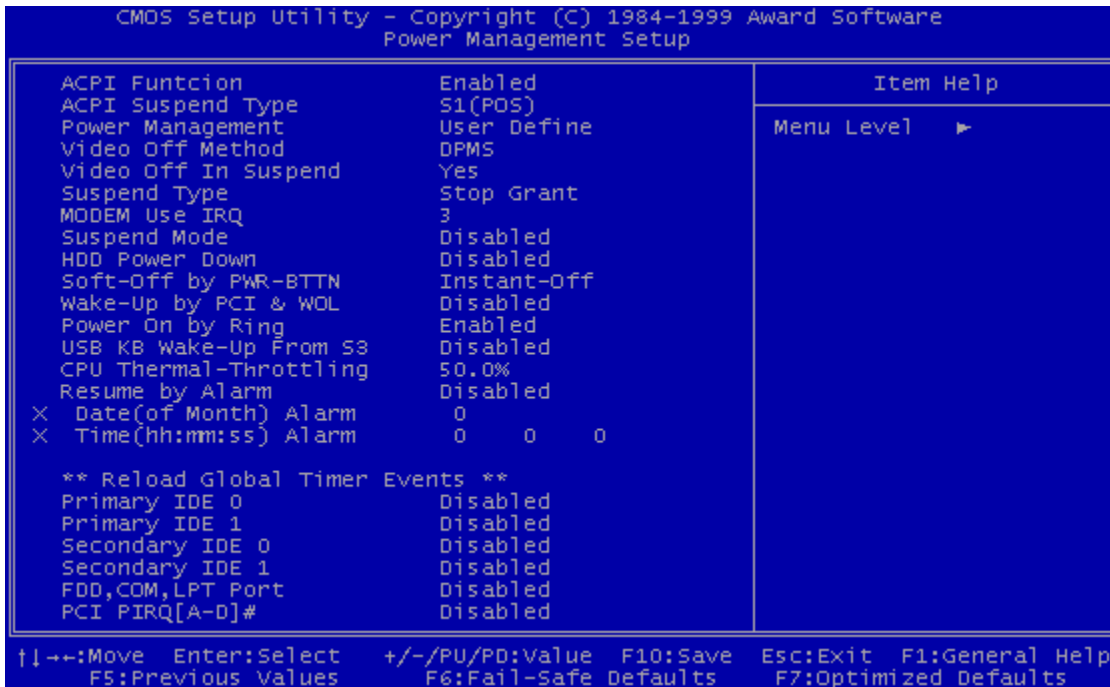

- **ACPI Function**

This item allows you to enable/disable the Advanced Configuration and Power Interface (ACPI).

- **ACPI Suspend Type**

Select the ACPI Suspend Type : “S1 (POS)” or “S3 (STR)”.

If your expansion cards do not support the STR function, you must leave this field on “S1 (POS)” setting. The STR (Suspend-to-RAM) is an energy-saving feature. It takes only a few seconds to wake up the system and return to the previous situation.

NOTE: This feature (STR) requires an ATX power supply with at least 720mA + 5V standby power for the Advanced Configuration and Power Interface (ACPI) functions.

Otherwise, the system will fail to return from suspend mode.

- **Power Management**

This category allows you to select the type (or degree) of power saving and is directly related to the following modes.

1. Suspend Mode
2. HDD Power Down

There are three selections for Power Management. Two of them have fixed mode settings.

1. Min. Power Saving :

Minimum power management mode. Inactivity period is defined below:

Suspend Mode = 1 hr. HDD Power Down = 15 min.

2. Max. Power Saving :

Maximum power management mode. Inactivity period is defined below:

Suspend Mode = 1 min. HDD Power Down = 1 min.

3. User Define :

Allows you to set each mode individually. Select the time-out period for each mode shown above.

- **Video Off Method**

Defines the Video Off features.

- Blank Screen :

Only blanks the screen. Use this for monitors without power management and “green” features.

- V/H SYNC+BLANK :

Blanks the screen and turns off vertical and horizontal scanning.

- DPMS :

The DPMS (Display Power Management System) feature allows the BIOS to control the video display card if it supports the DPMS feature.

- **VIDEO Off In Suspend**

This determines the manner in which the monitor is blanked. Select “Yes” to blank the monitor when the system enters suspend mode.

- **Suspend Type**

Select Suspend Type : “Stop Grant” or “PWR ON Suspend”.

- **MODEM Use IRQ**

You can select one of the following interrupt resources for modem use: “N/A”, “3”, “4”, “5”, “7”, “9”, “10”, and “11”.

- **Suspend Mode**

After the selected period of system inactivity (1 minute to 1 hour), all devices except the CPU will be shut down.

- **HDD Power Down**

After the selected period of system inactivity (1 to 15 minutes), the hard disk drive powers down while all other devices remain active. This feature doesn't effect SCSI hard drives.

- **Soft-Off by PWR-BTTN**

When set to "Instant-off", the ATX switch can be used as a normal system Power Off button. When set to "Delay 4 seconds", you need to press the Power-Off button down for more than 4 seconds if you want to Power Off the system.

- **Wake-Up by PCI & Card**

Select "Enabled" if you want to Power On your system when a PCI or LAN event occurs.

- **Power On by Ring**

Select "Enabled" to Power On your system when the external MODEM receives a call.

NOTE:This function requires an external MODEM which supports the Ring Wake-Up function.

- **CPU Thermal-Throttling**

Select the CPU Thermal-Throttling rate. If BIOS detects that the CPU temperature is too high, it will slow down the CPU's speed according to this field. The choices: "87.5%", "75.0%", "62.5%", "50.0%", "37.5%", "25.0%" and "12.5%".

- **Resume by Alarm**

Select "Enabled" if you want to power up your system at a certain time on the same day every month or at a certain time every day.

- **Date / Time**

Set the Date and Time to Power On the system. **Activated only when the "Resume by Alarm" field is enabled.**

- **Reload Global Timer Events**

When "Enabled", an event occurring on any device listed below restarts the global timer from Standby Mode, and Powers On the system.

Primary IDE 0
Primary IDE 1
Secondary IDE 0
Secondary IDE 1
FDD, COM, LPT Port
PCI PIRQ[A-D]#

The settings in these fields enable or disable the detection of IDE, floppy, serial and parallel port activities for powering down state transition. Actually it detects the read/write to/from I/O ports.

3.8 PnP/PCI Configuration Setup

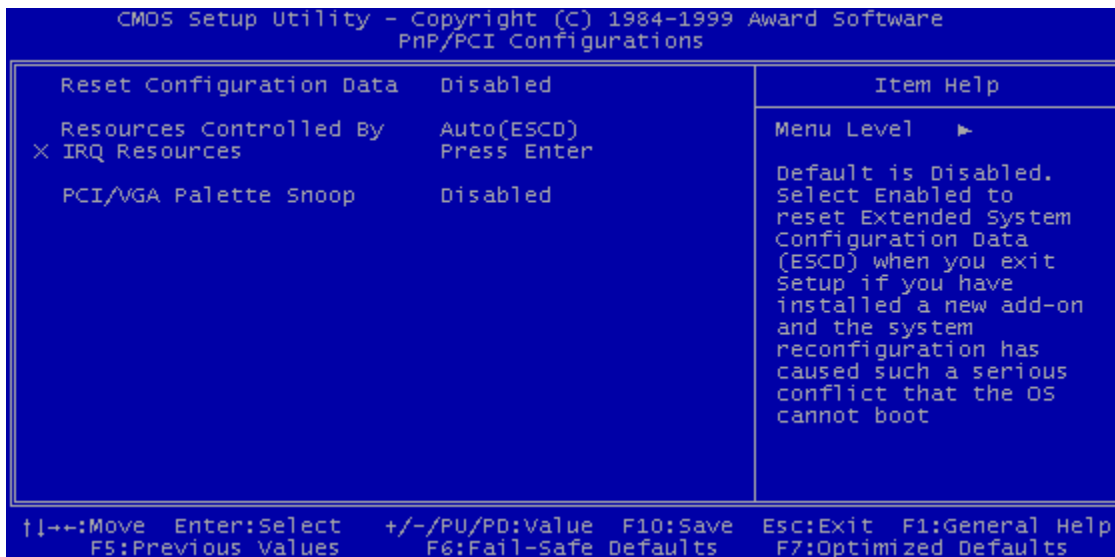

- **Reset Configuration Data**

Normally, you leave this field “Disabled”. Select “Enabled” to reset Extended System Configuration Data (ESCD), if you have just installed a new add-on card and the system reconfiguration has caused such a serious conflict that the operating system cannot boot. The setting will automatically be set back to “Disabled” when next time the system reboots.

- **Resources Controlled by**

The Award Plug and Play BIOS can automatically configure all the boot and Plug and Play(PnP) compatible devices. If you select “Auto”, all of the Interrupt Requests (IRQs) and DMA assignment fields will be deactivated as the BIOS automatically assigns them. The choices: “Auto” and “Manual”.

- **IRQ Resources**

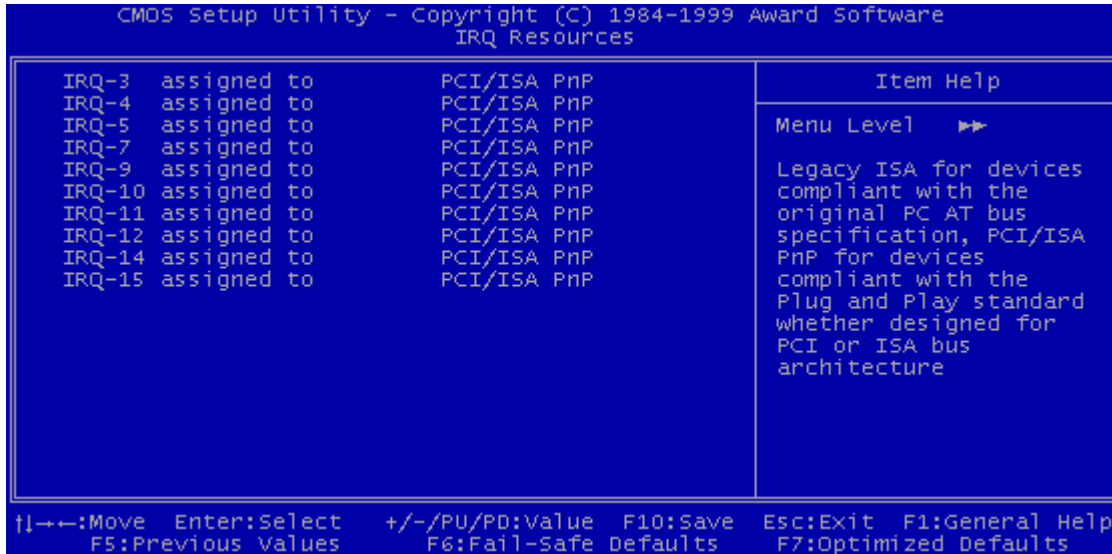

- **IRQ-n Assigned to**

When the resources are controlled manually, assign each System Interrupt to one of the following, depending on which type of device is using the interrupt.

- Legacy ISA Devices requiring a specific interrupt (such as IRQ4 for serial port1), compliant with the original PC AT bus specification.
- PCI/ISA PnP devices, whether designed for PCI or ISA bus architecture, compliant with the Plug and Play standard.

- **PCI / VGA Palette Snoop**

Some VGA cards, such as graphics accelerators or MPEG video cards, might not show colors properly. Select “Enabled” to correct this problem. If you don’t have such problems, leave this field at “Disabled”.

3.9 PC Health Status

This menu provides two thermo-protect functions (CPU warning temperature and shutdown temperature) and a hardware monitor center. These features let you know the health status of your PC.

```
CMOS Setup Utility - Copyright (C) 1984-1999 Award Software
PC Health Status

CPU Warning Temperature      Disabled
Current CPU Temperature     40°C/104°F
Current System Temp.        30°C/ 86°F
Current CPU Fan Speed       4891 RPM
Current Power Fan Speed     0 RPM
Current Case Fan Speed     0 RPM
Vcore                       2.00 V
VTT                          1.48 V
+3.3V                       3.47 V
+ 5 V                       5.02 V
+12 V                       12.03 V
-12 V                       -12.52 V
- 5 V                       - 5.14 V
3.3VSB                      3.37 V
Shutdown Temperature        75°C/167°F

Item Help
Menu Level ▶

↑|←→:Move  Enter:Select  +/-/PU/PD:Value  F10:Save  Esc:Exit  F1:General Help
F5:Previous Values  F6:Fail-Safe Defaults  F7:Optimized Defaults
```

- **CPU Warning Temperature**

This field allows you to set the CPU warning temperature. You can choose from “50°C/122°F” to “70°C/158°F” or even “Disabled” if you like.

- **Current CPU / System Temperature**

These two fields display the CPU and the on-board system temperature.

- **Current CPU / Power / Case Fan Speed**

These fields display the fan speeds of the CPU, Power and Case.

- **Vcore**

This field displays the CPU working voltage.

- **VTT**

This field displays the GTL bus voltage.

- **3.3VSB**

This field displays the 3.3V standby power supplied to the CMOS battery.

- **Shutdown Temperature**

This field allows you to set the CPU shutdown temperature.

The choices: “60°C/140°F”, “65°C/149°F”, “70°C/158°F” and “75°C/167°F”.

3.10 Frequency / Voltage Control

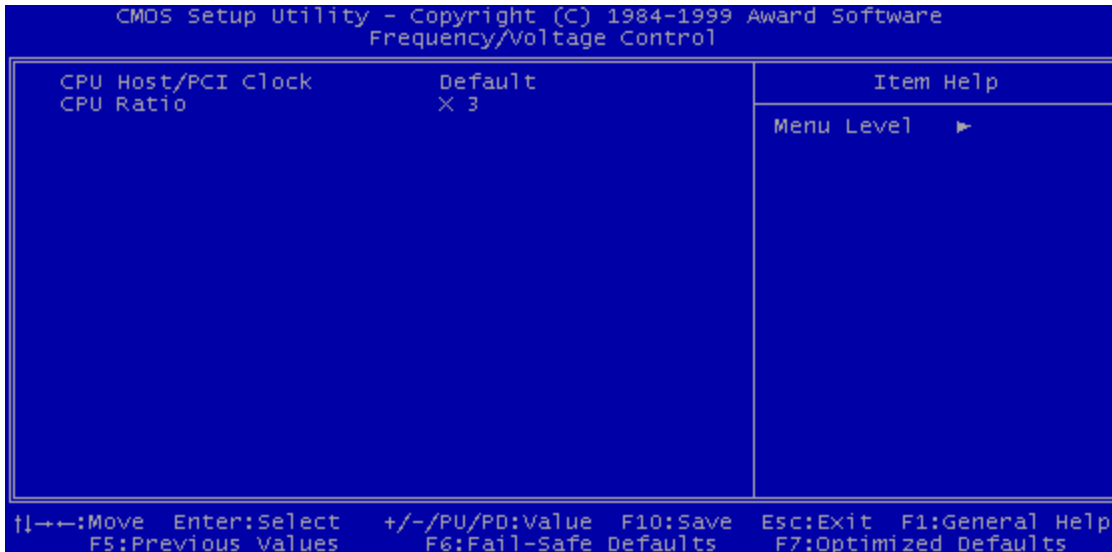

- **CPU Host / PCI Clock**

This function allows you to set the FSB frequency of the CPU and the speed of PCI bus. When JP3 is set to 66MHz, you can select the system bus frequency from 66MHz to 68 MHz. When JP3 is set to 100MHz, you can select the system bus frequency from 100MHz to 124MHz. When JP3 is set to 133MHz, you can select the system bus frequency from 133MHz to 150MHz.

- **CPU Ratio**

This function allows you to set the CPU internal frequency ratio. It determines the CPU internal frequency according to the following formula:

$$\text{CPU internal frequency} = \text{frequency ratio} \times \text{system bus frequency.}^*$$

* System bus frequency is set in the previous field ("CPU Host / PCI Clock").

The choices: "3", "3.5", "4", "4.5", "5", "5.5", "6", "6.5", "7", "7.5", and "8".

NOTE: Because Intel has locked the frequency ratio for new CPU settings, this field to adjust the frequency ratio is usually useless. However, it is effective for old version CPUs.

3.11 Load Fail-Safe Defaults

This option allows you to load the troubleshooting default values permanently stored in the BIOS ROM. **NOTE: These default settings are non-optimal and disable all high performance features.**

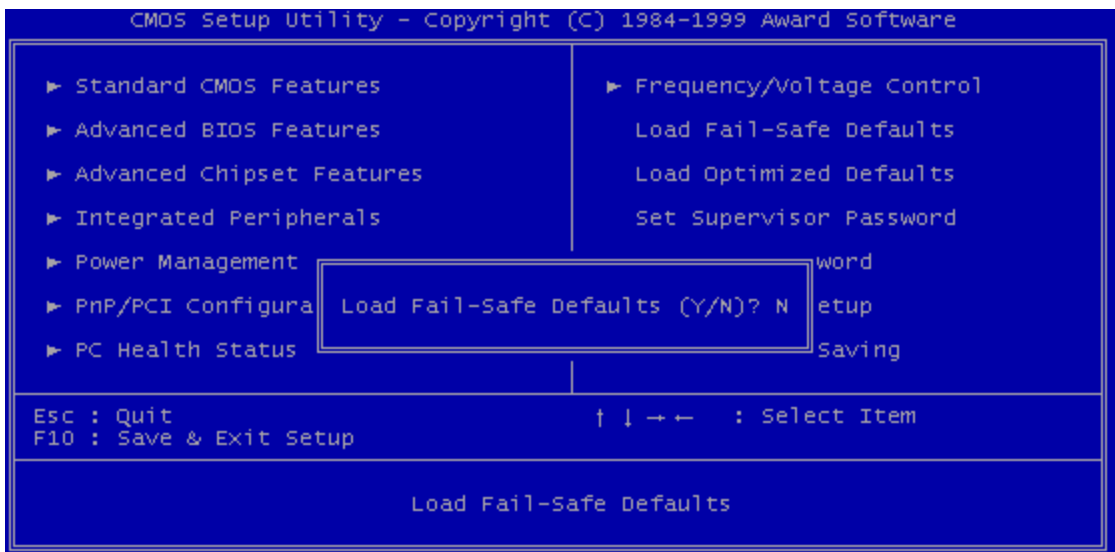

3.12 Load Optimized Defaults

This option allows you to load the default values to the system configuration fields. These default values are the optimized configuration settings for the system.

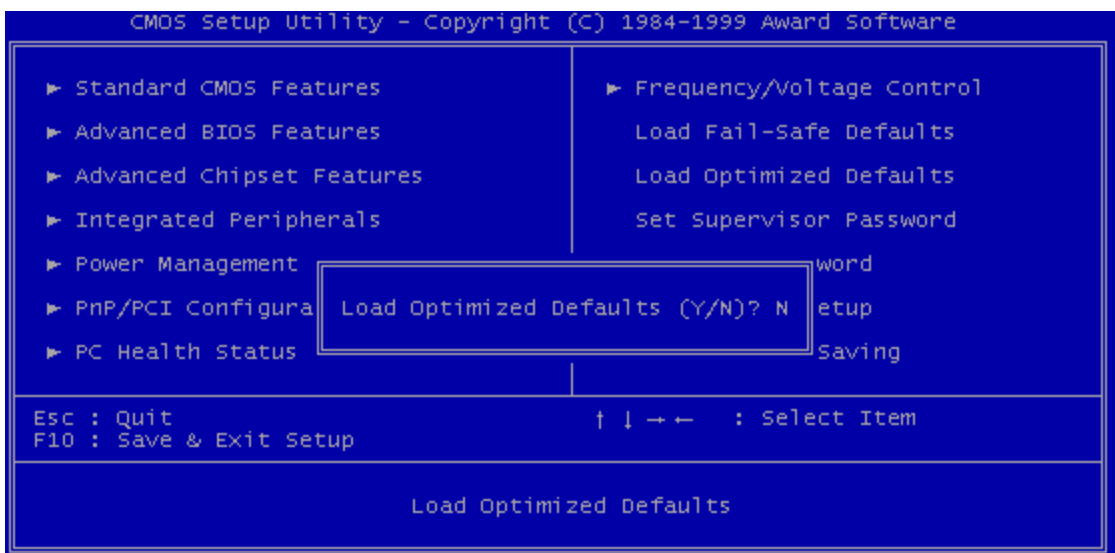

3.13 Supervisor Password

This option allows you to set a password to prevent others from changing the BIOS setting of your system.

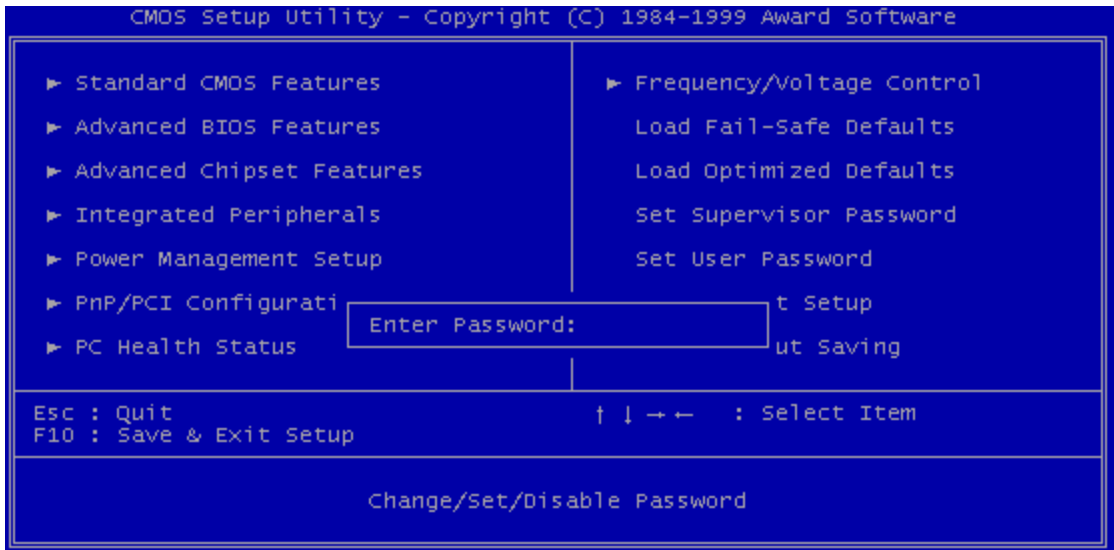

The password prevents any unauthorized use of your computer. If you set a password, the system prompts for the correct password before you boot or access "Setup".

To set a password:

1. At the prompt, type your password. Your password can be up to 8 alpha-numeric characters. When you type the characters, they appear as asterisks (*) on the password screen box.
2. After typing the password, press [Enter] key.
3. At the next prompt, re-type your password and press [Enter] key again to confirm the new password. After the password entry, the screen automatically reverts to the main screen.

To disable the password, press [Enter] key when prompted to enter the password. The screen displays a message confirming that the password has been disabled.

Forget the password?

If you forget the password, you can clear it by erasing the CMOS Real Time Clock (RTC) RAM with the jumper 5 (JP5: CMOS_CLR. Please refer to page 21). To erase the RTC RAM:

1. Unplug your computer.
 2. Short the JP5 for about 10 second, and restore the JP5 setting.
 3. Turn On your computer.
 4. Hold down [Delete] key during the POST process and enter BIOS setup to re-config BIOS.
-

3.14 User Password

This option allows you to set a password to prevent others from changing the BIOS setting of your system. This operation is the same as Supervisor Password.

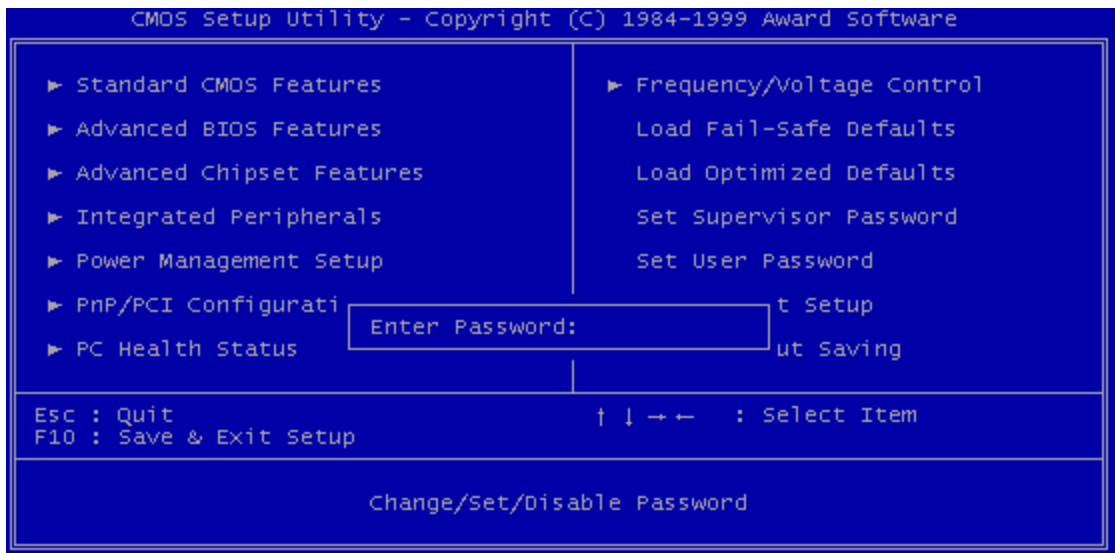

3.15 Save & Exit Setup

Save the setting and exit the BIOS utility.

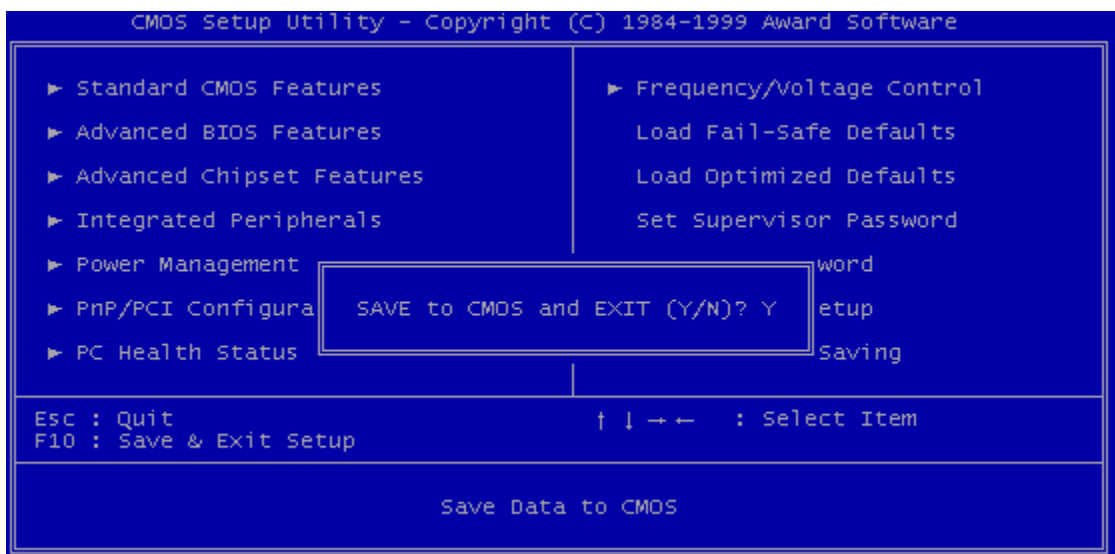

3.16 Exit Without Saving

Abort current changes and exit the BIOS utility.

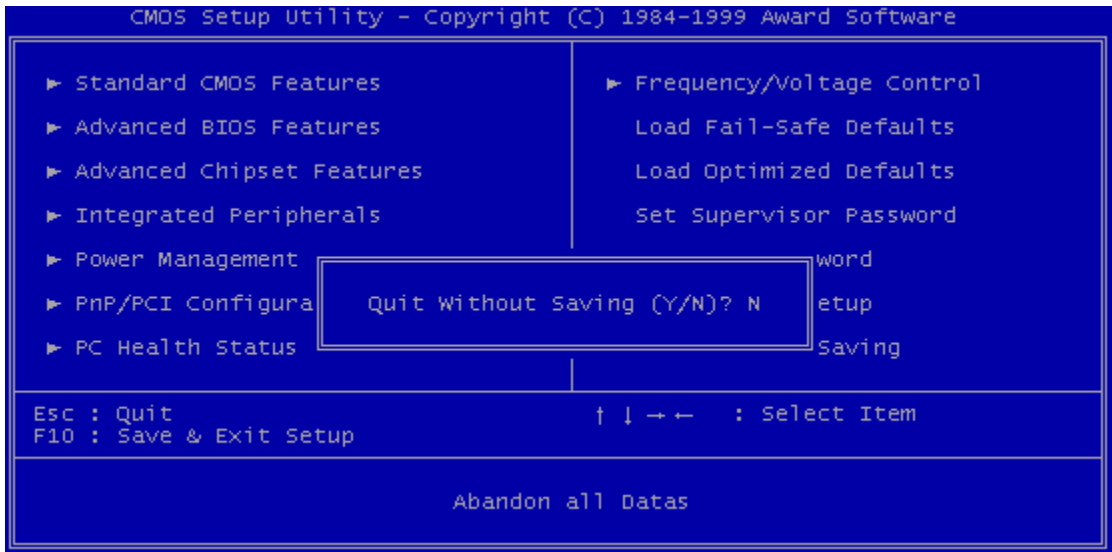

CHAPTER 4 SOFTWARE SETUP

Insert the CD-ROM enclosed with your motherboard into the CD-ROM drive. After the autorun program has executed, please check the model name showed on the screen. If the model name doesn't fit your motherboard, please re-select the correct one.

4.1 INF Update for 810 Chipset

This section introduces INF files in Windows 95/98 for the following items: System and Graphics, LPS Interface, SM Bus, PCI Bridge, Bus master IDE, USB Host, Controllers. Click **INF Update Utility for Intel 810 chipset**, and follow the figures as below.

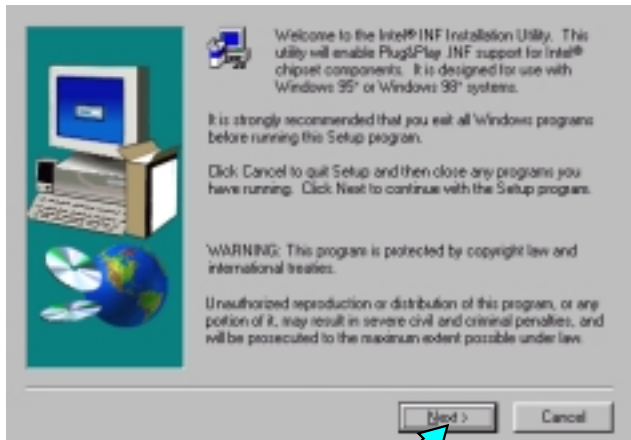

1 Click here

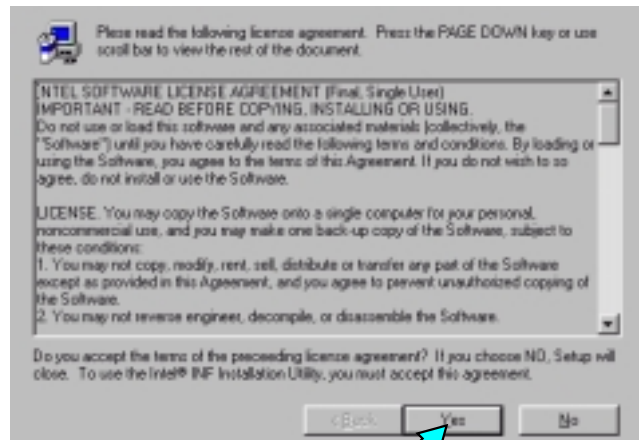

2 Click here

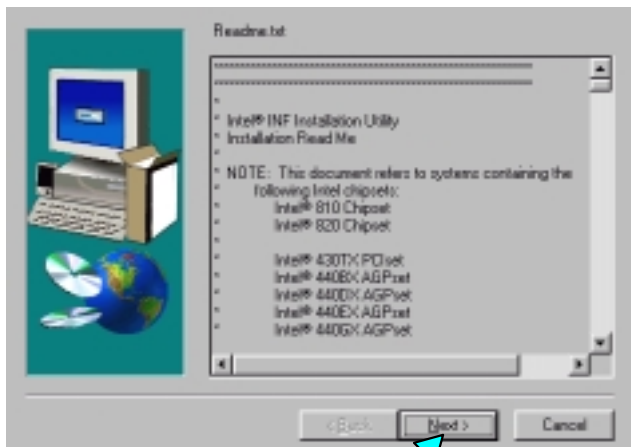

3 Click here

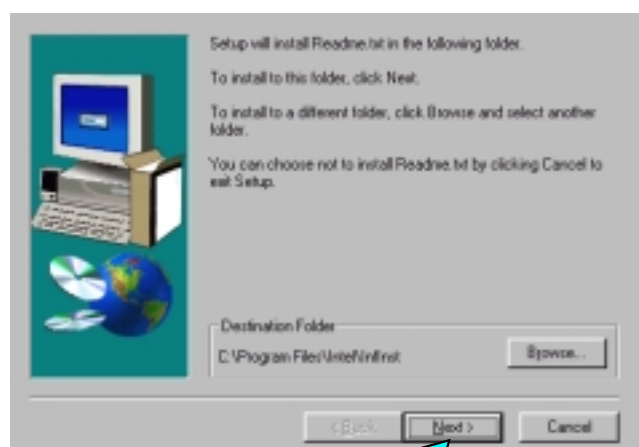

4 Click here

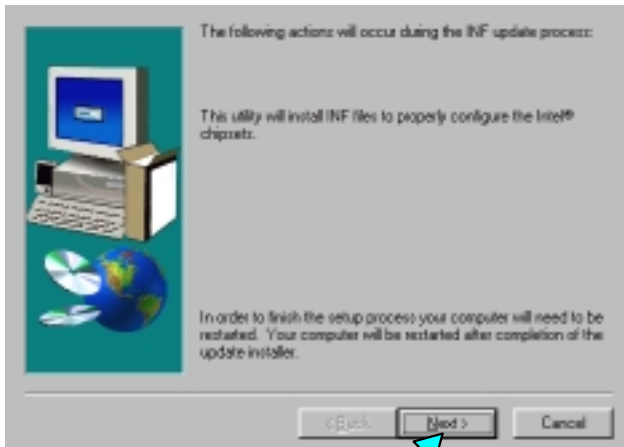

5 Click here

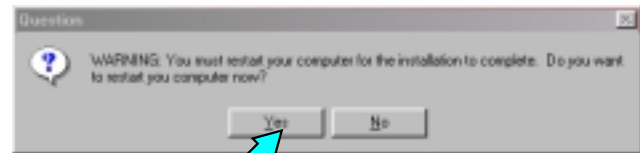

6 Click here

4.2 VGA Driver Setup

This section introduces Intel 810 DC-100 (or 810E) system and graphics controller Driver. Click **VGA Driver Setup**, and then follow the figures as below:

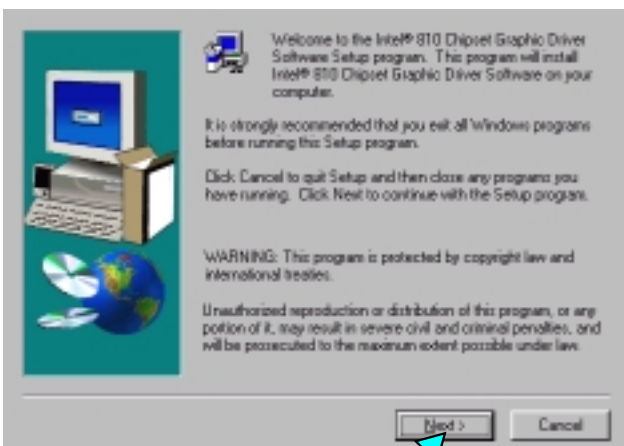

1 Click here

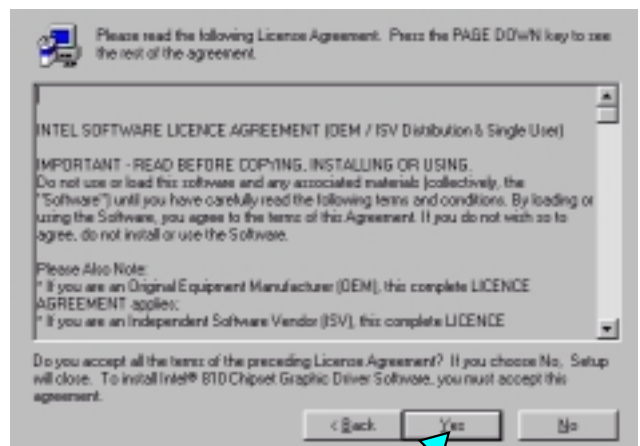

2 Click here

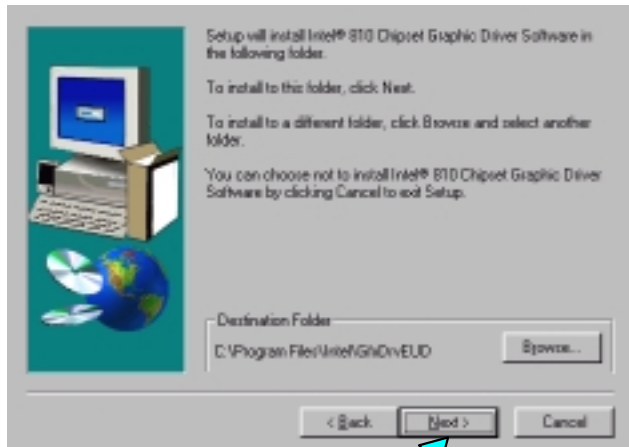

3 Click here

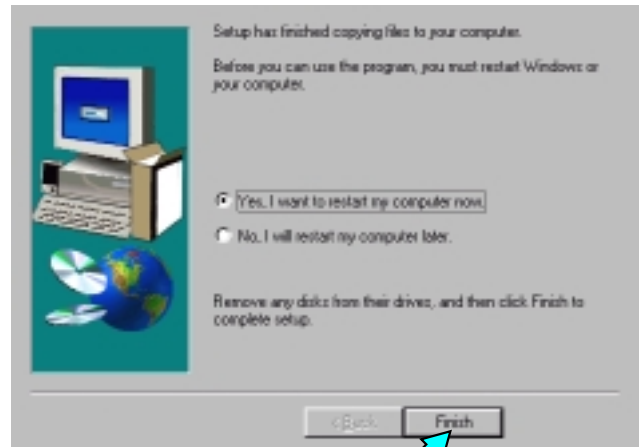

4 Click here

4.3 Intel Security Controller Driver

This section helps you to install a security controller for Windows 95/98. Click **Security Driver Setup**, and then follow the figures as below:

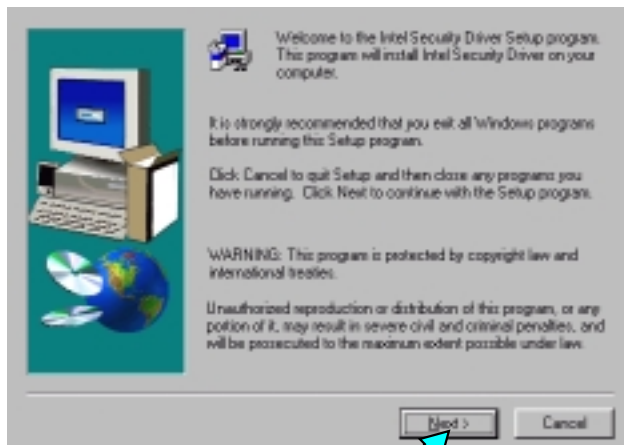

1 Click here

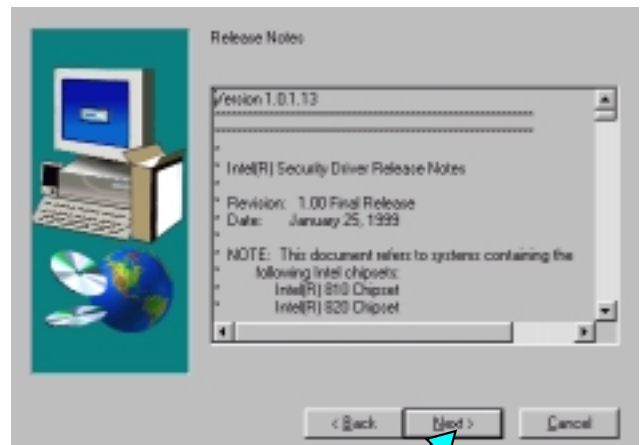

2 Click here

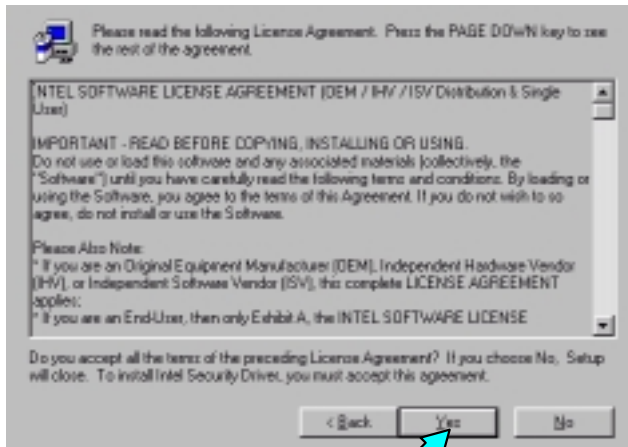

3 Click here

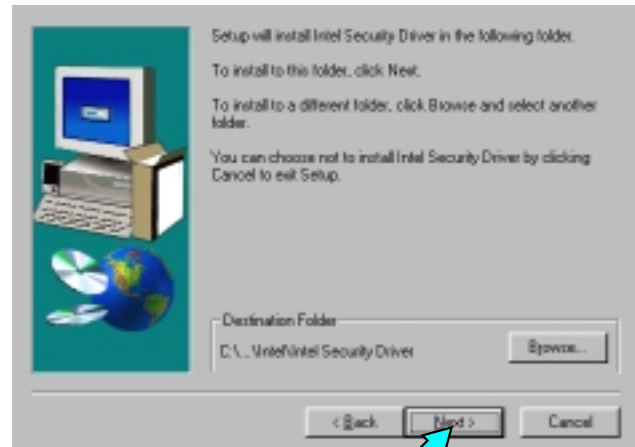

4 Click here

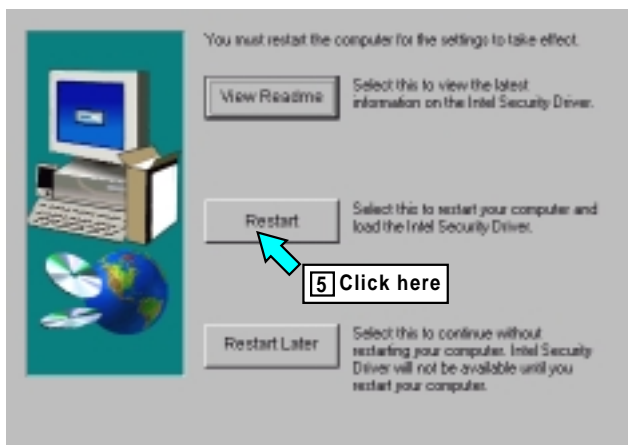

5 Click here

4.4 Audio Driver Setup

This section helps you to setup the onboard audio device. Click **Audio Driver Setup**, and choose the operation system you use.

A. Audio Driver for Windows 95/98/2000

The figures follow are captured from Windows 98SE, and you can setup the Audio Codec in almost the same way in Windows 95 and Windows 2000.

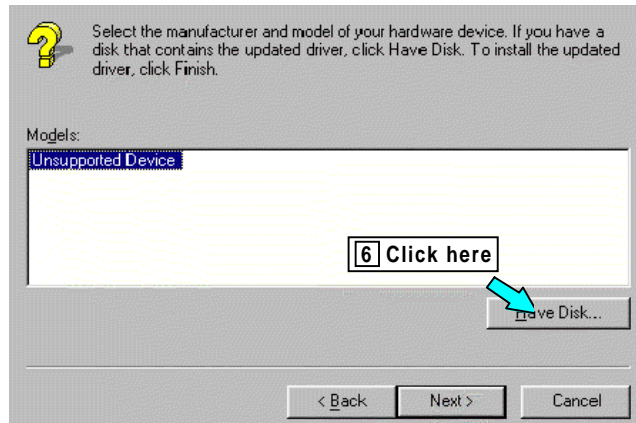
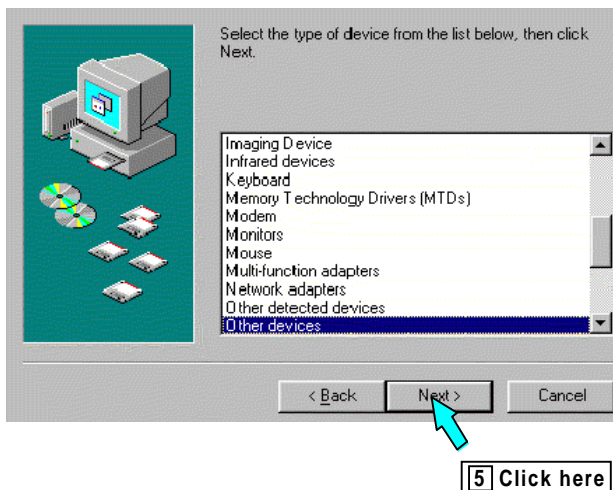
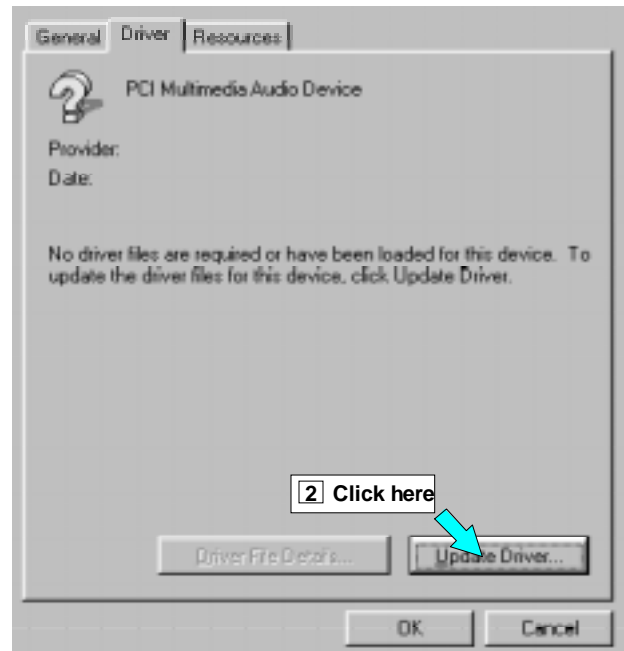
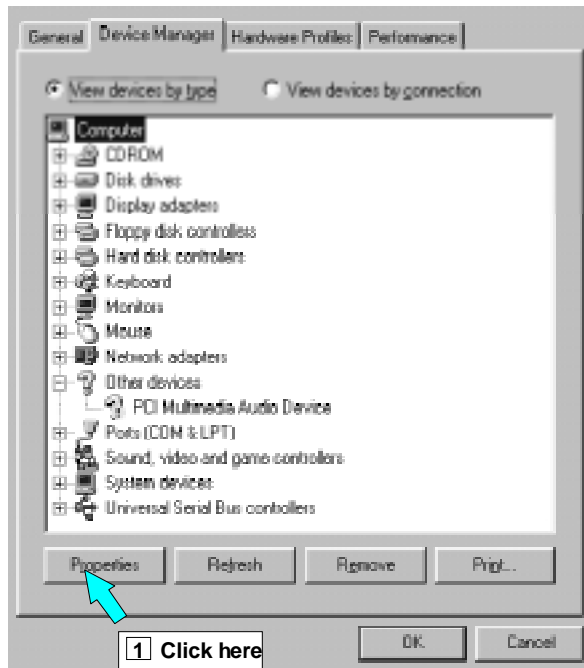



7 Click here

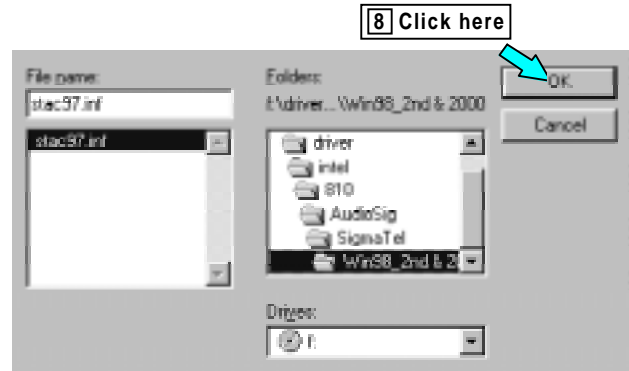

8 Click here



9 Click here

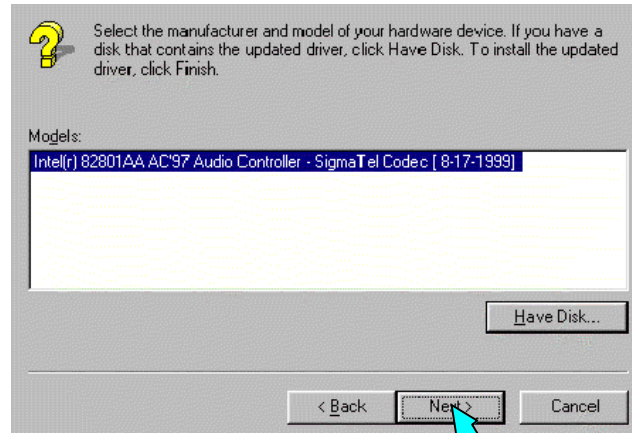

10 Click here



11 Click here

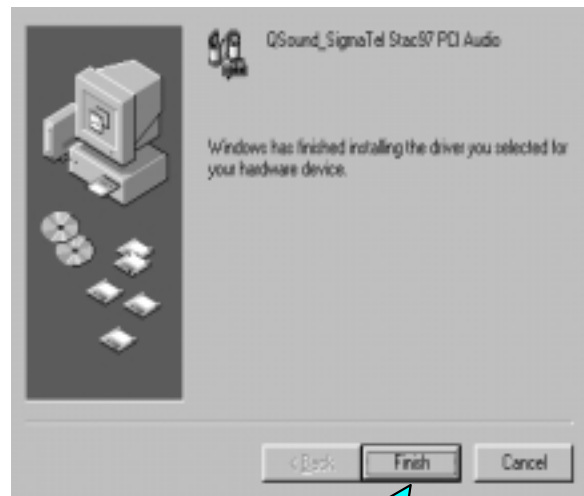

12 Click here

B. Audio Driver for WindowsNT

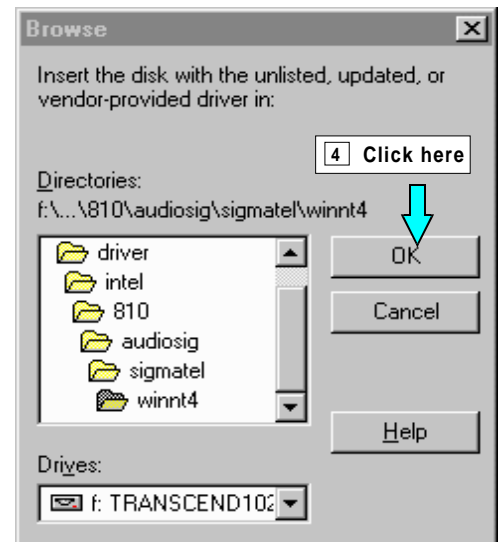
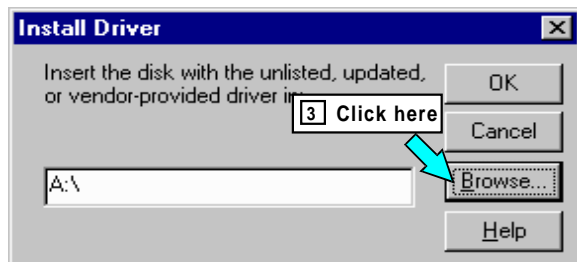
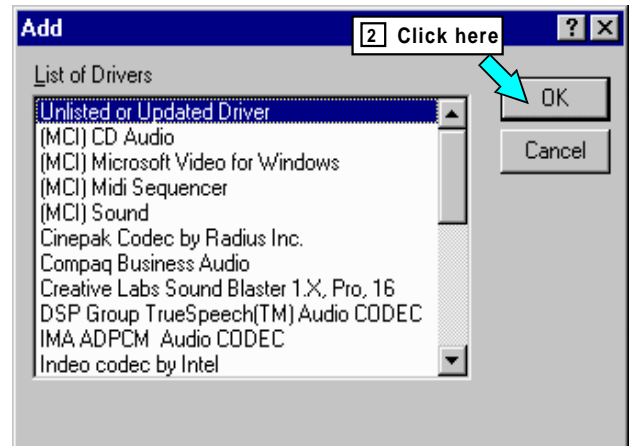
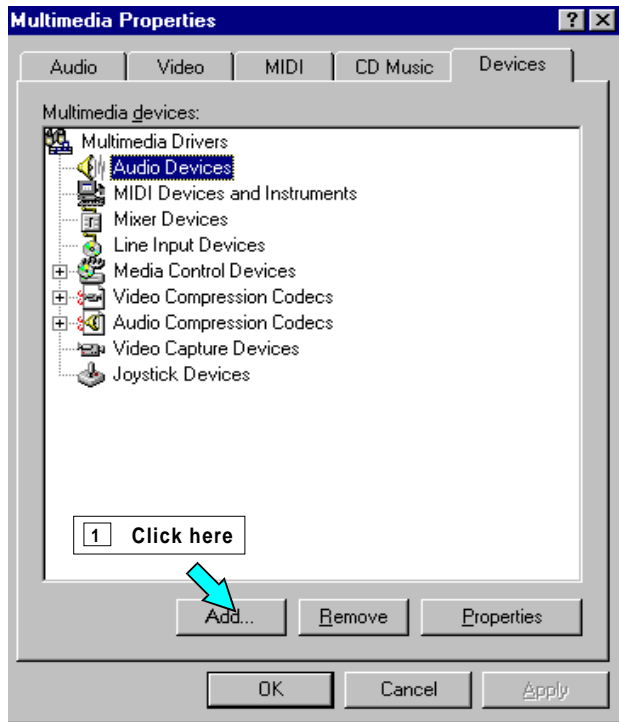

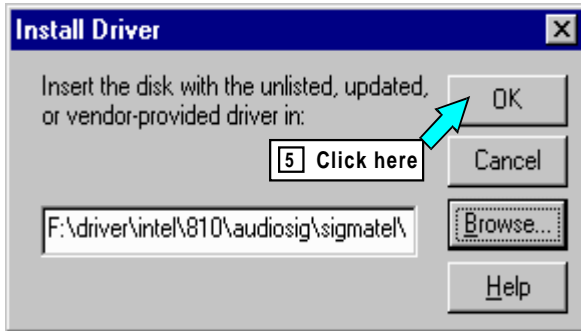

CHAPTER 5 BIOS UPGRADE

Caution!

Only users familiar with the upgrade procedure are recommended to update the BIOS of the motherboard and only when there is a need to do so. Please note that you have to download and install the right file on your motherboard. Otherwise, you might cause some serious system malfunctions.

5.1 How to Check Your BIOS File Name and Version

Please turn on PC first, the screen will display as follows (For example):

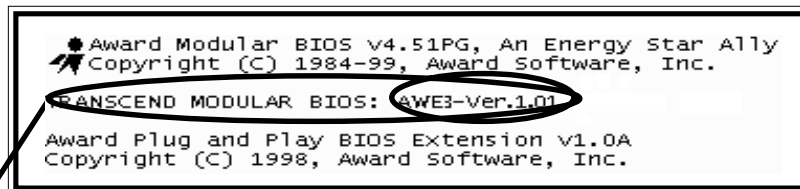

TRANSCEND MODULAR BIOS : AWE3-Ver.1.01.

You can see the BIOS description on the third line.

AWE3 - Ver.1.01.

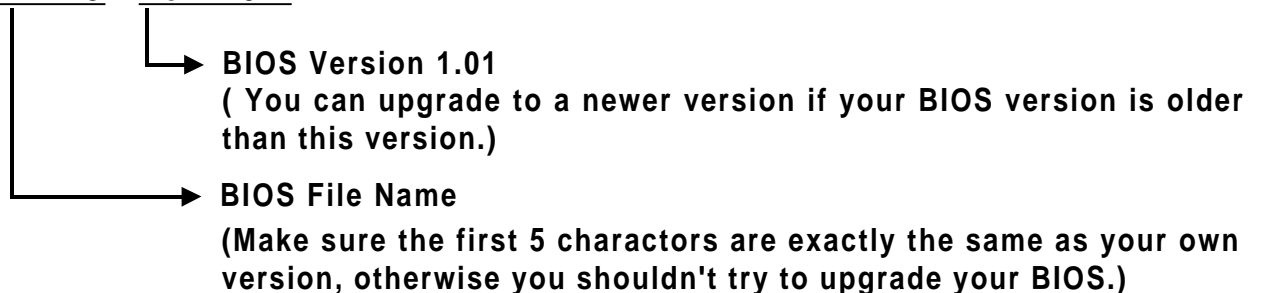

5.2 How to Download the Correct BIOS File from the Web

Please enter the Transcend website on: <http://www.transcendusa.com/>

On the front page, click on the "Motherboard" icon, which is the second one down: on the Motherboard page, click on the "BIOS" icon near the top. The BIOS page contains important information: please take time to read it carefully. Then go to the bottom of the BIOS page, click on "Slot 1" and choose your motherboard model.

Your BIOS file name must absolutely match the one shown on our web site. Then download the suitable version to your disk.

Warning: Your system could be damaged if the wrong BIOS version is accidentally used. If you are not sure what version you should choose, please contact us at: techsupport@transcend.com.tw

5.3 How to Upgrade Your Motherboard BIOS

Please follow these 5 steps listed below to upgrade your BIOS.

Step 1: Make a record of your original or existing BIOS Setup parameters.

- Press [Del] during the Power On Self Test to enter BIOS Setup Program when you start your system.
- Write down the value of each parameter in order to re-configure your system after BIOS updating.

Step 2: Make a System Disk

- Put a clean 3.5" disk in Drive A

MS-DOS : Key in **Format A:/S** and press [Enter].

Windows O/S : Select the **My Computer** icon.

Click [3.5" Floppy (A:)]

Select [File/Format] from Command Bar

Under **Format 3.5** Floppy (A:) **Menu** select

Format type = Full item, and

Other Options = Copy system files

Click [Start] button

Step 3: Download the updated **Bios.exe** file from the web site to a floppy disk.

(Ref 4.1 and 4.2)

Step 4: Type Bios.exe to decompress it.

Step 5: Please read the file of **Readme.txt** carefully, and follow the instructions step by step.

Then you can finish the BIOS upgrade.
