

**DXPS / DXPS Plus**  
**DXPS-U / DXPS Plus-U**  
**Online Manual**

DOC. NO.: DXPSP-OL-E0209A



## What's in this manual

<b>DXPS/DXPS Plus/DXPS-U/DXPS Plus-U.....</b>	<b>1</b>
<i>What's in this manual</i> .....	2
<i>You Must Notice</i> .....	8
<i>Before You Start</i> .....	9
<i>Overview</i> .....	10
<i>Feature Highlight</i> .....	11
<i>DXPS Series Comparison Table</i> .....	14
<i>Quick Installation Procedure</i> .....	15
<i>Motherboard Map</i> .....	16
<b>Hardware Installation.....</b>	<b>17</b>
<i>About "User Upgrade Optional" and "Manufacture Upgrade Optional"</i> .....	18
<i>CPU Installation</i> .....	19
<i>Installing CPU and Housing Fans</i> .....	20
<i>DIMM Sockets</i> .....	21
<i>Front Panel Connector</i> .....	23
<i>ATX Power Connector</i> .....	24
<i>AC Power Auto Recovery</i> .....	25

<i>IDE and Floppy Connector</i> .....	26
<i>ATA100 Supported</i> .....	28
<i>PC99 Color Coded Back Panel</i> .....	29
<i>Connecting 68pin Ultra320 SCSI Cable (DXPS Plus / DXPS Plus-U)</i> .....	30
<i>Connecting COM2 Connector</i> .....	32
<i>Connecting IPMB Connector</i> .....	33
<i>Support Two USB1.1 Channels (four Ports)</i> .....	35
<i>Resettable Fuse</i> .....	38
<i>Low ESR Capacitor</i> .....	39
<b>Driver and Utility</b> .....	<b>40</b>
<b>BIOS Setup Utility</b> .....	<b>41</b>
<i>Entering Setup</i> .....	42
<i>System Information</i> .....	45
<i>Product Information</i> .....	50
<i>Disk Drives</i> .....	52
<i>Onboard Peripherals</i> .....	57
<i>Power Management</i> .....	67
<i>Boot Options</i> .....	75
<i>Date and Time</i> .....	79

*System Security* ..... 81

*System Event Log* ..... 86

*Load Default Settings* ..... 94

*Abort Settings Change* ..... 95

**SCSISelect™ Utility** ..... **96**

*Running the SCSISelect™ Utility* ..... 99

*Utility Options* ..... 100

*Configure/View Host Adapter Settings Menu* ..... 103

*Advanced Configuration Options* ..... 115

*SCSI Disk Utilities* ..... 118

*Disk Drives Over 1 GByte* ..... 121

*When to Use the Extended Translation* ..... 122

**Glossary** ..... **123**

*AC97* ..... 123

*ACPI (Advanced Configuration & Power Interface)* ..... 123

*AGP (Accelerated Graphic Port)* ..... 123

*AMR (Audio/Modem Riser)* ..... 124

*AOpen Bonus Pack CD* ..... 124

*APM (Advanced Power Management)* ..... 124





<i>ATA (AT Attachment)</i> .....	124
<i>ATA/66</i> .....	124
<i>ATA/100</i> .....	125
<i>BIOS (Basic Input/Output System)</i> .....	125
<i>Bus Master IDE (DMA mode)</i> .....	125
<i>CNR (Communication and Networking Riser)</i> .....	125
<i>CODEC (Coding and Decoding)</i> .....	126
<i>DDR (Double Data Rated) SDRAM</i> .....	126
<i>DIMM (Dual In Line Memory Module)</i> .....	126
<i>DMA (Direct Memory Access)</i> .....	126
<i>ECC (Error Checking and Correction)</i> .....	127
<i>EDO (Extended Data Output) Memory</i> .....	127
<i>EEPROM (Electronic Erasable Programmable ROM)</i> .....	127
<i>EPROM (Erasable Programmable ROM)</i> .....	127
<i>EV6 Bus</i> .....	128
<i>FCC DoC (Declaration of Conformity)</i> .....	128
<i>FC-PGA (Flip Chip-Pin Grid Array)</i> .....	128
<i>Flash ROM</i> .....	128
<i>FSB (Front Side Bus) Clock</i> .....	129

<i>IPMB Bus</i> .....	129
<i>IEEE 1394</i> .....	129
<i>Parity Bit</i> .....	130
<i>PBSRAM (Pipelined Burst SRAM)</i> .....	130
<i>PC-100 DIMM</i> .....	130
<i>PC-133 DIMM</i> .....	130
<i>PC-1600 or PC-2100 DDR DRAM</i> .....	130
<i>PCI (Peripheral Component Interface) Bus</i> .....	131
<i>PDF Format</i> .....	131
<i>PnP (Plug and Play)</i> .....	131
<i>POST (Power-On Self Test)</i> .....	131
<i>RDRAM (Rambus DRAM)</i> .....	132
<i>RIMM (Rambus Inline Memory Module)</i> .....	132
<i>SDRAM (Synchronous DRAM)</i> .....	132
<i>Shadow E<sup>2</sup>PROM</i> .....	132
<i>SIMM (Single In Line Memory Module)</i> .....	133
<i>SMBus (System Management Bus)</i> .....	133
<i>SPD (Serial Presence Detect)</i> .....	133
<i>Ultra DMA</i> .....	134

*USB (Universal Serial Bus)* ..... 134

*VCM (Virtual Channel Memory)*..... 135

*ZIP file*..... 135

**Troubleshooting**..... **136**

**Technical Support** ..... **140**

**Product Registration** ..... **143**

**How to Contact Us** ..... **144**

## **You Must Notice**



Adobe, the Adobe logo, Acrobat is trademarks of Adobe Systems Incorporated.

AMD, the AMD logo, Athlon and Duron are trademarks of Advanced Micro Devices, Inc.

Intel, the Intel logo, Intel Celeron, Pentium II, Pentium III, Pentium 4 and Xeon™ are trademarks of Intel Corporation.

Microsoft, Windows, and Windows logo are either registered trademarks or trademarks of Microsoft Corporation in the United States and/or other countries.

All product and brand names used on this manual are used for identification purposes only and may be the registered trademarks of their respective owners.

All of the specifications and information contained in this manual are subject to change without notice. AOpen reserves the right to revise this publication and to make reasonable changes. AOpen assumes no responsibility for any errors or inaccuracies that may appear in this manual, including the products and software described in it.

**This documentation is protected by copyright law. All rights are reserved.**

**No part of this document may be used or reproduced in any form or by any means, or stored in a database or retrieval system without prior written permission from AOpen Corporation.**

**Copyright© 1996-2002, AOpen Inc. All Rights Reserved.**

## **Before You Start**



This Online Manual will introduce you how this product is installed. All useful information will be described in later chapters. Please keep this manual carefully for future upgrades or system configuration changes. This Online Manual is saved in [PDF format](#), we recommend using Adobe Acrobat Reader 4.0 for online viewing, it is included in [Bonus CD disc](#) or you can get free download from [Adobe web site](#).

Although this Online Manual is optimized for screen viewing, it is still capable for hardcopy printing, you can print it by A4 paper size and set 2 pages per A4 sheet on your printer. To do so, choose **File > Page Setup** and follow the instruction of your printer driver.

Thanks for the help of saving our earth.

## Overview

Thank you for choosing AOpen DXPS/DXPS Plus/DXPS-U/DXPS Plus-U motherboard. DXPS/DXPS Plus/DXPS-U/DXPS Plus-U is Intel® Socket 604 motherboard (M/B) based on the BIG ATX form factor featuring the [Intel® Server Works GC-SL Chipset](#). As high performance chipset built in the M/B, DXPS/DXPS Plus/DXPS-U/DXPS Plus-U motherboard can support Intel® Socket 604 Intel® Xeon™ and 400/533MHz [Front Side Bus \(FSB\)](#) clock. The dual channel SCSI architecture supports [Ultra320 SCSI](#) with bandwidth of up to 320MB/s for each channel. The DXPS/DXPS Plus/DXPS-U/DXPS Plus-U also integrates the Intel® 82551 10/100Mbps and Intel® 82545 GbE PCI Ethernet controller that supports 1 Gbites function for better remote site management. According to different customer's requirements, the chipset memory interface supports ECC DDR SDRAM devices with densities of 64, 128, 256, 512Mb, and 1Gb DDR SDRAM DIMM modules and the maximum memory size can be up to 4GB.

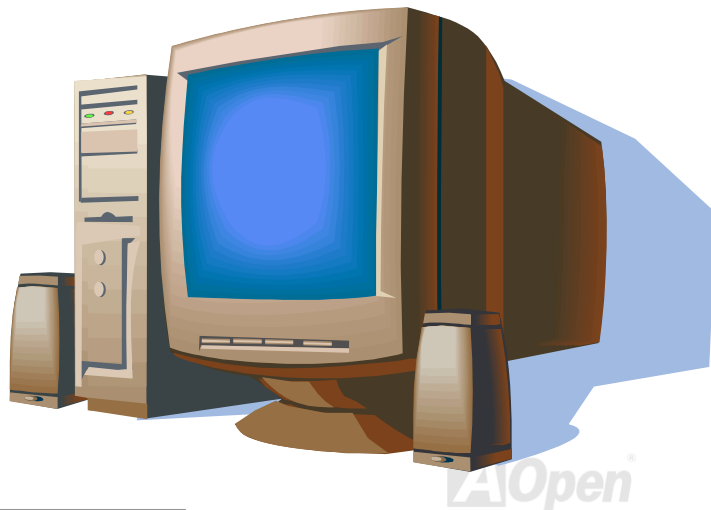

## **Feature Highlight**

### **CPU**

Supports Intel® Xeon™ 1.8GHz above with FSB400/533MHz (Front Side Bus) designed for Socket 604 technology.

### **Chipset**

With Intel® Server Works GC-SL chipset is designed for use with the Intel® Xeon™ processor in the 604-pin package. It is optimized for the Intel® Xeon™ processor, supporting a single channel of DDR 200/266.

### **Expansion Slots**

Including three 64-bit/100MHz, two 32-bit/33MHz PCI slots and one 64bit/100MHz PCI slot with ZCR Function support (DXPS Plus/DXPS Plus-U).

### **SCSI On-board (DXPS Plus / DXPS Plus-U)**

The dual channel Adaptec AIC-7902W chip host adapter delivers Ultra320/m SCSI data transfer rates which doubles the Ultra3 SCSI data transfer rate of up to 320MB/s. With two channels, it delivers a total of 640MB/s bandwidth. In addition, the AIC-7902W features a 66MHz, 64bit PCI interface that supports zero wait-state memory that also operates on 33MHz, 32bit PCI buses. It supports up to 30 devices on a 12 meters cable (or 25 meters in a point to point configuration), making it ideal for both clustering and RAID configurations.

## **Video Subsystem**

The ATI Rage XL harbors 2D and 3D display capacities that bring life to any multimedia and work applications. With a remarkable color depths and high resolutions of up to 1280\*1024 for an enhanced visual experience on your system. The on-board ATI Rage XL chipset comes with 8MB of video memory and supports up to 1280\*1024 display mode at high colors with a maximum of 8MB video memory option.

## **Intel® 82545 GbE and Intel® 82551 LAN controllers**

Another cost-effective feature for network solution is the integration of Intel 82545 GbE and Intel 82551 10/100 Mbps Fast Ethernet controllers. The Intel 82545 GbE integrates Intel's fourth-generation Gigabit MAC design with fully integrated, physical-layer circuitry to provide a standard IEEE 802.3 Ethernet interface for 1000BASE-T and 100BASE-TX applications. Moreover, on the strength of Intel 82551 LAN controller on board, which is a highly integrated Platform LAN Connect device, it provides 10/100 Mbps Ethernet.

## **Memory**

Provides four 184-pin DDR [SDRAM](#) DIMM sockets that support up to 4GB of [PC-200/266](#) compliant registered DDR SDRAM (Synchronous Dynamic Random Access Memory). You may install 64, 128, 256, 512Mb and 1Gb DDR SDRAM DIMM modules into each socket.



## **Four USB Connectors**

There are two connectors on the back pane for USB interface devices, such as mouse, keyboard, modem, scanner, etc. All two USB Connectors support USB1.1. You can use proper cables to connect USB devices from PC99 back panel or connect the 2<sup>nd</sup> USB channel header to the front panel of chassis.

## **Power Management/Plug and Play**

Supports the power management function that conforms to the power-saving standards of the U.S. Environmental Protection Agency (EPA) Energy Star program. It also offers [Plug-and-Play](#), helping save users from configuration problems and makes the system user-friendly.

## **Hardware Monitoring Management**

Supports CPU or system fans' status, temperature, voltage monitoring and alert through the on-board hardware monitor module.

## **Enhanced ACPI**

The fully implemented [ACPI](#) standard is Windows® 98/ME/2000 series compatible; it also supports Soft-Off, Stand by (S1), STD (Suspend to Disk, S4) features.

## **Super Multi-I/O**

Provides two high-speed UART compatible serial ports and one parallel port with EPP and ECP capabilities. You can also connect UART from COM1 to an Infrared Module for wireless connection.

## ***DXPS Series Comparison Table***

This comparison table below will show the differences between DXPS series motherboards.

<b>Compare/Model</b>	<b>Key Chip (North Bridge)</b>	<b>CPU Support (Dual CPU)</b>
DXPS	Server Works GC-SL(FSB:400MHz)	Support Intel Xeon 1.8 GHz above (FSB:400MHz)
DXPS Plus (With SCSI)	Server Works GC-SL(FSB:400MHz)	Support Intel Xeon 1.8 GHz above (FSB:400MHz)
DXPS-U	Server Works GC-SL(FSB:533MHz)	Support Intel Xeon 1.8 GHz above (FSB:400/533MHz)
DXPS Plus-U (With SCSI)	Server Works GC-SL(FSB:533MHz)	Support Intel Xeon 1.8 GHz above (FSB:400/533MHz)

## **Quick Installation Procedure**

This page gives you a quick procedure on how to install your system. Follow each step accordingly.

1. [Installing CPU and Fan](#)
2. [Installing System Memory \(DIMM\)](#)
3. [Connecting Front Panel Cable](#)
4. [Connecting IDE and Floppy Cable](#)
5. [Connecting ATX Power Cable](#)
6. [Connecting Back Panel Cable](#)
7. [Power-on and Load BIOS Setup Default](#)
8. [Setting CPU Frequency](#)
9. Reboot
10. Installing Operating System
11. [Installing Driver and Utility](#)

**Motherboard Map**

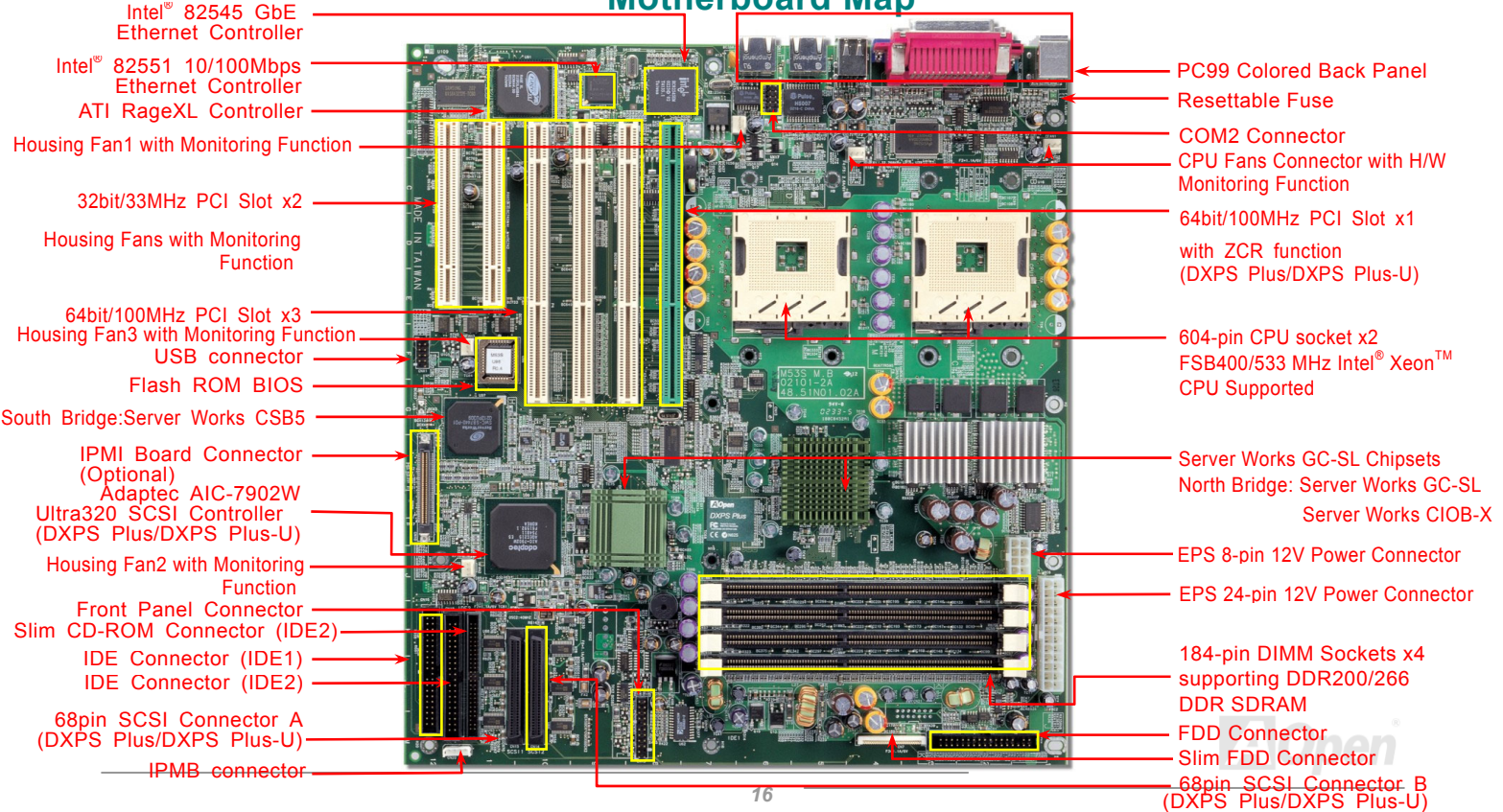

# Hardware Installation

This chapter describes jumpers, connectors and hardware devices of this motherboard.



**Note:** *Electrostatic discharge (ESD) can damage your processor, disk drives, expansion boards, and other components. Always observe the following precautions before you install a system component.*

- 1. Do not remove a component from its protective packaging until you are ready to install it.*
- 2. Wear a wrist ground strap and attach it to a metal part of the system unit before handling a component. If a wrist strap is not available, maintain contact with the system unit throughout any procedure requiring ESD protection.*

## **About “User Upgrade Optional” and “Manufacture Upgrade Optional”...**

When you read this online manual and start to assemble your computer system, you may notice that some of the functions are marked as “User Upgrade Optional” or “Manufacture Upgrade Optional”. Although all of AOpen’s motherboards have included many amazing and powerful features, sometimes not every user is familiar with these powerful features. As a result of this we define features that can be upgraded by users as “User Upgrade Optional”. You can upgrade these functions by purchasing additional devices. As for functions that cannot be upgraded by users, we define them as “Manufacture Upgrade Optional”. If need be, you can contact our local distributors or resellers to purchase “Manufacture Upgrade Optional” components, and again you are also welcome to visit our official website at [www.aopen.com](http://www.aopen.com) for detail information.



## CPU Installation

This motherboard supports Intel® Xeon™ Socket 604 series CPU. Be careful of CPU orientation when you plug it into CPU socket.

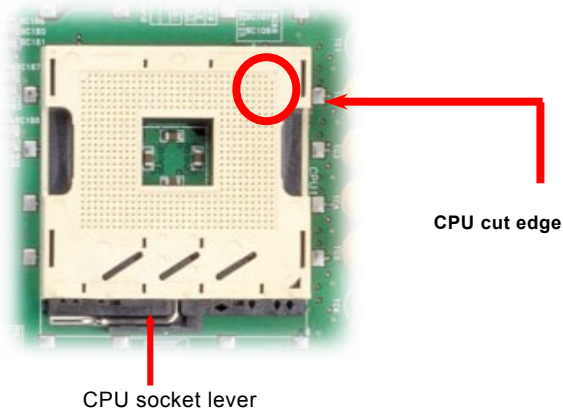

1. Pull up the CPU socket level and up to 90-degree angle.
2. Locate Pin 1 in the socket and look for a (golden) cut edge on the CPU upper interface. Match Pin 1 and cut edge. Then insert the CPU into the socket.
3. Press down the CPU socket level and finish CPU installation.

**Note:** If you do not match the CPU socket Pin 1 and CPU cut edge well, you may damage the CPU.

Note: Those pictures are for example only; it may not exactly look the same with your motherboard.

## **Installing CPU and Housing Fans**

Plug in the CPU fan cable to the 3-pin CPU FAN connector and housing fan cable to the HFan connectors.

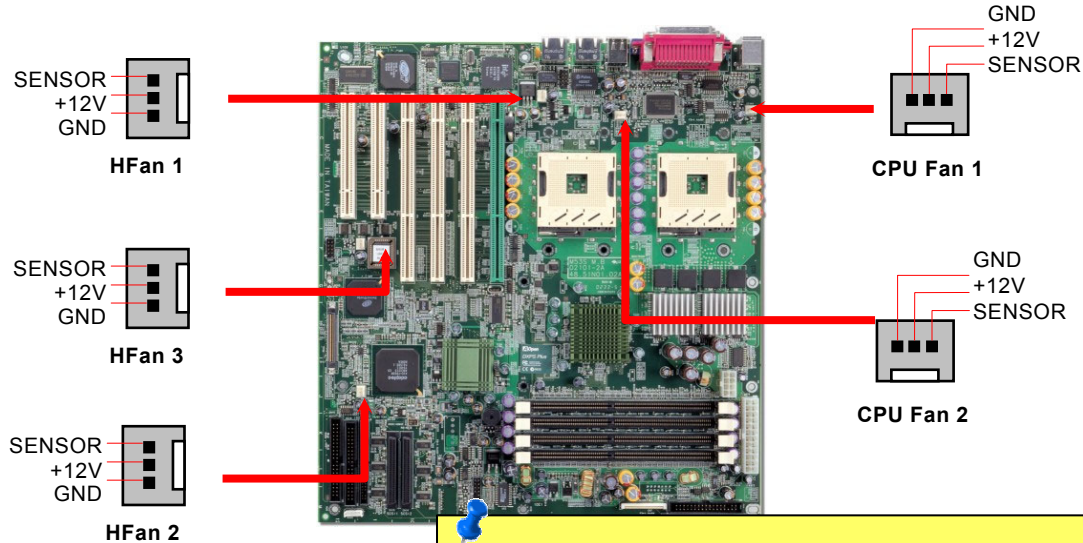

**Note:** Some CPU fans do not have sensor pin, so that cannot support fan monitoring.





## **DIMM Sockets**

This motherboard has four 184-pin DDR [DIMM](#) sockets that allow you to install [PC200](#) or [PC266](#) memory up to 4GB. ECC DDR SDRAM is supported.

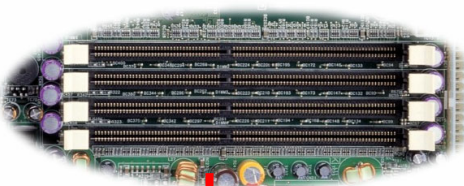
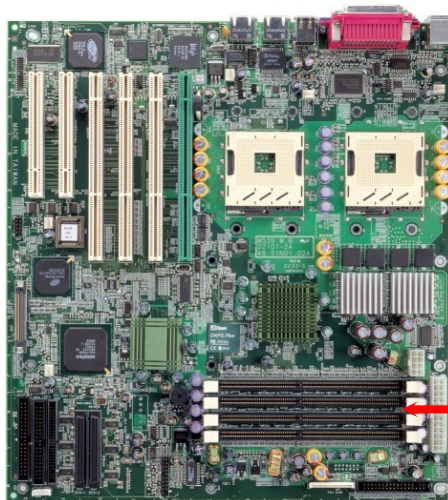

DIMM 1  
DIMM 2  
DIMM 3  
DIMM 4

## **How to Install Memory Modules**

Please follow the procedure as shown below to finish memory installation.

1. Make sure the DIMM module's pin face down and match the socket's size as depicted below.

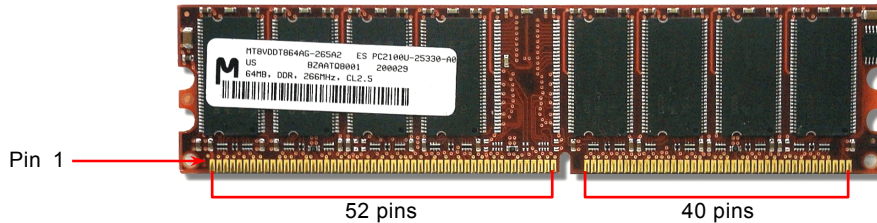

2. Insert the module straight down to the DIMM slot with both hands and press down firmly until the DIMM module is securely in place.

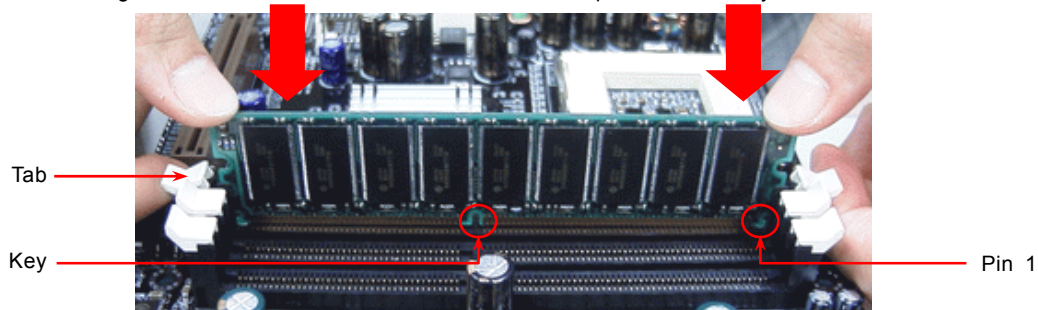

3. Repeat step 2 to finish additional DIMM modules installation.

## **Front Panel Connector**

Attaching such as power switch, reset switch, HDD LED connector, etc to corresponding pins. Locate the power switch cable from your ATX housing. It is 2-pin female connector from the housing front panel. Plug this connector to the soft-power switch connector marked **SPWR**.

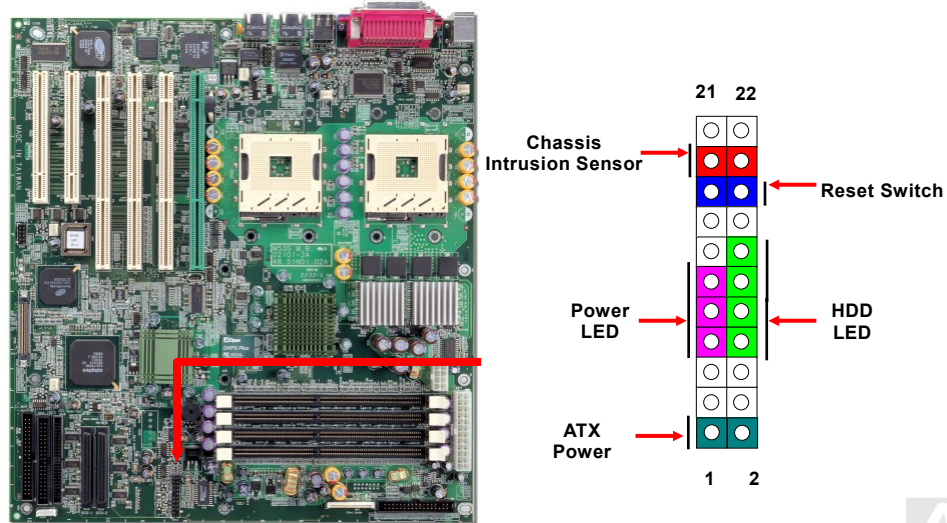

## ATX Power Connector

This motherboard comes with a 24-pin and 8-pin ATX power connector. Make sure you plug in the right direction. We strongly recommend you to connect the 8-pin 12V ATX connector before connecting the 24-pin ATX power connector

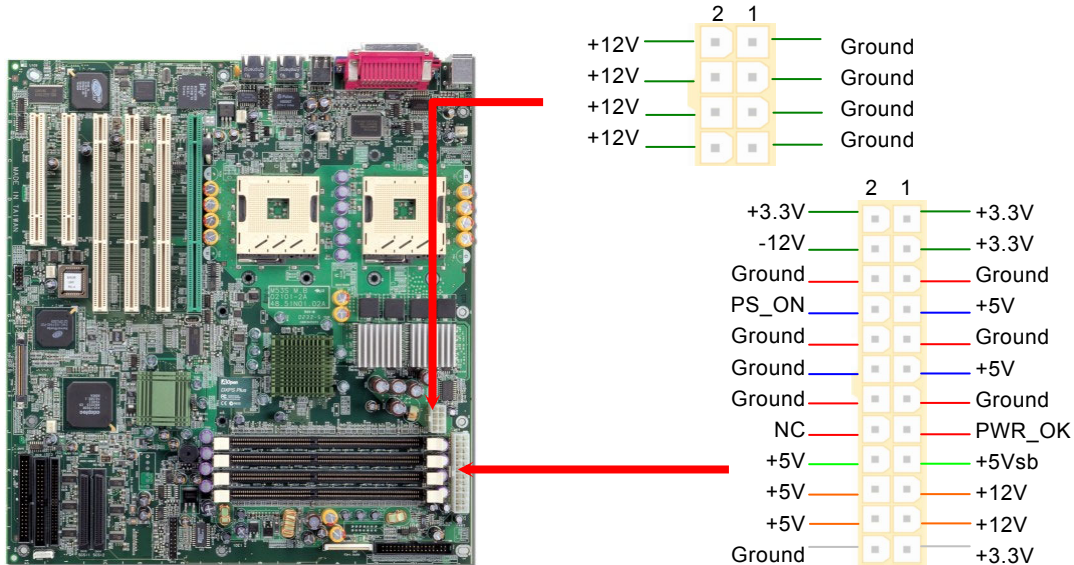

## **AC Power Auto Recovery**

A traditional ATX system remains at power off stage when AC power resumes from power failure. This design is inconvenient for a network server or workstation without an UPS. This motherboard implements an AC Power Auto Recovery function to solve this problem.



## **IDE and Floppy Connector**

Connect 34-pin floppy cable and 40-pin IDE cable to floppy connector FDC and IDE connector. Pin1 of cable is normally marked with red color. Addition to normal connectors, we provide you a slim type IDE2 connector and a slim type FDD connector. Please be informed that DO NOT connect Secondary IDE Slim connector and Secondary IDE Connector at the same time. As well as DO NOT connect FDD connector and slim FDD connector at the same time.

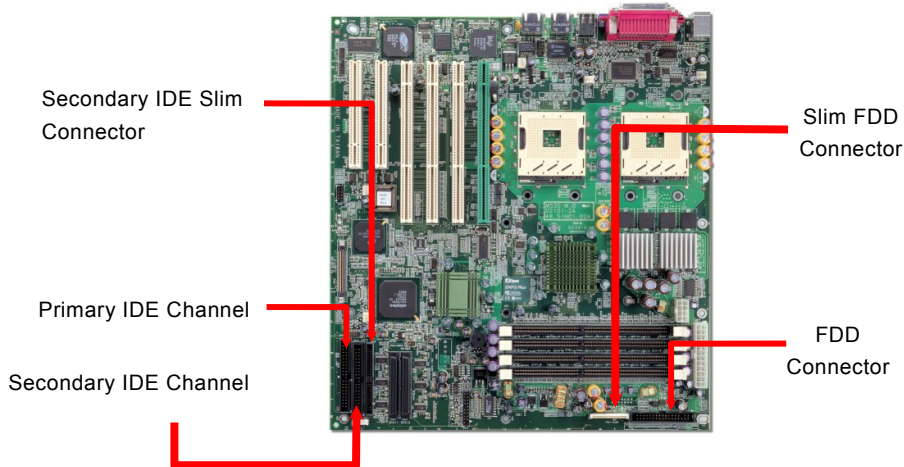

IDE1 is also known as the primary channel and IDE2 as the secondary channel. Each channel supports two IDE devices that

make a total of four devices. In order to work together, the two devices on each channel must be set differently to **Master** and **Slave** mode. Either one can be the hard disk or the CDROM. The setting as master or slave mode depends on the jumper on your IDE device, so please refer to your hard disk and CDROM manual accordingly.



**Warning:** *The specification of the IDE cable is a maximum of 46cm (18 inches); make sure your cable does not exceed this length.*



**Tip:**

1. *For better signal quality, it is recommended to set the far end side device to master mode and follow the suggested sequence to install your new device. Please refer to above diagram*
2. *To achieve the best performance of Ultra DMA 66/100 hard disks, a special **80-wires IDE cable** for Ultra DMA 66/100 is required.*

## ATA100 Supported

This motherboard supports [ATA66](#) or [ATA100](#) IDE devices. Following table lists the transfer rate of IDE PIO and DMA modes.

Mode	Clock Period	Clock Count	Cycle Time	Data Transfer Rate
PIO mode 0	30ns	20	600ns	$(1/600\text{ns}) \times 2\text{byte} = 3.3\text{MB/s}$
PIO mode 1	30ns	13	383ns	$(1/383\text{ns}) \times 2\text{byte} = 5.2\text{MB/s}$
PIO mode 2	30ns	8	240ns	$(1/240\text{ns}) \times 2\text{byte} = 8.3\text{MB/s}$
PIO mode 3	30ns	6	180ns	$(1/180\text{ns}) \times 2\text{byte} = 11.1\text{MB/s}$
PIO mode 4	30ns	4	120ns	$(1/120\text{ns}) \times 2\text{byte} = 16.6\text{MB/s}$
DMA mode 0	30ns	16	480ns	$(1/480\text{ns}) \times 2\text{byte} = 4.16\text{MB/s}$
DMA mode 1	30ns	5	150ns	$(1/150\text{ns}) \times 2\text{byte} = 13.3\text{MB/s}$
DMA mode 2	30ns	4	120ns	$(1/120\text{ns}) \times 2\text{byte} = 16.6\text{MB/s}$
DMA MODE3-4 (ATA 66)	30ns	2	60ns	$(1/60\text{ns}) \times 2\text{byte} \times 2 = 66\text{MB/s}$
DMA MODE5 (ATA 100)	20ns	2	40ns	$(1/40\text{ns}) \times 2\text{byte} \times 2 = 100\text{MB/s}$



## PC99 Color Coded Back Panel

The onboard I/O devices are PS/2 Keyboard, PS/2 Mouse, COM1, VGA, Printer and USB1.1. The view angle of drawing shown here is from the back panel of the housing.

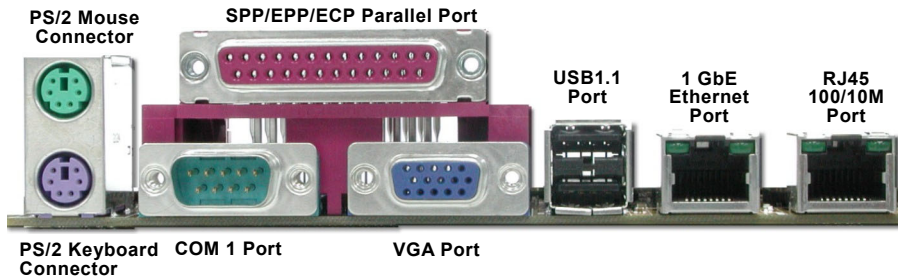

- PS/2 Keyboard: For standard keyboard, which is using a PS/2 plug.
- PS/2 Mouse: For PC-Mouse, which is using a PS/2 plug.
- USB Port: Available for connecting USB devices.
- Parallel Port: To connect with SPP/ECP/EPP printer.
- COM1: To connect with pointing devices, modem or others serial devices.
- VGA Connector: To connect with PC monitor.
- 1GbE Ethernet Port: To connect RJ-45 Ethernet Cable.
- RJ45 10/100 Port: To connect RJ-45 Ethernet Cable

## **Connecting 68pin Ultra320 SCSI Cable (DXPS Plus / DXPS Plus-U)**

The DXPS Plus provides two 68-pin Ultra320 SCSI connectors for 16-bit or 16-bit differential SCSI devices. The Adaptec AIC-7902W controller provides 320MB/sec maximum data throughput per channel available.

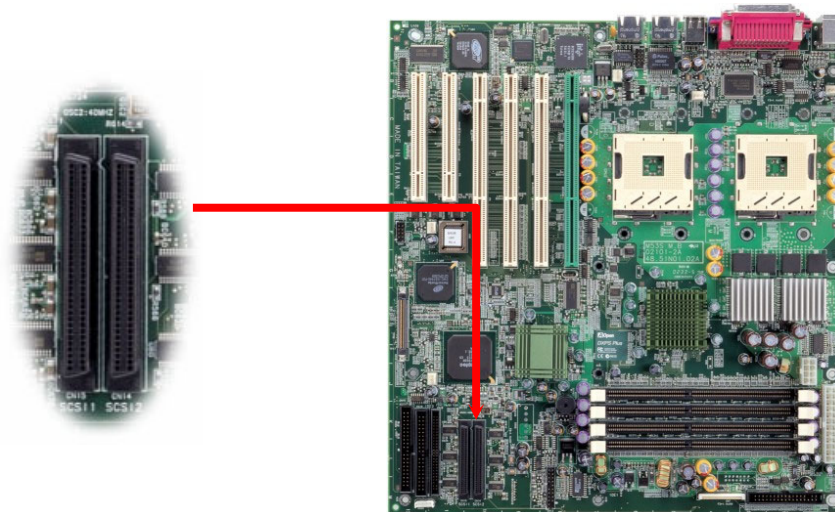

## **ZCR (Zero Channel RAID) Function (DXPS Plus / DXPS Plus-U)**

A ZCR card is a PCI card that allows a RAID card to use the onboard SCSI chip, thus lowering cost of RAID solution. A "Zero-channel" RAID adapter is a PCI RAID controller that doesn't have any SCSI channels on board. Instead, it is designed to use the on-board SCSI channels of the motherboard to implement a cost-effective Hardware RAID solution. Please be informed that only the first PCI slot supports ZCR function. (DXPS Plus/DXPS Plus-U)

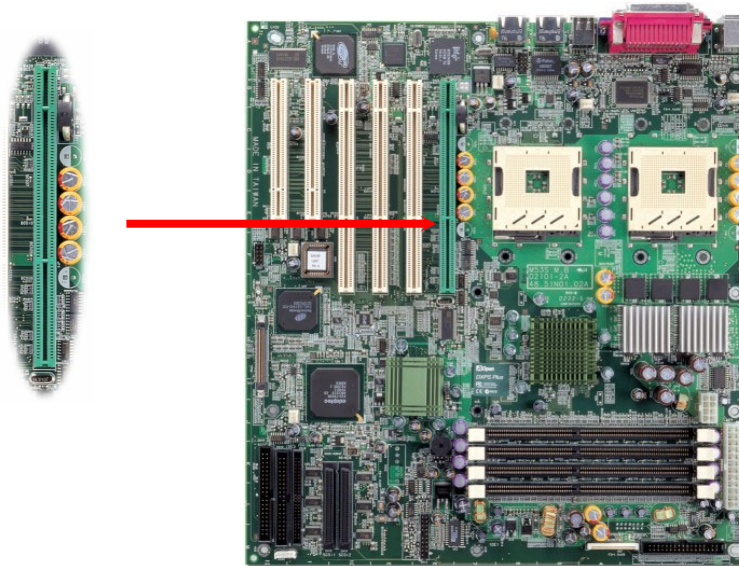

## Connecting COM2 Connector

This motherboard comes with a COM1 connector on the back panel. However, we provide an extra COM2 connector for your convenience. Once you need to connect a device via COM2, just connect a suitable cable on it.

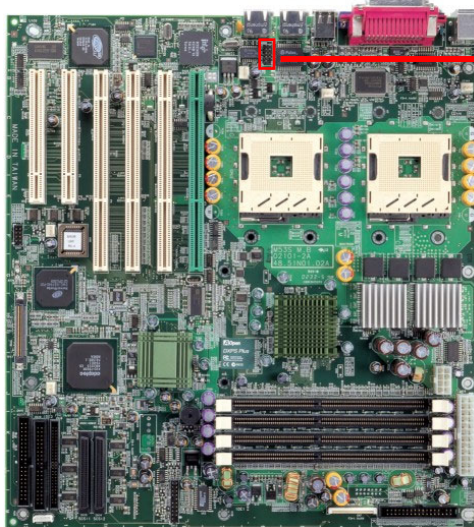

	1	2	
DCD#	●	●	SIN
SOUT	●	●	DTR#
GND	●	●	DSR#
RI#	●	●	CTS#
RTS#	●	□	NC



COM2  
Connector

## Connecting IPMB Connector

IPMB offers good support for communication with on-board devices that are accessed on an occasional basis. IPMB's competitive advantage over other low-speed short-distance communication schemes is that its cost and complexity don't scale up with the number of devices on the bus. The IPMB connector comes with foolproof design, please connect it with correct orientation.



IPMB Connector

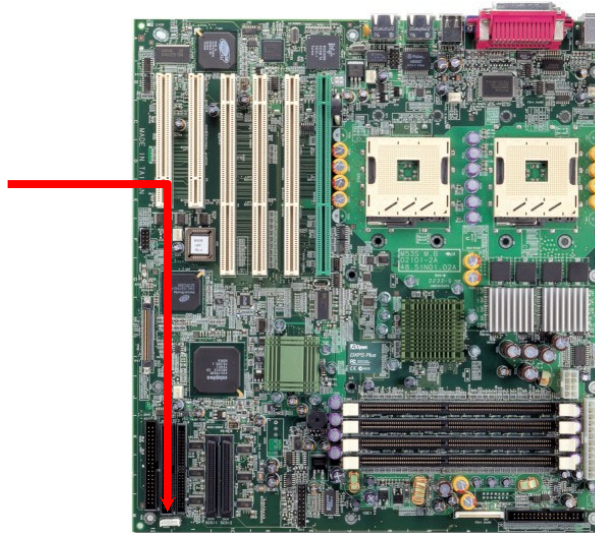

## **JP1 Check Password Jumper**

This motherboard provides check password function. You can use JP1 to enable or disable this function, which could prevent your system from unauthorized invasion. The factory default setting is set to "Disable"(2-3), and you may enable this function by setting the jumper to 1-2.

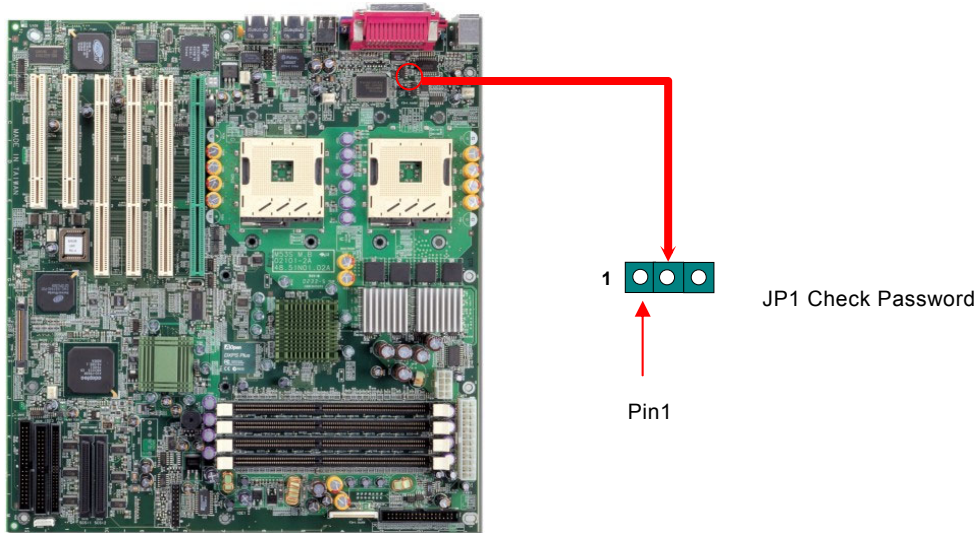



## **Support Two USB1.1 Channels (four Ports)**

This motherboard provides two [USB](#) channels to link USB devices, such as mouse, keyboard, modem, printer, etc. There are two connectors on the PC99 back panel. You can use proper cable to connect other USB connectors to the back panel or front panel of chassis.

	1	2	
USBPWR0			USBPWR0
USB_FP_P0-			USB_FP_P1-
USB_FP_P0+			USB_FP_P1+
GND			GND
KEY			NC

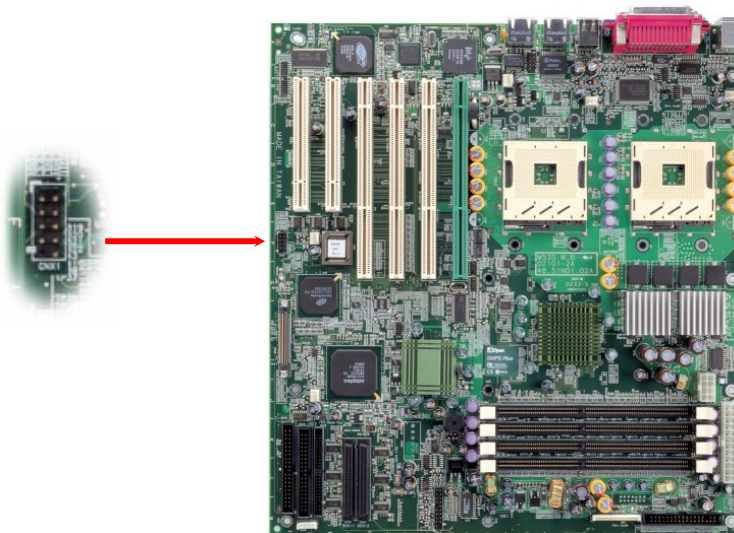

## **Support 10/100 Mbps and 1Gbps LAN onboard**

The Intel 82545EM integrates Intel's fourth-generation Gigabit MAC design with fully integrated, physical-layer circuitry to provide a standard IEEE 802.3 Ethernet interface for 1000BASE-T and 100BASE-TX applications. The left green LED indicates the link mode, it lights when linking to network and blinking when transferring data. The right green LED indicates the transfer mode, and it lights when data is transferring in 1Gbps/100Mbps mode.

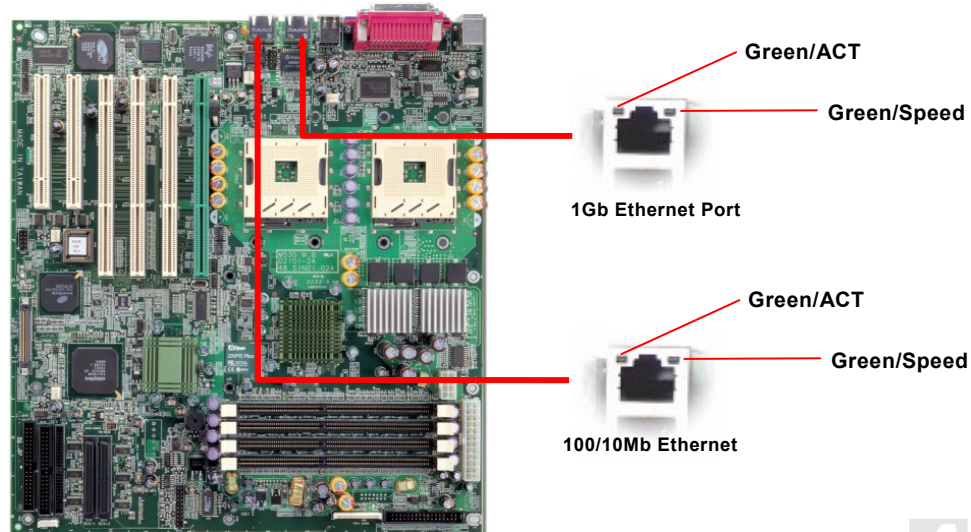



## **Connecting IPMI connector (Optional)**

Intelligent Platform Management Interface (IPMI) is a hardware level interface specification, defines a message-based interface to platform monitoring and control function. IPMI's monitoring abilities enable user to monitor server physical health characteristics such as temperature, voltage, fans, power supplies and chassis. (Optional)

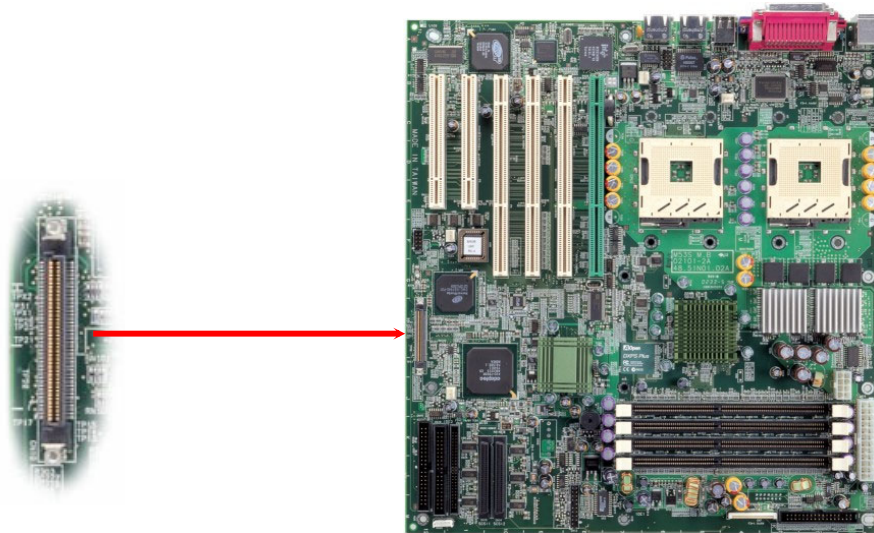

## **Resettable Fuse**

Traditional motherboard uses fuses to prevent Keyboard and [USB](#) port from over-current or shortage. These fuses are soldered onboard that when it is broken (function to protect motherboard), user cannot replace them and result in malfunction of motherboard.

With expensive Resettable Fuse, the motherboard can be resumed back to normal function even after the fuse had done its protection job.

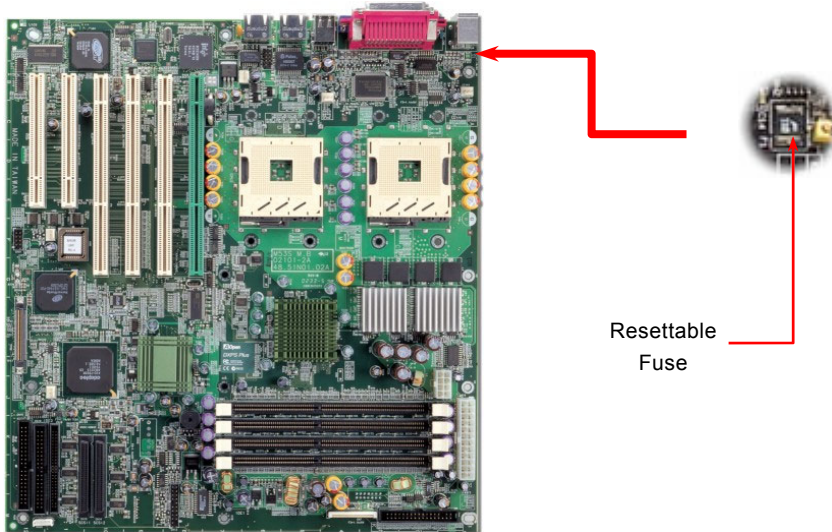

## **Low ESR Capacitor**

The quality of low ESR capacitor (Low Equivalent Series Resistance) during high frequency operation is very important for stability of CPU power. The location of where to put these capacitors is another know-how that requires experience and detail calculation.

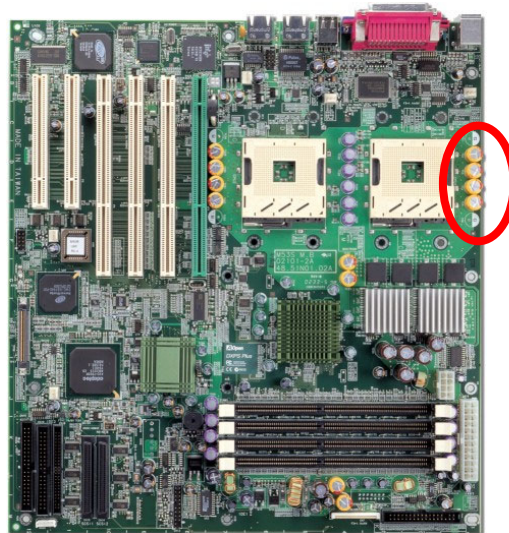

## Driver and Utility

There are motherboard drivers and utilities included in [AOpen Bonus CD](#). You don't need to install all of them in order to boot your system. But after you finish the hardware installation, you have to install your operation system first before you can install any drivers or utilities. Please refer to your operation system's installation guide.

## **BIOS Setup Utility**

Most of system had already configured by the manufacturer or the dealer. There is no need to run BIOS setup program when starting the computer unless you get a run setup program message.

The setup program loads configuration values into the battery-backed nonvolatile memory called CMOS RAM. This memory area is not part of the system RAM.



**If you repeatedly receive Run Setup messages, the battery may be bad. In this case, the system cannot retain configuration values in CMOS. Ask a qualified technician for assistance.**

The system will reboot immediately after you exit Setup.

## ***Entering Setup***

To enter Setup, press the DELETE key.



**You must press DELETE while the system is booting. This key does not work during any other time.**

The Setup Utility Main Menu appears:

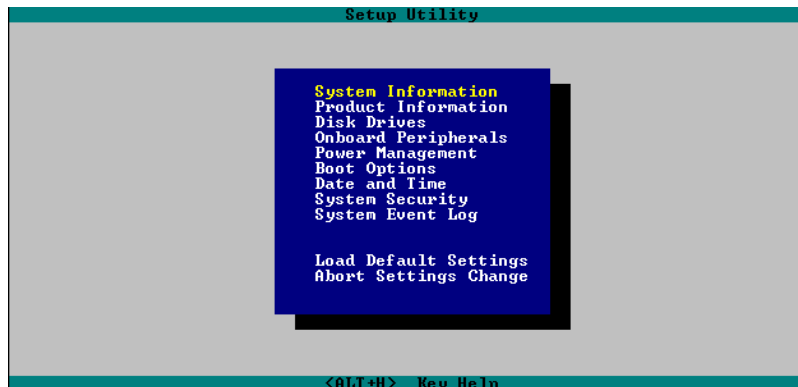

The system supports two BIOS Utility levels: Basic and Advanced.

If you are an advanced user, you may want to check the detailed configuration of your system.

Detailed system configurations are contained in the Advanced Level. To view the Advanced Level, press **F8**.







The asterisk (\*) mark indicates that the parameter appears only when you are in the Advanced Level.

The parameters on the screens show default values.

These values may not be the same as those in your system.

**The grayed items on the screens have fixed settings and are not user-configurable.**

Use the arrow keys  and  to move around the Setup Utility screen.

Use  to move to the next page or  to return to the previous page if the setup screen has more than one page available.

Use , , "+" or "-" to select the options if they are available.

Press  to return to the Main menu.



## System Information

The following screen appears if you select System Information from the Main menu:

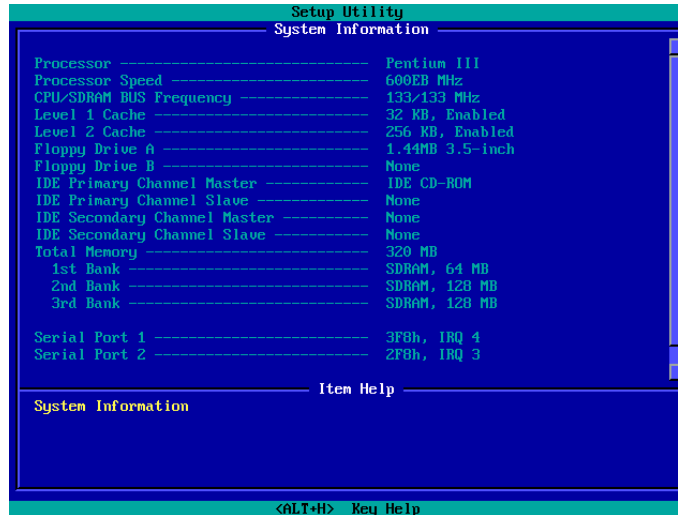

The System Information menu shows the current basic configuration of your system.

The sections below explain the parameters.

### **Processor**

The Processor parameter specifies the type of processor currently installed in your system. The system supports Intel Xeon™ 1.8 GHz above.

### **Processor Speed**

The Processor Speed parameter specifies the speed of the processor currently installed in your system.

### **CPU/SDRAM BUS Frequency**

This parameter specifies the currently FSB (Front Side Bus) frequency of the CPU/SDRAM.

### **Level 1 Cache**

This parameter specifies the first-level or the internal fast accessed memory (i.e., the memory integrated into the CPU) size, and whether it is enabled or disabled.

### **Level 2 Cache**

This parameter specifies the second-level cache memory size that comes with the CPU. The available cache size is 256/512 KB.

### **Diskette Drive A**

This parameter specifies the system's current diskette drive A settings.

### **Diskette Drive B**

This parameter specifies the system's current diskette drive B settings.

### **IDE Primary Channel Master**

This parameter specifies the current configuration of the IDE device connected to the master port of the primary IDE channel.

### **IDE Primary Channel Slave**

This parameter specifies the current configuration of the IDE device connected to the slave port of the primary IDE channel.

### **Total Memory**

This parameter specifies the total amount of onboard memory. The memory size is automatically detected by BIOS during the POST. If you install additional memory, the system automatically adjusts this parameter to display the new memory size.

### **1st Bank/2nd Bank/3rd Bank/4th Bank**

The 1st Bank, 2nd Bank, 3rd Bank, and 4th Bank parameters indicate the type and size of DRAM

installed in DIMM sockets 1, 2, 3 and 4 respectively. The **“None”** setting indicates that there is no DRAM installed.

### **1<sup>st</sup>/2<sup>nd</sup>/3<sup>rd</sup> /4<sup>th</sup> Bank**

Type and Size of DRAM installed in DIMM socket 1, 2, 3 and 4 respectively. The **“None”** setting indicates that there is no DRAM installed.

### **Serial Port 1**

This parameter shows the serial port 1 address and IRQ setting.

### **Serial Port 2**

This parameter shows the serial port 2 address and IRQ setting.

### **Parallel Port**

This parameter shows the parallel port address and IRQ setting.

### **PS/2 Mouse**

The BIOS utility automatically detects if there is a pointing device connected to your system. If there is, this parameter displays the **“Installed”** setting. Otherwise, this is set to **“None”**.

## ***Product Information***

The Product Information contains the general data about the system, such as the product name, serial number, BIOS version, etc. This information is necessary for troubleshooting (may be required when asking for technical support).

The following shows how the Product Information screen appears:

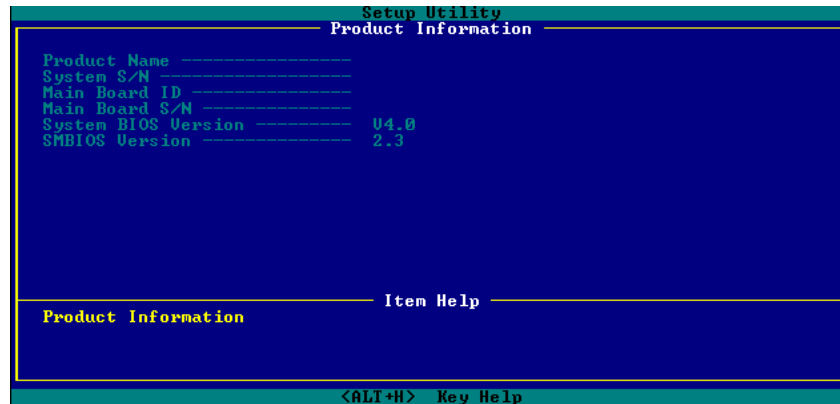

### Product Name

This parameter specifies the official name of the system.

### System S/N

This parameter specifies the system's serial number.

**Main Board ID**

This parameter specifies the motherboard's identification number.

**Main Board S/N**

This parameter specifies the motherboard's serial number.

**System BIOS Version**

This parameter specifies the version of the BIOS utility.

**SMBIOS Version**

This parameter specifies the version of the SMBIOS version.

***Disk Drives***

Select Disk Drives to input configuration values for disk drives.

The following screen shows the Disk Drives menu:

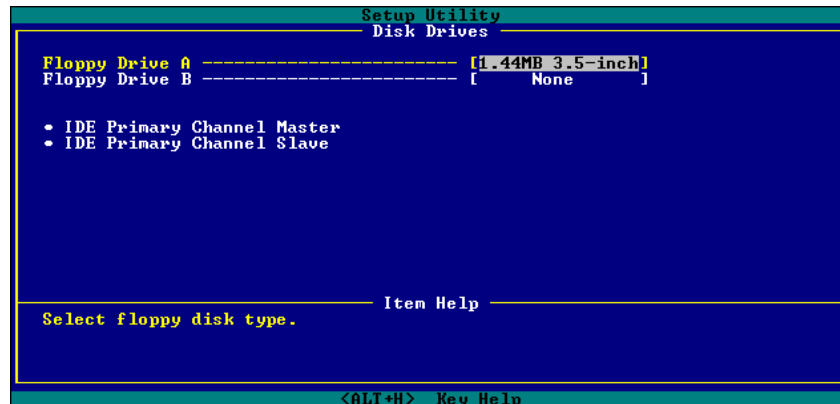

## Floppy Drives

To enter the configuration value for the first floppy drive, highlight the Floppy Drive A parameter. Press **[PGUP]** or **[PGDN]** key to view the options and select the appropriate value.

**Drive A/Drive B**

These items select the floppy drive type. The available settings and types



None

360KB 5.25"

1.2MB 5.25"

720KB 3.5"

1.44MB 3.5"

2.88MB 3.5"

supported by the motherboard are listed to the left.

Follow the same procedure to configure floppy drive B. Choose "**None**" if you do not have a second floppy drive.

## IDE Drives

To configure the IDE drives connected to your system, select the parameter that represents the channel and port where the desired hard disk to configure is connected. The options are:

IDE Primary Channel Master

This option lets you configure the hard disk drive connected to the master port of IDE channel 1.

**IDE Primary Channel Slave**

This option lets you configure the hard disk drive connected to the slave port of IDE channel 1.

The following screen appears if you select any of the IDE Drive parameters:

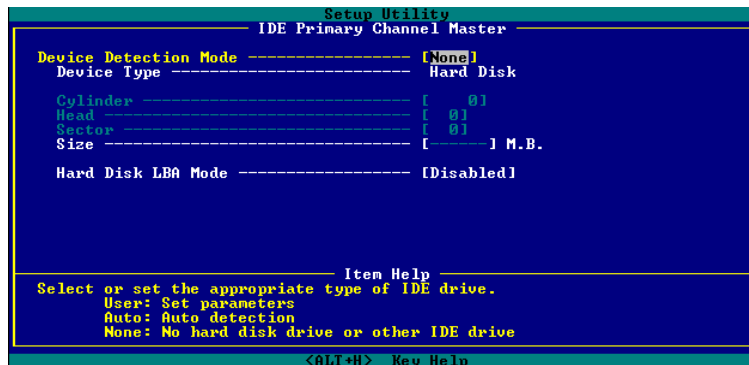

## Device Detection Mode

### Device Detection

#### Mode

Auto (Default)

User

None

If you select "Manual", you need to fill in all remaining field, such as Cylinder, Head, and Sector on this selected item. If the item "Auto" is selected, the items will remain "0". And when the system boot up, system will detect the hard disk and configure it automatically. "None" means there is no device in the channel.

## Device Type

This parameter shows which type of IDE drive currently used.

**Cylinder**

This parameter specifies the number of cylinders of your hard disk, and is automatically set depending on your Type parameter setting.

**Head**

This parameter specifies the number of heads of your hard disk, and is automatically set depending on your Type parameter setting.

**Sector**

This parameter specifies the number of sectors of your hard disk, and is automatically set depending on your Type parameter setting.

**Size**

This parameter specifies the size of your hard disk, in MB.

**Hard Disk LBA Mode**

<b><u>Hard Disk Block</u></b>
<b><u>Mode</u></b>

This function enhances disk performance depending on the hard disk in use. If you set this parameter to **“Auto”**, the BIOS utility automatically

Auto (Default)

Disabled

detects if the installed hard disk drive supports the Block Mode function. If supported, it allows data transfer in blocks (multiple sectors) at a rate of 256 bytes per cycle. To disregard the feature, change the setting to **“Disable”**.

## ***Onboard Peripherals***

The Onboard Peripherals Configuration allows you to configure the onboard communication ports and the onboard devices. Selecting this option displays the following screen:

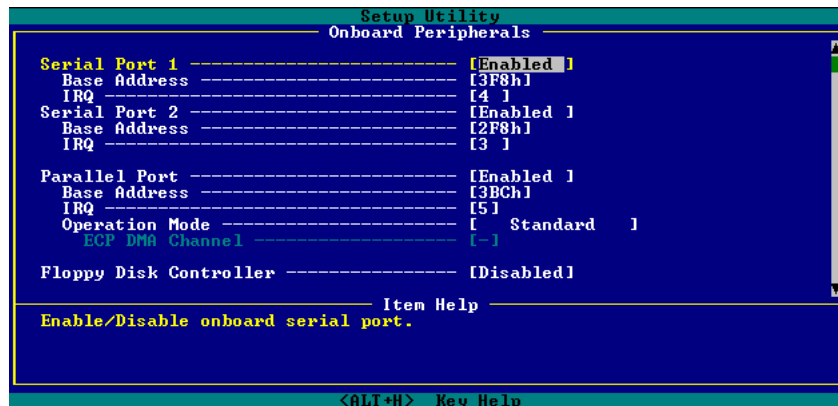

This page is the lower half of Onboard Peripherals submenu.

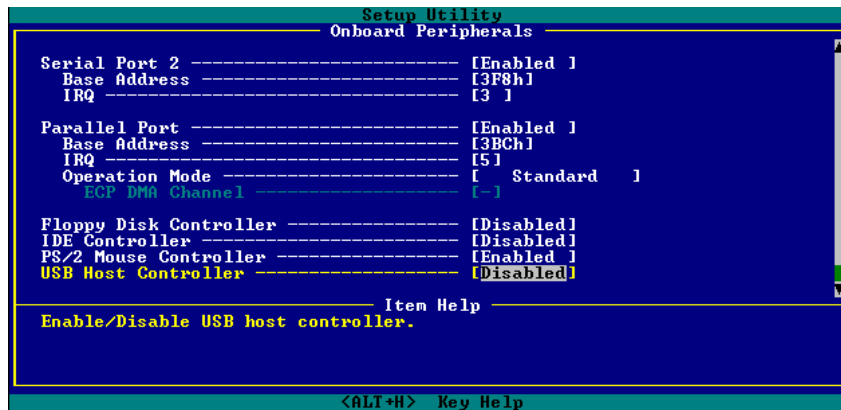

## Serial Ports 1 and 2

### Serial Port 1 & 2

Enabled (Default)

Disabled

These parameters allow you to enable or disable serial ports 1 and 2.

Base Address

**Base Address**

Serial Port 1:

3F8h (Default)

3E8h

2E8h

Serial Port 2:

2F8h (Default)

2E8h

3E8h

This item allows you to assign address and interrupt for the board serial port.

IRQ

**IRQ**

Serial Port 1:

4 (Default), 11

Serial Port 2:

3 (Default), 10

This function lets you assign an interrupt for serial ports 1 and 2. The options for serial ports 1 are IRQ 4 and 11. The options for serial port 2 are IRQ 3 and 10.



The Base Address and IRQ parameters for each port are configurable only if the port is enabled.

### Parallel Port

**Parallel Port**

Enabled (Default)

Disabled

This parameter allows you to enable or disable the parallel port.

#### Base Address

**Base Address**

378h (Default)

3BCh

278h

This item allows you to assign address and interrupt for the board serial port.

#### IRQ



**IRQ**

7 (Default), 5

This function lets you assign an interrupt for the parallel port. The options are IRQ 5 and 7.



The Base Address and IRQ parameters are configurable only if Parallel Port is enabled.

If you install an add-on card that has a parallel port whose address conflicts with the onboard parallel port, a warning appears on the screen.

Check the parallel port address of the add-on card and change the address to one that does not conflict.

## Operation Mode

**Operation Mode**

EPP (Default)

Bi-Directional

Standard

ECP

This item lets you set the parallel port mode. The mode options are Standard, Bi-directional, EPP (Enhanced Parallel Port) and ECP (Extended Parallel Port).

Setting

Function

Setting	Function
Standard Parallel Port (Standard)	Allows normal speed one-way operation
Bi-directional Parallel Port (Bi-directional)	Allows normal speed operation in a two-way mode
Enhanced Parallel Port (EPP)	Allows bi-directional parallel port operation at maximum speed
Extended Capabilities Port (ECP)	Allows parallel port to operate in bi-directional mode and at a speed higher than the maximum data transfer rate

## ECP DMA Channel

**ECP Mode Use DMA**

3

1 (Default)

This item becomes active only if you select Extended Capabilities Port (ECP) as the operation mode. It allows you to assign DMA channel 1 or DMA channel 3 for the ECP parallel port function (as required in Windows 95).

### **Onboard Device Settings**

The Onboard Device Settings menu allows you to configure the onboard communication ports and the onboard devices. Selecting this option from the Onboard Peripherals menu displays the following screen:

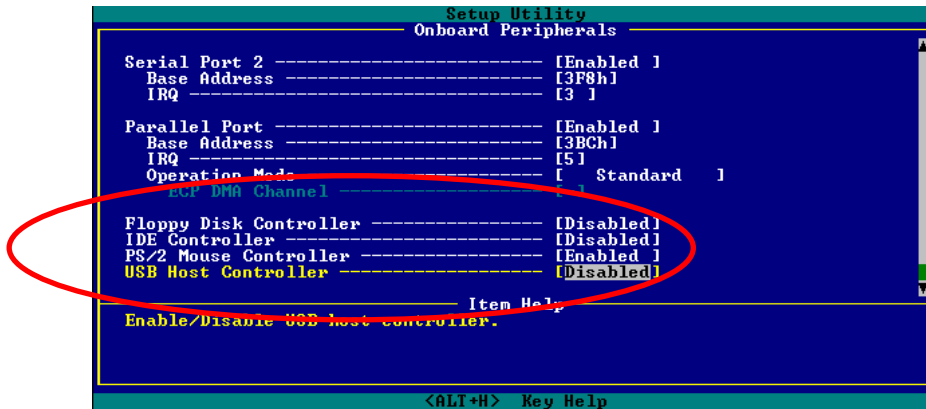

Floppy Disk Controller

**Floppy Disk**

**Controller**

Enabled (Default)

Disabled

This parameter lets you enable or disable the onboard floppy disk controller.

IDE Controller

**IDE Controller**

Both (Default)

Primary

Disabled

Set this parameter to “**Primary**” to enable only the primary IDE controller; “**Both**” to enable both primary and secondary IDE controllers; or “**Disabled**” to disable all IDE controllers.

PS/2 Mouse Controller

**PS/2 Mouse**

**Controller**

Enabled (Default)

Disabled

This parameter enables or disables the onboard PS/2 mouse controller.

USB Host Controller

**USB Host  
Controller**

Enabled (Default)  
Disabled

This parameter lets you enable or disable the USB controller on board. When enabled, it activates the USB function of the system. When disabled, it deactivates the function.

USB Legacy Mode

**USB Legacy Mode**

Enabled  
Disabled (Default)

This parameter lets you enable or disable the USB controller on board. When enabled, it activates the USB function of the system. When disabled, it deactivates the function.

On-board SCSI

**On-board SCSI**

Enabled (Default)  
Disabled

This parameter lets you enable or disable the SCSI controller on board. When enabled, it activates the SCSI function of the system. When disabled, it also deactivates the function.

Onboard Ethernet Chip



**On-board****Ethernet Chip**

Enabled (Default)

Disabled

This parameter allows you to enable or disable the onboard network feature.

## ***Power Management***

The Power Management menu allows you to configure the system power-management feature. The following screen shows the Power Management parameters and their default settings:

```
Setup Utility
Power Management

Power Management Mode ----- [Enabled ]
IDE Hard Disk Standby Timer ----- [OFF]
System Sleep Timer ----- [OFF]
Sleep Mode ----- [-----]

Power Switch < 4 sec. ----- [ Suspend ]

System wake-up event
Modem Ring Indicator ----- [Disabled]
PCI Power Management ----- [Disabled]
RTC Alarm ----- [Disabled ]
Resume Day ----- [--]
Resume Time ----- [--:--:--]
Restart on AC/Power Failure ----- [ Enabled ]

----- Item Help -----
Select <Enabled> to reduce power consumption or <Disabled> to
deactivate the power management features and timers.

<ALT+H> Key Help
```

This page is the lower half of Power Management submenu.



```

Setup Utility
Power Management
-----
Power Management Mode ----- [Enabled ]
IDE Hard Disk Standby Timer ----- [OFF]
System Sleep Timer ----- [OFF]
Sleep Mode ----- [-----]
Power Switch < 4 sec. ----- [Power Off]
System wake-up event
Modem Ring Indicator ----- [Disabled]
PCI Power Management ----- [Disabled]
RTC Alarm ----- [Date/Time]
Resume Day ----- [ 1 ]
Resume Time ----- [00:00:00]
Restart on AC/Power Failure ----- [* Enabled ]

Item Help
-----
When power failure occurs and this setting is <Enabled> / <Disabled> /
<Pre-state>, the system turns on/turns off/maintains last power state
when the power comes back.

<ALT+H> Key Help

```



A parameter with an asterisk (\*) mark indicates that the parameter appears only when you are using in the **Advanced Level**. See “**Entering Setup**” on Page

## Power Management Mode

<b><u>Power Management Mode</u></b> Enabled (Default) Disabled
--

This parameter allows you to reduce power consumption. When this parameter is set to “**Enabled**”, you can configure the IDE hard disk and system timers. Setting it to “**Disabled**” deactivates the power-management feature and its timers.

## IDE Hard Disk Standby Timer

<b><u>IDE Hard Disk Standby Timer</u></b> Off (Default) 1 to 15min
--

This parameter allows the hard disk to enter standby mode after inactivity of **1 to 15** minutes, depending on your setting. When you access the hard disk again, allow 3 to 5 seconds (depending on the hard disk) for the disk to return to normal speed. Set this parameter to “**Off**” if your hard disk does not support this function.

## System Sleep Timer

**System Sleep****Timer**

Off (Default)

120, 110, 100...20,

15, 10, 5, 2min

This parameter sets the system to the lowest power-saving mode after a specified period of inactivity. Any keyboard or mouse action or any activity detected from the IRQ channels resumes system operation.

**Sleep Mode****Sleep Mode**

Standby

Suspend (Default)

This parameter lets you specify the power-saving mode that the system will enter after a specified period of inactivity. The options are “**Standby**” and “**Suspend**” modes. This parameter becomes configurable only if the System Sleep Timer is enabled. Any keyboard or mouse action, or any enabled monitored activities occurring through the IRQ channels resume system operation.

### Power Switch < 4 sec.

**Power Switch < 4  
Sec.**

Suspend

Power Off (Default)

When set to "**Power Off**", the system automatically turns off when the power switch is pressed for less than 4 seconds. When set to "**Suspend**", the system enters the suspend mode when pressed for less than 4 seconds.

### System Wake-up Event

The system wake-up event allows the system to resume operation when the modem ring indicator is enabled.

#### Modem Ring Indicator

**Modem Ring  
Indicator**

Enabled

Disabled (Default)

When "**Enabled**" any fax/modem activity wakes up the system from suspend mode. The default setting is "**Disabled**".

#### PCI Power Management

**PCI Power Management**

Enabled (Default)  
Disabled

This item allows you to enable or disable the PCI power management function.

**RTC Alarm**

**RTC Alarm**

Enabled  
Disabled (Default)

This item allows you to set a certain time on a certain day to wake-up the system from suspend mode.

**Resume Day**

**Resume Day**

1 to 31

This item is displayed when you enable the “**RTC Timer**” option. Here you can specify what date you want to wake up the system. For example, setting to 15, the system will wake up on the 15<sup>th</sup> day of every month.

**Resume Time**

**Resume Time**

Hh:mm:ss

This item is displayed when you enable the RTC Wake Up Timer option. Here you can specify what time you want to wake up the system.

**Restart On AC/Power Failure****Restart On****AC/Power Failure**

Enabled

Disabled (Default)

Pre-State

When “**Enabled**”, the system automatically turns on when the power comes back. When “**Disabled**” the system turns off and does not turn on when the power comes back. When set to “**Pre-State**”, the system maintains the last power state when the power comes back.

## Boot Options

This option allows you to specify your preferred setting for boot up.

The following screen appears if you select Boot Options from the Basic Configuration menu:

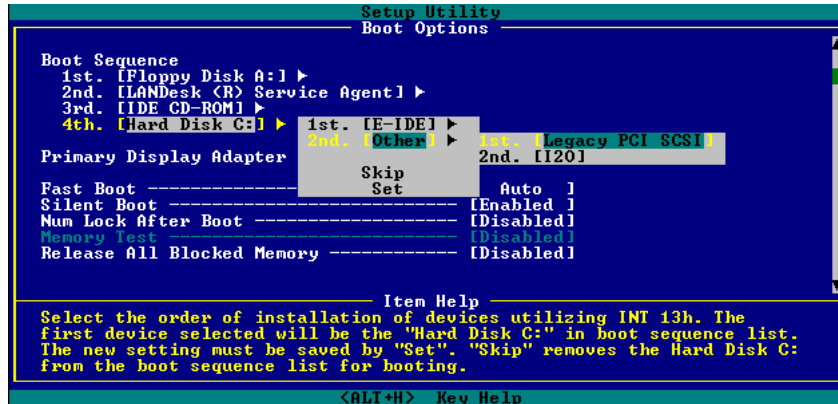

## Boot Sequence

This parameter allows you to specify the boot search sequence during POST.

- 1<sup>st</sup>. The system checks this drive first.
- 2<sup>nd</sup>. The system then checks this drive if it can not boot from the 1<sup>st</sup> specified drive.
- 3<sup>rd</sup>. If the 1<sup>st</sup> and 2<sup>nd</sup> searches fail then it boots from this drive.
- 4<sup>th</sup>. If the 1<sup>st</sup>, 2<sup>nd</sup>, and 3<sup>rd</sup> searches fail then it boots from this drive.

BIOS will display an error message if the drive(s) specified is not bootable.

## Primary Display Adapter

### **Primary Display Adapter**

Auto

Onboard (Default)

This parameter lets you activate the onboard video controller as your primary display adapter, or automatically disable it once BIOS detects that there is a video card installed in your system.

## Fast Boot

### **Fast Boot**

Auto (Default)

Disabled

This parameter allows the system to boot faster by skipping some POST routines.



## Silent Boot

### Silent Boot

Enabled (Default)

Disabled

This parameter enables or disables the Silent Boot function. When set to "**Enabled**", BIOS is in graphical mode and displays only an identification logo during POST and while booting. After booting the screen displays the operating system prompt (such as DOS) or logo (such as Windows 95). If any error occurs while booting, the system automatically switches to the text mode.

Even if your setting is "**Enabled**", you may also switch to the text mode while booting by pressing  when you see the "**Press DELETE key to enter setup**" message on the screen.

When set to "**Disabled**", BIOS is in the conventional text mode where you see the system initialization details on the screen.

## Num Lock After Boot

### Num Lock After Boot

Enabled (Default)

Disabled

This parameter allows you to activate the Num Lock function upon booting.

### Memory Test

**Memory Test**

Enabled

Disabled (Default)

When set to "**Enabled**", this parameter allows the system to perform a RAM test during the POST routine. When set to "**Disabled**", the system detects only the memory size and bypasses the test routine.

### Release All Blocked Memory

**Release All**

**Blocked Memory**

Enabled

Disabled (Default)

When set to "**Enabled**", this parameter allows system to bypass testing the defective memory banks detected earlier.

## Date and Time

The real-time clock keeps the system date and time. After setting the date and time, you do not need to enter them every time you turn on the system. As long as the internal battery remains good (approximately seven years) and connected, the clock continues to keep the date and time accurately even when the power is off.

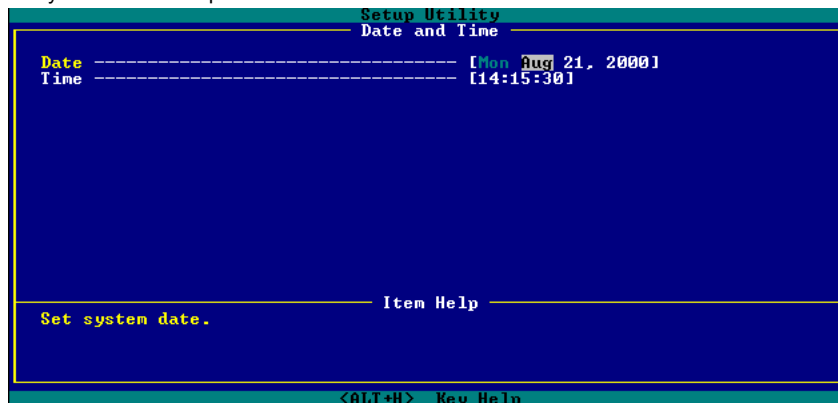

## Date

### Date

ww:mm:dd:yy

Highlight the items on the Date parameter and press  or  to set the date following the weekday-month-day-year format.

Valid values for weekday, month, day, and year are:

- Weekday: Sun, Mon, Tue, Wed, Thu, Fri, Sat
- Month: Jan, Feb, Mar, Apr, May, Jun, Jul, Aug, Sep, Oct, Nov, Dec
- Day: 1 to 31
- Year: 1980 to 2079

## Time

### Time

hh:mm:ss

Highlight the items on the Time parameter and press  or  to set the time following the hour-minute-second format.

Valid values for hour, minute, and second are:

- Hour 00 to 23
- Minute 00 to 59
- Second 00 to 59

## System Security

The Setup program has a number of security features to prevent unauthorized access to the system and its data.

The following screen appears if you select System Security from the Main menu:

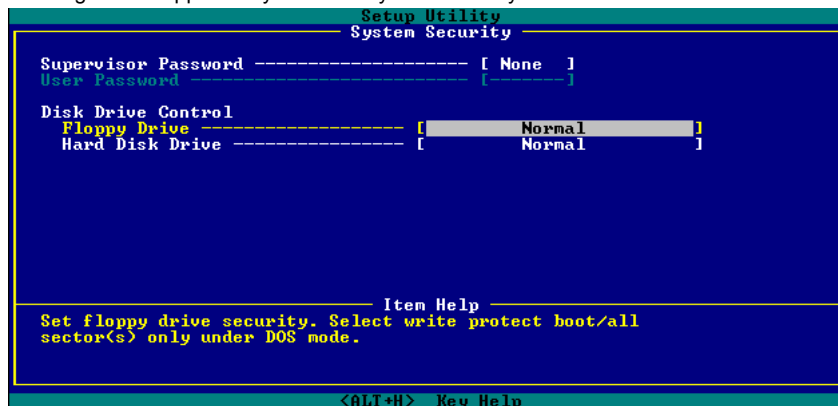

## Supervisor Password

### Supervisor

### Password

None (Default)

Present

This item can prevent unauthorized access to the BIOS utility.  
The "Present" setting allows you to set a setup password.

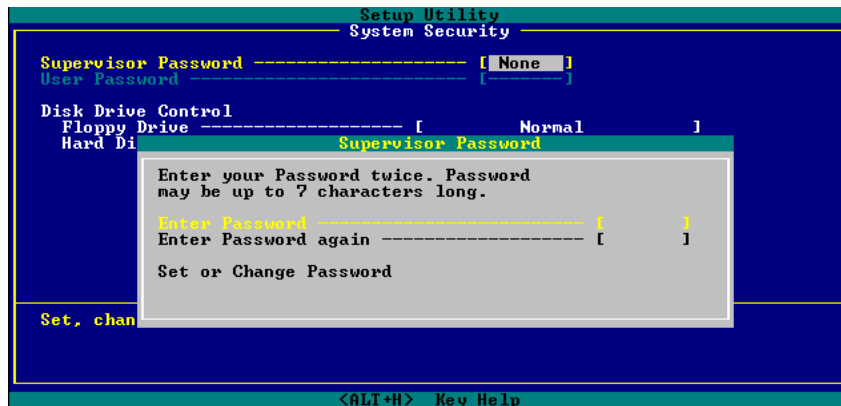

1. Enable the Supervisor Password parameter in the System Security menu by pressing the ENTER key. The Supervisor Password windows will appear as shown above.
2. Type a password. The password may consist of up to seven characters.



Be very careful when typing your password because the actual characters do not appear on the screen.

3. Press the ENTER key. Re-type the password to verify your first entry then press ENTER key again.
4. Highlight the “**Set or change password**” option and press ENTER key.
5. Press the ESC key to return the System Security screen.
6. Press the ESC key to exit setup. The Exit Setup screen will appear.
7. Choose “**Yes**” to save your setting and exit Setup. Your password will be saved to CMOS.
8. If you want to remove the password, please select “**Disabled**” to disable this function.

### User Password

<u>User Password</u>
None (Default)
Present

This item can secure your system against unauthorized use. Once you set this password, you have to type it whenever you boot the system. This item is available when only Supervisor Password is set.

## Disk Drive Control

The disk drive control features allow you to control the floppy drive or the hard disk drive boot function to prevent loading operating systems or other programs from a certain drive while the other drives are operational (under DOS mode only).

The table below lists the drive control settings and their corresponding functions.

Floppy Drive	
Setting	Description
Normal	Floppy drive functions normally
Write Protect All Sectors	Disables the write function on all sectors
Write Protect Boot Sector	Disables the write function only on the boot sector
Hard Disk Drive	
Setting	Description
Normal	Hard disk drive functions normally
Write Protect All Sectors	Disables the write function on all sectors



Write Protect Boot Sector	Disables the write function only on the boot sector
---------------------------	---

## **System Event Log**

The system event log enables you to record and monitor events that occurs in your system like system temperature, fan stops, and others. This feature allows you to specify the appropriate settings for your system's event handling. Selecting the option displays the following screen:

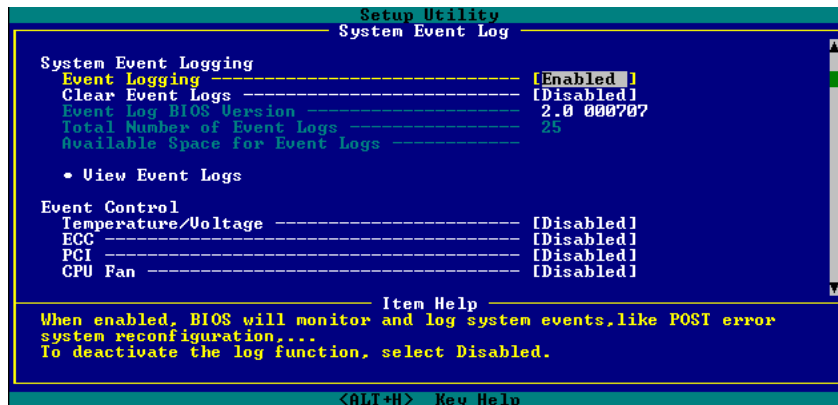

This page is the lower half of System Event Log submenu.

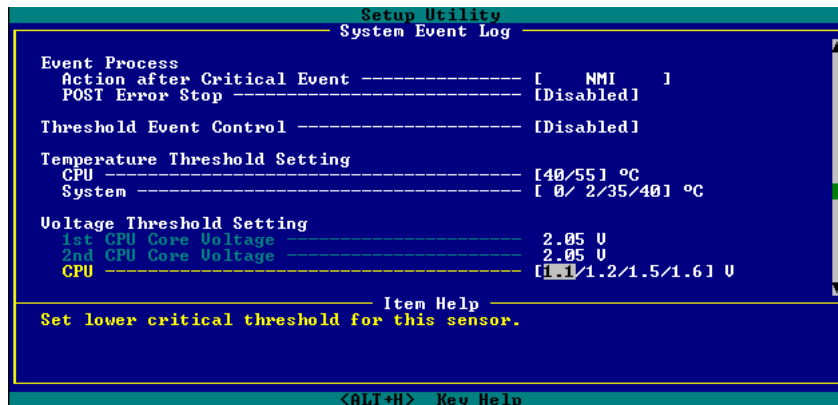

## System Event Logging

This option allows you to record monitored events that occur during the operation of your system.

**Event Logging**

**Event Logging**

Enabled (Default)

Disabled

This item allows you to enable or disable the system event logging function.

**Clear Event Logs**

**Clear Event Logs**

Enabled

Disabled (Default)

This item allows you to enable or disable the system event logs clearing function. Please enable it if you want to clear the event log whenever the event log area is full.

**Event Log BIOS Version**

**Event Log BIOS  
Version**

This parameter specifies the version of the Event Log BIOS.

**Total Number of Event Logs**

**Total Number of  
Event Logs**

The currently number of events located in the event log area.

**Available Space for Event Logs**

**Available Space  
for Event Logs**

The percentage of space that is still available for logging system events.

**View Event Logs**

**View Event Logs**

Opens the system event log file for viewing.

**Events Control**

This parameter monitors the following events and logs them into the event log file if there is a change in status.

**Temperature/Voltage/Fan**

**Temperature/Voltage/Fan**

Enabled (Default)  
Disabled

Enable or disable the monitoring of the system's temperature, voltage, and CPU fan.

**ECC**

**ECC**

Enabled (Default)  
Disabled

ECC or Error-Correcting Code tests the accuracy of data as it passes in and out of memory. This parameter enables or disables the monitoring of this function.

**PCI**

**PCI**

Enabled (Default)  
Disabled

PCI or Peripheral Component Interconnect is a 32-bit bus that can run at clock speeds of 33 MHz. This parameter monitors the activity of this bus when set to enabled.

## Event Process

### Action After Critical Event

**Action After  
Critical Event**

NMI (Default)  
Power Cycle  
Reset

This parameter allows you to select the action after BIOS finds a critical event. The critical events include multiple bits ECC error and PCI device error.

### POST Error Stop

**Post Error Stop**  
Enabled (Default)  
Disabled

BIOS checking the bad CPUs and memory modules during POST. When this parameter is enabled, BIOS will stop POST operation whenever it finds a bad CPU or memory. Otherwise, if disabled the system will continue running.

### Threshold Event Control

<b><u>Threshold Event Control</u></b> Enabled Disabled (Default)	This parameter lets you enabled or disabled the threshold event control function.
--	---

### Temperature Threshold Setting

#### CPU

<b><u>CPU</u></b> User Input	This item allows you to set the CPU critical temperature value.
---------------------------------	---

#### System

<b><u>System</u></b> User Input	This item allows you to set the system critical temperature value.
------------------------------------	--





### **Voltage Threshold Setting**

<p><b><u>Voltage Threshold</u></b> <b><u>Setting</u></b></p>
--

CPU

This parameter lets you setting CPU core voltage lower critical threshold value.

## Load Default Settings

Use this option to load the default settings for the optimized system configuration. When you load the default settings, some of the parameters are grayed-out with their fixed settings. These grayed parameters are not user-configurable.

The following dialog box appears when you select Load Default Settings from the main menu:

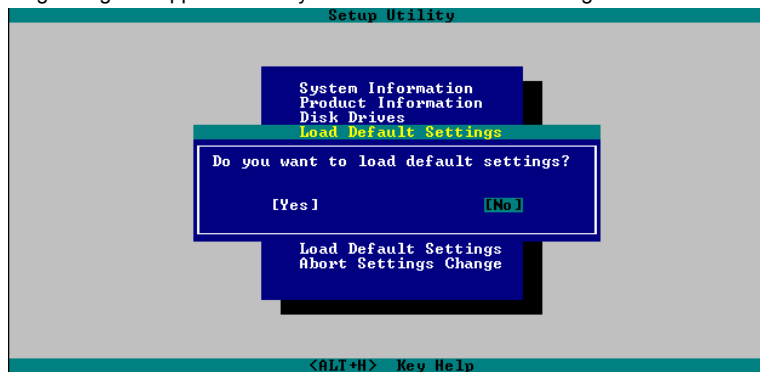

Select **"Yes"** to load the default settings.

Select **"No"** to ignore the message and return to the BIOS utility.

## Abort Settings Change

Use this option to disregard your changes to the BIOS and reload your previous settings.

The following dialog box appears when you select Abort Settings Change from the main menu:

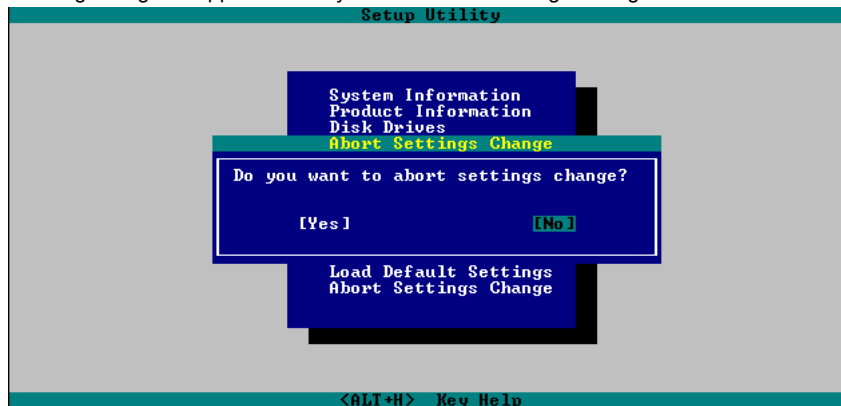

Select **"Yes"** to disregard your changes and reload your previous settings. After reload, the main menu appears on screen.

Select **"No"** to ignore the message and return to the BIOS utility.

# SCSISelect™ Utility

The SCSISelect™ utility allows you to change SCSI controller settings without opening the system or changing jumpers.

The table below lists the settings that you can change using the SCSISelect™ utility and the default value for each setting. Some settings apply globally to the SCSI controller and all SCSI devices on the bus. Other settings apply individually to each device on the bus.

**Settings for the SCSI Controller and All Devices**

Item	Default
Host Adapter SCSI ID	7
SCSI Parity Checking	Enabled
Host Adapter SCSI Termination	Enabled
Boot Device Option	0 (zero)
Host Adapter BIOS*	Enabled
Support Removable Disks under BIOS as Hard Disks	Boot only
Extended BIOS Translation for DOS Drives > 1 GB	Enabled
Display <Ctrl-A> Message During BIOS Initialization	Enabled
Multiple LUN Support	Disabled
BIOS Support for Bootable CD-ROM	Enabled
Item	Default
BIOS Support for Int13 Extensions	Enabled
Support for Ultra SCSI Speed	Disabled

---

\* **Some settings are valid only if the host adapter BIOS is enabled.**

### Individual Settings for SCSI Drives

Item	Default
Initiate Sync Negotiation	Yes
Maximum Sync Transfer Rate	160MB/sec.
Enable Disconnection	Yes
Send Start Unit SCSI Command*	No
Initiate Wide Negotiation	Yes

### When to Use the SCSISelect™ Utility

Use the SCSI Select utility if you need to do any one of the following:

- Change any of the default values listed in the SCSI Controller and All Devices Table.
- Check and/or change SCSI device settings that may conflict with those of other devices.
- Perform low-level formatting on new SCSI disk devices.

---

\* Some settings are valid only if the host adapter BIOS is enabled.



## Running the SCSISelect™ Utility

A screen message giving the option to access the SCSISelect™ utility appears after the BIOS and POST routine.

To start the utility, press  + A when the following message appears during power-on or system reset:

Press <Ctrl> <A> for SCSISelect™ Utility!



Your screen may show the key sequence as  + <Hot Key> instead of  + A. The correct sequence is  + A.

## **Utility Options**

When the SCSI Select utility detects that the AIC-7902W SCSI controller is in the system, it displays the following Options menu:

```
Adaptec AIC-7902W SCSISelect (TM) Utility v2.10

You have an AIC-7902W
SCSI host adapter in your sys
the cursor to the bus:device:c
the one to be configured and
press <Enter>

Bus:Device:Channel
02:09:A
02:09:B

<F5> - Toggle color/monochrome

Arrow keys to move cursor, <Enter> to select option, <Esc> to exit (*=default)
```



## Configuring Channel A

The following screens appear if you select Channel A:





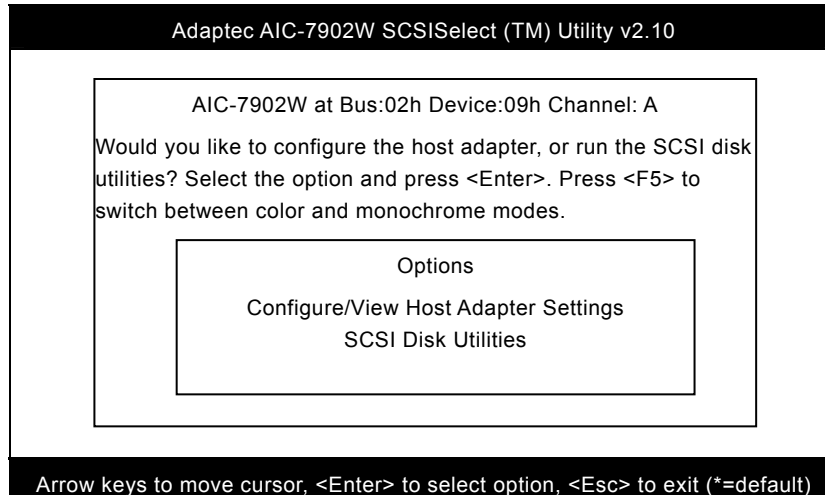

If you choose to configure Channel B, a similar SCSI Utility Screen will appear. The only difference is the I/O Port Address:

*A000h* for Channel A

A400h for Channel B



Using  and  and then press  to make selections in the SCSISelect™ utility. Press  at any time to return to the previous menu.



You can press  to toggle the display between color and monochrome modes.

This feature may not work with some kinds of monitors.

## Configure/View Host Adapter Settings Menu

The Configure/View Host Adapter Settings menu lists three settings under SCSI Bus Interface Definitions and three additional options.

```

Adaptec AIC-7902W SCSISelect (TM) Utility v2.10



AIC-7902W at Bus:02h Device:09h Channel:A

Configuration
SCSI Bus Interface Definitions
Host Adapter SCSI ID .....7
SCSI Parity Checking .....Enabled

Host Adapter SCSI Termination.....Enabled
Additional Options
Boot Device Options.....Press <Enter>
SCSI Device Configuration.....Press <Enter>
Advanced Configuration Options.....Press <Enter>

BIOS Information
Interrupt (IRQ) Channel.....11
I/O Port Address.....A000h
  
```

Arrow keys to move cursor, <Enter> to select option, <Esc> to exit (\*=default)

Using  and  to select a parameter. Press  to display a pop-up menu with a list of possible settings for the



parameter. Press  at any time to return to the previous menu.



SCSI controller default settings are marked with an asterisk (\*) throughout the selection submenus.

### **Host Adapter SCSI ID**

This parameter allows you to change the host controller SCSI ID. The following screen shows the available IDs used for the AIC-7902. The default setting is SCSI ID 7, which has the highest priority on the SCSI bus. We recommend that you keep the default setting since most system applications run only in this setting.





Adaptec AIC-7902W SCSISelect (TM) Utility v2.10

AIC-7902W at Bus:02h Device:09h Channel:A

Configuration	
SCSI Bus Interface Definitions	0
Host Adapter SCSI ID .....	1 .....7
SCSI Parity Checking .....	2 .....Enabled
	3
Host Adapter SCSI Termination .....	4 .....Enabled
	5
Additional Options	
Boot Device Options.....	6 .....Press
	*7
BIOS Info	
Interrupt (IRQ) Channel.....	8 .....11
	9
	10
	11

Arrow keys to move cursor, <Enter> to select option, <Esc> to exit (\*=default)

Each device on the SCSI bus, including the SCSI controller, must be set to a unique SCSI ID. The SCSI ID serves two purposes. It uniquely identifies each SCSI device on the bus, and it determines the device's priority on the bus during the arbitration phase. The arbitration phase determines which device controls the bus when two or more devices request for the use of it.

Using  and  then press  to select the SCSI ID if you need to change it. Press  at any time to return to the previous menu.



### SCSI Parity Checking

Select this option to enable or disable the SCSI parity checking function on the SCSI controller. The screen below displays the selections. The default setting is **“Enabled”**.

```
Adaptec AIC-7902W SCSISelect (TM) Utility v2.10

AIC-7902W at Bus:02h Device:09h Channel:A

Configuration
SCSI Bus Interface Definitions
Host Adapter SCSI ID .....7
SCSI Parity Checking .....Enabled

Host Adapter SCSI Te * Enabled .....Enabled
                        Disabled





Additional Options
Boot Device Options.....Press <Enter>
SCSI Device Configuration.....Press <Enter>

BIOS Information
Interrupt (IRQ) Channel.....11
I/O Port Address.....A000h

Arrow keys to move cursor, <Enter> to select option, <Esc> to exit (*=default)
```



The SCSI controller always checks parity when reading from the SCSI bus to verify the correct transmission of data from the SCSI devices. You should disable the SCSI Parity Checking parameter if any of the installed SCSI devices do not support SCSI parity. Most currently available SCSI devices support this feature.

Using  and  then press  to select options. Press  at any time to return to the previous menu.

## Boot Device Options

This parameter shows the target ID of your boot device. The default setting is 0 (zero). We recommend that you keep the default setting since most system applications run only in this setting. Below is the Boot Device Configuration menu screen.

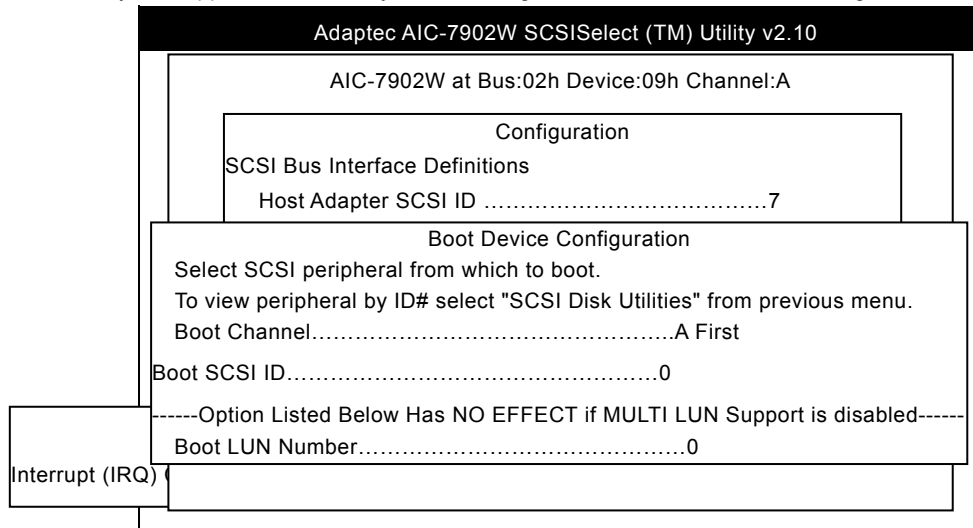

### Boot Channel Options

This parameter lets you choosing boot the system from SCSI channel A or B first. The default setting is A (zero). We recommend that you keep the default setting since most system applications run only in this setting. Below is the Boot Device Configuration menu screen.

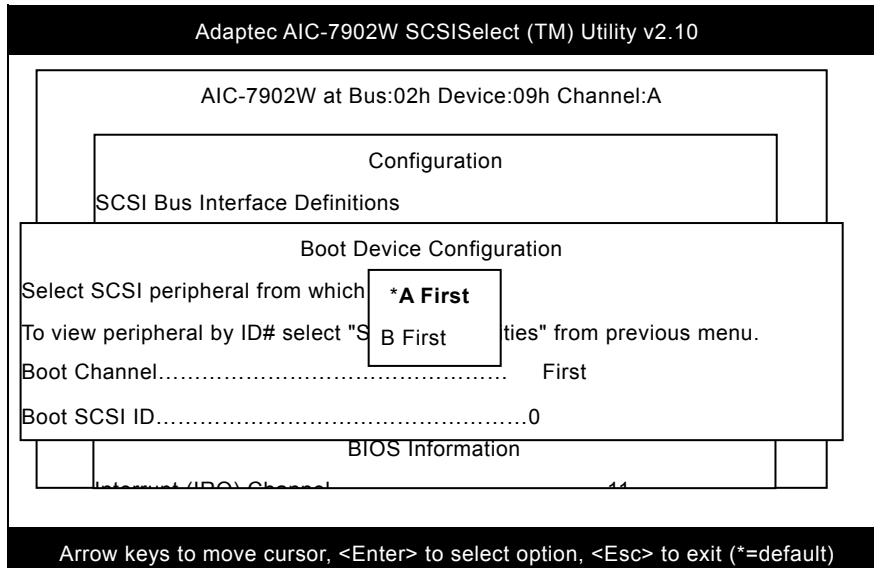



### Boot SCSI ID Options

This parameter lets you choosing the SCSI ID of SCSI device to be a boot device. The default setting is 0 (zero). We recommend that you keep the default setting since most system applications run only in this setting. Below is the Boot Device Configuration menu screen.

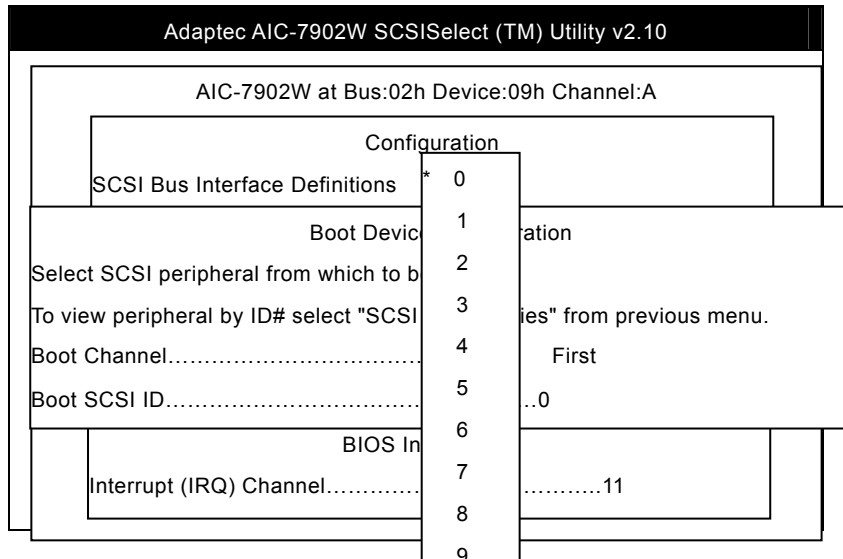

**Boot LUN Number Options**

Adaptec AIC-7902W SCSISelect (TM) Utility v2.10

AIC-7902W at Bus:02h Device:09h Channel:A

Configurasion

SCSI Bus Interface Definitions

Boot Device\* 0

Select SCSI peripheral from which to boot 1

To view peripheral by ID# select "SCSI 2

Boot Channel..... 3 First

Boot SCSI ID 4 0

5 on

Interrupt (IRQ) Channel..... 6 .....11

7

Arrow keys to move cursor, <Enter> to select option, <Esc> to exit (\*=default)

## **Boot LUN Number**



LUN (Logic unit number) can support more devices, like RAID box or RAID card.



### **SCSI Device Configuration**

This parameter allows you to configure details of each SCSI device on the SCSI bus. The screen shows a column of information for each SCSI ID, even if some SCSI IDs are not assigned to a device. To configure a specific SCSI device, you need to know which SCSI ID it uses. See the SCSI Disk Utilities later in this section for instructions on how to determine the SCSI ID used by a device.

Adaptec AIC-7902W SCSISelect (TM) Utility v2.10								
SCSI Device Configuration								
SCSI Device ID	#0	#1	#2	#3	#4	#5	#6	#7
-----								
Sync Transfer Rate (MB/Sec).	160.0	160.0	160.0	160.0	160.0	160.0	160.0	160.0
Initiate Wide Negotiation.....	Yes	Yes	Yes	Yes	Yes	Yes	Yes	Yes
Enable Disconnection.....	Yes	Yes	Yes	Yes	Yes	Yes	Yes	Yes
Send Start Unit Command.....	Yes	Yes	Yes	Yes	Yes	Yes	Yes	Yes
Enable Write Back Cache.....	N/C	N/C	N/C	N/C	N/C	N/C	N/C	N/C
-----Options Listed Below Have NO EFFECT if the BIOS is Disabled-----								
BIOS Multiple LUN Support.....	No	No	No	No	No	No	No	No
Include in BIOS Scan.....	Yes	Yes	Yes	Yes	Yes	Yes	Yes	Yes

Arrow keys to move cursor, <Enter> to select option, <Esc> to exit (\*=default)

Using  or  to move between options, then press  to display a pop-up menu with a list of values.

Using  or  to select a value, then press .

**Sync Transfer Rate**

This option determines the maximum synchronous data transfer rate that the SCSI controller can support. The SCSI controller supports rates up to the Fast Wide SCSI maximum of 80.0 MB per second. The default value is 80.0.

In most cases, you can use the maximum value of 80.0. However, if the SCSI controller is not set to negotiate data transfer (i.e., Initiate Sync Negotiation is set to No), the value selected here is the maximum rate that the SCSI controller accepts from the device during negotiation. This is a standard SCSI protocol.



Some older SCSI-1 devices do not support Fast SCSI data transfer rates. This may cause the system to operate erratically or hang if the transfer rate is too high.

**Initiate Wide Negotiation**

This option allows communication between all devices (lower 8-bit or upper 8-bit) on the wide (16-bit) SCSI bus. When set to **Yes**, each device can connect on the bus. When set to **No** (disabled), communication can only occur on the lower eight bits of the 16-bit SCSI bus. The default setting is **Yes**.

**Enable Disconnection**

This option determines whether the SCSI controller allows a SCSI device to disconnect from the SCSI bus (sometimes called Disconnect/Reconnect). Disconnect/Reconnect allows the SCSI controller to perform other operations on the SCSI bus while the SCSI device is temporarily disconnected.

When set to **Yes**, the SCSI device may disconnect from the SCSI bus. The SCSI device, however, may choose not to disconnect, even if permitted by the SCSI controller. When set to **No**, the SCSI device is not allowed to disconnect from the SCSI bus. The default setting is **Yes**.

Keep this item set to **Yes** if two or more SCSI devices are connected to the SCSI controller. This can optimize SCSI bus performance. If only one SCSI device is connected to the SCSI controller, set this item to **No** to achieve better system performance.

### **Send Start Unit Command**

This option determines whether the Start Unit Command (SCSI command 1B) is sent to the SCSI device (most devices do not require this). Enabling this item reduces the load on the system power supply by allowing the SCSI controller to power up SCSI devices one at a time upon booting. Otherwise, all the devices power up at the same time. Most devices require you to set a jumper before they can respond to this command.

When set to **Yes**, the Start Unit Command is sent to the SCSI device at system boot. When set to **No**, each SCSI device powers up in the normal procedure.



The Send Start Unit Command setting is valid only if the host adapter BIOS is enabled.

If this option is enabled for more than one SCSI device, the Start Unit Command is sent first to the device with the lowest SCSI ID. When this device responds to the SCSI controller, the Start Unit Command is sent to the next highest SCSI ID with a setting of **Yes**. The process continues until all supported devices respond to the SCSI controller.



If many drives are set to **Yes** for Send Start Unit Command, the boot time varies depending on how long it takes each drive to spin up.

## Advanced Configuration Options

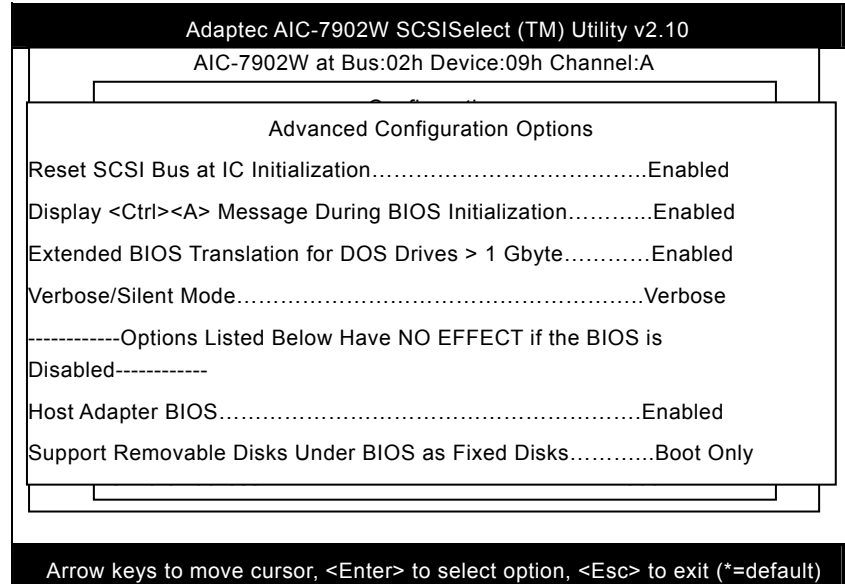
Selecting the Advanced Configuration Options displays a screen as shown below. Do not change the settings of the items under this parameter unless it is absolutely necessary.



Using  or  to move between options, then press  to display a pop-up menu with a list of options.

Using  or  to select an option, then press .

## Host Adapter BIOS

This option enables or disables the SCSI controller BIOS. The default setting is **Enabled**.

The SCSI controller BIOS must be enabled if you want the system to boot from a SCSI hard disk drive connected to the SCSI controller. Several SCSISelect™ options cannot be used unless the SCSI controller BIOS is enabled.

## Display <Ctrl-A> Message During BIOS Initialization

This option allows entering the SCSISelect™ utility during BIOS initialization. The default setting is **Enabled**.

## Extended BIOS Translation for DOS Drives > 1 GByte

This option allows you to enable or disable extended translation for SCSI hard disks with a capacity greater than 1 GB. This is valid only if the SCSI controller BIOS is enabled. The default factory setting is **Enabled**.

When enabled, this option uses the following translation schemes:

- **SCSI hard disks < 1 GB** use a translation scheme of 64 heads, 32 sectors per track
- **SCSI hard disks > 1 GB** use a translation scheme of 255 heads, 63 sectors per track



See the section "Disk Drives Over 1 GB" in this chapter, for more information on this option. This option should be left disabled for most operating systems except DOS.



## Support Removable Disks Under BIOS as Fixed Disks

This option allows you to control which removable-media drives are supported by the SCSI controller BIOS. This is only valid when the SCSI controller BIOS is enabled. The default setting is **Boot Only**. The following choices are available:

- **Boot Only** - Only the removable-media drive designated as the boot device is treated as a hard disk drive.
- **All Disks** - All removable-media drives supported by the BIOS are treated as hard disk drives.
- **Disabled** - No removable-media drives are treated as hard disk drives. In this case, software drivers are needed because the drives are not controlled by BIOS.

Support for removable-media drives means that the SCSI controller BIOS allows use of a removable-media drive as if it is a hard disk drive. It does not mean that you can remove the disk media during operation.



If a removable-media SCSI device is controlled by the SCSI controller BIOS, do not remove the media while the drive is powered-on or you may lose data!

## BIOS Support for Bootable CD-ROM

When enabled, this option allows you to use a bootable CD-ROM device to directly load an operating system. The default setting is **Enabled**.

## BIOS Support for Int13 Extensions

This option allows access to attached SCSI devices through BIOS Int13 functions. The default setting is **Enabled**.



## **SCSI Disk Utilities**

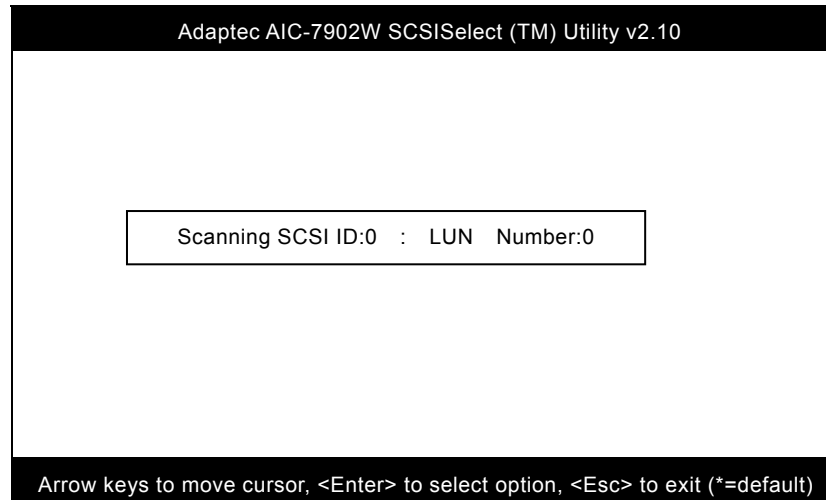

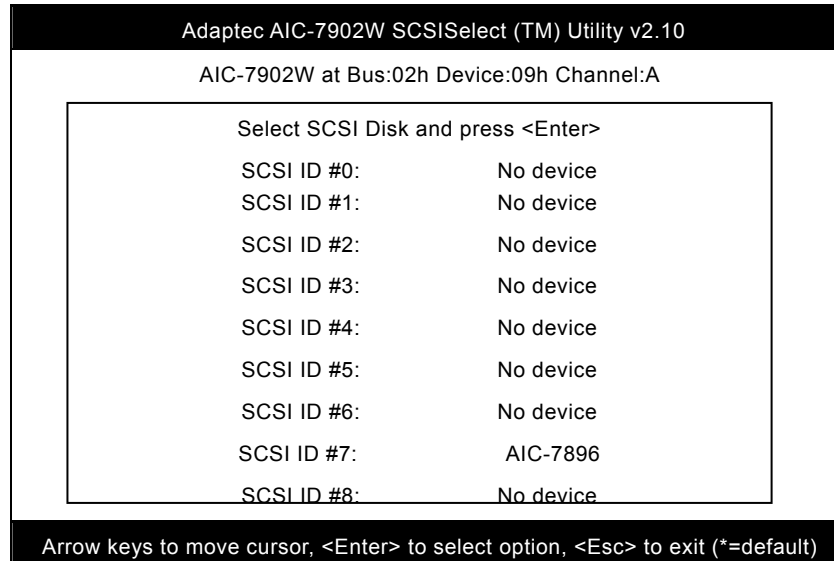
When you select SCSI Disk Utilities from the Options menu, the SCSISelect™ Utility scans the SCSI bus and lists all SCSI devices installed on the SCSI bus. The list shows the individual SCSI IDs assigned to each device on the SCSI bus.





Select a disk device to display a small menu window. From this menu, select **Format Disk** or **Verify Media**.

Using  or  to move between options, then press  to display a pop-up menu with a list of values.

Using  or  to select a value, then press .

## Format Disk

The Format Disk utility performs a low-level format on disk devices.

Most SCSI disk devices are preformatted and do not need to be formatted again. The Adaptec Format Disk utility is compatible with the vast majority of SCSI disk drives. Run it on hard disk drives or removable-media drives that were previously used with a non-Adaptec SCSI controller.



A low-level format destroys all data on the drive. Be sure to back up your data before performing this operation. You cannot abort a low-level format once it is started.

## Verify Media

The Verify Media utility scans the selected device's media for defects. If the utility finds bad blocks, it prompts you to reassign them. If you select **Yes**, those blocks will no longer be used.



You can press  at any time to abort the Verify Disk Media utility.

## **Disk Drives Over 1 GByte**

### **Extended Translation**

Adaptec SCSI controllers have always supported the full range of disk drive capacities under all major operating systems. As disk drives have recently grown beyond 1 GB in formatted capacity, they have run up against the DOS 1024-cylinder limit.

To continue its support for all SCSI disk drive capacities under DOS, Adaptec has included an extended translation scheme for the AIC-7902W SCSI controllers. This feature supports disk drives of up to 8 GB capacity under DOS. The section Extended BIOS Translation for DOS Drives > 1 GB explains how to change the setting of this option. Most operating systems leave this option disabled.

### **DOS 1 GByte Limit**

All current versions of DOS are limited to 1024 cylinders per drive. The standard translation scheme for SCSI host controllers, using 64 heads and 32 sectors, gives a maximum capacity of 1 GB.

To eliminate the 1-GB limit, Adaptec's extended translation feature uses 255 heads and 63 sectors, extending the disk drive capacity limit under DOS to 8 GB.



If you have already partitioned a large hard disk drive with one translation method, conversion to another method erases the data on the drive. Be sure to back up your disk drive prior to any change in the translation method.

## **When to Use the Extended Translation**

### **With DOS 5.0 and above**

NetWare 386 (version 3.0 and above) and some versions of UNIX that do not share the 1024 cylinder limit of DOS do not require extended translation to support large disk drives and should not be enabled.

### **Drives with mixed partitions**

Use standard translation (not extended translation) on drives formatted with two or more partitions for different operating systems. Partitions for UNIX and NetWare can be larger than 1 GB when using standard translation.

### **Using FDISK**

To install a new disk, or to re-partition an existing disk, use the FDISK DOS utility as you normally would. The cylinder size increases to 8 MB when you enable extended translation. The size of the partition you request must therefore be a multiple of 8 MB. If you request a partition size that is not a multiple of 8 MB, FDISK rounds up to the nearest whole multiple of 8 MB.

# Glossary

## AC97

Basically, AC97 specification separates sound/modem circuit to two parts, digital processor and a [CODEC](#) for analog I/O they are linked by AC97 link bus. Since digital processor can be put into motherboard main chipset, the cost of sound/modem onboard solution can be reduced.

## ACPI (Advanced Configuration & Power Interface)

ACPI is the power management specification of PC97 (1997). It intends to save more power by taking full control of power management to operating system and bypass [BIOS](#). The chipset or super I/O chip needs to provide standard register interface to operating system (such as Windows 98). This is a bit similar as the [PnP](#) register interface. ACPI defines ATX momentary soft power switch to control the power state transition.

## AGP (Accelerated Graphic Port)

AGP is a bus interface targeted for high-performance 3D graphic. AGP supports only memory read/write operation and single-master single-slave one-to-one only. AGP uses both rising and falling edge of the 66MHz clock, for 2X AGP, the data transfer rate is  $66\text{MHz} \times 4\text{byte} \times 2 = 528\text{MB/s}$ . AGP is now moving to 4X mode,  $66\text{MHz} \times 4\text{byte} \times 4 = 1056\text{MB/s}$ . AOpen is the first company to support 4X AGP motherboards by both AX6C (Intel 820) and MX64/AX64 (VIA 694x), started from Oct 1999.

## ***AMR (Audio/Modem Riser)***

The [CODEC](#) circuit of AC97 sound/modem solution can be put on motherboard or put on a riser card (AMR card) that connects to motherboard through AMR connector.

## ***AOpen Bonus Pack CD***

A disc bundled with AOpen motherboard product; there are motherboard drivers, Acrobat Reader for [PDF](#) online manual and other useful utilities.

## ***APM (Advanced Power Management)***

Unlike [ACPI](#), BIOS controls most APM power management functions. AOpen Suspend to Hard Drive is a good example of APM power management.

## ***ATA (AT Attachment)***

ATA is the specification of diskette interface. In 80's, many software and hardware manufacturers instituted the ATA specification together. The AT is meaning International Business Machines Corporation (IBM) personal computer/AT's bus structure.

## ***ATA/66***

ATA/66 uses both rising edge and falling edge but doubles [UDMA/33](#) transfer rate. The data transfer rate is 4 times of the PIO mode 4 or DMA mode 2, 16.6MB/s x4 = 66MB/s. To use ATA/66, you need special ATA/66 IDE cable.





## ***ATA/100***

ATA/100 is a new IDE specification under developing. ATA/100 uses both rising edge and falling edge as [ATA/66](#) but clock cycle time is reduced to 40ns. The data transfer rate is  $(1/40\text{ns}) \times 2 \text{ bytes} \times 2 = 100\text{MB/s}$ . To use ATA/100, you need special 80-wire IDE cable, the same as ATA/66.

## ***BIOS (Basic Input/Output System)***

BIOS is a set of assembly routine/program that reside in [EPROM](#) or [Flash ROM](#). BIOS controls Input/output devices and other hardware devices of motherboard. In general, to provide hardware independent portability, operation system and drivers is required to access BIOS without directly access hardware devices.

## ***Bus Master IDE (DMA mode)***

The traditional PIO (Programmable I/O) IDE requires the CPU to involve in all the activities of the IDE access including waiting for the mechanical events. To reduce the workload of the CPU, the bus master IDE device transfers data from/to memory without interrupting CPU, and releases CPU to operate concurrently while data is transferring between memory and IDE device. You need the bus master IDE driver and the bus master IDE HDD to support bus master IDE mode.

## ***CNR (Communication and Networking Riser)***

The CNR specification provides the PC industry the opportunity to deliver a flexible and cost reduced method of implementing LAN, home networking, DSL, USB, wireless, audio and modem subsystems widely used in today's "connected PCs". The CNR specification is an open industry specification and is supported by OEMs, IHV card manufacturers, silicon supplier and Microsoft.



## ***CODEC (Coding and Decoding)***

Normally, CODEC means a circuit that can do digital to analog conversion and also the analog to digital conversion. It is part of [AC97](#) sound/modem solution.

## ***DDR (Double Data Rated) SDRAM***

DDR SDRAM utilizes the existing DRAM infrastructure and technology while doubling the nominal bandwidth available to systems in an easy to design and simple to adopt way. Initially a perfect solution for memory intensive server and workstation applications, DDR low cost and low voltage will ultimately make it an ideal solution for all segments of the PC market, high performance desktop and mobile PCs, Value PCs and even Internet Appliances and mobile devices.

## ***DIMM (Dual In Line Memory Module)***

DIMM socket has total 168-pin and supports 64-bit data. It can be single or double side, the golden finger signals on each side of PCB are different, and that is why it was called Dual In Line. Almost all DIMMs are made by [SDRAM](#), which operate at 3.3V. Note that some old DIMMs are made by FPM/[EDO](#) and only operate at 5V. Do not confuse them with SDRAM DIMM.

## ***DMA (Direct Memory Access)***

Channel for communications between the memory and surrounding devices.

### ***ECC (Error Checking and Correction)***

The ECC mode needs 8 ECC bits for 64-bit data. Each time memory is accessed; ECC bits are updated and checked by a special algorithm. The ECC algorithm has the ability to detect double-bit error and automatically correct single-bit error while parity mode can only detect single-bit error.

### ***EDO (Extended Data Output) Memory***

The EDO DRAM technology is actually very similar to FPM (Fast Page Mode). Unlike traditional FPM that tri-states the memory output data to start the pre-charge activity, EDO DRAM holds the memory data valid until the next memory access cycle, that is similar to pipeline effect and reduces one clock state.

### ***EEPROM (Electronic Erasable Programmable ROM)***

Also known as E<sup>2</sup>PROM. Both EEPROM and [Flash ROM](#) can be re-programmed by electronic signals, but the interface technology is different. Size of EEPROM is much smaller than flash ROM.

### ***EPROM (Erasable Programmable ROM)***

Traditional motherboard stores BIOS code in EPROM. EPROM can only be erased by ultra-violet (UV) light. If BIOS has to be upgraded, you need to remove EPROM from motherboard, clear by UV light, re-program, and then insert back.

## **EV6 Bus**

EV6 Bus in the technology of Alpha processor from Digital Equipment Corporation. EV6 bus uses both rising and falling clock edge to transfer data, similar as DDR SDRAM or ATA/66 IDE bus.

EV6 Bus Speed = CPU external bus clock x 2.

For example, 200 MHz EV6 bus is actually using 100 MHz external bus clock, but the equivalent speed is 200 MHz.

## **FCC DoC (Declaration of Conformity)**

The DoC is component certification standard of FCC EMI regulations. This standard allows DIY component (such as motherboard) to apply DoC label separately without a shielding of housing.

## **FC-PGA (Flip Chip-Pin Grid Array)**

FC means Flip Chip, FC-PGA is a new package of Intel for Pentium III CPU. It can plug into SKT370 socket, but require motherboard to add some signals on socket 370. That is, the motherboard needs to be redesigned. Intel is going to ship FC-PGA 370 CPU and phase out slot1 CPU.

## **Flash ROM**

Flash ROM can be re-programmed by electronic signals. It is easier for BIOS to upgrade by a flash utility, but it is also easier to be infected by virus. Because of increase of new functions, BIOS size is increased from 64KB to 256KB (2M bit). AOpen AX5T is the first board to implement 256KB (2Mbit) Flash ROM. Now flash ROM size is moving to 4M bit on AX6C (Intel 820) and MX3W (Intel 810) motherboard. , AOpen motherboard uses EEPROM for jumper-less and battery-less design.

## **FSB (Front Side Bus) Clock**

FSB Clock means CPU external bus clock.

CPU internal clock = CPU FSB Clock x CPU Clock Ratio

## **IPMB Bus**

See [SMBus](#).

## **IEEE 1394**

IEEE 1394 is a low-cost digital interface originated by Apple Computer as a desktop LAN and developed by the IEEE 1394 working group. The IEEE 1394 can transport data at 100, 200 or 400 Mbps. One of the solutions to connect digital television devices together at 200 Mbps. Serial Bus Management provides overall configuration control of the serial bus in the form of optimizing arbitration timing, guarantee of adequate electrical power for all devices on the bus, assignment of isochronous channel ID, and notification of errors. There are two type of IEEE 1394 data transfer: asynchronous and isochronous. Asynchronous transport is the traditional computer memory-mapped, load and store interface. Data requests are sent to a specific address and an acknowledgment is returned. In addition to an architecture that scales with silicon technology, IEEE 1394 features a unique isochronous data channel interface. Isochronous data channels provide guaranteed data transport at a pre-determined rate. This is especially important for time-critical multimedia data where just-in-time delivery eliminates the need for costly buffering.

## ***Parity Bit***

The parity mode uses 1 parity bit for each byte, normally it is even parity mode, that is, each time the memory data is updated, parity bit will be adjusted to have even count "1" for each byte. When next time, if memory is read with odd number of "1", the parity error is occurred and this is called single bit error detection.

## ***PBSRAM (Pipelined Burst SRAM)***

For Socket 7 CPU, one burst data read requires four QWord (Quad-word,  $4 \times 16 = 64$  bits). PBSRAM only needs one address decoding time and automatically sends the remaining QWords to CPU according to a predefined sequence. Normally, it is 3-1-1-1, total 6 clocks, which is faster than asynchronous SRAM. PBSRAM is often used on L2 (level 2) cache of Socket 7 CPU. Slot 1 and Socket 370 CPU do not need PBSRAM.

## ***PC-100 DIMM***

[SDRAM](#) DIMM that supports 100MHz CPU [FSB](#) bus clock.

## ***PC-133 DIMM***

[SDRAM](#) DIMM that supports 133MHz CPU [FSB](#) bus clock.

## ***PC-1600 or PC-2100 DDR DRAM***

Based on FSB frequency, the DDR DRAM has 200MHz and 266MHz two type of working frequency. Because of DDR DRAM data bus is 64-bit, it provides data transfer bandwidth up to  $200 \times 64 / 8 = 1600 \text{MB/s}$ , and  $266 \times 64 / 8 = 2100 \text{MB/s}$ . Hence, the PC-1600 DDR DRAM is working with 100MHz and PC-2100 DDR DRAM is working with 133MHz FSB frequency.



## ***PCI (Peripheral Component Interface) Bus***

Bus for the internal connection of peripheral devices, high-speed data channel between the computer and expansion card.

## ***PDF Format***

A file format for electronic document, PDF format is independent from platform, you can read PDF file under Windows, Unix, Linux, Mac ... with different PDF reader. You can also read PDF file by web browser such as IE and Netscape, note that you need to install PDF plug-in first (Included in Acrobat Reader).

## ***PnP (Plug and Play)***

The PnP specification suggests a standard register interface for both BIOS and operating system (such as Windows 95). These registers are used by BIOS and operating system to configure system resource and prevent any conflicts. PnP BIOS or operating system will automatically allocate the IRQ/DMA/Memory. Currently, almost all the PCI cards and most ISA cards are already PnP compliant.

## ***POST (Power-On Self Test)***

The BIOS self-test procedure after power-on, sometimes, it is the first or the second screen shown on your monitor during system boot.

### ***RDRAM (Rambus DRAM)***

Rambus is a memory technology that uses large burst mode data transfer. Theoretically, the data transfer should be high than [SDRAM](#). RDRAM is cascaded in channel operation. For Intel 820, only one RDRAM channel is supported, 16-bit data per channel, and this channel may have maximum 32 RDRAM devices, no matter how many [RIMM](#) sockets.

### ***RIMM (Rambus Inline Memory Module)***

184-pin memory module that supports [RDRAM](#) memory technology. A RIMM memory module may contain up to maximum of 16 RDRAM devices.

### ***SDRAM (Synchronous DRAM)***

SDRAM is one of the DRAM technologies that allow DRAM to use the same clock as the CPU host bus ([EDO](#) and FPM are asynchronous and do not have clock signal). It is similar as [PBSRAM](#) to use burst mode transfer. SDRAM comes in 64-bit 168-pin [DIMM](#) and operates at 3.3V. AOpen is the first company to support dual-SDRAM DIMMs onboard (AP5V), from Q1 1996

### ***Shadow E<sup>2</sup>PROM***

A memory space in Flash-ROM to simulate E<sup>2</sup>PROM operation, AOpen motherboard uses Shadow E<sup>2</sup>PROM for jumper-less and battery-less design



### ***SIMM (Single In Line Memory Module)***

SIMM socket is only 72-pin, and is only single side. The golden finger signals on each side of PCB are identical. That is why it was called Single In Line. SIMM is made by FPM or [EDO](#) DRAM and supports 32-bit data. SIMM had been phased out on current motherboard design.

### ***SMBus (System Management Bus)***

SMBus is also called IPMB bus. It is a two-wire bus developed for component communication (especially for semiconductor IC). For example, set clock of clock generator for jumper-less motherboard. The data transfer rate of SMBus is only 100Kbit/s, it allows one host to communicate with CPU and many masters and slaves to send/receive message.

### ***SPD (Serial Presence Detect)***

SPD is a small ROM or [EEPROM](#) device resided on the [DIMM](#) or [RIMM](#). SPD stores memory module information such as DRAM timing and chip parameters. SPD can be used by [BIOS](#) to decide best timing for this DIMM or RIMM.

## **Ultra DMA**

Ultra DMA (or, more accurately, Ultra DMA/33) is a protocol for transferring data between a hard disk drive through the computer's data path (or bus) to the computer's random access memory (RAM). The Ultra DMA/33 protocol transfers data in burst mode at a rate of 33.3MB/s, twice as fast as the previous [Direct Access Memory \(DMA\)](#) interface. Ultra DMA was developed as a proposed industry standard by the Quantum corporation, makes of hard disk drives, and Intel, makes of chipset that support computer bus technology. Ultra DMA support in your computer means that it will boot (start) and open new applications more quickly. It will help users of graphic-intensive and applications that require large amounts of access to data on the hard disk drive. Ultra DMA uses Cyclical Redundancy Checking (CRC), offering a new level of data protection. Ultra DMA uses the same 40-pin IDE interface cable as PIO and DMA.

16.6MB/s x2 = 33MB/s

16.6MB/s x4 = 66MB/s

16.6MB/s x6 = 100MB/s

## **USB (Universal Serial Bus)**

USB is a 4-pin serial peripheral bus that is capable of cascading low/medium speed peripherals (less than 10Mbit/s) such as keyboard, mouse, joystick, scanner, printer and modem. With USB, the traditional complex cables from back panel of your PC can be eliminated.

## **VCM (Virtual Channel Memory)**

NEC's Virtual Channel Memory (VCM) is a new DRAM core architecture that dramatically improves the memory system's ability to service multimedia requirements. VCM increases memory bus efficiency and performance of any DRAM technology by providing a set of fast static registers between the memory core and I/O pins. Using VCM technology results in reduced data access latency and reduced power consumption.

## **ZIP file**

A compressed file format to reduce file size. To unzip file, run shareware PKUNZIP (<http://www.pkware.com/>) for DOS and other operating system or WINZIP (<http://www.winzip.com/>) for windows environment.

# **Troubleshooting**

If you encounter any trouble to boot your system, follow the procedures accordingly to resolve the problem.

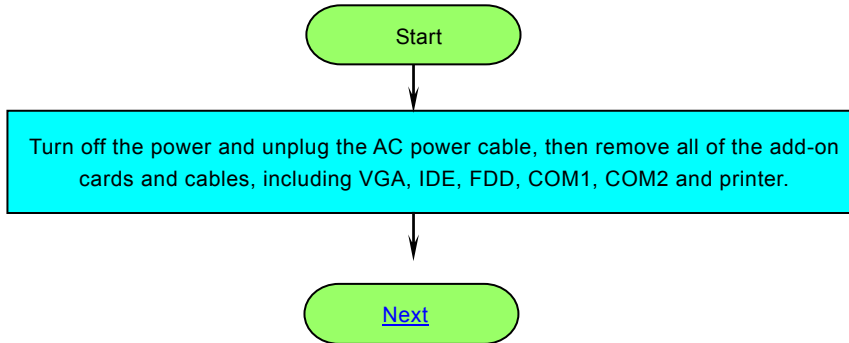

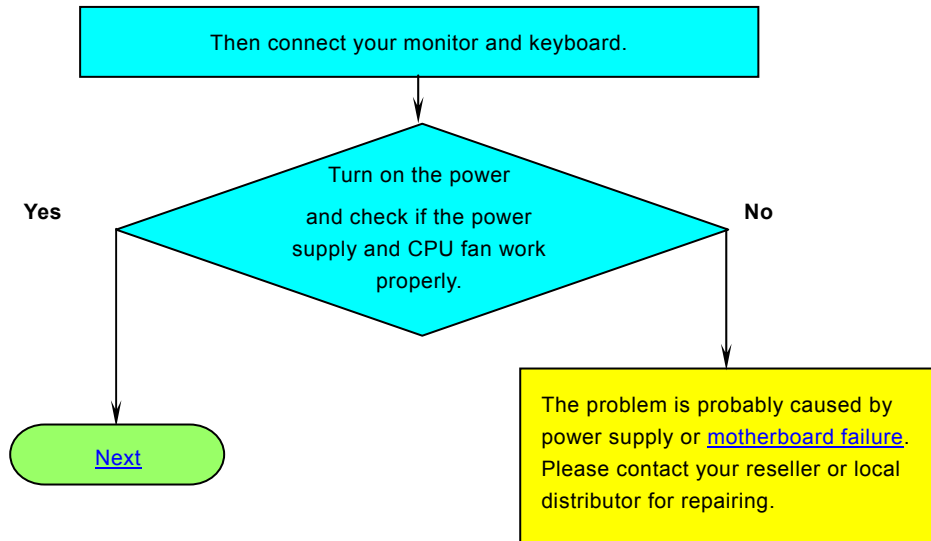

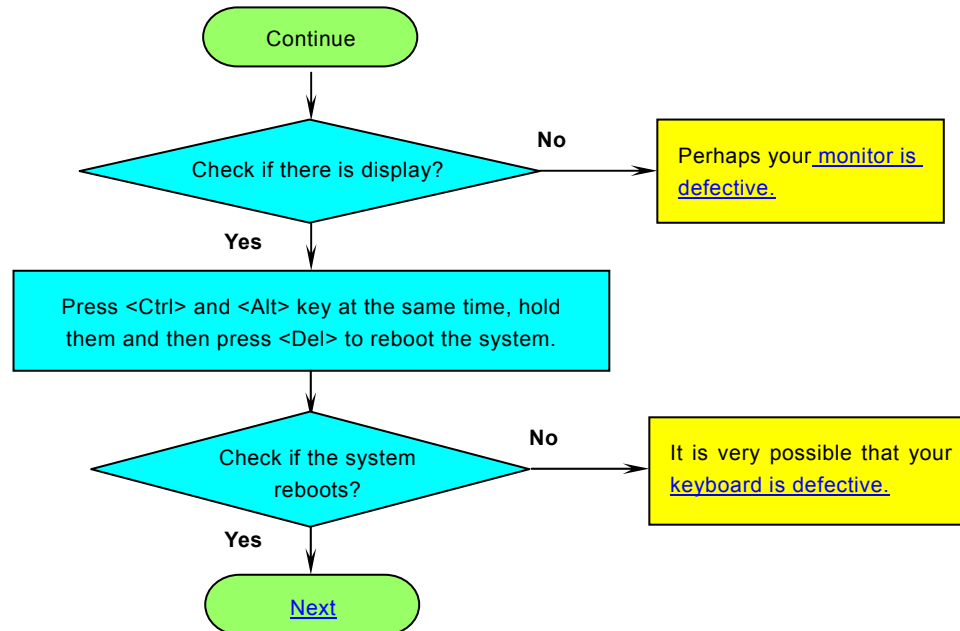

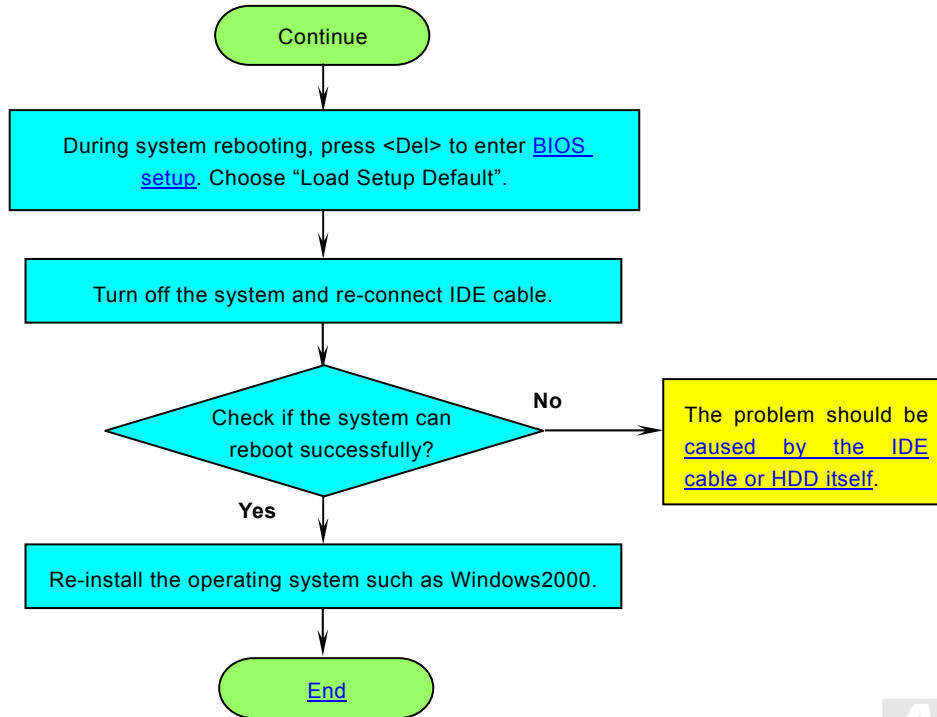



## Technical Support

Dear Customer,

Thanks for choosing AOpen products. To provide the best and fastest service to our customer is our first priority. However, we receive numerous emails and phone-calls worldwide everyday, it is very hard for us to serve everyone on time. We recommend you follow the procedures below and seek help before contact us. With your help, we can then continue to provide the best quality service to more customers.

Thanks very much for your understanding!

AOpen Technical Supporting Team

1

**Online Manual:** Please check the manual carefully and make sure the jumper settings and installation procedure are correct.

<http://www.aopen.com/tech/download/manual/default.htm>

2

**Test Report:** We recommend choosing board/card/device from the compatibility test reports for assembling your PC.

<http://www.aopen.com/tech/report/default.htm>

3

**FAQ:** The latest FAQ (Frequently Asked Questions) may contain a solution to your problem.

<http://www.aopen.com/tech/faq/default.htm>

4

**Download Software:** Check out this table to get the latest updated BIOS/utility and drivers.

<http://www.aopen.com/tech/download/default.htm>



**5**

**News Group:** News posted by computer experts. You are welcome to join any discussion.

<http://www.aopen.com/tech/newsgrp/default.htm>

**6**

**Contact Distributors/Resellers:** We sell our products through resellers and integrators. They should know your system configuration very well and should be able to solve your problem more efficiently than us. After all, their attitude of service is an important reference for you if next time you want to buy something else from them.

**7**

**Contact Us:** Please prepare detail system configuration and error symptom before contacting us. The **part number**, **serial number** and **BIOS version** are also very helpful.

### Part Number and Serial Number

The Part Number and Serial number are printed on bar code label. You can find this bar code label on the outside packing, or on component side of PCB. For example:



**P/N: 91.88110.201** is part number, **S/N: 91949378KN73** is serial number.

***Model name and BIOS version***

Model name and BIOS version can be found on upper left corner of first boot screen ([POST](#) screen). For example:



**DXPS** is model name of motherboard; **R1.20** is BIOS version.



# Product Registration

ClubAOpen

Welcome to AOpen Inc.



Thank you for choosing AOpen product. AOpen encourages you to spend few minutes in completing the following product registration. To register your product will ensure the high quality of services from AOpen. After the registration, you will:

- Have opportunities to play online slot machine and win a prize from AOpen by accumulating your bonuses for later prize exchange.
- Be upgraded to gold membership of Club AOpen program.
- Receive email notification about product safety alerts. Its purpose is to alert consumers quickly and conveniently when products contain technical issues.
- Receive email notification about latest product's announcements.
- Be able to personalize your AOpen web pages.
- Receive e-mail notification about latest BIOS/Driver/Software release information.
- Have opportunities to participate special product promotional programs.
- Enjoy higher service priority to receive technical assistance provided by AOpen specialists worldwide.
- Be able to join the discussions of web-based news groups.

AOpen makes sure that the information you provide is encrypted, so that it cannot be read or intercepted by other people or companies. Further, AOpen will not disclose any of information you submitted under any conditions. Please consult our [online privacy policy](#) for further information on our company policy.

**Note:** *If registering products purchased from different dealers/retails and/or purchased on different dates, please submit a separate form for each product.*

AOpen



## How to Contact Us



Pacific Rim  
AOpen Inc.  
Tel: 886-2-3789-5888  
Fax: 886-2-3789-5899

Europe  
AOpen Computer b.v.  
Tel: 31-73-645-9516  
Fax: 31-73-645-9604

America  
AOpen America Inc.  
Tel: 1-510-489-8928  
Fax: 1-510-489-1998

China  
艾爾鵬國際貿易(上海)有限公司  
Tel: 86-21-6225-8622  
Fax: 86-21-6225-7926

Germany  
AOpen Computer GmbH.  
Tel: 49-1805-559191  
Fax: 49-2102-157799

Japan  
AOpen Japan Inc.  
Tel: 81-048-290-1800  
Fax: 81-048-290-1820

**Web Site:** <http://www.aopen.com/>

**E-mail:** Send us email by going through the contact form below.

**English**                    <http://english.aopen.com.tw/tech/default.htm>

**Japanese**                   <http://www.aopen.co.jp/tech/default.htm>

**Chinese**                    <http://www.aopen.com.tw/tech/default.htm>

**German**                    <http://www.aopencom.de/tech/default.htm>

**Simplified Chinese**      <http://www.aopen.com.cn/tech/default.htm>

