

**USER'S GUIDE**  
**CB53X-VX Main Board**

NEWWOOD  
**DAEWOO**

**DAEWOO**

This mainboard requires correct configuration information; otherwise, a malfunction may result.



Static electricity can cause serious damage to integrated circuit mainboards. To avoid building up a static electric charging on your body, be sure you discharge any static electricity by grounding yourself before handling the mainboards. If mainboards are handed from one person to another, they should touch hands first, then pass the mainboards.

Information presented in this publication has been carefully checked for reliability; however, no responsibility is assumed for inaccuracies. The information contained in this document is subject to change without notice.

Contact your dealer for warranty details.

#### Trademarks

All brands and product names used in this manual may be trademarks or registered trademarks of their respective companies.

## Table of Contents

1. Introduction	
Mainboard Features	1-1
Mainboard Description	1-1
Specification	1-2
Mainboard Layout	1-5
2. Installation	
Check List	2-1
Install Main Memory	2-1
SDRAM Memory Installation	2-1
How to do the combination	2-1
Cache Memory	2-3
Install CPU	2-3
CPU frequency and Bus frequency	2-3
Pentium or Pentium with MMx Technology (P55C)	2-4
Cyrix or IBM 6x86 CPU	2-5
AMD K5/K6 CPU	2-6
Set the Jumpers for CPU Voltage	2-7
CPU Fan	2-8
Install Cables	2-8
IDE Connector	2-8
FDD Connector	2-8
Power Switch Connector	2-9
IrDA	2-9
22-pin Front Panel Switch Connector	2-9
Power Supply Connector	2-10
PS/2 Mouse & Keyboard Connector	2-11
USB Connector	2-11

Serial Port COM1 and COM2 .....	2-11
Parallel Port Printer Connector .....	2-11
Install Add-on Card .....	2-12
Other Jumpers .....	2-12
Clear CMOS (JP6) and Clear Password (JP5) .....	2-12
Summary .....	2-13
Jumper Settings .....	2-13
Host Clock Setting .....	2-14
Voltage Setting .....	2-14
Connector Table .....	2-15

### 3. Built-in BIOS Setup Program

SETUP Program .....	3-1
Standard CMOS Setup .....	3-6
BIOS Features Setup .....	3-8
Chipset Features Setup .....	3-12
Power Management Setup .....	3-16
PNP/PCI Configuration Setup .....	3-19
Load BIOS Defaults .....	3-21
Load Setup Defaults .....	3-21
Integrated Peripherals .....	3-22
Supervisor Password .....	3-26
User Password .....	3-26
IDE HDD Auto Detection .....	3-27
HDD Low Level Format .....	3-29
Quitting SETUP .....	3-31

## About this Manual

This manual is designed to offer detailed information about the CB53X-VX mainboard. The content includes the main features of the mainboard, the installation , and the BIOS settings. There are three chapters to offer clear and detailed information of CB53X-VX.

- |           |              |  |
|-----------|--------------|--|
| Chapter 1 | Introduction | Describes the main features and major components.  |
| Chapter 2 | Installation | Describes the installation of hardware including jumpers, cables and connectors.         |
| Chapter 3 | BIOS Setup   | Describes the setup of BIOS. Briefly explain each item and show the selection of option. |

## Warning Marks

In this manual , **warning marks** are used to stress important parts or notices of text that require users' attention. There are two kinds of warning marks in this manual:



*Stress the important information or instructions that must pay more attentions to and should be noted.*



*Avoid the possible system error or damages , and offer detailed information.*

## Graphic Descriptions of Jumper Settings



means Pin 1 & Pin 2 are set as short

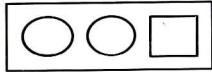

means Pin 1 & Pin 2 are set as open

# 1 Introduction

## Main Features

CB53X-VX is a main stream ATX mainboard supported with the complete family of Intel Pentium and Pentium with MMx technology. Based on Intel 430VX PCIset, CB53X-VX can support up to 512KB Pipelined burst SRAM, two banks 168-pin DIMM module.

## Mainboard Description

- |                              |                            |
|------------------------------|----------------------------|
| 1. Processor Socket          | 9. USB Connector           |
| 2. Chipset                   | 10. PCI IDE Connector      |
| 3. System BIOS               | 11. FDD Connector          |
| 4. DIMM Memory Socket        | 12. Power Connector        |
| 5. PCI Slots                 | 13. RTC                    |
| 6. ISA Slots                 | 14. Keyboard Controller    |
| 7. PS/2 Mouse & Keyboard Set | 15. I/O Chip               |
| 8. Serial/Parallel Ports     | 16. Power Switch Connector |

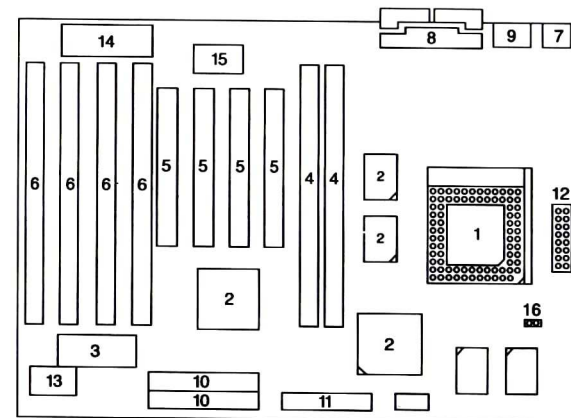

**Specification**

**1. Processor Socket:**

One Socket 7 supports:

- Pentium 75/90/100/120/133/150/166/200 MHz CPU.
- Pentium with MMX TM technology(PP/MT) 166/200/233 MHz CPU.
- Cyrix M1 & M2 CPU.
- AMD K5 & K6 CPU.
- Upgrade capacity to future Pentium Overdrive.

**2. Chipset:**

- Intel 430VX PCiset.
- ITE8669 or ITE8661(PnP Super I/O Controller).

**3. System BIOS:**

- Award flash BIOS.
  - ↳ DMI 2.0
  - ↳ PnP 1.0a (comply with Intel and Windows 95)
  - ↳ PCI 2.1
  - ↳ CD ROM boot
  - ↳ APM 1.2

**4. DIMM Memory Socket:**

- 2 pieces of 168-pin DIMM sockets.
- Support up to 8/16/32 MB unbuffered EDO or Fast Page DRAM or synchronous DRAM. (SDRAM)
- Compliance with JEDEC specifications for 3.3V unbuffered EDO/SDRAM Module.

**5. ISA Expansion Slots:**

- 4 16-bit ISA slots with 100% ISA compatible function.

**6. PCI Expansion Slots:**

- 4 32-bit PCI slots all support PCI master.
  - ↳ PCI specification version 2.1
  - ↳ CPU to PCI memory write posting with 4 Word deep buffers.
  - ↳ Convert Back-to-Back sequential CPU to PCI memory writes to PCI Burst writes.

**7. PS/2 Keyboard and PS/2 Mouse Set:**

- Provides Connectors for PS/2 Keyboard & PS/2 mouse connector set.

**8. Serial / Parallel Ports:**

- One multi-mode parallel port with chip-protect circuitry supports standard, enhanced (EPP), high speed (ECP) mode.
- Two high speed 16C550 UART compatible buffer fast serial port.
- Support IrDA / ASKIR Infrared Interface.

**9. USB Connector:**

- Provides the interface for use of two USB channels.

**10. PCI IDE Connector:**

- Build-in Intel 82371SB chip 32-bit PCI IDE interface with 2 IDE channels.
  - ↳ Support Maximum 4 IDE devices.
  - ↳ Support PIO and Bus master IDE.
  - ↳ Support up to PIO mode 4 timings or bus master.
  - ↳ Transfer 8x32 bit buffer for Bus master IDE PCI Burst

## Introduction

- ↳ Support Separate Master/Slave IDE mode.
- ↳ Plug and Play compatible.
- ↳ Fully compatible with PCI local bus specification V2.1

### 11. FDD Connector:

- Two floppy drive supports 360K/720K/1.2MB/1.44MB/2.88MB floppy drives.

### 12. Power Supply Connector:

- Provides the connectors for standard ATX power supply.

### 13. RTC:

- Stores the CMOS data, Real Time Clock and build-in battery.

### 14. Keyboard Controller:

- It's function compatible with Intel 8042 Keyboard Controller, which provides enhanced gate A20 switching & PS/2 compatible mouse.

### 15. I/O Controller:

### 16. Power On Switch Connector

- This connector is used to provide a way for use to turn the system on.

## Introduction

### Mainboard Layout

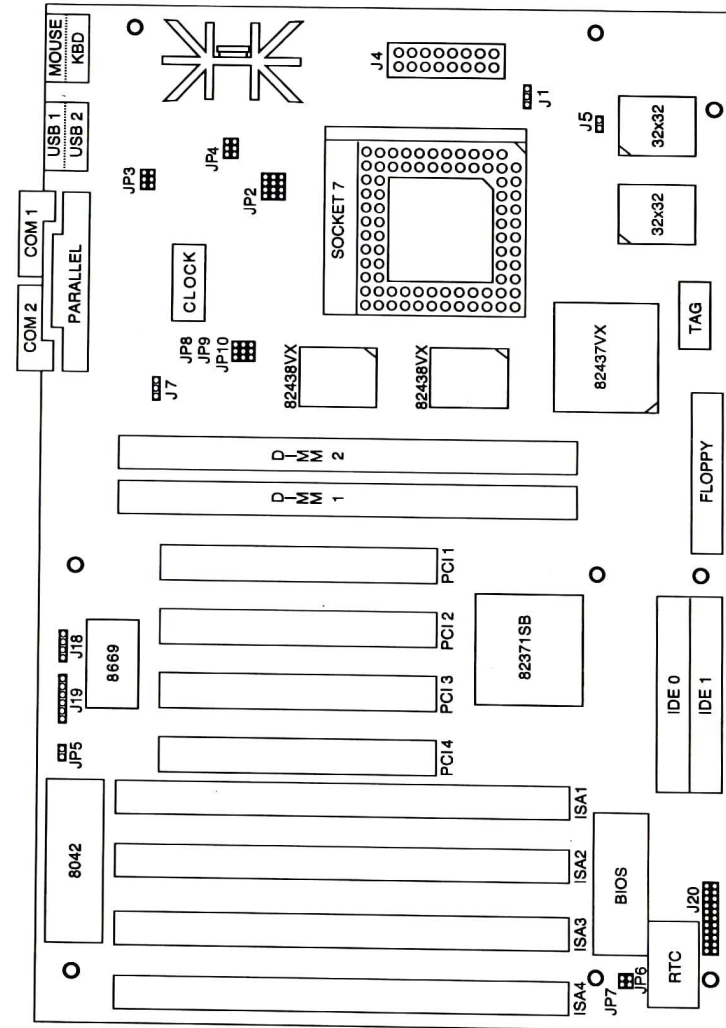

Figure 1-1. CB53X-VX Mainboard Layout

## 2 Installation

---

This chapter provides information on how to install and configure CB53X-VX Mainboard.

### Check List

The standard packing of CB53X-VX should include:

- CB53X-VX mainboard
- 1 IDE cable
- 1 Floppy cable
- CB53X-VX User' s Manual
- Device driver diskette(Optional)

### Install Main Memory

CB53X-VX provides tremendous flexibility DRAM configurations. It accepts a maximum of 128MB memory size with Fast Page Mode or Extended Data Output (EDO) memory. Also it accepts a maximum of 64MB memory size with synchronous DRAM (SDRAM). The on-board DRAM is installed 168-pin 3.3V unbuffered DIMM. (Dual-In-line-Memory Module)

The DIMM Socket is in compliance with JEDEC specifications for 3.3V unbuffered EDO/SDRAM Module. A DIMM socket is provided to support up 128MB of EDO/FPM Module, or 64MB of Synchronous DRAM Module.(SDRAM)

### How to do the Combination ?

Users can install the DIMM module on any bank according to the listing table next page. The possible combinations will make the total memory size from minimum 8MB to maximum 128MB.

The following table lists a number of possible DRAM combinations

DIMM		TOTAL
DIMM1	DIMM2	
8MB		8MB
8MB	8MB	16MB
8MB	16MB	24MB
8MB	32MB	40MB
16MB		16MB
16MB	8MB	24MB
16MB	16MB	32MB
16MB	32MB	48MB
32MB		32MB
32MB	8MB	40MB
32MB	16MB	48MB
32MB	32MB	64MB
64MB		64MB(EDO/FPM ONLY)
64MB	64MB	128MB(EDO/FPM ONLY)

Table 2-1. System Memory Configurations

**Cache Memory**

CB53X-VX is equipped with L2 cache size 256KB or 512KB. L2 Pipelined Burst Cache memory size is manufactured option.

Size	Data RAM(U4,U5)
256KB	32K x 32(3.3V) (Pipelined Burst)
512KB	64K x 32(3.3V) (Pipelined Burst)

**Install CPU**

CB53X-VX provides one ZIF socket 7 for installation of Pentium processor, Pentium with MMx technology processor, Cyrix 6x86/M2 or AMD K5/K6 processor. To install processor, check the direction of CPU and ZIF socket, lift the lever up to the top, put the CPU onto the socket, and lay down the lever of socket and then lock the lever of socket.



**CPU frequency and Bus frequency :**

To install the CPU at its correct frequency, Please refer the following table to set up CPU frequency.

*Intel Pentium Processor or Intel Pentium Processor with MMx Technology :*

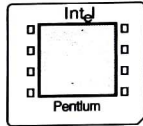

Core CPU Freq. PP & PP/MT	Host Clock	JP4 (Jumper short)	Clock Multiplier	JP9 (Jumper short)	JP10 (Jumper short)
100 MHz	66	open	1.5	2-3	2-3
120 MHz	60	1-2	2	2-3	1-2
133 MHz	66	open	2	2-3	1-2
150 MHz	60	1-2	2.5	1-2	1-2
166 MHz	66	open	2.5	1-2	1-2
200 MHz	66	open	3	1-2	2-3
233 MHz	66	open	3.5	2-3	2-3

Table 2-2. Pentium Series CPU Frequency and Bus Frequency

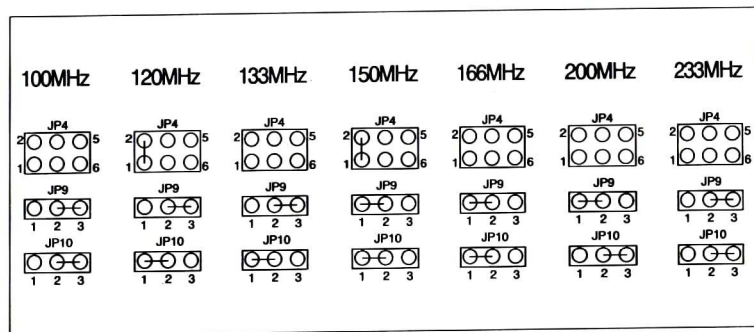

Cyrix or IBM 6x86 / M2 CPU :

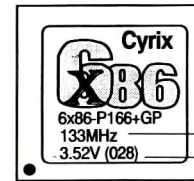

Core CPU frequency  
CPU Voltage

6x86 M2	Core-CPU Freq. (MHz)	Host Clock (MHz)	JP4 (Jumper short)	Clock Multiplier	JP9 (Jumper Short)	JP10 (Jumper Short)
P120+	100	50	1-2, 3-4	2	2-3	1-2
P133+	110	55	3-4	2	2-3	1-2
P150+	120	60	1-2	2	2-3	1-2
P166+	133	66	open	2	2-3	1-2
M2-PR166+	133	66	open	2	2-3	1-2
M2-PR200+	166	66	open	2.5	1-2	1-2
M2-PR233+	200	66	open	3	1-2	2-3
M2-PR266+	233	66	open	3.5	2-3	2-3

Table 2-3. Cyrix or IBM 6x86/M2 CPU Frequency and Bus Frequency

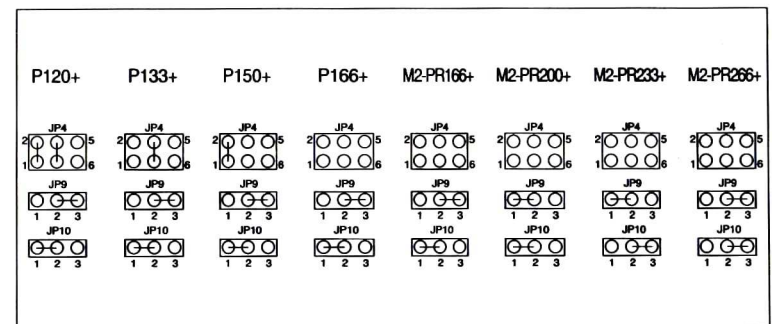

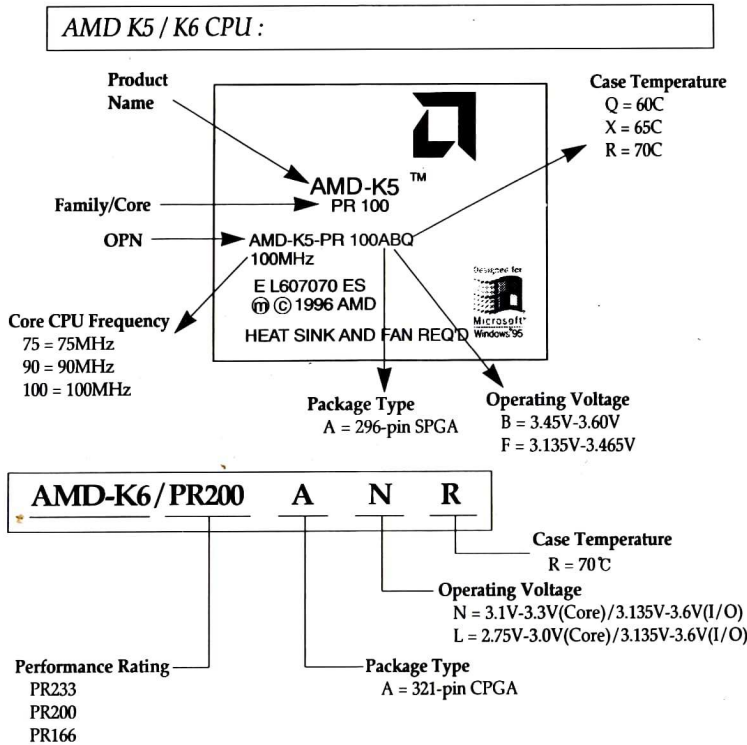

AMD K5/K6	Core CPU Freq. (MHz)	Host Clock (MHz)	JP4 (Jumper short)	Clock Multiplier	JP9 (Jumper Short)	JP10 (Jumper Short)
K5-PR100	100	66	open	1.5	2-3	2-3
K5-PR120	90	60	1-2	1.5	2-3	2-3
K5-PR133	100	66	open	1.5	2-3	2-3
K5-PR166	116.7	66	open	2.5	1-2	1-2
K6-PR166	166	66	open	2.5	1-2	1-2
K6-PR200	200	66	open	3	1-2	2-3
K6-PR233	233	66	open	3.5	2-3	2-3

Table 2-4. AMD K5/K6 CPU Frequency and Bus Frequency

**Set the Jumpers for CPU Voltage:**

The CPU voltage depends on different CPU level need to install the jumper setting for correct voltage as follows:

CPU TYPE	CPU I/O	CPU CORE	JP2	JP3
<b>Single Voltage CPU:</b>				
Pentium STD AMD K5 AFQ...		3.3V	3-4	5-6
Pentium VRE AMD K5 ABQ Cyrix/IBM 6x86		3.52V	3-4	open
<b>Dual Voltage CPU:</b>				
INTEL PP/MT (P55C) AMD K6-PR166/200 Cyrix/IBM 6x86L Cyrix M2	3.3V	2.85V	1-2	1-2
AMD K6-233	3.3V	3.2V	1-2	3-4

Table 2-5. The Jumpers for CPU Voltage

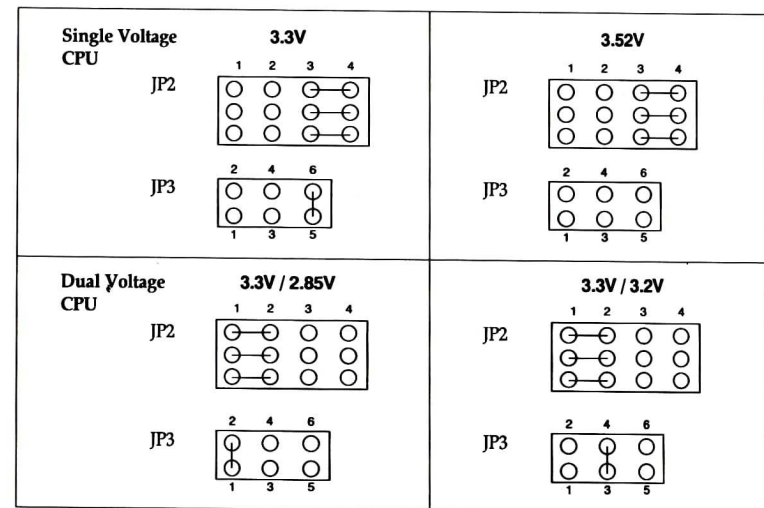

## Installation

### CPU Fan (J7) :

The CPU(Intel, Cyrix, AMD) needs one fan/heatsink installed on to help heat dissipation. **Do not** install Pentium Processor without the fan/heatsink.

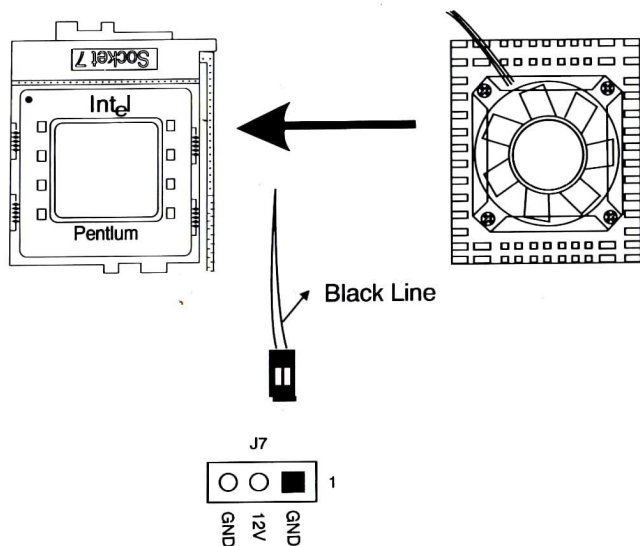

## Install Cables

### IDE Connector : (J16 & J17)

CB53X-VX provides 2 PCI IDE connectors which supports 2 ATAPI IDE devices(for example, Hard Drive and CD-ROM) on each connector. Use 40-pin IDE cable to connect IDE devices and IDE connector.

### FDD Connector : (J15)

CB53X-VX provides one floppy drive connector with one 34-pin floppy cable. It can support 2 floppy drivers with type : 360KB/720KB/1.2 MB/1.44MB or 3 mode.

## Installation

### Power Switch Connector(J5) :

CB53X-VX provides Power Switch connector. This connector is used to provide a way for user to turn the system on/off. Connecting it to the power on push-button on the front panel.

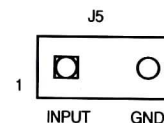

### IrDA [J19(7 Pin) / J18(5 Pin)] :

CB53X-VX is an IrDA-capable/Fast IR mainboard. It gives users IR wireless data exchange directly from mobile computers, printers and PDAs,.....etc.

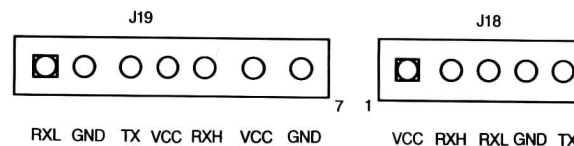

### 22-pin Front Panel Switch Connector : (J20)

In order to help quick install front panel switch, these headers are intergrated in 22-pin header set.

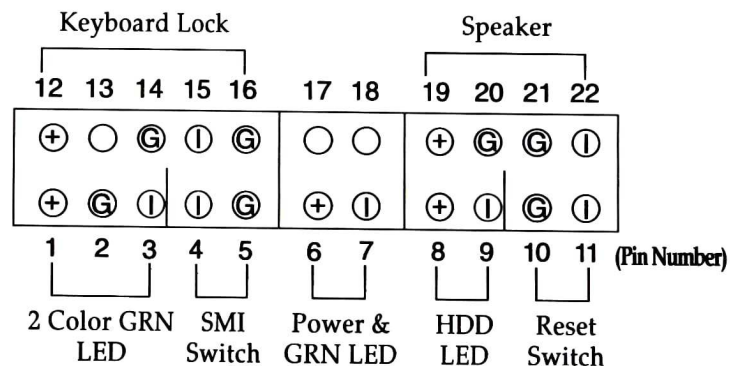

Connector	PIN NO	PIN NAME	Feature/Connect to
2 Color Green LED	1	VCC	Front Panel Power & GREEN mode LED GREEN MODE:LED blinking
	2	GND	
	3	GRN INPUT	
SMI Switch	4	INPUT	Suspend/Resume mode
	5	GND	
Power & GRN LED	6	VCC	2-pin Power & GREEN(Blinking) LED
	7	GRN INPUT	
HDD LED	8	VCC	Front Panel 2-pin HDD LED
	9	INPUT	
Reset Switch	10	GND	Reset System
	11	INPUT	
Keyboard Lock	12	VCC	Front Panel Keylock & 3-pin power LED
	13	N.C	
	14	GND	
	15	INPUT	
	16	GND	
Speaker	19	VCC	Front Panel External Speaker
	20	GND	
	21	GND	
	22	INPUT	

Table 2-6. Front Panel Switch Connector

**Power Supply Connector :**

CB53X-VX provides ATX power supply connectors(manufactured option)

J4 : ATX POWER SUPPLY CONNECTOR(20 PIN)

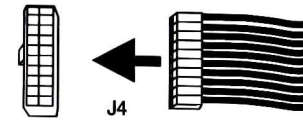

**PS/2 Keyboard & Mouse Connector : (J2)**

CB53X-VX provides one PS/2 keyboard and one PS/2 mouse connector. Follow the direction of keyboard(mouse) cable to install on keyboard(mouse) connector.

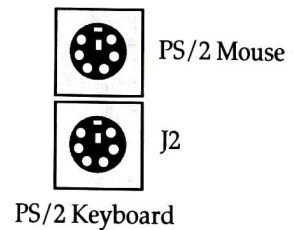

**USB Connector : (J6)**

Universal Serial Bus (USB) is a new industry standard interface for ease use of PC peripheral expansion.

**Serial Port COM1 and COM2 : (J8, J10)**

CB53X-VX provides two sets of high speed serial port. Each serial port is 16550 UART compatible.

**Parallel Port Printer Connector : (J9)**

CB53X-VX provides one set of high speed parallel port. The parallel port can support bidirection/EPP/ECP mode.

## Installation

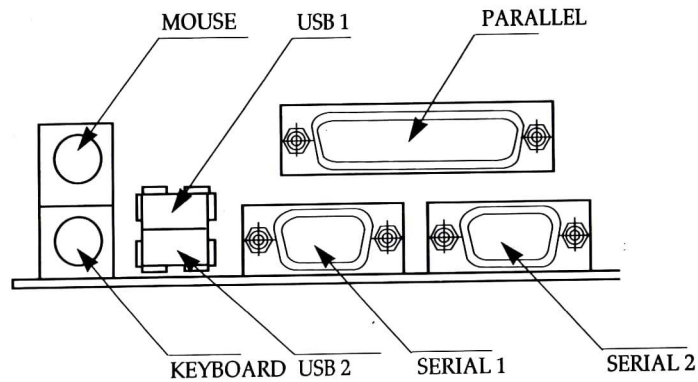

### Install Add-on Card

CB53X-VX provides four ISA slots and four PCI slots. ISA 4 and PCI 1 slots are shared and can not be installed at the same time.

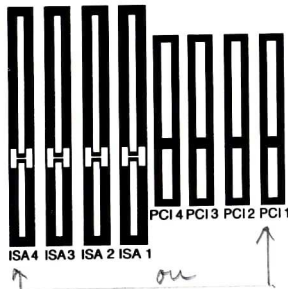

### Other Jumpers

#### Clear CMOS (JP6) and Password Check Switch (JP5)

BIOS setting values and password are stored in CMOS RAM. To clear CMOS Data of your computer, please open the computer chassis; short JP6 with short jumper; power on your system carefully; power off your system; then CMOS data will be cleared. For normal operation, please remove the short jumper from JP5 and close your computer chassis.

## Installation

To disable Password of your system, please short 1-2 of JP5.

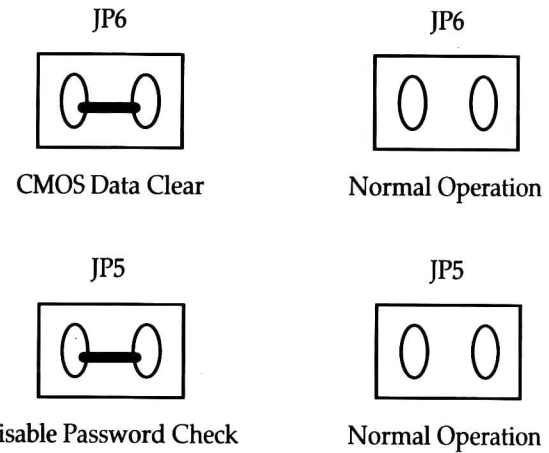

### Summary

#### Jumper Setting:

Jumper Block	Function	Configuration(Jumper short)
JP6	Clear CMOS	short : Disable open : Normal Operation
JP5	Password Check	short : Disable open : Normal Operation

Table 2-7. Jumper Settings

**Host Clock Setting:**

The table below presents the detailed Jumper Settings for different CPU Clock. Users can refer to this table for the reference if you cannot find out the proper CPU type on "Table 2-2, 2-3, 2-4, 2-5. Jumper Settings"

<b>Host Clock</b>	50 MHz	JP4	short 1-2, short 3-4
	55 MHz	JP4	short 3-4
	60 MHz	JP4	short 1-2
	66 MHz	JP4	open
<b>CPU Core Clock</b>	Host Clock* 1.5	JP9	short 2-3
		JP10	short 2-3
	Host Clock* 2	JP9	short 2-3
		JP10	short 1-2
	Host Clock* 2.5	JP9	short 1-2
JP10		short 1-2	
Host Clock* 3	JP9	short 1-2	
	JP10	short 2-3	
Host Clock* 3.5	JP9	short 2-3	
	JP10	short 2-3	

Table 2-8. Host Clock Settings

**Voltage Setting :**

<b>Single Voltage CPU</b>		JP2	short 3-4
<b>Power Split CPU</b>		JP2	short 1-2
<b>CPU Core Voltage</b>	3.3V	JP3	short 5-6
	3.525V	JP3	open
	2.85V	JP3	short 1-2
	3.2V	JP3	short 3-4

Table 2-9. Voltage Settings

**Connector Table:**

Connector	Function
J2	PS/2 Keyboard & Mouse Connector
J4	20 Pin ATX Power Connector
J5	Power Switch Connector(ATX)
J6	USB Port 1 & Port 2 Connector
J7	CPU Cooling FAN Header
J8	COM1/COM3 Port Connector
J9	Printer Port Connector
J10	COM2/COM4 Port Connector
J15	Floppy Disk Connector
J16	Primary Hard Disk Connector
J17	Secondary Hard Disk Connector
J18	Infrared (IR) Connector for HP
J19	Infrared (IR) Connector for FAST-IR(Manufactured Option)
J20	Front Panel Switch Connector

Table 2-10. Connectors

## **3** Built-In BIOS Setup Program

---

Before the computer can operate, it must know what devices are installed in it. These devices include floppy and fixed-disk drives, video, and so forth. Taken together, the presence or absence of these devices comprise the system configuration. Use the SETUP program to verify or change the system configuration.

Ordinarily, there should be no need to run SETUP the time you start your system, since your computer comes from the factory ready to use. You must, however, run the SETUP program each time you make any changes to your computer's configuration, such as adding drives, and so forth. You can also run it to verify the system configuration.

## SETUP

The SETUP program is permanently stored in a "Flash EEPROM" and not contained on disk. The SETUP program can be accessed :

- When powering up the system
- When resetting the system
- When the system detects an error and prompts for the SETUP program



### Accessing SETUP When Powering Up the System

To access the SETUP program when powering up the system, turn the computer power on. The system BIOS will first test the system components and then display a message similar to the following :

**Press <DEL> to enter setup**

Before the above message disappears, press the  key to activate the SETUP program.

### Accessing SETUP When Resetting the System

Reset the system by either pressing the reset button or the    key combination. The system will display the following message :



**Press <DEL> to enter setup**

Before the above message disappears, press  key to activate the SETUP program. You can prevent the system displaying this message using the SETUP prompt setting, described below.

### Accessing SETUP When the System Prompts for the SETUP Program

If the system BIOS detects a software or hardware error during the self-testing process, the system displays the following message :

**Press <F1> to continue, <DEL> to Enter SETUP**

Press  to continue the boot sequence or  to run SETUP

### Accessing SETUP Menus

SETUP provides access to primary menus from which you modify the system configuration. SETUP always displays the Main Menu when you start the program. Main menus include :

- STANDARD CMOS SETUP - This option allows users to check or modify the basic system configuration.
- BIOS FEATURE SETUP - This option is used to set the various system options for the users, including the virus warning, external cache, security option, boot operations, and video BIOS shadow, etc..
- CHIPSET FEATURES SETUP - This option allows users to control the features of chipset.



ROM PCI/ISA BIOS(CB53X-VX)  
CMOS SETUP UTILITY  
AWARD SOFTWARE, INC.

STANDARD CMOS SETUP	INTEGRATED PERIPHERALS
BIOS FEATURES SETUP	SUPERVISOR PASSWORD
CHIPSET FEATURES SETUP	USER PASSWORD
POWER MANAGEMENT SETUP	IDE HDD AUTO DETECTION
PNP/PCI CONFIGURATION	HDD LOW LEVEL FORMAT
LOAD BIOS DEFAULTS	SAVE & EXIT SETUP
LOAD SETUP DEFAULTS	EXIT WITHOUT SAVING
ESC : Quit	↑ ↓ → ← : Select Item
F10 : Save & Exit Setup	(Shift)F2 : Change Color
Time, Date, Hard Disk, Type ...	

Figure 3 -1. SETUP Main Menu



The instructions at the bottom of Main Menu Screen show the items of each option.

- **POWER MANAGEMENT SETUP** - This option allows users to set the power saving status for reducing the power consumption.
- **PNP/PCI CONFIGURATION SETUP** - This option is used to set the various system function and internal addresses of the PCI devices. Allows users to configure system IRQ and DMA to PCI/ISA PnP or Legacy ISA .
- **LOAD BIOS DEFAULTS** - Users can load the BIOS default values to boot the system safely.

- **LOAD SETUP DEFAULT** - This option supports the better performance for the system. It is recommended to choose this option for the setup.
- **INTEGRATED PERIPHERALS** - This option allows users to decide how many kinds peripherals need to change their I/O type , mode and used or not . This options also allows user to set the various system function and onboard PCI IDE controller.
- **SUPERVISOR PASSWORD** - Password is required when entering and changing all of the SETUP option or booting your system. Users can change the current password stored in the CMOS by accessing this option.
- **USER PASSWORD** - Password is required when booting your system and entering to change only the USER PASSWORD. Users can change the current password stored in the CMOS by accessing the option.
- **IDE HDD AUTO DETECTION** - This option can automatic detect the hard disk drive type(s) including the number of cylinders and heads, write precompensation time, read/write head landing zone, and number of sectors per track.
- **HDD LOW LEVEL FORMAT** - This provides a hard disk low level format utility.
- **SAVE & EXIT SETUP** - After saving the changes what you have made in the SETUP program, then exit and reboot the system.

## Built-In BIOS Setup Program

- EXIT WITHOUT SAVING - Abandon all previous settings, then exit and reboot the system.

After choosing an menu item from the SETUP main menu, move the cursor by using the (↑), (↓), (→), (←) Arrow keys and press (Enter ↵). To modify the setting of an option, simply press the (Page Up) or (+) and the (Page Down) or (-) keys. Press the (F2) key when changing the color setting, (F1) for a context sensitive help function, and the (Esc) key when quitting SETUP.

### Standard CMOS Setup

ROM PCI/ISA BIOS (CB53X-VX)  
STANDARD CMOS SETUP  
AWARD SOFTWARE, INC

Data (mm:dd:yy) : Thu, JUN 12 1997											
Time (hh:mm:ss) : 17 : 58 : 42											
HARD DISKS	TYPE SIZE CYLS HEAD PRECOMP LANDZ SECTOR MODE										
Primary Master	: Auto 0 0 0 0 0 0 Auto										
Primary Slave	: Auto 0 0 0 0 0 0 Auto										
Secondary Master	: Auto 0 0 0 0 0 0 Auto										
Secondary Slave	: Auto 0 0 0 0 0 0 Auto										
Drive A	: 1.44M, 3.5 in.										
Drive B	: None										
Video	: EGA/VGA										
Halt On	: All, But Keyboard										
<table border="0" style="width: 100%;"> <tr> <td style="width: 50%;">Base Memory : 640K</td> <td style="width: 50%;"></td> </tr> <tr> <td>Extended Memory : 31744K</td> <td></td> </tr> <tr> <td>Other Memory : 384K</td> <td></td> </tr> <tr> <td colspan="2"><hr/></td> </tr> <tr> <td colspan="2">TOTAL Memory : 32768K</td> </tr> </table>		Base Memory : 640K		Extended Memory : 31744K		Other Memory : 384K		<hr/>		TOTAL Memory : 32768K	
Base Memory : 640K											
Extended Memory : 31744K											
Other Memory : 384K											
<hr/>											
TOTAL Memory : 32768K											
ESC : Quit	↑ ↓ ← → : Select Item										
F1 : Help	PU/PD/+/- : Modify										
	(Shift)F2 : Change Color										

Figure 3 -2 SETUP Feature Setup Menu

## Built-In BIOS Setup Program

A. **Date** - Allows manual setting of the electronic calendar on the mainboard.

B. **Time** - Sets the system's internal clock which includes hour, minutes, and seconds.

C. **Primary Master/Primary Slave/Secondary Master/Secondary Slave** - Specifies the physical and electronic properties of the standard hard disk drives installed. Relevant specifications include the type, number of cylinders (CYLS), heads (HEAD), write pre-compensation time (PRECOMP), read/write head landing zone (LANDZ), number of sectors per track (SECTOR), and HDD mode (MODE). Selecting "AUTO" in the hard disk type item avoids the necessity of loading the HDD specifications and the function of the IDE HDD Auto Detection option in the main menu. The system BIOS will automatically detect the hard drive installed on the system upon bootup.

D. **Drive A/ B:** - Specifies the capacity and format of the floppy drive installed in your system.

E. **Video** - Specifies the display adapter installed.

F. **Halt On** - Enables the system to halt on several conditions/options. The default value is set at "All, But Keyboard."

G. **Base / Extended / Other Memory** - A small section in the lower right corner of the screen displays important information about your system which includes the base, extended, and other memory sizes. They are updated automatically by the SETUP program according to the status detected by the BIOS self-test. This section of the Standard CMOS SETUP screen is for viewing purpose only and manual modifications are not allowed.

**BIOS Feature SETUP**

ROM PCI/ISA BIOS (CB53X-VX)  
 BIOS FEATURES SETUP  
 AWARD SOFTWARE, INC.

Virus Warning	: Disabled	Video BIOS Shadow	: Enabled
CPU Internal Cache	: Enabled	C8000-CBFFF Shadow	: Disabled
External Cache	: Enabled	CC000-CFFFF Shadow	: Disabled
Quick Power On Self Test	: Enabled	D0000-D3FFF Shadow	: Disabled
Boot Sequence	: A,C,SCSI	D4000-D7FFF Shadow	: Disabled
Swap Floppy Drive	: Disabled	D8000-DBFFF Shadow	: Disabled
Boot Up Floppy Drive	: Enabled	DC000-DFFFF Shadow	: Disabled
Boot Up NumLock Status	: On		
Boot Up System Speed	: High		
GATE A20 Option	: FAST		
Typematic Rate Setting	: Disabled		
Typematic Rate (Chars/Sec)	: 6		
Typematic Delay (Msec)	: 250	ESC : Quit	↑ ↓ → ← : Select Item
Security Option	: Setup	F1 : Help	PU/PD/+/-: Modify
PCI/VGA Palette Snoop	: Disabled	F5 : Old Values (Shift)	F2 : Color
OS Select For DRAM > 64MB: Non-OS2		F6 : Load BIOS Defaults	
Report No FDD for WIN 95	: No	F7 : Load Setup Defaults	

Figure 3 -3. BIOS Features Setup Menu

**A. Virus Warning** - Allows the virus warning feature for the hard disk boot sector to display a warning message and produce a beep sound whenever an attempt is made to write on the hard disk's boot sector. The default value for this option is "Disabled."

**B. CPU Internal Cache** - Enables the internal code/data cache of CPU when set to "Enabled" (default).

**C. External Cache** - Enables the on-board secondary cache when set to "Enabled" (default).

**D. Quick Power On Self Test** - Allows the power on self test to run at either a fast or a normal speed. The available options are:  
 - Enabled - Disabled (default)

**E. Boot Sequence** - Selects the drive where the system would search for the operating system to run with. The available options are:

- |                      |             |
|----------------------|-------------|
| A, C, SCSI (default) | C, A, SCSI  |
| C, CDROM, A          | CDROM, C, A |
| D, A, SCSI           | E, A, SCSI  |
| F, A, SCSI           | SCSI, A, C  |
| SCSI, C, A           | C only      |
| LS120                |             |

**F. Swap Floppy Drive** - "Enabled" will effectively change the A: drive to B: and the B: to A: drive. "Disabled" (default) sets the floppy drives in their default states.

- |                   |         |
|-------------------|---------|
| Disabled(default) | Enabled |
|-------------------|---------|

**G. Boot Up Floppy Seek** - Check if the floppy drives installed on the system are correct or not. This option's operation usually occurs when the magnetic heads of the floppy drives produce a sound during power on self test. The available options are:

- |                    |            |
|--------------------|------------|
| - Enabled(default) | - Disabled |
|--------------------|------------|

## *Built-In BIOS Setup Program*

**H. Boot Up NumLock Status** - This allows users to determine the default state of the numeric keypad. By default, the system boots up with NumLock on.

- On (default)                      - Off

**I. Boot Up System Speed** - Sets the speed of the system during power on self test sequence. The available options are :

- High (default)                      - Low

**J. Gate A20 Option** - Boots the performance of system with software using the 80286 protected mode such as OS/2 UNIX. This option determines the accessibility of the extended memory. The available options are :

- FAST (default)                      - Normal

**K. Typematic Rate Setting** - Defines the setting of the keyboard's typematic rate. The available options are :

- Disabled (default)                      - Enabled

**L. Typematic Rate <Char/Sec>** - Specifies the key repeat rate, in seconds, of keyboard character. The available options are :

- 6 (default)                              - 8/10/12/15/20/24/30

**M. Typematic Delay <Msec>** - Select the delay, in milliseconds, before a key repeat. The available options are :

- 250 (default)                              - 500/750/1000

## *Built-In BIOS Setup Program*

**N. Security Option** - Determines whether the password will be asked for in every boot (System), or when entering into the SETUP program (Setup - default). Refer to the section entitled SUPERVISOR PASSWORD for the password setting.

**O. PCI/VGA Palette Snoop** -Selects "Enabled" to solve the abnormal color in Windows while using ISA MPEG and PCI VGA card. The available options are:

- Disabled (default)                      - Enabled

**P. OS Select For DRAM > 64MB** - Selects the OS if DRAM > 64MB. The available options are:

- Non-OS2 (default)                      - OS2

**Q. Video BIOS Shadow** - Enables the system shadowing and achieve the best performance of the system. The available options are:

- Enabled (default)                      - Disabled

**R. C8000-CBFFF, CC000-CFFFF, D0000-D3FFF, D4000-D7FFF, D8000-DBFFF, DC000-DFFFF Shadow** - If you have a shadowing of the BIOS at any of the above segments, you may set the appropriate memory cacheable function to "Enabled". Otherwise, select "Disabled" (default).

**S. Report No FDD For WIN 95** - This option supports IRQ6 for passing windows 95 Logo. If you pass SCT for passing windows 95 Logo, sets this option to "Yes". The default value for this option is "No".

**Chipset Features Setup**

ROM PCI/ISA BIOS (CB53X-VX)  
 CHIPSET FEATURES SETUP  
 AWARD SOFTWARE, INC.

Auto Configuration	: Enabled	Delayed Transaction	: Disabled
DRAM Timing	: 60ns	Memory Address Drive Str.:	16mA
DRAM RAS# Precharge Time	: 3		
DRAM R/W Leadoff Timing	: 6		
Fast RAS To CAS Delay	: 3		
DRAM Read Burst <EDO/FP>	: x222/x333		
DRAM Write Burst Timing	: x222		
Fast MA to RAS# Delay CLK	: 1		
Fast EDO Path Select	: Disabled		
Refresh RAS# Assertion	: 4 Clks		
ISA Bus Clock	: PCICLK/3		
SDRAM <CASLat/RAS-to-CAS>	: 3/3		
System BIOS Cacheable	: Enabled		
Video BIOS Cacheable	: Enabled	ESC : Quit	↑ ↓ → ← : Select Item
8 Bit I/O Recovery Time	: 2	F1 : Help	PU/PD/+/- : Modify
16 Bit I/O Recovery Time	: 3	F5 : Old Values	(Shift)F2 : Color
Memory Hole At 15M-16M	: Disabled	F6 : Load BIOS Defaults	
Peer Concurrency	: Enabled	F7 : Load Setup Defaults	
Passive Release	: Enabled		

Figure 3 -4 Chipset Features Setup Menu

**A. Auto Configuration** - Loads the default values, if "Enabled" (default), for the following DRAM and cache options. Otherwise, "Disabled" allows you to program each option as required.

- Enabled (default)
- Disabled



The following items are controlled by Auto Configuration when users select "Enabled". For this reason, their default values will be changed by the speed of CPU. These items are: "DRAM Leadoff Timing", "DRAM Read <EDO/FP>", "DRAM Write Burst Timing", "Fast EDO Leadoff" and "Refresh RAS# Assertion".

**B. DRAM Timing** - Configures the DRAM read/write timing for the maximum performance. The available options are :

- 60ns (default)
- 70ns

**C. DRAM RAS# Precharge Time** - DRAM must continually be refreshed or it will lose its data. Normally, DRAM is refreshed entirely as the result of a single request. This option allows you to determine the number of CPU clocks allocated for the Row Address Strobe to accumulate its charge before the DRAM is refreshed. If insufficient time is allowed, refresh may be incomplete and data lost. The available options are :

- 3 (default)
- 4

**D. DRAM R/W Leadoff Timing** - Determines the leadoff time for R/W to the Cache. The available options are :

- 6(default)
- 7

**E. Fast RAS To CAS Delay** - Selects the RAS-to-CAS delay time for DRAM access. The available options are :

- 3 (default)
- 2

**F. DRAM Read Burst <EDO/FP>** - Determines the timing for burst read to the cache . If your DRAM type is EDO DRAM, we suggest you select

## Built-In BIOS Setup Program

x222 (EDO) timing to get a better performance. The available options are :

- x222 / x333 (default)
- x322 / x333
- x444 / x444
- x333 / x444

**G. DRAM Write Burst Timing** - Determines the timing for burst write to the cache. If your DRAM type is EDO DRAM , we suggest you select x222 (EDO) timing to get a better performance.

The available options are :

- x222 (default)
- x333
- x444

**H. Fast MA to RAS# Delay CLK** - Selects the option for DRAM access. The available options are :

- 1 (default)
- 2

**I. Fast EDO Path Select** - The selection of the EDO fast path for read cycles. The available options are :

- Disabled(default)
- Enabled

**J. Refresh RAS# Assertion** - Determines the number of clocks RAS# is asserted for Refresh cycles. The available options are :

- 4 Clks (default)
- 5 Clks

**K. ISA Bus Clock** - ISA clock divide by 4 or 3 depending on PCI bus clock. Users can refer to the formula for clear figure. (ISA Clock=PCI Clock/3 or ISA Clock=PCI Clock/4). The available options are :

- PCICLK/3 (default)
- PCICLK/4

## Built-In BIOS Setup Program

**L. SDRAM (CAS Lat / RAS-to-CAS)** - Configs the SDRAM CAS latency time / RAS to CAS delay. The available options are :

- 3/3 (default)
- 3/2

**M. System BIOS Cacheable** - Allows caching of the different segments where there is system BIOS shadowing. The available options are :

- Enabled(default)
- Disabled

**N. Video BIOS Cacheable** - Allows caching of the different segments where there is video BIOS shadowing. The available options are :

- Enabled(default )
- Disabled

**O. 8 Bit I/O Recovery Time** - Defines the 8-bit I/O recovery time with one of the following system clock options. The available options are :

- 2 (default)
- 1/3/4/5/6/7/8
- N/A

**P. 16 bit I/O Recovery Time** - Defines the 16-bit I/O recovery time with one of the following system clock options. The available options are :

- 3 (default)
- 1/2/4
- N/A

**Q. Memory Hole At 15M-16M** - Enables this option to reserve the certain space in memory for ISA cards. The available options are:

- Disabled (default)
- Enabled

**R. Peer Concurrency** - Determines whether or not the CPU allowed to run DRAM/L2 cycles when non-PHLD PCI master devices are targeting peer device. The available options are:

- Enabled (default)
- Disabled

**Power Management Setup**

ROM PCI/ISA BIOS (CB53X-VX)  
Power MANAGEMENT SETUP  
AWARD SOFTWARE, INC.

Power Management	: User Define	** Reload Global Timer Events**
PM Control by APM	: Yes	IRQ 3 (COM 2) : ON
Video Off Method	: V/H SYNC	IRQ 4 (COM 1) : ON
	+ Blank	IRQ 5 (LPT 2) : ON
MODEM Use IRQ	: 3	IRQ 6 (Floppy Disk) : OFF
		IRQ 7 (LPT 1) : ON
Doze Mode	: 4 Min	IRQ 8 (RTC Alarm) : OFF
Standby Mode	: 10 Min	IRQ 9 (IRQ2 Redir) : OFF
Suspend Mode	: 10 Min	IRQ 10 (Reserved) : OFF
HDD Power Down	: Disabled	IRQ 11 (Reserved) : OFF
		IRQ 12 (PS/2 Mouse) : ON
**Wake Up Events In Doze & Standby**		IRQ 13 (Coprocesor) : ON
IRQ 3 (Wake-Up Event)	: On	IRQ 14 (Hard Disk) : ON
IRQ 4 (Wake-Up Event)	: On	IRQ 15 (Reserved) : ON
IRQ 8 (Wake-Up Event)	: On	
IRQ 12 (Wake-Up Event)	: On	
		ESC : Quit ↑ ↓ → ← : Select Item
		F1 : Help PU/PD/+/- : Modify
		F5 : Old Values (Shipt)F2 : Color
		F6 : Load Bios Default
		F7 : Load Setup Defaults

Figure 3 -5 Power Management Setup Screen

**A. Power Management** - Allows user determine how often the Power Saving activating . The available options are :

- User Define (default)      - Max Saving
- Min Saving                      - Disable

**B. PM Control by APM** - Sets the power management (PM) control by the APM. The available options are :

- Yes (default)                      - No

**C. Video Off Method** - Sets the video power green method . The available options are :

- V/H SYNC+Blank (default)      - DPMS
- Blank Screen

**D. Doze Mode** - Sets the time interval after system inactivity when the system enters Doze mode. The available options are :

- 4 Min (default)                      - 1 Hour
- 1/2/6/8/12/20/30/40 Min      - Disabled

**E. Standby Mode** -Sets the timer interval after system inactivity when the system enters STANDBY mode. The available options are :

- 10 Min (default)                      - 1 Hour
- 1/2/4/6/8/12/20/30/40 Min      - Disabled

**F. Suspend** - Sets the time interval after system inactivity when the system enters SUSPEND mode. The available options are :

- 10 Min (default)                      - 1 Hour
- 1/2/4/6/8/12/20/30/40 Min      - Disabled

**G. HDD Power Down** - Sets the interval time to power down HDD. The available options are :

- Disabled (default)                      - 1....15 Min

**H. Wake Up Events In Doze & Standby**

**H-1 IRQ 3/4/8/12 (Wake-Up Event)** - Sets the wake-up event to **ON** or **OFF** while system enters the suspend mode.

**I. Power Down & Resume Events**

**I-1 Power Down Activities** - The manual also lists the Power Management **SETUP (PM)** events by which the system wakes up from **STANDBY** or **SUSPEND** modes. Switch the following parameters to **ON** or **OFF** :

**PNP/PCI Configuration Setup**

ROM PCI/ISA BIOS (CB53X-VX)  
PNP/PCI CONFIGURATION  
AWARD SOFTWARE, INC

PNP OS Installed	: Yes	PCI IRQ Artivity By	: Level
Resources Controlled By	: Auto	PCI IDE 2nd Channel	: Disabled
Reset Configuration Data	: Disabled	PCI IDE IRQ Map To	: PCI-AUTO
		Primary IDE INT#	: A
		Secondary IDE INT#	: B
		ESC : Quit      ↑ ↓ ← → : Select Item	
		F1 : Help      UP/DN/+/- : Modify	
		F5 : Old Values (Shipt) F2 : Color	
		F6 : Load Bios Default	
		F7 : Load Setup Defaults	

Figure 3-6 PNP/PCI Configuration Setup Screen



**A. Resources Controlled By** - Allows user what kind IRQs assignment to be used. "Manual" or "Automatic" definition. The available options are :

- Auto (default)
- Manual



The default of "Resources Controlled By" is Auto. If users set Manual option for the setting "IRQ-3/IRQ-5/IRQ-7/IRQ-9/IRQ-10/IRQ-11/IRQ-12/IRQ-14/IRQ-15/DMA-0/DMA-1/DMA-3/DMA-5/DMA-6/DMA-7 assigned to" options below will be shown on the screen.

**B. Reset Configuration Data** - To clear the ESCD data which is stored in flash ROM, please set "Enable". This is a one short switch. After clearing the ESCD, the BIOS will change the value back to "Disabled" The available option are :

- PCI-AUTO (default)
- ISA
- PCI-SLOT1
- PCI-SLOT2
- PCI-SLOT3
- PCI-SLOT4



If user sets this option to "ISA", both the "Primary IDE INT#" and "Secondary IDE INT#" options below will not be shown on the screen.

**C. IRQ-3/IRQ-4/IRQ-5/IRQ-7/IRQ-9/IRQ-10/IRQ-11/IRQ-12/IRQ-14/IRQ-15/DMA-0/DMA-1/DMA-3/DMA-5/DMA-6/DMA-7 assigned to** - Users can select resources controlled by manual method to fix legacy ISA card IRQ & DMA in Plug & IRQ# & DMA# which one assigned by manual.

The available option are :

- PCI/ISA PnP (default)
- Legacy ISA

**D. PCI IRQ Activated By** - Programs the PCI IRQ to single edge or logic level. Level/Edge sensitivity is programmed per controller. Every IRQ input for a given bank is either *EDGE* or *LEVEL* (default) triggered.

**E. PCI IDE 2nd Channel** - If you designate a higher performance IDE board into the physical PCI slot(certainly, you must disable On-chip IDE controller), this item allows you to turn on the 2nd channel of this external board.

**F. Primary IDE INT#** - Selects a PCI Interrupt pin which will be used by the primary channel of a PCI IDE card. The available options are :

- A (default)
- B/C/D

**G. Secondary IDE INT#** - Selects a PCI Interrupt pin which will be used by the secondary channel of a PCI IDE card. The available options are :

- B (default)
- A/C/D

### Load BIOS Defaults

In the event of a loss in memory on the configuration SETUP, the user can restore the information on the BIOS by default values. Loading the BIOS defaults provides safety booting of the system.

**Load SETUP Defaults**

SETUP defaults are considered default values with which the system will be enabled to perform better. This due to the enabling of some options within the SETUP program. However, if problems are encountered after loading the Optimum Setting, reboot the system and load the BIOS defaults instead.

**INTEGRATED PERIPHERALS**

**A. IDE HDD Block Mode** - Determines whether block transfer mode want to use or not. The available options are :

- Enabled(default)
- Disabled

**B. IDE Primary/Second Master/Slave PIO** - Sets the advanced hard disk PIO transfer mode which effects your hard disk transfer rate. The program will auto detect the mode of this option you select "Auto". Otherwise, you must set this option by yourself. The available options are :

- Auto (default)
- Mode 0
- Mode 1
- Mode 2
- Mode 3
- Mode 4

**C. On-Chip Primary/Secondary PCI IDE** - Enables or Disables the primary/secondary PCI IDE of IDE controller.

- Enabled (default)
- Disabled

**D. USB Controller** - Enables or Disables the USB function of Intel on-board chip. The available options are :

- Disabled (default)
- Enabled

**E. Onboard FDD Controller** - Enables or Disables the FDD On-board controller. The available options are :

- Enabled (default)
- Disabled

**F. OnBoard Serial Port 1/2** - Sets the I/O address for serial port 1/2.

- Auto
- 2F8 / IRQ3
- 3E8 / IRQ4
- 3F8 / IRQ4
- 2E8 / IRQ3
- Disabled

**G. OnBoard Parallel Port** - Sets the I/O address for the parallel port.

The available options are :

- 378h / IRQ7 (default)
- Disabled
- 278h / IRQ5
- 3BCh / IRQ7

**H. OnBoard Parallel Mode** - Selects the working mode of parallel port.

The available options are :

- SPP (default)
- ECP/EPP
- EPP/SPP
- ECP

**I. Infra Red(IR) Function** - Determines which type IR module want to use. The available options are :

- Disabled (default)
- ASKIR
- HPSIR
- Standard

**J. Onboard Parallel Port** - Sets the I/O address for the parallel port.

The available options are :

- 378h/IRQ7 (default)
- Disabled
- 278h/IRQ5
- 3BCh/IRQ7

**Built-In BIOS Setup Program**



If users set this options to "Disabled", the "Onboard Parallel Mode" option below will not be shown on the screen.

**K. Onboard Parallel Mode** - Selects the working mode of parallel port.

The available options are :

- ECP/EPP (default)      - SPP
- EPP/SPP                      - ECP



1. If users set this options to "SPP" or "EPP/SPP", The "ECP Mode Use DMA" options below will not be shown on the screen.

2. If users set this options to "SPP" or "ECP", the "Parallel Poort EPP Type" options below will not be shown on the screen.

**Built-In BIOS Setup Program**

ROM PCI/ISA BIOS (CB53X-VX)  
 INTEGRATED PERIPHERALS  
 AWARD SOFTWARE, INC.

IDE HDD Block Mode	: Enabled	
IDE Primary Master PIO	: Auto	
IDE Primary Slave PIO	: Auto	
IDE Secondary Master PIO	: Auto	
IDE Secondary Slave PIO	: Auto	
On-Chip Primary PCI IDE	: Enabled	
On-Chip Secondary PCI IDE	: Enabled	
USB Controller	: Disabled	
Onboard FDD Controller	: Enabled	
Onboard Serial Port 1	: COM1/3F8	
Onboard Serial Port 2	: COM2/2F8	
Infra Red (IR) Function	: Disabled	ESC : Quit    ↑ ↓ → ← : Select Item
OnBoard Parallel Port	: 378/IRQ7	F1 : Help        up/dn/+/- : Modify
OnBoard Parallel Mode	: EPP+SPP	F5 : Old Values (Shipt) F2 : Color
ECP Mode Use DMA	: 3	F6 : Load Bios Default
IR Transfer Mode	: Half-Dup	F7 : Load Setup Defaults

Figure 3 -7 Integrated Peripheral Setup Screen

### **SUPERVISOR PASSWORD**

The SUPERVISOR PASSWORD utility allows you to set, change, and disable the password which is stored in the BIOS. To change the password setting, press <Enter> on the SUPERVISOR PASSWORD option of the main menu and then type the new password.

Configure the Security Option within the BIOS Features Setup corresponding to the setting in the utility. SUPERVISOR PASSWORD access right is higher than USER PASSWORD.

The password can be at most 8 characters long. The program will require you to confirm the new password before it exits and enables the utility. To disable the SUPERVISOR PASSWORD, press the <F1> when the program asks you to enter the new password.

### **USER PASSWORD**

USER PASSWORD only can be used when the system is booting. Users only can enter SETUP screen to change the USER PASSWORD.

The password can be at most 8 characters long. The program will require you to confirm the new password before it exits and enables the utility. To disable the USER PASSWORD, press the <F1> as the program asks you to enter the new password.

### **IDE HDD Auto Detection**

The IDE HDD Auto Detection provides auto configuration of the hard drive installed in the system. It supports LBA, Large, and Normal modes. If the system's hard disk drive has a capacity of over 528MB and supports LBA functions, you may enable either the LBA mode or the Large mode. On the other hand, if the hard disk drive's capacity is over 528MB but does not support LBA functions, you may enable the Large mode in order to use over 528MB.



- a. The LBA and Large modes will only appear on the screen when the installed hard disk drive is specified to support the LBA mode.
- b. In the case when a hard disk drive's cylinder specification exceeds 1024, and does not support the LBA function, only the Large mode will be displayed on the screen.
- c. With a hard disk drive supporting cylinders below 1024, only the Normal mode will be appear on the screen. The Normal mode will also be shown on the screen under conditions a & b above.
- d. Hard disk drives with less than 528MB total capacity must be set to Normal mode when combined with either old BIOS versions or the Award BIOS. LBA and Large modes are new specifications which may not be fully supported by all operating systems. An example of which is the current version of UNIX System (R3.2.4) which is still unable to support the LBA function. Therefore, determine the specifications of your hard disk drive and operating system before selecting the drive's mode.

ROM PCI/ISA BIOS(CB53X-VX)  
 HDD AUTO DETECTION  
 AWARD SOFTWARE. INC

HDD DISKS	TYPE	SIZE	CYLS	HEAD	PRECOMP	LANDZ	SECTOR	MODE
Primary Master :								
Select Primary Master Option (N=Skip) : N								
OPTIONS	SIZE	CYLS	HEAD	PRECOMP	LANDZ	SECTOR	MODE	
2(Y)	1674	811	64	0	3243	63	LBA	
1	1674	3244	16	65535	3243	63	NORMAL	
3	1674	811	64	65535	3243	63	LARGE	
Note : Some OSes (like SCO-UNIT) must use "NORMAL" for Installation								
ESC : Skip								

Figure 3-8 IDE HDD Auto Detection Screen

After pressing the <Enter> key on this item of the main menu, the display screen will show the above screen.

Once the program detects the type of hard disk installed, it will display the relative information such as the type, cylinders, heads, write pre-compensation, landing zone, number of sectors per track, size and mode. A message asking you to accept the IDE HDD detected will also be flashed on the screen.

**HDD Low Level Format**

Use the Up and Down key to move around the selections displayed on the upper Screen. Press Enter to accept the selection. Press ESC to abort the selection or exit this menu.

Hard Disk Low Level Format							NO. CYLS HEAD	
SELECT DRIVE BAD TRACK LIST PERFORMANCE								
Current select drive : C								
Drive : C	CYLINDER : 0		HEAD : 0					
	SIZE	CYLS	HEAD	PRECOMP	LANDZ	SECTOR	MODE	
Primary Master	1674	3244	16	65536	3243	63	Auto	
Primary Slave	0	0	0	0	0	0	Auto	
Secondary Master	0	0	0	0	0	0	Auto	
Secondary Slave	0	0	0	0	0	0	Auto	
UP/Down-Select item			Enter-Accept			ESC-Exit/Abort		
Copyright (c) Award Software, Inc. 1992-97 All Right Reserved								

Figure 3-9 HDD Low Level Format menu Screen

**A. Select Drive** - Select from installed hard disk drive C or D. Listed at the bottom of the screen is the drive automatically detected by the utility.

**B. Auto Scan Bad Track** - Automatically scan bad tracks and list the bad tracks in the window at the right side of the screen.

**C. Add bad Track** - Directly type in any information about known bad tracks in the window at the right side of the screen.

## *Built-In BIOS Setup Program*

**D. Modify Bad Track** - Modify information about the bad tracks in the window at the right side of the screen.

**E. Delete Bad Track** - Delete the added bad tracks in the windows at the right side of the screen.

**F. Clear Bad Track Table** - Clear the whole bad track list in the windows at the right side of the screen.

**G. Interleave** - Select the interleave number of the hard disk drive you wish to perform low level format. You may select from 1 to 8. Check the documentation that came with the drive for the correct interleave number, or select 0 for utility automatic detection.

**H. Auto Scan Bad Track** - This allow the utility to scan for bad sector first then by each track.

## *Built-In BIOS Setup Program*

### Quitting SETUP

After making all modifications in the SETUP program, go to the option "Save & Exit SETUP" then press the <Enter> key. The program will display the following screen.

Press <Y> to confirm the changes made, and the <N> or the <Esc> keys if further modifications are sill necessary before exiting the SETUP program. Once the <Y> key in pressed, the system will automatically exit the program and reboot.

However, if you want cancel all changes made under the SETUP program, go to the options "Exit Without Saving"

Press <Y> and the system will wait the SETUP program then reboot without saving any of the change made.



You may also use the <F10> key to save the new settings.

DA

---

**DAEWOO**  
DAEWOO TELECOM LTD.

P/N:9919540301

DAEWOO TELECOM HEAD OFFICE  
14-34, Youido-Dong, Youngdungpo-Gu,  
Seoul, Korea

## DECLARATION OF CONFORMITY

This device complies with Part 15 of the FCC Rules. Operation is subject to the following two conditions: (1) this device may not cause harmful interference, and (2) this device must accept any interference received, including interference that may cause undesired operation.

**Trade Name/Model:** *Daewoo*<sup>®</sup> *CB53X-VX*

**Responsible Party:** **DAEWOO TELECOM LTD.**

**Address:** 1055 W. Victoria Street  
Compton, CA 90220

**Contact Person:** Mr. D. K. Kim

**Telephone No.:** (310) 609-2288

**Equipment Classification:** FCC Class B Subassembly - CPU Board  
**Type of Product:** Pentium<sup>®</sup> (MMx<sup>™</sup>) PCI/ISA ATX Motherboard  
**CPU / Processor(s):** Intel<sup>®</sup> Pentium<sup>®</sup> or Pentium MMx<sup>™</sup>  
**CPU Frequencies:** 233/200/166MHz MMx<sup>™</sup>  
or: 200/166/150/133/120/10/90/75 MHz  
**Main Chipset:** Intel<sup>®</sup> 430VX PCiset SB82437VX & SB82371SB  
**Manufacturer:** **DAEWOO TELECOM LTD.**  
**Address:** Daewoo Bldg., 8th Fl., 14-34 Youido-Dong  
Youngdungpo-Gu 150-010, Seoul, KOREA

*We hereby declare that the equipment bearing the trade name and model number specified above was tested conforming to the applicable FCC Rules under the most accurate measurement standards possible, and that all the necessary steps have been taken and are in force to assure that production units of the same equipment will continue to comply with the Commission's requirements.*

**DAEWOO TELECOM LTD.**



Signature

007-1-1997

Date