

Intel® Desktop Board D425KT and Intel® Desktop Board D425KTW Technical Product Specification

July 2010

Order Number: E98415-001US

The Intel® Desktop Board D425KT and Intel® Desktop Board D425KTW may contain design defects or errors known as errata that may cause the product to deviate from published specifications. Current characterized errata are documented in the Intel Desktop Board D425KT and Intel Desktop Board D425KTW Specification Update.

Revision History

Revision	Revision History	Date
-001	First release of the Intel® Desktop Board D425KT and Intel® Desktop Board D425KTW Technical Product Specification.	July 2010

This product specification applies to only the standard Intel® Desktop Board D425KT and Intel® Desktop Board D425KTW with BIOS identifier MWPNT10N.86A

Changes to this specification will be published in the Intel Desktop Board D425KT and Intel Desktop Board D425KTW Specification Update before being incorporated into a revision of this document.

INFORMATION IN THIS DOCUMENT IS PROVIDED IN CONNECTION WITH INTEL® PRODUCTS. NO LICENSE, EXPRESS OR IMPLIED, BY ESTOPPEL OR OTHERWISE, TO ANY INTELLECTUAL PROPERTY RIGHTS IS GRANTED BY THIS DOCUMENT. EXCEPT AS PROVIDED IN INTEL'S TERMS AND CONDITIONS OF SALE FOR SUCH PRODUCTS, INTEL ASSUMES NO LIABILITY WHATSOEVER, AND INTEL DISCLAIMS ANY EXPRESS OR IMPLIED WARRANTY, RELATING TO SALE AND/OR USE OF INTEL PRODUCTS INCLUDING LIABILITY OR WARRANTIES RELATING TO FITNESS FOR A PARTICULAR PURPOSE, MERCHANTABILITY, OR INFRINGEMENT OF ANY PATENT, COPYRIGHT OR OTHER INTELLECTUAL PROPERTY RIGHT. UNLESS OTHERWISE AGREED IN WRITING BY INTEL, THE INTEL PRODUCTS ARE NOT DESIGNED NOR INTENDED FOR ANY APPLICATION IN WHICH THE FAILURE OF THE INTEL PRODUCT COULD CREATE A SITUATION WHERE PERSONAL INJURY OR DEATH MAY OCCUR.

Intel Corporation may have patents or pending patent applications, trademarks, copyrights, or other intellectual property rights that relate to the presented subject matter. The furnishing of documents and other materials and information does not provide any license, express or implied, by estoppel or otherwise, to any such patents, trademarks, copyrights, or other intellectual property rights.

Intel may make changes to specifications and product descriptions at any time, without notice.

Designers must not rely on the absence or characteristics of any features or instructions marked "reserved" or "undefined." Intel reserves these for future definition and shall have no responsibility whatsoever for conflicts or incompatibilities arising from future changes to them.

Intel® Desktop Boards may contain design defects or errors known as errata, which may cause the product to deviate from published specifications. Current characterized errata are available on request.

Contact your local Intel sales office or your distributor to obtain the latest specifications before placing your product order.

Copies of documents which have an ordering number and are referenced in this document, or other Intel literature, may be obtained from:

Intel Corporation
P.O. Box 5937
Denver, CO 80217-9808

or call in North America 1-800-548-4725, Europe 44-0-1793-431-155, France 44-0-1793-421-777, Germany 44-0-1793-421-333, other Countries 708-296-9333.

Intel, the Intel logo, and Intel Atom are trademarks of Intel Corporation in the United States and other countries.

* Other names and brands may be claimed as the property of others.

Copyright © 2010, Intel Corporation. All rights reserved.

Preface

This Technical Product Specification (TPS) specifies the board layout, components, connectors, power and environmental requirements, and the BIOS for the Intel® Desktop Board D425KT and Intel® Desktop Board D425KTW. It describes the standard product and available manufacturing options.

Intended Audience

The TPS is intended to provide detailed, technical information about the Intel Desktop Board D425KT and Intel Desktop Board D425KTW and its components to the vendors, system integrators, and other engineers and technicians who need this level of information. It is specifically *not* intended for general audiences.

What This Document Contains

Chapter	Description
1	A description of the hardware used on the board
2	A map of the resources of the board
3	The features supported by the BIOS Setup program
4	A description of the BIOS error messages, beep codes, and POST codes
5	Regulatory compliance and battery disposal information

Typographical Conventions

This section contains information about the conventions used in this specification. Not all of these symbols and abbreviations appear in all specifications of this type.

Notes, Cautions, and Warnings



NOTE

Notes call attention to important information.



CAUTION

Cautions are included to help you avoid damaging hardware or losing data.

Intel Desktop Board D425KT and Intel Desktop Board D425KTW Technical Product Specification

Other Common Notation

#	Used after a signal name to identify an active-low signal (such as USBP0#)
GB	Gigabyte (1,073,741,824 bytes)
GB/s	Gigabytes per second
Gbit	Gigabit (1,073,741,824 bits)
KB	Kilobyte (1024 bytes)
Kbit	Kilobit (1024 bits)
kbits/s	1000 bits per second
MB	Megabyte (1,048,576 bytes)
MB/s	Megabytes per second
Mbit	Megabit (1,048,576 bits)
Mbit/s	Megabits per second
xxh	An address or data value ending with a lowercase h indicates a hexadecimal value.
x.x V	Volts. Voltages are DC unless otherwise specified.
*	This symbol is used to indicate third-party brands and names that are the property of their respective owners.

Contents

1	Product Description	9
1.1	Overview.....	9
1.1.1	Feature Summary	9
1.1.2	Board Layout	11
1.1.3	Block Diagram	13
1.2	Online Support.....	14
1.3	Processor	14
1.3.1	Intel D425 Graphics Subsystem.....	15
1.4	System Memory	16
1.5	Intel® NM10 Express Chipset.....	17
1.5.2	USB	19
1.5.3	SATA Support	19
1.6	Real-Time Clock Subsystem	20
1.7	Legacy I/O Controller	20
1.8	LAN Subsystem.....	21
1.8.1	LAN Subsystem Drivers	21
1.8.2	RJ-45 LAN Connector with Integrated LEDs	22
1.9	Audio Subsystem.....	23
1.9.1	Audio Subsystem Software	24
1.9.2	Audio Connectors and Headers	24
1.10	Hardware Management Subsystem	25
1.10.1	Hardware Monitoring.....	25
1.10.2	Thermal Monitoring	26
1.11	Power Management	27
1.11.1	ACPI.....	27
1.11.2	Hardware Support	30
2	Technical Reference	33
2.1	Memory Map.....	33
2.1.1	Addressable Memory.....	33
2.2	Connectors and Headers.....	36
2.2.1	Back Panel	37
2.2.2	Component-side Connectors and Headers	39
2.3	BIOS Configuration Jumper Block.....	49
2.4	Mechanical Considerations	51
2.4.1	Form Factor.....	51
2.5	Electrical Considerations.....	52
2.5.1	Fan Header Current Capability.....	52
2.5.2	Add-in Board Considerations	52
2.6	Thermal Considerations.....	52
2.6.1	Passive Heatsink Design in a Passive System Environment	54

Intel Desktop Board D425KT and Intel Desktop Board D425KTW Technical Product Specification

2.7	Power Consumption	57
2.7.1	Minimum Load Configuration	57
2.7.2	Maximum Load Configuration	57
2.8	Reliability	58
2.9	Environmental	59
3	Overview of BIOS Features	61
3.1	Introduction	61
3.2	BIOS Flash Memory Organization	62
3.3	Resource Configuration	62
3.3.1	PCI* Autoconfiguration.....	62
3.4	System Management BIOS (SMBIOS).....	63
3.5	Legacy USB Support	64
3.6	BIOS Updates	65
3.6.1	BIOS Recovery.....	65
3.6.2	Custom Splash Screen	66
3.7	Boot Options.....	66
3.7.1	Optical Drive Boot	66
3.7.2	Network Boot.....	66
3.7.3	Booting Without Attached Devices.....	67
3.7.4	Changing the Default Boot Device During POST	67
3.8	BIOS Security Features	68
4	Board Status and Error Messages	69
4.1	BIOS Beep Codes	69
4.2	Front-panel Power LED Blink Codes	70
4.3	BIOS Error Messages	70
4.4	Port 80h POST Codes	71
5	Regulatory Compliance and Battery Disposal Information..	77
5.1	Regulatory Compliance.....	77
5.1.1	Safety Standards.....	77
5.1.2	European Union Declaration of Conformity Statement.....	78
5.1.3	Product Ecology Statements.....	79
5.1.4	EMC Regulations	81
5.1.5	ENERGY STAR* 5.0, e-Standby, and ErP Compliance	84
5.1.6	Regulatory Compliance Marks (Board Level)	85
5.2	Battery Disposal Information.....	86

Figures

1.	Major Board Components.....	11
2.	Block Diagram	13
3.	LAN Connector LED Locations.....	22
4.	Back Panel Audio Connectors	24
5.	Thermal Sensors and Fan Header.....	26
6.	Location of the Standby Power Indicator LED.....	32
7.	Detailed System Memory Address Map	34
8.	Back Panel Connectors	37
9.	I/O Shield Reference Diagram	38
10.	Component-side Connectors and Headers	39
11.	Connection Diagram for Front Panel Header	46
12.	Connection Diagram for Front Panel USB Header.....	48
13.	Connection Diagram for Front Panel USB Header with Intel Z-U130 USB Solid-State Drive or Compatible Device Support (D425KTW only)	48
14.	Location of the BIOS Configuration Jumper Block	49
15.	Board Dimensions	51
16.	Localized High Temperature Zones.....	53
17.	Fan Location Guide for Chassis Selection (Chassis Orientation is Not Restricted)	56

Tables

1.	Feature Summary.....	9
2.	Board Components Shown in Figure 1	12
3.	Supported Memory Configurations	16
4.	LAN Connector LED States	22
5.	Audio Jack Support.....	23
6.	Effects of Pressing the Power Switch	27
7.	Power States and Targeted System Power.....	28
8.	Wake-up Devices and Events	29
9.	System Memory Map	35
10.	Component-side Connectors and Headers Shown in Figure 10.....	40
11.	Serial Port Header	41
12.	LVDS Data Connector - 30-Pin (D425KTW only)	41
13.	LVDS Panel Voltage Selection Jumper (D425KTW only)	42
14.	LVDS Inverter Power Connector (D425KTW only).....	42
15.	LVDS Inverter Power Voltage Selection Jumper (D425KTW only)	42
16.	Chassis Fan Header	42
17.	SATA Connectors.....	43
18.	Front Panel Wireless Activity LED Header (D425KTW only)	43
19.	Front Panel Audio Header for Intel HD Audio.....	43
20.	Front Panel Audio Header for AC '97 Audio	43
21.	Front Panel USB Header	44
22.	Front Panel USB Header with Intel Z-U130 USB Solid-State Drive or Compatible Device Support (D425KTW only)	44

Intel Desktop Board D425KT and Intel Desktop Board D425KTW Technical Product Specification

23. Power Connector	45
24. Front Panel Header	46
25. States for a One-Color Power LED	47
26. BIOS Configuration Jumper Settings.....	50
27. Fan Header Current Capability	52
28. Thermal Considerations for Components	54
29. Minimum Load Configuration Current and Power Results	57
30. Maximum Load Configuration Current and Power Results.....	58
31. Intel Desktop Board D425KT and Intel Desktop Board D425KTW Environmental Specifications.....	59
32. BIOS Setup Program Menu Bar	62
33. BIOS Setup Program Function Keys.....	62
34. Acceptable Drives/Media Types for BIOS Recovery	65
35. Boot Device Menu Options	67
36. Supervisor and User Password Functions.....	68
37. BIOS Beep Codes	69
38. Front-panel Power LED Blink Codes	70
39. BIOS Error Messages	70
40. Port 80h POST Code Ranges.....	71
41. Port 80h POST Codes	72
42. Typical Port 80h POST Sequence.....	75
43. Safety Standards.....	77
44. EMC Regulations	81
45. ENERGY STAR Requirements.....	84
46. Regulatory Compliance Marks.....	85

1 Product Description

1.1 Overview

1.1.1 Feature Summary

Table 1 summarizes the major features of Intel Desktop Board D425KT and Intel Desktop Board D425KTW.

Table 1. Feature Summary

Form Factor	Mini-ITX, (6.7 inches by 6.7 inches [170 millimeters by 170 millimeters]) compatible with microATX
Processor	Passively-cooled, soldered-down Single-Core Intel® Atom™ processor with integrated graphics and integrated memory controller
Memory	<ul style="list-style-type: none">• Two 204-pin DDR3 SDRAM Small Outline Dual Inline Memory Module (SO-DIMM) sockets• Support for DDR3 800 MHz, DDR3 1066 MHz, and DDR3 1333 MHz SO-DIMMs Note: DDR3 1066 MHz and DDR3 1333 MHz memory will run at 800 MHz• Support for up to 2 GB of system memory on a single SO-DIMM (4 GB with two SO-DIMMs)
Chipset	Passively cooled, Intel® NM10 Express Chipset
Audio	Multi-streaming 2+2 channel audio subsystem support based on the Realtek* ALC662 high definition audio codec
Internal Graphics	Onboard Intel® graphics subsystem with support for: <ul style="list-style-type: none">• Integrated GMCH• Analog displays (VGA)• Flat Panel displays (LVDS interface - D425KTW only)
Legacy I/O Control	Winbond W83627DHG-A based Legacy I/O controller for hardware management, serial, parallel, and PS/2* ports
Peripheral Interfaces	<ul style="list-style-type: none">• Eight USB 2.0 ports (D425KT only):<ul style="list-style-type: none">— Four back panel ports— Four ports are implemented with two dual port internal headers for front panel cabling• Seven USB 2.0 ports (D425KTW only):<ul style="list-style-type: none">— Four back panel ports— Two ports are implemented with a dual port internal header for front panel cabling— One port is implemented with an internal header (brown-colored) that supports an Intel® Z-U130 USB Solid-State Drive or compatible device• Two Serial ATA (SATA) 3.0 Gb/s connectors (supporting IDE and AHCI mode)• One parallel port connector on the back panel• One serial port connector on the back panel• One serial port header• PS/2*-style keyboard and mouse ports
LAN Support	10/100 Mbits/s Ethernet LAN subsystem using a Realtek 8105E Ethernet Controller

continued

Intel Desktop Board D425KT and Intel Desktop Board D425KTW Technical Product Specification

Table 1. Feature Summary (continued)

BIOS	<ul style="list-style-type: none"> • Intel® BIOS (resident in the SPI Flash device) • Support for Advanced Configuration and Power Interface (ACPI), Plug and Play, and SMBIOS
Instantly Available PC Technology	<ul style="list-style-type: none"> • Support for PCI* Local Bus Specification Revision 2.3 • Suspend to RAM support • Wake on PCI, PCI Express*, PS/2, serial, front panel, USB ports, and LAN
Expansion Capabilities	<ul style="list-style-type: none"> • One PCI Conventional bus connector (with riser card support for up to two PCI cards) • PCI Express x1 Mini Card connector (D425KTW only)
Hardware Monitor Subsystem	<ul style="list-style-type: none"> • Hardware monitoring through the Windbond I/O controller • Voltage sense to detect out of range power supply voltages • Thermal sense to detect out of range thermal values • One fan header • One fan sense input used to monitor fan activity • Fan speed control

1.1.2 Board Layout

Figure 1 shows the location of the major components.

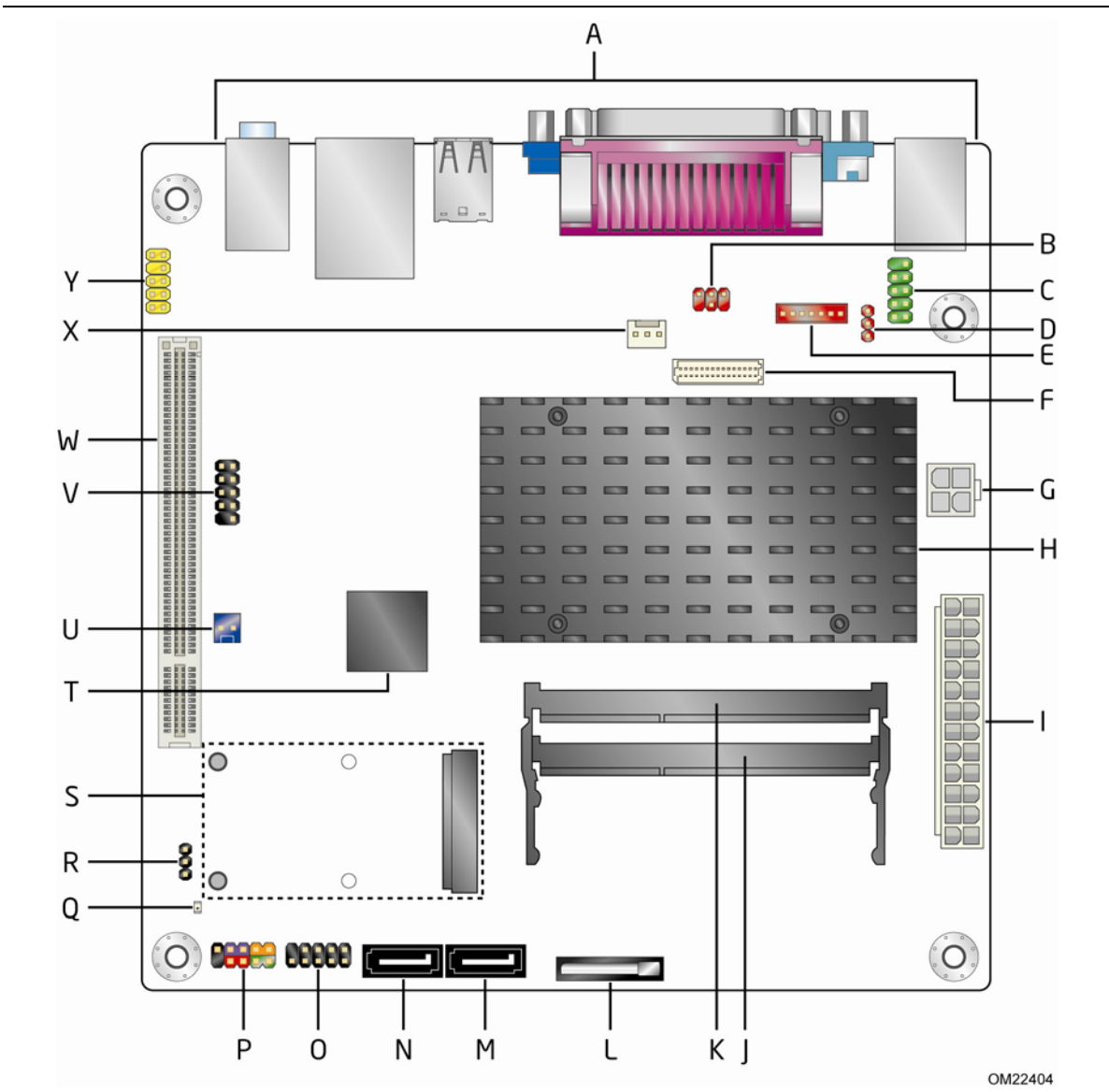

Figure 1. Major Board Components

Table 2 lists the components identified in Figure 1.

Intel Desktop Board D425KT and Intel Desktop Board D425KTW Technical Product Specification

Table 2. Board Components Shown in Figure 1

Item/callout from Figure 1	Description
A	Back panel connectors
B	LVDS inverter panel voltage selection jumper (D425KTW only)
C	Serial port header
D	LVDS inverter power voltage selection jumper (D425KTW only)
E	LVDS inverter power connector (D425KTW only)
F	LVDS panel connector (D425KTW only)
G	Processor core power connector (2 x 2)
H	Intel Atom processor
I	Power connector (2 x 12)
J	SO-DIMM channel A socket, DIMM 0
K	SO-DIMM channel A socket, DIMM 1
L	Battery
M	SATA connector 1
N	SATA connector 0
O	Front panel USB header (black)
P	Front panel header
Q	Standby power LED
R	BIOS setup configuration jumper block
S	PCI Express x1 Mini Card connector (D425KTW only)
T	Intel NM10 Express Chipset
U	Front Panel Wireless Activity LED Header (D425KTW only)
V	Front panel USB header (black) D425KTW only - Front panel USB header supports Intel Z-U130 USB Solid-State Drive or compatible device (brown)
W	PCI conventional bus connector
X	Chassis fan header
Y	Front panel audio header

1.1.3 Block Diagram

Figure 2 is a block diagram of the major functional areas.

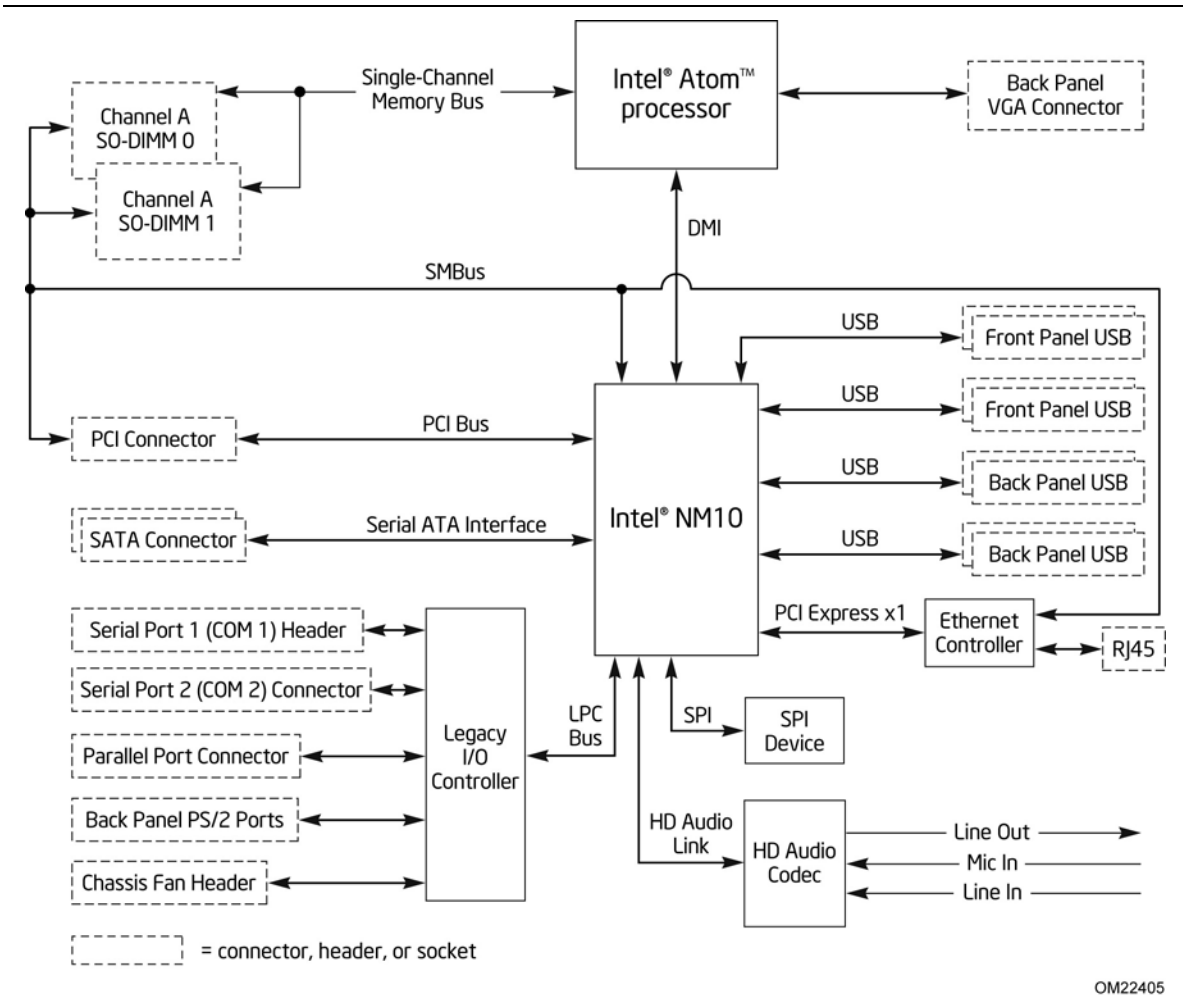

OM22405

Figure 2. Block Diagram

1.2 Online Support

To find information about...	Visit this World Wide Web site:
Intel Desktop Board D425KT and Intel Desktop Board D425KTW	http://www.intel.com/products/motherboard/index.htm
Desktop Board Support	http://www.intel.com/p/en_US/support?iid=hdr+support
Available configurations for the Intel Desktop Board D425KT and Intel Desktop Board D425KTW	http://ark.intel.com
Supported processors	http://processormatch.intel.com
Chipset information	http://www.intel.com/products/desktop/chipsets/index.htm
BIOS and driver updates	http://downloadcenter.intel.com
Tested memory	http://www.intel.com/support/motherboards/desktop/sb/CS-025414.htm
Integration information	http://www.intel.com/support/go/buildit

1.3 Processor

The board has a passively-cooled, soldered-down Single-Core Intel Atom processor with integrated graphics and integrated memory controller.



NOTE

The board is designed to be passively cooled in a properly ventilated chassis. Chassis venting locations are recommended above the processor heatsink area for maximum heat dissipation effectiveness.

For information about	Refer to
Power supply connectors	Section 2.2.2.3, page 45

1.3.1 Intel D425 Graphics Subsystem

1.3.1.1 Intel® Graphics Media Accelerator 3150 Graphics Controller

The Intel GMA 3150 graphics controller features the following:

- 400 MHz core frequency
- High quality texture engine
 - DX9.0c* and OpenGL* 1.4 compliant
 - Hardware Pixel Shader 2.0
 - Vertex Shader Model 2.0
- 3D Graphics Rendering enhancements
 - 1.6 dual texture GigaPixel/s max fill rate
 - 16-bit and 32-bit color
 - Vertex cache
- Video
 - Software DVD at 30 fps full screen
 - DVMT support up to 256 MB
- Display
 - Supports analog displays up to 2048 x 1536 at 75 Hz refresh (QXGA)
 - Supports LVDS displays up to 1366 x 768 (single channel, 18 bpp) (D425KTW only)
 - Dual independent display support with LVDS option (D425KTW only)

For information about	Refer to
Obtaining graphics software and utilities	Section 1.2, page 14

1.4 System Memory

The board has two 204-pin DDR3 SO-DIMM sockets and supports the following memory features:

- DDR3 SDRAM SO-DIMMs with gold-plated contacts
- Unbuffered, single-sided or double-sided SO-DIMMs
- 4 GB maximum total system memory
- Minimum total system memory: 256 MB
- Non-ECC SO-DIMMs
- Serial Presence Detect
- DDR3 800 MHz, DDR3 1066 MHz, and DDR3 1333 MHz SO-DIMMs (DDR3 1066 MHz and DDR3 1333 MHz memory will run at 800 MHz)



NOTE

Due to passively-cooled thermal constraints, system memory must have an operating temperature rating of 85 °C.

The board is designed to be passively cooled in a properly ventilated chassis. Chassis venting locations are recommended above the system memory area for maximum heat dissipation effectiveness.



NOTE

To be fully compliant with all applicable DDR3 SDRAM memory specifications, the board should be populated with SO-DIMMs that support the Serial Presence Detect (SPD) data structure. This allows the BIOS to read the SPD data and program the chipset to accurately configure memory settings for optimum performance. If non-SPD memory is installed, performance and reliability may be impacted or the SO-DIMMs may not function under the determined frequency.

Table 3 lists the supported DIMM configurations.

Table 3. Supported Memory Configurations

DIMM Capacity	Configuration	SDRAM Density	SDRAM Organization Front-side/Back-side	Number of SDRAM Devices
1024 MB	DS	1 Gbit	64 M x16/64 M x16	8
1024 MB	SS	1 Gbit	128 M x8/empty	8
2048 MB	DS	2 Gbit	128 M x16/128 M x16	8
2048 MB	SS	2 Gbit	256 M x8/empty	8

Note: In the second column, "DS" refers to double-sided memory modules (containing two rows of SDRAM) and "SS" refers to single-sided memory modules (containing one row of SDRAM).

1.5 Intel® NM10 Express Chipset

The Intel NM10 Express Chipset provides interfaces to the processor and the USB, SATA, LPC, LAN, PCI, and PCI Express interfaces. The Intel NM10 Express Chipset is a centralized controller for the board's I/O paths.



NOTE

The board is designed to be passively cooled in a properly ventilated chassis. Chassis venting locations are recommended above the processor heatsink area for maximum heat dissipation effectiveness.

For information about	Refer to
The Intel NM10 Express chipset	http://www.intel.com/products/desktop/chipsets/index.htm
Resources used by the chipset	Chapter 2

1.5.1.1 Video Memory Allocation

Video memory is allocated from the total available system memory for the efficient balancing of 2-D/3-D graphics performance and overall system performance. Dynamic allocation of system memory to video memory is as follows:

- 256 MB total RAM results in 32 MB video RAM
- 512 MB total RAM results in 64 MB video RAM
- 1 GB total RAM results in 128 MB video RAM
- 2 GB total RAM results in 224 MB video RAM

1.5.1.2 Analog Display (VGA)

The VGA port supports analog displays. The maximum supported resolution is 2048 x 1536 (QXGA) at a 75 Hz refresh rate.

1.5.1.3 Flat Panel Interface (LVDS) - D425KTW Only

The flat panel interface (LVDS) supports the following:

- Panel support up to UXGA (1366 x 768)
- 25 MHz to 112 MHz single-channel; @18 bpp
 - TFT panel type
- Panel fitting, panning, and center mode
- CPIS 1.5 compliant
- Spread spectrum clocking
- Panel power sequencing
- Integrated PWM interface for LCD backlight inverter control

1.5.1.4 Configuration Modes

For monitors attached to the VGA port, video modes supported by this board are based on the Extended Display Identification Data (EDID) protocol.

Video mode configuration for LVDS displays (D425KTW only) is supported as follows:

- Automatic panel identification via Extended Display Identification Data (EDID) for LVDS panels supporting EDID protocol.
- Manual LVDS panel configuration through the BIOS setup page. This feature allows the manual entry of critical panel settings (equivalent to the 18-byte Detailed Timings Descriptor structure defined by the VESA EDID specification) for non-EDID panel support.

In addition, BIOS setup provides the following configuration parameters for LVDS displays (D425KTW only):

- Screen Brightness: allows the end-user to set screen brightness for the display.
- Maintain Aspect Ratio: allows the end-user to select whether the native aspect ratio is to be preserved during POST and before the video driver is loaded.
- LVDS Configuration Changes: allows the system integrator to “lock” critical settings of the LVDS configuration to avoid end-users potentially rendering the display unusable (refer to Note 1).
- Inverter Frequency and Polarity: allows the system integrator to set the operating frequency and polarity of the panel inverter board.
- Minimum Inverter Current Limit (%): allows the system integrator to set minimum PWM%, as appropriate, according to the power requirements of the LVDS display and the selected inverter board.



NOTE

Support for LVDS (D425KTW only) configuration complies with the following:

- 1. “Unlocking” of critical settings of the LVDS configuration is supported via Intel® Integrator Toolkit’s command-line tool.*
- 2. Critical settings of the LVDS configuration are not exposed through Intel Integrator Toolkit or Intel® Integrator Assistant GUIs.*
- 3. Critical settings of the LVDS configuration will not be overwritten by loading BIOS setup defaults.*
- 4. Critical settings of the LVDS configuration will be preserved across BIOS updates.*

1.5.2 USB

The board provides up to eight USB 2.0 ports, supports UHCI and EHCI, and uses UHCI- and EHCI-compatible drivers. The port arrangement is as follows:

- Eight USB 2.0 ports (D425KT only):
 - Four back panel ports
 - Four ports are implemented with two dual port internal headers for front panel cabling
- Seven USB 2.0 ports (D425KTW only):
 - Four back panel ports
 - Two ports are implemented with a dual port internal header for front panel cabling
 - One port is implemented with an internal header (brown-colored) that supports an Intel® Z-U130 USB Solid-State Drive or compatible device



NOTE

Computer systems that have an unshielded cable attached to a USB port may not meet FCC Class B requirements, even if no device is attached to the cable. Use shielded cable that meets the requirements for full-speed devices.

For information about	Refer to
The location of the USB connectors on the back panel	Figure 8, page 37
The location of the front panel USB headers	Figure 10, page 39

1.5.3 SATA Support

The board provides two SATA interface connectors that support one device per connector.

The board's SATA controller offers independent SATA ports with a theoretical maximum transfer rate of 3.0 Gbits/s on each port. One device can be installed on each port for a maximum of two SATA devices. A point-to-point interface is used for host to device connections, unlike PATA which supports a master/slave configuration and two devices on each channel.

For compatibility, the underlying SATA functionality is transparent to the operating system. The SATA controller supports IDE and AHCI configuration and can operate in both legacy and native modes. In legacy mode, standard ATA I/O and IRQ resources are assigned (IRQ 14 and 15). In native mode, standard PCI Conventional bus resource steering is used. Native mode is the preferred mode for configurations using the Windows* XP and Windows Vista* operating systems.

For information about	Refer to
Obtaining AHCI driver	Section 1.2, page 14
The location of the SATA connectors	Figure 10, page 39

1.6 Real-Time Clock Subsystem

A coin-cell battery (CR2032) powers the real-time clock and CMOS memory. When the computer is not plugged into a wall socket, the battery has an estimated life of three years. When the computer is plugged in, the standby current from the power supply extends the life of the battery. The clock is accurate to ± 13 minutes/year at 25 °C with 3.3 VSB applied.



NOTE

If the battery and AC power fail, custom defaults, if previously saved, will be loaded into CMOS RAM at power-on.

When the voltage drops below a certain level, the BIOS Setup program settings stored in CMOS RAM (for example, the date and time) might not be accurate. Replace the battery with an equivalent one. Figure 1 on page 11 shows the location of the battery.

1.7 Legacy I/O Controller

The Legacy I/O Controller provides the following features:

- One serial port header
- One serial port connector on the back panel
- One parallel port connector with Extended Capabilities Port (ECP) and Enhanced Parallel Port (EPP) support
- Serial IRQ interface compatible with serialized IRQ support for PCI Conventional bus systems
- PS/2-style keyboard and mouse ports
- Intelligent power management, including a programmable wake-up event interface
- PCI Conventional bus power management support

The BIOS Setup program provides configuration options for the Legacy I/O controller.

For information about	Refer to
The location of the serial port header	Figure 10, page 39
The serial port header signal mapping	Table 11, on page 41

1.8 LAN Subsystem

The LAN subsystem consists of the following:

- Intel NM10 Express Chipset
- Realtek 8105E Ethernet Controller for 10/100 Mb/s Ethernet LAN connectivity
- RJ-45 LAN connector with integrated status LEDs

Additional features of the LAN subsystem include:

- CSMA/CD protocol engine
- LAN connect interface that supports the Ethernet controller
- PCI Conventional bus power management
 - Supports ACPI technology
 - Supports LAN wake capabilities

1.8.1 LAN Subsystem Drivers

LAN drivers are available from Intel's World Wide Web site.

For information about

Obtaining LAN drivers

Refer to

Section 1.2, page 14

1.8.2 RJ-45 LAN Connector with Integrated LEDs

Two LEDs are built into the RJ-45 LAN connector (shown in Figure 3).

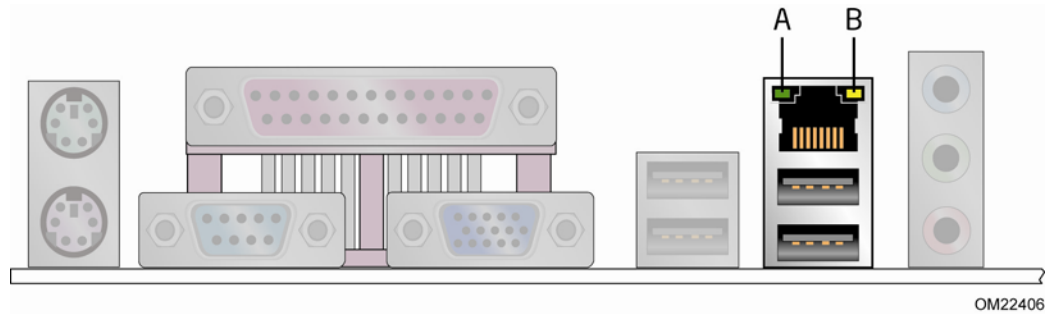

Figure 3. LAN Connector LED Locations

Table 4 describes the LED states when the board is powered up and the 10/100 Mb/s LAN subsystem is operating.

Table 4. LAN Connector LED States

LED	Color	State	Condition
Activity (A)	Green	Blinking	LAN activity occurring
Speed (B)	N/A	Off	10 Mb/s data rate
	Yellow	On	100 Mb/s data rate

1.9 Audio Subsystem

The board supports the Intel® High Definition Audio (Intel® HD Audio) subsystem. The audio subsystem consists of the following:

- Intel NM10 Express Chipset
- Realtek ALC662 audio codec

The audio subsystem has the following features:

- Advanced jack sense for the back panel audio jacks that enables the audio codec to recognize the device that is connected to an audio port. The back panel audio jacks are capable of retasking according to the user's definition, or can be automatically switched depending on the recognized device type.
- Front panel Intel HD Audio and AC '97 audio support
- 3-port analog audio out stack
- Windows Vista Basic certification
- A signal-to-noise (S/N) ratio of 95 dB

Table 5 lists the supported functions of the front panel and back panel audio jacks.

Table 5. Audio Jack Support

Audio Jack	Line In	Line/ Front Out	Rear Out	MIC	Headphones
Front panel – Green	No	Yes	No	No	Yes
Front panel – Pink	No	No	No	Yes	No
Back panel – Blue	Yes	No	Yes	No	No
Back panel – Green	No	Yes	No	No	Yes
Back panel – Pink	No	No	No	Yes	No

1.9.1 Audio Subsystem Software

Audio software and drivers are available from Intel’s World Wide Web site.

For information about	Refer to
Obtaining audio software and drivers	Section 1.2, page 14

1.9.2 Audio Connectors and Headers

The board contains audio connectors and headers on both the back panel and the component side of the board. The component-side audio headers include front panel audio (a 2 x 5-pin header that provides mic in and line out signals for front panel audio connectors).

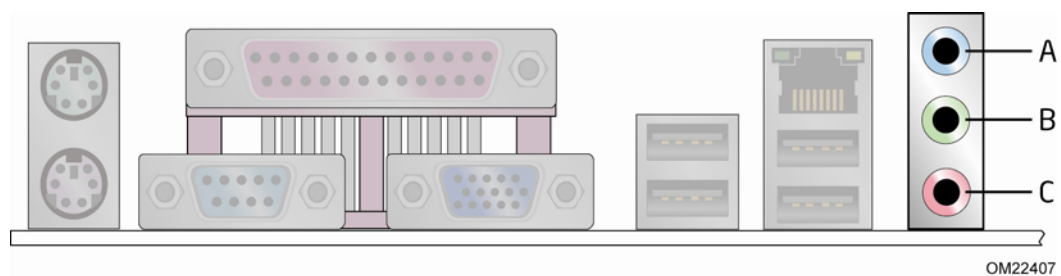

Item	Description
A	Line in
B	Line out
C	Mic in

Figure 4. Back Panel Audio Connectors



NOTE

The back panel audio line out connector is designed to power headphones or amplified speakers only. Poor audio quality occurs if passive (non-amplified) speakers are connected to this output.

For information about	Refer to
The locations of the front panel audio header and S/PDIF audio header	Figure 10, page 39
The signal names of the front panel audio header and S/PDIF header	Section 2.2.2.1. page 41
The back panel audio connectors	Figure 4. page 24

1.10 Hardware Management Subsystem

The hardware management features enable the board to be compatible with the Wired for Management (WfM) specification. The board has several hardware management features, including the following:

- Thermal and voltage monitoring
- Chassis intrusion detection

1.10.1 Hardware Monitoring

The hardware monitoring and fan control subsystem is based on the Winbond W83627DHG-A device, which supports the following:

- Processor and system ambient temperature monitoring
- Chassis fan speed monitoring
- Power monitoring of +12 V, +5 V, +5 Vstdby, +3.3 V, and +VCCP
- SMBus interface

1.10.2 Thermal Monitoring

Figure 5 shows the locations of the thermal sensors and fan header.

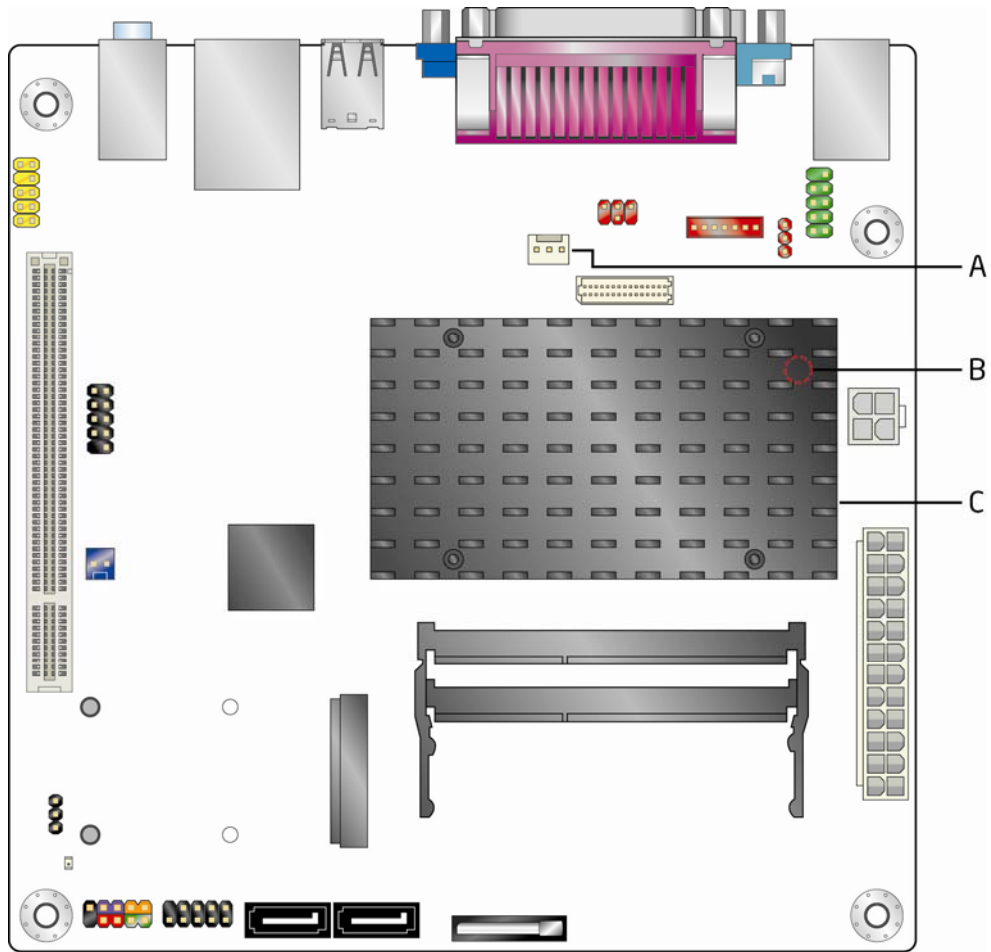

OM22409

Item	Description
A	Chassis fan header
B	Remote thermal sensor
C	Thermal diode, located on the processor die

Figure 5. Thermal Sensors and Fan Header

1.11 Power Management

Power management is implemented at several levels, including:

- Software support through Advanced Configuration and Power Interface (ACPI)
- Hardware support:
 - Power connector
 - Fan header
 - LAN wake capabilities
 - Instantly Available PC technology
 - Wake from USB
 - Wake from PS/2 devices
 - Power Management Event signal (PME#) wake-up support
 - WAKE# signal wake-up support

1.11.1 ACPI

ACPI gives the operating system direct control over the power management and Plug and Play functions of a computer. The use of ACPI with the board requires an operating system that provides full ACPI support. ACPI features include:

- Plug and Play (including bus and device enumeration)
- Power management control of individual devices, add-in boards (some add-in boards may require an ACPI-aware driver), video displays, and hard disk drives
- Methods for achieving less than 15-watt system operation in the power-on/standby sleeping state
- A Soft-off feature that enables the operating system to power-off the computer
- Support for multiple wake-up events (see Table 8 on page 29)
- Support for a front panel power and sleep mode switch

Table 6 lists the system states based on how long the power switch is pressed, depending on how ACPI is configured with an ACPI-aware operating system.

Table 6. Effects of Pressing the Power Switch

If the system is in this state...	...and the power switch is pressed for	...the system enters this state
Off (ACPI G2/G5 – Soft off)	Less than four seconds	Power-on (ACPI G0 – working state)
On (ACPI G0 – working state)	Less than four seconds	Power-off (ACPI G2/G5 – Soft off)
On (ACPI G0 – working state)	More than four seconds	Fail safe power-off (ACPI G2/G5 – Soft off)
Sleep (ACPI G1 – sleeping state)	Less than four seconds	Wake-up (ACPI G0 – working state)
Sleep (ACPI G1 – sleeping state)	More than four seconds	Power-off (ACPI G2/G5 – Soft off)

1.11.1.1 System States and Power States

Under ACPI, the operating system directs all system and device power state transitions. The operating system puts devices in and out of low-power states based on user preferences and knowledge of how devices are being used by applications. Devices that are not being used can be turned off. The operating system uses information from applications and user settings to put the system as a whole into a low-power state.

Table 7 lists the power states supported by the board along with the associated system power targets. See the ACPI specification for a complete description of the various system and power states.

Table 7. Power States and Targeted System Power

Global States	Sleeping States	Processor States	Device States	Targeted System Power <small>(Note 1)</small>
G0 – working state	S0 – working	C0 – working	D0 – working state.	Full power > 30 W
G1 – sleeping state	S1 – Processor stopped	C1 – stop grant	D1, D2, D3 – device specification specific.	5 W < power < 52.5 W
G1 – sleeping state	S3 – Suspend to RAM. Context saved to RAM.	No power	D3 – no power except for wake-up logic.	Power < 5 W <small>(Note 2)</small>
G1 – sleeping state	S4 – Suspend to disk. Context saved to disk.	No power	D3 – no power except for wake-up logic.	Power < 5 W <small>(Note 2)</small>
G2/S5	S5 – Soft off. Context not saved. Cold boot is required.	No power	D3 – no power except for wake-up logic.	Power < 5 W <small>(Note 2)</small>
G3 – mechanical off. AC power is disconnected from the computer.	No power to the system.	No power	D3 – no power for wake-up logic, except when provided by battery or external source.	No power to the system. Service can be performed safely.

Notes:

1. Total system power is dependent on the system configuration, including add-in boards and peripherals powered by the system's power supply.
2. Dependent on the standby power consumption of wake-up devices used in the system.

1.11.1.2 Wake-up Devices and Events

Table 8 lists the devices or specific events that can wake the computer from specific states.

Table 8. Wake-up Devices and Events

These devices/events can wake up the computer...	...from this state
LAN	S1, S3, S4, S5 (Note 1)
PME# signal	S1, S3, S4, S5 (Note 1)
Wake# signal	S1, S3, S4, S5 (Notes 1 and 3)
Power switch	S1, S3, S4, S5 (Note 1)
RTC alarm	S4, S5 (Note 1)
Serial port	S1, S3
USB	S1, S3 (Note 2)
PS/2 devices	S1, S3, S4, S5 (Notes 1 and 4)

Notes:

1. S4 implies operating system support only. Wake from S5 must include wake after loss of power.
2. USB ports are turned off during S4/S5 states.
3. Wake# signal must be controllable by the BIOS (enable/disable option).
4. PS/2 wake from S5 should have a selection in the BIOS to enable wake from a combination key (Alt + Print Screen) or the keyboard power button.



NOTE

The use of these wake-up events from an ACPI state requires an operating system that provides full ACPI support. In addition, software, drivers, and peripherals must fully support ACPI wake events.

1.11.2 Hardware Support

The board provides several power management hardware features, including:

- Power connector
- Fan header
- LAN wake capabilities
- Instantly Available PC technology
- Wake from USB
- Wake from PS/2 devices
- Power Management Event signal (PME#) wake-up support
- WAKE# signal wake-up support
- +5V Standby Power Indicator LED

LAN wake capabilities and Instantly Available PC technology require power from the +5 V standby line.



NOTE

The use of Wake from USB technologies from an ACPI state requires an operating system that provides full ACPI support.

1.11.2.1 Fan Header

The function/operation of the fan header is as follows:

- The fan is on when the board is in the S0 state.
- The fan is off when the board is off or in the S3, S4, or S5 state.
- The chassis fan header supports closed-loop fan control that can adjust the fan speed and is wired to a fan tachometer input.
- The fan header supports +12 V, 3-wire fans at 1 A maximum.

For information about	Refer to
The locations of the fan header and thermal sensors	Figure 5, page 26
The signal names of the chassis fan header	Table 16, page 42

1.11.2.2 LAN Wake Capabilities

LAN wake capabilities enable remote wake-up of the computer through a network. The LAN subsystem network adapter monitors network traffic at the Media Independent Interface. The board supports LAN wake capabilities with ACPI in the following ways:

- By Ping
- By Magic Packet

Upon detecting the configured wake packet type, the LAN subsystem asserts a wake-up signal that powers up the computer.

1.11.2.3 Instantly Available PC Technology

Instantly Available PC technology enables the board to enter the ACPI S3 (Suspend-to-RAM) sleep-state. While in the S3 sleep-state, the computer will appear to be off (the hard drive(s) and fan will power off, the front panel LED will blink). When signaled by a wake-up device or event, the system quickly returns to its last known state. Table 8 on page 29 lists the devices and events that can wake the computer from the S3 state.

The board supports the *PCI Bus Power Management Interface Specification*. Add-in boards that also support this specification can participate in power management and can be used to wake the computer.

The use of Instantly Available PC technology requires operating system support and PCI 2.3 compliant add-in cards and drivers.

1.11.2.4 Wake from USB

USB bus activity wakes the computer from an ACPI S1 or S3 state.



NOTE

Wake from USB requires the use of a USB peripheral that supports Wake from USB and support in the operating system.

1.11.2.5 PME# Signal Wake-up Support

When the PME# signal on the PCI bus is asserted, the computer wakes from an ACPI S1, S3, S4, or S5 state (with Wake on PME enabled in the BIOS).

1.11.2.6 Wake from PS/2 Devices

PS/2 keyboard activity wakes the computer from an ACPI S1, S3, S4, or S5 state. However, when the computer is in an ACPI S4 or S5 state, the only PS/2 activity that will wake the computer is the Alt + Print Screen or the Power Key available only on some keyboards.

1.11.2.7 WAKE# Signal Wake-up Support

When the WAKE# signal on the PCI Express bus is asserted, the computer wakes from an ACPI S1, S3, S4, or S5 state.

1.11.2.8 Wake from Serial Port

Serial Port activity wakes the computer from an ACPI S1 or S3 state.

1.11.2.9 +5 V Standby Power Indicator LED

The +5 V standby power indicator LED shows that power is still present even when the computer appears to be off. Figure 6 shows the location of the standby power indicator LED.



CAUTION

If AC power has been switched off and the standby power indicator is still lit, disconnect the power cord before installing or removing any devices connected to the board. Failure to do so could damage the board and any attached devices.

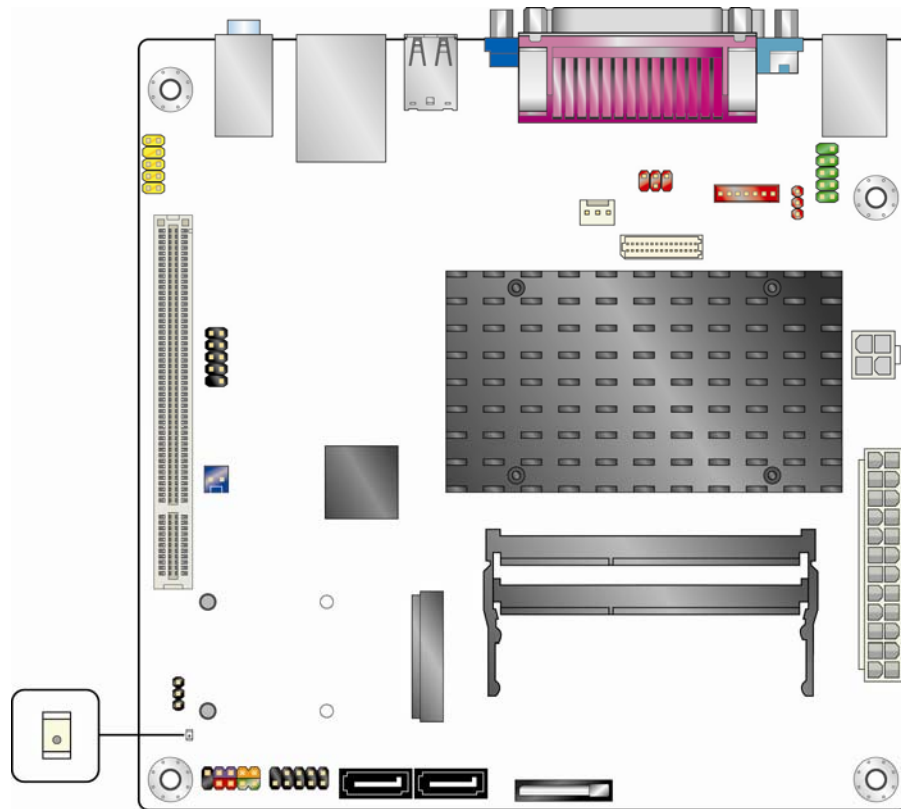

OM22410

Figure 6. Location of the Standby Power Indicator LED

2 Technical Reference

2.1 Memory Map

2.1.1 Addressable Memory

The board utilizes 4 GB of addressable system memory. Typically the address space that is allocated for PCI Conventional bus add-in cards, PCI Express configuration space, BIOS (SPI Flash), and chipset overhead resides above the top of DRAM (total system memory). On a system that has 4 GB of system memory installed, it is not possible to use all of the installed memory due to system address space being allocated for other system critical functions. These functions include the following:

- BIOS/ SPI Flash (4 MB)
- Local APIC (19 MB)
- Direct Media Interface (40 MB)
- Front side bus interrupts (17 MB)
- Internal graphics address registers
- Memory-mapped I/O that is dynamically allocated for PCI Conventional add-in cards

Intel Desktop Board D425KT and Intel Desktop Board D425KTW Technical Product Specification

The amount of installed memory that can be used will vary based on add-in cards and BIOS settings. Figure 7 shows a schematic of the system memory map. All installed system memory can be used when there is no overlap of system addresses.

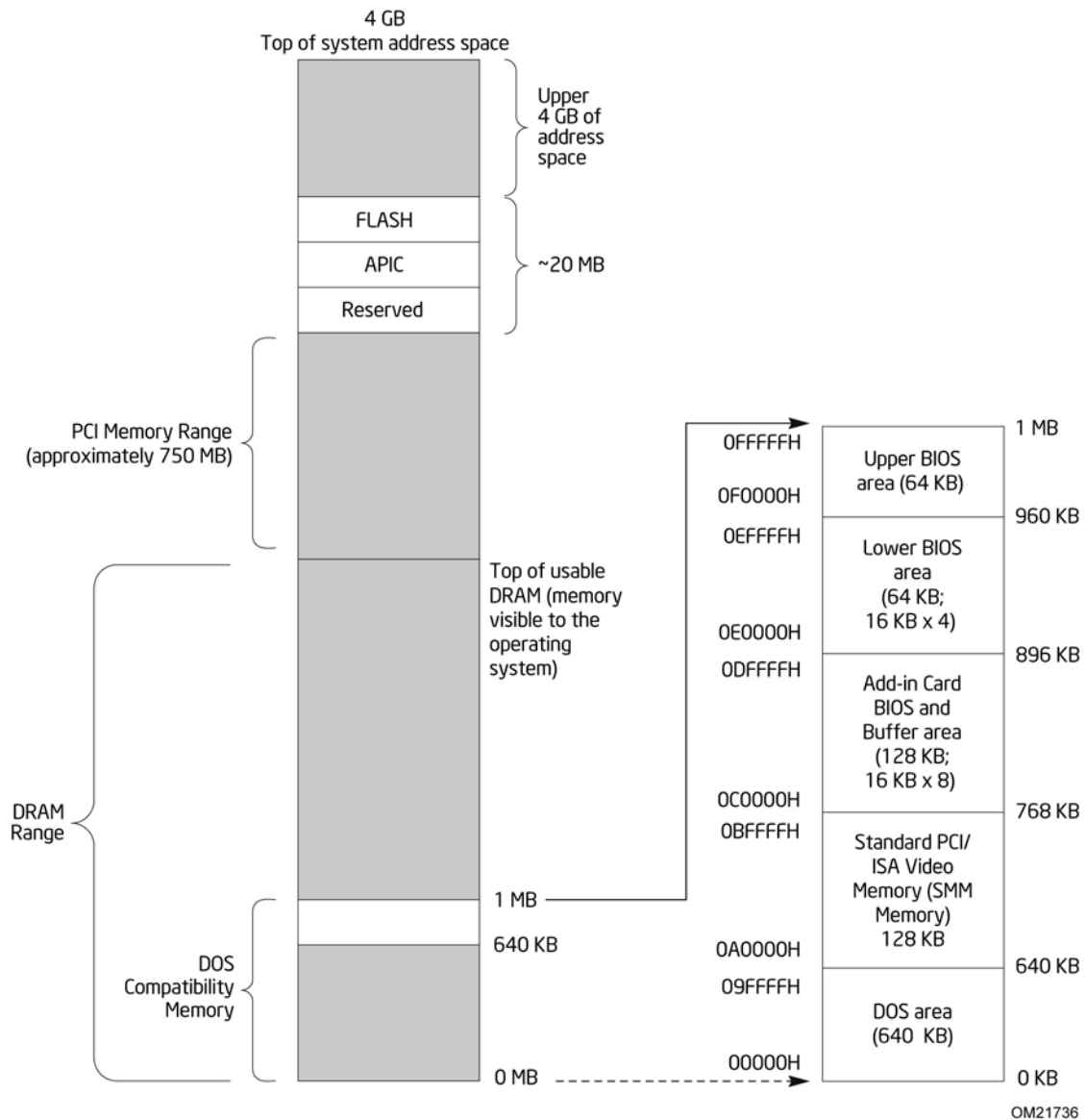

Figure 7. Detailed System Memory Address Map

Table 9 lists the system memory map.

Table 9. System Memory Map

Address Range (decimal)	Address Range (hex)	Size	Description
1024 K - 4194304 K	100000 - FFFFFFFF	4095 MB	Extended memory
960 K - 1024 K	F0000 - FFFFF	64 KB	Runtime BIOS
896 K - 960 K	E0000 - EFFFF	64 KB	Reserved
800 K - 896 K	C8000 - DFFFF	96 KB	Potential available high DOS memory (open to the PCI bus). Dependent on video adapter used.
640 K - 800 K	A0000 - C7FFF	160 KB	Video memory and BIOS
639 K - 640 K	9FC00 - 9FFFF	1 KB	Extended BIOS data (movable by memory manager software)
512 K - 639 K	80000 - 9FBFF	127 KB	Extended conventional memory
0 K - 512 K	00000 - 7FFFF	512 KB	Conventional memory

2.2 Connectors and Headers



CAUTION

Only the following connectors/headers have overcurrent protection: Back panel and front panel USB, VGA, serial, and PS/2.

The other internal connectors/headers are not overcurrent protected and should connect only to devices inside the computer's chassis, such as fans and internal peripherals. Do not use these connectors/headers to power devices external to the computer's chassis. A fault in the load presented by the external devices could cause damage to the computer, the power cable, and the external devices themselves.



NOTE

Computer systems that have an unshielded cable attached to a USB port may not meet FCC Class B requirements, even if no device is attached to the cable. Use shielded cable that meets the requirements for full-speed devices.

This section describes the board's connectors and headers. The connectors and headers can be divided into these groups:

- Back panel I/O connectors (see page 37)
- Component-side connectors and headers (see page 39)

2.2.1 Back Panel

2.2.1.1 Back Panel Connectors

Figure 8 shows the location of the back panel connectors.

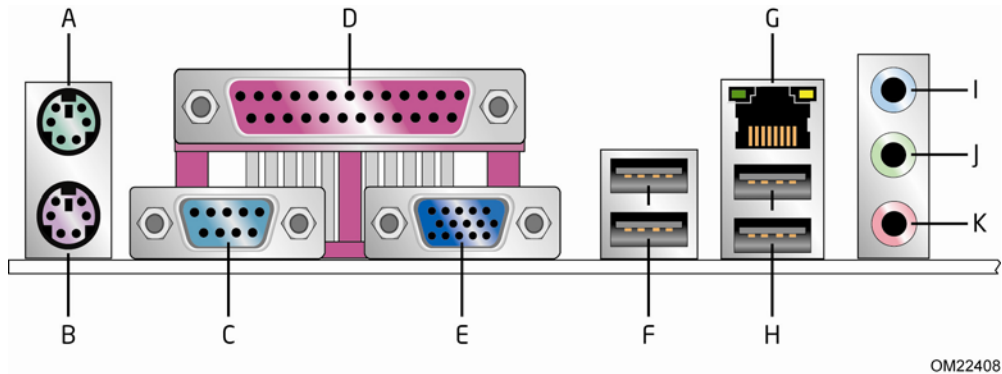

OM22408

Item	Description
A	PS/2 keyboard/mouse
B	PS/2 keyboard/mouse
C	Serial port
D	Parallel port
E	VGA port
F	USB ports
G	LAN
H	USB ports
I	Line in
J	Line out
K	Mic in

Figure 8. Back Panel Connectors



NOTE

The back panel audio line out connector is designed to power headphones or amplified speakers only. Poor audio quality occurs if passive (non-amplified) speakers are connected to this output.

2.2.1.2 I/O Shield

The I/O shield provided with the board allows access to all back panel connectors and is compatible with standard mini-ITX and microATX chassis. As an added benefit for system configurations with wireless PCI Express Mini Card solutions, the I/O shield also provides pre-cut holes for user installation of up to two external wireless antennas. Figure 9 shows an I/O shield reference diagram.

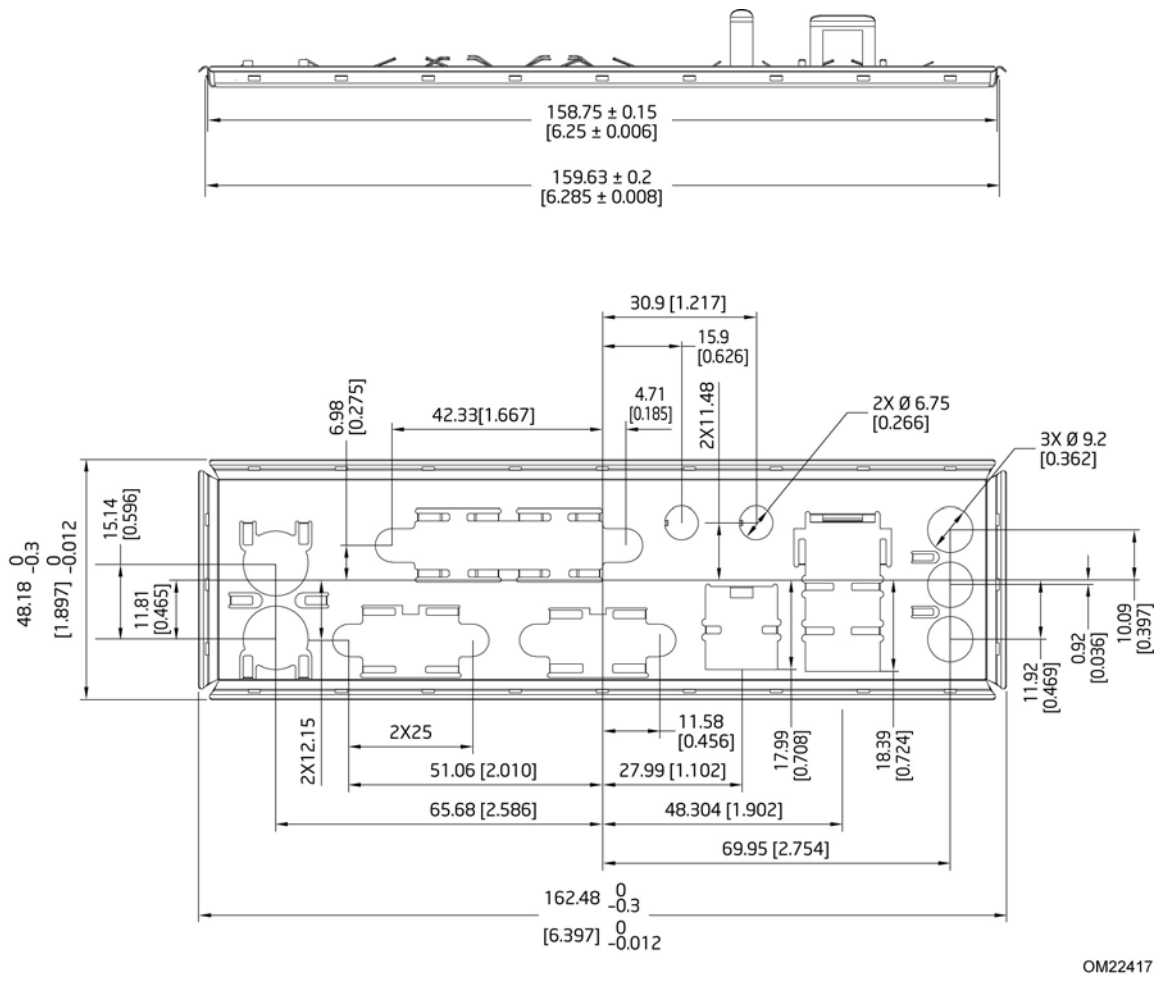

Figure 9. I/O Shield Reference Diagram

2.2.2 Component-side Connectors and Headers

Figure 10 shows the locations of the component-side connectors and headers.

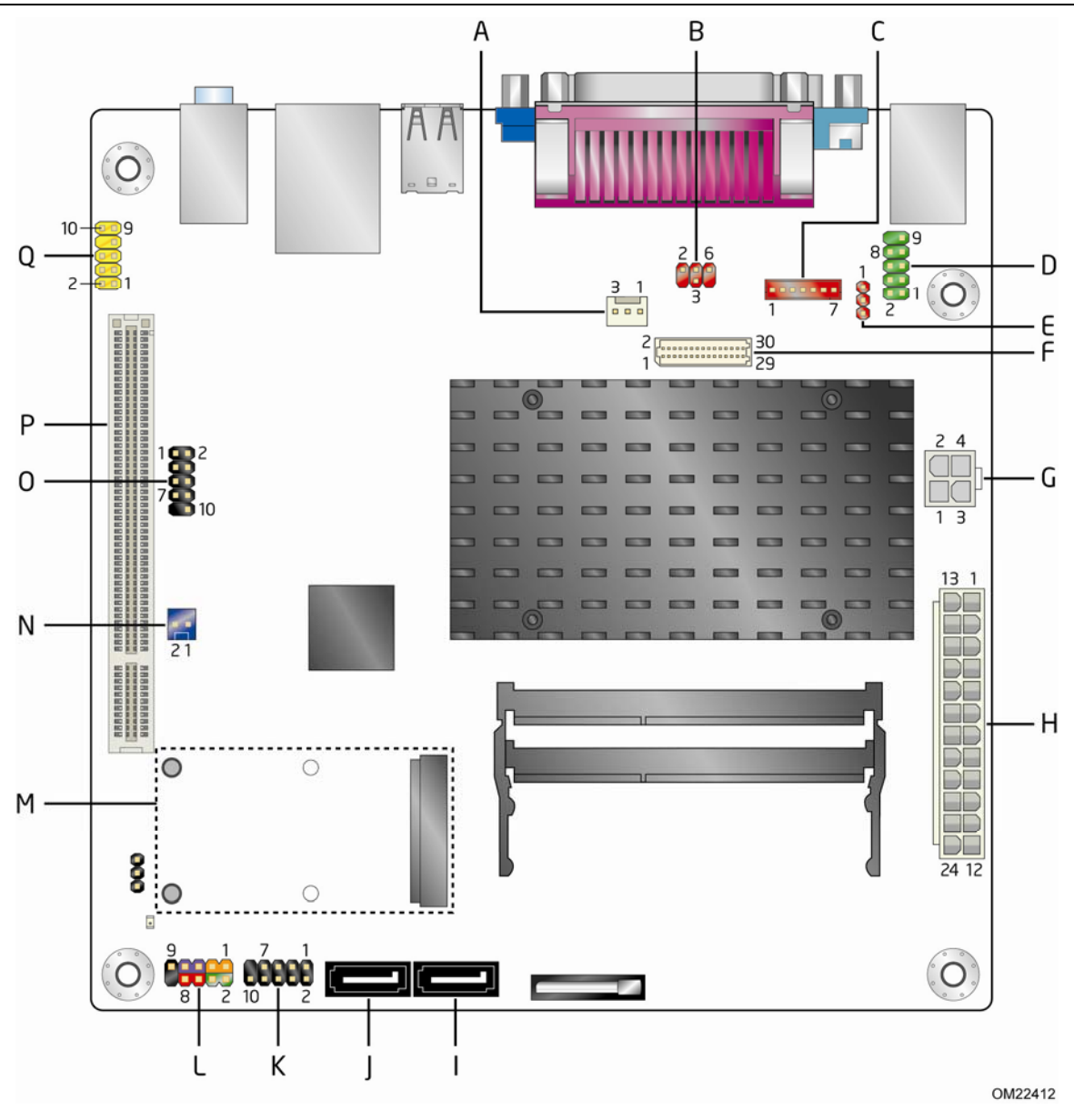

Figure 10. Component-side Connectors and Headers

Intel Desktop Board D425KT and Intel Desktop Board D425KTW Technical Product Specification

Table 10 lists the component-side connectors and headers identified in Figure 10.

Table 10. Component-side Connectors and Headers Shown in Figure 10

Item/callout from Figure 10	Description
A	Chassis fan header
B	LVDS inverter panel voltage selection jumper (D425KTW only)
C	LVDS inverter power connector (D425KTW only)
D	Serial port header
E	LVDS inverter power voltage selection jumper (D425KTW only)
F	LVDS panel connector (D425KTW only)
G	Processor core power connector (2 x 2)
H	Power connector (2 x 12)
I	SATA connector 1
J	SATA connector 0
K	USB front panel header
L	Front panel header
M	PCI Express x1 Mini Card connector
N	Front Panel Wireless Activity LED Header (D425KTW only)
O	Front panel USB header (black) D425KTW only - Front panel USB header supports Intel Z-U130 USB Solid-State Drive or compatible device (brown)
P	PCI conventional bus connector
Q	Front panel audio header

2.2.2.1 Signal Tables for the Connectors and Headers

Table 11. Serial Port Header

Pin	Signal Name	Pin	Signal Name
1	DCD (Data Carrier Detect)	2	RXD# (Receive Data)
3	TXD# (Transmit Data)	4	DTR (Data Terminal Ready)
5	Ground	6	DSR (Data Set Ready)
7	RTS (Request To Send)	8	CTS (Clear To Send)
9	RI (Ring Indicator)	10	Key (no pin)

Table 12. LVDS Data Connector - 30-Pin (D425KTW only)

Pin	Signal Name	Description	Pin	Signal Name	Description
1	LA_CLKN	LVDS Channel A diff clock output - negative	2	NC	
3	LA_CLKP	LVDS Channel A diff clock output - positive	4	NC	
5	EDID_3.3V	Power for EDID ROM	6	EDID_GND	Ground for EDID signaling
7	LA_DATAN0	LVDS Channel A diff data output - negative	8	NC	
9	LA_DATAP0	LVDS Channel A diff data output - positive	10	NC	
11	LA_DATAN1	LVDS Channel A diff data output - negative	12	NC	
13	LA_DATAP1	LVDS Channel A diff data output - positive	14	NC	
15	GND	Ground	16	GND	Ground
17	LA_DATAN2	LVDS Channel A diff data output - negative	18	NC	
19	LA_DATAP2	LVDS Channel A diff data output - positive	20	NC	
21	GND	Ground	22	GND	Ground
23	GND	Ground	24	GND	Ground
25	3.3 V/5 V/12 V	Selectable LCD power output	26	3.3 V/5 V/12 V	Selectable LCD power output
27	3.3 V/5 V/12 V	Selectable LCD power output	28	3.3 V/5 V/12 V	Selectable LCD power output
29	EDID_CLK	EDID/DDC clock signal	30	EDID_DATA	EDID/DDC data signal

Intel Desktop Board D425KT and Intel Desktop Board D425KTW Technical Product Specification

Table 13. LVDS Panel Voltage Selection Jumper (D425KTW only)

Voltage	Jumper Setting	Configuration
3.3 V	2 and 4	 Jumper position for 3.3 V (default)
5 V	6 and 4	 Jumper position for 5 V
12 V	3 and 4	 Jumper position for 12 V

Table 14. LVDS Inverter Power Connector (D425KTW only)

Pin	Signal Name	Description
1	GND	Ground
2	GND	Ground
3	5 V/12 V	Inverter power
4	5 V/12 V	Inverter power
5	INV_RATING	Inverter rating
6	BKLT_PWM	Backlight PWM
7	BKLT_EN	Backlight enable

Table 15. LVDS Inverter Power Voltage Selection Jumper (D425KTW only)

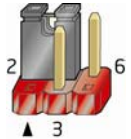
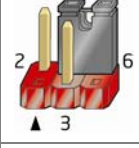
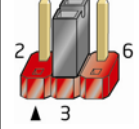

Voltage	Jumper Setting	Configuration
5 V	1 and 2	 Jumper position for 5 V (default)
12 V	3 and 2	 Jumper position for 12 V

Table 16. Chassis Fan Header

Pin	Signal Name
1	Ground
2	+12 V (PWM controlled pulses)
3	Tach

Table 17. SATA Connectors

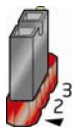
Pin	Signal Name
1	Ground
2	TXP
3	TXN
4	Ground
5	RXN
6	RXP
7	Ground

Table 18. Front Panel Wireless Activity LED Header (D425KTW only)

Pin	Signal Name
1	LED (+)
2	Ground

Table 19. Front Panel Audio Header for Intel HD Audio

Pin	Signal Name	Pin	Signal Name
1	[Port 1] Left channel	2	Ground
3	[Port 1] Right channel	4	PRESENCE# (Dongle present)
5	[Port 2] Right channel	6	[Port 1] SENSE_RETURN
7	SENSE_SEND (Jack detection)	8	Key (no pin)
9	[Port 2] Left channel	10	[Port 2] SENSE_RETURN

Table 20. Front Panel Audio Header for AC '97 Audio

Pin	Signal Name	Pin	Signal Name
1	MIC	2	AUD_GND
3	MIC_BIAS	4	AUD_GND
5	FP_OUT_R	6	FP_RETURN_R
7	AUD_5V	8	KEY (no pin)
9	FP_OUT_L	10	FP_RETURN_L

Intel Desktop Board D425KT and Intel Desktop Board D425KTW Technical Product Specification

Table 21. Front Panel USB Header

Pin	Signal Name	Pin	Signal Name
1	+5 VDC	2	+5 VDC
3	D-	4	D-
5	D+	6	D+
7	Ground	8	Ground
9	KEY (no pin)	10	No Connect

Table 22. Front Panel USB Header with Intel Z-U130 USB Solid-State Drive or Compatible Device Support (D425KTW only)

Pin	Signal Name	Pin	Signal Name
1	+5 VDC	2	NC
3	D-	4	NC
5	D+	6	NC
7	Ground	8	NC
9	KEY (no pin)	10	LED#

2.2.2.2 Add-in Card Connectors

The board has the following add-in card connectors:

- PCI Express x1 Mini Card (rev 1.2 compliant) connector (D425KTW only)
- PCI Conventional (rev 2.3 compliant) bus connector (with riser card support for up to two PCI cards)

Note the following considerations for the PCI Conventional bus connector:

- The PCI Conventional bus connector is bus master capable.
- SMBus signals are routed to the PCI Conventional bus connector. This enables PCI Conventional bus add-in boards with SMBus support to access sensor data on the board. The specific SMBus signals are as follows:
 - The SMBus clock line is connected to pin A40.
 - The SMBus data line is connected to pin A41.

The PCI Conventional bus connector also supports single-slot and dual-slot riser cards for use of up to two bus master PCI expansion cards. In order to support two PCI bus master expansion cards, the riser card must support the following PCI signal routing:

- Pin A11: additional 33 MHz PCI clock
- Pin B10: additional PCI Request signal (i.e., PREQ#2)
- Pin B14: additional PCI Grant signal (i.e., GNT#2)

2.2.2.3 Power Supply Connector

The board has a 2 x 12 power connector (see Table 23). This board requires a TFX12V or SFX12V power supply.

Table 23. Power Connector

Pin	Signal Name	Pin	Signal Name
1	+3.3 V	13	+3.3 V
2	+3.3 V	14	-12 V
3	Ground	15	Ground
4	+5 V	16	PS-ON# (power supply remote on/off)
5	Ground	17	Ground
6	+5 V	18	Ground
7	Ground	19	Ground
8	PWRGD (Power Good)	20	No connect
9	+5 V (Standby)	21	+5 V
10	+12 V	22	+5 V
11	+12 V	23	+5 V
12	No connect	24	Ground

2.2.2.4 Front Panel Header

This section describes the functions of the front panel header. Table 24 lists the signal names of the front panel header. Figure 11 is a connection diagram for the front panel header.

Table 24. Front Panel Header

Pin	Signal	In/Out	Description	Pin	Signal	In/Out	Description
Hard Drive Activity LED				Power LED			
1	HD_PWR	Out	Hard disk LED pull-up to +5 V	2	HDR_BLNK_GRN	Out	Front panel green LED
3	HDA#	Out	Hard disk active LED	4	HDR_BLNK_YEL	Out	Front panel yellow LED
Reset Switch				On/Off Switch			
5	Ground		Ground	6	FPBUT_IN	In	Power switch
7	FP_RESET#	In	Reset switch	8	Ground		Ground
Power				Not Connected			
9	+5 V		Power	10	N/C		Not connected

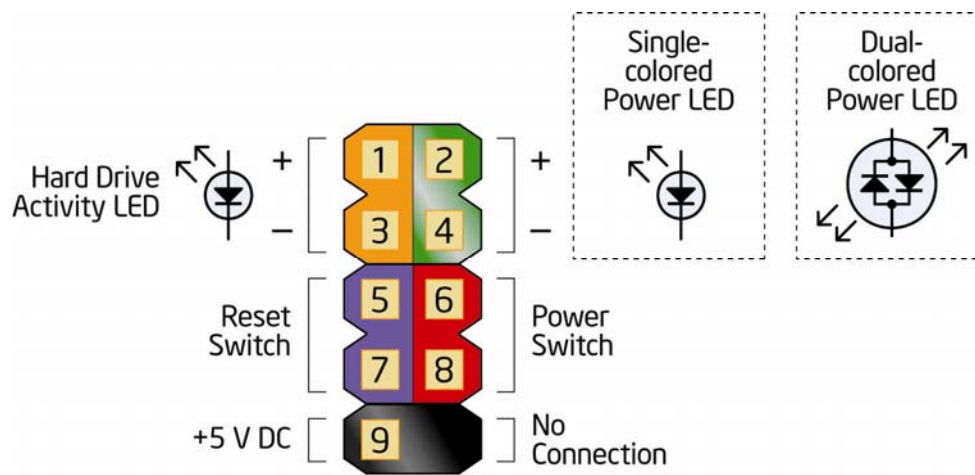

OM20176

Figure 11. Connection Diagram for Front Panel Header

2.2.2.4.1 Hard Drive Activity LED Header

Pins 1 and 3 can be connected to an LED to provide a visual indicator that data is being read from or written to a hard drive.

2.2.2.4.2 Reset Switch Header

Pins 5 and 7 can be connected to a momentary single pole, single throw (SPST) type switch that is normally open. When the switch is closed, the board resets and runs the POST.

2.2.2.4.3 Power/Sleep LED Header

Pins 2 and 4 can be connected to a single- or dual-color LED. Table 25 shows the default states for a single-color LED.

Table 25. States for a One-Color Power LED

LED State	Description
Off	Power off/hibernate (S5/S4)
Blinking	Sleeping (S3)
Steady Green	Running/Away (S0/S1)



NOTE

The LED states listed in Table 25 are default settings that can be modified through BIOS setup. Systems built with a dual-color front panel power LED can also use alternate color state options.

2.2.2.4.4 Power Switch Header

Pins 6 and 8 can be connected to a front panel momentary-contact power switch. The switch must pull the SW_ON# pin to ground for at least 50 ms to signal the power supply circuitry to switch on or off. (The time requirement is due to internal debounce circuitry on the board.) At least two seconds must pass before the power supply circuitry will recognize another on/off signal.

2.2.2.5 Front Panel USB Headers

Figure 12 and Figure 13 are connection diagrams for the front panel USB headers.



NOTE

- The +5 VDC power on the USB headers is fused.
- Use only a front panel USB connector that conforms to the USB 2.0 specification for high-speed USB devices.

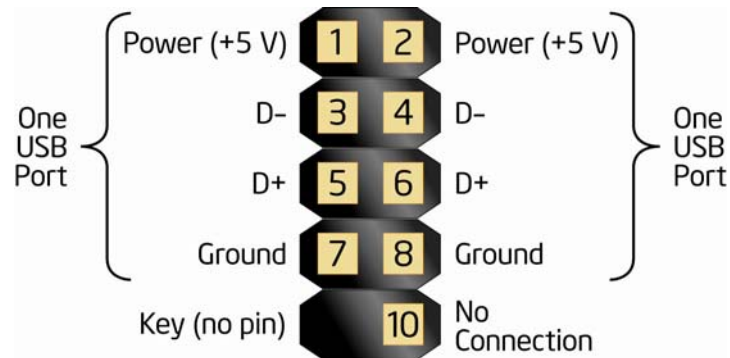

OM20141

Figure 12. Connection Diagram for Front Panel USB Header

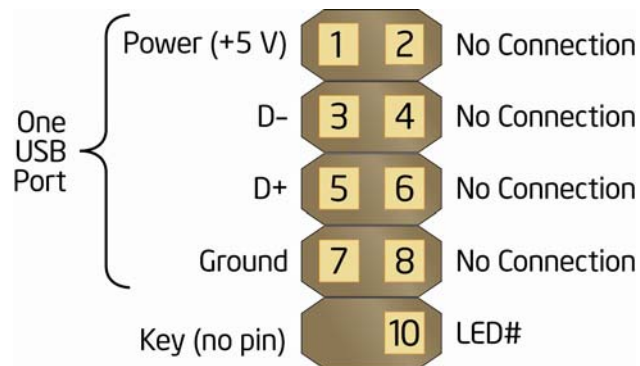

OM21794

Figure 13. Connection Diagram for Front Panel USB Header with Intel Z-U130 USB Solid-State Drive or Compatible Device Support (D425KTW only)

2.3 BIOS Configuration Jumper Block

CAUTION

Do not move the jumper with the power on. Always turn off the power and unplug the power cord from the computer before changing a jumper setting. Otherwise, the board could be damaged.

Figure 14 shows the location of the jumper block. The jumper determines the BIOS Setup program's mode. Table 26 lists the jumper settings for the three modes: normal, configure, and recovery.

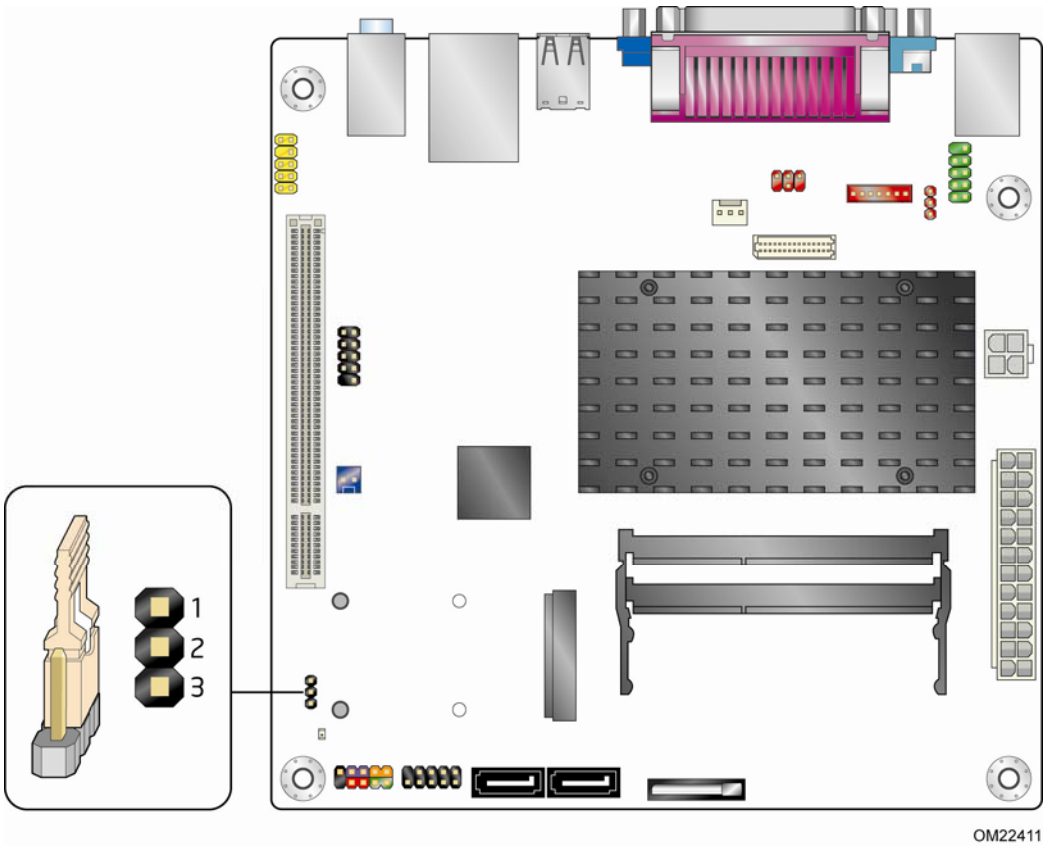

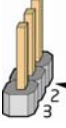

Figure 14. Location of the BIOS Configuration Jumper Block

Intel Desktop Board D425KT and Intel Desktop Board D425KTW Technical Product Specification

Table 26. BIOS Configuration Jumper Settings

Function/Mode	Jumper Setting	Configuration
Normal	1-2 	The BIOS uses current configuration information and passwords for booting.
Configure	2-3 	After the POST runs, Setup runs automatically. The maintenance menu is displayed.
Recovery	None 	The BIOS attempts to recover the BIOS configuration. See Section 3.6.1 for more information on BIOS recovery.

2.4 Mechanical Considerations

2.4.1 Form Factor

The board is designed to fit into a mini-ITX or microATX form-factor chassis. Figure 15 illustrates the mechanical form factor for the board. Dimensions are given in inches [millimeters]. The outer dimensions are 6.7 inches by 6.7 inches [170 millimeters by 170 millimeters]. Location of the I/O connectors and mounting holes are in compliance with the microATX specification.

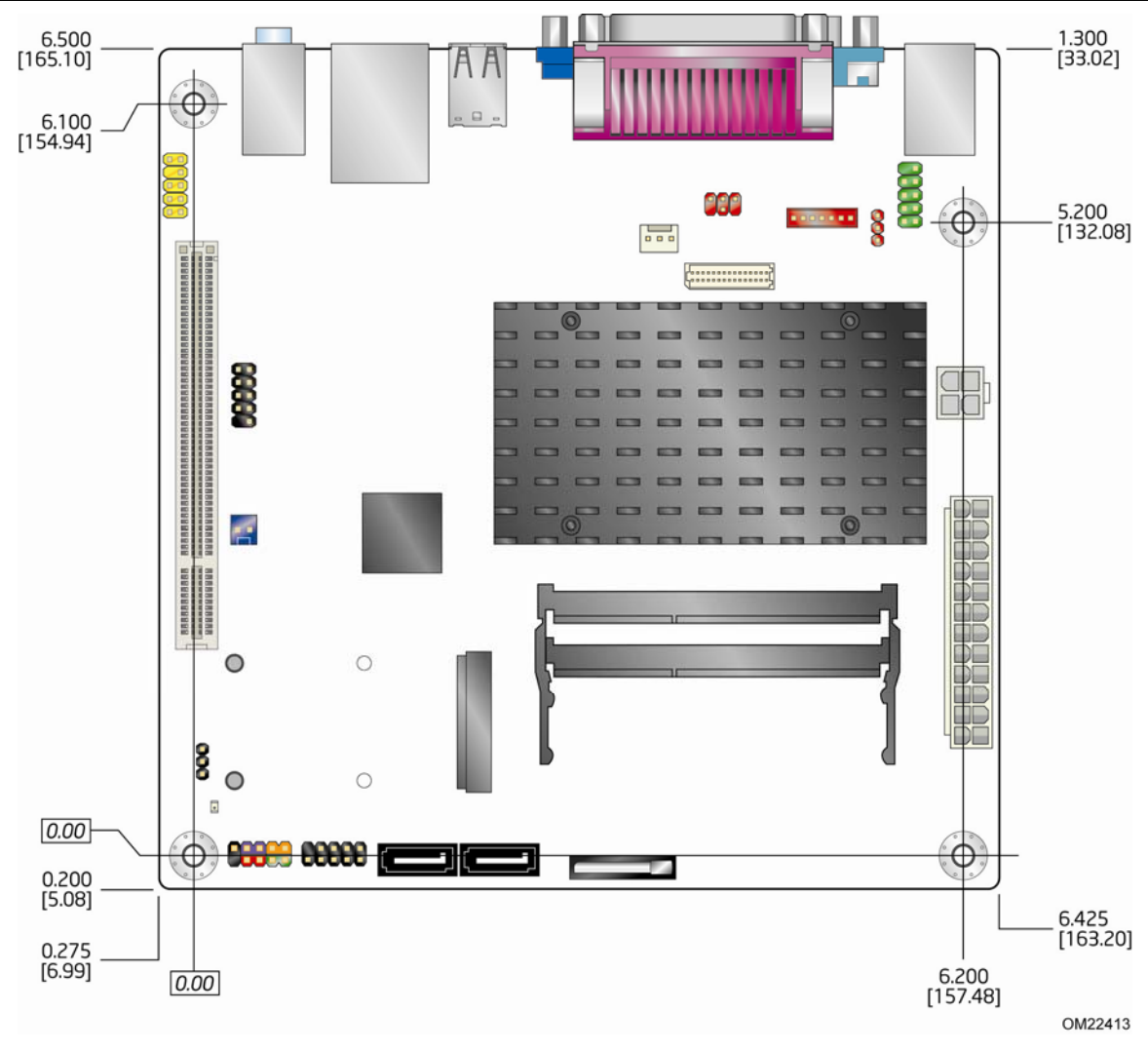

Figure 15. Board Dimensions

2.5 Electrical Considerations

2.5.1 Fan Header Current Capability

Table 27 lists the current capability of the fan header.

Table 27. Fan Header Current Capability

Fan Header	Maximum Available Current
Chassis fan	1.5 A

2.5.2 Add-in Board Considerations

The board is designed to provide 2 A (average) of +5 V current for the PCI Conventional slot. The total +5 V current draw for the PCI Conventional expansion slot (total load) must not exceed 2 A.

2.6 Thermal Considerations



CAUTION

A chassis with a maximum internal ambient temperature of 38 °C at the processor fan inlet is a requirement.



CAUTION

Failure to ensure appropriate airflow may result in reduced performance of both the processor and/or voltage regulator or, in some instances, damage to the board. For a list of chassis that have been tested with Intel Desktop Boards please refer to the following website:

<http://developer.intel.com/design/motherbd/cooling.htm>

All responsibility for determining the adequacy of any thermal or system design remains solely with the reader. Intel makes no warranties or representations that merely following the instructions presented in this document will result in a system with adequate thermal performance.



CAUTION

Ensure that the ambient temperature does not exceed the board's maximum operating temperature. Failure to do so could cause components to exceed their maximum case temperature and malfunction. For information about the maximum operating temperature, see the environmental specifications in Section 2.9.



CAUTION

Ensure that proper airflow is maintained in the processor voltage regulator circuit. Failure to do so may result in damage to the voltage regulator circuit. The processor voltage regulator area (shown in Figure 16) can reach a temperature of up to 85 °C in an open chassis.

Figure 16 shows the locations of the localized high temperature zones.

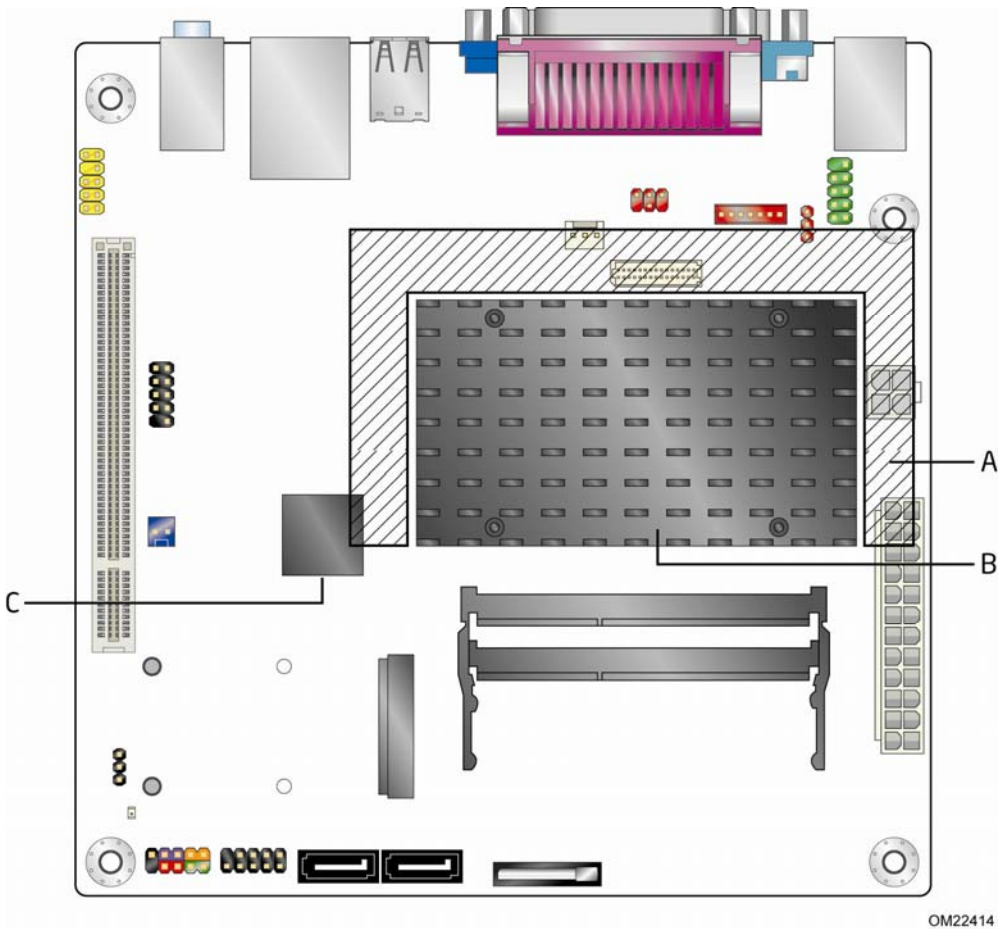

Item	Description
A	Processor voltage regulator area
B	Intel Atom processor
C	Intel NM10 Express Chipset

Figure 16. Localized High Temperature Zones

Table 28 provides maximum case temperatures for the board components that are sensitive to thermal changes. The operating temperature, current load, or operating frequency could affect case temperatures. Maximum case temperatures are important when considering proper airflow to cool the board.

Table 28. Thermal Considerations for Components

Component	Maximum Case Temperature
Intel Atom processor	99 °C
Processor voltage regulator area	85 °C
Intel NM10 Express Chipset	113 °C
Memory SO-DIMM	85 °C

For information about	Refer to
Processor datasheets and specification updates	Section 1.2, page 14

2.6.1 Passive Heatsink Design in a Passive System Environment

This section highlights important guidelines and related thermal boundary conditions for passive heatsink design in a passive system environment. Passive heatsink describes a thermal solution without a fan attached. Passive system environment describes a chassis with either a power supply fan or a built-in chassis fan.

This information should be used in conjunction with the *Thermal/Mechanical Specifications and Design Guidelines* (TMSDG) published for Intel® Atom™ D400 and D500 Series processors. The TMSDG contains detailed package information and thermal mechanical specifications for the processors. The TMSDG also contains information on how to enable a completely fanless design provided the right usage scenario and boundary conditions are observed for optimal thermal design. While the TMSDG has a section on thermal design for passive system environments (pages 29-30), the information in this section can also be used to complement the TMSDG.

2.6.1.1 Definition of Terms

Term	Description
T_A	The measured ambient temperature locally surrounding the processor. The ambient temperature should be measured just upstream of a passive heatsink.
T_J	Processor junction temperature.
Ψ_{JA}	Junction-to-ambient thermal characterization parameter (psi). A measure of thermal solution performance using total package power. Defined as $(T_J - T_A)/TDP$. Note: Heat source must be specified for Ψ measurements.
TIM	Thermal Interface Material: the thermally conductive compound between the heatsink and the processor die surface. This material fills the air gaps and voids, and enhances the transfer of the heat from the processor die surface to the heatsink.
TDP	Thermal Design Power: a power dissipation target based on worst-case applications. Thermal solutions should be designed to dissipate the thermal design power.
T_A external	The measured external ambient temperature surrounding the chassis. The external ambient temperature should be measured just upstream of the chassis inlet vent.

2.6.1.2 Thermal Specifications Guideline

Terms	Requirements
T_A	$\leq 50\text{ }^\circ\text{C}$
T_J	$\leq 100\text{ }^\circ\text{C}$
Ψ_{JA}	$\leq 3.85\text{ }^\circ\text{C/W}$
TIM	Honeywell PCM45F
TDP	13 W
T_A external	$\leq 35\text{ }^\circ\text{C}$

2.6.1.3 Heatsink Design Guideline

Maximum heatsink size ^(Note)	87 x 62 x 35.54 mm
Heatsink mass	≤ 80 grams
Retention type	Spring loaded fasteners
Heatsink preload	11.3 +/- 3.6 lb

Note: Refers to the heatsink installed on the board.

2.6.1.4 Chassis Design Guideline

The pin fin heatsink design used on this board will be able to dissipate up to 13 W of processor power in most of the passively enabled system chassis. This board is targeted for 3-7 liters volumetric or larger, desktop/tower orientation, mini-ITX and micro-ATX chassis with a chassis fan. The recommended fan type is an exhaust fan.

For best thermal performance, it is recommended that the chassis fan provide reasonable airflow directly over the all the major components on the board. The pin fin heatsink is designed to have the best thermal performance when airflow direction is parallel to the heatsink fins.

The processor on the board will generate the highest amount of heat, leading to high ambient temperature within the chassis. The chassis fan should be located near the board region in order to effectively regulate airflow (see Figure 17). A chassis fan located further away from the board region, i.e., at the optical disk drive or hard disk drive region, will be less effective in controlling the local ambient temperature. Regardless of where the chassis fan is located, the maximum local ambient temperature as defined by T_A should be capped at 50 °C. Chassis inlet vents should also provide adequate openings for airflow to pass through. The recommended free-area-ratio of chassis vents should be equal to or greater than 0.53. By using the reference pin fin heatsink, most chassis with a chassis fan enabled should have local ambient temperature safely below the 50 °C limit.

Intel Desktop Board D425KT and Intel Desktop Board D425KTW Technical Product Specification

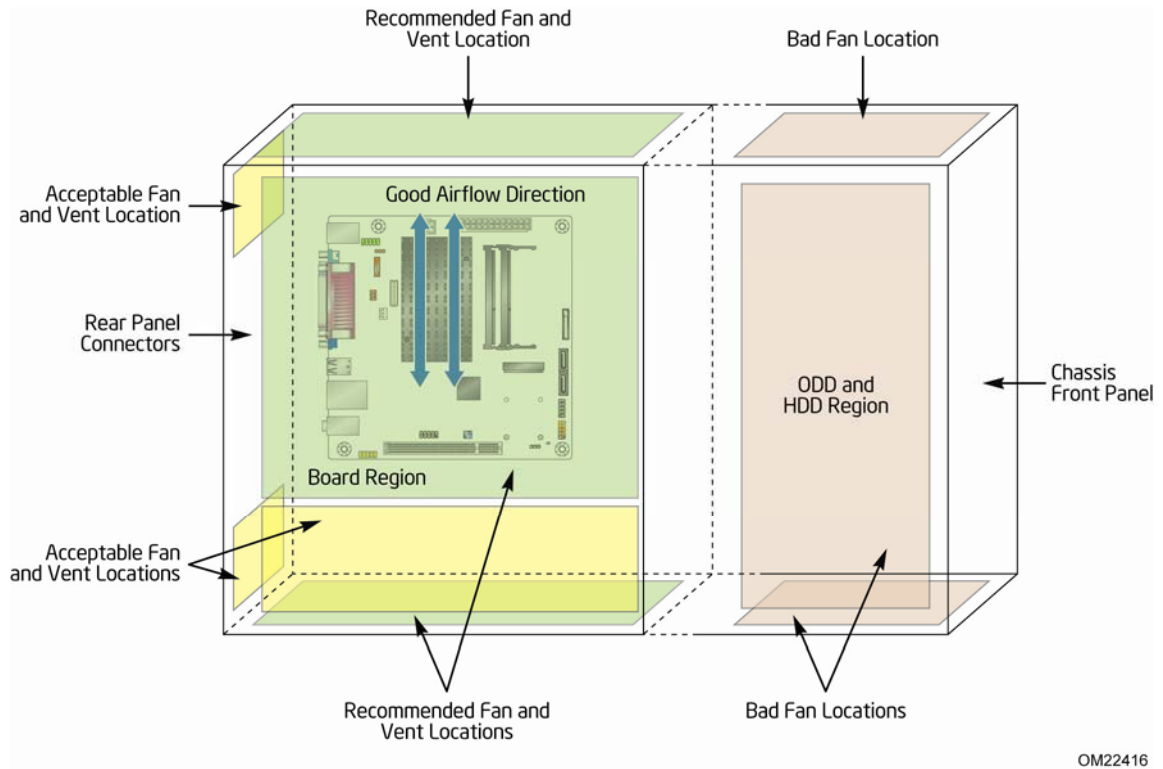

OM22416

**Figure 17. Fan Location Guide for Chassis Selection
(Chassis Orientation is Not Restricted)**

For all chassis configurations, the heatsink performance parameter, Ψ_{JA} should be less than 3.85 °C/W. The detail thermal measurement metrology is described in the TMSDG. For chassis that fail to meet the thermal specifications guideline highlighted above, an actively cooled heatsink solution should be used.

2.7 Power Consumption

Power measurements were performed to determine bare minimum and likely maximum power requirements from the board, as well as attached devices, in order to facilitate power supply rating estimates for specific system configurations.

2.7.1 Minimum Load Configuration

Minimum load refers to the power demand placed on the power supply when using a bare system configuration with minimal power requirement conditions. Minimum load configuration test results are shown in Table 29. The test configuration was defined as follows:

- 2 GB DDR3/800 MHz SO-DIMM
- USB keyboard and mouse
- LAN linked at 100 Mb/s
- DOS booted via network (PXE); system at idle
- All on board peripherals enabled (serial, parallel, audio, ...)

Table 29. Minimum Load Configuration Current and Power Results

Output Voltage	3.3 V	5 V	12 V1	12 V2	-12 V	5 VSB
Minimum Load	0.46 A	2.3 A	0.37 A	0.062A	0.025A	0.13A

2.7.2 Maximum Load Configuration

Maximum load refers to the incremental power demands placed on the power supply, augmenting the minimum load configuration into a fully-featured system that stresses power consumption from all subsystems. Maximum load configuration test results are shown in Table 30. The test configuration was defined as follows:

- 4 GB DDR3/800 MHz SO-DIMM
- 14.1-inch LCD via LVDS (D425KTW only)
- SATA DVD-R/W
 - Load: DVD playback
- 3.5-inch SATA hard disk drive, running Microsoft Windows Vista Home Basic
 - Load: continuous read/write benchmark
- 2.5-inch SATA hard disk drive
 - Load: continuous read/write benchmark
- Intel Z-U130 USB Solid-State Drive or compatible device on the USB flash drive header (D425KTW only)
 - Load: continuous read/write benchmark
- Wireless card on PCI Express x1 Mini Card slot (D425KTW only), connected via 802.11n protocol
 - Load: continuous read/write benchmark on remote share

Intel Desktop Board D425KT and Intel Desktop Board D425KTW Technical Product Specification

- Riser card on conventional PCI slot, populated with PCI LAN card, running file transfer through local network to SATA hard drive
- USB keyboard and mouse
- Back and front panel host-powered USB devices (other than keyboard and mouse)
 - Load: continuous read/write activity on external drive/peripheral
- LAN linked at 100 Mb/s
 - Load: continuous read/write benchmark on remote share
- All on board peripherals enabled (serial, parallel, audio, ...)

Table 30. Maximum Load Configuration Current and Power Results

Output Voltage	3.3 V	5 V	12 V1	12 V2	-12 V	5 VSB
Maximum Load	0.47 A	4.6 A	0.86 A	0.17A	0.025A	0.24A

2.8 Reliability

The Mean Time Between Failures (MTBF) prediction is calculated using component and subassembly random failure rates. The calculation is based on the Telcordia SR-332, Method I Case 1 50% electrical stress, 55 °C ambient. The MTBF prediction is used to estimate repair rates and spare parts requirements.

The MTBF data was calculated from predicted data at 55 °C. The Intel Desktop Board D425KT and Intel Desktop Board D425KTW have an MTBF of at least 507,404 hours.

2.9 Environmental

Table 31 lists the environmental specifications for the board.

Table 31. Intel Desktop Board D425KT and Intel Desktop Board D425KTW Environmental Specifications

Parameter	Specification		
Temperature			
Non-Operating	-20 °C to +70 °C		
Operating	0 °C to +50 °C		
Shock			
Unpackaged	50 g trapezoidal waveform Velocity change of 170 inches/second ²		
Packaged	Half sine 2 millisecond		
	Product weight (pounds)	Free fall (inches)	Velocity change (inches/s ²)
	<20	36	167
	21-40	30	152
	41-80	24	136
	81-100	18	118
Vibration			
Unpackaged	5 Hz to 20 Hz: 0.01 g ² Hz sloping up to 0.02 g ² Hz 20 Hz to 500 Hz: 0.02 g ² Hz (flat)		
Packaged	10 Hz to 40 Hz: 0.015 g ² Hz (flat) 40 Hz to 500 Hz: 0.015 g ² Hz sloping down to 0.00015 g ² Hz		

Intel Desktop Board D425KT and Intel Desktop Board D425KTW Technical Product Specification

3 Overview of BIOS Features

3.1 Introduction

The board uses an Intel BIOS that is stored in the Serial Peripheral Interface Flash Memory (SPI Flash) and can be updated using a disk-based program. The SPI Flash contains the BIOS Setup program, POST, the PCI auto-configuration utility, LAN EEPROM information, and Plug and Play support.

The BIOS displays a message during POST identifying the type of BIOS and a revision code. The initial production BIOSs are identified as MWPNT10N.86A.

The BIOS Setup program can be used to view and change the BIOS settings for the computer. The BIOS Setup program is accessed by pressing the <F2> key after the Power-On Self-Test (POST) memory test begins and before the operating system boot begins. The menu bar is shown below.

Maintenance	Main	Advanced	Security	Power	Boot	Exit
-------------	------	----------	----------	-------	------	------



NOTE

The maintenance menu is displayed only when the board is in configure mode. Section 2.3 on page 49 shows how to put the board in configure mode.

Table 32 lists the BIOS Setup program menu features.

Table 32. BIOS Setup Program Menu Bar

Maintenance	Main	Advanced	Security	Power	Boot	Exit
Clears passwords and displays processor information	Displays processor and memory configuration	Configures advanced features available through the chipset	Sets passwords and security features	Configures power management features and power states options	Selects boot options	Saves or discards changes to Setup program options

Table 33 lists the function keys available for menu screens.

Table 33. BIOS Setup Program Function Keys

BIOS Setup Program Function Key	Description
<←> or <→>	Selects a different menu screen (Moves the cursor left or right)
<↑> or <↓>	Selects an item (Moves the cursor up or down)
<Enter>	Executes command or selects the submenu
<F9>	Load the default configuration values for the current menu
<F10>	Save the current values and exits the BIOS Setup program
<Esc>	Exits the menu

3.2 BIOS Flash Memory Organization

The Serial Peripheral Interface Flash Memory (SPI Flash) includes an 8 Mbit (1024 KB) flash memory device.

3.3 Resource Configuration

3.3.1 PCI* Autoconfiguration

The BIOS can automatically configure PCI devices. PCI devices may be onboard or add-in cards. Autoconfiguration lets a user insert or remove PCI cards without having to configure the system. When a user turns on the system after adding a PCI card, the BIOS automatically configures interrupts, the I/O space, and other system resources. Any interrupts set to Available in Setup are considered to be available for use by the add-in card.

3.4 System Management BIOS (SMBIOS)

SMBIOS is a Desktop Management Interface (DMI) compliant method for managing computers in a managed network.

The main component of SMBIOS is the Management Information Format (MIF) database, which contains information about the computing system and its components. Using SMBIOS, a system administrator can obtain the system types, capabilities, operational status, and installation dates for system components. The MIF database defines the data and provides the method for accessing this information. The BIOS enables applications such as third-party management software to use SMBIOS. The BIOS stores and reports the following SMBIOS information:

- BIOS data, such as the BIOS revision level
- Fixed-system data, such as peripherals, serial numbers, and asset tags
- Resource data, such as memory size, cache size, and processor speed
- Dynamic data, such as event detection and error logging

Non-Plug and Play operating systems require an additional interface for obtaining the SMBIOS information. The BIOS supports an SMBIOS table interface for such operating systems. Using this support, an SMBIOS service-level application running on a non-Plug and Play operating system can obtain the SMBIOS information. Additional board information can be found in the BIOS under the Additional Information header under the Main BIOS page.

3.5 Legacy USB Support

Legacy USB support enables USB devices to be used even when the operating system's USB drivers are not yet available. Legacy USB support is used to access the BIOS Setup program, and to install an operating system that supports USB. By default, Legacy USB support is set to Enabled.

Legacy USB support operates as follows:

1. When you apply power to the computer, legacy support is disabled.
2. POST begins.
3. Legacy USB support is enabled by the BIOS allowing you to use a USB keyboard to enter and configure the BIOS Setup program and the maintenance menu.
4. POST completes.
5. The operating system loads. While the operating system is loading, USB keyboards and mice are recognized and may be used to configure the operating system. (Keyboards and mice are not recognized during this period if Legacy USB support was set to Disabled in the BIOS Setup program.)
6. After the operating system loads the USB drivers, all legacy and non-legacy USB devices are recognized by the operating system, and Legacy USB support from the BIOS is no longer used.
7. Additional USB legacy feature options can be accessed by using Intel Integrator Toolkit.

To install an operating system that supports USB, verify that Legacy USB support in the BIOS Setup program is set to Enabled and follow the operating system's installation instructions.

3.6 BIOS Updates

The BIOS can be updated using either of the following utilities, which are available on the Intel World Wide Web site:

- Intel® Express BIOS Update utility, which enables automated updating while in the Windows environment. Using this utility, the BIOS can be updated from a file on a hard disk, a USB drive (a flash drive or a USB drive), or an optical drive.
- Intel® Flash Memory Update Utility, which requires booting from DOS. Using this utility, the BIOS can be updated from a file on a hard disk, a USB drive (a flash drive or a USB drive), or an optical drive.
- Intel® F7 switch allows a user to select where the BIOS .bio file is located and perform the update from that location/device. Similar to performing a BIOS Recovery without removing the BIOS configuration jumper.

Both utilities verify that the updated BIOS matches the target system to prevent accidentally installing an incompatible BIOS.



NOTE

Review the instructions distributed with the upgrade utility before attempting a BIOS update.

For information about

Refer to

BIOS update utilities

<http://downloadcenter.intel.com>

3.6.1 BIOS Recovery

It is unlikely that anything will interrupt a BIOS update; however, if an interruption occurs, the BIOS could be damaged. Table 34 lists the drives and media types that can and cannot be used for BIOS recovery. The BIOS recovery media does not need to be made bootable.

Table 34. Acceptable Drives/Media Types for BIOS Recovery

Media Type	Can be used for BIOS recovery?
Optical drive connected to the SATA interface	Yes
USB removable drive (a USB Flash Drive, for example)	Yes
USB diskette drive (with a 1.44 MB diskette)	No
USB hard disk drive	No

For information about

Refer to

BIOS update instructions

<http://www.intel.com/support/motherboards/desktop/sb/CS-022312.htm>

3.6.2 Custom Splash Screen

During POST, an Intel® splash screen is displayed by default. This splash screen can be augmented with a custom splash screen. The Intel® Integrator's Toolkit that is available from Intel can be used to create a custom splash screen.



NOTE

If you add a custom splash screen, it will share space with the Intel branded logo.

For information about	Refer to
Intel Integrator Toolkit	http://developer.intel.com/design/motherbd/software/itk/

3.7 Boot Options

In the BIOS Setup program, the user can choose to boot from a hard drive, optical drive, removable drive, or the network. The default setting is for the optical drive to be the first boot device, the hard drive second, removable drive third, and the network fourth.

3.7.1 Optical Drive Boot

Booting from the optical drive is supported in compliance to the El Torito bootable CD-ROM format specification. Under the Boot menu in the BIOS Setup program, the optical drive is listed as a boot device. Boot devices are defined in priority order. Accordingly, if there is not a bootable CD in the optical drive, the system will attempt to boot from the next defined drive.

3.7.2 Network Boot

The network can be selected as a boot device. This selection allows booting from the onboard LAN or a network add-in card with a remote boot ROM installed.

Pressing the <F12> key during POST automatically forces booting from the LAN. To use this key during POST, the User Access Level in the BIOS Setup program's Security menu must be set to Full.

3.7.3 Booting Without Attached Devices

For use in embedded applications, the BIOS has been designed so that after passing the POST, the operating system loader is invoked even if the following devices are not present:

- Video adapter
- Keyboard
- Mouse

3.7.4 Changing the Default Boot Device During POST

Pressing the <F10> key during POST causes a boot device menu to be displayed. This menu displays the list of available boot devices (as set in the BIOS setup program's Boot Device Priority submenu). Table 35 lists the boot device menu options.

Table 35. Boot Device Menu Options

Boot Device Menu Function Keys	Description
<↑> or <↓>	Selects a default boot device
<Enter>	Exits the menu, saves changes, and boots from the selected device
<Esc>	Exits the menu without saving changes

3.8 BIOS Security Features

The BIOS includes security features that restrict access to the BIOS Setup program and who can boot the computer. A supervisor password and a user password can be set for the BIOS Setup program and for booting the computer, with the following restrictions:

- The supervisor password gives unrestricted access to view and change all the Setup options in the BIOS Setup program. This is the supervisor mode.
- The user password gives restricted access to view and change Setup options in the BIOS Setup program. This is the user mode.
- If only the supervisor password is set, pressing the <Enter> key at the password prompt of the BIOS Setup program allows the user restricted access to Setup.
- If both the supervisor and user passwords are set, users can enter either the supervisor password or the user password to access Setup. Users have access to Setup respective to which password is entered.
- Setting the user password restricts who can boot the computer. The password prompt will be displayed before the computer is booted. If only the supervisor password is set, the computer boots without asking for a password. If both passwords are set, the user can enter either password to boot the computer.
- For enhanced security, use different passwords for the supervisor and user passwords.
- Valid password characters are A-Z, a-z, and 0-9. Passwords may be up to 16 characters in length.

Table 36 shows the effects of setting the supervisor password and user password. This table is for reference only and is not displayed on the screen.

Table 36. Supervisor and User Password Functions

Password Set	Supervisor Mode	User Mode	Setup Options	Password to Enter Setup	Password During Boot
Neither	Can change all options (Note)	Can change all options (Note)	None	None	None
Supervisor only	Can change all options	Can change a limited number of options	Supervisor Password	Supervisor	None
User only	N/A	Can change all options	Enter Password Clear User Password	User	User
Supervisor and user set	Can change all options	Can change a limited number of options	Supervisor Password Enter Password	Supervisor or user	Supervisor or user

Note: If no password is set, any user can change all Setup options.

4 Board Status and Error Messages

4.1 BIOS Beep Codes

The BIOS uses audible beep codes to signal status messages and error messages indicating recoverable errors that occur during the POST. The beep codes are listed in Table 37. These beep codes can be heard through a speaker attached to the board's line out audio jack (see Figure 4, B on page 24).

Table 37. BIOS Beep Codes

Type	Pattern	Frequency
F2 Setup/F10 Boot Menu Prompt	One 0.5 second beep when BIOS is ready to accept keyboard input	932 Hz
BIOS update in progress	None	
Video error	On-off (1.0 second each) two times, then 2.5-second pause (off), entire pattern repeats (beeps and pause) once and the BIOS will continue to boot.	932 Hz When no VGA option ROM is found.
Memory error	On-off (1.0 second each) three times, then 2.5-second pause (off), entire pattern repeats (beeps and pause) until the system is powered off.	932 Hz
Thermal trip warning	Alternate high and low beeps (1.0 second each) for eight beeps, followed by system shut down.	High beep 2000 Hz Low beep 1500 Hz

4.2 Front-panel Power LED Blink Codes

Whenever a recoverable error occurs during POST, the BIOS causes the board's front panel power LED to blink an error message describing the problem (see Table 38).

Table 38. Front-panel Power LED Blink Codes

Type	Pattern	Note
F2 Setup/F10 Boot Menu Prompt	None	
BIOS update in progress	Off when the update begins, then on for 0.5 seconds, then off for 0.5 seconds. The pattern repeats until the BIOS update is complete.	
Video error	On-off (1.0 second each) two times, then 2.5-second pause (off), entire pattern repeats (blink and pause) until the system is powered off.	When no VGA option ROM is found.
Memory error	On-off (1.0 second each) three times, then 2.5-second pause (off), entire pattern repeats (blinks and pause) until the system is powered off.	
Thermal trip warning	Each beep will be accompanied by the following blink pattern: .25 seconds On, .25 seconds Off, .25 seconds On, .25 seconds Off. This will result in a total of 16 blinks.	

4.3 BIOS Error Messages

Whenever a recoverable error occurs during POST, the BIOS displays an error message describing the problem. Table 39 lists the error messages and provides a brief description of each.

Table 39. BIOS Error Messages

Error Message	Explanation
CMOS Battery Low	The battery may be losing power. Replace the battery soon.
CMOS Checksum Bad	The CMOS checksum is incorrect. CMOS memory may have been corrupted. Run Setup to reset values.
Memory Size Decreased	Memory size has decreased since the last boot. If no memory was removed, then memory may be bad.
No Boot Device Available	System did not find a device to boot.

4.4 Port 80h POST Codes

During the POST, the BIOS generates diagnostic progress codes (POST codes) to I/O port 80h. If the POST fails, execution stops and the last POST code generated is left at port 80h. This code is useful for determining the point where an error occurred.

Displaying the POST codes requires a PCI bus add-in card, often called a POST card. The POST card can decode the port and display the contents on a medium such as a seven-segment display.



NOTE

The POST card must be installed in the PCI bus connector.

The following tables provide information about the POST codes generated by the BIOS:

- Table 40 lists the Port 80h POST code ranges
- Table 41 lists the Port 80h POST codes themselves
- Table 42 lists the Port 80h POST sequence



NOTE

In the tables listed above, all POST codes and range values are listed in hexadecimal.

Table 40. Port 80h POST Code Ranges

Range	Category/Subsystem
00 – 0F	Debug codes: Can be used by any PEIM/driver for debug.
10 – 1F	Host Processors: 1F is an unrecoverable CPU error.
20 – 2F	Memory/Chipset: 2F is no memory detected or no useful memory detected.
30 – 3F	Recovery: 3F indicated recovery failure.
40 – 4F	Reserved for future use.
50 – 5F	I/O Busses: PCI, USB, ISA, ATA, etc. 5F is an unrecoverable error. Start with PCI.
60 – 6F	Reserved for future use (for new busses).
70 – 7F	Output Devices: All output consoles. 7F is an unrecoverable error.
80 – 8F	Reserved for future use (new output console codes).
90 – 9F	Input devices: Keyboard/Mouse. 9F is an unrecoverable error.
A0 – AF	Reserved for future use (new input console codes).
B0 – BF	Boot Devices: Includes fixed media and removable media. BF is an unrecoverable error.
C0 – CF	Reserved for future use.
D0 – DF	Boot device selection.
E0 – FF	E0 – EE: Miscellaneous codes. See Table 41. EF: boot/S3 resume failure. F0 – FF: FF processor exception.

Intel Desktop Board D425KT and Intel Desktop Board D425KTW Technical Product Specification

Table 41. Port 80h POST Codes

POST Code	Description of POST Operation
Host Processor	
10	Power-on initialization of the host processor (Boot Strap Processor)
11	Host processor cache initialization (including APs)
12	Starting Application processor initialization
13	SMM initialization
Chipset	
21	Initializing a chipset component
Memory	
22	Reading SPD from memory DIMMs
23	Detecting presence of memory DIMMs
24	Programming timing parameters in the memory controller and the DIMMs
25	Configuring memory
26	Optimizing memory settings
27	Initializing memory, such as ECC init
28	Testing memory
PCI Bus	
50	Enumerating PCI busses
51	Allocating resources to PCI bus
52	Hot Plug PCI controller initialization
53 – 57	Reserved for PCI Bus
USB	
58	Resetting USB bus
59	Reserved for USB
ATA/ATAPI/SATA	
5A	Resetting PATA/SATA bus and all devices
5B	Reserved for ATA
SMBus	
5C	Resetting SMBus
5D	Reserved for SMBus
Local Console	
70	Resetting the VGA controller
71	Disabling the VGA controller
72	Enabling the VGA controller
Remote Console	
78	Resetting the console controller
79	Disabling the console controller
7A	Enabling the console controller

continued

Table 41. Port 80h POST Codes (continued)

POST Code	Description of POST Operation
Keyboard (PS/2 or USB)	
90	Resetting keyboard
91	Disabling keyboard
92	Detecting presence of keyboard
93	Enabling the keyboard
94	Clearing keyboard input buffer
95	Instructing keyboard controller to run Self Test (PS/2 only)
Mouse (PS/2 or USB)	
98	Resetting mouse
99	Disabling mouse
9A	Detecting presence of mouse
9B	Enabling mouse
Fixed Media	
B0	Resetting fixed media
B1	Disabling fixed media
B2	Detecting presence of a fixed media (hard drive detection etc.)
B3	Enabling/configuring a fixed media
Removable Media	
B8	Resetting removable media
B9	Disabling removable media
BA	Detecting presence of a removable media (CD-ROM detection, etc.)
BC	Enabling/configuring a removable media
BDS	
Dy	Trying boot selection y (y=0 to 15)
PEI Core	
E0	Started dispatching PEIMs (emitted on first report of EFI_SW_PC_INIT_BEGIN EFI_SW_PEI_PC_HANDOFF_TO_NEXT)
E2	Permanent memory found
E1, E3	Reserved for PEI/PEIMs
DXE Core	
E4	Entered DXE phase
E5	Started dispatching drivers
E6	Started connecting drivers

continued

Intel Desktop Board D425KT and Intel Desktop Board D425KTW Technical Product Specification

Table 41. Port 80h POST Codes (continued)

POST Code	Description of POST Operation
	DXE Drivers
E7	Waiting for user input
E8	Checking password
E9	Entering BIOS setup
EB	Calling Legacy Option ROMs
	Runtime Phase/EFI OS Boot
F4	Entering Sleep state
F5	Exiting Sleep state
F8	EFI boot service ExitBootServices () has been called
F9	EFI runtime service SetVirtualAddressMap () has been called
FA	EFI runtime service ResetSystem () has been called
	PEIMs/Recovery
30	Crisis Recovery has initiated per user request
31	Crisis Recovery has initiated by software (corrupt flash)
34	Loading recovery capsule
35	Handing off control to the recovery capsule
3F	Unable to recover

Table 42. Typical Port 80h POST Sequence

POST Code	Description
21	Initializing a chipset component
22	Reading SPD from memory DIMMs
23	Detecting presence of memory DIMMs
25	Configuring memory
28	Testing memory
34	Loading recovery capsule
E4	Entered DXE phase
12	Starting application processor initialization
13	SMM initialization
50	Enumerating PCI busses
51	Allocating resourced to PCI bus
92	Detecting the presence of the keyboard
90	Resetting keyboard
94	Clearing keyboard input buffer
95	Keyboard Self Test
EB	Calling Video BIOS
58	Resetting USB bus
5A	Resetting PATA/SATA bus and all devices
92	Detecting the presence of the keyboard
90	Resetting keyboard
94	Clearing keyboard input buffer
5A	Resetting PATA/SATA bus and all devices
28	Testing memory
90	Resetting keyboard
94	Clearing keyboard input buffer
E7	Waiting for user input
01	INT 19
00	Ready to boot

Intel Desktop Board D425KT and Intel Desktop Board D425KTW Technical Product Specification

5 Regulatory Compliance and Battery Disposal Information

5.1 Regulatory Compliance

This section contains the following regulatory compliance information for Intel Desktop Board D425KT and Intel Desktop Board D425KTW:

- Safety standards
- European Union Declaration of Conformity statement
- Product Ecology statements
- Electromagnetic Compatibility (EMC) standards
- Product certification markings

5.1.1 Safety Standards

Intel Desktop Board D425KT and Intel Desktop Board D425KTW comply with the safety standards stated in Table 43 when correctly installed in a compatible host system.

Table 43. Safety Standards

Standard	Title
CSA/UL 60950-1	Information Technology Equipment – Safety - Part 1: General Requirements (USA and Canada)
EN 60950-1	Information Technology Equipment – Safety - Part 1: General Requirements (European Union)
IEC 60950-1	Information Technology Equipment – Safety - Part 1: General Requirements (International)

5.1.2 European Union Declaration of Conformity Statement

We, Intel Corporation, declare under our sole responsibility that the products Intel® Desktop Board D425KT and Intel® Desktop Board D425KTW are in conformity with all applicable essential requirements necessary for CE marking, following the provisions of the European Council Directive 2004/108/EC (EMC Directive), 2006/95/EC (Low Voltage Directive), and 2002/95/EC (ROHS Directive).

The product is properly CE marked demonstrating this conformity and is for distribution within all member states of the EU with no restrictions.



This product follows the provisions of the European Directives 2004/108/EC, 2006/95/EC, and 2002/95/EC.

Čeština Tento výrobek odpovídá požadavkům evropských směrnic 2004/108/EC, 2006/95/EC a 2002/95/EC.

Dansk Dette produkt er i overensstemmelse med det europæiske direktiv 2004/108/EC, 2006/95/EC & 2002/95/EC.

Dutch Dit product is in navolging van de bepalingen van Europees Directief 2004/108/EC, 2006/95/EC & 2002/95/EC.

Eesti Antud toode vastab Euroopa direktiivides 2004/108/EC, ja 2006/95/EC ja 2002/95/EC kehtestatud nõuetele.

Suomi Tämä tuote noudattaa EU-direktiivin 2004/108/EC, 2006/95/EC & 2002/95/EC määräyksiä.

Français Ce produit est conforme aux exigences de la Directive Européenne 2004/108/EC, 2006/95/EC & 2002/95/EC.

Deutsch Dieses Produkt entspricht den Bestimmungen der Europäischen Richtlinie 2004/108/EC, 2006/95/EC & 2002/95/EC.

Ελληνικά Το παρόν προϊόν ακολουθεί τις διατάξεις των Ευρωπαϊκών Οδηγιών 2004/108/EC, 2006/95/EC και 2002/95/EC.

Magyar E termék megfelel a 2004/108/EC, 2006/95/EC és 2002/95/EC Európai Irányelv előírásainak.

Icelandic Þessi vara stenst reglugerð Evrópska Efnahags Bandalagsins númer 2004/108/EC, 2006/95/EC, & 2002/95/EC.

Italiano Questo prodotto è conforme alla Direttiva Europea 2004/108/EC, 2006/95/EC & 2002/95/EC.

Latviešu Šis produkts atbilst Eiropas Direktīvu 2004/108/EC, 2006/95/EC un 2002/95/EC noteikumiem.

Lietuvių Šis produktas atitinka Europos direktyvų 2004/108/EC, 2006/95/EC, ir 2002/95/EC nuostatas.

Malti Dan il-prodott hu konformi mal-provvedimenti tad-Direttivi Ewropej 2004/108/EC, 2006/95/EC u 2002/95/EC.

Norsk Dette produktet er i henhold til bestemmelsene i det europeiske direktivet 2004/108/EC, 2006/95/EC & 2002/95/EC.

Polski Niniejszy produkt jest zgodny z postanowieniami Dyrektyw Unii Europejskiej 2004/108/EC, 206/95/EC i 2002/95/EC.

Portuguese Este produto cumpre com as normas da Diretiva Europeia 2004/108/EC, 2006/95/EC & 2002/95/EC.

Español Este producto cumple con las normas del Directivo Europeo 2004/108/EC, 2006/95/EC & 2002/95/EC.

Slovensky Tento produkt je v súlade s ustanoveniami európskych direktív 2004/108/EC, 2006/95/EC a 2002/95/EC.

Slovenščina Izdelek je skladen z določbami evropskih direktiv 2004/108/EC, 2006/95/EC in 2002/95/EC.

Svenska Denna produkt har tillverkats i enlighet med EG-direktiv 2004/108/EC, 2006/95/EC & 2002/95/EC.

Türkçe Bu ürün, Avrupa Birliği'nin 2004/108/EC, 2006/95/EC ve 2002/95/EC yönergelerine uyar.

5.1.3 Product Ecology Statements

The following information is provided to address worldwide product ecology concerns and regulations.

5.1.3.1 Disposal Considerations

This product contains the following materials that may be regulated upon disposal: lead solder on the printed wiring board assembly.

5.1.3.2 Recycling Considerations

As part of its commitment to environmental responsibility, Intel has implemented the Intel Product Recycling Program to allow retail consumers of Intel's branded products to return used products to selected locations for proper recycling.

Please consult the http://www.intel.com/intel/other/ehs/product_ecology for the details of this program, including the scope of covered products, available locations, shipping instructions, terms and conditions, etc.

中文

作为其对环境责任之承诺的部分，英特尔已实施 Intel Product Recycling Program（英特尔产品回收计划），以允许英特尔品牌产品的零售消费者将使用过的产品退还至指定地点作恰当的重复使用处理。

请参考http://www.intel.com/intel/other/ehs/product_ecology了解此计划的详情，包括涉及产品之范围、回收地点、运送指导、条款和条件等。

Deutsch

Als Teil von Intels Engagement für den Umweltschutz hat das Unternehmen das Intel Produkt-Recyclingprogramm implementiert, das Einzelhandelskunden von Intel Markenprodukten ermöglicht, gebrauchte Produkte an ausgewählte Standorte für ordnungsgemäßes Recycling zurückzugeben.

Details zu diesem Programm, einschließlich der darin eingeschlossenen Produkte, verfügbaren Standorte, Versandanweisungen, Bedingungen usw., finden Sie auf der http://www.intel.com/intel/other/ehs/product_ecology

Intel Desktop Board D425KT and Intel Desktop Board D425KTW Technical Product Specification

Español

Como parte de su compromiso de responsabilidad medioambiental, Intel ha implantado el programa de reciclaje de productos Intel, que permite que los consumidores al detalle de los productos Intel devuelvan los productos usados en los lugares seleccionados para su correspondiente reciclado.

Consulte la http://www.intel.com/intel/other/ehs/product_ecology para ver los detalles del programa, que incluye los productos que abarca, los lugares disponibles, instrucciones de envío, términos y condiciones, etc.

Français

Dans le cadre de son engagement pour la protection de l'environnement, Intel a mis en œuvre le programme Intel Product Recycling Program (Programme de recyclage des produits Intel) pour permettre aux consommateurs de produits Intel de recycler les produits usés en les retournant à des adresses spécifiées.

Visitez la page Web http://www.intel.com/intel/other/ehs/product_ecology pour en savoir plus sur ce programme, à savoir les produits concernés, les adresses disponibles, les instructions d'expédition, les conditions générales, etc.

日本語

インテルでは、環境保護活動の一環として、使い終えたインテルブランド製品を指定の場所へ返送していただき、リサイクルを適切に行えるよう、インテル製品リサイクルプログラムを発足させました。

対象製品、返送先、返送方法、ご利用規約など、このプログラムの詳細情報は、http://www.intel.com/intel/other/ehs/product_ecology (英語)をご覧ください。

Malay

Sebagai sebahagian daripada komitmennya terhadap tanggungjawab persekitaran, Intel telah melaksanakan Program Kitar Semula Produk untuk membenarkan pengguna-pengguna runcit produk jenama Intel memulangkan produk terguna ke lokasi-lokasi terpilih untuk dikitar semula dengan betul.

Sila rujuk http://www.intel.com/intel/other/ehs/product_ecology untuk mendapatkan butir-butir program ini, termasuklah skop produk yang dirangkumi, lokasi-lokasi tersedia, arahan penghantaran, terma & syarat, dsb.

Portuguese

Como parte deste compromisso com o respeito ao ambiente, a Intel implementou o Programa de Reciclagem de Produtos para que os consumidores finais possam enviar produtos Intel usados para locais selecionados, onde esses produtos são reciclados de maneira adequada.

Consulte o site http://www.intel.com/intel/other/ehs/product_ecology (em Inglês) para obter os detalhes sobre este programa, inclusive o escopo dos produtos cobertos, os locais disponíveis, as instruções de envio, os termos e condições, etc.

Russian

В качестве части своих обязательств к окружающей среде, в Intel создана программа утилизации продукции Intel (Product Recycling Program) для предоставления конечным пользователям марок продукции Intel возможности возврата используемой продукции в специализированные пункты для должной утилизации.

Пожалуйста, обратитесь на веб-сайт http://www.intel.com/intel/other/ehs/product_ecology за информацией об этой программе, принимаемых продуктах, местах приема, инструкциях об отправке, положениях и условиях и т.д.

Türkçe

Intel, çevre sorumluluğuna bağlılığının bir parçası olarak, perakende tüketicilerin Intel markalı kullanılmış ürünlerini belirlenmiş merkezlere iade edip uygun şekilde geri dönüştürmesini amaçlayan Intel Ürünleri Geri Dönüşüm Programı'nı uygulamaya koymuştur.

Bu programın ürün kapsamı, ürün iade merkezleri, nakliye talimatları, kayıtlar ve şartlar v.s dahil bütün ayrıntılarını öğrenmek için lütfen http://www.intel.com/intel/other/ehs/product_ecology

Web sayfasına gidin.

5.1.4 EMC Regulations

Intel Desktop Board D425KT and Intel Desktop Board D425KTW comply with the EMC regulations stated in Table 44 when correctly installed in a compatible host system.

Table 44. EMC Regulations

Regulation	Title
FCC 47 CFR Part 15, Subpart B	Title 47 of the Code of Federal Regulations, Part 15, Subpart B, Radio Frequency Devices. (USA)
ICES-003	Interference-Causing Equipment Standard, Digital Apparatus. (Canada)
EN55022	Limits and methods of measurement of Radio Interference Characteristics of Information Technology Equipment. (European Union)
EN55024	Information Technology Equipment – Immunity Characteristics Limits and methods of measurement. (European Union)
EN55022	Australian Communications Authority, Standard for Electromagnetic Compatibility. (Australia and New Zealand)
CISPR 22	Limits and methods of measurement of Radio Disturbance Characteristics of Information Technology Equipment. (International)
CISPR 24	Information Technology Equipment – Immunity Characteristics – Limits and Methods of Measurement. (International)
VCCI V-3, V-4	Voluntary Control for Interference by Information Technology Equipment. (Japan)
KN-22, KN-24	Korean Communications Commission – Framework Act on Telecommunications and Radio Waves Act (South Korea)
CNS 13438	Bureau of Standards, Metrology, and Inspection (Taiwan)

Intel Desktop Board D425KT and Intel Desktop Board D425KTW Technical Product Specification

FCC Declaration of Conformity

This device complies with Part 15 of the FCC Rules. Operation is subject to the following two conditions: (1) this device may not cause harmful interference, and (2) this device must accept any interference received, including interference that may cause undesired operation.

For questions related to the EMC performance of this product, contact:

Intel Corporation, 5200 N.E. Elam Young Parkway, Hillsboro, OR 97124
1-800-628-8686

This equipment has been tested and found to comply with the limits for a Class B digital device, pursuant to Part 15 of the FCC Rules. These limits are designed to provide reasonable protection against harmful interference in a residential installation. This equipment generates, uses, and can radiate radio frequency energy and, if not installed and used in accordance with the instructions, may cause harmful interference to radio communications. However, there is no guarantee that interference will not occur in a particular installation. If this equipment does cause harmful interference to radio or television reception, which can be determined by turning the equipment off and on, the user is encouraged to try to correct the interference by one or more of the following measures:

- Reorient or relocate the receiving antenna.
- Increase the separation between the equipment and the receiver.
- Connect the equipment to an outlet on a circuit other than the one to which the receiver is connected.
- Consult the dealer or an experienced radio/TV technician for help.

Any changes or modifications to the equipment not expressly approved by Intel Corporation could void the user's authority to operate the equipment.

Tested to comply with FCC standards for home or office use.

Canadian Department of Communications Compliance Statement

This digital apparatus does not exceed the Class B limits for radio noise emissions from digital apparatus set out in the Radio Interference Regulations of the Canadian Department of Communications.

Le présent appareil numérique n'émet pas de bruits radioélectriques dépassant les limites applicables aux appareils numériques de la classe B prescrites dans le Règlement sur le brouillage radioélectrique édicté par le ministère des Communications du Canada.

Japan VCCI Statement

Japan VCCI Statement translation: This is a Class B product based on the standard of the Voluntary Control Council for Interference from Information Technology Equipment (VCCI). If this is used near a radio or television receiver in a domestic environment, it may cause radio interference. Install and use the equipment according to the instruction manual.

この装置は、情報処理装置等電波障害自主規制協議会（VCCI）の基準に基づくクラスB情報技術装置です。この装置は、家庭環境で使用することを目的としていますが、この装置がラジオやテレビジョン受信機に近接して使用されると、受信障害を引き起こすことがあります。
取扱説明書に従って正しい取り扱いをして下さい。

Korea Class B Statement

Korea Class B Statement translation: This equipment is for home use, and has acquired electromagnetic conformity registration, so it can be used not only in residential areas, but also other areas.

이 기기는 가정용(B급)으로 전자파적합등록을 한 기기로서 주로 가정에서 사용하는 것을 목적으로 하며, 모든 지역에서 사용할 수 있습니다.

5.1.5 ENERGY STAR* 5.0, e-Standby, and ErP Compliance

Intel Desktop Board D425KT and Intel Desktop Board D425KTW meet the ENERGY STAR requirements listed in Table 45 when used in corresponding system configurations.

Table 45. ENERGY STAR Requirements

ENERGY STAR Specification	Computer Type	Required States	Capability Adjustments	Typical Electricity Consumption (TEC) Criteria
v4.0	Desktop Computer	Idle State (Cat A)	With and without Wake On LAN (Sleep, Standby)	N/A
v4.0	Integrated Computer	Sleep Mode Standby Level		
v5.0	Desktop Computer	Off Mode	With and without additional internal storage	Cat A under "desktop conventional" and "desktop proxying" operational mode weightings
v5.0	Integrated Desktop Computer	Sleep Mode Idle State Active State		
v5.0	Thin Client	Off Mode Sleep Mode Idle State (Cat B)	With and without Wake On LAN (Sleep, Standby)	N/A

The Desktop Boards also meet the following international requirements:

- Republic of Korea e-Standby program
- European Union Energy-related Products (ErP) directive

For information about

Refer to

ENERGY STAR requirements and recommended configurations

<http://www.intel.com/go/energystar>

Electronic Product Environmental Assessment Tool (EPEAT)

<http://www.epeat.net/>

Korea e-Standby Program

http://www.kemco.or.kr/new_eng/pg02/pg02100300.asp









European Union Energy-related Products Directive 2009 (ErP)

http://ec.europa.eu/enterprise/policies/sustainable-business/sustainable-product-policy/ecodesign/index_en.htm

5.1.6 Regulatory Compliance Marks (Board Level)

Intel Desktop Board D425KT and Intel Desktop Board D425KTW have the regulatory compliance marks shown in Table 46.

Table 46. Regulatory Compliance Marks

Description	Mark
UL joint US/Canada Recognized Component mark. Includes adjacent UL file number for Intel Desktop Boards: E210882.	
FCC Declaration of Conformity logo mark for Class B equipment.	
CE mark. Declaring compliance to the European Union (EU) EMC directive, Low Voltage directive, and RoHS directive.	
Australian Communications Authority (ACA) and New Zealand Radio Spectrum Management (NZ RSM) C-tick mark. Includes adjacent Intel supplier code number, N-232.	
Japan VCCI (Voluntary Control Council for Interference) mark.	
KCC (Korean Communications Commission) EMC certification mark. Includes adjacent KCC certification number: CPU-D425KT (B).	
Taiwan BSMI (Bureau of Standards, Metrology and Inspections) mark. Includes adjacent Intel company number, D33025.	
Printed wiring board manufacturer's recognition mark. Consists of a unique UL recognized manufacturer's logo, along with a flammability rating (solder side).	<p data-bbox="1258 1260 1307 1291">V-0</p>
China RoHS/Environmentally Friendly Use Period Logo: This is an example of the symbol used on Intel Desktop Boards and associated collateral. The color of the mark may vary depending upon the application. The Environmental Friendly Usage Period (EFUP) for Intel Desktop Boards has been determined to be 10 years.	

5.2 Battery Disposal Information



CAUTION

Risk of explosion if the battery is replaced with an incorrect type. Batteries should be recycled where possible. Disposal of used batteries must be in accordance with local environmental regulations.



PRÉCAUTION

Risque d'explosion si la pile usagée est remplacée par une pile de type incorrect. Les piles usagées doivent être recyclées dans la mesure du possible. La mise au rebut des piles usagées doit respecter les réglementations locales en vigueur en matière de protection de l'environnement.



FORHOLDSREGEL

Eksplodingsfare, hvis batteriet erstattes med et batteri af en forkert type. Batterier bør om muligt genbruges. Bortskaffelse af brugte batterier bør foregå i overensstemmelse med gældende miljølovgivning.



OBS!

Det kan oppstå eksplosjonsfare hvis batteriet skiftes ut med feil type. Brukte batterier bør kastes i henhold til gjeldende miljølovgivning.



VIKTIGT!

Risk för explosion om batteriet ersätts med felaktig batterityp. Batterier ska kasseras enligt de lokala miljövårdsbestämmelserna.



VARO

Räjähdyksvaara, jos pariston tyyppi on väärä. Paristot on kierrätettävä, jos se on mahdollista. Käytetyt paristot on hävitettävä paikallisten ympäristömääräysten mukaisesti.



VORSICHT

Bei falschem Einsetzen einer neuen Batterie besteht Explosionsgefahr. Die Batterie darf nur durch denselben oder einen entsprechenden, vom Hersteller empfohlenen Batterietyp ersetzt werden. Entsorgen Sie verbrauchte Batterien den Anweisungen des Herstellers entsprechend.



AVVERTIMENTO

Esiste il pericolo di un esplosione se la pila non viene sostituita in modo corretto. Utilizzare solo pile uguali o di tipo equivalente a quelle consigliate dal produttore. Per disfarsi delle pile usate, seguire le istruzioni del produttore.



PRECAUCIÓN

Existe peligro de explosión si la pila no se cambia de forma adecuada. Utilice solamente pilas iguales o del mismo tipo que las recomendadas por el fabricante del equipo. Para deshacerse de las pilas usadas, siga igualmente las instrucciones del fabricante.



WAARSCHUWING

Er bestaat ontploffingsgevaar als de batterij wordt vervangen door een onjuist type batterij. Batterijen moeten zoveel mogelijk worden gerecycled. Houd u bij het weggooien van gebruikte batterijen aan de plaatselijke milieuwetgeving.



ATENÇÃO

Haverá risco de explosão se a bateria for substituída por um tipo de bateria incorreto. As baterias devem ser recicladas nos locais apropriados. A eliminação de baterias usadas deve ser feita de acordo com as regulamentações ambientais da região.



AŠCIAROŽZNAŚĆ

Існуе рызыка выбуху, калі заменены акумулятар неправільнага тыпу. Акумулятары павінны, па магчымасці, перепрацоўвацца. Пазбаўляцца ад старых акумулятараў патрэбна згодна з мясцовым заканадаўствам па экалогіі.



UPOZORNĚNÍ

V případě výměny baterie za nesprávný druh může dojít k výbuchu. Je-li to možné, baterie by měly být recyklovány. Baterie je třeba zlikvidovat v souladu s místními předpisy o životním prostředí.



Προσοχή

Υπάρχει κίνδυνος για έκρηξη σε περίπτωση που η μπαταρία αντικατασταθεί από μία λανθασμένου τύπου. Οι μπαταρίες θα πρέπει να ανακυκλώνονται όταν κάτι τέτοιο είναι δυνατό. Η απόρριψη των χρησιμοποιημένων μπαταριών πρέπει να γίνεται σύμφωνα με τους κατά τόπο περιβαλλοντικούς κανονισμούς.



VIGYÁZAT

Ha a telepet nem a megfelelő típusú telepre cseréli, az felrobbanhat. A telepeket lehetőség szerint újra kell hasznosítani. A használt telepeket a helyi környezetvédelmi előírásoknak megfelelően kell kiselejtezni.



注意

異なる種類の電池を使用すると、爆発の危険があります。リサイクルが可能な地域であれば、電池をリサイクルしてください。使用後の電池を破棄する際には、地域の環境規制に従ってください。



AWAS

Risiko letupan wujud jika bateri digantikan dengan jenis yang tidak betul. Bateri sepatutnya dikitar semula jika boleh. Pelupusan bateri terpakai mestilah mematuhi peraturan alam sekitar tempatan.



OSTRZEŻENIE

Istnieje niebezpieczeństwo wybuchu w przypadku zastosowania niewłaściwego typu baterii. Zużyte baterie należy w miarę możliwości utylizować zgodnie z odpowiednimi przepisami ochrony środowiska.



PRECAUȚIE

Risc de explozie, dacă bateria este înlocuită cu un tip de baterie necorespunzător. Bateriile trebuie reciclate, dacă este posibil. Depozitarea bateriilor uzate trebuie să respecte reglementările locale privind protecția mediului.



ВНИМАНИЕ

При использовании батареи несоответствующего типа существует риск ее взрыва. Батареи должны быть утилизированы по возможности. Утилизация батарей должна проводиться по правилам, соответствующим местным требованиям.



UPOZORNENIE

Ak batériu vymeníte za nesprávny typ, hrozí nebezpečenstvo jej výbuchu. Batérie by sa mali podľa možnosti vždy recyklovať. Likvidácia použitých batérií sa musí vykonávať v súlade s miestnymi predpismi na ochranu životného prostredia.



POZOR

Zamenjava baterije z baterijo drugačnega tipa lahko povzroči eksplozijo. Če je mogoče, baterije reciklirajte. Rabljene baterije zavrzite v skladu z lokalnimi okoljevarstvenimi predpisi.



คำเตือน

ระวังการระเบิดที่เกิดจากเปลี่ยนแบตเตอรี่ผิดประเภท หากเป็นไปได้ ควรนำแบตเตอรี่ไปรีไซเคิล การทิ้งแบตเตอรี่ใช้แล้วต้องเป็นไปตามกฎข้อบังคับด้านสิ่งแวดล้อมของท้องถิ่น.



UYARI

Yanlış türde pil takıldığında patlama riski vardır. Piller mümkün olduğunda geri dönüştürülmelidir. Kullanılmış piller, yerel çevre yasalarına uygun olarak atılmalıdır.



ОСТОРОГА

Використовуйте батареї правильного типу, інакше існуватиме ризик вибуху. Якщо можливо, використані батареї слід утилізувати. Утилізація використаних батарей має бути виконана згідно місцевих норм, що регулюють охорону довкілля.



UPOZORNĚNÍ

V případě výměny baterie za nesprávný druh může dojít k výbuchu. Je-li to možné, baterie by měly být recyklovány. Baterie je třeba zlikvidovat v souladu s místními předpisy o životním prostředí.



ETTEVAATUST

Kui patarei asendatakse uue ebasobivat tüüpi patareiga, võib tekkida plahvatusoht. Tühjad patareid tuleb võimaluse korral viia vastavasse kogumispunkti. Tühjade patareide äraviskamisel tuleb järgida kohalikke keskkonnakaitse alaseid reegleid.



FIGYELMEZTETÉS

Ha az elemet nem a megfelelő típusúra cseréli, felrobbanhat. Az elemeket lehetőség szerint újra kell hasznosítani. A használt elemeket a helyi környezetvédelmi előírásoknak megfelelően kell kiselejtezni.



UZMANĪBU

Pastāv eksplozijas risks, ja baterijas tiek nomainītas ar nepareiza veida baterijām. Ja iespējams, baterijas vajadzētu nodot attiecīgos pieņemšanas punktus. Bateriju izmešanai atkritumos jānotiek saskaņā ar vietējiem vides aizsardzības noteikumiem.



DĒMESIO

Naudojant netinkamo tipo baterijas įrenginys gali sprogti. Kai tik įmanoma, baterijas reikia naudoti pakartotinai. Panaudotas baterijas išmesti būtina pagal vietinius aplinkos apsaugos nuostatus.



ATTENZJONI

Riskju ta' splużjoni jekk il-batterija tinbidel b'tip ta' batterija mhux korrett. Il-batteriji għandhom jiġu riċiklati fejn hu possibbli. Ir-rimi ta' batteriji użati għandu jsir skond ir-regolamenti ambjentali lokali.



OSTRZEŻENIE

Ryzyko wybuchu w przypadku wymiany na baterie niewłaściwego typu. W miarę możliwości baterie należy poddać recyklingowi. Zużytych baterii należy pozbywać się zgodnie z lokalnie obowiązującymi przepisami w zakresie ochrony środowiska.