

COMPONENT

.com

Additional Technical Manual

System Board D1332, D1331, D1330

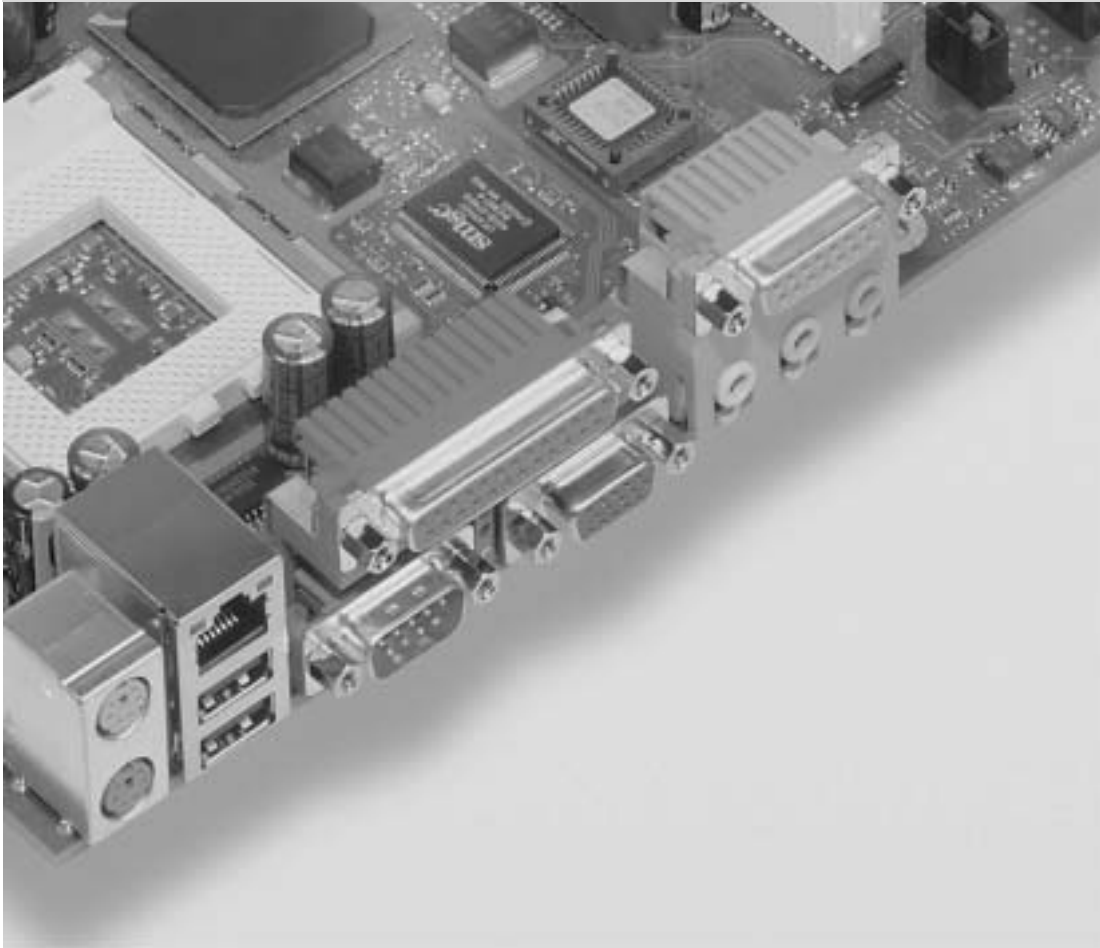

Are there ...

... any technical problems or other questions you need clarified?

Please contact:

- Our Hotline:
 - Mo-Fr: 8 a.m. - 6 p.m.
 - Sat: 9 a.m. - 2 p.m.
 - Tel.: ++49 (0) 180 3777 005
- your sales outlet

The latest information on our products, tips, updates, etc., can be found on the Internet under: <http://www.fujitsu-siemens.com/mainboards>

Dieses Handbuch wurde auf Recycling-Papier gedruckt.
This manual has been printed on recycled paper.
Ce manuel est imprimé sur du papier recyclé.
Este manual ha sido impreso sobre papel reciclado.
Questo manuale è stato stampato su carta da riciclaggio.
Denna handbok är tryckt på recyclingpapper.
Dit handboek werd op recycling-papier gedrukt.

Herausgegeben von/Published by
Fujitsu Siemens Computers GmbH

Bestell-Nr./Order No.: **A26361-D1332-Z180-1-7619**
Printed in the Federal Republic of Germany
AG 0102 01/02



A26361-D1332-Z180-1-7619

**System Board
D1332
D1331
D1330**

Additional Technical Manual

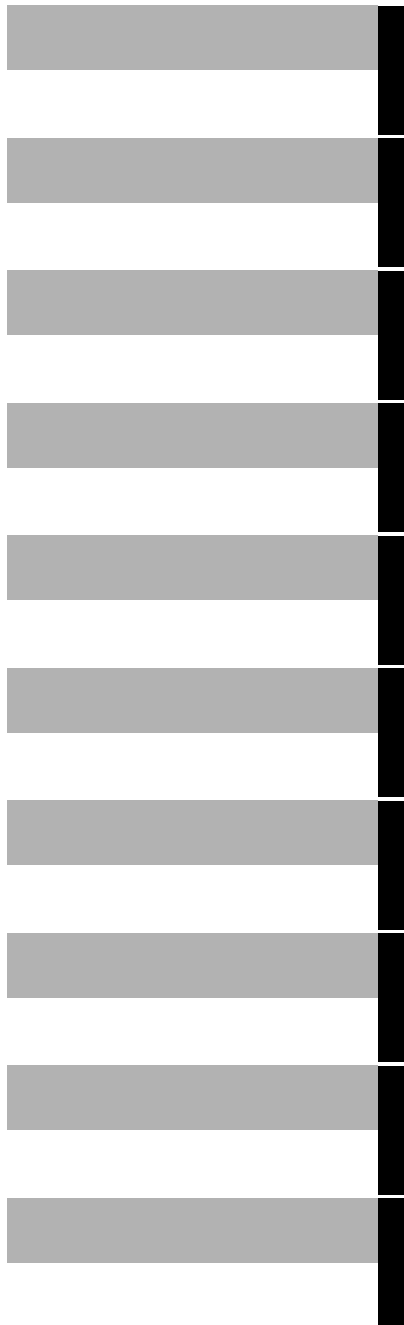

Intel, Pentium and Celeron are registered trademarks of Intel Corporation, USA.

Microsoft, MS, MS-DOS and Windows are registered trademarks of Microsoft Corporation.

PS/2 and OS/2 Warp are registered trademarks of International Business Machines, Inc.

Magic Packet is a registered trademark of Advanced Micro Devices, Inc.

Rambus, RDRAM, and the Rambus Logo are registered trademarks of Rambus Inc. Direct Rambus, RIMM, SO-RIMM, and Direct RDRAM are trademarks of Rambus Inc.

All other trademarks referenced are trademarks or registered trademarks of their respective owners, whose protected rights are acknowledged.

Copyright © Fujitsu Siemens Computers GmbH 2002

All rights, including rights of translation, reproduction by printing, copying or similar methods, even of parts are reserved.

Offenders will be liable for damages.

All rights, including rights created by patent grant or registration of a utility model or design, are reserved. Delivery subject to availability.

Right of technical modification reserved.

Contents

Introduction.....	1
Features	2
Mechanics	3
Connectors.....	5
Power supply monitoring.....	5
Fan 1 connector.....	5
Fan 2 connector.....	5
Front panel connector	6
Intrusion connector for case open detect for optional push-button (opener).....	7
USB port C / D 1 - Dual channel	7
Wake On LAN (WOL) connector	8
CD-ROM audio connector (internal).....	8
Audio front panel (internal).....	8
Auxiliary (MPEG, TV) audio connector (internal).....	9
Configuration	9
Functions controlled by the configuration switch	9
Power	10
Power requirement for onboard components (worst case)	10
Power loadability.....	10
Documentation	10
Installing drivers.....	11
Upgrading main memory.....	11
Troubleshooting.....	11
Message BIOS update.....	11
The screen stays blank.....	11

Introduction



Depending on the configuration chosen, some of the hardware components described may not be available on your system board.

You will find further information e. g. in the complete system board Technical Manual and in the "BIOS Setup" description.

Further information regarding drivers is provided on the supplied drivers diskettes or on the "Drivers & Utilities" or "ServerStart" CD. For detailed information please read the "Installing drivers" chapter. The latest BIOS version and drivers can be found on the internet under

<http://www.fujitsu-siemens.com/en/service>.



Computer system boards and components contain very delicate IC chips. To protect them against damage caused by static electricity, you must follow these precautions:

- Use a grounded wrist strap.
- Unplug your computer before you remove any part of the casing.
- Place the system board and the components on a grounded antistatic pad whenever you remove them from the computer.

Hold components by the edge, do not touch any pins or connectors on them.

Once you have installed the system board, you should remove the battery protection (i.e. the thin plastic plate between battery and contact spring).

Features

The table shows assembly versions of this system board as an example.

Features	D1330-B	D1331-A	D1332-A D1332-D
Chipset	Intel 845D		
Board Size	μ-ATX	μ-ATX	μ-ATX
VGA onboard	-	-	-
Audio onboard (AC '97)	✓	✓	✓
LAN onboard / with Alert-on-LAN	- / -	✓ / -	✓ / ✓
Thermal Management onboard	-	-	✓
System Monitoring onboard	-	-	✓
Fujitsu Siemens Keyboard Power Button Support	-	-	✓
Buzzer onboard / int. Speaker Support	✓ / -	✓ / -	- / ✓

Internal Connectors

DIMM Sockets (DDR)	2	2	2
AGP Slot (1/2/4x, 32 Bit, 66 Mhz, 1.5 V)	1	1	1
PCI Slots (32Bit, 33 MHz, 5 V and 3,3 V)	3	3	D1332-A: 3 D1332-D: 1
ISA Slot	-	-	-
CNR Slot	1	-	-
IDE Interfaces (Ultra DMA/100)	2	2	2
Floppy Interface (up to 1,44 MB)	1	1	-
Floppy Interface (up to 1,44 MB) with SMD	-	-	1
CD / AUX Audio Input	1 / 1	1 / 1	1 / 1
Front Panel Audio Output	1	1	1
Wake-on-LAN	1	1	1
Int. Serial Port / with SmartCard Support	- / -	- / -	- / -
Int. USB Connectors with SmartCard Support	1	1	1
Int. USB Connectors/shared with CNR	2 / 1	2 / -	2 / -

External Connectors

VGA	-	-	-
Audio Mic. / in / out (2 x 0.5 W / 8 Ω)	1 / 1 / 1	1 / 1 / 1	1 / 1 / 1
Game/MIDI	1	1	1
LAN (RJ-45)	-	1	1
PS/2 Mouse/Keyboard	1 / 1	1 / 1	1 / 1
Ext. Serial Port (FIFO, 16550 compatible)	2	2	2
Parallel Port (EPP/ECP)	1	1	1
USB Connectors external	2	2	2

Mechanics

Layout System board D1332 / D1331 / D1330

μ-ATX 9.6" x 9.6" (243.84 mm x 243.84 mm)

Some of the following connectors are optional and may therefore not be included on your system board.

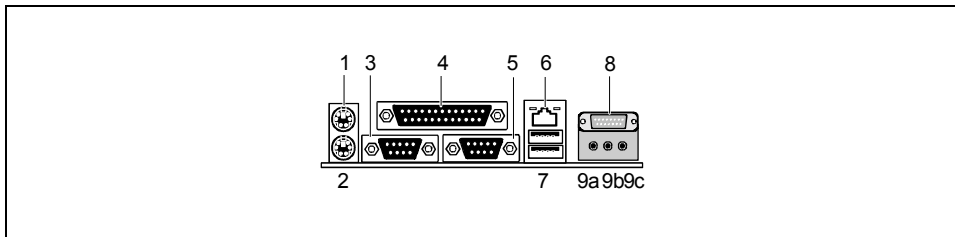

- 1 = PS/2 mouse port
- 2 = PS/2 keyboard port
- 3 = Serial port 1
- 4 = Parallel port
- 5 = Serial port 2
- 6 = LAN port

- 7 = USB ports A and B
- 8 = Game/Midi port
- 9a = Audio Line-Out / Headphones
- 9b = Audio Line-In
- 9c = Audio Micro-In

The components and connectors marked are not necessarily present on the system board.

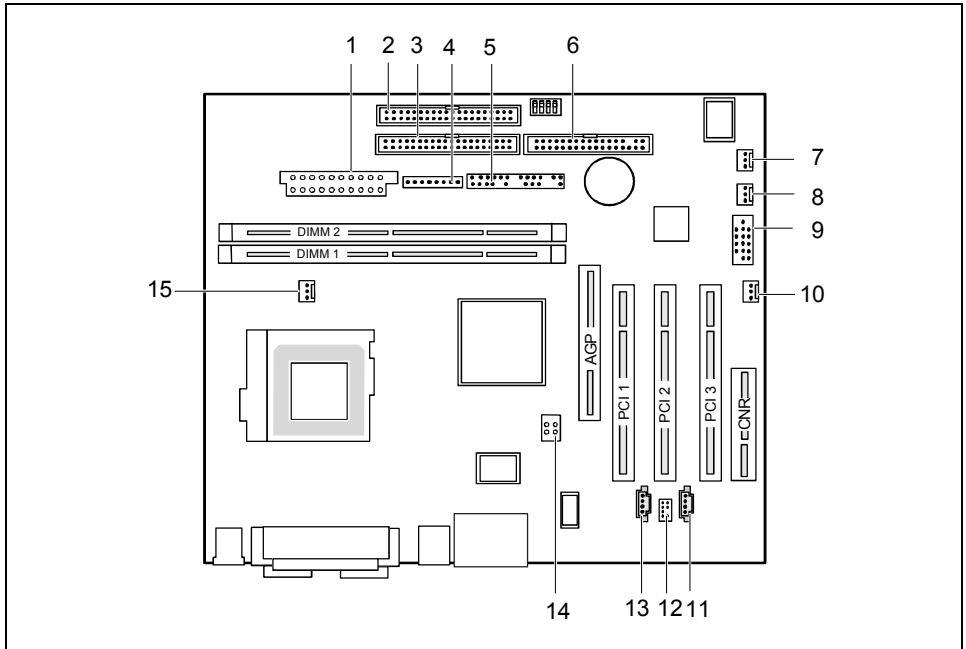

- 1 = Power supply
- 2 = Floppy disk drive
- 3 = IDE drives 3 and 4 (secondary)
- 4 = Power supply monitoring
- 5 = Connector for control panel
- 6 = IDE drives 1 and 2 (primary)
- 7 = Fan 2
- 8 = Intrusion control
- 9 = USB port C / D

- 10 = Wake On LAN
- 11 = CD audio input
- 12 = Audio front panel
- 13 = AUX audio input
- 14 = Power supply +12V
- 15 = Fan 1 (e. g. for the processor)

The components and connectors marked are not necessarily present on the system board.

Connectors



Some of the following connectors are optional!

Power supply monitoring

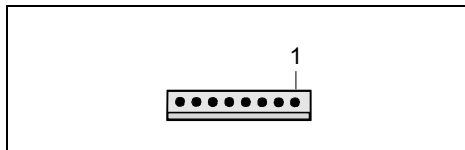

Pin	Signal
1	AC Outlet on(high asserted)
2	PS FAN Control (low asserted)
3	PS FAN full on (low asserted)
4	PS FAN C (max. 3mA)
5	SMB CLK
6	SMB DATA
7	VCC EEPROM (+3,3V)
8	GND

Fan 1 connector

(processor fan - controlled and supervised, only for 3 pin fans)

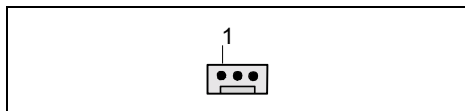

Pin	Signal
1	GND
2	Controlled fan voltage (0 V / 6...12 V)
3	Fan sense

Fan 2 connector

(system fan - supervised)

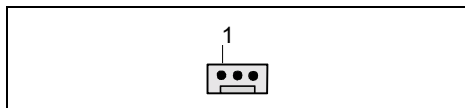

Pin	Signal
1	GND
2	+12 V
3	Fan sense

Front panel connector

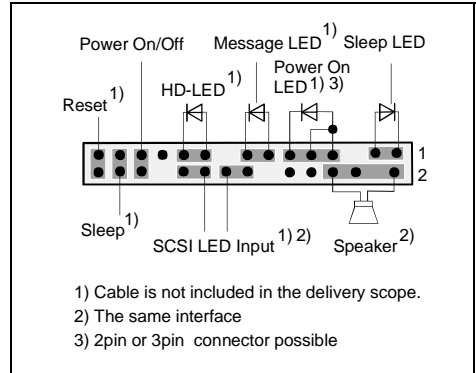

Pin	Signal	Pin	Signal
1	Sleep LED (Cathode)	2	In case of 'Sound via internal system speaker' support: Speaker Negative
3	Sleep LED (Anode)	4	Key
5	Key	6	GND
7	PowerON_LED (Anode)	8	In case of 'Sound via internal system speaker' support: Speaker Positive
9	PowerON_LED (Anode)	10	Key pin
11	'Sleep LED' and 'Power On LED' Cathode (GND)	12	Key pin
13	Message LED (Anode)	14	Key
15	Message LED (Cathode)	16	Not connected
17	Key	18	SCSI LED input (low asserted)
19	HD_LED (Anode)	20	SCSI LED input (low asserted)
21	HD_LED (Cathode)	22	Not connected
23	GND	24	Key
25	Power button (low asserted)	26	GND
27	Sleep Button (low asserted)	28	GND
29	Reset button (low asserted)	30	GND

Intrusion connector for case open detect for optional push-button (opener)

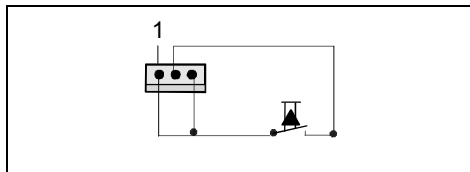

Pin	Signal
1	GND
2	Case open (low asserted)
3	Intrusion switch present (low asserted)

USB port C / D 1 - Dual channel

(internal or external via special wire)

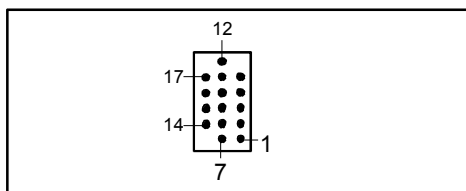

Pin	Signal	Pin	Signal	Pin	Signal
1	VCC Dual / VCC (fused max. 500mA and power supervision with over current detection)	7	Shield GND	13	Key
2	Data negative (port C)	8	GND	14	GND
3	Data positive (port C)	9	Data positive (port D)	15	Data positive (port C)
4	GND	10	Data negative (port D)	16	Data negative (port C)
5	Shield GND	11	VCC Dual / VCC (fused max. 500mA and power supervision with over current detection)	17	VCC Dual (fused max. 500mA and power supervision with over current detection)
6	Key	12	Power supply on (CCR on) (max. 1 second low pulse)	18	Key

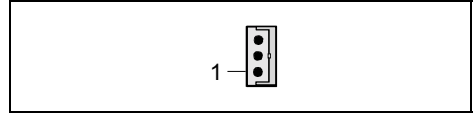
Wake On LAN (WOL) connector

Pin	Signal
1	VCC Auxiliary
2	GND
3	Wake pulse (high asserted)

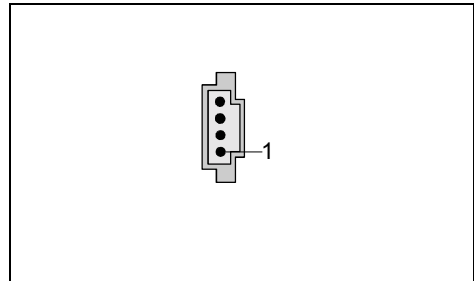
CD-ROM audio connector (internal)

Pin	Signal
1	Left CD audio input
2	CD GND
3	CD GND
4	Right CD audio input

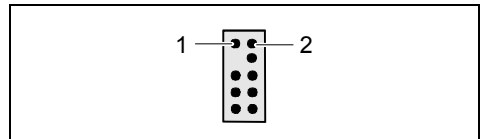
Audio front panel (internal)

Pin	Signal	Pin	Signal
1	Analog GND	2	Micro Input
3	Key	4	12 V
5	Analog GND	6	Analog GND
7	Analog GND	8	Analog GND
9	Left line output*	10	Right Line Output*

* as stuffing option this can be configured as Headphone Out, but the rear out will in this case be a Line Out only otherwise the rear out is a Headphone Out.

Auxiliary (MPEG, TV) audio connector (internal)

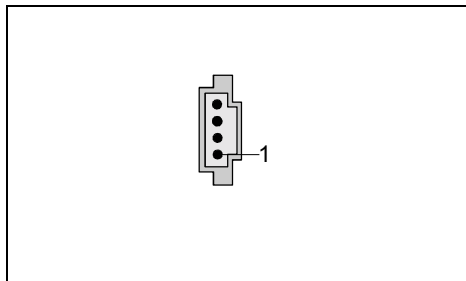

//Pin	Signal
1	Left AUX audio input
2	Analog GND
3	Analog GND
4	Right AUX audio input

Configuration

Functions controlled by the configuration switch

Switch	Function	SKP	RCV	N.U.	LAUX
1	Password skip	on			
1	Off	off			
2	Recovery BIOS		on		
2	Off		off		
3	Not used				
3	Not used				
4	Low auxiliary power supply (<2 A)				on
4	High auxiliary power supply				off

PSS must be switched on for systems with not enough 5 V auxiliary power for all its self powered wake devices (Wake On LAN, USB, PCI) in S3-S4.

Power

Power requirement for onboard components (worst case)

Source	Voltage	Maximum variation	Maximum current	Comment
Main power supply	+12 V	±5 %		
Main power supply	-12 V	±10 %		
Main power supply	+5.0 V	±5 %		
Main power supply	+3.3 V	±5 %		
Auxiliary power supply	+5.0 V	±5 %		

Power loadability

Fuse number	Maximum fuse current	Function	Maximum function current
1	750 mA	Keyboard port	Not specified
		Mouse port	Not specified
		Game port	Not specified
		VGA connector	Minimum 50 mA
2	500 mA	Universal serial bus (USB) Port A	500 mA
3	500 mA	Universal serial bus (USB) Port B	500 mA
4	1250 mA	Universal serial bus (USB) Port C	500 mA
		Universal serial bus (USB) Port D	500 mA

Documentation

- ▶ Insert the "Drivers & Utilities" CD.
- ▶ If the CD does not start automatically, run the *START.EXE* file in the main directory of the CD.
- ▶ Select your system board or your device.
- ▶ Select *Documentation*.
- ▶ Select - *Technical Manuals*
- ▶ Select - *Technical Manuals (BIOS)*



You may have to install the Acrobat Reader - Software on the CD-ROM (path: utls/acrobat) before reading!

For more details please read the according readme.txt files.

Installing drivers

- ▶ Insert the "Drivers & Utilities" CD.
- ▶ If the CD doesn't start automatically call the *START.EXE* file in the main directory of the CD.
- ▶ If the system board list is displayed select the system board or select under *Driver* the operating system used and the audio and video drivers.

Upgrading main memory

Support:	The system needs at least one module.
Size:	From 64 Mbytes up to 2 Gbytes DDR SDRAM
Technology:	PC2100 unbuffered DDR-DIMM modules. 184 pin, 2,5 V, 64 bit, no ECC support 184 pin, 2,5 V, 72 bit, ECC-support
Granularity:	For one socket 64, 128, 256, 512 or 1024 MB

Troubleshooting

Message BIOS update

The System BIOS provides optimum support for the processor you have chosen. If the message `BIOS update for installed CPU failed` appears the microcode required for the processor inserted must still be loaded. Further information on this is available in the "BIOS Setup" manual on the "Drivers & Utilities" CD provided.

The screen stays blank

If your screen stays blank this may have the following cause:

The wrong RAM memory module has been inserted

- ▶ See the chapter "Main Memory" for information which memory modules can be used.

ACPI S3 (Save-to-RAM) and/or ACPI S4 (Save-to-Disk) doesn't work

This system board is fully compliant for ACPI S3 and S4. Therefore it is PC99 certified by Microsoft.

If you have any problems with ACPI please ensure that all of your components are supporting ACPI S3 and S4.

- Operating system
- Hardware and drivers of controllers (e. g. VGA, audio, LAN, SCSI controllers).

For further information please refer to <http://developer.intel.com/technology/iapc/involve.htm>.