

# COLORFUL<sup>®</sup>

COLORFIRE B760M-MEOW WIFI D5 橘影橙

## 主板使用手册

版本：V1.0

[www.colorful.cn](http://www.colorful.cn)

## 2022 年 11 月 第一版

### 版权说明

本手册版权属于七彩虹公司所有，未经本公司书面许可，任何人不得对此说明书和其中所包含的任何资料进行复制、修改、翻译或出版。

### 免责声明

- 1.本手册上所有图片仅供参考，请以实物为准。产品信息会依不同国家及地区而有所变动，我们诚挚的建议您与当地的经销商或零售商确认目前销售产品的规格。
- 2.产品颜色可能会因拍照角度而与实际产品有所差异。我们会尽力提供正确与完整的数据到网页上，并保留随时更正、修改页面信息的权利，恕不另行通知。
- 3.为保证用户的安全及合法权益，请按照本使用手册操作。如不遵照本手册规范操作，对此所造成的后果我们不承担任何形式的责任。
- 4.以上所有产品涉及的其它名称及商标，我们公司拥有最终解释权。

### 商标版权

本手册使用的所有商标均属于该商标的持有者所有。

AMD, Athlon™, Athlon™ XP, Thoroughbred™ 和 Duron™是 Advanced Micro Devices 的注册商标。

Intel® 和 Pentium® 是 Intel Corporation 的注册商标。

PS/2 和 OS® 2 是 International Business Machines Corporation 的注册商标。

Windows® 95/98/2000/NT/XP/Vista 是 Microsoft Corporation 的注册商标。

Netware® 是 Novell, Inc 的注册商标。

Award® 是 Phoenix Technologies Ltd 的注册商标。

AMI® 是 American Megatrends Inc 的注册商标。

Kensington 和 MicroSaver 是 Kensington Technology Group 的注册商标。

PCMCIA 和 CardBus 是 Personal Computer Memory Card International Association 的注册商标。

其他在本说明书中使用的产品名称是他们各自所属公司所拥有和被公认的。

### 技术支持

如果您的系统出现问题，并且无法从本主板使用手册中获得帮助，请联系您所购买主板的经销商。此外您还可以尝试通过以下方式获得帮助：访问七彩虹的官方网站 (<http://www.colorful.cn>)，点击服务与支持模块，即可获取七彩虹提供的各种服务、保修条例与下载支持。

# 七彩虹产品质量保证卡

三年免费质保 全国联保

## 尊敬的客户：

感谢您选用七彩虹系列产品，为了确保您能够充分享有我们提供的售后服务，请在购买后认真阅读此说明并妥善保存此质量保证卡。

## 售后内容说明：

- 一、此质量保证卡的资料必须填写完整，并由最终直接经销商盖章，方可生效。
- 二、在正常情况下，七彩虹公司按照国家质量监督检验的有关责任规定，我们承诺自消费者购买七彩虹主板之日起，享有主板系列产品三年免费质量保证和全国联保服务。
- 三、若经本公司判定属下列因素，则不属于免费保修服务范围，本公司有权收取维修费用：
  - 1、超过七彩虹提供的质保有效期的产品；
  - 2、产品质保标贴或序列号贴纸被撕去、损毁或模糊不清的产品；
  - 3、未按产品说明的要求使用、维护、保管而造成的损坏；
  - 4、未经本公司授权，私自拆装、修理或试图修理过的产品，表现为：产品元件、插接件缺少或损坏、线路板严重变形、线路板断裂、线路划伤、主板腐蚀、生锈及污迹严重等；
  - 5、无有效三包凭证或擅自涂改三包凭证；
  - 6、三包凭证上的产品型号、产品序号与产品实物不相符；
  - 7、因意外事故、不可抗拒的自然因素或错误使用产品所造成的产品损坏，表现为：产品表面刮伤、电子元器件丢失、PCB板变形、有碰撞伤痕等；
  - 8、因用户运输、保管不当而导致损坏的产品，如：受潮腐蚀、机械损伤等。
- 四、获取更多售后服务详情，请访问七彩虹官方网站 (<http://www.colorful.cn>) 查阅售后服务相关内容。

## 用户资料填写

用户名称		购买日期	
联系人		联系电话	
联系地址			
产品型号		产品序号	
经销商名称		经销商电话	
经销商地址			
经销商印章		七彩虹印章	

技术服务热线：400-678-5866

COLORFUL®

通过拨打 400-678-5866 客户服务热线进行咨询，此外还可以直接与七彩虹各属地平台服务中心联系，具体联系方式如下：

七彩虹经销商服务范围及联系方式		
平台名称	服务范围	联系方式
北部大区	黑龙江省、吉林省、辽宁省、北京市、天津市、河北省、山东省、山西省、河南省、内蒙古自治区	010-82488344
中部大区	江苏省、浙江省、安徽省、上海市、湖北省、湖南省、江西省	027-87873911（武汉区域） 025-86817950（华东区域）
南部大区	广东省、广西壮族自治区、福建省、海南省	020-38335851
西南大区	四川省、重庆市、云南省、西藏自治区、贵州省	028-85579371
西北大区	陕西省、甘肃省、青海省、新疆维吾尔自治区、宁夏回族自治区	029-87877278
注意：以上电话如有变动，请拨打 400-678-5866 服务热线查询。		

\*七彩虹公司对本手册拥有最终解释权





根据电子电器产品有害物质使用标识要求：图中数字为产品的环保使用期限。指电子产品中含有的有害物质在不发生外泄或突变的条件下，不会对环境造成污染或人身、财产造成损害的期限。

产品中有害物质的名称及含量：

部件名称	有害物质					
	铅(Pb)	汞(Hg)	镉(Cd)	六价铬 (Cr(VI))	多溴联 苯(PBB)	多溴二 苯醚 (PBDE)
印刷电路板及其 电子组件	×	○	○	○	○	○
外部信号连接口 及线材	×	○	○	○	○	○

本表格依据 SJ/T 11364 的规定编制。

○：表示该有毒有害物质在该部件所有均质材料中的含量均在 GB/T 26572 标准规定的限量要求以下。

×：表示该有毒有害物质至少在该部件的某一均质材料中的含量超出 GB/T 26572 标准规定的限量要求，但该部件仍符合欧盟 RoHS 要求。

备注：此产品所标示的环保使用期限，系指产品在一般使用状况下。

# 目 录

产品包装 .....	1
硬件安装 .....	1
驱动程序安装说明 .....	1
产品规格表 .....	2
I/O 接口介绍 .....	5
主板布局图 .....	6
中央处理器插槽 .....	8
供电接口 .....	9
内存插槽 .....	10
PCIe 扩展插槽 .....	11
M.2 插槽 .....	12
SATA 6Gb/s 接口 .....	13
前置 USB 3.2 Gen 1 插针 .....	13
前置 USB 3.2 Gen 1 Type-C 插槽 .....	14
前置 USB 2.0 插针 .....	14
CPU 风扇插针 .....	15
系统风扇插针 .....	15
水冷泵插针 .....	16
5V ARGB 插针 .....	16
前置音频插针 .....	17
12V RGB 插针 .....	17
喇叭插针 .....	18
前置面板插针 .....	18
串口插针 .....	19
清除 CMOS 跳线 .....	19

BIOS 烧录器插针.....	20
诊断卡插针.....	20
ME 写保护跳线.....	21
RGB 灯效控制跳线.....	21
LED 侦错灯.....	22
<b>BIOS 介绍.....</b>	<b>23</b>
BIOS 设置程序.....	23
进入 BIOS.....	23
BIOS 设置程序主界面.....	23
BIOS 程序更新.....	24

## 产品包装

在您打开本主板包装盒之后，请检查下面所列出的各项标准配件是否齐全。

主板	1×COLORFIRE B760M-MEOW WIFI D5 橘影橙 主板
连接线	2×SATA 6Gb/s 数据线
其他配件	2×WiFi 6 高增益天线 1×前面板辅助插针/连接头 1×USB 2.0 辅助插针/连接头
使用手册	1×主板使用手册



- 以上配件仅供参考，请以实物为准，七彩虹科技保留变更的权利。
- 若以上列出的任何一项配件有损坏，请尽快与您的经销商联络或致电七彩虹客服。

## 硬件安装

当您取出主板后，可以扫描右侧二维码，获取七彩虹官方的硬件安装快速操作指南，从而快速安装您的个人电脑。



## 驱动程序安装说明

您可以访问七彩虹官网(<http://www.colorful.cn>)，搜索该产品型号，在技术支持列表里面找到相应的驱动进行下载。板载网卡驱动亦可扫描右侧二维码进行下载。



## 产品规格表

芯片组	Intel® B760 芯片组
中央处理器	支持适配主板 LGA 1700 插槽的第 13 代和第 12 代 Intel® 酷睿™、奔腾®以及赛扬®处理器 *请访问七彩虹官网 <a href="http://www.colorful.cn">www.colorful.cn</a> 查询最新的处理器支持列表
内存	4 条 DDR5 内存插槽，可支持高达 192 GB 容量内存 (单一插槽最高支持 48 GB 容量) ●支持 DDR5-7200(OC)/7000(OC)/6800(OC)/6600(OC)/6400(OC)/6200(OC)/6000(OC)/5800(OC)/5600(OC)/5400(OC)/5200(OC)/5000(OC)/4800MHz 内存 ●支持 Intel® Extreme Memory Profile (XMP)内存技术 ●支持双通道内存技术 *请访问七彩虹官网 <a href="http://www.colorful.cn">www.colorful.cn</a> 查询最新的内存兼容性列表
扩展插槽	1 个 PCIe 5.0 x16 插槽 1 个 PCIe 3.0 x4 插槽
存储设备接口	共支持 3 个 M.2 插槽和 4 个 SATA 6Gb/s 硬盘接口 ●M.2_1 插槽：支持 2242/2280 规格 M.2 SSD (PCIe 4.0 x4, CPU 通道) ●M.2_2 插槽：支持 2242/2260/2280 规格 M.2 SSD (PCIe 4.0 x4, PCH 通道) ●M.2_3 插槽：支持 2242/2260/2280 规格 M.2 SSD (PCIe 4.0 x4, PCH 通道)
RAID	支持用 SATA 硬盘设备创建 RAID 0, RAID 1, RAID 5, RAID 10 磁盘阵列 *RAID 磁盘阵列的创建步骤详见七彩虹官方的 BIOS 用户指南

<p><b>音频</b></p>	<p>Realtek ALC897 高保真解码芯片</p> <ul style="list-style-type: none"> <li>●最高支持 5.1 声道</li> </ul>
<p><b>网络功能</b></p>	<p>RTL8125BG 2.5G 网卡</p>
<p><b>无线网卡和蓝牙</b></p>	<p>WiFi 6 模块</p> <ul style="list-style-type: none"> <li>●WiFi 6 (支持 802.11 a/b/g/n/ac/ax, 支持 2.4/5GHz 无线频段)</li> <li>●蓝牙 5.2</li> </ul>
<p><b>后置 I/O 接口</b></p>	<p>4 个 USB 2.0 接口                  2 个 USB 3.2 Gen 1 Type-A 接口                  1 个 USB 3.2 Gen 2 Type-C 接口                  1 个 DP 1.2 接口, 最高支持 4K 60Hz 的分辨率                  1 个 HDMI 2.0 接口, 最高支持 4K 60Hz 的分辨率                  1 个 2.5G 网络接口                  2 个 WiFi 6 天线接口                  3 个音频接口 (音频输入/音频输出/麦克风)                  1 个 BIOS 更新按键</p>
<p><b>前置 USB 扩展接口</b></p>	<p>1 个 USB 2.0 插针可扩展 2 个 USB 2.0 Type-A 接口 (FUSB2.0_1)                  1 个 USB 3.2 Gen 1 插针可扩展 2 个 USB 3.2 Gen 1 Type-A 接口 (FUSB3.0)                  1 个 USB 3.2 Gen 1 Type-C 插槽可扩展 1 个 USB 3.2 Gen 1 Type-C 接口 (F_USBC)</p>

<b>板载插针/跳线/按键</b>	1 个 CPU 风扇插针 (CPU_FAN) 3 个系统风扇插针 (CHA_FAN1、CHA_FAN2、CHA_FAN3) 1 个水冷泵插针 (AIO_PUMP) 2 个 5V 3-pin ARGB 插针 (5V_ARGB_1、5V_ARGB_2) 2 个 12V 4-pin RGB 插针 (12V_RGB_1、12V_RGB_2) 1 个前置音频插针 (F_AUDIO) 1 个前置面板插针 (FPANEL) 1 个喇叭插针 (SPEAK) 1 个清除 CMOS 跳线 (CLR_CMOS) 1 个串口插针 (COM) 1 个 BIOS 烧录器插针 (JBIOS) 1 个诊断卡插针 (ESPI_HEADER) 1 个 ME 写保护跳线 (JME) 1 个 RGB 灯效控制跳线 (RGB_LED_EN)
<b>主板尺寸</b>	M-ATX 板型 245mm x 245mm



- 主板规格以产品发布时为准，如有任何更改，请访问七彩虹官网查询最新规格。

## I/O 接口介绍

### COLORFIRE B760M-MEOW WIFI D5 橘影橙

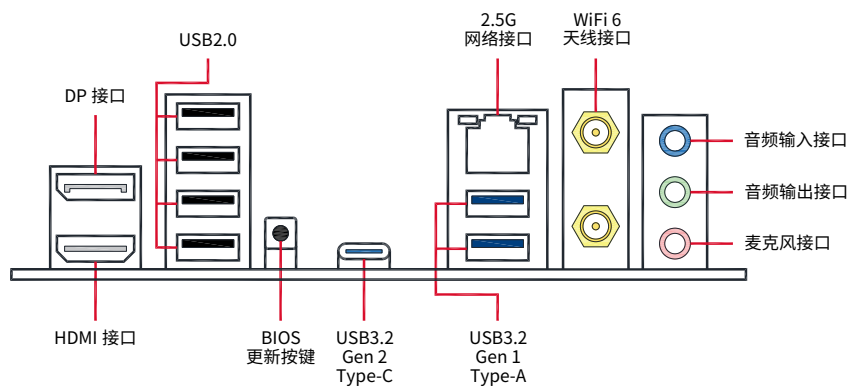



# 主板布局图

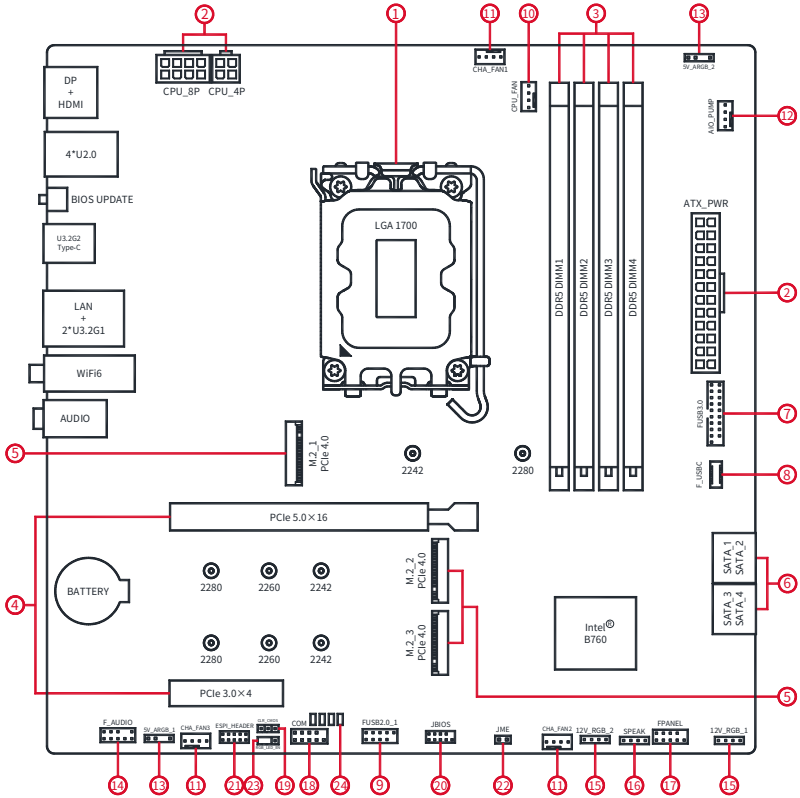

主板布局图介绍：	
① 中央处理器插槽	② 电源接口
③ 内存插槽	④ PCIe 扩展插槽
⑤ M.2 插槽	⑥ SATA 6Gb/s 接口
⑦ 前置 USB 3.2 Gen 1 插针	⑧ 前置 USB 3.2 Gen 1 Type-C 插槽
⑨ 前置 USB 2.0 插针	⑩ CPU 风扇插针
⑪ 系统风扇插针	⑫ 水冷泵插针
⑬ 5V ARGB 插针	⑭ 前置音频插针
⑮ 12V RGB 插针	⑯ 喇叭插针
⑰ 前置面板插针	⑱ 串口插针
⑲ 清除 CMOS 跳线	⑳ BIOS 烧录器插针
㉑ 诊断卡插针	㉒ ME 写保护跳线
㉓ RGB 灯效控制跳线	㉔ LED 侦错灯

## 中央处理器插槽

本主板具有 1 个 LGA 1700 处理器插槽，搭配 B760 芯片组，支持第 13 代和第 12 代 Intel®酷睿™、奔腾®以及赛扬®处理器。

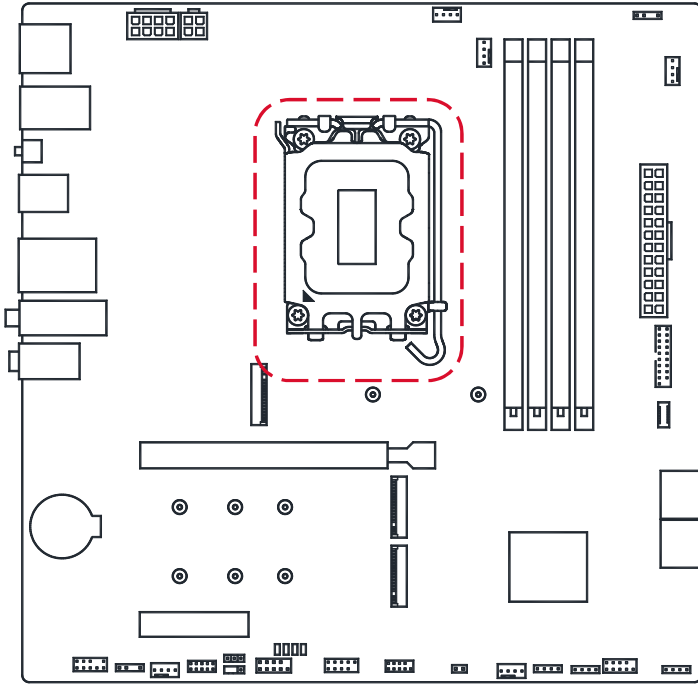

- 本插槽仅支持适配 LGA 1700 插槽的处理器，且需要按照正确的方向安装处理器，请勿使用错误的方式将处理器安装至插槽内，以避免 CPU 插槽内针脚损坏。
- 安装或移除 CPU 之前，请确认电源已关闭，所有电源接口已拔除。
- CPU 在使用时发热量较大，过高的温度会损坏 CPU，请务必搭配使用散热器和散热硅脂以保证 CPU 散热良好。
- 若因为错误的安装导致 CPU 或主板被损坏，七彩虹不提供任何的保修服务。

## 供电接口

本主板提供 1 个 24-pin 主板供电接口和 1 个 8-pin+4-pin CPU 供电接口。主板供电接口与电源的连接插头有防呆设计，只有按照特定的方向才能成功连接。找到正确的方向后，将连接插头插进接口中，检查无松动即可。

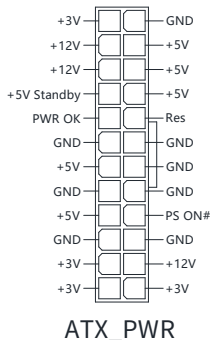
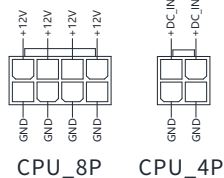
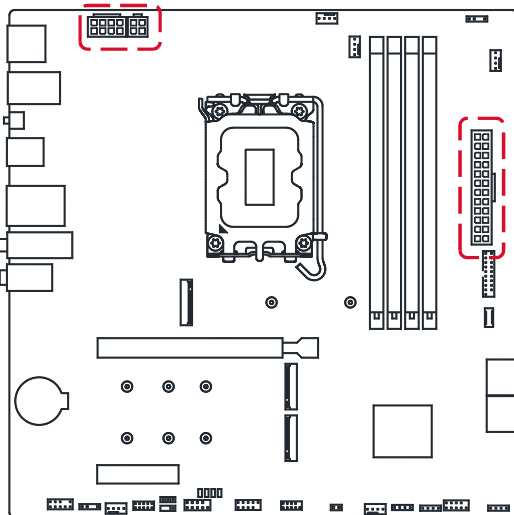

- 如果要安装功率较高的硬件设备，请务必使用输出功率较高的电源以满足的设备用电需求。若电源输出功率较低，可能会导致计算机不稳定或无法开启。

## 内存插槽

本主板提供 4 条 DDR5 内存插槽，可支持高达 192 GB 容量内存 (单一插槽最高支持 48 GB 容量)。

- 支持 DDR5-7200(OC)/7000(OC)/6800(OC)/6600(OC)/6400(OC)/6200(OC)/6000(OC)/5800(OC)/5600(OC)/5400(OC)/5200(OC)/5000(OC)/4800MHz 内存。
- 支持双通道内存及支持 Intel® Extreme Memory Profile (XMP)内存技术。
- 主板内存频率上限由 CPU 内存控制器性能及内存本身的颗粒特性共同决定，请访问七彩虹官网 (<http://www.colorful.cn>) 查询最新的内存兼容性列表。

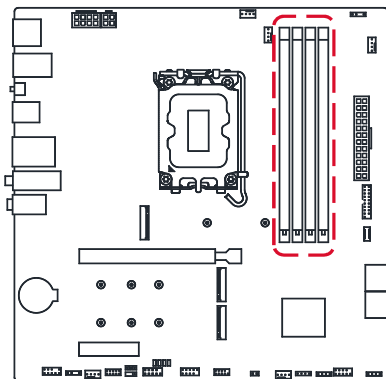

### 内存安装建议

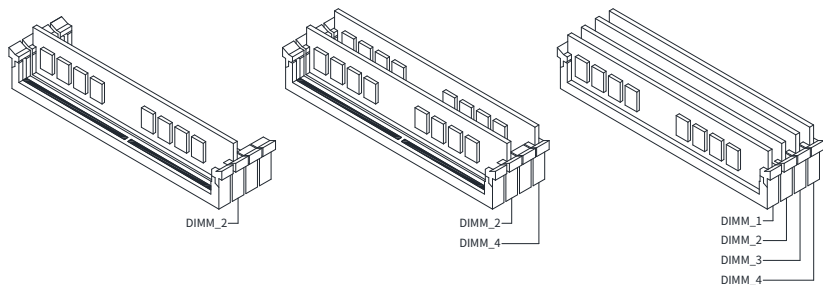

- 内存的默认运行频率是根据其 SPD 决定的，超频运行时某些内存的频率可能会低于厂商的宣传值。
- 为顺利启用双通道内存并确保运行的稳定性，建议安装同一生产商，相同容量、速度和颗粒的内存条，以达到最佳兼容性和最优性能。

## PCIe 扩展插槽

本主板提供 1 个 PCIe 5.0 x16 插槽和 1 个 PCIe 3.0 x4 插槽，可用于安装独立显卡、网卡等扩展卡。如需安装较重的显卡，请使用显卡支架，以防止 PCIe 插槽变形。

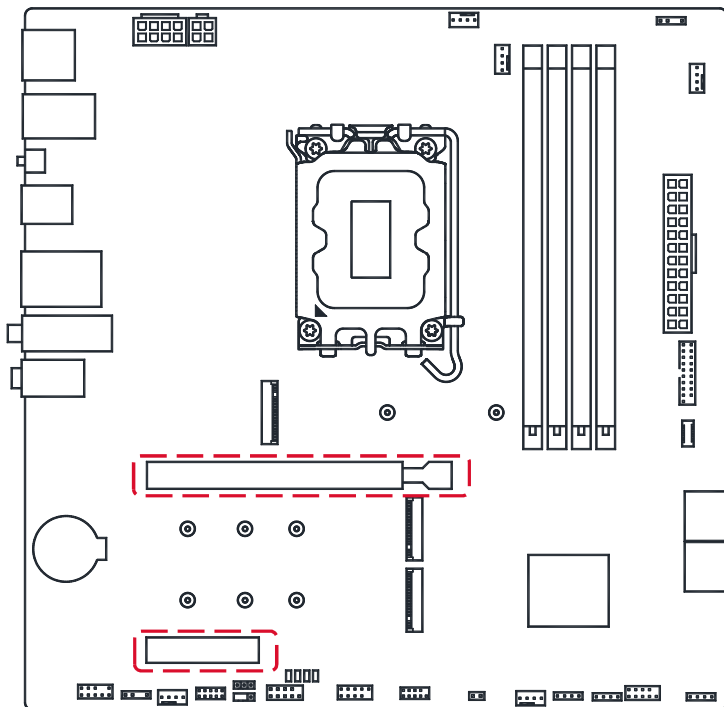

- 安装或卸除扩展卡之前，请先关机并拔出电源线，这样可以避免发生触电等意外状况。

## M.2 插槽

本主板提供 3 个 M.2 插槽，可用于安装 M.2 SSD 模块。

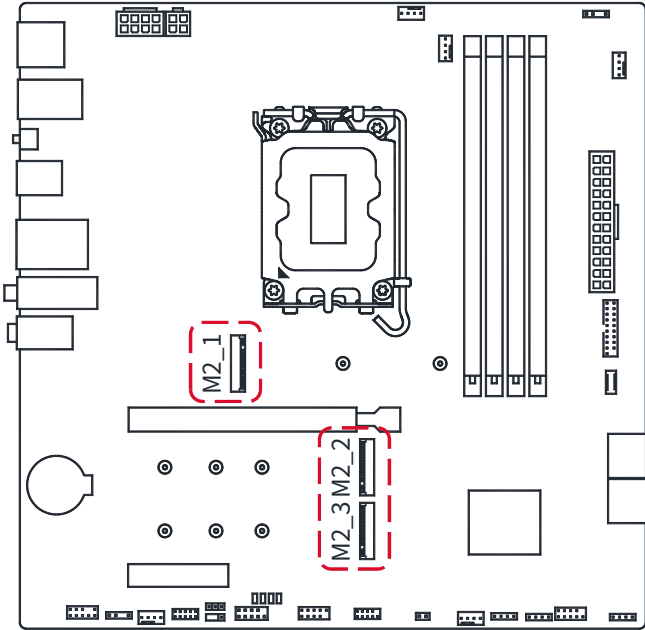

M.2 插槽规格	
M2_1	支持 2242/2280 PCIe 4.0 x4 SSD
M2_2/M2_3	支持 2242/2260/2280 PCIe 4.0 x4 SSD

## SATA 6Gb/s 接口

本主板提供 4 个 SATA 6Gb/s 接口，支持连接 SATA 6Gb/s 硬盘。

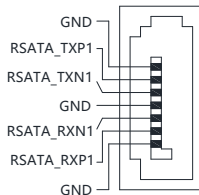
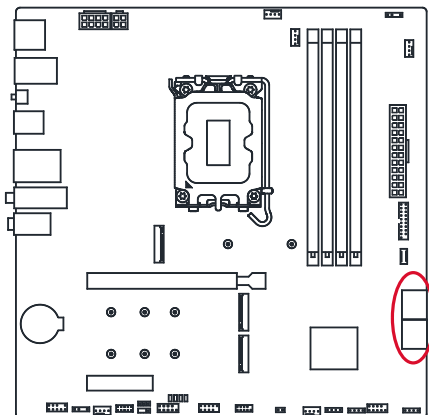

## 前置 USB 3.2 Gen 1 插针

本主板提供 1 个前置 USB 3.2 Gen 1 扩展插针，可扩展为 2 个 USB 3.2 Gen 1 Type-A 接口，可向下兼容 USB 2.0 设备。

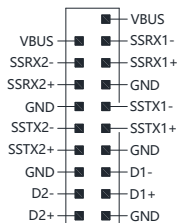
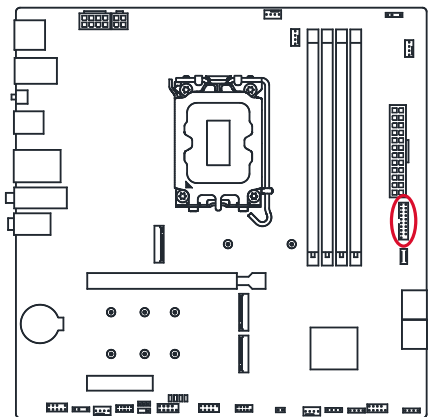



## 前置 USB 3.2 Gen 1 Type-C 插槽

本主板提供 1 个前置 USB 3.2 Gen 1 Type-C 插槽，可扩展为 1 个 USB 3.2 Gen 1 Type-C 接口。

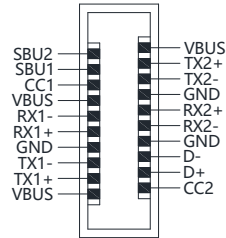
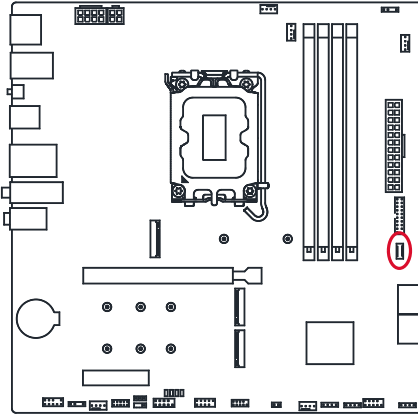

## 前置 USB 2.0 插针

本主板提供 1 个前置 USB 2.0 扩展插针，可扩展为 2 个 USB 2.0 接口。

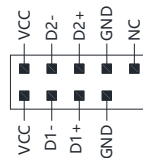
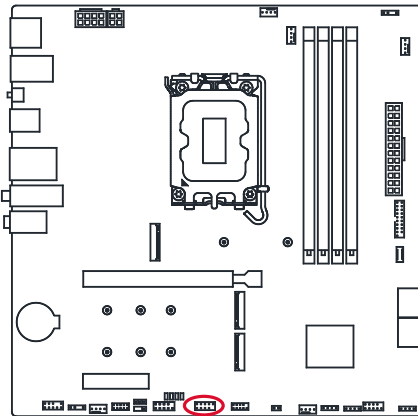

## CPU 风扇插针

本主板提供 1 个 4-pin CPU 风扇插针，插座具有防呆设计，安装时需要注意方向。搭配具有转速控制功能的散热风扇可以降低 CPU 的温度以实现散热功能。

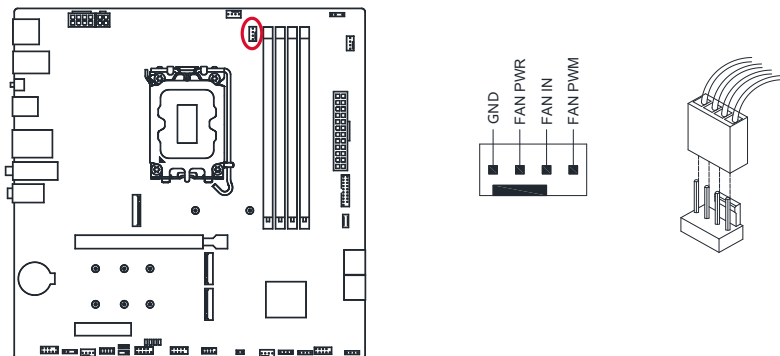

## 系统风扇插针

本主板共提供 3 个 4-pin 系统风扇插针，插座具有防呆设计，安装时需要注意方向。CHA\_FAN1 支持独立控制，CHA\_FAN2 和 CHA\_FAN3 共享控制，单个风扇连接到 CHA\_FAN3 时风扇不能被主板侦测到。搭配具有转速控制功能的散热风扇可以降低机箱的温度以实现散热功能。

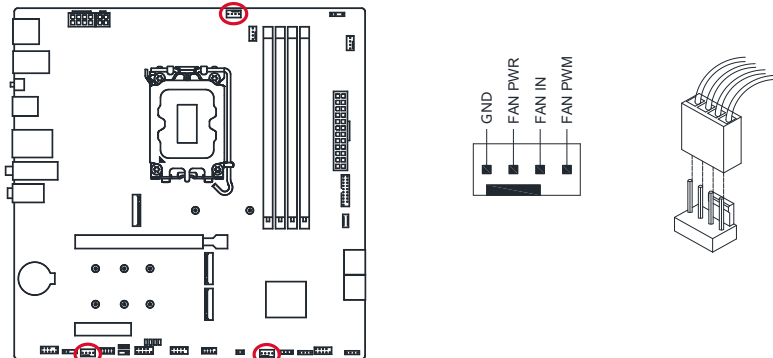

## 水冷泵插针

本主板提供 1 个 4-pin 水冷泵插针，插座具有防呆设计，安装时需要注意方向。此插针用于连接一体式水冷 CPU 散热器水泵电源接头。

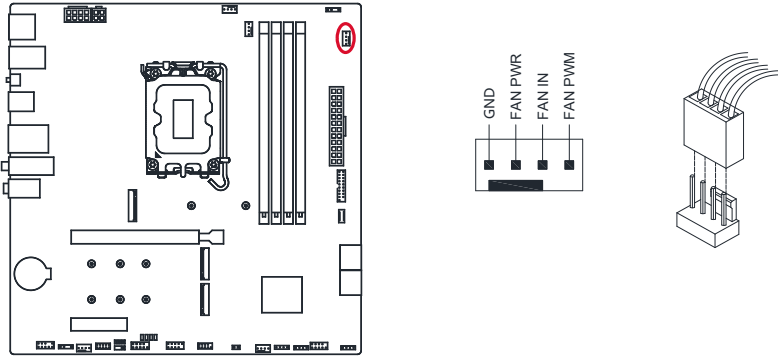

## 5V ARGB 插针

本主板提供 2 个 5V 3-pin ARGB 插针，此插针用于连接 5V ARGB 设备。

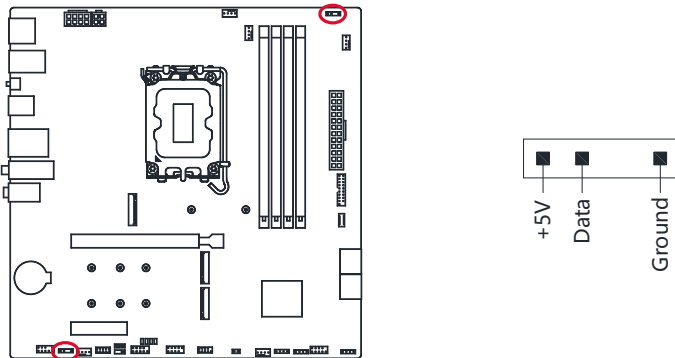

- 本主板支持灯效控制，请访问七彩虹官网 (<https://www.colorful.cn>) 下载 iGame Center 灯光控制软件，调节灯效模式。
- ARGB 风扇为选购设备，如需使用请另行购买。

## 前置音频插针

机箱前面板的音频接口可通过机箱内的音频线连接到前置音频插针上，让您可以通过前面板的音频接口来实现音频输入/输出等功能。

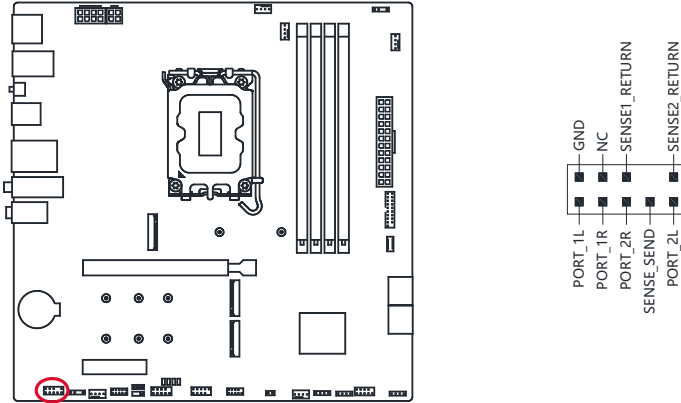

## 12V RGB 插针

本主板提供 2 个 12V 4-pin RGB 插针，此插针用于连接 12V RGB 设备。

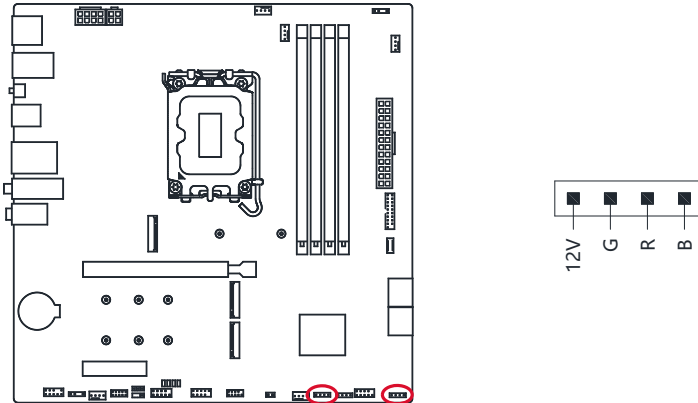

- 本主板支持灯效控制，请访问七彩虹官网 (<https://www.colorful.cn>) 下载 iGame Center 灯光控制软件，调节灯效模式。
- RGB 风扇为选购设备，如需使用请另行购买。

## 喇叭插针

本主板提供 1 个喇叭插针，喇叭插针可以用来连接位于机箱上的喇叭。

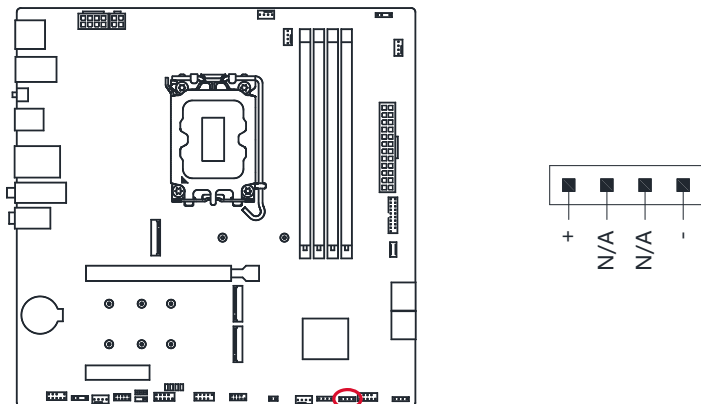

## 前置面板插针

PWR\_Switch：电源开关。短接此针脚可以开机。

Reset\_Switch：重启开关。短接此针脚，不需要关闭系统电源即可重新启动计算机。

PWR\_LED：电源指示灯。当系统电源开启时，此灯会亮起。

HD\_LED：硬盘指示灯。对硬盘进行数据存取时，此灯会亮起。

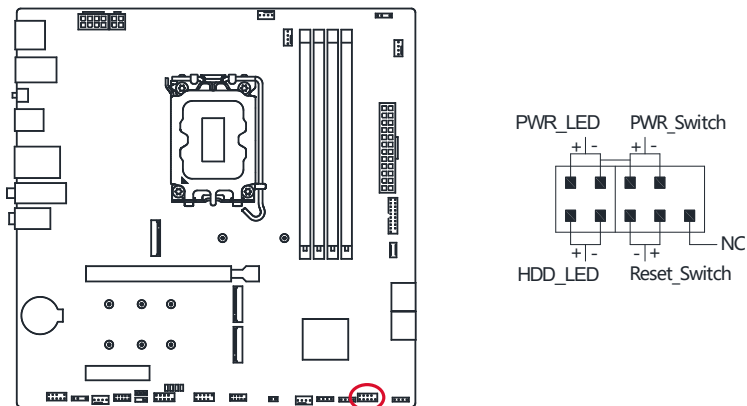

## 串口插针

串口插针可以用来连接串口模块。先将串口模块的数据线接到串口插针上，再将模块固定在机箱后侧面板空的槽位中即可连接串口设备。

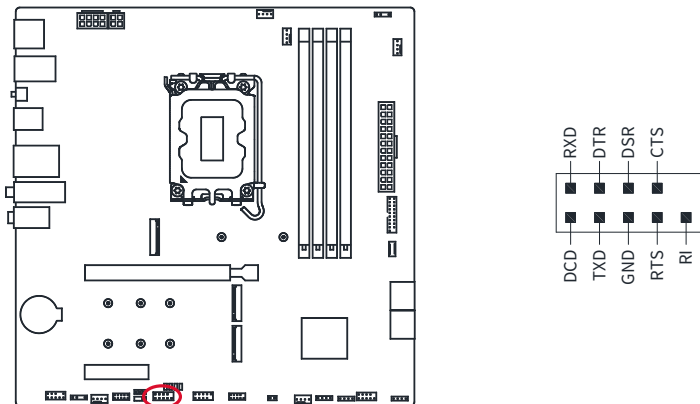

## 清除 CMOS 跳线

清除 CMOS 跳线可以用来清除主板 CMOS 存储器内的数据。CMOS 存储器中储存着 BIOS 的设置参数，由主板上的电池独立供电。跳线帽默认插在针脚①和针脚②上，此时 CMOS 的数据不会被清除。若需要清除 CMOS 的数据，首先需要关闭电脑并拔掉电源线，将跳线帽拔出并插入针脚②和针脚③上，使两个针脚短接 5 秒钟，然后将跳线帽拔出，等待 5 分钟后再启动电脑，即可进入 BIOS 重新设置 BIOS 参数。

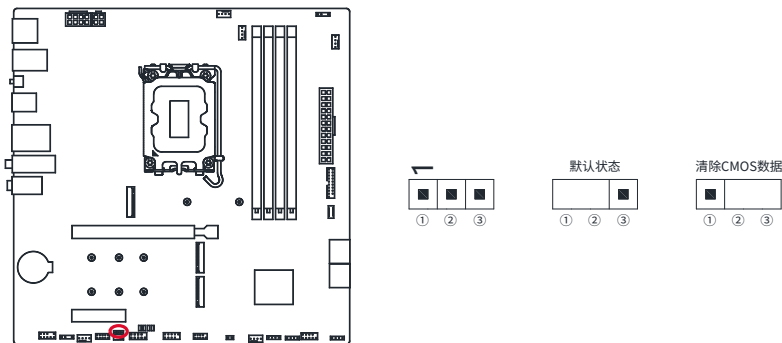

## BIOS 烧录器插针

BIOS 烧录器插针可以在无法通过常规升级 BIOS 的情况下通过连接 BIOS 烧录器对主板 BIOS 进行升级。

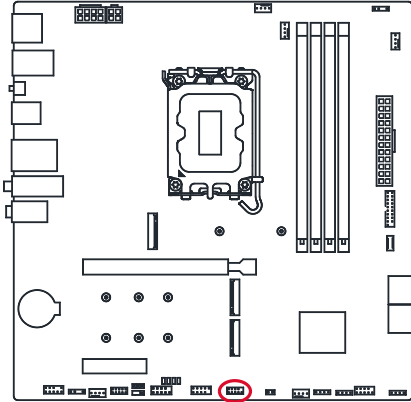

## 诊断卡插针

诊断卡插针可用于连接主板诊断卡，并依据诊断卡所显示的代码分析主板故障原因。

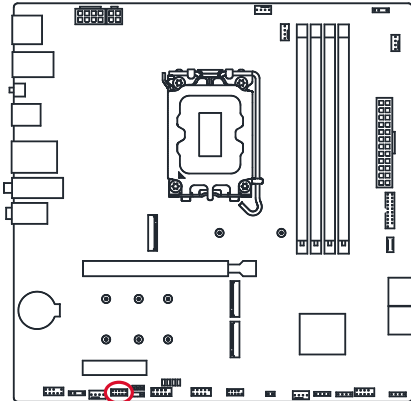

## ME 写保护跳线

ME 写保护跳线用于控制是否可以刷写 BIOS 固件，ME 跳线短接状态下则为关闭 BIOS 写入保护功能，此时可进行 BIOS 更新操作。

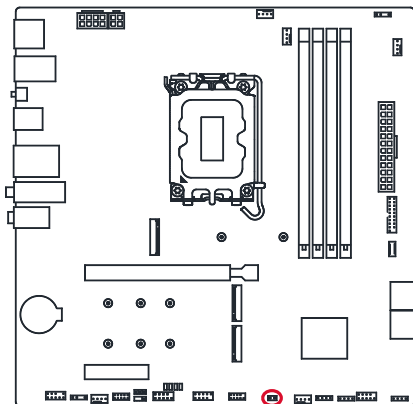

## RGB 灯效控制跳线

RGB 灯效控制跳线可以控制已连接到主板上的 RGB 设备是否开启 RGB 灯效。跳线帽默认插在针脚①和针脚②上，此时可以使用 iGame Center 灯光控制软件来控制主板上的 RGB 设备的灯光效果。如果需要关闭主板的 RGB 设备灯效，首先需要关闭电脑并拔掉电源线，将跳线帽拔出并插到针脚②和针脚③上，此时主板上的 RGB 设备灯效已关闭。

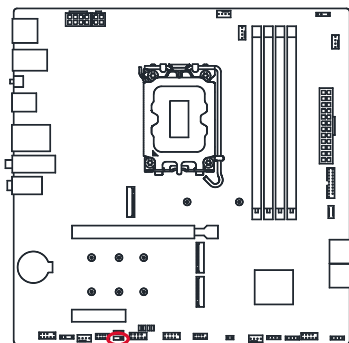



## LED 侦错灯

主板上共有 4 颗 LED 侦错灯，用于侦测计算机启动时 CPU、内存、GPU、启动磁盘的状态，若上述某个硬件存在异常，对应的 LED 灯将持续常亮。

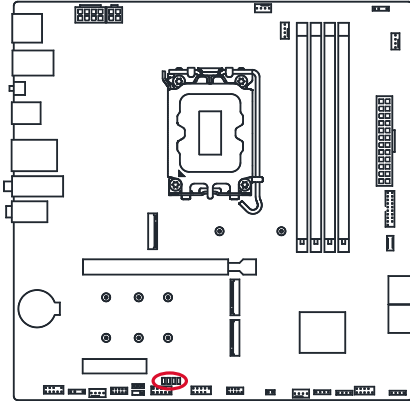

BOOT  
GPU  
DRAM  
CPU

□  
□  
□  
□

# BIOS 介绍

## BIOS 设置程序

### 进入 BIOS

在计算机开机或重启过程中，当屏幕上出现：Press DEL to run Setup 提示信息，按 <Delete>键即可进入 BIOS 设置界面。

若系统 POST 程序已执行完成，您仍想进入 BIOS 设置程序时，请按下机箱上的 <RESET>键重启电脑或将电脑关机后再重启电脑，重复上面的操作即可进入 BIOS。

### BIOS 设置程序主界面

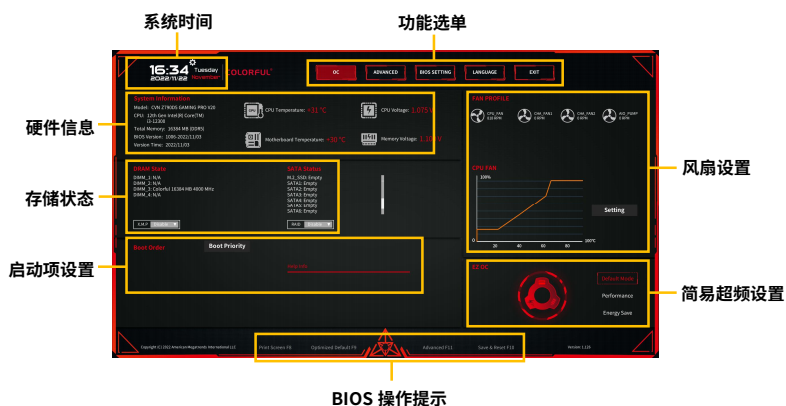

- 不当或错误的 BIOS 设置可能会导致系统不稳定或开机失败，强烈建议您只有在专业人士的协助下，才可以执行 BIOS 程序设置的变更。
- 由于 BIOS 在不断升级，程序画面仅供参考，将可能与您所见的画面有所差异。如果需要了解更详细的 BIOS 设置操作，请扫描右侧二维码下载七彩虹官方的 BIOS 用户指南。



## BIOS 程序更新

每当一款新主板发布之后，其主板 BIOS 也会对应进行迭代更新，主要作用是可以支持最新发布硬件，对已发布的硬件优化其兼容性，提升运行稳定性，或者支持新的 BIOS 功能。



- 更新 BIOS 程序存在潜在风险，如果您的计算机在使用过程中功能无异常，我们不建议您更新 BIOS 程序。
- 如需进行 BIOS 更新操作，请仔细阅读此操作指南并在专业人士指导下操作，以免操作不当造成系统毁损或数据丢失。
- 如果需要了解更详细的 BIOS 程序更新步骤，请扫描右侧二维码下载七彩虹官方的 BIOS 更新指南。



# Contents

<b>Packaging of the product</b> .....	<b>1</b>
<b>Hardware installation</b> .....	<b>1</b>
<b>Diver installation instructions</b> .....	<b>1</b>
<b>Product specification</b> .....	<b>2</b>
<b>I/O interfaces introduction</b> .....	<b>5</b>
<b>Motherboard layout</b> .....	<b>5</b>
CPU slot .....	8
Power interface .....	9
Memory slot.....	10
PCIe expansion slot .....	12
M.2 slot.....	13
SATA 6Gb/s interface .....	14
Front USB 3.2 Gen 1 pin.....	14
Front USB 3.2 Gen 1 Type-C slot.....	15
Front USB 2.0 pin.....	15
CPU fan pin .....	16
System fan pin.....	16
Water cooling pump pin .....	17
5V ARGB pin .....	17
Front audio pin .....	18
12V RGB pin .....	18
Speaker pin.....	19
Front panel pin .....	19
COM port pin.....	20
Clear CMOS jumper.....	20

BIOS burner pin .....	21
POST card pin .....	21
ME write protection jumper .....	22
RGB light effect control jumper.....	22
LED debug light .....	23
<b>BIOS introduction.....</b>	<b>24</b>
BIOS setting program.....	24
Enter BIOS.....	24
Main interface of BIOS setting program.....	24
Update of BIOS program .....	25

## Packaging of the product

After opening the packaging box of the motherboard, please check if all the standard accessories listed below are complete or not.

<b>Motherboard</b>	1× COLORFIRE B760M-MEOW WIFI D5 ORANGE motherboard
<b>Connecting cable</b>	2× SATA 6Gb/s data cable
<b>Other accessories</b>	2× WiFi 6 high gain antenna 1× Front panel auxiliary pin/connector 1× USB 2.0 auxiliary pin/connector
<b>User's manual</b>	1× User's manual for motherboard



- The accessories listed above are for reference only, the delivered items may vary. Colorful reserves the right to change them.
- If any accessories listed above are damaged, please contact your dealer or Colorful customer service as soon as possible.

## Hardware installation

After taking out the motherboard, you can scan the QR code on the right to obtain the official quick operation guide for hardware installation provided by Colorful to install it onto your personal computer quickly.



## Diver installation instructions

You can visit the Colorful official website (<http://www.colorful.cn>), search for the model of the product, find the corresponding driver in the technical support list, and download it. The onboard network card driver can also be downloaded by scanning the QR code on the right.



## Product specification

<b>Chipset</b>	Intel® B760 chipset
<b>CPU</b>	<p>Supports 13th Gen and 12th Gen Intel Core™, Pentium® and Celeron® processors that fit the LGA 1700 slot of the motherboard</p> <p>*Please visit the official website of Colorful (<a href="http://www.colorful.cn">www.colorful.cn</a>) for the latest supported processor list</p>
<b>Memory</b>	<p>4 DDR5 memory slots, supporting up to 192 GB of memory (a single slot can support a capacity of up to 48 GB)</p> <ul style="list-style-type: none"> <li>•Support DDR5-7200(OC)/7000(OC)/6800(OC)/6400(OC)/6200(OC)/6000(OC)/5800(OC)/5600(OC)/5400(OC)/5200(OC)/5000(OC)/ 4800MHz memory</li> <li>•Support Intel® Extreme Memory Profile (XMP) memory technology</li> <li>•Support dual channel memory technology</li> </ul> <p>*Please visit the official website of Colorful (<a href="http://www.colorful.cn">www.colorful.cn</a>) for the latest memory compatibility list</p>
<b>Expansion slots</b>	<p>1×PCIe 5.0 x16 slot</p> <p>1×PCIe 3.0 x4 slot</p>
<b>Storage device interfaces</b>	<p>A total of 3 M.2 slots and 4 SATA 6Gb/s hard disk interfaces are supported</p> <ul style="list-style-type: none"> <li>•M.2_1 slot: support 2242/2280 specifications M.2 SSD (PCIe 4.0 x4, CPU channel)</li> <li>•M.2_2 slot: support 2242/2260/2280 specifications M.2 SSD (PCIe 4.0 x4, PCH channel)</li> <li>•M.2_3 slot: support 2242/2260/2280 specifications M.2 SSD (PCIe 4.0 x4, PCH channel)</li> </ul>

<p><b>RAID</b></p>	<p>Support the creation of RAID 0, RAID 1, RAID 5, and RAID 10 disk arrays using SATA hard disk devices</p> <p>*See the official BIOS user guide of Colorful for the steps to create a RAID disk array</p>
<p><b>Audio</b></p>	<p>Realtek ALC897 high fidelity decoding chip</p> <ul style="list-style-type: none"> <li>●Support up to 5.1 channels</li> </ul>
<p><b>Network function</b></p>	<p>RTL8125BG 2.5G LAN controllers</p>
<p><b>Wireless network card and Bluetooth</b></p>	<p>WiFi 6 module</p> <ul style="list-style-type: none"> <li>●WiFi 6 (support 802.11 a/b/g/n/ac/ax, support 2.4/5 GHz wireless frequency band)</li> <li>●Bluetooth 5.2</li> </ul>
<p><b>Rear I/O interfaces</b></p>	<p>4×USB 2.0 interfaces                  2×USB 3.2 Gen 1 Type-A interfaces                  1×USB 3.2 Gen 2 Type-C interface                  1×DP 1.2 interface, up to 4K 60Hz resolution supported                  1×HDMI 2.0 interface, up to 4K 60Hz resolution supported                  1×2.5G network interface                  2×WiFi 6 antenna interfaces                  3×audio interfaces (audio input/audio output/microphone)                  1×BIOS update button</p>
<p><b>Front USB expansion interfaces</b></p>	<p>1×USB 2.0 pin (support additional 2 USB 2.0 Type-A interfaces) (FUSB2.0_1)                  1×USB 3.2 Gen 1 pin (support additional 2 USB 3.2 Gen 1 Type-A interface) (FUSB3.0)                  1×USB 3.2 Gen 1 Type-C slot (support additional 1 USB 3.2 Gen 1 Type-C interface) (F_USBC)</p>



<p><b>Onboard pin/ jumper/key</b></p>	<p>1×CPU fan pin (CPU_FAN)                      3×System fan pins (CHA_FAN1、CHA_FAN2、CHA_FAN3)                      1×Water cooling pump pin (AIO_PUMP)                      2×5V 3-pin ARGB pins (5V_ARGB_1, 5V_ARGB_2)                      2×12V 4-pin RGB pins (12V_RGB_1, 12V_RGB_2)                      1×Front audio pin (F_AUDIO)                      1×Front panel pin (FPANEL)                      1×Speaker pin (SPEAK)                      1×Clear CMOS jumper (CLR_CMOS)                      1×COM port pin (COM)                      1×BIOS burner pin (JBIOS)                      1×POST card pin (ESPI_HEADER)                      1×ME write protection jumper (JME)                      1×RGB light effect control jumper (RGB_LED_EN)</p>
<p><b>Dimension of motherboard</b></p>	<p>M-ATX Form Factor                      245mm x 245mm</p>



- The specification of the motherboard is subject to the launched product. If there is any change, please visit the Colorful official website for the latest specification.

## I/O interfaces introduction

### COLORFIRE B760M-MEOW WIFI D5 ORANGE

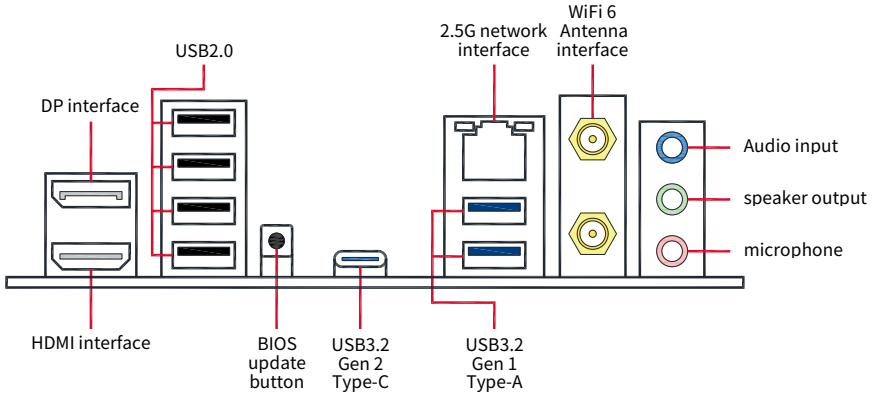

# Motherboard layout

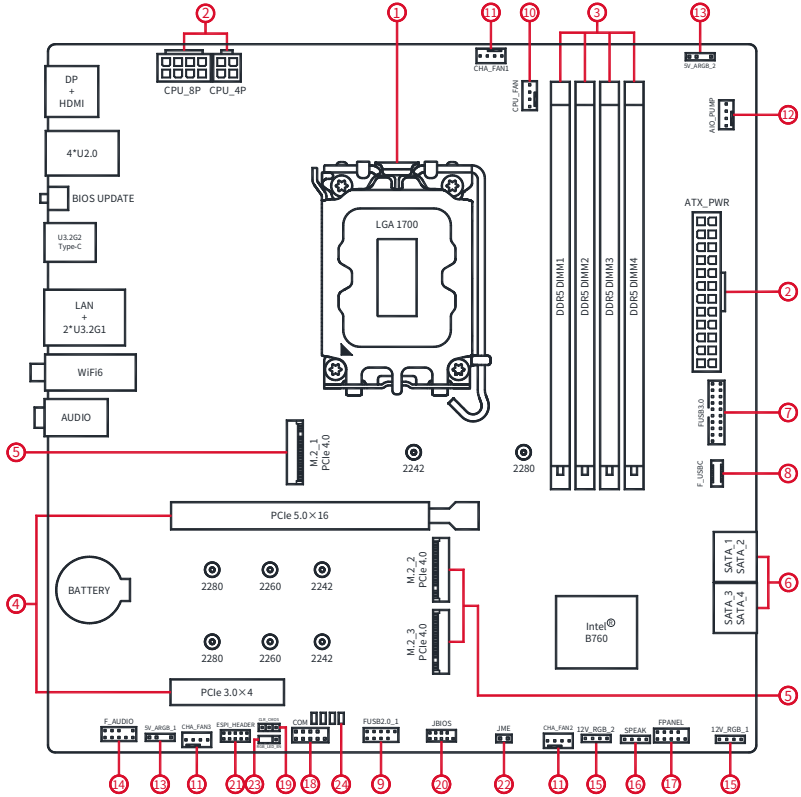

Introduction to motherboard layout:	
① CPU slot	② Power interface
③ Memory slot	④ PCIe expansion slot
⑤ M.2 slot	⑥ SATA 6Gb/s interface
⑦ Front USB 3.2 Gen 1 pin	⑧ Front USB 3.2 Gen 1 Type-C slot
⑨ Front USB 2.0 pin	⑩ CPU fan pin
⑪ System fan pin	⑫ Water cooling pump pin
⑬ 5V ARGB pin	⑭ Front audio pin
⑮ 12V RGB pin	⑯ Speaker pin
⑰ Front panel pin	⑱ COM port pin
⑲ Clear CMOS jumper	⑳ BIOS burner pin
㉑ POST card pin	㉒ ME write protection jumper
㉓ RGB light effect control jumper	㉔ LED debug light

## CPU slot

There is one LGA 1700 processor slot on the motherboard, matching with B760 chipset, supporting the 13th and 12th generations of Intel® Core™, Pentium®, and Celeron® Processors.

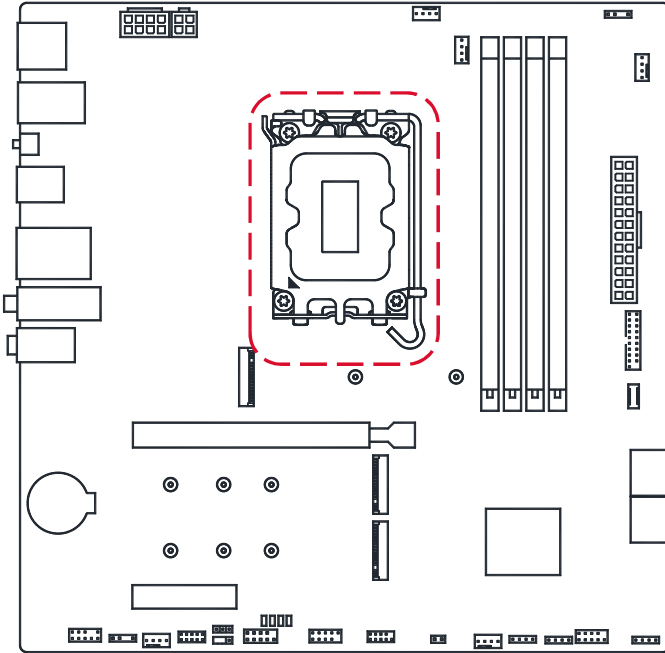

- This slot only supports a processor that fits the LGA 1700 slot, and the CPU must be installed in the correct direction. Do not install the CPU into the socket in the wrong way to avoid damaging the pins in the CPU slot.
- Before installing or removing the CPU, please confirm that the power has been turned off and all power interfaces have been unplugged.
- The CPU generates a large amount of heat during operation, and overheating will damage the CPU. Please apply radiator and heat dissipation silicone grease to ensure sufficient heat dissipation of the CPU.
- If the CPU or motherboard is damaged due to incorrect installation, no warranty service from Colorful will be available.

## Power interface

There is one 24-pin motherboard power supply interface and one 8-pin + 4-pin CPU power supply interface on the motherboard. The connection plug between the power interface of the motherboard and the power supply has a foolproof design, and only the connection in the correct direction can be achieved. After finding the correct direction, insert the connecting plug into the interface and check whether it is loose.

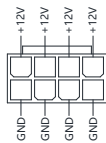
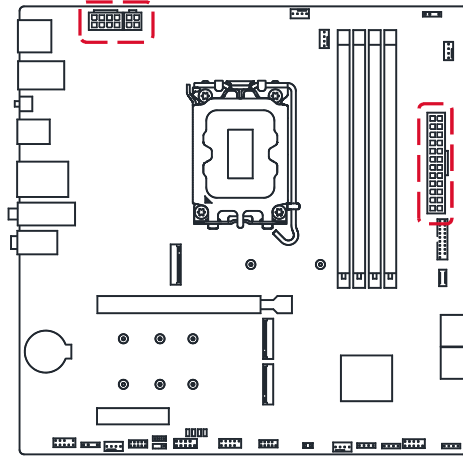

CPU\_8P

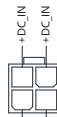

CPU\_4P

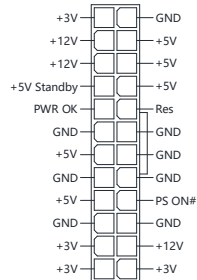

ATX\_PWR



- When installing a hardware device with a higher power, be sure to use a power supply with a higher output power to meet the power demand of the device. If the output power of the power supply is too low, the computer may become unstable or cannot be powered on.

## Memory slot

There are four DDR5 memory slots on this motherboard, which supports up to 192 GB of memory (a single slot can support a capacity of up to 48 GB).

- Support DDR5-7200(OC)/7000(OC)/6800(OC)/6600(OC)/6400(OC)/6200(OC)/6000(OC)/5800(OC)/5600(OC)/5400(OC)/5200(OC)/5000(OC)/4800MHz memory
- Support dual channel memory and Intel® Extreme Memory Profile (XMP) memory technology.
- The upper limit of the memory frequency of the motherboard is determined by the performance of the CPU memory controller and the granular characteristics of the memory itself. Please visit the Colorful official website (<http://www.colorful.cn>) to check the latest memory compatibility list.

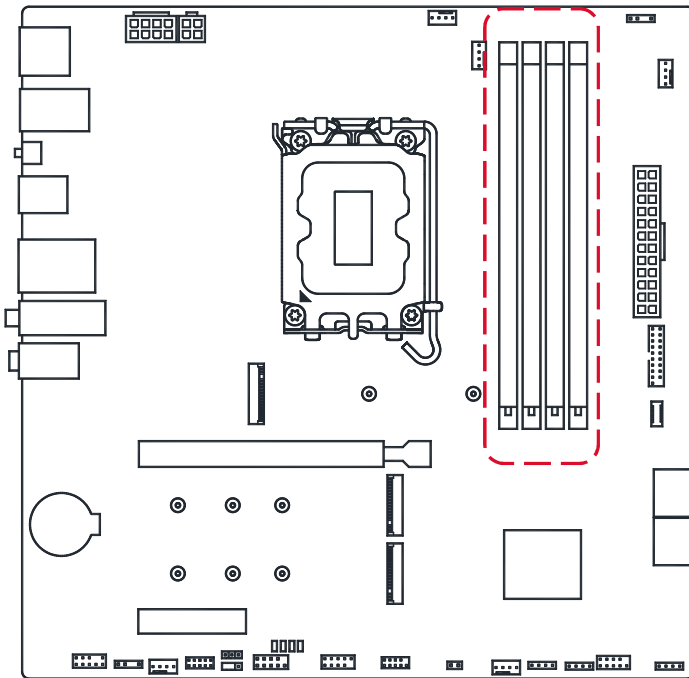

## Suggestions for memory installation

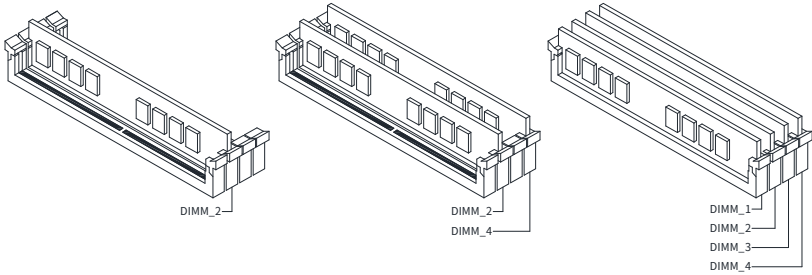

- The default operating frequency of the memory is determined by its SPD, and the frequency of some memory during overclocking may be lower than the promotional value from the manufacturer.
- To properly enable the dual channel memory and ensure stability, it is recommended to install the memory bank of the same capacity, speed, and granularity from the same manufacturer to achieve the best compatibility and performance.



## PCIe expansion slot

There is one PCIe 5.0 x16 slot, and one PCIe 3.0 x4 slot on this motherboard, which can be used to install an independent graphics card, network card, and other expansion cards. If you need to install a heavier graphics card, please use a graphics card bracket to prevent the PCIe slot from deforming.

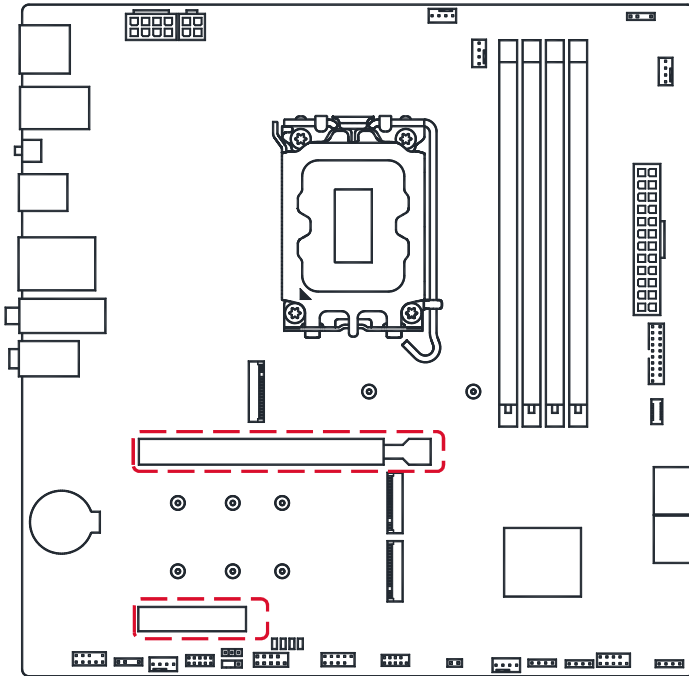

- Before installing or removing the expansion card, please turn off the computer and unplug the power cord to avoid unexpected accidents such as electric shock.

## M.2 slot

There are three M.2 slots on this motherboard, which can be used for installing M.2 SSD module.

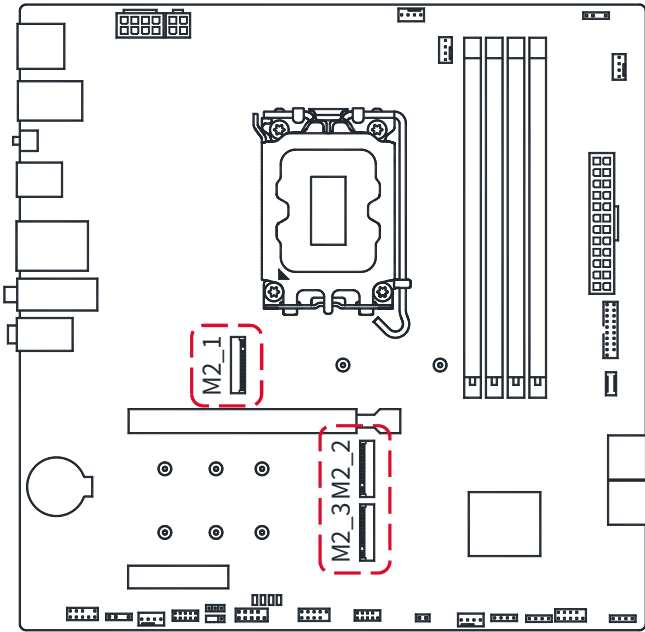

Specification of M.2 slot	
M2_1	Support 2242/2280 PCIe 4.0 x4 SSD
M2_2/ M2_3	Support 2242/2260/2280 PCIe 4.0 x4 SSD

## SATA 6Gb/s interface

There are four SATA 6Gb/s interfaces on the motherboard, which support the connection of the SATA 6Gb/s hard disk.

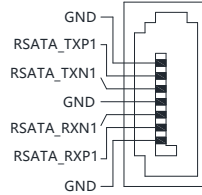
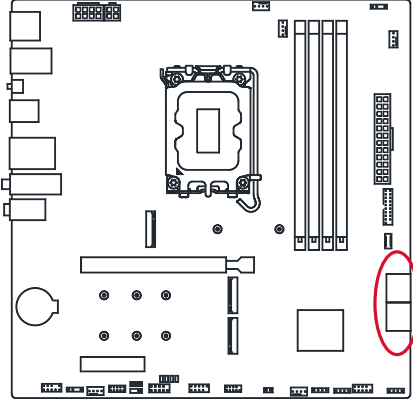

## Front USB 3.2 Gen 1 pin

There is one front USB 3.2 Gen 1 expansion pin on the motherboard, which can be expanded to two USB 3.2 Gen 1 Type-A interfaces while providing backward compatibility for USB 2.0 devices.

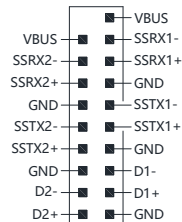
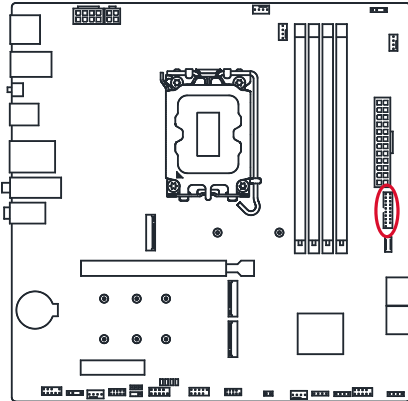

## Front USB 3.2 Gen 1 Type-C slot

There is one front USB 3.2 Gen 1 Type-C slot on the motherboard, which can be expanded to a USB 3.2 Gen 1 Type-C interface.

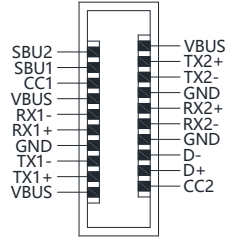
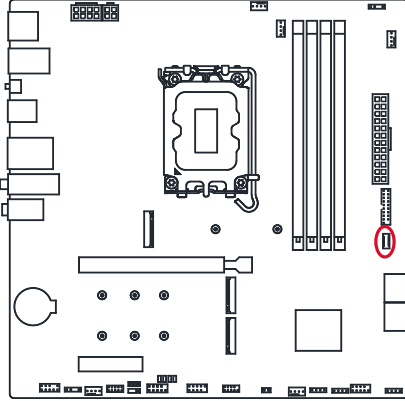

## Front USB 2.0 pin

There is one front USB 2.0 expansion pins on the motherboard, which can be expanded to two USB 2.0 interfaces.

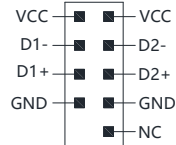
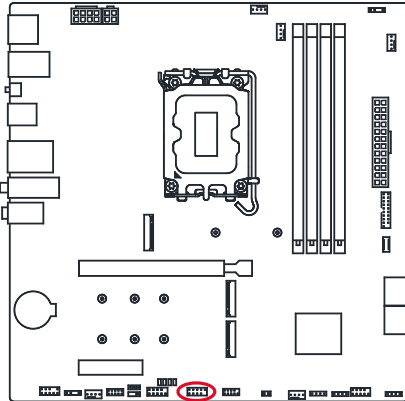

## CPU fan pin

There is one 4-pin CPU fan pin on the motherboard. The socket comes with a foolproof design, and the correct direction must be checked before installation. The cooling fan with a speed control function can reduce the temperature of the CPU and provide a cooling function.

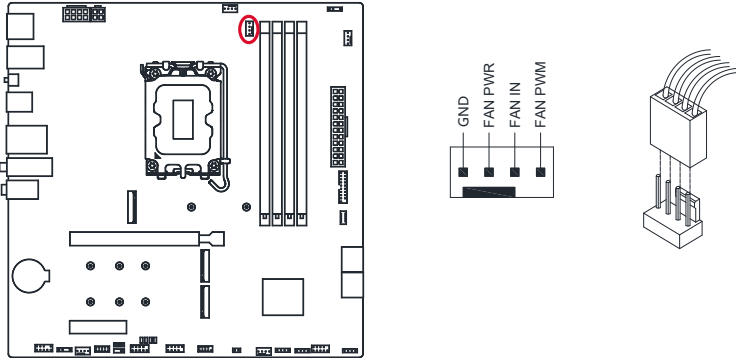

## System fan pin

There are three 4-pin system fan pins in total on the motherboard. The socket comes with a foolproof design, and the correct direction must be checked before installation. CHA\_FAN1 supports independent control, while CHA\_FAN2 and CHA\_FAN3 share control, and when a single fan is connected to CHA\_FAN3, the fan cannot be detected by the motherboard. Matching with a cooling fan with a speed control function, the temperature of the computer case can be reduced, achieving the cooling function.

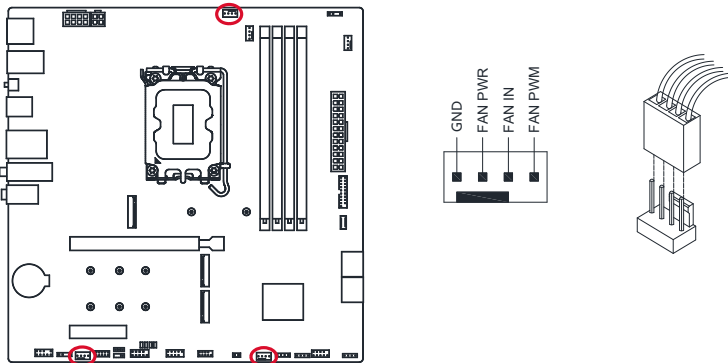

## Water cooling pump pin

There is one 4-pin water cooling pump pin on the motherboard. The socket comes with a foolproof design, and the correct direction must be checked before installation. This pin is used to connect the power connector of an integrated water-cooling CPU radiator water pump.

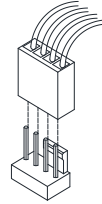
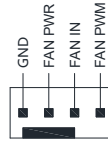
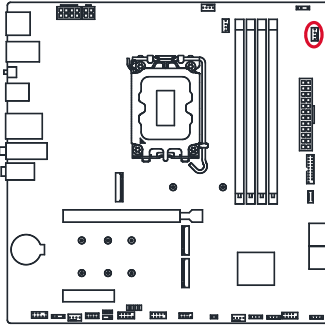

## 5V ARGB pin

There are two 5V 3-in ARGB pins on the motherboard, which are used for connecting 5V ARGB devices.

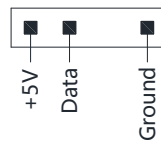
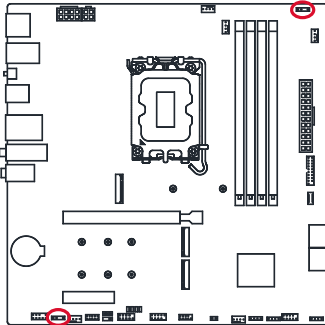

- The motherboard supports light effect control. Please visit the Colorful official website (<https://www.colorful.cn>) to download the iGame Center light control software for adjusting the light effect modes.
- ARGB fan is an optional device and can be additionally purchased.

## Front audio pin

The audio interface on the front panel of the case can be connected to the front audio pin through the audio cable in the case, allowing audio input/output and other functions through the audio interface on the front panel.

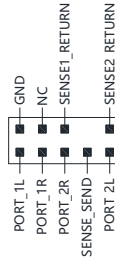
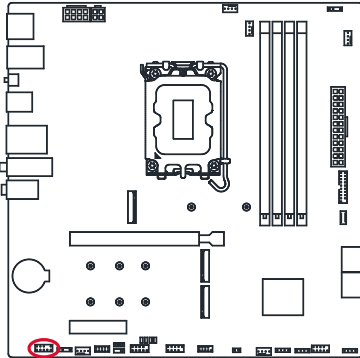

## 12V RGB pin

There are two 12V 4-pin RGB pins on the motherboard, which are used for connecting 12V RGB devices.

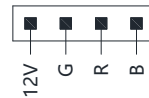
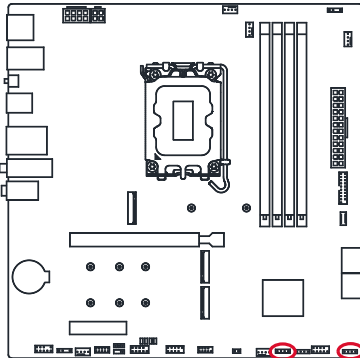

- The motherboard supports light effect control. Please visit the Colorful official website (<https://www.colorful.cn>) to download the iGame Center light control software for adjusting the light effect modes.
- ARGB fan is an optional device, and it shall be purchased additionally if it is to be used.

## Speaker pin

There is one speaker pin on the motherboard, which can be used for connecting the speaker located on the case.

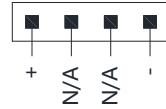
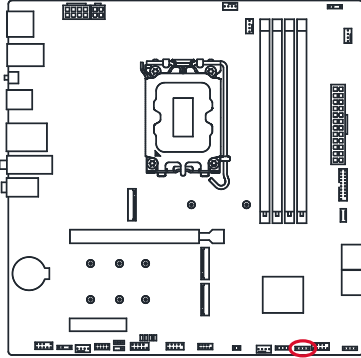

## Front panel pin

PWR\_Switch: the power switch. Connect this pin with a short circuit to start the computer.

Reset\_Switch: the restart switch. Connect this pin with a short circuit to restart the computer without turning off the system power.

PWR\_LED: power indicator. This light will be lit when the system is powered on.

HD\_LED: hard disk indicator. This light will be lit when accessing data on the hard disk.

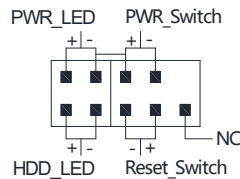
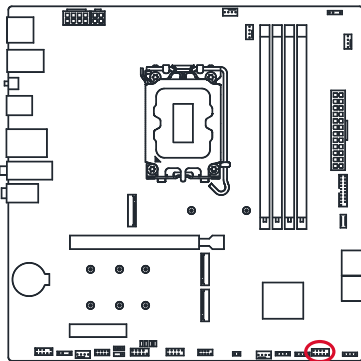



## COM port pin

The COM port pin can be used to connect the COM port module. First, connect the data cable of the COM port module to the COM port pin, then fix the module in the empty slot on the rear panel of the case, allowing the connection of the COM port device.

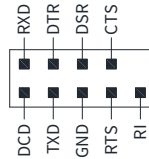
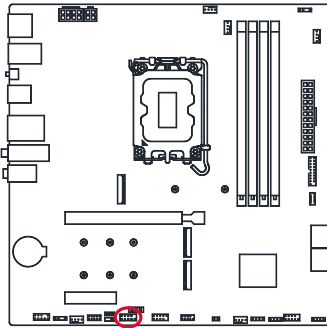

## Clear CMOS jumper

Clear CMOS jumper can be used to clear the data in the motherboard CMOS memory. The BIOS settings are stored in the CMOS memory, which is independently powered by the battery on the motherboard. The jumper caps are inserted on pins ① and ② by default, and the CMOS data will not be cleared. To clear the CMOS data, first shut down the computer and unplug the power cord, pull out the jumper cap and plug it into pin ② and pin ③, short-circuit the two pins for 5 seconds, then pull out the jumper cap, wait 5 minutes and then start the computer, you can enter the BIOS to reset the BIOS parameters.

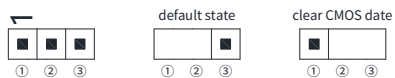
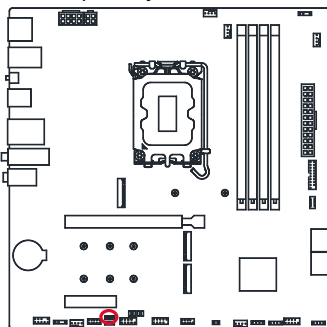

## BIOS burner pin

When the BIOS cannot be upgraded by conventional methods, the BIOS burner pin can upgrade the BIOS of the motherboard by connecting the BIOS burner.

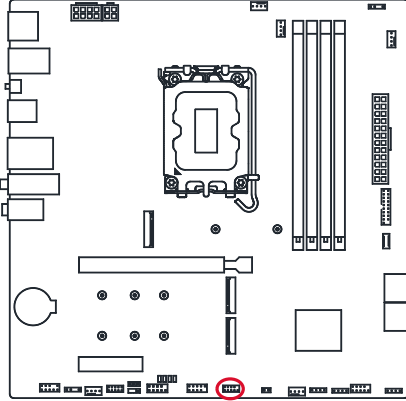

## POST card pin

The POST card pin can be used to connect the motherboard POST card and analyze the cause of motherboard failure according to the code displayed on the POST card.

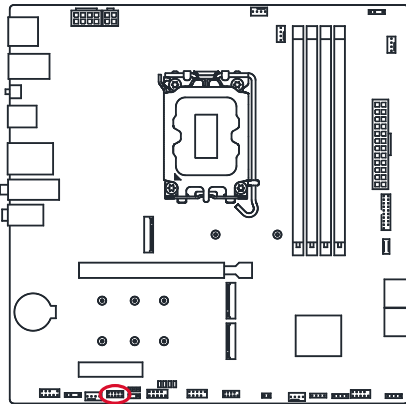

## ME write protection jumper

The ME write protection jumper is used to control whether the BIOS firmware can be written. When the ME jumper is short-circuited, the BIOS write protection function is disabled. At this time, the BIOS can be updated.

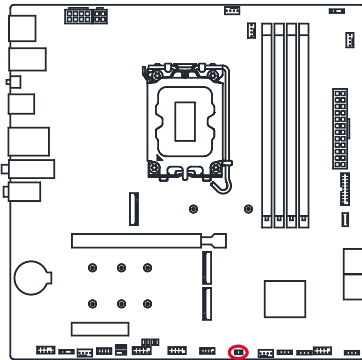

default  
BIOS write  
protection  
enabled



short-circuit  
BIOS write  
protection  
disabled

## RGB light effect control jumper

The RGB light effect control jumper can control whether the RGB light effect of the RGB devices connected to the motherboard is enabled. The jumper cap is inserted on pin ① and pin ② by default. At this time, you can use the iGame Center light control software to control the light effect of RGB devices on the motherboard. If you need to disable the RGB device light effect on the motherboard, first turn off the computer and unplug the power cord, pull out the jumper cap and plug it into pin ② and pin ③. By this time, the RGB device light effect on the motherboard will have been disabled.

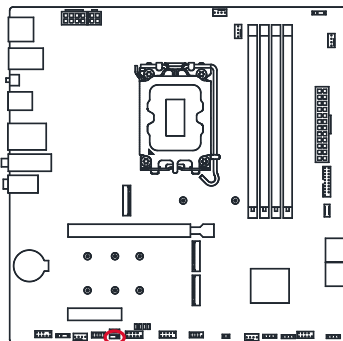

## LED debug light

There are four LED debug lights on the motherboard, which are used to detect the status of CPU, memory, GPU, and disk booting when the computer is started. If any of the above is abnormal, the corresponding LED lights will remain on.

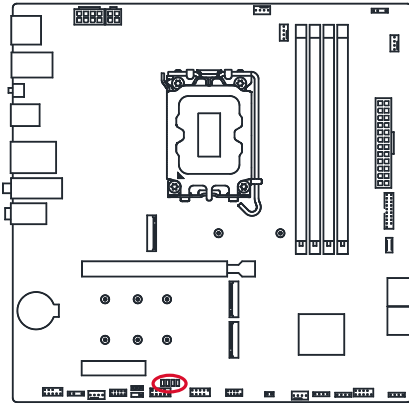

- BOOT
  - GPU
  - DRAM
  - CPU
- □ □ □

# BIOS introduction

## BIOS setting program

### Enter BIOS

When the prompt "Press DEL to run Setup" appears on the screen during the startup or restart of the computer, press the <Delete> key to enter the BIOS setting interface.

If the system's POST program has been executed and you still want to enter the BIOS Setup program, please press the <RESET> key on the case to restart the computer or turn off the computer and restart it. Repeat the above steps to enter the BIOS.

### Main interface of BIOS setting program

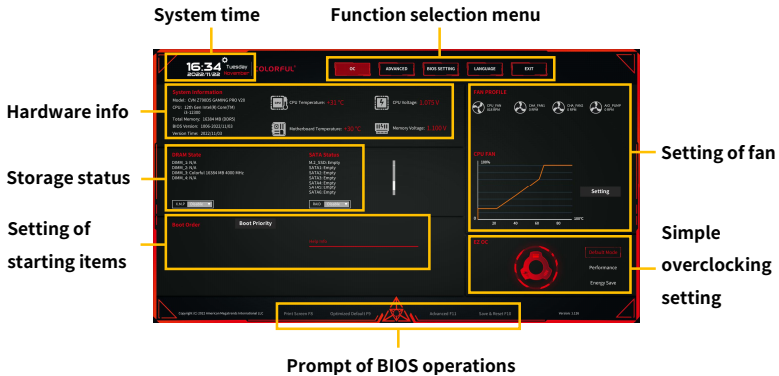



- Improper or incorrect BIOS settings may lead to system instability or boot failure. It is strongly recommended that you change BIOS program settings only with the assistance of professionals.
- Since BIOS is constantly upgraded, the current program interface is only for reference, which may be different from the picture you see. If you need more detailed BIOS setting information, please scan the QR code on the right to download the official BIOS user guide of Colorful.



## Update of BIOS program

Every time a new motherboard is released, its motherboard BIOS will also be updated iteratively. The main function of such a process is to support the latest released hardware, optimize its compatibility with the released hardware, improve its running stability, or support new BIOS functions.



- There are potential risks in updating the BIOS program. If your computer works normally, we do not recommend that you update the BIOS program.
- If you need to update BIOS, please read this operation guide carefully and operate under the guidance of professionals to avoid system damage or data loss due to improper operation.
- If you need a more detailed BIOS program update procedure, please scan the QR code on the right to download the official BIOS update guide of Colorful.

