



**Compaq** Evo D310  
Micro Desktop

**COMPAQ**

technical  
reference  
manual

[www.hp.com/go/support](http://www.hp.com/go/support)

---

## Notice

The information contained in this document is subject to change without notice.

Hewlett-Packard makes no warranty of any kind with regard to this material, including, but not limited to, the implied warranties of merchantability and fitness for a particular purpose. Hewlett-Packard shall not be liable for errors contained herein or for incidental or consequential damages in connection with the furnishing, performance, or use of this material.

This document contains proprietary information that is protected by copyright. All rights are reserved. No part of this document may be photocopied, reproduced, or translated to another language without the prior written consent of Hewlett-Packard Company.

Compaq™, the Compaq logo™, and Evo™ are trademarks of Compaq Information Technologies Group, L.P. in the U.S. and other countries.

Acrobat™ is a trademark of Adobe Systems Incorporated.

Microsoft®, Windows® and Windows XP® are U.S. registered trademarks of Microsoft Corporation.

Intel®, Celeron® and Pentium® are registered trademarks of Intel Corporation.

Analog Devices® and SoundMax® are registered trademarks of Analog Devices Incorporated.

ATI™ and RADEON™ are trademarks of ATI Technologies Inc.

HP France  
Business Desktop Division  
38053 Grenoble Cedex 9  
France

© 2002 Hewlett-Packard Company

© 2002 Compaq Information Technologies Group, L.P

---

---

# Information Roadmap

Use the  icon in Acrobat Reader to search for information in this PDF.

The following types of information are available for HP Compaq Business PCs:

## Installing, Configuring and Upgrading



See the *HP Compaq Service Handbook Chapter* or the *HP Compaq Upgrade Guide*.

The *Service Handbook Chapter*, available in PDF format on the HP support web site ([www.hp.com/go/support](http://www.hp.com/go/support)), provides information on:

- HP Compaq Business PC configurations
- Replacement parts
- Available accessories.

The *Upgrade Guide* will help you upgrade and replace components in your HP Compaq Business PC, including the hard drive, memory, battery, power supply, and optical drives. More information is available on the HP support web site ([www.hp.com/go/support](http://www.hp.com/go/support)).

## Troubleshooting



See the *HP Compaq Troubleshooting Guide*.

The *Troubleshooting Guide*, available in PDF format on the HP support web site ([www.hp.com/go/support](http://www.hp.com/go/support)) will help you:

- Troubleshoot your HP Compaq Business PC
- Find out where to get more information.

## Discover and use your product

See the *HP Compaq Quick Start* card and *HP Compaq Quick User's Guide*.



The *Quick Start* card provided with your HP Compaq Business PC will help you:

- Set up and begin using your HP Compaq Business PC for the first time
- Upgrade and replace components in your HP Compaq Business PC, including the hard drive, processor memory, add-on cards and optical drives. More information is available on the HP support web site ([www.hp.com/go/support](http://www.hp.com/go/support)).
- Find out where to get more information.

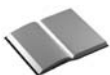

The *Quick User's Guide* provided with your HP Compaq Business PC includes basic troubleshooting information, technical specifications, warranty and legal information.

## Your computer's online information



Your computer may contain online help information on the hard disk. It includes information on:

- Troubleshooting and how to use HP Instant Support
- Linking to useful HP web sites.

## Information on the hp support web site



Refer to the HP support web site ([www.hp.com/go/support](http://www.hp.com/go/support)) for a wide range of information, including:

- Downloadable documentation
- Service and support options
- The latest BIOS, drivers and utilities
- Answers to Frequently Asked Questions.

## System recovery cd-roms



Used for a full system recovery or alternative OS installation. Includes instructions on how to recover your preloaded software including operating system, drivers and utilities.

---

# Finding Information

Use the following table to determine where to locate particular types of information:

Type of Information	Location
<ul style="list-style-type: none"><li>• Support phone numbers</li><li>• Technical support contact information</li><li>• Warranty information</li></ul>	<i>Quick User's Guide</i>
<ul style="list-style-type: none"><li>• How to set up your computer</li></ul>	<i>Quick Start Card</i> (details) <i>Quick User's Guide</i> (general information)
<ul style="list-style-type: none"><li>• Operation of your computer</li></ul>	Operating system and application manuals
<ul style="list-style-type: none"><li>• Diagrams and detailed instructions on installing add-on devices</li><li>• Internal wire connections for adding hard drives, CD-ROM, etc.</li><li>• Memory expansion and replacing devices</li></ul>	<i>Upgrade Guide</i>
<ul style="list-style-type: none"><li>• LAN configuration</li><li>• LAN controller</li></ul>	<i>Technical Reference Manual</i>
<ul style="list-style-type: none"><li>• Identifying the problem</li><li>• Information on errors</li><li>• Problem solving</li><li>• Troubleshooting</li></ul>	<i>Troubleshooting Guide</i>
<ul style="list-style-type: none"><li>• Parts list</li><li>• Accessories list</li></ul>	<i>Service Handbook Chapter</i>
<ul style="list-style-type: none"><li>• BIOS</li><li>• Connectors</li><li>• IRQ</li><li>• POST setup</li><li>• Specifications</li><li>• System board layout</li><li>• Technical diagrams</li></ul>	<i>Technical Reference Manual</i>

---

# Bibliography

Datasheets and other information can be obtained at:

- Intel Chipsets*  
**[developer.intel.com](http://developer.intel.com)**
- Intel Dynamic Video Memory Technology*  
**[www.developer.intel.com/business/products/chipsets/dvmt\\_white.pdf](http://www.developer.intel.com/business/products/chipsets/dvmt_white.pdf)**
- Pentium 4 Processors*  
**[www.intel.com/design/pentium4](http://www.intel.com/design/pentium4)**
- Analog Devices AD1981A*  
**[www.analogdevices.com](http://www.analogdevices.com)**
- Intel LAN card*  
**[www.intel.com/support/network](http://www.intel.com/support/network)**
- ATI graphics cards*  
**[www.ati.com](http://www.ati.com)**
- Hewlett-Packard white papers are available on a variety of subjects including AGP graphics and SDRAM memory at:  
**[www.hp.com/go/library](http://www.hp.com/go/library)**

---

# Table of Contents

## System Overview

System Features . . . . .	10
Package Features . . . . .	11
Rear Connectors . . . . .	11
Front Panel . . . . .	11
Inside the PC . . . . .	12
Rear View . . . . .	12
Specifications . . . . .	13
Physical Characteristics . . . . .	13
Environmental Specifications . . . . .	13
Acoustic Noise Emission . . . . .	13
Power Consumption . . . . .	14

## System Features

System Board Layout . . . . .	16
System Board Components . . . . .	17
Chipset . . . . .	18
Main Features . . . . .	18
Intel 845G System Block Diagram . . . . .	19
Processor . . . . .	20
Intel Pentium 4 (Socket 478) . . . . .	20
Intel Celeron (Socket 478) . . . . .	20
Main Memory . . . . .	21
Accessory Board Slots . . . . .	22
PCI Slot Numbers . . . . .	22
System Board Switches . . . . .	23
Hard Disk Drives . . . . .	24
Ultra-ATA/100 Hard Disk Drives . . . . .	24
Floppy Disk Drives . . . . .	24
Optical Drives . . . . .	25
Features of the CD-RW Drive . . . . .	25
Features of the DVD-ROM Drive . . . . .	26
Features of the CD-ROM Drive . . . . .	29

Graphics .....	30
Intel 845G Chipset Integrated Graphics .....	30
ATI Radeon 7000 .....	31
ATI Radeon 7500 .....	32
Audio .....	33
Analog Devices AD1981A .....	33
LAN Controller .....	34
LAN Connector .....	35
USB 2.0 Connectors .....	36

## Serviceability

Evo D310 Micro Desktop .....	38
------------------------------	----

## BIOS Overview

BIOS Summary .....	40
Entering the Configuration and Diagnostics menu .....	40
Using the PC Setup Program .....	41
Power Management and Wake Up Events .....	43
BIOS Addresses .....	44
System Memory Map .....	44
HP I/O Port Map (I/O Addresses Used by the System) .....	44
POST Tests .....	47
HP e-DiagTools Preboot Diagnostics (Beep Codes) .....	52

## Drivers and Software

Drivers .....	54
Software .....	54
Operating System .....	54
Software .....	54
e-DiagTools .....	54
BIOS Updates .....	55



---

## **System Overview**

This chapter introduces the internal and external features, and lists the specifications of the Compaq Evo D310 Micro Desktop PC.

## System Features

Component	Description
<b>Package Description</b>	1 front-accessible shelf for CD-ROM, DVD-ROM or CD-RW drive. 1 internal shelf for standard 3.5in hard disk drive (one pre-installed). 4 accessory board slots (3 PCI, 1 AGP).
	Width: 35.9cm (14.36in.) Height: 13.7cm (5.48in.) Depth: 41cm (16.4in.).
<b>Processor</b>	Intel Pentium 4: 1.7GHz and above (400/533MHz FSB). Intel Celeron: 1.7GHz and above (400MHz FSB).
<b>System Board:</b>	
<b>Chipset</b>	Intel 845G.
<b>Integrated I/O</b>	6 USB 2.0 connectors (2 front, 4 rear), 2 serial ports (1 optional), 1 parallel port, audio (microphone, line in, line out).
<b>Graphics</b>	Integrated Intel graphics solution. Optional graphics card: - ATI Radeon, 7000 32MB - ATI Radeon, 7500 64MB
<b>Audio</b>	Integrated Analog Devices AD1981A AC'97 SoundMAX CODEC.
<b>LAN</b>	Integrated Intel Pro/100 VE Network Adapter (10 Base-T/100 Base-TX LAN Interface) or 3COM LAN controller.
<b>Mass storage</b>	Choice of hard disk drives: Ultra ATA/100: 20GB (5400 rpm), 20GB (7200 rpm), 40GB (7200 rpm), 80GB (7200 rpm). Floppy drive: standard 1.44MB 3.5" (or alternative second hard drive).
	CD-ROM drive: 48X IDE. DVD-ROM drive: 16X, 40X IDE (WinDVD MPEG2 decoding software from InterVideo included). CD-RW drive: 40X, 10X, 40X IDE (DLA and MyCD software from Veritas included).
<b>Main memory</b>	Two DDR-SDRAM sockets using: 128MB, 256MB and 512MB 266MHz DDR-SDRAM. Maximum of 1GB.
<b>Input devices</b>	Compaq PS/2 keyboard and scrolling mouse.
<b>Power supply</b>	Input Voltage: 100-127V 6A max. 200-240V 4A max ac (voltage selection switch). Input Frequency: 50/60 Hz.
<b>Connectors</b>	Keyboard, mouse, VGA, parallel, serial, video, 6 x USB (4 rear, 2 front), 1 Ethernet port, 3 x audio (stereo-in, stereo-out, microphone-in).
<b>BIOS</b>	Based on American Megatrends Inc. (AMI) core 7.00T. BIOS, Version: JH.01.yy. This BIOS is not localized.

# Package Features

## Rear Connectors

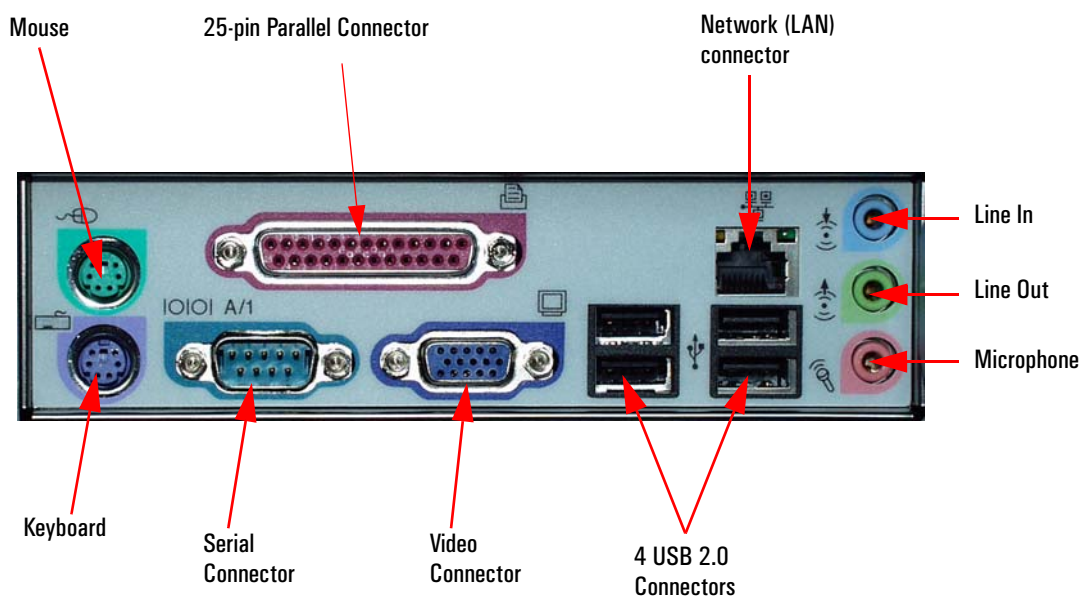

## Front Panel

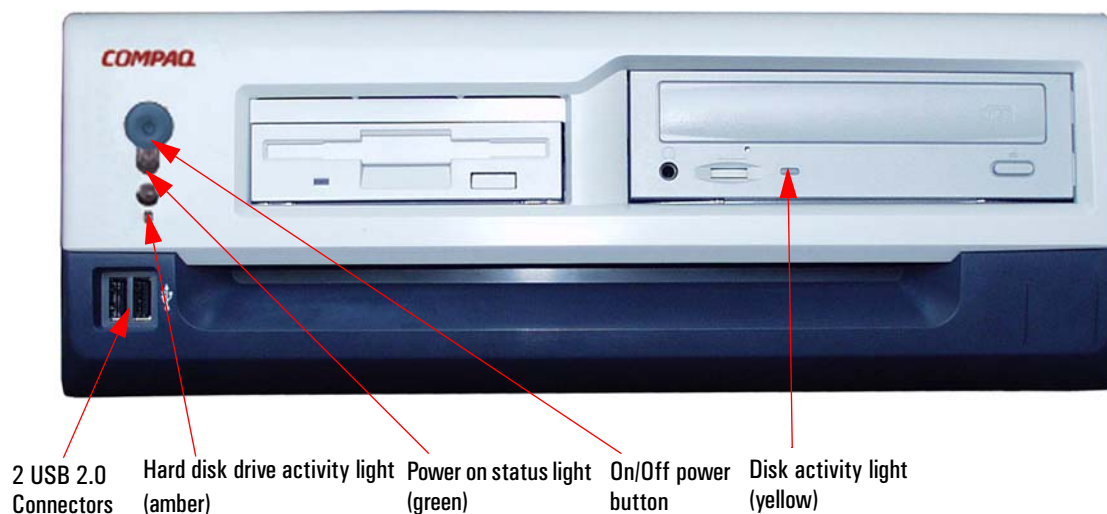

## Inside the PC

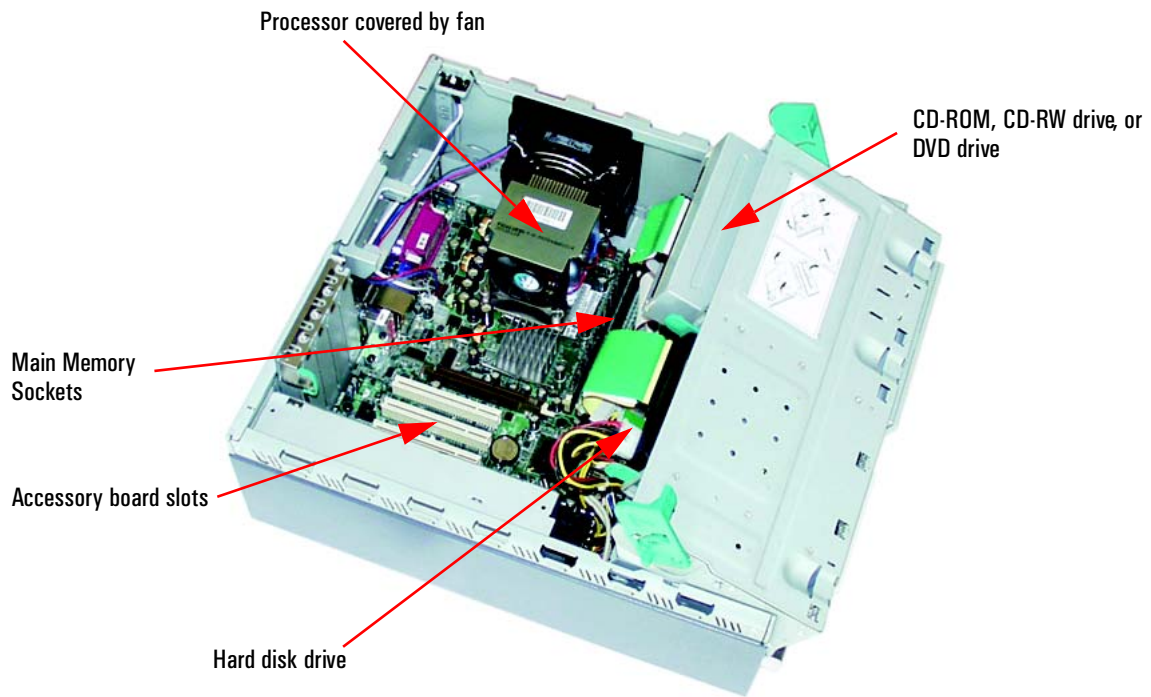

## Rear View

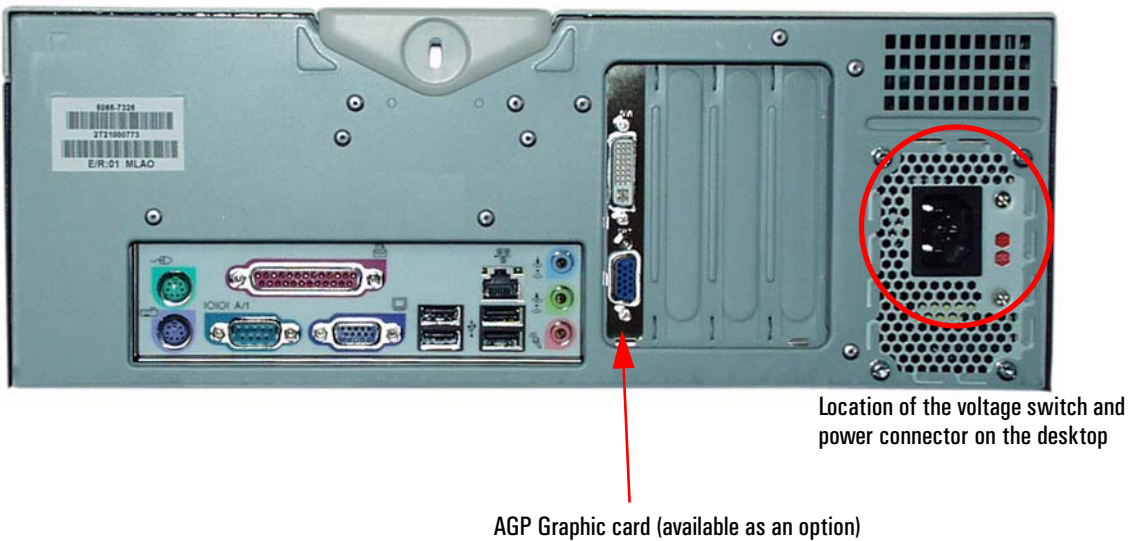

# Specifications

## Physical Characteristics

Characteristic	Compaq Evo D310 Micro Desktop
Weight (configuration with 1 CD-ROM drive, excluding keyboard and display)	10.2kg (22.5 pounds)
Dimensions	Width: 36cm (14.2in.) Height: 13.5cm (5.3in.) Depth: 41cm (16.2in.)
Footprint	0.16m <sup>2</sup> (1.78 sq ft)

## Environmental Specifications

Environmental Specifications (System Processing Unit, with Hard Disk)	
Operating Temperature	+5°C to +35°C (+41°F to 95°F)
Storage Temperature	-40°F to +70°F (-40°C to +158°C)
Operating Humidity	15% to 80% (relative)
Storage Humidity (operating)	15% to 80% (relative), non-condensing at 40°C (104°F)
Storage Humidity (non operating)	8% to 85% (relative), non-condensing at 40°C (104°F)

**NOTE** Operating temperature and humidity ranges may vary depending on the mass storage devices installed. High humidity levels can cause improper operation of disk drives. Low humidity ranges can aggravate static electricity problems and cause excessive wear of the disk surface.

## Acoustic Noise Emission

Characteristic	Compaq Evo D310 Micro Desktop
Acoustic noise emission (IS 07779)	Sound pressure level at operator position
	LpA ≤ 27 dB(A)
• Idle (typical)	LpA ≤ 29 dB(A)
• Operating with hard disk access	LpA ≤ 39 dB(A)
• Operating with floppy disk access	LpA ≤ 41 dB(A)
• Operating with CD access	
	Sound power level <sup>1</sup>
• Idle (typical)	LwA ≤ 3.5 B(A)
• Operating with hard disk access	LwA ≤ 3.8 B(A)
• Operating with floppy disk access	LwA ≤ 4.7 B(A)
• Operating with CD access	LwA ≤ 4.8 B(A)

1.LwAd = LwA + 3 dB(A).

## Power Consumption

As an ENERGY STAR partner, HP has determined that this product meets the ENERGY STAR guidelines for energy efficiency (Windows 2000 only). This value is only achieved when “Suspend to RAM” (S3 mode) is enabled. To enable Suspend to RAM, enter the PC’s Setup program by pressing F2 during startup and select the Power menu.

In normal mode power consumption will be around 50W.

Characteristic	Compaq Evo D310 Micro Desktop
Power Supply	
<ul style="list-style-type: none"> <li>• Input voltage</li> <li>• Voltage selection switch</li> <li>• Input frequency</li> </ul>	<p>100-127V 6A max</p> <p>200-240V 4A max</p> <p>50/60Hz</p>
Power consumption	115V/60Hz and 230V/50Hz
<ul style="list-style-type: none"> <li>• Maximum Operating</li> <li>• Typical</li> <li>• Sleep (suspend)</li> <li>• Off</li> </ul>	<p>120W</p> <p>50W</p> <p>&lt; 5W</p> <p>&lt; 5W</p>

---

### NOTE

The power consumption figures given in the table above are valid for the standard configuration as shipped. For more information, refer to the product’s data sheet at HP’s web site: [www.hp.com/go/desktops](http://www.hp.com/go/desktops)

When the computer is turned off with the power button on the front panel, the power consumption falls below 5W, but it is not zero. The special on/off method used by these computers considerably extends the lifetime of the power supply. To reach zero power consumption in “off” mode, either unplug the power outlet or use a power block with a switch.

---

---

## **System Features**

This chapter describes core components of the Compaq Evo D310 Micro Desktop such as the chipset, processor, mass storage devices, graphics controllers, audio controllers, network features and input devices.

## System Board Layout

The Compaq Evo D310 Micro Desktop system board features two DDR-SDRAM main memory slots, three PCI slots and an AGP slot.





# System Board Components

The following diagram shows where the different slots and connectors are located on the system board:

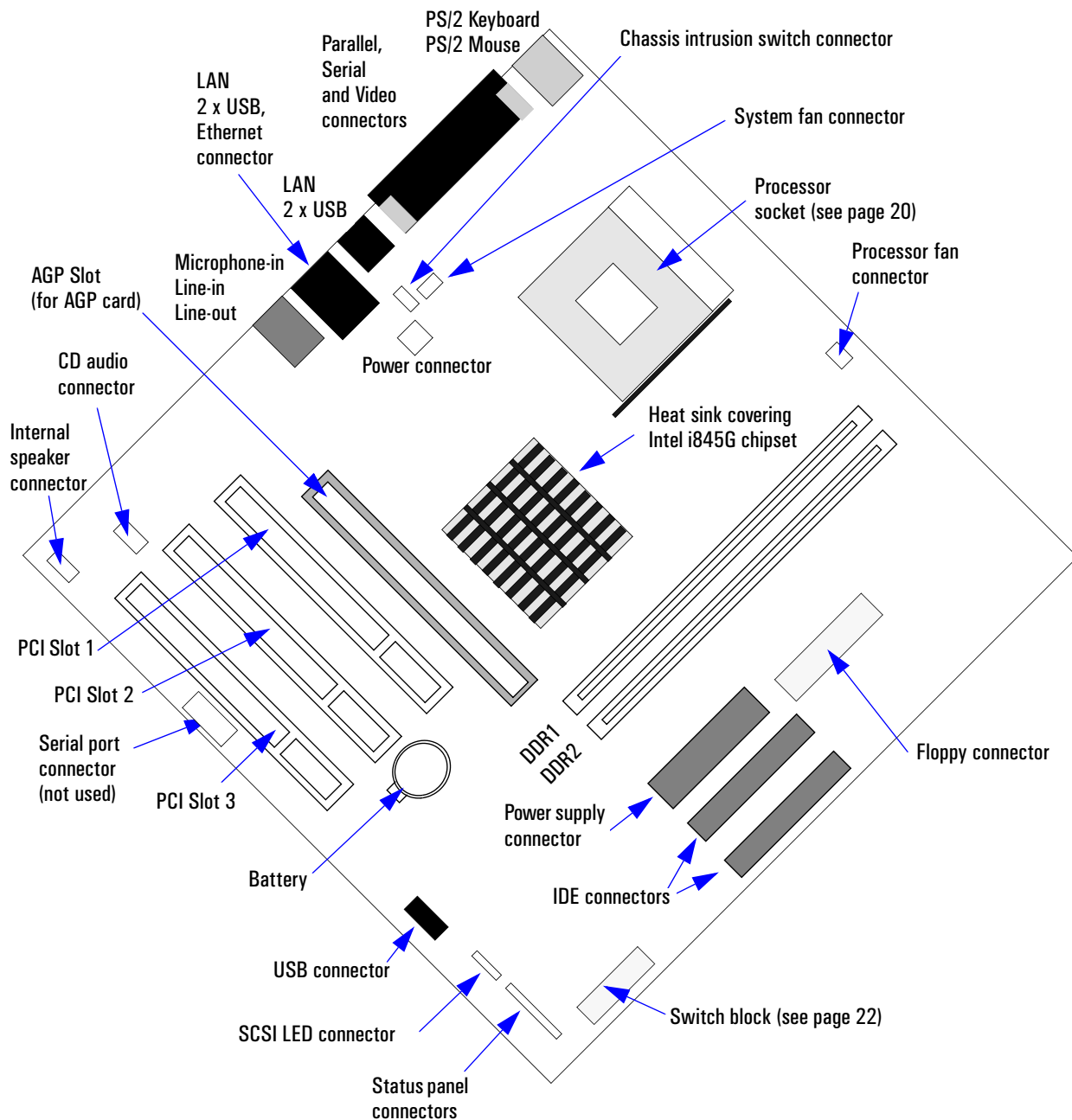

**WARNING** There is a risk of explosion if the battery is not replaced by the correct type. Make sure you dispose of used batteries according to instructions provided.

## Chipset

The Compaq Evo D310 Micro Desktop features the Intel i845G chipset.

The 845G chipset offers the available bandwidth of DDR-SDRAM 266 MHz main memory, coupled with a 533 MHz Front Side Bus (FSB) and high speed USB 2.0 connectivity to allow for high PC performance.

The 845G chipset consists of two controller hubs:

- The 82845G Graphics Memory Controller Hub (GMCH) supports both 400 and 500 MHz system bus designs, PC133 or DDR200/DDR266 SDRAM memory, and the new integrated graphics architecture. It features Intel's Dynamic Video Memory Technology (DVMT) and Zone Rendering Technology (ZRT).
- The 82801DB I/O Controller Hub (ICH4) brings high speed USB 2.0, offering up to 40X greater bandwidth for I/O intensive applications.

## Main Features

- Support for Intel Pentium 4 processor
- mPGA478 socket
- 32 bpp true color support for high resolution texture
- Flat panel monitors and TV-out support via 3rd party DVO devices
- Memory bandwidth DDR200/266 SDRAM support
- 2.0 GB Max memory
- 2 DIMM, no ECC
- ICH4 I/O Connectivity
- Six high speed USB 2.0 ports offering up to 40 X greater bandwidth over original USB 1.1
- Enhanced audio
- 400 and 533 Mhz system bus compatibility
- AGP4X interface providing the most advanced graphics support available
- LAN connect Interface (LCI) provides flexible network solutions
- Dual Ultra ATA/100 controllers
- Communication and Networking Riser (CNR) card capability
- Low power sleep mode.

### Intel 845G System Block Diagram:

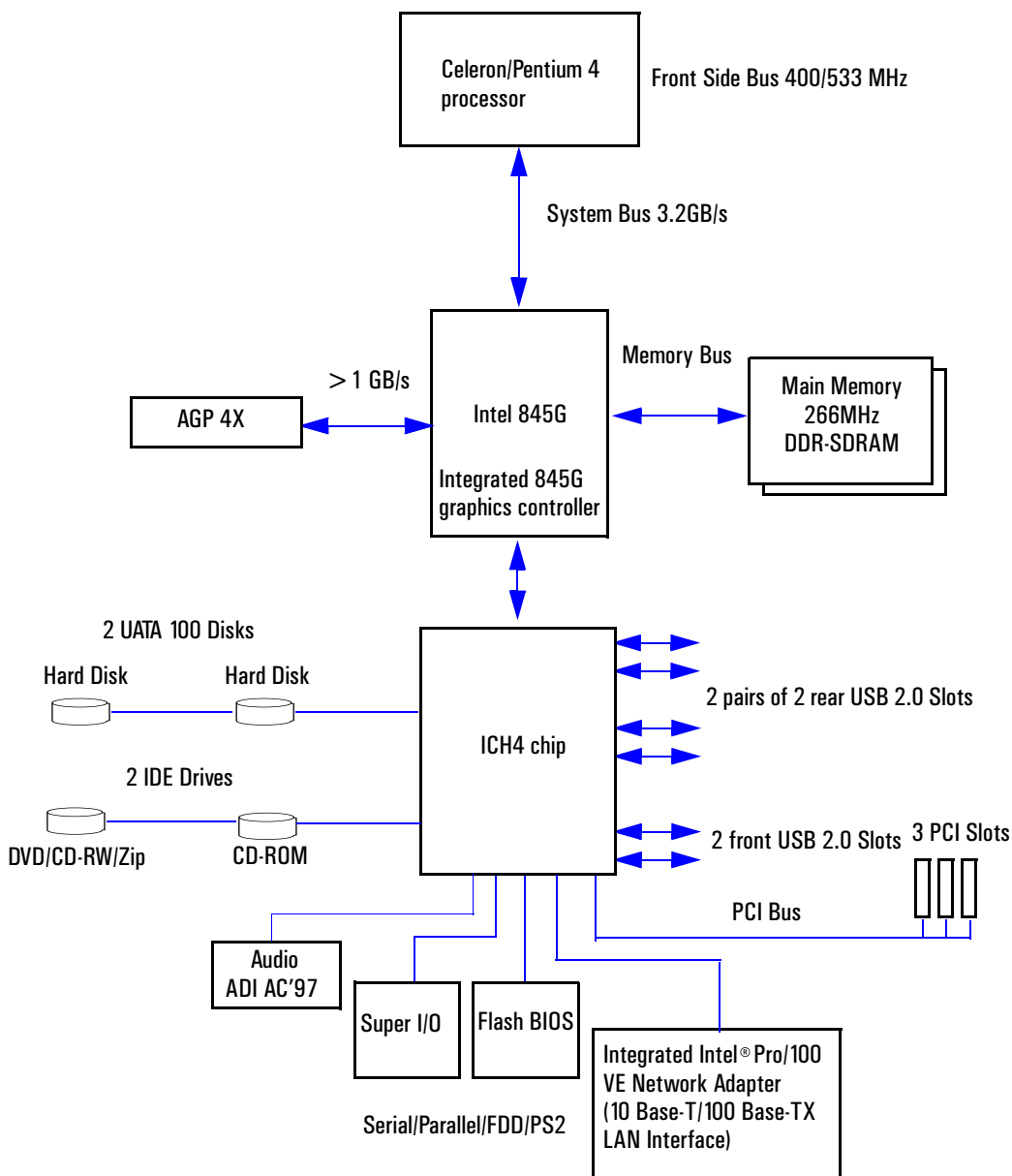

## Processor

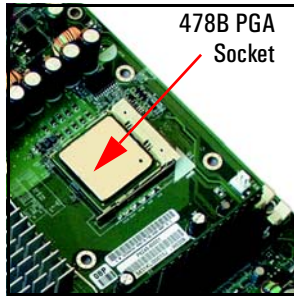

The Compaq Evo D310 Micro Desktop is equipped with either a socket 478B Intel Celeron or Pentium 4 processor. The processor is connected to the system board through a Pin Grid Array (PGA) 478B Socket.

A heatsink and fan (not shown) cover the processor to prevent it from overheating. If the heatsink is removed, the thermal interface material between the heatsink and the processor must be replaced by a new one. If no thermal interface is used or the old one is re-used, then cooling may be impaired and the processor damaged.

### Intel Pentium 4 (Socket 478)

The Intel Pentium 4 processor has the following features:

- Speeds ranging upto 2.4GHz
- Data bus frequency of 400MHz
- Dual Independent Bus architecture, which combines a dedicated 64-bit L2 cache bus (supporting 256KB or 512KB) plus a 64-bit system bus that enables multiple simultaneous transactions
- MMX2 technology, which gives higher performance for media, communications and 3D applications
- Dynamic execution to speed up software performance
- Internet Streaming SIMD Extensions 2 (SSE2) for enhanced floating point and 3D application performance
- Uses multiple low-power states, such as AutoHALT, Stop-Grant, Sleep and Deep Sleep to conserve power during idle times.

The Pentium 4 processor is packaged in a pin grid array (PGA) that fits into a PGA478B socket. The Pentium 4 integrates the following cache memories on the same die as the processor cache:

- A trace instruction and L1 data cache. The trace cache is 4-way set associative
- A 256KB or 512KB L2 cache. The L2 cache is 8-way associative.

### Intel Celeron (Socket 478)

The “new” Celeron (socket 478) processor is based on the Pentium 4 architecture. It is supported by the Intel 845GL chipset. The “new” Celeron processor also features the following:

- Processor speeds ranging from 1.7 to 1.8GHz
- Front side bus 400MHz
- 128K cache.

## Main Memory

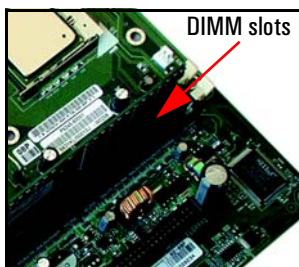

There are two memory module slots on the system board for installing main memory. You can install 266MHz DDR-SDRAM modules, these are available in 128, 256 and 512MB memory modules. You can install a maximum of 1GB (2 x 512MB modules).

You can only use non-ECC memory modules.

Short for Double Data Rate-Synchronous DRAM, DDR-SDRAM is a type of SDRAM that supports data transfers on both edges of each clock cycle, effectively doubling the memory chip's data throughput. DDR-SDRAM also consumes less power. DDR-SDRAM is also called SDRAM II.

While the new memory module is clocked at the same speed as normal SDRAM, it is able to transport double the amount of data by using the rising as well as falling edge of the clock signal for data transfers. DDR-SDRAM has another important enhancement over SDRAM. Its voltage supply uses only 2.5 V, instead of 3.3 V. This and the lower capacities inside the memory chips lead to significantly reduced power consumption.

DDR-SDRAM DIMMs are not compatible with SDRAM DIMMs. The new DDR-DIMMs come with 184 instead of the 168 pins used by SDRAM-DIMMs. The module itself looks almost identical to SDRAM, but it has only one notch on its connector surface instead of the two notches found on SDRAM-DIMMs.

## Accessory Board Slots

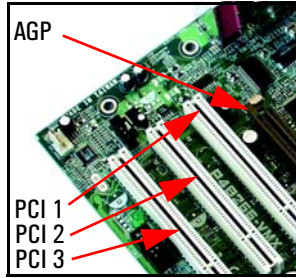

The Compaq Evo D310 Micro Desktop has four accessory board slots: three PCI slots and one 1.5V AGP slot.

The PCI slots are PCI 2.2 compliant and each slot supports a maximum total current of 375 mA.

An optional graphics card can be installed in the AGP slot. The 1.5V AGP slot is backward compatible with AGP 1x, 2x and 4x modes. A latch on one end of the AGP slot locks the graphics card in place.

## PCI Slot Numbers

Your PC uses logical slot numbers in the BIOS *Setup* program. You need to know these logical slot numbers if you want to change the PCI slot configuration in the *Setup* program.

Compaq Evo D310 Micro Desktop PCI Mapping Table			
Bus	Device	PCI Device	Slot#
0	0	MCH: Host bridge	Not Applicable
0	2	MCH: AGP bridge	Not Applicable
0	30	ICH: Hub interface to PCI bridge	Not Applicable
0	31	ICH: PCI to LPC bridge	Not Applicable
0	31	ICH: IDE controller	Not Applicable
0	31	ICH: USB controller	Not Applicable
0	31	ICH: SMBUS controller	Not Applicable
0	31	ICH: AC97 audio controller	Not Applicable
2	9	PCI slot 1	1
2	10	PCI slot 2	2
2	11	PCI slot 3	3
1	0	AGP device	AGP slot
1	8	LAN controller	Embedded

## System Board Switches

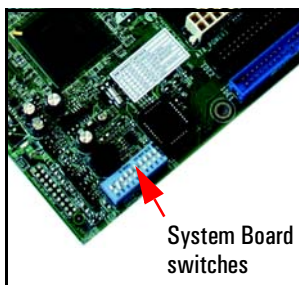

The following table gives the functionality and default position of switches on the system board switch block:

Switch	Default Position	Function
1-4	OFF	Reserved
5	OFF	ON = Clear CMOS
6	OFF	ON = Clear Password
7	OFF	ON = BIOS crisis mode recovery
8	OFF	Not used
9	ON	OFF = Boot block FLASH protect
10	OFF	Not used

## Hard Disk Drives

A 3.5-inch hard disk drive is supplied on an internal shelf in some models. These hard drives can be provided with the PC. To see which other hard disk drives can be purchased as accessories for the Compaq Evo D310 Micro Desktop, refer to [www.hp.com/go/pccessories](http://www.hp.com/go/pccessories).

	20GB Ultra ATA 100	20GB Ultra ATA 100	40GB Ultra ATA 100	80GB Ultra ATA 100
<b>Average Seek Time (ms)</b>	8.9 to 12.1	8.5 to 8.9		9.5
<b>Track-to-Track Seek Time (ms)</b>	1.5	1.2		0.95
<b>Full Stroke Seek Time (ms)</b>	20 to 25	15		-
<b>Rotational Speed (RPM)</b>	5400	7200		7200
<b>Buffer Size (MB)</b>	2	2		2

### Ultra-ATA/100 Hard Disk Drives

ATA (AT Attachment) is a disk drive implementation designed to integrate the controller into the drive itself, thereby reducing interface costs, ATA is also known as IDE (Integrated Drive Electronics).

Ultra ATA/100 is the latest generation of the ATA interface, it increases burst data rates significantly over previous versions of the protocol. Also known as Ultra DMA/100 and Feature ATA, Ultra ATA/100 allows host computers to send and receive data at 100MB/s. The result is maximum disk performance under PCI local bus environments.

At its fast burst data rates, Ultra ATA/100 removes bottlenecks associated with data transfers, especially during sequential operations. Ultra ATA/100 also delivers heightened data integrity to the EIDE interface through use of a 40-pin 80-conductor cable, and CRC (Cyclic Redundancy Check) error detection code. The 80-conductor cable reduces crosstalk and improves signal integrity by providing 40 additional ground lines between the 40-pin IDE signal and ground lines. The connector is plug-compatible with existing 40-pin headers, and the incremental cost for the cable should be minimal.

By increasing the burst transfer rates of IDE drives, Ultra ATA/100 brings the effective transfer rate of the system's bus and a drive's internal data rate that much closer into balance. Ultra ATA/100 allows greater system throughput, particularly for long sequential transfers required by audio/visual applications.

Ultra ATA/100 hard drives are 100 percent backwards compatible with Ultra ATA/66, Ultra ATA/33, and DMA, as well as with existing EIDE/IDE hard drives, CD-ROM drives, and host systems.

#### NOTE

S.M.A.R.T. or Self Monitoring Analysis and Reporting Technology allows the hard disk drive to report certain types of degradation or impending failure. This allows the operating system to take the necessary precautions and warn the user. The system is comprised of software that resides both on the disk drive and on the host computer. The disk drive software monitors the internal performance of the motors, media, heads, and electronics of the drive, while the host software monitors the overall reliability status of the drive. The reliability status is determined through the analysis of the drive's internal performance level and the comparison of internal performance levels to predetermined threshold limits.

## Floppy Disk Drives

All models are supplied with a 3.5-inch floppy disk drive.



## Optical Drives

The Compaq Evo D310 Micro Desktop is available with a choice of optical drives:

- CD-RW drive: 40X, 10X, 40X IDE (DLA and MyCD software from Veritas included)
- DVD-ROM drive: 16X, 40X IDE (WinDVD MPEG2 decoding software from InterVideo included)
- CD-ROM drive: 48X IDE.

These drives can also be purchased as accessories. Refer to [www.hp.com/go/pcaccessories](http://www.hp.com/go/pcaccessories).

### Features of the CD-RW Drive

- Supported CD-ROM formats:
  - CD-ROM Mode-1 data disc
  - CD-ROM Mode-2 data disc
  - CD-ROM XA
  - CD Audio disc
  - Video CD
  - CD-I
  - CD-I Ready
  - CD-I Bridge
  - CD-WO
  - Enhanced Music CD (CD Plus)
  - Photo CD Multi-session.
- Interface type: E-IDE/ATAPI.

	Description
Data Transfer Rate (1 KB = 2 <sup>10</sup> byte = 1,024 bytes)	Sustained Data Transfer Rate
(1 MB = 2 <sup>20</sup> byte = 1,048,576 bytes)	Writing CD-RW - 40X = 6,000 KB/s (Max)
	Writing CD-R - 10X = 1,500 KB/s (Max)
	Reading - 40X = 6,000 KB/s (Max)

### CD-RW Technology

CD-RW drives use a technology known as optical phase-change. It does not use magnetic fields like the phase-change technology used with magneto-optical technology. The media are generally distinguishable from CD-R discs by their metallic grey color. The basic structure of the discs, however, is the same as a CD-R disc but with significant detail differences. A CD-RW disc's phase-change medium consists of a polycarbonate substrate, moulded with a spiral groove for servo guidance, absolute time information and other data, on to which a stack (usually five layers) is deposited. The recording layer is sandwiched between dielectric layers that draw excess heat from the phase-change layer during the writing process. In place of the dye-based recording layer on a CD-R disc, CD-RW commonly uses a crystalline compound made up of a mix of silver, indium, antimony and tellurium. This mix, when heated to a certain temperature and then cooled becomes crystalline, but if heated to a higher temperature it becomes amorphous when it cools down again. The crystalline areas allow the metallized layer to reflect the laser light better while the non-crystalline portion absorbs the laser beam, and is therefore not reflected.

CD-RW devices use three different laser powers to achieve these effects in the recording layer:

- the highest, called 'Write Power', creates a non-crystalline (absorptive) state on the recording layer
- the medium, 'Erase Power', melts the recording layer and converts it to a reflective crystalline state
- the lowest, 'Read Power', does not alter the state of the recording layer, so it can be used for reading the data.

During writing, a focused 'Write Power' laser beam selectively heats areas of the phase-change material above the melting temperature (500-700° C), so all the atoms in this area can move rapidly in the liquid state. Then, if cooled sufficiently quickly, the random liquid state is 'frozen-in' and the so-called amorphous state is obtained. The amorphous version of the material shrinks, leaving a pit where the laser dot was written, resulting in a recognizable CD surface. When an 'Erase Power' laser beam heats the phase-change layer to below the melting temperature but above the crystallization temperature (200° C) for a sufficient time (at least longer than the minimum crystallization time), the atoms revert back to an ordered state (the crystalline state). Writing takes place in a single pass of the focused laser beam, sometimes referred to as 'direct overwriting' and the process can be repeated several thousand times per disc.

Once the data has been burned the amorphous areas reflect less light, enabling a 'Read Power' laser beam to detect the difference between the lands and the pits on the disc. One compromise here is that the disc reflects less light than CD-ROMs or CD-Rs and consequently CD-RW discs can only be read on CD players that support the new MultiRead specification.

CD-RW drives are dual-function, offering both CD-R and CD-RW recording, so the user can choose the best media for a particular job.

Although UDF (Universal Disc Format) allows users to drag and drop files to discs, CD-RW is still not as easy to use as a hard disk. Initially limitations in the UDF standard and associated driver software meant that when data was deleted from a CD-RW, those areas of the disc were merely marked for deletion and were not immediately accessible. A disc could be used until all its capacity was used, but then the entire disc had to be erased to reclaim its storage space using a 'sequential erase' function. In hardware terms erasing a disk is accomplished by heating up the surface to a lower temperature, but for a longer time, which returns it to the crystalline state.

Evolution of the UDF standard and developments in associated driver software have improved things considerably, making CD-RW more like hard drives or floppy disks.

## Features of the DVD-ROM Drive

- Supported CD-ROM formats:
  - CD-ROM Mode 1 and 2 data disc
  - Photo-CD Multisession
  - CD Audio disc
  - Mixed mode CD-ROM disc (data and audio)
  - CD-ROM XA
  - CD-I
  - CD-Extra
  - CD-R
  - CD-RW

- Supported DVD-ROM formats:
  - DVD-ROM
  - DVD-R (4.7GB/3.9GB)
  - DVD-RW
  - DVD + RW.
- Interface: E-IDE/ATAPI, Support Ultra DMA 66.

	Description
Data Capacity: Capacity DVD-ROM	Up to 8.5 GB/side
Capacity DVD-RAM	4.7 GB/side
Capacity DVD-R	4.7 GB/side
Capacity CD	650 MB
Data Transfer Rate	16X (maximum) DVD 40X (maximum) CD-ROM
Loading Type	Motorized tray
Access Time	120 ms (DVD) 90 ms (CD-ROM)
Buffer Memory Size	512 KB
Acoustic Noise	52 dB
Rotational Speed	Approx. Variable (Approx 7,300 rpm max.)

**NOTE**

If a disk is still in the drive after power failure or drive failure, the disk can be reclaimed by inserting a straightened paper-clip into the small hole at the bottom of the door.

### Digital Versatile Disk (DVD) Technology

Digital Versatile Disc (DVD) is a medium for the distribution of from 4.7 to 17GB of digital data on a 120-mm (4.75 inch) disc. This huge volume of data (CD-ROMs can store 680MB) can be used to store up to nine hours of studio quality video and multi-channel surround-sound audio, highly interactive multimedia computer programs, 30 hours of CD-quality audio, or anything else that can be represented as digital data.

A DVD looks like a CD-ROM: it is a silvery disc, 4.75 inches in diameter, with a hole in the center. Like a CD, data is recorded on the disc in a spiral trail of tiny pits, and the discs are read using a laser beam. The DVD's larger capacity is achieved by making the pits smaller and the spiral tighter, and by recording the data in as many as four layers, two on each side of the disc.

To read these tightly packed discs, lasers that produce a shorter wavelength beam of light are required, as are more accurate aiming and focusing mechanisms. In fact, the focusing mechanism is the technology that allows data to be recorded on two layers. To read the second layer, the reader simply focuses the laser a little deeper into the disc, where the second layer of data is recorded.

Not only are two layer discs possible, but so are double-sided discs. The availability of four layers is what gives DVD its 17GB capacity.

	DVD	CD
<b>Diameter</b>	120mm	120mm
<b>Thickness</b>	0.6mm	1.2mm
<b>Track Pitch</b>	0.74nm	1.6nm
<b>Minimum Pit Length</b>	0.40nm	0.834nm
<b>Laser Wavelength</b>	640nm	780nm
<b>Data Capacity (per layer)</b>	4.7GB	0.68GB
<b>Layers</b>	1,2,4	1

### Audio features of DVD-Video

A DVD-Video disc can have up to 8 audio tracks (streams). Each track can be in one of three formats:

- Dolby Digital (Dolby AC-3): 1 to 5.1 channels
- MPEG-2 audio: 1 to 5.1 or 7.1 channels
- LPCM: 1 to 8 channels.

Dolby Digital is multi-channel digital audio, using lossy AC-3 coding technology from original PCM with a sample rate of 48 kHz at up to 24 bits. The bitrate is 64 kbps to 448 kbps, with 384 being the normal rate for 5.1 channels and 192 being the normal rate for stereo (with or without surround encoding).

MPEG audio is multi-channel digital audio, using lossy compression from original PCM format with sample rate of 48 kHz at 16 bits. Both MPEG-1 and MPEG-2 formats are supported. The variable bitrate is 32 kbps to 912 kbps, with 384 being the normal average rate. MPEG-1 is limited to 384 kbps.

Linear PCM is uncompressed (lossless) digital audio, the same format used on CDs and most studio masters. It can be sampled at 48 or 96 kHz with 16, 20, or 24 bits/sample. (Audio CD is limited to 44.1 kHz at 16 bits.) There can be from 1 to 8 channels. The maximum bitrate is 6.144MBps.

### DVD Region Codes

After setting the DVD region (by playing a DVD video for the first time), the DVD region can be changed a further four times; after that the DVD drive will only play DVD videos from the last DVD region that was set.

Regional Codes	Region
1	USA & Canada
2	Europe (excluding former USSR countries), Japan, Near East (including Iran and Egypt), South Africa
3	South East Asia, South Korea
4	Latin America & Oceania (Australia, New Zealand)
5	Africa (excluding Egypt and South Africa), Eastern European countries, Sub-Indian continent
6	China

## Features of the CD-ROM Drive

- Supported CD-ROM formats:
  - CD-ROM Mode 1 and 2 data disc
  - Photo-CD Multisession
  - CD Audio disc
  - Mixed mode CD-ROM disc (data and audio)
  - CD-ROM XA
  - CD-I, CD-Extra, CD-R, CD-RW.
- Interface: E-IDE/ATAPI.

	Description
Loading Type	Motorized tray
Data Transfer Rate	Outer side 7,200 KB/s (48x)
Access Time	Average stroke (1 / 3) 110ms Full Stroke 180ms
Buffer Memory Size	128KB
Rotational Speed	Approx. 11,100 rpm maximum

## Graphics

The Compaq Evo D310 Micro Desktop has an Integrated Intel graphics solution. It also has an AGP slot where an ATI Radeon 7000 or ATI Radeon 7500 graphics card can be installed:

### Intel 845G Chipset Integrated Graphics

The Intel 845G chipset offers integrated graphics with Dynamic Video Memory Technology (DVMT). Some memory (8MB) is reserved at boot time from the main memory; further memory is allocated as needed.

#### Key Features

- **Dynamic Video Memory Technology:** Ensures most efficient system memory usage for optimal 2D/3D graphics and system performance
- **Zone Rendering Technology:** Significantly reduces the memory bandwidth by up to 11x which results in much higher 3D performance
- **Tiled Memory Addressing:** Performs Address Remapping in hardware for all graphics surfaces which increases page coherency and improves memory efficiency
- **Dynamic Multi-Context Switcher:** Provides deeply pipelined operations in both 2D and 3D allowing overlapping operations with no need to flush between modes of operation
- **Intelligent Memory Manager:** Fourth generation UMA Memory Manager that provides faster accesses, adequate burst sizes and smart page closing policies
- **4x Blit Engine for 2D operations:** 256 bit wide Blitter fills at a much greater rate than memory bandwidth which speeds up operations like drop down menus
- **Deep Display Buffers:** Buffer for screen refreshes which enables higher system performance by reducing the CPU latency as well as decreasing the total transactions handled by the CPU
- **Non-blocking and multi-tier cache structures:** Dedicated internal caches for textures, colors, Z and vertices which significantly reduces memory bandwidth and improves core performance
- **Single-Pass Quad Texture Support:** Supports up to blending operations for up to four textures in a single pass which reduces memory bandwidth requirements and CPU loading
- **Texture Decompression:** Provide up to 8x compression and consequent reduction in bandwidth and footprint.

#### Memory Usage with Dynamic Video Memory Technology

At boot time the system BIOS dedicates 8MB of system memory for graphics display. When more memory is needed the Intel 845 graphics driver submits a request to the operating system, the operating system grants the request based upon available system memory. When the application is closed, the OS will reallocate system memory back for generic use. The quantity of additional memory which can be allocated for video by the operating system is limited, the limit depends on the quantity of memory installed on the system and on the driver version (the latest drivers can be downloaded from the web).

The quantity of system memory allocated by the BIOS and the maximum limit cannot be modified by the user.

## ATI Radeon 7000

The ATI Radeon 7000 graphics card is powered by the Radeon 7000 graphics processor and 32MB of DDR-SDRAM memory; Radeon 7000 features HYPER Z technology to increase effective memory bandwidth and PIXEL TAPESTRY for fast image rendering. It also has industry leading, built-in DVD playback capability.

### Key Features

- Powered by the Radeon 7000 graphics processor
- ATI HYPER Z technology reduces memory bandwidth consumption resulting in improved 3D performance
- Powerful 3D graphics performance with ATI PIXEL TAPESTRY 3D rendering engine
- DVD playback with integrated motion compensation and iDCT
- Supports 3D resolutions (32-bit color) up to 2048x1536
- Excellent 3D quality
- High resolution 2D graphics
- Radeon 7000, with powerful double data rate memory, delivers enhanced 3D and 2D performance
- PIXEL TAPESTRY, the Radeon 7000 rendering engine, powers 1.6 gigatexels/ second for high fill rates in 32-bit at high resolutions.
- Supports DirectX and OpenGL allowing for superior graphics and 3D textures
- Features VIDEO IMMERSION technology for industry leading video playback
- Process full-frame rate, full-screen DVD or MPEG-2 video
- Built-in DVD playback saves the expense of buying a separate MPEG-2/DVD decoder card

### Supported Resolutions

The following 2D resolutions and refresh rates are supported:

Resolutions	Refresh Rates (256, 65K and 16.7M colors)
640x480	200 Hz
800x600	200 Hz
1024x768	200 Hz
1152x864	160 Hz
1280x1024	120 Hz
1600x1200	100 Hz
1920x1080	90 Hz
1920x1200	90 Hz
1920x1440	75 Hz
2048x1536	60 Hz

Maximum 3D resolutions are as follows:

65K colors	1920x1440
16.7M colors	1920x1200

## ATI Radeon 7500

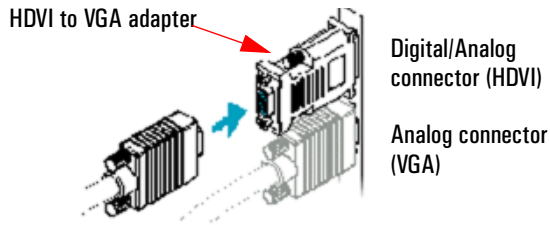

The ATI Radeon 7500 graphics card is powered by the Radeon 7500 GPU and 64MB of DDR-SDRAM memory providing high performance acceleration of 3D graphic applications. Its dual head provides one VGA output (analog) and one HDVI output (Digital for Flat panel). The HDVI connector can be converted to a classical VGA by adding an external converter.

### Key Features

- Dual monitor and video output support
- 64MB DDR memory accelerates the latest 3D and 2D games and applications
- HYPERZ increases graphics memory bandwidth
- VIDEO IMMERSION for industry-leading DVD playback
- High-resolution 32-bit 3D graphics up to 2048x1536
- Powered by the Radeon 7500 GPU and 64MB DDR-SDRAM memory for advanced 3D graphics
- Delivers immersive, realistic 32-bit color graphics without PC performance decline
- Full support of DirectX and OpenGL applications
- PIXEL TAPESTRY, the Radeon 7500 rendering engine, powers 1.74 gigatexels/second for the highest fill rates in 32-bit at high resolutions
- Process full-frame rate, full-screen DVD or MPEG-2 video
- Hardware DVD saves the expense of buying a separate MPEG-2/DVD decoder card
- Motion compensation and iDCT allow for DVD decoding with minimum CPU usage

### Supported Resolutions

The following 2D resolutions and refresh rates are supported:

Resolutions	Refresh Rates (256, 65K and 16.7M colors)
640x480	200 Hz
800x600	200 Hz
1024x768	200 Hz
1152x864	100 Hz
1280x1024	160 Hz
1600x1200	120 Hz
1920x1080	100 Hz
1920x1200	100 Hz
1920x1440	85 Hz
2048x1536	75 Hz

Maximum 3D resolutions are as follows:

65K colors	2048x1536
16.7M colors	2048x1536



## Audio

The audio solution on the Compaq Evo D310 Micro Desktop is the Integrated Analog Devices AD1981A AC'97 SoundMAX CODEC. The AD1981A interfaces directly with the South Bridge chip and performs all digital operations, such as sample rate conversions and synthesis, as well as mixing and processing the analog signals.

All models have a Line In jack, Line Out jack and Microphone In jack connector located on the rear panel. These external jacks are standard connectors.

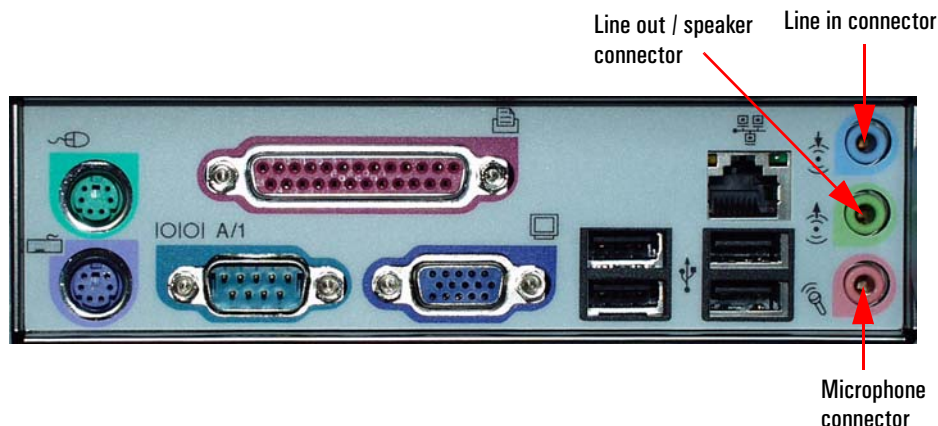

### Analog Devices AD1981A

Feature of the AD1981A include:

- S/PDIF output, 20 bits data format, supporting 48 kHz, 44.1 kHz and 32 kHz
- Integrated stereo headphone amplifier
- Variable sample rate audio
- External audio power down control
- Greater than 90 dB dynamic range
- 16 bit stereo full duplex CODEC
- 20 bit resolution output DACs
- Three analog line level stereo inputs for: line in, AUX and CD
- Mono line level phone input
- Mono MIC input with built in programmable pre-amp
- High quality CD input with ground sense
- Mono output for speakerphone or internal speaker
- Power management support.

Other Enhanced Features include:

- Built in digital equalizer function for optimized speaker sound
- Full duplex variable sample rates from 7040 Hz to 48 kHz with 1 Hz resolution
- Multiple CODEC configuration options.

# LAN Controller

The Compaq Evo D310 Micro Desktop has an Integrated LAN controller, either an Intel Pro/100 VE Network Adapter (10 Base-T/100 Base-TX LAN Interface) or a 3COM LAN controller.

If you install a LAN card, integrated LAN is not automatically disabled. However you can disable the integrated LAN controller in the PC's *Setup* program.

The Intel LAN boot ROM setup can be launched by pressing **CTRL-S** while booting your PC.

<b>3COM LAN Controller Features</b>	
<b>LAN Interface</b>	<ul style="list-style-type: none"> <li>● 32 bits PCI 10 Base-T/100 Base-TX</li> <li>● RJ 45 LAN port</li> </ul>
<b>Power Management</b>	<ul style="list-style-type: none"> <li>● RPO (Remote Power-On) and RWU (Remote Wake-Up) for APM Windows 95 and Windows 98 (SR # 1 only), Windows NT 4.0; RWU for ACPI Windows 98SE and Windows 2000</li> <li>● On Now 1.0; APM 1.2; ACPI 1.0</li> <li>● PCI Power Management 1.1, PCI 2.2</li> </ul>
<b>Manageability</b>	<ul style="list-style-type: none"> <li>● DMI 2.0 Component Code</li> <li>● WfM 2.0 Bootrom</li> </ul>
<b>Diagnostics</b>	<ul style="list-style-type: none"> <li>● Production Diag</li> <li>● MAC address DOS report tool</li> <li>● User Diag for MS-DOS, Windows 95, Windows 98 and Windows NT 4.0</li> </ul>
<b>Drivers</b>	Windows 2000, Windows 95, Windows 98, Windows NT 4.0, Novell support
<b>Specifications</b>	
<b>Network Interface</b>	<ul style="list-style-type: none"> <li>● 10 Mbps Ethernet 10BASE-T: Ethernet IEEE 802.3 industry standard for a 10 Mbps baseband CSMA/CD local area network.</li> <li>● 100 Mbps Ethernet 100BASE-TX: Ethernet IEEE 802.3u industry standard for a 100 Mbps baseband CSMA/CD local area network.</li> </ul>

<b>Intel PRO 100 VE Network Adapter Features</b>	
<b>LAN Interface</b>	<ul style="list-style-type: none"> <li>● 32 bits PCI 10 Base-T/100 Base-TX</li> <li>● RJ 45 LAN port</li> </ul>
<b>Power Management</b>	<ul style="list-style-type: none"> <li>● RPO (Remote Power-On) for Windows 98SE, Windows NT 4.0, Windows 2000, Windows XP.</li> <li>● RWU (Remote Wake-Up) for Windows 98SE, Windows 2000, Windows XP</li> <li>● On Now ACPI 1.0b</li> <li>● PCI Power Management 1.1, PCI 2.2</li> </ul>
<b>Manageability</b>	<ul style="list-style-type: none"> <li>● DMI 2.0 Component Code</li> <li>● WfM 2.0, PXE 2.1 and RPL2.73 boot on LAN</li> </ul>
<b>Diagnostics</b>	<ul style="list-style-type: none"> <li>● Production Diag</li> <li>● MAC address DOS report tool</li> <li>● User Diag for MS-DOS and Windows NT 4.0</li> </ul>
<b>Drivers</b>	Windows XP, Windows 2000, Windows 98, Windows NT 4.0, Novell support
<b>Specifications</b>	
<b>Network Interface</b>	<ul style="list-style-type: none"> <li>● 10 Mbps Ethernet 10BASE-T: Ethernet IEEE 802.3 industry standard for a 10 Mbps baseband CSMA/CD local area network.</li> <li>● 100 Mbps Ethernet 100BASE-TX: Ethernet IEEE 802.3u industry standard for a 100 Mbps baseband CSMA/CD local area network.</li> </ul>

## LAN Connector

The 10 Base-T/100 Base-TX LAN connector is located on the rear of the PC.

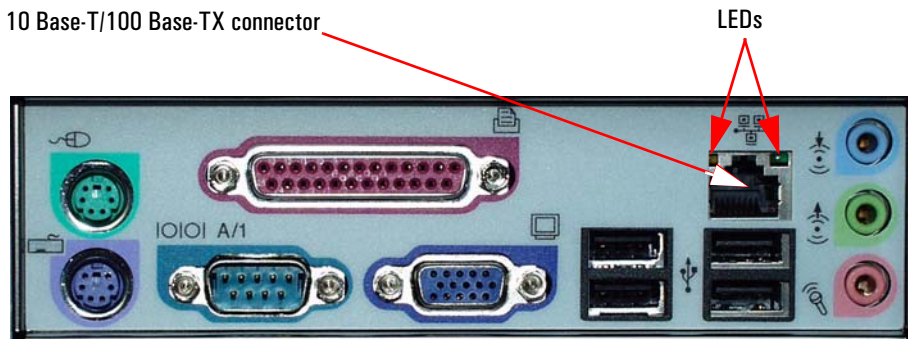

There are two LEDs on the 10 Base-T/100 Base-TX connector as indicated in the graphic above. The following table provides a status summary of these LEDs:

LED	Description	Status		
		Flashing	On	Off
Green	Speed LED	N/A	100 Base-TX connection between NIC and hub	10 Base-T connection between NIC and hub
Yellow	Link Integrity and Activity LED	Link integrity OK and network traffic present	Link integrity OK and no network traffic	No connection between NIC and hub

## USB 2.0 Connectors

The Compaq Evo D310 Micro Desktop features 6 USB 2.0 connectors (4 rear and 2 front).

USB 2.0 extends the speed of the connection from 12 Mbps on USB 1.1 to 480 Mbps on USB 2.0, providing an attachment point for next-generation peripherals for use with higher performance PCs and user applications. USB 2.0 is both forwards and backwards compatible with USB 1.1 and uses the same cables and connectors as USB 1.1. Externally USB 2.0 system looks no different from a USB 1.1 system.

USB 1.1's data rate of 12 Mbps is sufficient for many PC peripherals. These peripherals will continue to operate with no change in USB 2.0 systems. The higher bandwidth of USB 2.0 permits the use of PC peripherals with wider functionality. The higher bandwidth supports the most demanding PC user applications, where multiple high-speed peripherals are running simultaneously. When using a USB hub it is important to make sure that you use a USB 2.0 compliant hub.

USB 2.0 drivers are not preloaded on the software image, they can be downloaded from HP's Support web site at: [www.hp.com/go/support](http://www.hp.com/go/support).

---

## Serviceability

This chapter introduces the enhanced serviceability features of the Compaq Evo D310 Micro Desktop PC. It shows how easily you can open the PC and remove or add system components using the serviceability features developed for these PC models.

For further service information refer to the motherboard serviceability label delivered with your PC.

# Evo D310 Micro Desktop

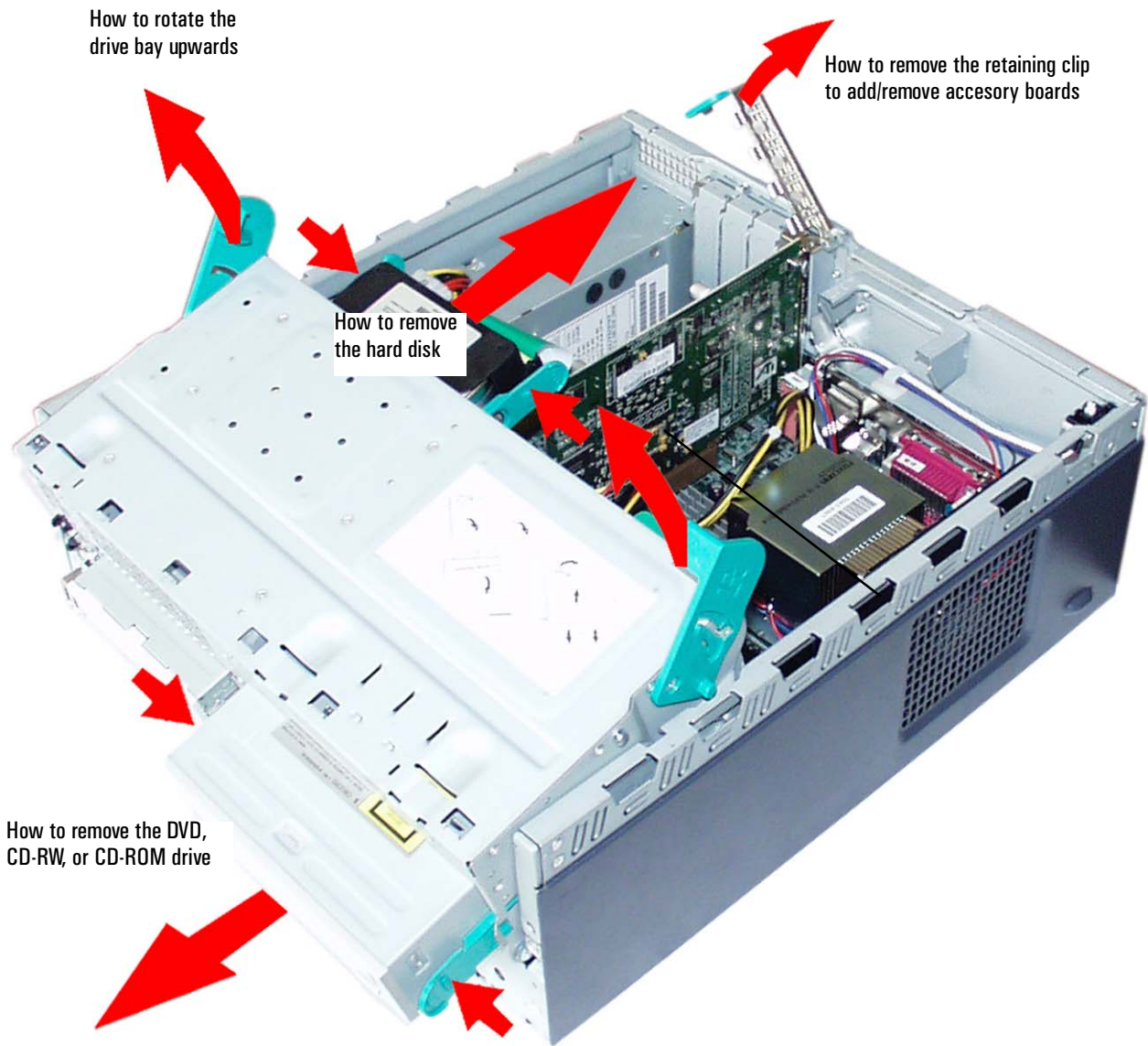

## — BIOS Overview

This chapter describes the BIOS features of the Compaq Evo D310 Micro Desktop PC.

## BIOS Summary

The Compaq Evo D310 Micro Desktop PC BIOS (Basic Input Output System) is based on the American Megatrends Inc. (AMI) core 7.00T. The system ROM contains the POST (power-on self-test) routines, and the BIOS: the System BIOS, video BIOS, and Intel LAN boot ROM.

The system BIOS is identified by the version number **JH.01.yy**.

The latest BIOS version for your PC and instructions for updating the BIOS can be downloaded from the support Web site at: [www.hp.com/go/support](http://www.hp.com/go/support).

This section covers:

- The BIOS Setup program
- Power saving
- BIOS addresses
- POST tests
- Beep codes.

## Entering the Configuration and Diagnostics menu

To enter the **Configuration and Diagnostics** menu on your Evo D310 PC, restart the computer and keep **F8** pressed. The **Configuration and Diagnostics** menu displays the default order of devices the PC will start (boot) from. This order can be modified in the boot menu of the *Setup* program, see “Using the Setup Program” below. The standard boot order is as follows: CD-ROM, Hard Disk Drive, LAN and Floppy Drive.

Press **F12** to boot (start) on the network. This option will only work if your PC and the network is configured correctly.

Alternatively, press **Esc** to view the summary configuration screen. By default, this remains on the screen for 20 seconds, but by pressing the **Pause** key once, it can be held on the screen indefinitely until any key is pressed.

Press **F10** to run the Diagnostics tool.



## Using the PC Setup Program

In the **Configuration and Diagnostics** menu press **F2** to run the *Setup* program.

The *Setup* screen comprises six menus: **Main**, **Advanced**, **Security**, **Boot**, **Power** and **Exit**. These are selected using the left and right arrow keys.

A list of the menus and submenus in the *Setup* screen is given below. See *Setup Help* for a description of each field.

### Main Menu

The **Main** menu is comprised of the following fields:

- Date
- Time
- BIOS Version
- Plug & Play O/S
- Reset Configuration Data

### Advanced Menu

The **Advanced** menu is comprised of the following fields:

- Spread Spectrum
- Processor and Cache Options
- Flexible Disk Drive
- IDE Devices
- Integrated USB Interface
- Integrated I/O Ports
- Integrated Audio Interface
- Integrated Network Interface
- PCI Configuration

### Security Menu

The **Security** menu is comprised of the following fields:

- User and Administrator Passwords
- Hardware Protection
- Boot Device Security

### Boot Menu

The **Boot** menu is comprised of the following fields:

- Quick Boot Mode
- Boot-Time Diagnostic Screen
- Display Option ROM Message
- Boot on LAN after RPO
- Boot Device Priority

### Power Menu

The **Power** menu is comprised of the following fields:

- State After Power Failure
- Power-up on PCI Bus Activity
- Advanced Power Management

### Exit Menu

The **Exit** menu is comprised of the following fields:

- Exit Saving Changed
- Exit Without Saving Changes
- Load Default Settings

## Power Management and Wake Up Events

You can reduce the PC's overall power consumption by using Power Management to slow down the PC's activity when it is idle.

### ACPI Power Management Modes (Windows 98, Windows 2000 and Windows XP)

- Idle (s1):  
The processor is shutdown.
- Standby (s3):  
All components of the system are shut down except for the system memory which remains active. This management mode is also known as "Suspend to RAM".
- Hibernation (s4):  
System memory is copied to the hard disk. All components of the system are shut down. This management mode is also known as "Suspend to Disk".
- Off (s5):  
All components of the system are shut down.

The following table lists the possible Wake Up Events for the different power management modes, activity on any one of these events will cause the system to wake up from it's current power state:

Power State	Wake Up Event	
	Windows 98	Windows 2000/XP
s1 (Idle) s3 (Standby/Suspend to RAM)	RTC (Real Time Clock) LAN RI# (Ring Indicator) USB PS/2 Keyboard Power Button	
s4 (Hibernation/Suspend to Disk)	Not Applicable	RTC (Real Time Clock) LAN RI# (Ring Indicator) USB Power Button
s5 (Off)	Power Button	LAN Power Button

## BIOS Addresses

This section provides a summary of the main features of the HP system BIOS.

### System Memory Map

Reserved memory used by accessory boards must be located in the area from C8000h to EFFFFh.

0000 0000 - 0000 03FF	Real-mode IDT
0000 0400 - 0000 04FF	BIOS Data Area
0000 0500 - 0009 FC00	Used by OS
0009 FC00 - 0009 FFFF	Extended BIOS Data Area
000A_0000 - 000B_FFFF	Video RAM or SMRAM (not visible unless in SMM)
000C 0000 - 000C 7FFF	Video ROM
000C 8000 - 000E 0000	Adapter ROM, RAM, memory-mapped registers
000E 0000 - 000F FFFF	System BIOS (Flash/Shadow)
10 0000 - FF FFFF	Memory (1MB to 16MB)
100 0000 - 1FF FFFF	Memory (16MB to 32MB)
200 0000 - 3FF FFFF	Memory (32MB to 64MB)
400 0000 - 1FFF FFFF	Memory (64MB to 512MB) <sup>1</sup>
FFF80000 - FFFF FFFF	512KB BIOS (Flash)

1. The last MB of memory in this area is used as Unified Memory Architecture (UMA) embedded memory.

### HP I/O Port Map (I/O Addresses Used by the System)

Peripheral devices, accessory devices and system controllers are accessed via the system I/O space, which is not located in system memory space. The 64KB of addressable I/O space comprises 8-bit and 16-bit registers (called I/O ports) located in the various system components. When installing an accessory board, ensure that the I/O address space selected is in the free area of the space reserved for accessory boards (100h to 3FFh).

Although the *Setup* program can be used to change some of the settings, the following address map is not completely BIOS dependent, but is determined partly by the operating system. Note that some of the I/O addresses are allocated dynamically.

I/O Address Ports	Function
0000 - 000F	DMA controller 1
0020 - 0021	Master interrupt controller (8259)
002E - 002F	NS360 Configuration registers
0040 - 0043	Timer 1
0060, 0064	Keyboard controller (reset, slow A20)
0061	Port B (speaker, NMI status and control)
0070	Bit 7: NMI mask register
0070 - 0071	RTC and CMOS data
0080	Manufacturing port (POST card)
0081 - 0083, 008F	DMA low page register
0092	PS/2 reset and Fast A20
00A0 - 00A1	Slave interrupt controller
00C0 - 00DF	DMA controller 2
00F0 - 00FF	Co-processor error
0170 - 0177	IDE secondary channel
01F0 - 01F7	IDE primary channel
0278 - 027F	LPT 2
02E8 - 02EF	Serial port 4 (COM4)
02F8 - 02FF	Serial port 2 (COM2)
0372 - 0377	IDE secondary channel, secondary floppy disk drive
0378 - 037A	LPT1
03B0 - 03DF	VGA
03E8 - 03EF	COM3
03F0h- 03F5	Floppy disk drive controller
03F6	IDE primary channel
03F7	Floppy disk drive controller
03F8 - 03FF	COM1
04D0 - 04D1	Interrupt edge/level control
0678 - 067B	LPT2 ECP
0778 - 077B	LPT1 ECP
0CF8 - 0CFF	PCI configuration space

### DMA Channel Controllers

Only “I/O-to-memory” and “memory-to-I/O” transfers are allowed. “I/O-to-I/O” and “memory-to-memory” transfers are disallowed by the hardware configuration.

The system controller supports seven DMA channels, each with a page register used to extend the addressing range of the channel to 16 MB. The following table summarizes how the DMA channels are allocated.

DMA controller	
Channel	Function
0	Free
1	Free if not used for parallel port in Setup
2	Floppy disk controller
3	Free if not used for parallel port in Setup
4	Used to cascade DMA channels 0-3
5	Free
6	Free
7	Free

### Interrupt Controllers

The Interrupt Requests (IRQs) are numbered sequentially, starting with the master controller, and followed by the slave.

Windows 2000 and Windows XP	
IRQ (Interrupt Vector)	Interrupt Request Description
INTR	
ISA0	System Timer
ISA1	Standard 101/102-Key or Microsoft Natural PS/2 keyboard
ISA3	Communication Port (COM2)
ISA4	Communication Port (COM1)
ISA6	Standard Floppy Disk Controller
ISA8	System CMOS/real time clock
ISA9	Microsoft ACPI-Compliant System
ISA12	PS/2 Compatible Mouse
ISA13	Numeric data processor
ISA14	Primary IDE Channel
ISA15	Secondary IDE Channel
PCI5	Intel(R) 82801BA/BAM SMBus Controller - 2443
PCI17	Intel(R) 82801BA/BAM AC'97 Audio Controller - 2445
PCI19	Intel(R) 82801BA/BAM USB Universal Host Controller - 2442
PCI20	Intel(R) PRO/100 VE Network Connection
PCI 23	Intel(R) 82801BA/BAM USB Universal Host Controller - 2444

## PCI Interrupt Request Lines

PCI devices generate interrupt requests using up to eight PCI interrupt request lines. PCI interrupts can be shared; several devices can use the same interrupt. However, optimal system performance is reached when minimizing the sharing of interrupts.

Chipset PCI INT lines	Devices									
	AGP	PCI1	PCI2	PCI3	AC97	Internal LAN	USB controller 1	USB controller 2	USB controller 3	SMBus
<b>PIRQA</b>	INTA			INTB						
<b>PIRQB</b>	INTB			INTC						
<b>PIRQC</b>				INTD						
<b>PIRQD</b>				INTA						
<b>PIRQE</b>		INTD	INTC							
<b>PIRQF</b>		INTA	INTD							
<b>PIRQG</b>		INTB	INTA							
<b>PIRQH</b>		INTC	INTB							

## POST Tests

The POST is executed each time the system is powered on, or a reset is performed. The POST process verifies the basic functionality of the system components and initializes certain system parameters.

The POST starts by displaying a graphic screen of the Hewlett-Packard logo when the PC is started.

Devices, such as memory and newly installed hard disks, are configured automatically. The user is not requested to confirm the change. Newly removed hard disks are detected, and the user is prompted to confirm the new configuration by pressing **F4**.

---

**NOTE** The POST does not detect when a hard disk drive has been otherwise changed.

---

During the POST, the BIOS and other ROM data is copied into high-speed shadow RAM. The shadow RAM is addressed at the same physical location as the original ROM in a manner which is completely transparent to applications. It therefore appears to behave as very fast ROM. This technique provides faster access to the system BIOS firmware.

The following table lists the POST checkpoint codes written at the start of each test:

Checkpoint Code	POST Routine Description
D0	NMI is Disabled. CPU ID saved. Init code Checksum verification starting.
D1	To do DMA init, Keyboard controller BAT test, start memory refresh and going to 4GB flat mode.
D3	To start Memory sizing.
D4	To comeback to real mode. Execute OEM patch. Set stack.
D5	E000 ROM enabled. Init code is copied to segment 0 and control to be transferred to segment 0.

Checkpoint Code	POST Routine Description
D6	Control is in segment 0. To check <CTRL><HOME> key and verify main BIOS checksum. If either <CTRL><HOME> is pressed or main BIOS checksum is bad, go to check point E0 else go to check point D7.
D7	To pass control to Interface Module.
D8	Main BIOS runtime code is to be decompressed.
D9	Control to be passed to main BIOS in shadow RAM. Boot Block Recovery Code Check Points.
E0	OnBoard Floppy Controller (if any) is initialized. To start base 512K memory test.
E1	To initialize interrupt vector table.
E2	To initialize DMA and interrupt controllers.
E6	To enable floppy and timer IRQ, enable internal cache.
ED	Initialize floppy drive.
EE	Start looking for a diskette in drive A: and read 1st sector of the diskette.
EF	Floppy read error.
F0	Start searching 'AMIBOOT . ROM' file in root directory.
F1	'AMIBOOT . ROM' file not present in root directory.
F2	Start reading FAT table and analyze FAT to find the clusters occupied by 'AMIBOOT . ROM' file.
F3	Start reading 'AMIBOOT . ROM' file cluster by cluster.
F4	'AMIBOOT . ROM' file not of proper size.
F5	Disable internal cache.
FB	Detect Flash type present.
FC	Erase Flash.
FD	Program Flash.
FF	Flash program successful. BIOS is going to restart. Runtime code is uncompressed in F000 shadow ram.
03	NMI is Disabled. To check soft reset/power-on.
05	BIOS stack set. Going to disable Cache if any.
06	POST code to be uncompressed.
07	CPU init and CPU data area init to be done.
08	CMOS checksum calculation to be done next.
0B	Any initialization before keyboard BAT to be done next.
0C	KB controller I/B free. To issue the BAT command to keyboard controller.
0E	Any initialization after KB controller BAT to be done next.
0F	Keyboard command byte to be written.
10	Going to issue Pin-23,24 blocking/unblocking command.
11	Going to check pressing of <INS>, <END> key during power-on.
12	To init CMOS if "Init CMOS in every boot" is set or <END> key is pressed. Going to disable DMA and Interrupt controllers.
13	Video display is disabled and port-B is initialized. Chipset init about to begin.
14	8254 timer test about to start.
19	About to start memory refresh test.
1A	Memory Refresh line is toggling. Going to check 15us ON/OFF time.
23	To read 8042 input port and disable Megakey GreenPC feature. Make BIOS code segment writeable.



Checkpoint Code	POST Routine Description
24	To do any setup before Int vector init.
25	Interrupt vector initialization about to begin. To clear password if necessary.
27	Any initialization before setting video mode to be done.
28	Going for monochrome mode and color mode setting.
2A	Different BUSES init (system, static, output devices) to start if present.
2B	To give control for any setup required before optional video ROM check.
2C	To look for optional video ROM and give control.
2D	To give control to do any processing after video ROM returns control.
2E	If EGA/VGA not found then do display memory R/W test.
2F	EGA/VGA not found. Display memory R/W test about to begin.
30	Display memory R/W test passed. About to look for the retrace checking.
31	Display memory R/W test or retrace checking failed. To do alternate Display memory R/W test.
32	Alternate Display memory R/W test passed. To look for the alternate display retrace checking.
34	Video display checking over. Display mode to be set next.
37	Display mode set. Going to display the power on message.
38	Different BUSES init (input, IPL, general devices) to start if present.
39	Display different BUSES initialization error messages.
3A	New cursor position read and saved. To display the Hit <DEL> message.
40	To prepare the descriptor tables.
42	To enter in virtual mode for memory test.
43	To enable interrupts for diagnostics mode.
44	To initialize data to check memory wrap around at 0:0.
45	Data initialized. Going to check for memory wrap around at 0:0 and finding the total system memory size.
46	Memory wrap around test done. Memory size calculation over. About to go for writing patterns to test memory.
47	Pattern to be tested written in extended memory. Going to write patterns in base 640k memory.
48	Patterns written in base memory. Going to find out amount of memory below 1M memory.
49	Amount of memory below 1M found and verified. Going to find out amount of memory above 1M memory.
4B	Amount of memory above 1M found and verified. Check for soft reset and going to clear memory below 1M for soft reset. (If power on, go to check point# 4Eh).
4C	Memory below 1M cleared. (SOFT RESET) Going to clear memory above 1M.
4D	Memory above 1M cleared. (SOFT RESET) Going to save the memory size. (Goto check point# 52h).
4E	Memory test started. (NOT SOFT RESET) About to display the first 64k memory size.
4F	Memory size display started. This will be updated during memory test. Going for sequential and random memory test.
50	Memory testing/initialization below 1M complete. Going to adjust displayed memory size for relocation/shadow.
51	Memory size display adjusted due to relocation/ shadow. Memory test above 1M to follow.
52	Memory testing/initialization above 1M complete. Going to save memory size information.
53	Memory size information is saved. CPU registers are saved. Going to enter in real mode.
54	Shutdown successful, CPU in real mode. Going to disable gate A20 line and disable parity/NMI.
57	A20 address line, parity/NMI disable successful. Going to adjust memory size depending on relocation/shadow.
58	Memory size adjusted for relocation/shadow. Going to clear Hit <DEL> message.

Checkpoint Code	POST Routine Description
59	Hit <DEL> message cleared. <WAIT . . . > message displayed. About to start DMA and interrupt controller test.
60	DMA page register test passed. To do DMA#1 base register test.
62	DMA#1 base register test passed. To do DMA#2 base register test.
65	DMA#2 base register test passed. To program DMA unit 1 and 2.
66	DMA unit 1 and 2 programming over. To initialize 8259 interrupt controller.
7F	Extended NMI sources enabling is in progress.
80	Keyboard test started. clearing output buffer, checking for stuck key, to issue keyboard reset command.
81	Keyboard reset error/stuck key found. To issue keyboard controller interface test command.
82	Keyboard controller interface test over. To write command byte and init circular buffer.
83	Command byte written, Global data init done. To check for lock-key.
84	Lock-key checking over. To check for memory size mismatch with CMOS.
85	Memory size check done. To display soft error and check for password or bypass setup.
86	Password checked. About to do programming before setup.
87	Programming before setup complete. To uncompress SETUP code and execute CMOS setup.
88	Returned from CMOS setup program and screen is cleared. About to do programming after setup.
89	Programming after setup complete. Going to display power on screen message.
8B	First screen message displayed. <WAIT . . . > message displayed. PS/2 Mouse check and extended BIOS data area allocation to be done.
8C	Setup options programming after CMOS setup about to start.
8D	Going for hard disk controller reset.
8F	Hard disk controller reset done. Floppy setup to be done next.
91	Floppy setup complete. Hard disk setup to be done next.
95	Init of different BUSES optional ROMs from C800 to start.
96	Going to do any init before C800 optional ROM control.
97	Any init before C800 optional ROM control is over. Optional ROM check and control will be done next.
98	Optional ROM control is done. About to give control to do any required processing after optional ROM returns control and enable external cache.
99	Any initialization required after optional ROM test over. Going to setup timer data area and printer base address.
9A	Return after setting timer and printer base address. Going to set the RS-232 base address.
9B	Returned after RS-232 base address. Going to do any initialization before Coprocessor test.
9C	Required initialization before Coprocessor is over. Going to initialize the Coprocessor next.
9D	Coprocessor initialized. Going to do any initialization after Coprocessor test.
9E	Initialization after Coprocessor test is complete. Going to check extd keyboard, keyboard ID and num-lock.
A2	Going to display any soft errors.
A3	Soft error display complete. Going to set keyboard typematic rate.
A4	Keyboard typematic rate set. To program memory wait states.
A5	Going to enable parity/NMI.
A7	NMI and parity enabled. Going to do any initialization required before giving control to optional ROM at E000.
A8	Initialization before E000 ROM control over. E000 ROM to get control next.
A9	Returned from E000 ROM control. Going to do any initialization required after E000 optional ROM control.

<b>Checkpoint Code</b>	<b>POST Routine Description</b>
AA	Initialization after E000 optional ROM control is over. Going to display the system configuration.
AB	To build MP table if needed.
AC	To uncompress DMI data and execute DMI POST init.
B0	System configuration is displayed.
B1	Going to copy any code to specific area.
00	Copying of code to specific area done. Going to give control to INT-19 boot loader.

## HP e-DiagTools Preboot Diagnostics (Beep Codes)

When your PC starts up, its BIOS performs a Power-on Self Test (POST) to test your hardware configuration for any problems. If a problem is detected during the POST, an error is displayed on your PC's monitor.

If, however, your PC is unable to display an error message (for example, when your graphics controller has failed), it will emit a buzzing sound. This is the e-DiagTools preboot diagnostic. In the event of a problem with your PC immediately after the buzzing sound, a series of beeps is emitted.

If you hear a series of beeps, you should count them as this will help you detect the cause of the problem.

Number of Beeps	Meaning
0	<ul style="list-style-type: none"><li>• If you hear the buzzing audio signal: system OK</li><li>• No buzzing audio signal: no power, PC is unplugged, power supply is down or system board has failed.</li></ul>
1	Processor absent, not correctly connected or processor socket not closed
2	Power supply is in protected mode <sup>1</sup>
3	No memory, bad memory modules, incompatible memory module
4	Graphics solution problem
5	PnP/PCI initialization problem
6	Corrupted BIOS. You need to activate crisis recovery procedure.
7	Defective system board

1. Typically this is as a result of a system board problem, and not a power supply unit fault.

Note that for Memory (code 3), Video Card (code 4), and PnP/PCI (code 5) errors, e-DiagTools preboot diagnostic will only detect them after a 15-second timeout.

If you miss the beep code, turn off the PC. Then press the on/off power button for five seconds or more and listen for the signal again.

The e-DiagTools preboot diagnostics, as well as emitting a beep sequence, also encodes troubleshooting information (such as the PC model, serial number and failing components) into a coded audio signal. During a support call, this coded signal can then be decoded by the HP Service Provider to provide immediate and effective assistance.

## — Drivers and Software

This chapter describes the drivers and software preloaded with the Compaq Evo D310 Micro Desktop PC.

## Drivers

You can download up-to-date versions of drivers required for the Compaq Evo D310 Micro Desktop PC from the “Software and Drivers” section of HP’s Support web site at:

[www.hp.com/go/support](http://www.hp.com/go/support).

---

## Software

Compaq Evo D310 Micro Desktop PCs come preloaded with the following software. You can download the most up-to-date versions from the “Software and Drivers” section of HP’s Support web site at:

[www.hp.com/go/support](http://www.hp.com/go/support).

## Operating System

Choice of operating systems:

- Windows 2000
- Windows XP Professional Edition
- Windows XP Home Edition.

## Software

- WinDVD MPEG2 decoding software (on CD-ROM) from InterVideo included on DVD models. This software allows you to play movies on your PC.
- DLA (Drive Letter Access) software (on CD-ROM) from Veritas included on CD-RW models. This software allows you to add/remove data to a CD-RW.
- MyCD software (on CD-ROM) from Veritas included on CD-RW models.
- HP e-Diagtools hardware diagnostic solution.
- HP Instant Support tuner.
- HP Image Creation and Recovery CD-ROM (OS installation and hard disk preparation).
- HP Image Library and Diagnostics CD-ROM (drivers and utilities installation and diagnostics).
- Sound Blaster applications (on CD-ROM).

## e-DiagTools

HP e-DiagTools, the hardware diagnostics utility can help you diagnose hardware-related problems on your HP PC. For more information about this utility, refer to the e-Diagtools User's Guide. The e-Diagtools User's Guide is available on HP’s Support web site: ([www.hp.com/go/support](http://www.hp.com/go/support)).

e-DiagTools is installed on the HP protected partition on the PC’s hard disk drive, is provided on the HP Image Library and Diagnostics System CD-ROM (that came with your PC) from where it can be installed, and is available on the HP e-DiagTools CD-ROM (you can order this CD-ROM from HP’s Support web site) from where it can be run.

---

## BIOS Updates

The system BIOS is identified by the version number JH.01.yy. The latest BIOS version for your PC and instructions for updating the BIOS can be downloaded from the HP Support Web site at:

**[www.hp.com/go/support](http://www.hp.com/go/support)**.







***COMPAQ***