



Your Reliable Partner

BE7 Series

(BE7-G, BE7-S, BE7-RAID, BE7-B, BE7)

Socket 478 System Board

User's Manual

Copyright and Warranty Notice

The information in this document is subject to change without notice and does not represent a commitment on part of the vendor, who assumes no liability or responsibility for any errors that may appear in this manual.

No warranty or representation, either expressed or implied, is made with respect to the quality, accuracy or fitness for any particular part of this document. In no event shall the manufacturer be liable for direct, indirect, special, incidental or consequential damages arising from any defect or error in this manual or product.

Product names appearing in this manual are for identification purpose only and trademarks and product names or brand names appearing in this document are the property of their respective owners.

This document contains materials protected under International Copyright Laws. All rights reserved. No part of this manual may be reproduced, transmitted or transcribed without the expressed written permission of the manufacturer and authors of this manual.

If you do not properly set the motherboard settings, causing the motherboard to malfunction or fail, we cannot guarantee any responsibility.

Contents

BE7 系列快速安裝指引.....	1
BE7 シリーズのクイックインストールガイド	3
BE7-Serie Schnellinstallationsanleitung	5
Série BE7 Guide d'Installation Rapide	7
Краткое руководство по установке BE7 серия.....	9
Guida all'installazione veloce Scheda madre serie BE7	11
CHAPTER 1. INTRODUCTION.....	1-1
1-1. FEATURES & SPECIFICATIONS	1-1
1-2. LAYOUT DIAGRAM (BE7-G).....	1-3
1-3. LAYOUT DIAGRAM (BE7-S)	1-4
1-4. LAYOUT DIAGRAM (BE7-RAID).....	1-5
1-5. LAYOUT DIAGRAM (BE7-B).....	1-6
1-6. LAYOUT DIAGRAM (BE7).....	1-7
CHAPTER 2. HARDWARE SETUP	2-1
2-1. INSTALL THE MOTHERBOARD	2-1
2-2. INSTALL PENTIUM® 4 CPU AND HEATSINK SUPPORTING-BASE ..	2-2
2-3. INSTALL SYSTEM MEMORY	2-3
2-4. CONNECTORS, HEADERS AND SWITCHES	2-4
CHAPTER 3. BIOS SETUP	3-1
3-1. CPU SETUP [SOFTMENU™ III]	3-3
3-2. STANDARD CMOS FEATURES SETUP MENU	3-6
3-3. ADVANCED BIOS FEATURES SETUP MENU	3-9
3-4. ADVANCED CHIPSET FEATURES SETUP MENU	3-12
3-5. INTEGRATED PERIPHERALS.....	3-14
3-6. POWER MANAGEMENT SETUP MENU	3-18
3-7. PNP/PCI CONFIGURATIONS.....	3-22
3-8. PC HEALTH STATUS	3-24
3-9. LOAD FAIL-SAFE DEFAULTS.....	3-26
3-10. LOAD OPTIMIZED DEFAULTS	3-26

3-11.	SET PASSWORD.....	3-27
3-12.	SAVE & EXIT SETUP	3-28
3-13.	EXIT WITHOUT SAVING	3-28
APPENDIX A.	INSTALL INTEL CHIPSET SOFTWARE UTILITY	A-1
APPENDIX B.	INSTALL INTEL APPLICATION ACCELERATOR	B-1
APPENDIX C.	INSTALL AUDIO DRIVER.....	C-1
APPENDIX D.	INSTALL LAN DRIVER.....	D-1
APPENDIX E.	INSTALL USB 2.0 DRIVER.....	E-1
APPENDIX F.	INSTALL SERIAL ATA RAID DRIVER (FOR BE7-G & BE7-S)	F-1
APPENDIX G.	HPT 372 SETUP (FOR BE7-RAID)	G-1
APPENDIX H.	BIOS UPDATE GUIDE	H-1
APPENDIX I.	HARDWARE MONITORING (THE WINBOND HARDWARE DOCTOR UTILITY).....	I-1
APPENDIX J.	INSTALLATION GUIDE FOR SUSPEND TO RAM	J-1
APPENDIX K.	TROUBLESHOOTING (NEED ASSISTANCE?)..	K-1
APPENDIX L.	HOW TO GET TECHNICAL SUPPORT	L-1

BE7 系列快速安裝指引

感謝您購買 ABIT 的主機板，此主機板是設計給 Intel Socket 478 Pentium 4 處理器使用，支援 Intel Socket-478 架構的處理器，並支援最高至 2GB 容量的 DDR 記憶體模組。

如您要瞭解此主機板更詳細的資訊，請參閱我們的完整版使用手冊，裡面會有詳盡的說明。此快速安裝手冊是給有經驗的系統組裝者使用，如果您是您第一次嘗試來組裝您的電腦系統，我們建議您先去閱讀完整版的使用手冊，或是詢問技術人員來幫助您組裝您的電腦系統。

處理器的安裝

本主機板提供零出力 (Zero Insertion Force, ZIF) 式 Socket 478，以方便安裝 Intel® Pentium® 4 CPU。您所購買的 CPU 應已配備一組散熱套件及散熱片，如果沒有，請購買專為 Pentium® 4 Socket 478 設計的散熱套件及散熱片。

1. 請找出 Socket 478 的位置，然後將散熱套件支座固定在主機板上。

注意：若您使用專為 Pentium® 4 設計的底座，請注意底座上的金屬螺栓或墊片 (若已安裝的話)。請確定金屬螺栓或墊片不會碰到印刷電路板上的電線或零件。

2. 請將 CPU 插座桿拉出至插座旁，然後將插座桿以 90 度角向上拉。請以正確的方向插入 CPU，由於只能朝著一個固定的方向插入 CPU，因此如果遇到阻礙時，切勿勉強用力。最後壓住 CPU，並且門上插座桿。
3. 請將散熱裝置的正面向著 CPU 放入，直至完全蓋住 CPU 為止。
4. 將散熱裝置的支罩蓋在散熱裝置上。請確定支罩的每邊四個鎖扣都已鎖入鎖孔。
5. 將支罩兩側的固定夾往下壓，以夾緊支座。壓固定夾時，請注意壓按的方向。
6. 現在散熱支罩及支座應該已互相緊扣，而散熱裝置亦已裝妥在支罩內。

注意：請記得設定正確的處理器外頻和倍頻數值。

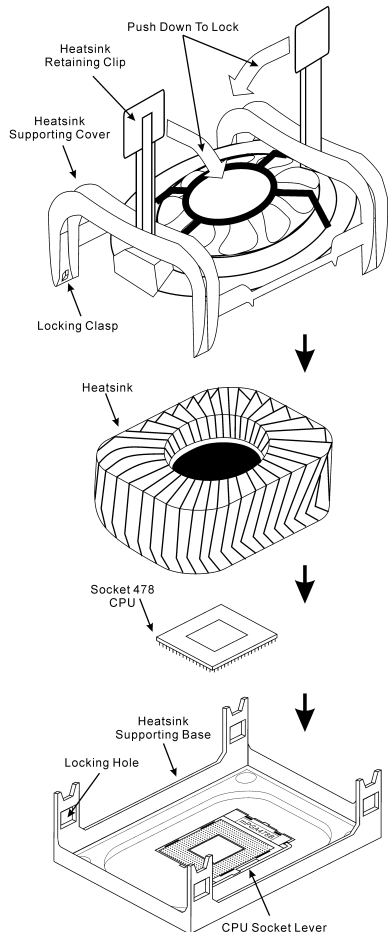

將主機板安裝到機殼上

當您將處理器安裝到主機板上之後，您就可以開始將主機板固定到電腦機殼裡去。首先；請您先將主機板固定到電腦機殼。大多數的電腦機殼底座都有許多的固定孔位，請將主機板上的固定孔位與機殼底座上的固定孔位對準。如果孔能對準並且有螺絲孔，就表示可使用銅柱來固定主機板。另外；您可以使用塑膠墊片來讓螺絲與主機板的 PCB 表層隔離（絕緣）。

安裝系統記憶體

本主機板提供 3 組 184 腳的 DDR DIMM 插座可供記憶體擴充，可支援 DDR SDRAM 的最小記憶體大小為 64MB，而最大的記憶體大小則為 2GB。

將 DDR DIMM 記憶體模組插入 DIMM 插槽。請注意記憶體模組的楔子是如何對應到 DIMM 插槽上的卡榫之上。此種設計可確保 DDR DIMM 記憶體模組僅能由一個方向插到 DIMM 插槽之上。當您將 DDR DIMM 記憶體模組完全插入 DIMM 插槽時，模組退出（固定）夾應該會將 DDR DIMM 記憶體模組自兩側卡緊並緊緊地固定住記憶體模組。請依 DIMM1~DIMM3 插槽的順序來安裝記憶體模組。

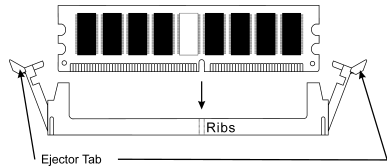

最後，您必需將所有必需的裝置纜線連接到主機板上相關的連接頭或是連接器上面，以完成您系統的硬體安裝動作。

連接器、連接頭以及附加卡的安裝

在任何一部電腦機殼的裡面，都必需連接一些纜線與插頭。這些纜線與插頭通常都是一對一的連接至主機板的連接埠上，您必需注意任何一條纜線的連接方向。如果可能的話，請一併注意連接埠第一根針腳的位置。您將會安裝一些特殊功能的附加卡到主機板上，像是 SCSI 卡或是 AGP 顯示卡等等。當您將它們安裝到主機板上適當的插槽之後，請以螺絲將這些附加卡與機殼背板牢牢地固定好，避免有鬆動的情況發生。

如您想要瞭解相關且更為詳細的資訊，請參閱我們的完整版使用手冊，裡面會有詳盡的說明。

將電源供應器的電源線連接頭與主機板上的 J3/J5 連接頭連接起來

請將電源供應器的 ATX 電源接頭確實地壓入主機板上的 J3/J5 接頭，並確定連接妥當。

BIOS 的設定

當您將所有的硬體安裝完畢以後，就可以開啓電腦的電源並進入 BIOS 的選項。如您想要瞭解相關且更為詳細的資訊，請參閱我們的完整版使用手冊，裡面會有詳盡的說明。

BE7 シリーズのクイックインストールガイド

ABIT マザーボードをお買い上げいただきましてありがとうございます。このマザーボードは Intel Socket 478 Pentium 4 プロセッサ用に設計されています。最高 2GB の DDR メモリを搭載した Intel Socket-478 構造をサポートします。

このマザーボードの詳細については、ユーザーズマニュアルの完全版を参照してください。このクイックインストールガイドは、経験あるシステム構築者向けに書かれました。今回始めてコンピュータシステムをセットアップする方は、まず完全版のマニュアルをお読みになるか、専門技術者に連絡してコンピュータシステムのセットアップを行うようお勧めします。レバー

プロセッサの取り付け

このマザーボードは ZIF (ゼロインサージョンフォース) Socket 478 を提供して Intel® Pentium® 4 CPU をインストールします。お買い上げになった CPU には、ヒートシンクと冷却ファンのキットが付属しています。付属していない場合、Pentium® 4 Socket 478 向けに特別に設計されたキットをお求めください。

1. Socket 478 を設置します。ヒートシンクをマザーボード上のサポート台に固定してください。

注意： Pentium® 4 向けに特別に設計されたシャーシをお使いの場合、金属スタッドやスペーサがすでにインストールされている場合、それらの場所に注意してください。金属スタッドやスペーサがプリント基板線や PCB の部品に触れないように気をつけてください。

2. CPU のソケットレバーをソケットから横方向に引いて、90 度上に持ち上げます。CPU を正しい方向に挿入します。CPU を挿入する際、余分な力を入れないでください。1 方向にだけ適合します。CPU を下に押しながら、ソケットレバーをクローズします。
3. ヒートシンクの面が CPU を完全に覆うまで、CPU の上に下ろします。
4. ヒートシンクのサポートカバーをヒートシンクに置きます。サポートカバーの各面の 4 本の留め金がすべて固定穴に届いていることを確認してください。
5. サポートカバーの両側の支持クリップを下に押し、サポート台と共に固定します。クリップを下に押しときに方向に注意してください。
6. ヒートシンクのサポートカバーと台は、ヒートシンクの内側でお互いにしっかりと固定されている必要があります。

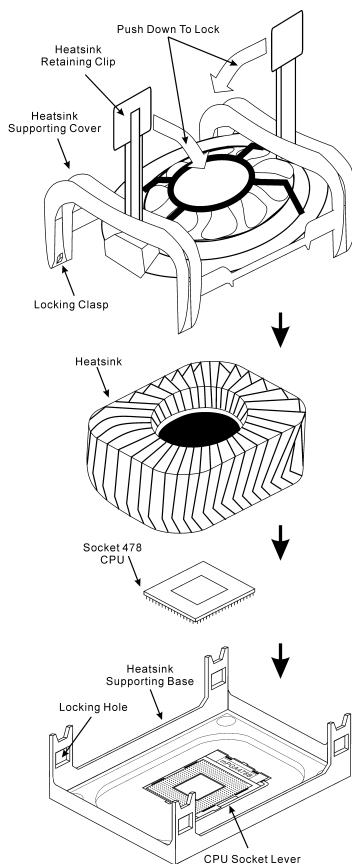

注意： プロセッサに対して、正しいバス周波数とマルチプルに設定することを忘れないでください。

マザーボードをシャーシに取り付ける

マザーボードにプロセッサを取り付けた後、シャーシにマザーボードを固定することができるようになります。まず、シャーシにマザーボードを固定する必要があります。ほとんどのコンピュータシャーシには、多くの取り付け穴の付いた台が付属しており、それを使用することでマザーボードをしっかりと取り付けたり、同時にショートを避けることができます。シャーシに付属する飾りボタンかスパーサーを使用してマザーボードを固定します。

システムメモリの取り付け

このマザーボードでは、3つの184ピンDDR DIMMスロットメモリ拡張を提供します。最小メモリは64MBで、最大メモリは2GB DDR SDRAMです。

DDR DIMMを図に示すように拡張スロットに差し込みます。モジュールがソケットにどのように固定されているか注意してください。これにより、DDR DIMMモジュールに差し込む方法が1つしかないことを確認できます。DDR DIMMモジュールをDDR DIMMソケットにしっかりと押し込み、モジュールがDDR DIMMソケットに完全に差し込まれていることを確認します。

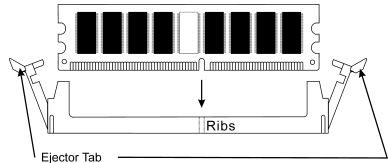

これらのモジュールに対して、DIMM1からDIMM3まで順に差し込むようにお勧めします。

次に、すべての必要なデバイスケーブルをマザーボードの関連ヘッダとコネクタに接続して、システムのハードウェア取付けを終了する必要があります。

コネクタ、ヘッダ、スイッチおよびアダプタ

コンピュータのケース内部には、複数のケーブルやプラグを接続できます。これらのケーブルやプラグは、通常マザーボードにあるコネクタに1つずつ接続されます。ケーブルの接続方向には十分な注意を払い、また必要に応じ、コネクタの第1ピンの位置にも注目する必要があります。SCSIアダプタ、AGPアダプタのような特殊なニーズ向けには、それに対応したアダプタを取り付けてください。アダプタをマザーボードのスロットに取り付けたら、ネジでシャーシの背面パネルに固定してください。

詳細については、ユーザーズマニュアルの完全版を参照してください。

電源コネクタをJ3/J5コネクタに差し込む

電源装置から出ている電源ブロックコネクタをこのJ3/J5に接続します。コネクタが十分奥まで装着されていることをご確認ください。

BIOSのセットアップ

ハードウェアの取り付けが完了したら、コンピュータの電源をオンにし、BIOS Setup アイテムに移動して、プロセッサのパラメータをセットアップします。詳細については、ユーザーズマニュアルの完全版を参照してください。

BE7-Serie Schnellinstallationsanleitung

Vielen Dank für Ihren Kauf der ABIT-Hauptplatine. Diese Hauptplatine wurde für Intel Socket 478 Pentium 4 Prozessoren ausgelegt. Sie unterstützt die Intel Socket-478-Struktur und DDR-Speichersteckplätze mit der Kapazität von bis zu 2 GB RAM.

Beziehen Sie sich bitte für detaillierte Informationen über diese Hauptplatine auf die vollständige Version des Benutzerbuchs. Diese Schnellinstallationsanleitung ist für erfahrene Systemaufbauer gedacht. Ist es Ihr erster Versuch ein Computersystem aufzubauen, dann empfehlen wir Ihnen zuerst das vollständige Benutzerhandbuch zu lesen oder einen Techniker zum Aufbauen des Systems zu Hilfe zu holen.

Installieren des Prozessors

Dieses Motherboard verfügt über einen ZIF (Zero Insertion Force) Socket 478 zur Installation eines Intel® Pentium® 4 CPU. Ihre CPU sollte über ein Kühlblech und einen Lüfter verfügen. Wenn dies nicht der Fall ist, kaufen Sie bitte diese Teile speziell für den Pentium® 4 Socket 478.

1. Finden Sie den Socket 478. Bringen Sie die Basis des Kühlblechs am Motherboard an.

Achtung: Wenn Sie ein speziell für den Pentium® 4 entworfenes Gehäuse verwenden, achten Sie bitte auf die Lage der Metallbolzen oder Abstandhalter, falls diese schon im Gehäuse angebracht sind. Achten Sie darauf, diese Metallbolzen bzw. Abstandhalter nicht in Kontakt mit den gedruckten Schaltkreisen oder Teile auf dem PCB kommen zu lassen.

2. Ziehen Sie den CPU-Sockelhebel seitlich vom Sockel weg und dann nach im 90°-Winkel nach oben. Setzen Sie die CPU in der korrekten Ausrichtung ein. Wenden Sie beim Einsetzen der CPU keine Gewalt an; sie passt nur in eine Richtung in den Sockel. Schließen Sie den Sockelhebel wieder, während Sie die CPU nach unten gedrückt halten.
3. Setzen Sie das Kühlblech mit der Vorderseite nach unten auf die CPU, bis es die CPU komplett abdeckt.
4. Setzen Sie die Kühlblechabdeckung auf das Kühlblech. Achten Sie darauf, dass die vier Verschlüsse auf jeder Seite der Kühlblechabdeckung völlig in den Verschlusslöchern sitzen.
5. Drücken Sie die Halteklammern an beiden Seiten der Halteklammern, bis sie mit der Basis verriegelt sind. Achten Sie beim Herunterdrücken der Klammern auf die Richtung.
6. Kühlblechabdeckung und -basis sollten nun fest miteinander das Kühlblech umschließen.

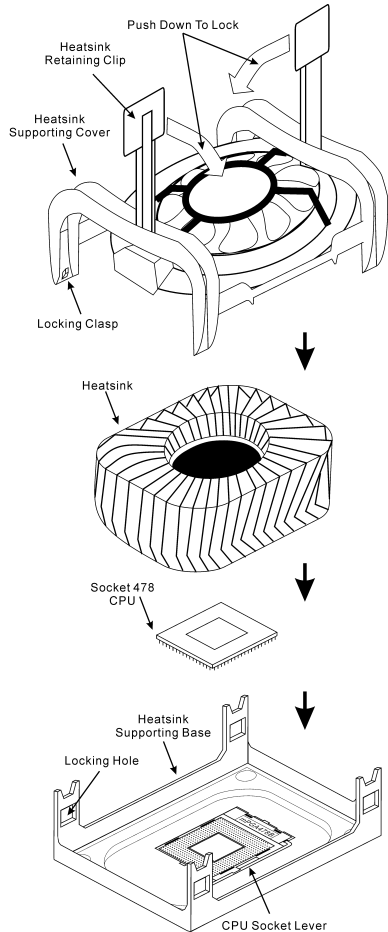

Achtung: Vergessen Sie nicht, die korrekte Busfrequenz und Multiplikator für Ihren Prozessor einzustellen.

Installieren der Hauptplatine im Gehäuse

Nach der Installation des Prozessors können Sie anfangen die Hauptplatine im Computergehäuse zu befestigen. Die meisten Gehäuse haben eine Bodenplatte, auf der sich eine Reihe von Befestigungslöcher befinden, mit deren Hilfe Sie die Hauptplatine sicher verankern können und zugleich Kurzschlüsse verhindern. Verwenden Sie entweder die Dübeln oder die Abstandhalter, um die Hauptplatine auf der Bodenplatte des Gehäuses zu befestigen.

Installieren des Arbeitsspeichers

Diese Hauptplatine bietet 3 184-polige DDR DIMM-Steckplätze an. Sie können minimal 64 MB und maximal 2 GB DDR SDRAM einbauen.

Stecken Sie das DDR DIMM-Modul in den Speichersteckplatz ein, wie in der Abbildung dargestellt. Achten Sie darauf, wie die Kerbe des Moduls in den Steckplatz passt. So ist sichergestellt, dass das DDR DIMM-Modul nur in eine Richtung in den Steckplatz eingesteckt werden kann. Drücken Sie das DDR DIMM-Modul fest in den DDR DIMM-Steckplatz, bis es komplett und fest darin sitzt.

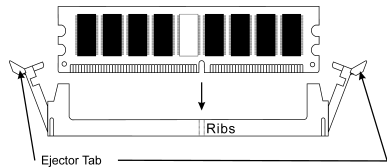

Für solche Module, empfehlen wir Ihnen die Bestückung von DIMM1 zu DIMM3 (in dieser Reihenfolge).

Danach müssen Sie alle nötigen Geräte Kabel mit den entsprechenden Sockeln und Anschlüssen auf der Hauptplatine verbinden, um die Hardwareinstallation Ihres Systems zu vervollständigen.

Anschlüsse, Sockel, Schalter und Adapter

Im Inneren des Gehäuses findet man in jedem Computer viele Kabel und Stecker, die angeschlossen werden müssen. Diese Kabel und Stecker werden normalerweise einzeln mit den Anschlüssen auf der Hauptplatine verbunden. Sie müssen genau auf die Anschlussorientierung der Kabel achten und, wenn vorhanden, sich die Position des ersten Pols des Anschlusses merken. Wenn Sie Adapter wie z.B. SCSI-Adapter, AGP-Adapter usw. installieren, befestigen Sie bitte die Adapter immer mit Hilfe der Schrauben auf die Rückseite des Computergehäuses.

Für detaillierte Informationen beziehen Sie sich bitte auf das vollständige Benutzerhandbuch.

Verbinden der Netzstecker mit dem J3/J5-Anschluss

Denken Sie daran, den Anschluss des ATX-Netzteils fest in das Ende mit dem J3/J5-Anschluss zu drücken, um eine feste Verbindung zu garantieren.

BIOS-Setup

Schalten Sie nach der vervollständigten Hardwareinstallation den Computer ein und gehen zur Option im BIOS, um die Prozessorparameter einzustellen. Für detaillierte Informationen beziehen Sie sich bitte auf das vollständige Benutzerhandbuch.

Série BE7 Guide d'Installation Rapide

Merci d'avoir acheté la carte mère ABIT. Cette carte mère est conçue pour les processeurs Intel Pentium 4 Socket 478. Elle supporte la structure Socket-478, avec jusqu'à 2 GB de mémoire DDR.

Pour des informations relatives à cette carte mère plus détaillées, veuillez vous référer à notre version complète du manuel utilisateur. Ce guide d'installation rapide est créé pour les assembleurs système expérimentés. S'il s'agit de votre premier essai pour installer un ordinateur, nous vous suggérons de lire d'abord le manuel en version complète ou de demander l'aide d'un technicien pour vous aider à configurer le système ordinateur.

Installer le Processeur

Cette carte mère fournit un support ZIF (Zero Insertion Force) Socket 478 permettant d'installer le Microprocesseur Intel® Pentium® 4. Le microprocesseur que vous achetez doit être muni d'un système de refroidissement avec dissipateur thermique et ventilateur. Dans le cas contraire, veuillez en acheter un, conçu spécialement pour les microprocesseurs Pentium® 4 Socket 478.

1. Placez le Socket 478. Fixez la base support du dissipateur thermique sur la carte mère.

Attention: Si vous utilisez un châssis conçu spécialement pour Pentium® 4, veuillez faire attention à l'emplacement des clous ou spacers métalliques si ceux-ci sont déjà installés sur le châssis. Faites attention de ne pas laisser les talons (studs) ou entretoises (spacers) métalliques en contact avec des fils ou des parties de circuit imprimé se trouvant sur le PCB.

2. Tirez de côté le levier de l'emplacement du CPU et tirez-le vers le haut à 90 degrés. Insérez le Microprocesseur en respectant une bonne orientation. Ne pas utiliser une force excessive en insérant le CPU; il s'installe uniquement dans une position. Fermez le levier d'emplacement en maintenant le Microprocesseur en place.
3. Mettez le dissipateur thermique face au microprocesseur jusqu'à ce qu'il le couvre complètement.
4. Mettez le couvercle support du dissipateur thermique sur le dissipateur thermique. Assurez-vous que les quatre verrous situés sur chaque côté du couvercle support vont bien dans les trous de verrouillage.
5. Poussez les attaches de maintenance se trouvant de chaque côté du couvercle support pour le rendre solidaire de la base support. Faites à la direction en poussant les attaches.

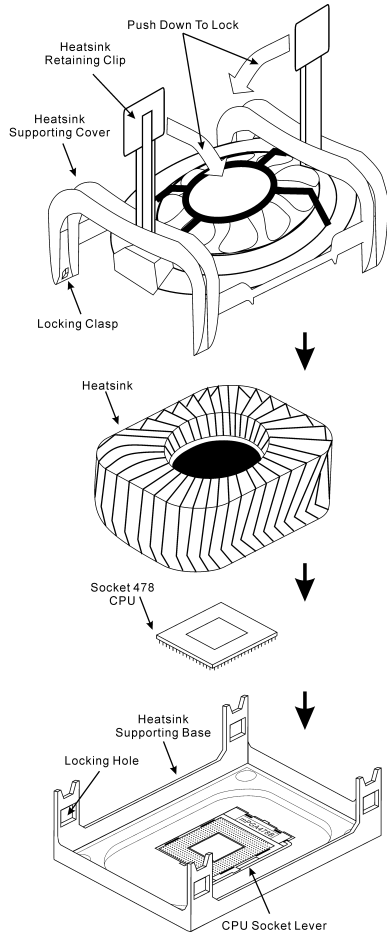

- Le couvercle support et la base du dissipateur thermique doivent maintenant être fermement fixés l'un à l'autre fermement avec le dissipateur thermique à l'intérieur.

Attention: N'oubliez pas de régler une fréquence de Bus et un coefficient multiplicateur corrects pour votre processeur.

Installer la Carte Mre dans le Châssis

Une fois que vous aurez installé le processeur sur la carte mère, vous pourrez commencer à fixer la carte mère sur le châssis. Tout d'abord, vous avez besoin de fixer la carte mère sur le châssis. La plupart des châssis d'ordinateur possèdent une base sur laquelle il y a nombreux trous de montage permettant à la carte mère d'être fixée fermement, et en même temps d'éviter les court-circuits. Utilisez les talons ou les entretoises fixés sur le châssis pour fixer la carte mère.

Installer la Mémoire Système

Cette carte mère dispose de 3 emplacements DIMM DDR 184-broches pour les extensions mémoire. La mémoire minimum est de 64 MB et la mémoire maximum est de 2 GB DDR SDRAM.

Insérez le module DDR DIMM dans l'emplacement d'extension comme illustré dans le schéma. Notez comment le module est verrouillé dans l'emplacement. Ceci assure qu'il n'y a qu'une manière d'insérer le module DDR DIMM. Pressez fermement le module DDR DIMM dans l'emplacement DDR DIMM; assurez-vous que le module est installé complètement dans l'emplacement DDR DIMM. Pour ces modules, nous vous suggérons de remplir de DIMM1 à DIMM3 en respectant l'ordre.

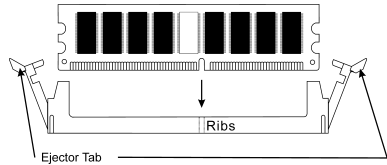

Ensuite, vous aurez à connecter les câbles de tous les périphériques nécessaires dans les socles de connexion et connecteurs correspondants se trouvant sur la carte mère pour terminer l'installation matérielle de votre système.

Connecteurs, Socles de connexion, Interrupteurs et Adaptateurs

A l'intérieur du boîtier de n'importe quel ordinateur il y a plusieurs câbles et prises qui doivent être connectés. Ces câbles et prises sont habituellement connectés les uns après les autres aux connecteurs situés sur la carte mère. Vous avez besoin de faire attention au sens de connexion des câbles et, s'il y a lieu, remarquez la position de la première broche du connecteur. Vous installerez certains adaptateurs pour des besoins spéciaux, tels adaptateurs SCSI, adaptateurs AGP, etc. Lorsque vous les installez dans les emplacements situés sur la carte mère, veuillez les fixer sur le panneau arrière du châssis à l'aide des vis.

Pour les informations détaillées, veuillez vous référer au manuel utilisateur en version complète.

Brancher les connecteurs d'alimentation dans les connecteurs J3/J5

Souvenez-vous que vous devez pousser le connecteur de votre alimentation fermement dans le connecteur J3/J5 pour assurer une bonne connexion.

Configuration du BIOS

Une fois le matériel installé complètement, démarrez l'ordinateur et allez sur l'item dans le BIOS pour configurer les paramètres du processeur. Pour les informations détaillées, veuillez vous référer à la version complète du manuel utilisateur.

Краткое руководство по установке BE7 серия

Благодарим вас за приобретение материнской платы производства АВIT. Эта материнская плата предназначена для использования с процессорами Intel Socket 478. Она поддерживает структуру Intel Socket 478, максимальный объем памяти DDR составляет 2 Гбайт.

Более подробные сведения о материнской плате приведены в руководстве пользователя. Краткое руководство по установке предназначено для опытных специалистов. Если вы собираете компьютер впервые, ознакомьтесь сперва с руководством пользователя или попросите техника помочь в настройке компьютерной системы.

Установка процессора

На этой системной плате используется гнездо ZIP (с нулевым усилием установки) типа 'Socket 478' для процессора Intel® Pentium® 4. В комплект приобретаемого процессора должны входить радиатор и вентилятор. В противном случае следует приобрести радиатор и вентилятор, предназначенные для процессора Pentium® 4 с разъемом 'Socket 478'.

1. Найдите на плате гнездо 'Socket 478'. Зафиксируйте крепежное основание радиатора на системной плате.

Внимание: При использовании корпуса специально предназначенного для Pentium® 4 обратите внимание на расположенные металлических вставок или распорок, если они уже установлены в корпус. Не допускайте контакта металлических вставок или распорок с проводниками или деталями печатной платы.

2. Сместите рычаг гнезда процессора в сторону от гнезда, а затем поверните его вверх на 90 градусов. Вставьте процессор, ориентируя его надлежащим образом. Устанавливая процессор, не прикладывайте чрезмерных усилий. Его установка возможна только в одном положении. Прижав процессор сверху, опустите рычаг гнезда.
3. Поместите радиатор плоской стороной на процессор так, чтобы процессор был полностью закрыт.
4. Поместите прижимную крышку радиатора на радиатор. Все четыре фиксатора по обеим сторонам прижимной крышки должны находиться на уровне крепежных отверстий.
5. Прижмите вниз фиксирующие зажимы по обеим сторонам прижимной крышки до их фиксации в крепежном основании. Следите за направлением, в котором Вы прижимаете зажимы.
6. Крышка и основание должны быть надежно скреплены, фиксируя радиатор.

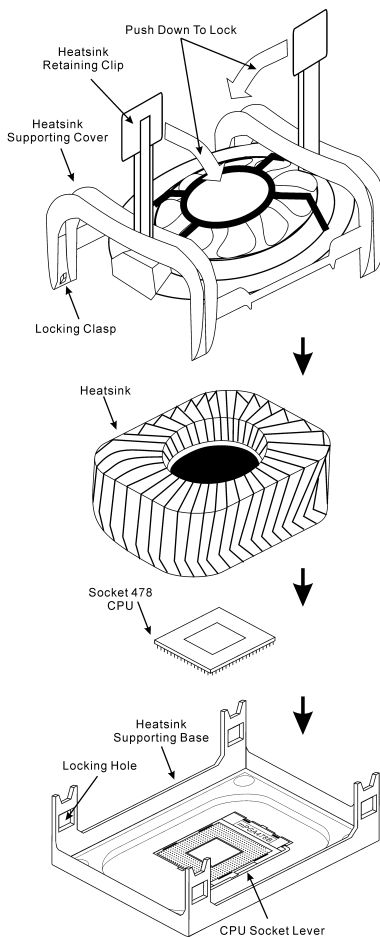

Внимание: Не забудьте установить для процессора надлежащую частоту шины и множитель.

Установка материнской платы в корпус

После установки процессора на материнскую плату можно начинать установку материнской платы в корпус. Большая часть корпусов оборудована основанием, в котором проделаны монтажные отверстия, которые позволяют надежно закрепить материнскую плату и предотвратить короткие замыкания. Для крепления материнской платы к основанию используются винты и прокладки.

Установка модулей памяти

На плате имеется 3 184-контактных гнезда расширения DDR DIMM для памяти. Минимальный объем памяти равен 64 Мбайт, максимальный объем равен 2 Гбайт DDR SDRAM.

Установите модуль памяти DDR DIMM в гнездо расширения, как показано на рисунке. Обратите внимание, что модуль фиксируется в гнезде. Таким образом, гарантируется единственно возможный способ установки модуля DDR DIMM. Вставьте модуль DDR DIMM в гнездо DDR DIMM; и убедитесь, что модуль надежно установлен в гнездо DDR DIMM. Для этих модулей мы рекомендуем устанавливать память начиная с DIMM1 и далее по DIMM3.

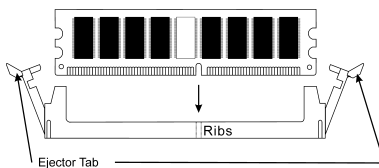

Подключите все необходимые кабели для подключения устройств к соответствующим разъемам на материнской плате, чтобы завершить установку аппаратуры вашей системы.

Разъемы, переключатели и адаптеры

Внутри корпуса компьютера необходимо расположены несколько кабелей и вилок, которые необходимо подключить. Обычно эти кабели подключаются к разъемам, расположенным на материнской плате. При подключении любого кабеля необходимо обращать внимание на расположение первого контакта разъема. Для особых целей могут потребоваться специальные адаптеры, например, адаптер SCSI, адаптер AGP и т.п. При установке адаптеров в гнезда материнской платы закрепите их на задней панели с помощью винтов.

За более подробной информацией обращайтесь к полному руководству пользователя.

Подключение кабелей питания к разъемам J3/J5

Обратите внимание, разъем блока питания ATX необходимо вставить в разъем J3/J5 до упора, чтобы обеспечить надежное соединение.

Настройка BIOS

По окончании установки аппаратуры включите питание и перейдите в меню BIOS Setup, чтобы настроить параметры процессора. За более подробной информацией обращайтесь к руководству пользователя.

Guida all'installazione veloce Scheda madre serie BE7

Complimenti per l'acquisto di una scheda madre ABIT. Questa scheda madre è progettata per processori Intel Pentium 4. Supporta la struttura Socket 478 con fino a 2GB di memoria DDR.

Per maggiori e dettagliate informazioni su questa scheda madre si prega di fare riferimento alla versione integrale del Manuale utente. Questa guida all'installazione veloce è intesa per costruttori esperti di sistemi. Se questa è la prima volta che si cerca di installare un sistema, si consiglia di leggere, innanzi tutto, la versione integrale del manuale oppure di chiedere aiuto ad un tecnico per l'installazione.

Installazione del processore

Questa scheda madre fornisce una presa "Socket 478" ZIF (Zero Insertion Force – forza d'inserimento zero) per installare il processore Intel® Pentium® 4. Il processore acquistato dovrebbe essere fornito di dissipatore di calore e ventolina per il raffreddamento. In caso contrario acquistare un dissipatore di calore specifico per la presa Socket 478 Pentium®.

1. Localizzare la presa Socket 478. Fissare la base di supporto dissipatore di calore sulla scheda madre.

Attenzione: Se si impiega un telaio progettato specificatamente per il processore Pentium® 4, prestare attenzione all'ubicazione delle borchie in metallo o degli spaziatori, nel caso in cui siano già installati sul telaio. Assicurarsi di non permettere alle borchie in metallo od agli spaziatori di entrare in contatto con il cavo o con le parti del circuito stampato.

2. Tirare di lato la leva della presa del processore allontanandola dalla presa; poi sollevarla di 90 gradi. Inserire il processore con il corretto orientamento. Non sforzare per inserire il processore poiché si adatta solamente in un dato orientamento. Chiudere la leva della presa mentre si trattiene il processore.
3. Mettere il dissipatore di calore a faccia in giù sul processore finché lo copre completamente.
4. Mettere il coperchio di supporto del dissipatore di calore sul dissipatore di calore. Assicurarsi che tutti quattro i fermagli, su ciascun lato del coperchio di supporto, si inseriscano nei fori di bloccaggio.
5. Spingere verso il basso i fermagli di bloccaggio su ciascun lato del coperchio di supporto in modo da fissarlo alla base di supporto. Prestare attenzione alla direzione in cui si spingono i fermagli.

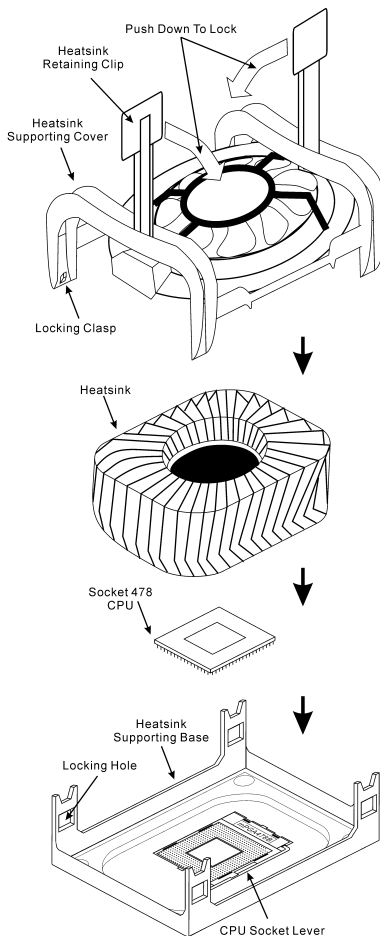

6. Il coperchio di supporto e la base del dissipatore di calore dovrebbero ora essere fissate saldamente l'uno all'altra, contenendo al loro interno il dissipatore di calore.

Attenzione: Non dimenticare di impostare la corretta frequenza BUS e multiplier per il processore.

Installazione della scheda madre sul telaio

Dopo avere installato il processore sulla scheda madre si può iniziare a fissare la scheda madre sul telaio. Innanzi tutto è necessario fissare la scheda madre al telaio. La maggior parte dei telai ha una base sulla quale sono presenti diversi fori di montaggio che permettono di fissare in modo accurato la scheda madre e, allo stesso tempo, di prevenire corto circuiti. Impiegare le borchie o gli spaziatori attaccati al telaio per fissare la scheda madre.

Installazione della memoria di sistema

Questa scheda madre fornisce 3 slot d'espansione di memoria DDR DIMM da 184 pin. La memoria minima è di 64 MB, quella massima è di 2 GB DDR SDRAM.

Inserire il modulo DDR DIMM nello slot d'espansione come mostrato nell'illustrazione- Notare che il modulo è impernato nella presa. Ciò assicura che ci sia un unico modo per collegare il modulo DDR DIMM. Premere con fermezza il modulo DDR DIMM nello slot DDR DIMM, assicurandosi che il modulo sia inserito completamente nello slot DDR DIMM. Per questi moduli si suggerisce di inserire con ordine i chip elettronici da DIMM1 a DIMM3.

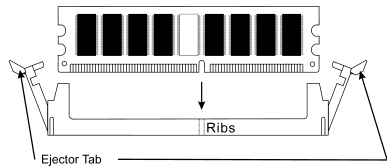

Per completare l'installazione dell'hardware del sistema, bisogna collegare tutti i cavi delle attrezzature necessarie ai relativi collettori e connettori sulla scheda madre.

Connettori, collettori, interruttori ed adattatori

All'interno della copertura di ogni computer ci sono diversi cavi e prese che devono essere collegati. Questi cavi e prese sono solitamente collegati uno ad uno ai connettori situati sulla scheda madre. E' necessario prestare particolare attenzione a qualunque orientamento del collegamento che possono avere i cavi e, se necessario, notare la posizione del primo pin del connettore. Si installeranno alcuni adattatori per particolari necessità quali l'adattatore SCSI, AGP, eccetera. Quando si installano gli adattatori sugli slot della scheda madre, si ricorda di fissarli con le viti anche sul pannello posteriore del telaio.

Per informazioni dettagliate si prega di fare riferimento alla versione integrale del Manuale utente.

Collegamento dei connettori d'alimentazione ai connettori J3/J5

Ricordarsi che è necessario spingere con fermezza fino in fondo il connettore della sorgente d'alimentazione ATX al connettore J3/J5, assicurando così un buon collegamento.

Impostazione BIOS

Quando l'hardware è stato installato completamente, accendere il computer ed andare alla voce BIOS per impostare i parametri del processore. Per informazioni dettagliate si prega di fare riferimento alla versione integrale del Manuale utente.

Chapter 1. Introduction

1-1. Features & Specifications

1. CPU

- Supports Intel® Pentium® 4 socket 478 processor with 400MHz/533MHz System Data Bus
- Supports Intel® Hyper-Threading Technology

2. Chipset

- Intel 82845PE (MCH) + 82801DB (ICH4)
- Supports Hi-Speed Universal Serial Bus (USB 2.0)
- Supports Ultra ATA/100/66/33 mode

3. Memory

- Three 184-pin DIMM sockets (un-buffered Non-ECC DIMM)
- Supports 3 DIMM DDR 200/266 (Max. 2GB)
- Supports 2 DIMM DDR 333 (Max. 2GB)

4. LAN

- Onboard Broadcom Gigabit PCI Ethernet Controller (For BE7-G)
- Onboard 10/100M PCI Fast Ethernet Controller (For BE7-S, BE7-RAID, BE7-B, BE7)

5. Serial ATA 150 (For BE7-G & BE7-S)

- Onboard Silicon Image Serial ATA PCI Controller
- Support 2 ports SATA 150 (1.5G bps)

6. ATA133 RAID (For BE7-RAID)

- HighPoint HPT372 IDE controller
- Supports Ultra ATA 133MB/sec data transfer rate
- Supports RAID 0 (Stripping mode for boosting performance) mode
- Supports RAID 1 (Mirroring mode for data security) mode
- Supports RAID 0+1 (Stripping and Mirroring) mode

7. Audio

- Onboard RealTek ALC650 6-Channel AC 97 CODEC
- Professional digital audio interface supports 24-bit S/PDIF Out

8. System BIOS

- SoftMenu™ Technology to set CPU parameters
- Supports Plug-and-Play (PNP)
- Supports Advanced Configuration Power Interface (ACPI)
- Supports Desktop Management Interface (DMI)
- Write-Protect Anti-Virus function by AWARD BIOS

9. Internal I/O Connectors

- 1 x AGP slot
- 5 x PCI slots
- 1 x Floppy port supports up to 2.88MB
- 2 x Ultra ATA 33/66/100 connectors
- 2 x Ultra ATA 33/66/100/133 connectors (For BE7-RAID)
- 2 x Serial ATA 150 connectors (For BE7-G & BE7-S)
- 2 x USB headers
- 1 x CD-IN, 1 x AUX-IN header
- 1 x IrDA header

10. Back Panel I/O

- 1 x PS/2 Keyboard, 1 x PS/2 mouse
- 2 x Serial port connectors, 1 x Parallel port connector
- 1 x S/PDIF Out connector
- AUDIO1 connector (Rear-Left / Rear-Right, Center/Subwoofer)
- AUDIO2 connector (Mic-In, Line-In, Front-Left/Front-Right)
- 2 x USB, 1 x RJ-45 LAN Connector

11. Miscellaneous

- ATX form factor
- Hardware Monitoring – including Fan Speed, Voltages, CPU and system temperature and one thermal header for other devices temperature monitoring
- Supports Wake Up by LAN, Modem Ring, RTC Alarm, Keyboard and Mouse Power On
- Supports STR (Suspend to RAM)

※ **The Switching Power Supply must meet ATX 2.03 specification with ATX12V and AUX Power connectors.**

※ **Specifications and information contained herein are subject to change without notice.**

1-2. Layout Diagram (BE7-G)

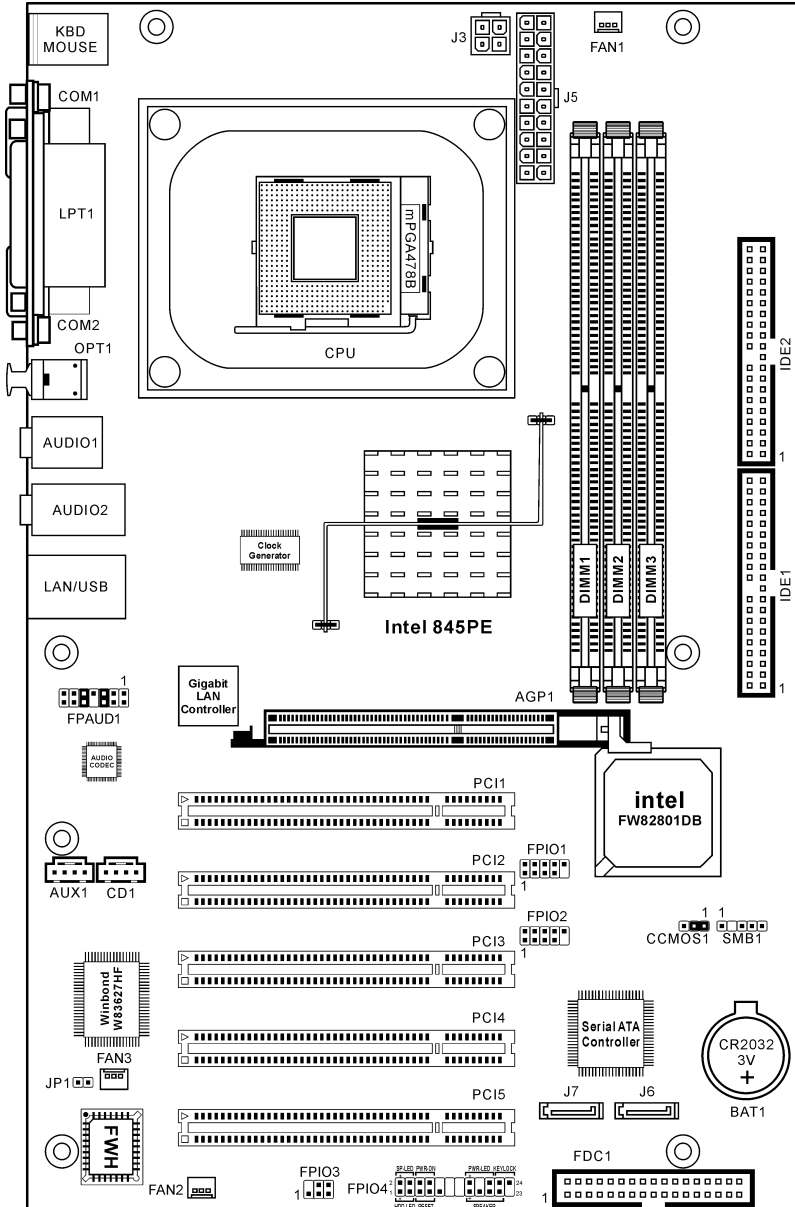

1-4. Layout Diagram (BE7-RAID)

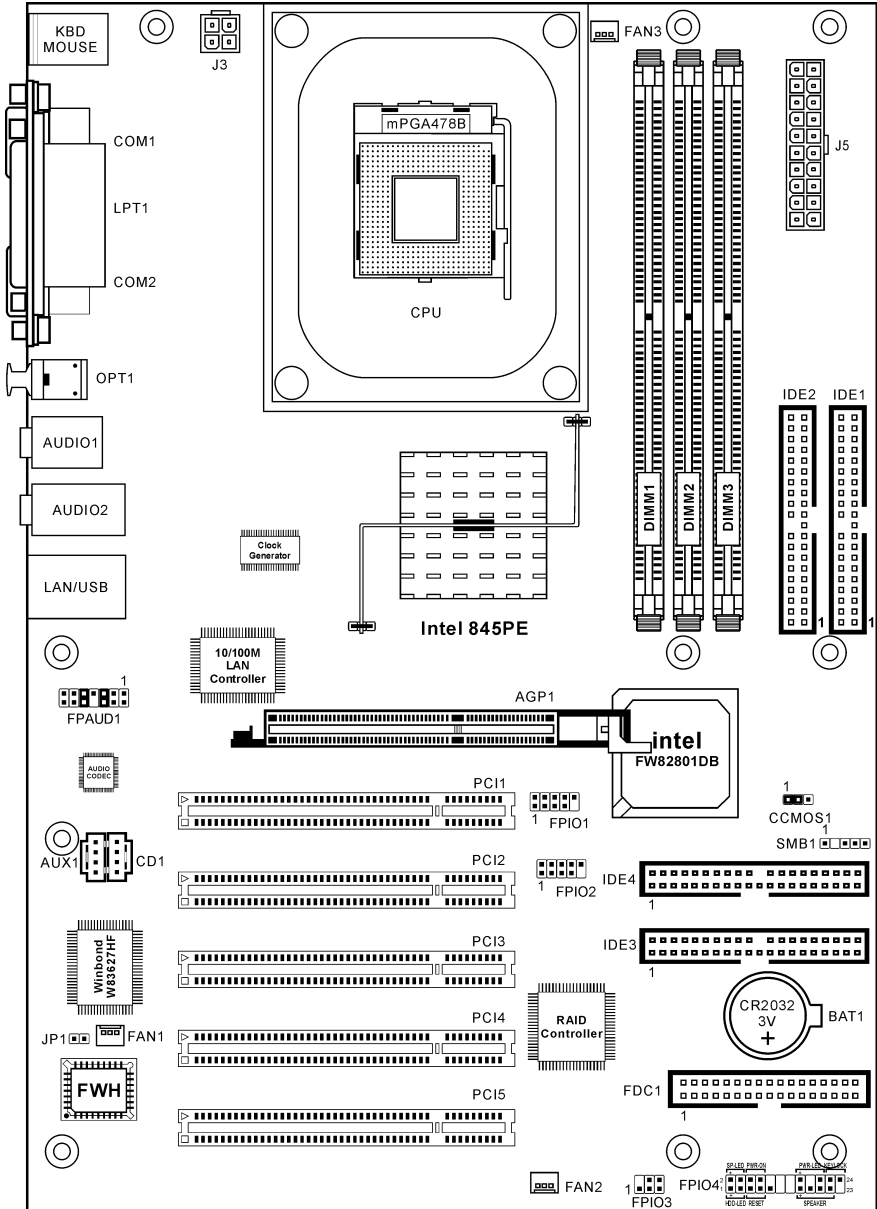

1-5. Layout Diagram (BE7-B)

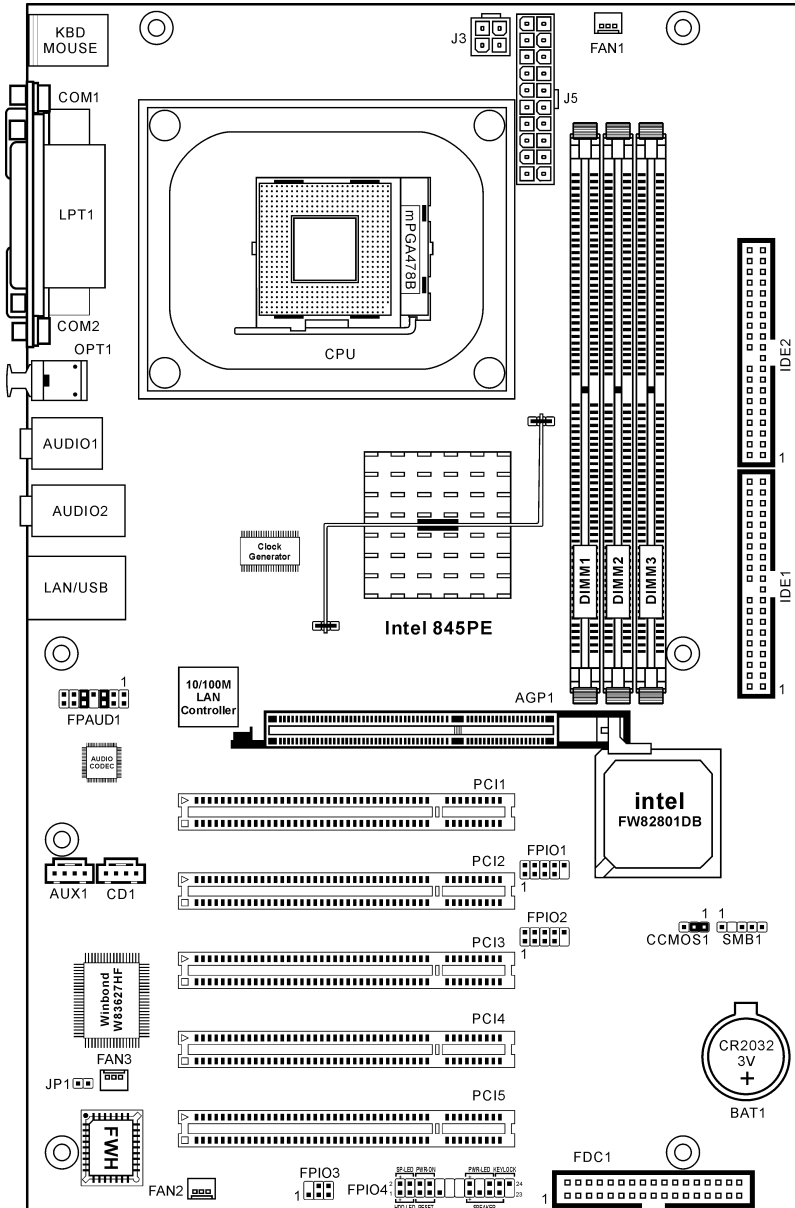

1-6. Layout Diagram (BE7)

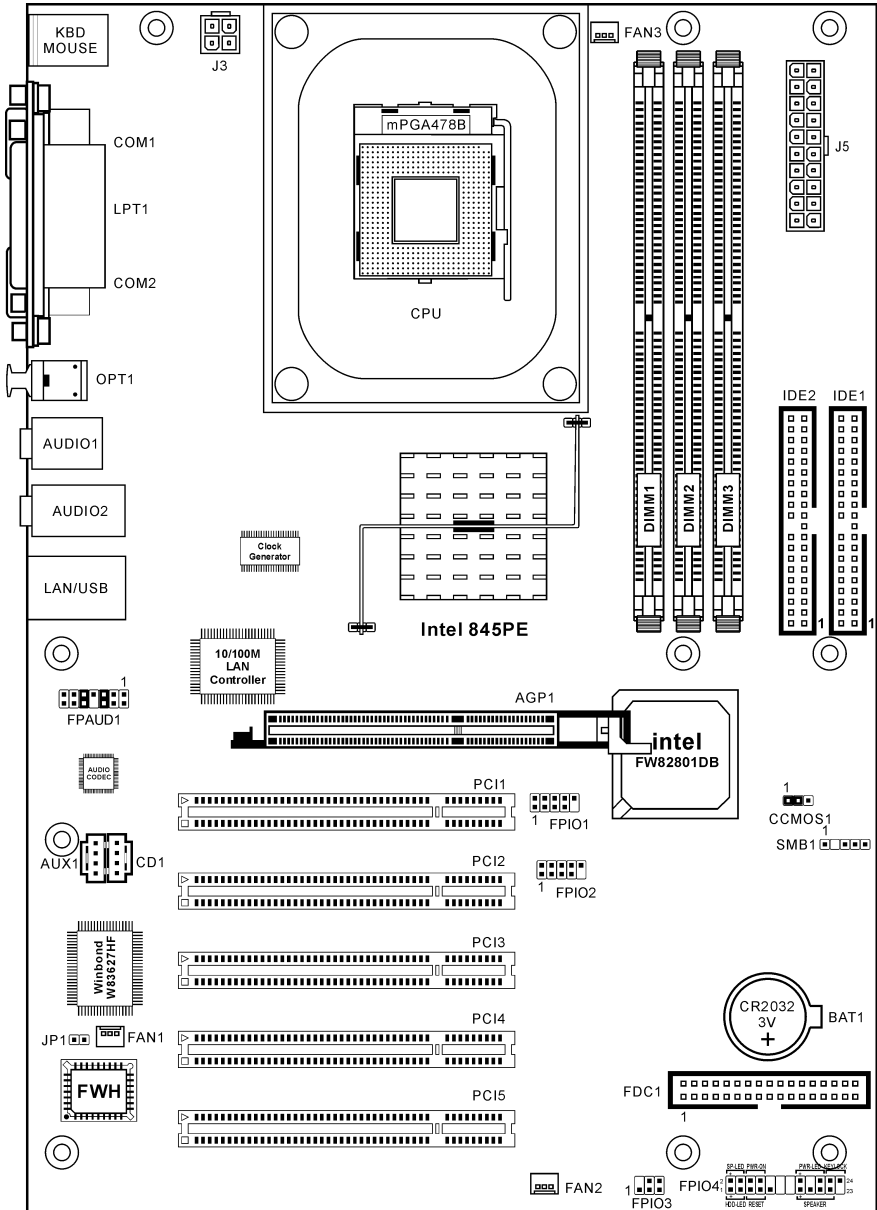



Chapter 2. Hardware Setup

It is required to adopt an ATX12V power supply to meet the power requirement of Pentium® 4

This motherboard provides all standard equipment for classic personal computers with great flexibility for meeting future upgrade demands. This chapter will introduce step-by-step all of the standard equipment and will also present, as completely as possible, future upgrade capabilities.

This chapter is organized with the following features:

- 2-1 Install The Motherboard
- 2-2 Install Pentium® 4 CPU and Heatsink Supporting-Base
- 2-3 Install System Memory
- 2-4 Connectors, Headers and Switches

Before Proceeding with the Installation: Please be reminded to turn the ATX12V power supply switch off (fully turn the +5V standby power off), or disconnect the power cord before you install or unplug any connectors or add-on cards. Failing to do so may cause the motherboard components or add-on cards to malfunction or damaged.

2-1. Install The Motherboard

Most computer chassis have a base with many mounting holes to allow motherboard to be securely attached on and at the same time, prevented from short circuits. There are two ways to attach the motherboard to the chassis base:

- use with studs
- or use with spacers

Figure 2-1 shows the shape of studs and spacers. There may be several types, but all look similar.

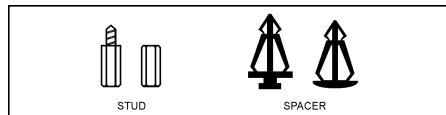

Figure 2-1. The outline of stud and spacer.

In principle, the best way to attach the board is to use with studs. Only if you are unable to do this should you attach the board with spacers. Line up the holes on the board with the mounting holes on the chassis. If the holes line up and there are screw holes, you can attach the board with studs. If the holes line up and there are only slots, you can only attach with spacers. Take the tip of the spacers and insert them into the slots. After doing this to all the slots, you can slide the board into position aligned with slots. After the board has been positioned, check to make sure everything is OK before putting the chassis back on. Figure 2-2 shows the ways to fix the board to chassis by studs or spacers.

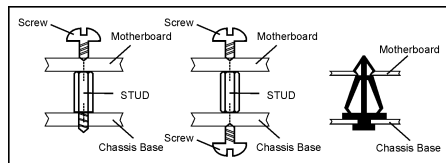

Figure 2-2. The way we fixed the motherboard.

ATTENTION: To prevent shorting the PCB circuit, please REMOVE the metal studs or spacers if they are already fastened on the chassis base and are without mounting-holes on the motherboard to align with.

2-2. Install Pentium® 4 CPU and Heatsink Supporting-Base

This motherboard provides a ZIF (Zero Insertion Force) Socket 478 to install Intel® Pentium® 4 CPU. The CPU you bought should have a kit of heatsink and cooling fan along with. If that's not the case, buy one specially designed for Pentium® 4 Socket 478. Please refer to figure 2-3 to install CPU.

1. Locate the Socket 478. Fasten the heatsink supporting-base onto the motherboard.

ATTENTION: If you are using chassis specially designed for Pentium® 4, please pay attention to the location of metal studs or spacers if they are already installed on the chassis. Be careful not let the metal studs or spacers contact the printed circuit wire or parts on the PCB.

2. Pull the CPU socket lever sideways away from the socket and then upwards to 90 degree. Insert the CPU with the correct orientation. Do not use extra force to insert CPU; it only fit in one orientation. Closing down the socket lever while holding down the CPU.
3. Put the heatsink faces down onto the CPU until it completely covers the CPU.
4. Put the heatsink supporting-cover onto the heatsink. Make sure all the four locking clasp at each side of the supporting cover reach in the locking holes.
5. Push down the retaining clip at both sides of the supporting cover to lock up together with the supporting base. Watch out the direction for pushing down the clip.
6. The heatsink supporting cover and base should now firmly locking up with each other with the heatsink inside.

ATTENTION: Do not forget to set the correct bus frequency and multiple for your processor.

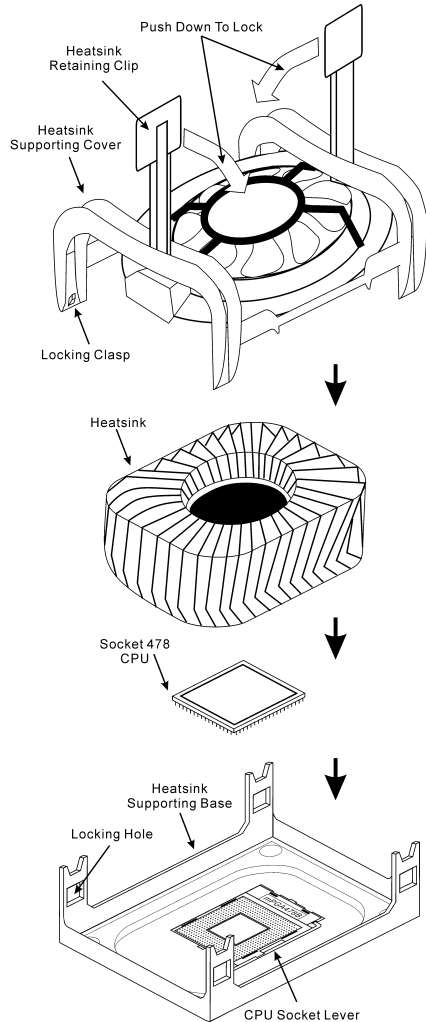

Figure 2-3. Installing P4 Socket 478 CPU and its heatsink into supporting base.

2-3. Install System Memory

This motherboard provides three 184-pin DDR DIMM sites for memory expansion available from minimum memory size of 64MB to maximum memory size of 2GB DDR SDRAM (DIMM2 & DIMM3 are sharing).

Table 2-1. Valid Memory Configurations

Bank	Memory Module	Total Memory
Bank 0, 1 (DIMM1)	64, 128, 256, 512MB, 1GB	64MB ~ 1GB
Bank 2, 3 (DIMM2)	64, 128, 256, 512MB, 1GB	64MB ~ 1GB
Bank 3, 2 (DIMM3)	64, 128, 256, 512MB, 1GB	64MB ~ 1GB
Total System Memory		64MB ~ 2GB

ATTENTION: Static electricity can damage the electronic components of the computer or optional boards. Before starting these procedures, ensure that you are discharged of static electricity by touching a grounded metal object briefly.

1. Power off the computer and disconnect the AC power cord.
2. Locate the DDR DIMM slot.
3. Push both ejector tabs of the DDR DIMM slot outward.
4. Insert the memory module into the DDR DIMM slot. Note how the module is keyed to the slot. ***This insures the memory module will be plugged into the slot in one way only.***
5. Firmly press the memory module into the DDR DIMM slot until both ejector tabs snap into places.

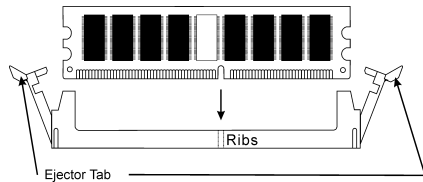

Figure 2-4. Memory module installation

2-4. Connectors, Headers and Switches

Inside the case of any computer there are several cables and plugs that have to be connected. These cables and plugs are usually connected one-by-one to connectors located on the board. You have to pay attention carefully to any connection orientation the cables may have and, if any, notice the position of the first pin.

Here we will show you all of the connectors, headers and switches, and how to connect them. Please read the entire section for necessary information before attempting to finish all the hardware installation inside the computer chassis. A complete enlarged layout diagram is shown in Chapter 1 for all the position of connectors and headers on the board that you may refer to.

All the connectors, headers and switches mentioned here are depending on your system configuration. Some features you may (or may not) have to connect or to configure depending on the peripherals you have connected.

WARNING: Always power off the computer and unplug the AC power cord before adding or removing any peripheral or component. Failing to do so may cause severe damage to your motherboard and/or peripherals. Plug in the AC power cord only after you have carefully checked everything.

(1). ATX12V: ATX Power Input Connectors

The Pentium 4 requires a power supplier different from the regular one. It's a newly designed ATX12V power with 300W, 20A +5VDC capacity at least for heavily loaded system, and 720mA +5VSB at least for supporting Wake-On-LAN feature.

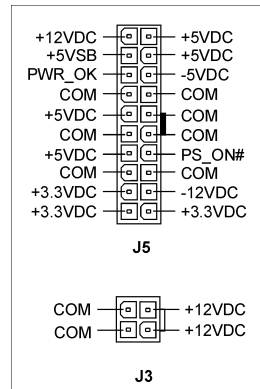
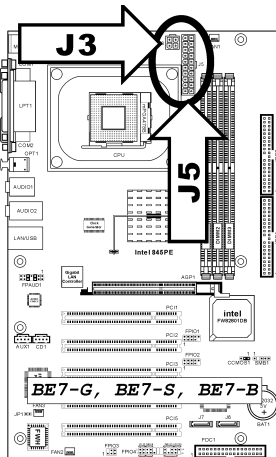
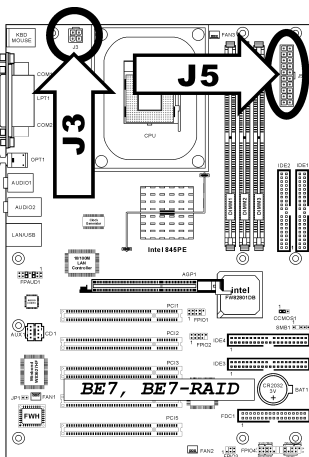

(2). **FAN Connectors:**

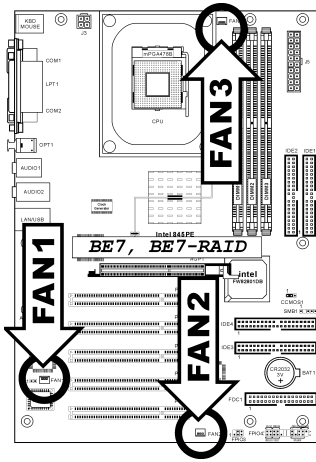

FAN1: Power Fan
FAN2: Chassis Fan
FAN3: CPU Fan

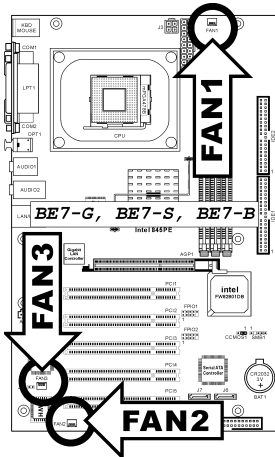
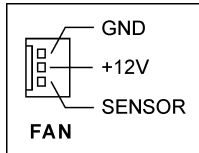

FAN1: CPU Fan
FAN2: Chassis Fan
FAN3: Power Fan

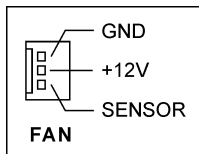

(3). CCMOS1: CMOS Memory Clearing Header

This header uses a jumper to clear the CMOS memory. Short pin 2 and pin 3 only when you want to clear the CMOS memory. The default setting is pin 1 and pin 2 shorted for normal operation.

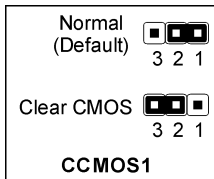
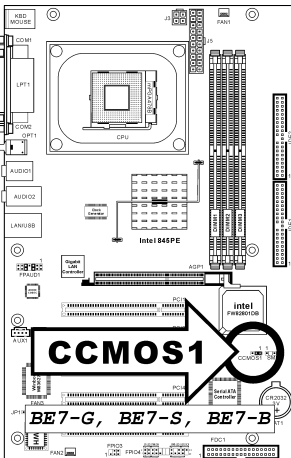
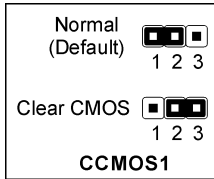
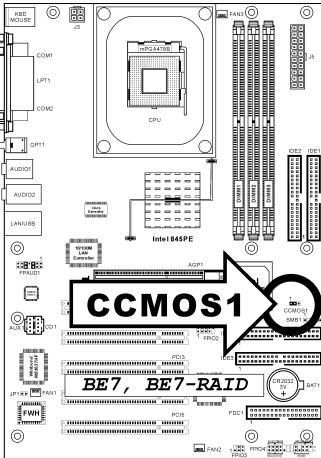

NOTE: Turn the power off first (including the +5V standby power) before clearing the CMOS memory. Failing to do so may cause your system to work abnormally or malfunction.

(4). FPIO1/FPIO2: Additional USB Port Headers

This motherboard provides totally six USB 2.0 ports controlled by ICH4. Two of them are through the onboard USB connectors; four of them are capable through these two headers.

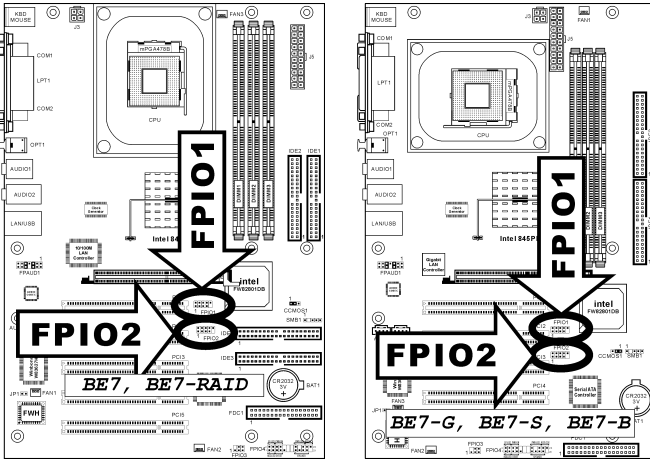

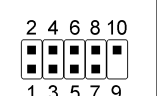
 FPIO1/FPIO2		Pin	Pin Assignment	Pin	Pin Assignment
	1	VCC	2	VCC	
	3	Data0 -	4	Data1 -	
	5	Data0 +	6	Data1 +	
	7	Ground	8	Ground	
	9	NC	10	NC	

(5). FPIO3: Infrared Device Header

This header connects to an optional IR device attached to chassis. This motherboard supports standard IR transfer rates.

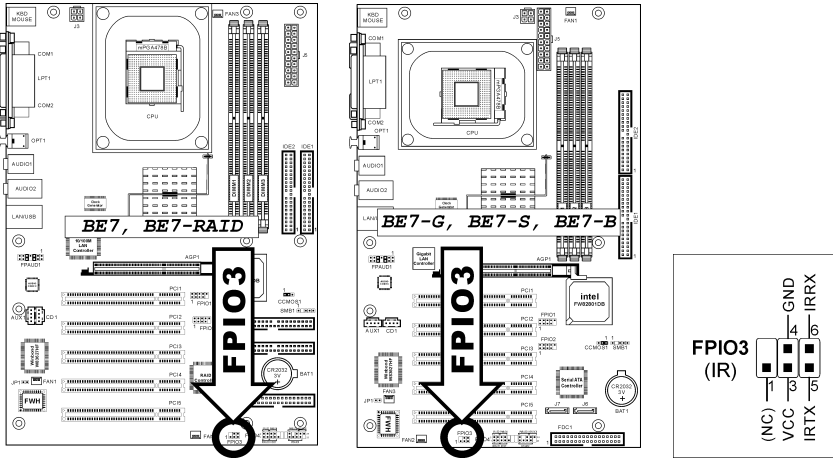

(6). FPIO4 Headers

This header is used for connecting switches and LED indicators on the chassis front panel.

Watch the power LED pin position and orientation. The mark “+” align to the pin in the figure below stands for positive polarity for the LED connection. Please pay attention to connect these headers. A wrong orientation will only cause the LED not lighting, but a wrong connection of the switches could cause system malfunction.

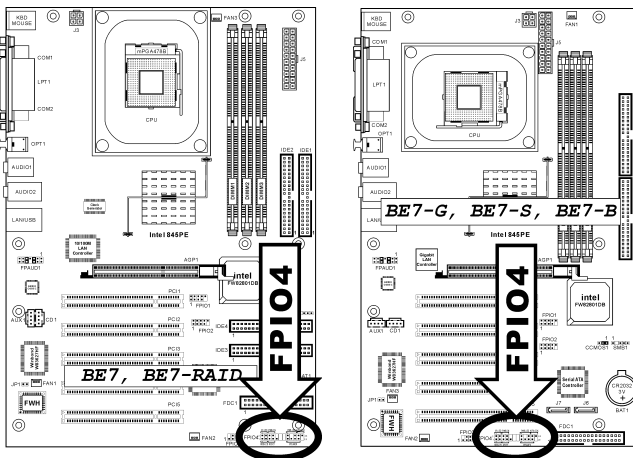

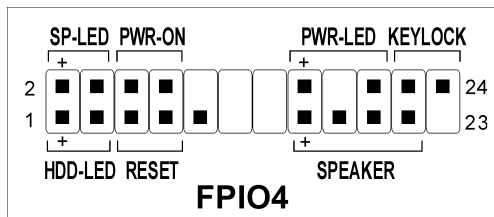

- **Pin 1, 3: HDD-LED**
Connects to the HDD LED cable of chassis front panel.
- **Pin 5, 7: RESET**
Connects to the Reset Switch cable of chassis front panel.
- **Pin 15, 17, 19, 21: SPEAKER**
Connects to the System Speaker cable of chassis.
- **Pin 2, 4: SP-LED**
Connects to the Suspend LED cable (if there is one) of chassis front panel.
- **Pin 6, 8: PWR-ON**
Connects to the Power Switch cable of chassis front panel.
- **Pin 16, 18, 20: PWR-LED**
Connects to the Power LED cable of chassis front panel.
- **Pin 22, 24: KEYLOCK**
Connects to the Keylock cable (if there is one) of chassis front panel.

(7). FPAUD1: Front panel audio connection header

This header provides the connection to audio connector at front panel.

- To use the audio connector at front panel, remove all the jumpers on this header, and then connect to front panel by the extension cable provided with the chassis.
- To use the audio connector at rear panel, disconnect the extension cable, attach the jumpers back at pin 5-6, and pin 9-10 (default setting).

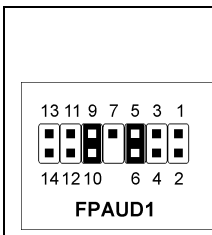
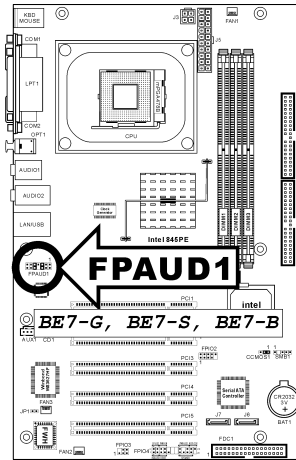
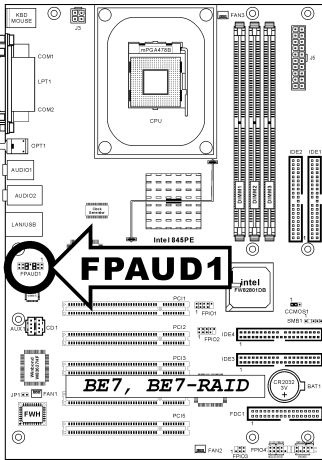

Pin	Pin Assignment	Pin	Pin Assignment
1	Audio Mic.	2	Ground
3	Audio Mic. Bias	4	VCC
5	Speaker Out Right Channel	6	Speaker Out Right Channel Return
7	X	8	NC
9	Speaker Out Left Channel	10	Speaker Out Left Channel Return
11	Ground	12	S/PDIF In
13	VCC	14	S/PDIF Out

(8). SMB1: System Management Bus Headers

This header is reserved for system management bus (SM bus). The SM bus is a specific implementation of an I²C bus. I²C is a multi-master bus, which means that multiple chips can be connected to the same bus and each one can act as a master by initiating a data transfer. If more than one master simultaneously tries to control the bus, an arbitration procedure decides which master gets priority.

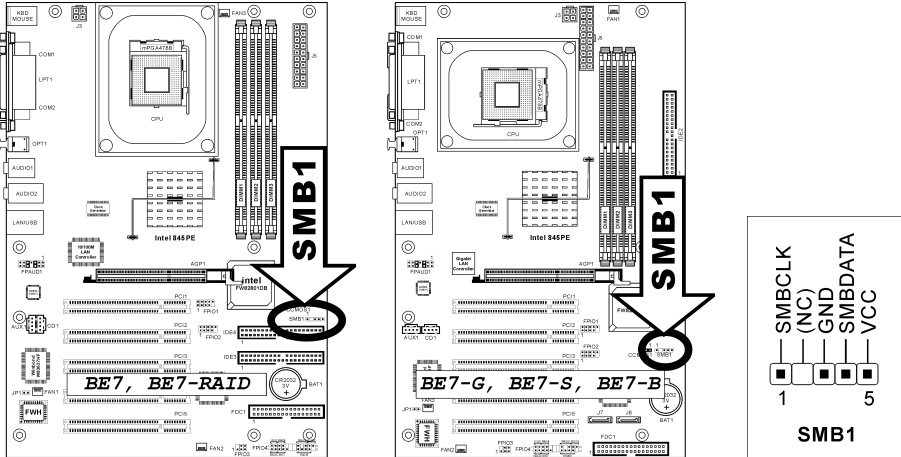

(9). JP1: Thermal Sensor Header

This connector is a thermal sensor connector used for detecting the system environmental temperature. It may also be called a system temperature detector. You can attach one end of a two-threaded thermal cable to this header, and attach the other end of the thermal cable onto any heat source, such as VGA chipset's heatsink, or Hard Disk Drive.

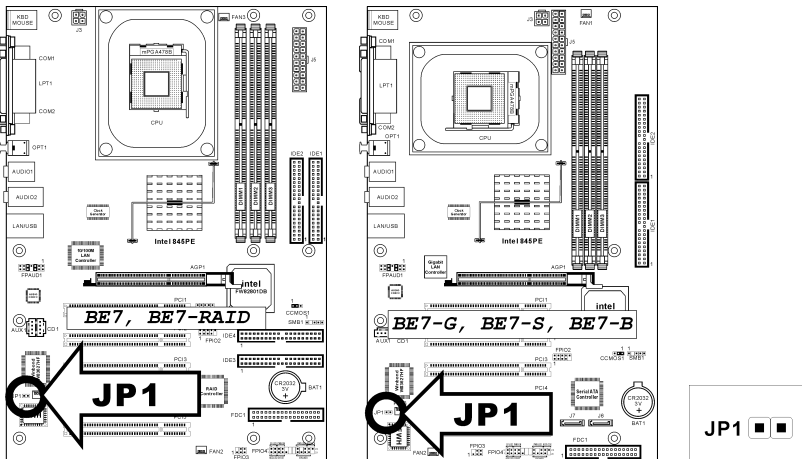

(10). **CD1, AUX1: Internal Audio Connector**

These connectors connect to the audio output of internal CD-ROM drive or add-on card.

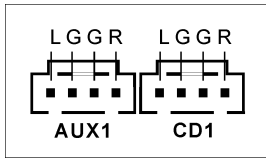
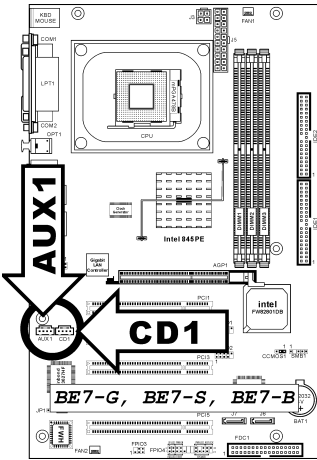
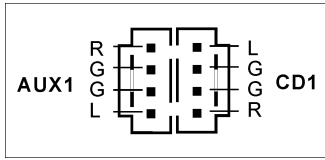
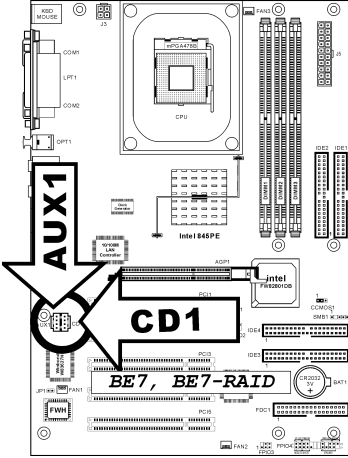

(11). AGP1: Accelerated Graphics Port Slot

This slot supports an optional AGP graphics card up to AGP 4X mode. Please refer to our Web site for more information on graphics cards.

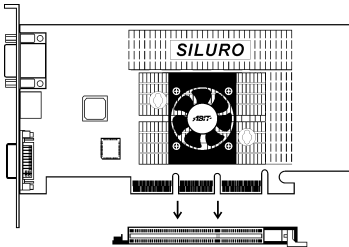
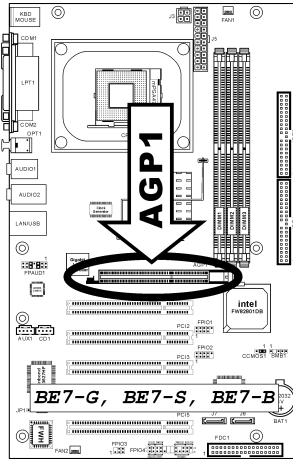
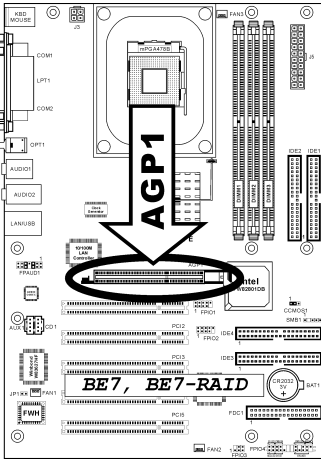

(12). FDC1 Connector

There are 34 wires and two connectors on each floppy cable providing two floppy disk drives connection. Connect the single end at the longer length of ribbon cable to this FDC1, and the two connectors on the other end to the floppy disk drives. Generally you need only one floppy disk drive in your system.

Note: The red line on the ribbon cable should be aligned with pin 1 on this connector.

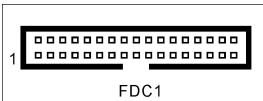
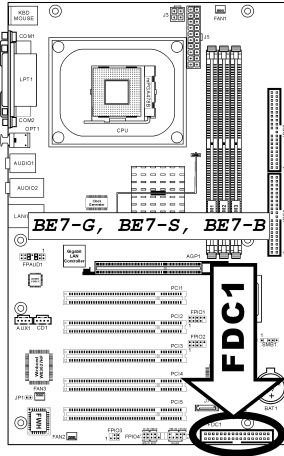
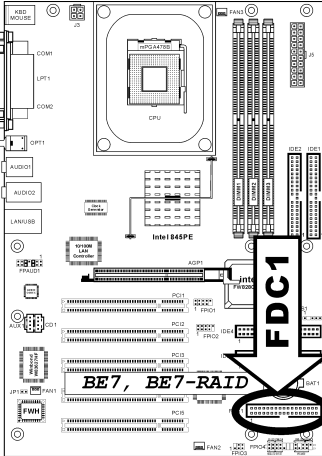

(13). IDE1/IDE2 and IDE3/IDE4 Connectors

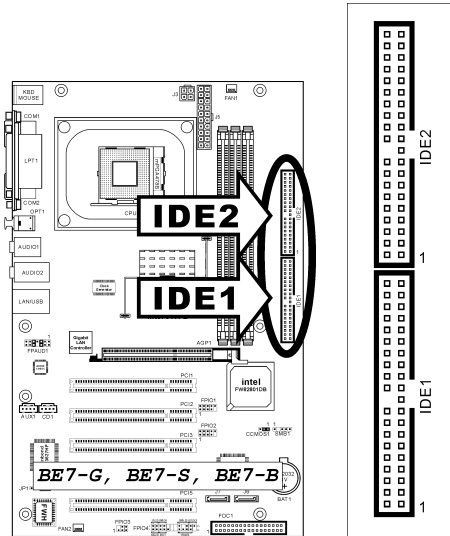
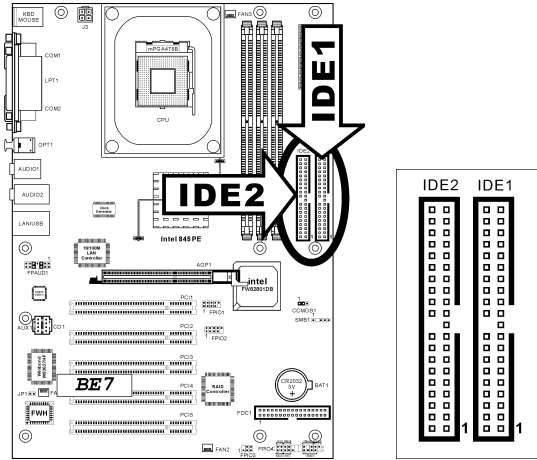

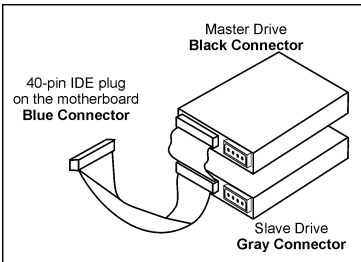
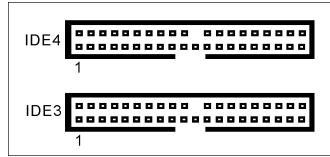
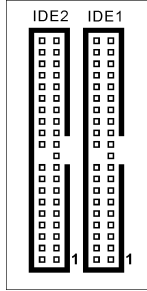
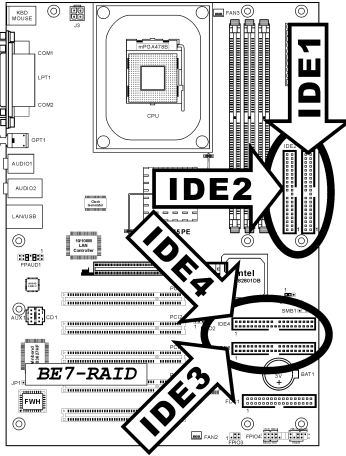

This motherboard provides two IDE ports to connect up to four IDE drives at Ultra ATA/100 mode by Ultra ATA/66 ribbon cables. Each cable has 40-pin 80-conductor and three connectors, providing two hard drives connection with motherboard. Connect the single end (blue connector) at the longer length of ribbon cable to the IDE port on motherboard, and the other two ends (gray and black connector) at the shorter length of the ribbon cable to the connectors on hard drives.

If you want to connect two hard drives together through one IDE channel, you must configure the second drive to Slave mode after the first Master drive. Please refer to the drives' documentation for jumper settings. The first drive connected to IDE1 is usually referred to as "Primary Master", and the second drive as "Primary Slave". The first drive connected to IDE2 is referred to as "Secondary Master" and the second drive as "Secondary Slave".

Keep away from connecting one legacy slow speed drive, like CD-ROM, together with another hard drive on the same IDE channel; this will drop your integral system performance.

For BE7-RAID: IDE3 and IDE4 are extra devices controlled by a HighPoint HPT372 chipset. This bonus feature allows for having regular Ultra ATA/133 devices ports, or a RAID array in the combination of RAID 0, RAID 1, or RAID 0+1 mode.

(14). J6/J7: Serial ATA Connector (For BE7-G & BE7-S)

These two connectors are provided to attach one serial ATA device at each channel through Serial ATA cable. It is also possible to connect legacy IDE hard disk through an optional SERILLEL Converter.

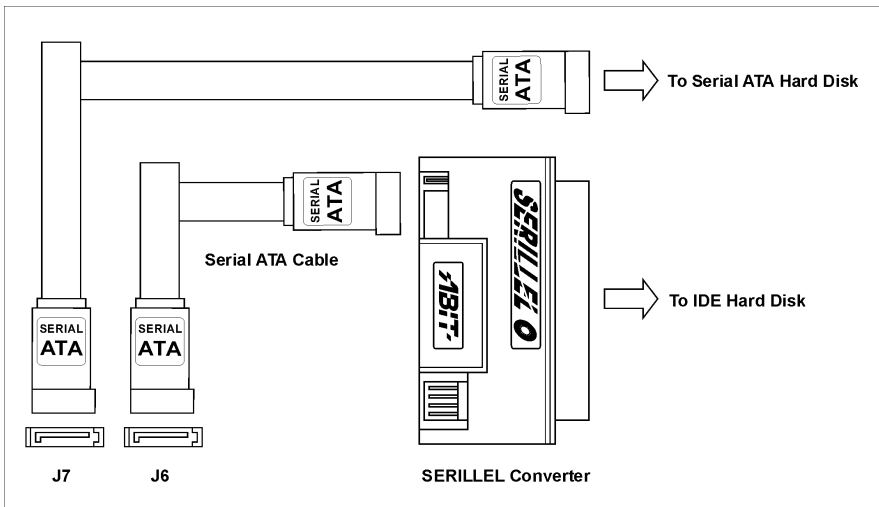
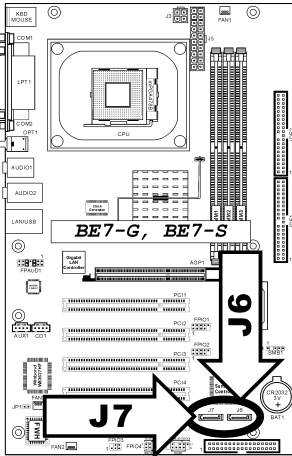

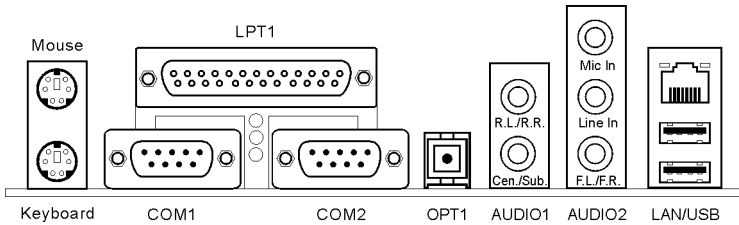
(15). Back Panel Connectors

- Mouse: PS/2 Mouse Connector**
 Attach a PS/2 mouse to this 6-pin Din-connector.
- Keyboard: PS/2 Keyboard Connector**
 Attach a PS/2 keyboard connector to this 6-pin Din-connector. If you use an AT keyboard, you can go to a computer store to purchase an AT to ATX converter adapter. You can then connect your AT keyboard to this connector. We suggest you use a PS/2 keyboard for best compatibility.
- Parallel Port Connector**
 This parallel port is also called an “LPT” port because it usually connects to the printer. You can connect other devices that support this communication protocol, like an EPP/ECP scanner, etc.
- Serial Port COM1 & COM2 Connector**
 This motherboard provides two COM ports to connect external modem, mouse or other devices that support this communication protocol.
- OPT1**
 This connector provides an S/PDIF out connection through optical fiber to digital multimedia devices.
- AUDIO1**
R.L./R.R. (Rear Left / Rear Right): Connects to the rear left and rear right channel in the 5.1 channel audio system.
Cen./Sub. (Center / Subwoofer): Connects to the center and subwoofer channel in the 5.1 channel audio system.
- AUDIO2**
Mic In: Connects to the plug from external microphone.
Line In: Connects to the line out from external audio sources.
F.L./F.R. (Front Left / Front Right): Connects to the front left and front right channel in the 5.1-channel or regular 2-channel audio system.
- LAN Connector**
 You can connect your system to Local Area Network through this LAN connector.
- USB Port Connectors**
 This motherboard provides two on-board USB2.0 ports to attach USB devices such as scanner, digital speakers, monitor, mouse, keyboard, hub, digital camera, joystick etc.

Chapter 3. BIOS Setup

The BIOS is a program located on a Flash Memory chip on the motherboard. This program will not be lost when you turn the computer off. This program is also referred to as the boot program. It is the only channel the hardware circuit has to communicate with the operating system. Its main function is to manage the setup of the motherboard and interface card parameters, including simple parameters such as time, date, hard disk drive, as well as more complex parameters such as hardware synchronization, device operating mode, **CPU SoftMenu™ III** features and setup of CPU speed. The computer will operate normally, or will operate at its best, only if all of these parameters are correctly configured through the BIOS.

Don't change the parameters inside the BIOS unless you fully understand their meanings and consequences: The parameters inside the BIOS are used to setup the hardware synchronization or the device-operating mode. If the parameters are not correct, they will produce errors, the computer will crash, and sometimes you will not even be able to boot the computer after it has crashed. We recommend that you do not change the parameters inside the BIOS unless you are very familiar with them. If you are not able to boot your computer anymore, please refer to the section “**Erase CMOS data**” in Chapter 2.

When you start the computer, the BIOS program controls it. The BIOS first operates an auto-diagnostic test called POST (Power On Self Test) for all of the necessary hardware. It then configures the parameters of the hardware synchronization, and detects all of the hardware. Only when these tasks are completed does it give up control of the computer to the next level, which is the operating system (OS). Since the BIOS is the only channel for hardware and software to communicate, it is the key factor for system stability, and in ensuring that your system performs at its best. After the BIOS has achieved the auto-diagnostic and auto-detection operations, it will display the following message:

PRESS DEL TO ENTER SETUP

The message will be displayed for three to five seconds, if you press the key, you will access the BIOS Setup menu. At that moment, the BIOS will display the following screen:

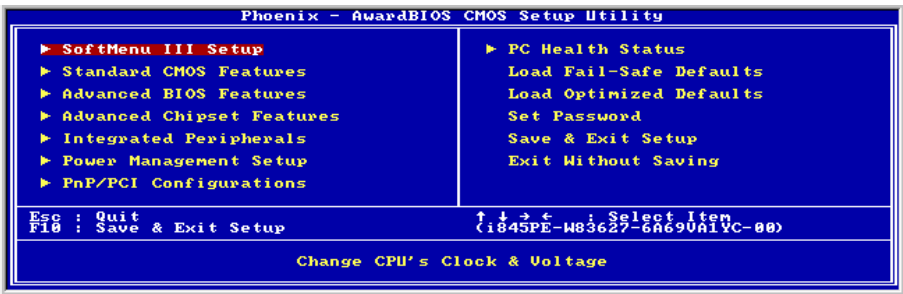

Figure 3-1. CMOS Setup Utility

NOTE: Because the BIOS menu is being constantly improved to increase stability and performance, the BIOS screens in this manual may not completely match your BIOS version. All the default settings in this chapter are taken from the Load Optimized Defaults settings, which are different from those taken from Load Fail-Safe Defaults.

In the BIOS Setup main menu of Figure 3-1, you can see several options. We will explain these options step by step in the following pages of this chapter, but let us first see a short description of the function keys you may use here:

- Press **Esc** to quit the BIOS Setup.
- Press **↑ ↓ ← →** (up, down, left, right) to choose, in the main menu, the option you want to confirm or to modify.
- Press **F10** when you have completed the setup of BIOS parameters to save these parameters and to exit the BIOS Setup menu.
- Press **Page Up/Page Down** or **+/-** keys when you want to modify the BIOS parameters for the active option.

CMOS Data: Maybe you have heard somebody saying that his or her CMOS DATA was lost. What is the CMOS? Is it important? The CMOS is the memory used to store the BIOS parameters that you have configured. This memory is passive. You can read its data, and you can also store data in it. But this memory has to be powered by a battery in order to avoid any loss of its data when the computer is turned off. Since you may have to change the CMOS battery when it is out of power, and if doing so you will lose all CMOS data, we recommend that you write down all the parameters of your hardware, or to put a label with these parameters on your hard disk.

3-1. CPU Setup [SoftMenu™ III]

The CPU can be setup through a programmable switch (**CPU SoftMenu™ III**) that replaces the traditional manual hardware configuration. This feature allows the user to more easily complete the installation procedures. You can install the CPU without configuring any jumpers or switches. The CPU must be setup according to its specifications.

In the first option, you can press <F1> at any time to display all the items that can be chosen for that option.

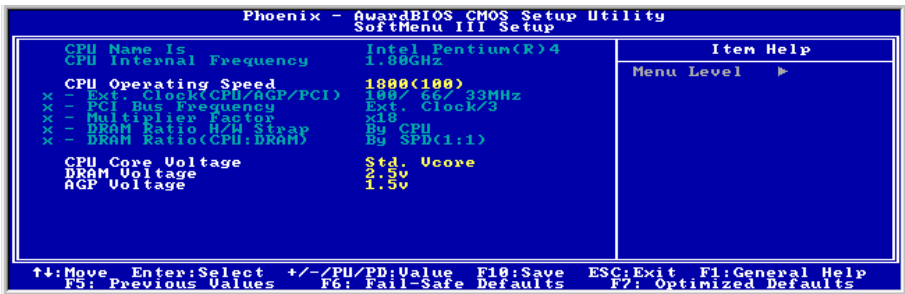

Figure 3-2. CPU SoftMenu™ III

CPU Name Is:

Intel Pentium (R) 4.

CPU Internal Frequency:

1.80GHz (depending on the CPU type).

CPU Operating Speed:

This option sets the CPU speed. In this field, the CPU speed is indicated like this: CPU Speed = External Clock x Multiplier Factor. Select the CPU speed according the type and speed of your CPU.

Normally, we do not recommend that you use the “User Define” option to setup CPU speed and multiplier factors. This option is for setup of future CPUs whose specifications are still unknown. The specifications of all present CPUs are included in the default settings. Unless you are very familiar with all CPU parameters, it is very easy to make mistakes when you define the external clock and the multiplier factor by yourself. When you complete the setting in this option, the POST will not check if the actual running speed is the same as the one you set.

User Define:

WARNING: The wrong settings of the multiplier and external clock in certain circumstances may cause CPU damage. Setting the working frequency higher than the PCI chipset or processor specs, may cause abnormal memory module functioning, system hangs, hard disk drive data lose, abnormal functioning of the VGA card, or abnormal functioning with other add-on cards. Using non-specification settings for your CPU is not the intention of this explanation. These should be used for engineering testing, not for normal applications.

If you use non-specification settings for normal operation, your system may not be stable, and may affect system reliability. Also, we do not guarantee the stability and compatibility for settings that are not within specification, and any damage of any elements on the motherboard or peripherals, is not our responsibility.

*** Ext. Clock (CPU/AGP/PCI):**

After choosing the “**CPU Operating Speed**” option as “**User Define**”, you can choose the external clock frequency from 100MHz to 250 MHz. The best frequency is either 100MHz or 133MHz depending on the CPU type and its speed. The default setting is **100MHz**.

*** PCI Bus Frequency:**

This item determines the PCI bus frequency. The options are: Ext. Clock/3, Ext. Clock/4, 44MHz (fixed), 37MHz (fixed), and 33MHz (fixed). The default setting is **Ext. Clock/3**.

*** Multiplier Factor:**

The multiplier factors for this motherboard are: x8, x9, x10, x11, x12 (These factors vary with the different type and specification of the CPU installed)

NOTE: Some processors might have this multiplier factor locked, so there is no way to choose a higher multiplier factor.

*** DRAM Ratio H/W Strap:**

This item sets the external hardware reset strap assigned to MCH (Memory Controller Hub). The options are: Low, High, and By CPU. The default setting is **By CPU**.

To set this option manually:

- Select “Low” for CPU of 400MHz FSB frequency.
- Select “High” for CPU of 533MHz FSB frequency.

*** DRAM Ratio (CPU:DRAM):**

This item determines the frequency ratio between CPU and DRAM. The options are: 1:1 and 3:4 (under Low “DRAM Ratio H/W Strap” settings), or 4:5 and 1:1 (under High “DRAM Ratio H/W Strap” settings). The default setting is **By SPD**.

Solution in case of booting problem due to invalid clock setup:

Normally, if the CPU clock setup is wrong, you will not be able to boot. In this case, turn the system off then on again. The CPU will automatically use its standard parameters to boot. You can then enter the BIOS Setup again and set up the CPU clock. If you can't enter the BIOS setup, you must try turning the system on a few times (3~4 times) or press <INSERT> when turning on, and the system will automatically use its standard parameters to boot. You can then enter BIOS SETUP again and set up the new parameters.

When you change your CPU:

This motherboard has been designed in such a way that you can turn the system on after having inserted a CPU in the socket without having to configure any jumpers or DIP switches. If you change your CPU, normally you just have to turn off the power supply, change the CPU and then set up the CPU parameters through **SoftMenu™ III**. However, if the new CPU is slower than the old one (and is the same brand and type), we offer you two methods to successfully complete the CPU change operation.

Method 1: Setup up the CPU for the lowest speed for its brand. Turn the power supply off and change the CPU. Then turn the system on again, and set up the CPU parameters through **SoftMenu™ III**.

Method 2: Since you have to open the computer case when you change the CPU, it would be a good idea to use the CMOS clearing jumper to erase the parameters of the original CPU and to enter BIOS Setup to set up CPU parameters again.

ATTENTION: After setting up the parameters and leaving the BIOS SETUP, and having verified that the system can be booted, do not press the Reset button or turn off the power supply. Otherwise the BIOS will not read correctly, the parameters will fail and you must enter **SoftMenu™ III** again to set up the parameters all over again.

CPU Core Voltage:

This item selects the CPU core voltage.

ATTENTION: A wrong voltage setting may cause the system unstable or even damage the CPU. Please leave it to default settings unless you are fully aware of its consequences.

DRAM Voltage:

This item selects the voltage for DRAM slot.

AGP Voltage (For BE7-G, BE7-S, and BE7-B):

This item selects the voltage for AGP slot.

3-2. Standard CMOS Features Setup Menu

This section contains the basic configuration parameters of the BIOS. These parameters include date, hour, VGA card, FDD and HDD settings.



Figure 3-3. Standard CMOS Setup Screen Shot

Date (mm:dd:yy):

You can set the date in this item: month (mm), date (dd) and year (yy).

Time (hh:mm:ss):

You can set the time in this item: hour (hh), minute (mm) and second (ss).

IDE Primary Master / Slave and IDE Secondary Master / Slave:

These items have a sub-menu to let you choose further options. You can refer to figure 3-4 to check what options are available.

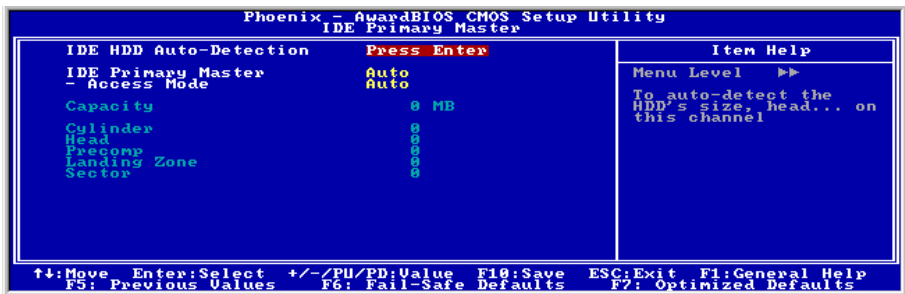

Figure 3-4. IDE Primary Master Setup Screen Shot

IDE HDD Auto-Detection:

Press the <Enter> key for the BIOS to auto detect all detailed parameters of the hard disk drives (HDD). If auto detection is successful, the correct values will be shown in the remaining items of this menu.

NOTE: A new IDE HDD must be first formatted, otherwise it can not read/write. The basic step in using a HDD is to make a **HDD low-level format**, then run FDISK, and then FORMAT the drive. Most current HDDs have already been subjected to low-level format at the factory, so you can probably skip this operation. Remember though, the primary IDE HDD must have its partition set to active within the FDISK procedure.

If you are using an old HDD that is already formatted, auto detection can not detect the correct parameters. You may need to do a low-level format or set the parameters manually, and then check if the HDD is working.

IDE Primary Master:

Three settings are available: *Auto*, *Manual* and *None*. If you choose Auto, the BIOS will automatically check what kind of hard disk you are using. If you want to set the HDD parameters yourself, make sure you fully understand the meaning of the parameters, and be sure to refer to the manual provided by the HDD manufacturer to get the settings right.

Access Mode:

Since old operating systems were only able to support HDDs with capacities no bigger than 528MB, any hard disk with more than 528MB was unusable. AWARD BIOS features a solution to this problem: you can, according to your operating system, choose four operating modes: NORMAL → LBA → LARGE → Auto.

The HDD auto detection option in the sub-menu will automatically detect the parameters of your hard disk and the mode supported.

Auto: Lets the BIOS detect your HDD access mode and make the decisions.

Normal mode: Standard normal mode supports hard disks of up to 528MB or less. This mode directly uses positions indicated by Cylinders (CYLS), Heads, and Sectors to access data.

LBA (Logical Block Addressing) mode: The earlier LBA mode can support HDD capacities of up to 8.4GB, and this mode uses a different method to calculate the position of disk data to be accessed. It translates Cylinders (CYLS), Heads and Sectors into a logical address where data is located. The Cylinders, Heads, and Sectors displayed in this menu do not reflect the actual structure of the hard disk. They are just reference values used to calculate actual positions. Currently, all high capacity hard disks support this mode and that is why **we recommend you use this mode**. Currently, the BIOS can support the INT 13h extension function, enabling the LBA mode to support hard disk drive capacities exceeding 8.4GB.

Large Mode: When the number of cylinders (CYLS) of the hard disk exceeds 1024 and DOS is not able to support it, or if your operating system does not support LBA mode, you should select this mode.

Capacity:

This item auto displays your HDD size. Note that this size is usually slightly greater than the size given by a disk checking program of a formatted disk.

NOTE: All the items below are available when you set the item “Primary IDE Master” to “Manual”.

Cylinder:

When disks are placed directly above one another along the shaft, the circular vertical “slice” consisting of all the tracks located in a particular position is called a cylinder. You can set the number of cylinders for a HDD. The minimum number you can enter is 0, the maximum number you can enter is 65536.

Head:

This is the tiny electromagnetic coil and metal pole used to create and read back the magnetic patterns on the disk (also called the read/write head). You can configure the number of read/write heads. The minimum number you can enter is 0, the maximum number you can enter is 255.

Precomp:

The minimum number you can enter is 0, the maximum number you can enter is 65536.

WARNING: Setting a value of 65536 means no hard disk exists.

Landing Zone:

This is a non-data area on the disk's inner cylinder where the heads can rest when the power is turned off. The minimum number you can enter is 0, the maximum number you can enter is 65536.

Sector:

The minimum segment of track length that can be assigned to stored data. Sectors usually are grouped into blocks or logical blocks that function as the smallest units of data permit. You can configure this item to sectors per track. The minimum number you can enter is 0, the maximum number you can enter is 255.

Drive A & Drive B:

If you have installed the floppy disk drive here, then you can select the type of floppy drive it can support. Six options are available: None → 360K, 5.25in. → 1.2M, 5.25in. → 720K, 3.5in. → 1.44M, 3.5in. → 2.88M, 3.5in.

Floppy 3 Mode Support:

Four options are available: Disabled → Driver A → Driver B → Both. The default setting is *Disabled*. 3 Mode floppy disk drives (FDD) are 3 1/2” drives used in Japanese computer systems. If you need to access data stored in this kind of floppy, you must select this mode, and of course you must have a 3 Mode floppy drive.

Video:

You can select the VGA modes for your video adapter, four options are available: EGA/VGA → CGA 40 → CGA 80 → MONO. The default setting is *EGA/VGA*.

Halt On:

You can select which type of error will cause the system to halt. Five options are available: All Errors → No Errors → All, But Keyboard → All, But Diskette → All, But Disk/Key.

You can see your system memory list in the lower left box, it shows the *Base Memory*, *Extended Memory* and *total Memory size* configurations in your system. It is detected by the system during boot-up procedure.

3-3. Advanced BIOS Features Setup Menu

With each item, you can press <Enter> at any time to display all the options for that item.

ATTENTION: Advanced BIOS Features Setup Menu has already been set for maximum operation. If you do not really understand each of the options in this menu, we recommend you use the default values.



Figure 3-5. Advanced BIOS Features Setup Screen

Virus Warning:

When this feature is enabled, if there is any attempt from a software or an application to access the boot sector or the partition table, the BIOS will warn you that a boot virus is attempting to access the hard disk.

CPU Hyper-Threading

Leave this item to its default setting to enable the simultaneous multi-threaded (SMT) processor so as to make one physical processor looks like two logical processors to the OS and applications.

This option is for CPU with Hyper-Threading Technology only. For more information on “Hyper-Threading Technology”, please visit Intel Web site at

<http://www.intel.com/homepage/land/hypertexting.htm> , <http://www.intel.com/design/chipsets/ht/>.

Quick Power On Self Test:

After the computer has been powered on, the BIOS of the motherboard will run a series of tests in order to check the system and its peripherals. If the Quick Power on Self-Test feature is enabled, the BIOS will simplify the test procedures in order to speed up the boot process. The default setting is *Enabled*.

First Boot Device:

When the computer boots up, the BIOS attempts to load the operating system from the devices in the sequence selected in these items: floppy disk drive A, LS/ZIP devices, hard drive C, SCSI hard disk drive or CD-ROM. There are eleven options for the boot sequence that you can choose (The default setting is *Floppy*):

Floppy → LS120 → HDD-0 → SCSI → CDROM → HDD-1 → HDD-2 → HDD-3 → ZIP100 → LAN
 → ATA133RAID → Disabled.

Second Boot Device:

Description is the same as the *First Boot Device*, the default setting is **HDD-0**.

Third Boot Device:

Description is the same as the *First Boot Device*, the default setting is **CDROM**.

Boot Other Device:

Two options are available; Enabled or Disabled. The default setting is **Enabled**. This setting allows the BIOS to try three kinds of boot devices that are set from the above three items.

Swap Floppy Drive:

This item can be set as Enabled or Disabled. The default setting is **Disabled**. When this feature is enabled, you don't need to open the computer case to swap the position of floppy disk drive connectors. Drive A can be set as drive B and drive B can be set as drive A.

Boot Up Floppy Seek:

When the computer boots up, the BIOS detects if the system has an FDD or not. When this item is enabled, if the BIOS detect no floppy drive, it will display a floppy disk drive error message. If this item is disabled, the BIOS will skip this test. The default setting is **Disabled**.

Boot Up NumLock Status:

On: At boot up, the Numeric Keypad is in numeric mode. (Default Settings)

Off: At boot up, the Numeric Keypad is in cursor control mode.

Disable Unused PCI Clock:

This option disables the clock of PCI slot that is not in use.

Security Option:

This option can be set to System or Setup. The default setting is **Setup**. After you have created a password through PASSWORD SETTING, this option will deny access to your system (System) or modification of computer setup (BIOS Setup) by unauthorized users.

SYSTEM: When you choose System, a password is required each time the computer boots up. If the correct password is not given, the system will not start.

SETUP: When you choose Setup, a password is required only when accessing the BIOS Setup. If the correct password is not given, you can't enter the BIOS setup menu.

To disable security, select *Set Supervisor Password* at main menu and then you will be asked to enter the password. Do not type anything and just press the <Enter> key and it will disable security. Once security is disabled, the system will boot and you can enter the *BIOS setup menu* freely

NOTE: Don't forget your password. If you forget the password, you will have to open the computer case and clear all information in the CMOS before you can start up the system. But by doing this, you will have to reset all previously set options.

APIC Mode:

Two options are available: Enabled or Disabled. The default setting is *Enabled*.

MPS Version Ctrl For OS:

This item specifies which version of MPS (Multi-Processor Specification) this motherboard will use. The options are 1.1 and 1.4. The default setting is *1.4*. If you use an older OS for dual processor executing, please set this option to 1.1.

OS Select For DRAM > 64MB:

When the system memory is bigger than 64MB, the communication method between the BIOS and the operating system will differ from one operating system to another. If you use OS/2, select *OS2*; if you are using another operating system, select *Non-OS2*. The default setting is *Non-OS2*.

Report No FDD For OS:

When you are running some older Windows version without floppy drive, set this item to *Yes*. Otherwise, set it to *No*. The default setting is *No*.

Delay IDE Initial (Secs):

This item is used to support some old models or special types of hard disks or CD-ROMs. They may need a longer amount of time to initialize and prepare for activation. Since the BIOS may not detect those kinds of devices during system booting. You can adjust the value to fit such devices. Larger values will give more delay time to the device. The minimum number you can enter is 0, the maximum number you can enter is 15. The default setting is *0*.

3-4. Advanced Chipset Features Setup Menu

The Chipset Features Setup Menu is used to modify the contents of the buffers in the chipset on the motherboard. Since the parameters of the buffers are closely related to hardware, if the setup is not correct or is false, the motherboard will become unstable or you will not be able to boot up. If you don't know the hardware very well, use default values (i.e. use the LOAD SETUP DEFAULTS option). The only time you might consider making any changes is if you discover that data is being lost while using your system.

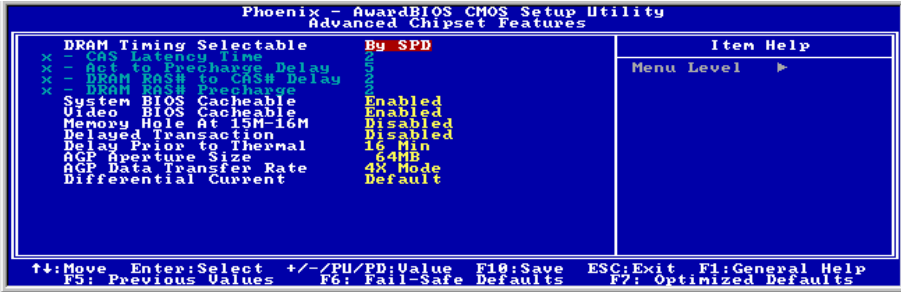

Figure 3-6. Chipset Features Setup Screen

You can use the arrow keys to move between the items. Use **↑**, **↓** and **<Enter>** key to change the values. When you have finished setting up the chipset, press **<Esc>** to go back to the main menu.

NOTE: The parameters in this screen are for system designers, service personnel, and technically competent users only. Do not reset these values unless you understand the consequences of your changes.

The first chipset settings deal with CPU access to DRAM. The default timings have been carefully chosen and should only be altered if data is being lost. Such a scenario might well occur if your system has mixed speed DRAM chips installed. In such a case, greater delays may be required to preserve the integrity of the data held in the slower memory chips.

DRAM Timing Selectable:

This item sets the optimal timings for the following four items, depending on the memory module you are using. The default setting "By SPD" configures these four items by reading the contents in the SPD (Serial Presence Detect) device. The EEPROM on the memory module stores critical parameter information about the module, such as memory type, size, speed, voltage interface, and module banks.

* **CAS Latency Time:**

This item controls the latency between the DRAM read command and the time that the data becomes actually available. The options are: 1.5, 2, and 2.5.

* **Act to Precharge Delay:**

The options are: 7, 6, and 5.

* **DRAM RAS# to CAS# Delay**

This item controls the latency between the DRAM active command and the read/write command. The options are: 2 and 3.

*** DRAM RAS# Precharge:**

This item controls the idle clocks after issuing a precharge command to the DRAM.

System BIOS Cacheable:

You can select Enabled or Disabled. The default setting is *Enabled*. When you select *Enabled* allows caching of the system BIOS ROM at F0000h-FFFFFh, resulting in better system performance. However, if any program writes to this memory area, a system error may result.

Video BIOS Cacheable:

You can select Enabled or Disabled. The default setting is *Enabled*. *Enabled* allows caching of the video BIOS, resulting in better system performance. However, if any program writes to this memory area, a system error may result.

Video RAM Cacheable:

Two options are available: Enabled and Disabled. The default setting is *Disabled*. *Enabled* allows you to get faster video RAM executing speed via the L2 cache. You must check your VGA adapter documentation to see if any compatibility problem will occur.

Memory Hole At 15M-16M:

Two options are available: Enabled and Disabled. The default setting is *Disabled*. This option is used to reserve the memory block 15M-16M for ISA adapter ROM. Some special peripherals need to use a memory block located between 15M and 16M, and this memory block has a size of 1M. We recommend that you disable this option.

Delayed Transaction:

Two options are available: Enabled and Disabled. The default setting is *Disabled*. Set the option to enabled or disabled PCI 2.1 features including passive release and delayed transaction for the chipset. This function is used to meet the latency of PCI cycles to or from the ISA bus. This option must be enabled to provide PCI 2.1 compliance. If you have an ISA card compatibility problem, you can try to enable or disable this option for optimal results.

Delay Prior to Thermal:

The options are: 4, 8, 16, and 32 Minutes. The default setting is *16 Min.*

AGP Aperture Size:

The options are: 4, 8, 16, 32, 64, 128, and 256MB. The default setting is *64MB*. This option specifies the amount of system memory that can be used by the AGP device. The aperture is a portion of the PCI memory address range dedicated for graphics memory address space. Host cycles that hit the aperture range are forwarded to the AGP without any translation. See www.agpforum.org for AGP information.

AGP Data Transfer Rate:

You can select the AGP device data transfer rate capability. Two options are available: 2X Mode and 4X Mode. The default setting is *4X Mode*.

Differential Current:

This option allows you to select the current multiple of CPU clock. The options are: 4x, 6x, 5x, 7x, and Default.

3-5. Integrated Peripherals

In this menu, you can change the onboard I/O device, I/O port address and other hardware settings.



Figure 3-7. Integrated Peripherals Menu Screen

OnChip IDE Device(s):

Press <Enter> key to enter the OnChip IDE Device(s) menu.

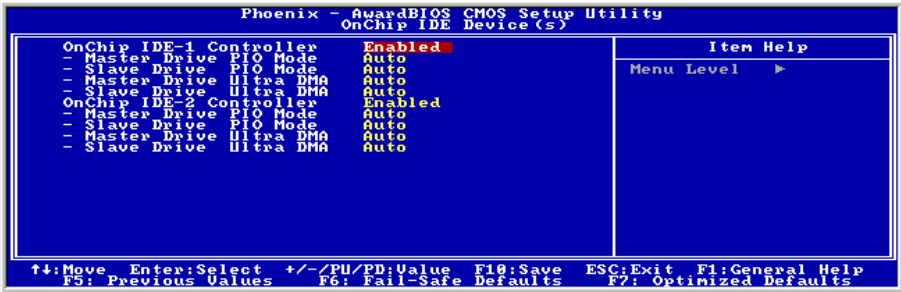

OnChip IDE-1 Controller:

The OnChip IDE 1 Controller can be set as Enabled or Disabled. The default setting is *Enabled*. The integrated peripheral controller contains an IDE interface with support for two IDE channels. If you choose *Disabled*, it will affect the settings of four items not available. For example, if you disabled the *OnChip IDE-1 Controller*, you will also disable the *Master/Slave Drive PIO Mode* and *Master/Slave Drive Ultra DMA*.

* **Master/Slave Drive PIO Mode**

Six options are available: Auto → Mode 0 → Mode 1 → Mode 2 → Mode 3 → Mode 4. The five IDE PIO (Programmed Input/Output) items let you set a PIO mode (0-4) for each of the four IDE devices that the onboard IDE interface supports. Modes 0 through 4 provide successively increased performance. In Auto mode (default setting), the system automatically determines the best mode for each device.

* Master/Slave Drive Ultra DMA

Two options are available: Auto and Disabled. The default setting is *Auto*. Ultra DMA is a DMA data transfer protocol that utilizes ATA commands and the ATA bus to allow DMA commands to transfer data at a maximum burst rate of 100 MB/sec.

Ultra DMA/33 or Ultra DMA/66/100 implementation is possible only if your IDE hard drive supports it and the operating environment includes a DMA driver (Windows® 95 OSR2 / 98 / ME / NT / 2000 or a third-party IDE bus master driver).

Auto: If your hard drive and your system software both support Ultra DMA, select *Auto* to enable BIOS support.

Disabled: If you encounter a problem in using Ultra DMA devices, you can try to disable this item.

OnChip IDE-2 Controller:

The description is same as the *OnChip IDE-1 Controller*.

OnChip PCI Device(s):

Press <Enter> key to enter the OnChip PCI Device(s) menu.

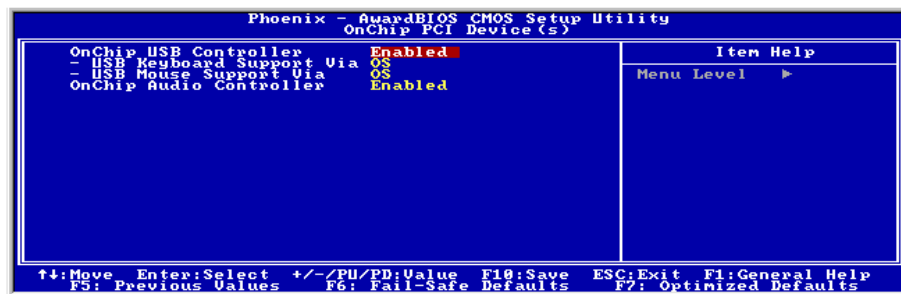

OnChip USB Controller:

Two options are available: Enabled and Disabled. The default setting is *Enabled*. This motherboard provides two Universal Serial Bus (USB) ports, thus supporting USB devices. If you don't want to use USB devices, set it to *Disabled*, then the item *USB Keyboard Support & USB Mouse Support* will also be disabled.

* USB Keyboard Support Via:

Two options are available: OS and BIOS. The default setting is *OS*. If you want to use USB keyboard in DOS environment, please set it to BIOS.

* USB Mouse Support Via:

Two options are available: OS and BIOS. The default setting is *OS*. If you want to use USB mouse in DOS environment, please set it to BIOS.

OnChip Audio Controller:

This option enables or disables the audio controller. The default setting is *Enabled*.

Init Display First:

Two options are available: PCI Slot and AGP. The default setting is *PCI Slot*. When you install an additional display card, you can choose either a PCI display card or an AGP display card to activate the display boot-up screen.

Onboard PCI Device(s):

Press <Enter> key to enter the Onboard PCI Device(s) menu.

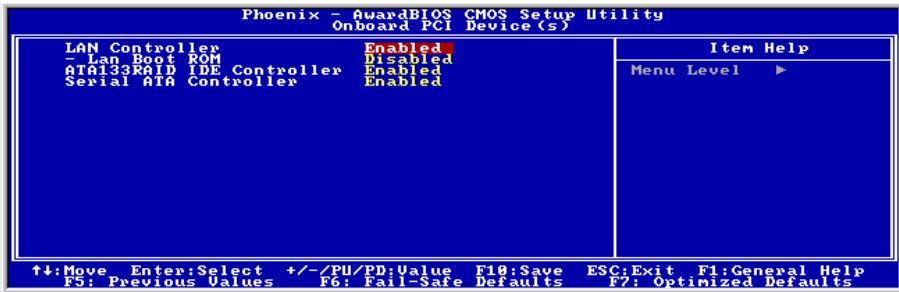
**LAN Controller:**

This option enables or disables the LAN controller. The default setting is *Enabled*.

LAN Boot ROM:

This option enables or disables the Boot ROM on LAN controller. The default setting is *Enabled*.

ATA133RAID IDE Controller (For BE7-RAID):

This item selects the onboard ATA133RAID controller. When set to [Enabled], two additional channels will be provided for adding high performance devices to system.

Serial ATA Controller (For BE7-G and BE7-S):

This item selects the onboard Serial ATA controller. When set to [Enabled], two additional channels will be provided for adding high performance devices to system.

Onboard FDD Controller:

Two options are available: Enabled and Disabled. The default setting is *Enabled*. You can enable or disable the onboard FDD controller.

Onboard Serial Port 1:

This is used to specify the I/O address and IRQ of Serial Port 1. Six options are available: Disabled → 3F8/IRQ4 → 2F8/IRQ3 → 3E8/IRQ4 → 2E8/IRQ3 → AUTO. The default setting is *3F8/IRQ4*.

Onboard Serial Port 2:

This is used to specify the I/O address and IRQ of Serial Port 2. Six options are available: Disabled →

3F8/IRQ4 → 2F8/IRQ3 → 3E8/IRQ4 → 2E8/IRQ3 → AUTO. The default setting is **2F8/IRQ3**.

Onboard IR Function: Three options are available: IrDA (HPSIR) mode → ASK IR (Amplitude Shift Keyed IR) mode → Disabled. The default setting is **Disabled**.

RxD , TxD Active: Four options are available: Hi, Hi → Hi, Lo → Lo, Hi → Lo, Lo. The default setting is **Hi, Lo**. Set IR transmission/reception polarity as High or Low.

IR Transmission Delay: Two options are available: Enabled and Disabled. The default setting is **Enabled**. Set IR transmission delays 4 character-time (40 bit-time) when SIR is changed from RX mode to TX mode.

UR2 Duplex Mode: Two options are available: Full and Half. The default setting is **Half**. This item lets you choose the operation mode for your IR KIT. Some IR device only can work at half duplex mode. Refer to your IR KIT user's guide to find out which setting is correct.

Use IR Pins: Two options are available: Rx2, Tx2 and IR-Rx2Tx2. The default setting is **IR-Rx2Tx2**. If you choose *RxD2*, *TxD2*, your motherboard must support a COM port IR KIT connection. Otherwise, you can only choose the *IR-Rx2Tx2* to use the IR header on your motherboard to connect your IR KIT. Please use the default setting.

Onboard Parallel Port:

Sets the I/O address and IRQ of the onboard parallel port. Four options are available: Disable → 378/IRQ7 → 278/IRQ5 → 3BC/IRQ7. Default setting is **378/IRQ7**.

Parallel Port Mode: Four options are available: SPP → EPP → ECP → ECP+EPP. The default setting is **SPP** mode.

EPP Mode Select: Two options are available: EPP1.7 → EPP1.9. The default setting is **EPP 1.7**. When the mode selected for the parallel port mode is EPP, the two EPP version options are available.

ECP Mode Use DMA: Two options are available: 1 → 3. The default setting is **3**. When the mode selected for the parallel port mode is ECP, the DMA channel selected can be Channel 1 or Channel 3.

3-6. Power Management Setup Menu

This menu allows you to set up the power management in order to reduce power consumption.

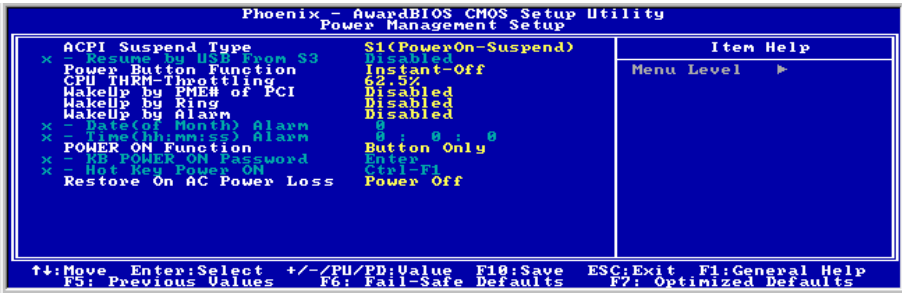

Figure 3-8. Power Management Setup Menu

If you want ACPI (Advanced Configuration and Power Interface) functions to work normally, you should notice two things. One is your operating system must support ACPI. The second thing is that all devices and add-on cards in your system must fully support ACPI, both hardware and software (drivers). If you want to know if your devices or add-on cards support ACPI or not, please contact the device or add-on card manufacturer for more information. If you want to know more about ACPI specifications, please go to the address below for more detailed information: <http://www.acpi.info/>

ACPI requires an ACPI-aware operating system. ACPI features include:

- Plug and Play (including bus and device enumeration) and APM functionality normally contained in the BIOS.
- Power management control of individual devices, add-in cards (some add-in cards may require an ACPI-aware driver), video displays, and hard disk drives.
- A Soft-off feature that enables the operating system to power off the computer.
- Support for multiple wake-up events (see Table 3-1).
- Support for a front panel power and sleep mode switch. Table 3-2 describes the system states based on how long the power switch is pressed, depending on how ACPI is configured with an ACPI-aware operating system.

System States and Power States:

Under ACPI, the operating system directs all system and device power state transitions. The operating system puts devices in and out of low-power states based on user preferences and knowledge of how devices are being used by applications. Devices that are not being used can be turned off. The operating system uses information from applications and user settings to put the system as a whole into a low-power state.

Table 3-1: Wake Up Device and Events

The table below describes which devices or specific events can wake the computer from specific states.

These device/events can wake up the computer.....from this state
Power switch	Sleeping mode or power off mode
RTC alarm	Sleeping mode or power off mode
LAN	Sleeping mode or power off mode
Modem	Sleeping mode or power off mode
IR command	Sleeping mode
USB	Sleeping mode
PS/2 keyboard	Sleeping mode or power off mode
PS/2 mouse	Sleeping mode or power off mode

Table 3-2: Effect of Pressing the Power Switch

If the system is in this state.....and the power switch is pressed forthe system enters this state
Off	Less than four seconds	Power on
On	More than four seconds	Fail safe power off
On	Less than four seconds	Soft off/Suspend
Sleep	Less than four seconds	Wake up

ACPI Suspend Type:

Two options are available: S1(POS) and S3(STR). The default setting is **S1(POS)**. Generally, ACPI has six states: System S0 state, S1, S2, S3, S4, S5. S1 and S3 states are described below:

The S1 (POS) State (POS means Power On Suspend):

While the system is in the S1 sleeping state, its behavior is as described below:

- The processor is not executing instructions. The processor's complex context is maintained.
- Dynamic RAM context is maintained.
- Power Resources are in a state compatible with the system S1 state. All Power Resources that supply a System Level reference of S0 are in the OFF state.
- Devices states are compatible with the current Power Resource states. Only devices which solely reference Power Resources which are in the ON state for a given device state can be in that device state. In all other cases, the device is in the D3 (off) state.
- Devices that are enabled to wake the system and that can do so from their current device state can initiate a hardware event which transitions the system state to S0. This transition causes the processor to continue execution where it left off.

To transition into the S1 state, the operating software does not have to flush the processor's cache.

The S3 (STR) State (STR means Suspend to RAM):

The S3 state is logically lower than the S2 state and is assumed to conserve more power. The behavior of this state is defined as follows:

- Processor is not executing instructions. The processor complex context is not maintained.
- Dynamic RAM context is maintained.
- Power Resources are in a state compatible with the system S3 state. All Power Resources that supply a System Level reference of S0, S1, or S2 are in the OFF state.
- Devices states are compatible with the current Power Resource states. Only devices which solely reference Power Resources which are in the ON state for a given device state can be in that device state. In all other cases, the device is in the D3 (off) state.
- Devices that are enabled to wake the system and that can do so from their current device state can initiate a hardware event which transitions the system state to S0. This transition causes the processor to begin execution at its boot location. The BIOS performs initialization of core functions as required to exit an S3 state and passes control to the firmware resume vector. Please see the ACPI Specification Rev. 1.0 book section 9.3.2 for more details on BIOS initialization.

From the software point of view, this state is functionally the same as the S2 state. The operational difference can be that some Power Resources that could be left ON in the S2 state might not be available to the S3 state. As such, additional devices can be required to be in logically lower D0, D1, D2, or D3 state for S3 than S2. Similarly, some device wake events can function in S2 but not S3.

Because the processor context can be lost while in the S3 state, the transition to the S3 state requires that the operating software flush all dirty cache to DRAM.

* **The information above for system S0 & S3 were referring to ACPI Specification.**

Resume by USB From S3:

Two options are available: Enabled and Disabled. The default setting is *Disabled*.

Power Button Function:

Two options are available: Instant-off and Delay 4 Sec.. The default setting is *Instant-off*. Pressing the power button for more than four seconds forces the system to enter the Soft-Off state when the system has “hung”.

CPU THRM-Throttling

This option is used during Suspend To RAM (STR) mode. It controls the CPU speed as a percentage of regular power. The options include 87.5%, 75.0%, 62.5%, 50.0%, 37.5%, 25.0%, and 12.5%. The default setting is set at **62.5%**.

WakeUp by PME# of PCI:

Two options are available: Enabled and Disabled. Default setting is *Disabled*. This item can let you wake-up your computer by PCI devices. For instance, if you had installed a PCI LAN card with Wake-Up on LAN capability, then you could wake-up your computer from another computer via a network by sending a wake-up frame signal. This feature also allows the PCI card built-in hardware function to support the wake up function without special cables connected to the motherboard.

NOTE: This feature needs a specific network interface (optional). Also your ATX power supply +5V standby power must be at least 720mA compatible.

WakeUp by Ring:

Two options are available: Enabled and Disabled. Default setting is **Disabled**. If you connect an external modem to the onboard serial port, the system will be turned on when a telephone ring-up occurs.

WakeUp by Alarm:

Two options are available: Enabled and Disabled. Default setting is **Disabled**. The RTC alarm can turn on the system. You can set Date (of month) and Time (hour, minute, and second) when you set this item to **Enabled**.

POWER ON Function:

This item allows you to select by which way you want your system to power on. The options are: Password → Hot Key → Mouse Left → Mouse Right → Any Key → Button Only → Keyboard 98. The default setting is **Button Only**.

NOTE: The mouse wake up function can only be used with the PS/2 mouse, not with a mouse that uses the COM port and USB connection. *Mouse Left (Mouse Right)* means you need to double click the mouse *left (right)* button, for the computer to power on. You also need to note the compatibility issue with your PS/2 mouse. Some PS/2 mice cannot wake up the system because of compatibility problems. Also, if the specs of your keyboard are too old, it may fail to power on.

KB Power ON Password: This option allows you to set a password required in order to Power ON your computer. You will be asked to enter your password and then to confirm it. Do not forget your password. Should you forget your password, you will have to open your computer case, clear the CMOS and reset all parameters again in order to be able to utilize this function.

Hot Key Power ON: There are twelve options are available, Ctrl-F1 to Ctrl-F12. You can select this item and using the <Ctrl> plus the one of each function key (F1 to F12) to power on the computer. The default setting is **Ctrl-F1**.

Restore On AC Power Loss:

This item allows you to select the system action after a power failure. The options are: Power Off → Power On → Last State. The default setting is **Power Off**.

3-7. PnP/PCI Configurations

This section describes configuring the PCI bus system. PCI, or Personal Computer Interconnect, is a system which allows I/O devices to operate at speeds nearing the speed the CPU itself uses when communicating with its own special components. This section covers some very technical items and it is strongly recommended that only experienced users should make any changes to the default settings.



Figure 3-9. PnP/PCI Configurations Setup Screen Shot

Force Update ESCD:

If you want to clear ESCD data next time you boot up, and ask the BIOS to reset the settings for the Plug & Play ISA Card and the PCI Card, select Enabled. But the next time you boot up, this option will automatically be set as Disabled.

NOTE: The ESCD (Extended System Configuration Data) contains the IRQ, DMA, I/O port, memory information of the system. This is a specification and a feature specific to the Plug & Play BIOS.

Resources Controlled By:

Two options are available: Auto(ESCD) and Manual. Default setting is *Auto(ESCD)*. When the setting is Auto(ESCD), the *IRQ Resources* and *Memory Resources* can not be changed. When resources are controlled manually, the *IRQ Resources* and *Memory Resources* can then be changed.

PCI PnP devices compliant with the Plug and Play standard, whether designed for the PCI bus architecture.

The Award Plug and Play BIOS has the capability to automatically configure all of the boot and Plug and Play compatible devices. If you select *Auto (ESCD)*, The IRQ Resources item will be disabled, as the BIOS automatically assigns them. But if you have trouble in assigning the interrupt resources automatically, you can select *Manual* to set which IRQ is assigned to PCI PnP cards.

Figure 3-10 shows you the screen of IRQ resources. Each item has two options: PCI Device and Reserved. The default setting is *PCI Device*.

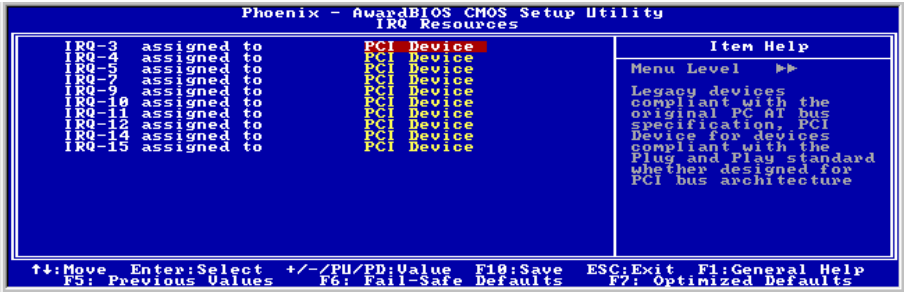

Figure 3-10. IRQ Resources Setup Screen Shot

PCI/VGA Palette Snoop:

This option allows the BIOS to preview VGA Status, and to modify the information delivered from the Feature Connector of the VGA card to the MPEG Card. This option can solve the display inversion to black after you have used the MPEG card.

Allocate IRQ To Video:

Two options are available: Disabled or Enabled. The default setting is *Enabled*. Name the interrupt request (IRQ) line assigned to the USB/VGA/ACPI (if any) on your system. Activity of the selected IRQ always awakens the system.

You can assign an IRQ for the PCI VGA or *Disabled*.

Allocate IRQ To USB:

Two options are available: Disabled or Enabled. The default setting is *Enabled*. If you need another IRQ to be freed up, you can choose to disable this item, and you can get an IRQ. But in some situations in Windows® 95 it may cause the USB port to malfunction or have other problems!

PCI Latency Timer(CLK):

This option selects the controls for the amount of time that the ICH arbiter allows a PCI initiator to perform multiple back-to-back transactions on the PCI bus. The options are: 32, 64, 96, 128, 160, 192, 224, and 248 PCI Clocks. The default setting is *32 PCI Clocks*.

PIRQ 0 Use IRQ No. ~PIRQ 7 Use IRQ No. :

The options are: Auto, 3, 4, 5, 7, 9, 10, 11, 12, 14, and 15. The default setting is *Auto*.

This item allows the IRQ number for the device installed on PCI slots to be specified by the system automatically or you can specify a fixed IRQ number. This is a useful function when you want to fix the IRQ for a specific device. For example, if you want to move your hard disk to another computer and don't want to re-install Windows® NT, then you can specify the IRQ for the device installed on the new computer to fit the original computer settings.

This feature is for the operating system that will record and fix the PCI configuration status, if you want to change it.

For the relations between the hardware layout of PIRQ (the signals from the ICH chipset), INT# (means PCI slot IRQ signals) and devices, please refer to the table below:

Signals	AGP	LAN	PCI-1	PCI-2	PCI-3	PCI-4	PCI-5	HPT372 (BE7-RAID)	SATA (BE7-G/S)
PIRQ_0 Assignment	INT A		INT D						
PIRQ_1 Assignment	INT B		INT A						
PIRQ_2 Assignment			INT B					INT A	INT A
PIRQ_3 Assignment		INT A	INT C						
PIRQ_4 Assignment				INT A	INT B	INT C	INT D		
PIRQ_5 Assignment				INT B	INT C	INT D	INT A		
PIRQ_6 Assignment				INT C	INT D	INT A	INT B		
PIRQ_7 Assignment				INT D	INT A	INT B	INT C		

3-8. PC Health Status

You can set the warning temperature for your computer system, and you can check the fan speeds and power supply voltages of your computer system. The features are useful for monitoring all the important parameters within your computer system. We call it the *PC Health Status*.

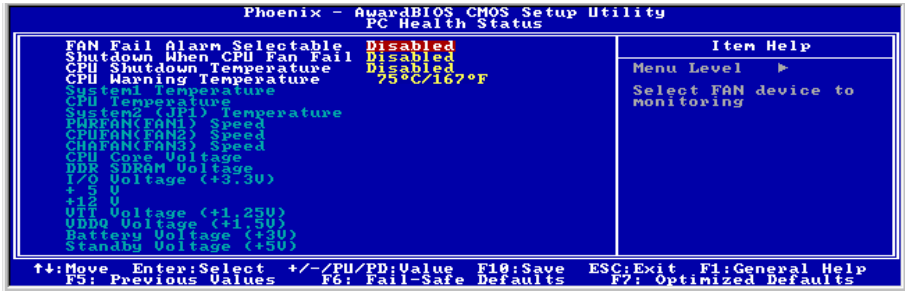

Figure 3-11. PC Health Status Screen Shot

FAN Fail Alarm Selectable:

This item lets you select which one of the fans will be monitored for malfunction. The options are: Disabled → PWRFAN → CPUFAN → CHAFAN → Auto. The default setting is *Disabled*.

Shutdown When CPU Fan Fail:

This item protects the CPU by shutting the system down if the fan of the option you select is not rotating. The options are: Disabled → Enabled. The default setting is *Disabled*.

If you select this option as Enabled, the system will be shut down:

- (1) Immediately when the fan fails in the process of POST.
- (2) Only when the fan fails in ACPI after the process of POST.

CPU Shutdown Temperature:

Once the system or CPU temperature exceeds the temperature specified, the CPU will shutdown automatically to avoid damaging. This function only works for an ACPI OS such as Windows 98/Windows 2000 with ACPI activated. The options are Disabled, 60°C/140°F, 65°C/149°F, 70°C/158°F, and 75°C/167°F. The default setting is *Disabled*.

CPU Warning Temperature:

This item lets you select the temperature at which you want the system to send out a warning message to the PC speakers of when the temperature goes beyond either limit. You can select the temperatures you want. The ranges are from 30°C/86°F to 120°C/248°F, default setting is *75°C/167°F*.

All Voltages, Fans Speed and Thermal Monitoring:

These unchangeable items list the current status of the CPU and environment temperatures, fan speeds, and system power voltage.

NOTE: The hardware monitoring features for temperatures, fans and voltages will occupy the I/O address from 294H to 297H. If you have a network adapter, sound card or other add-on cards that might use those I/O addresses, please adjust your add-on card I/O address to avoid using these addresses.

3-9. Load Fail-Safe Defaults

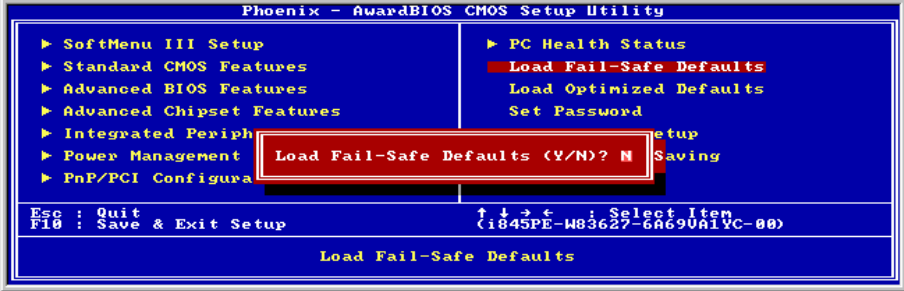

Figure 3-12. Load Fail-Safe Defaults Screen Shot

When you press <Enter> on this item you get a confirmation dialog box with a message similar to:

Load Fail-Safe Defaults (Y/N) ? N

Pressing “Y” loads the BIOS default values for the most stable, minimal-performance system operations.

3-10. Load Optimized Defaults

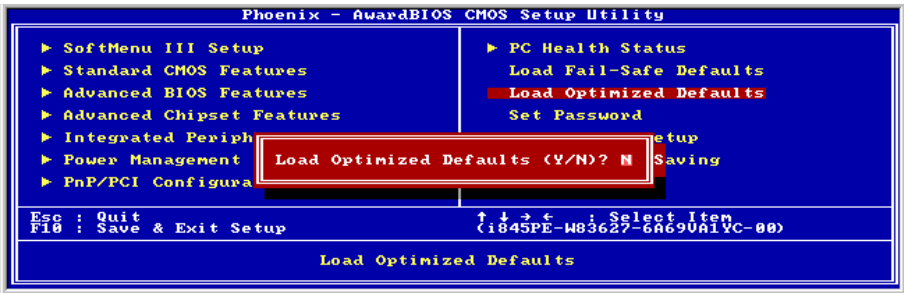

Figure 3-13. Load Optimized Defaults Screen Shot

When you press <Enter> on this item you get a confirmation dialog box with a message similar to:

Load Optimized Defaults (Y/N) ? N

Pressing “Y” loads the default values that are factory settings for optimal performance system operations.

3-11. Set Password

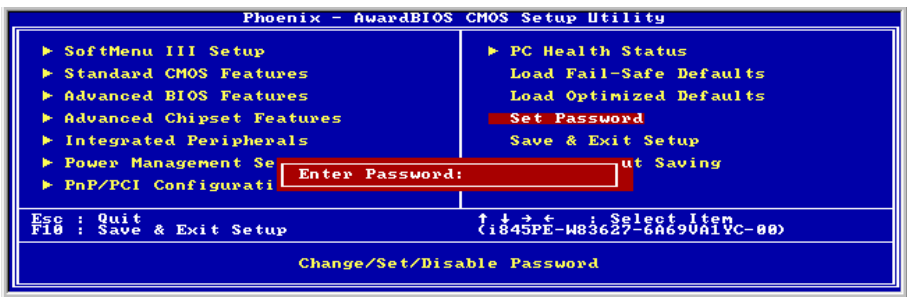

Figure 3-14. Set Password Screen Shot

Set Password: You can enter but do not have the right to change the options of the setup menus. When you select this function, the following message will appear at the center of the screen to assist you in creating a password.

ENTER PASSWORD:

Type the password, up to eight characters in length, and press <Enter>. The password typed now will clear any previously entered password from CMOS memory. You will be asked to confirm the password. Type the password again and press <Enter>. You may also press <Esc> to abort the selection and not enter a password.

To disable a password, just press <Enter> when you are prompted to enter the password. A message will confirm the password will be disabled. Once the password is disabled, the system will boot and you can enter Setup freely.

PASSWORD DISABLED.

When a password has been enabled, you will be prompted to enter it every time you try to enter Setup. This prevents an unauthorized person from changing any part of your system configuration.

Additionally, when a password is enabled, you can also require the BIOS to request a password every time your system is rebooted. This would prevent unauthorized use of your computer.

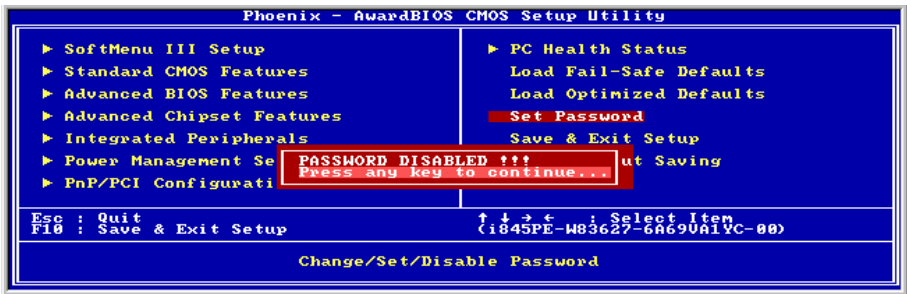

Figure 3-15. Password Disabled Screen Shot

You can determine when the password is required within the BIOS Features Setup Menu and its Security option. If the Security option is set to “System”, the password will be required both at boot and at entry to Setup. If it is set to “Setup”, the prompting only occurs when trying to enter Setup.

3-12. Save & Exit Setup

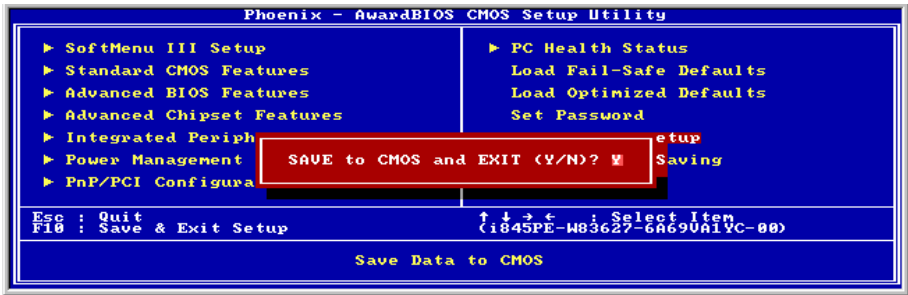

Figure 3-16. Save & Exit Setup Screen Shot

Pressing <Enter> on this item asks for confirmation:

Save to CMOS and EXIT (Y/N)? **Y**

Pressing “Y” stores the selections made in the menus in CMOS - a special section of memory that stays on after you turn your system off. The next time you boot your computer, the BIOS configures your system according to the Setup selections stored in CMOS. After saving the values the system is restarted again.

3-13. Exit Without Saving

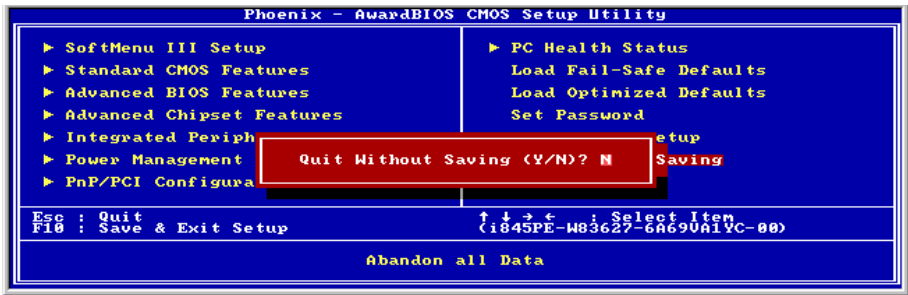

Figure 3-17. Exit Without Saving Screen Shot

Pressing <Enter> on this item asks for confirmation:

Quit without saving (Y/N)? **N**

This allows you to exit Setup without storing in CMOS any change. The previous selections remain in effect. This exits the Setup utility and restarts your computer.

Appendix A. Install Intel Chipset Software Utility

NOTE: Please install this Intel Chipset Driver before installing VGA and Audio driver.

The installation procedures and screen shots in this section are based on Windows XP operating system. For those of other OS, please follow its on-screen instruction.

Insert the Driver & Utility CD into CD-ROM drive, it should execute the installation program automatically. If not, double-click the execution file at the main directory of this CD to enter the installation menu.

After entering the installation menu, move your cursor to [Driver] tab. Click [Intel Chipset Software Utility]. The following screen appears.

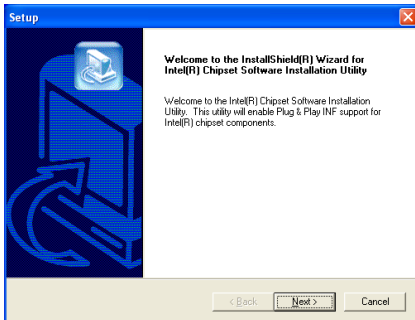

1. Click [Next].

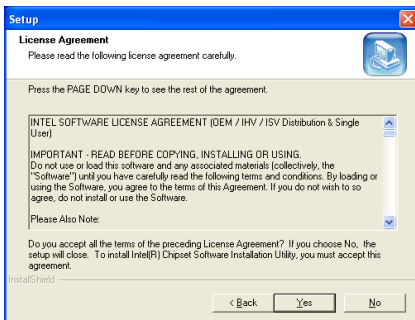

2. Click [Yes].

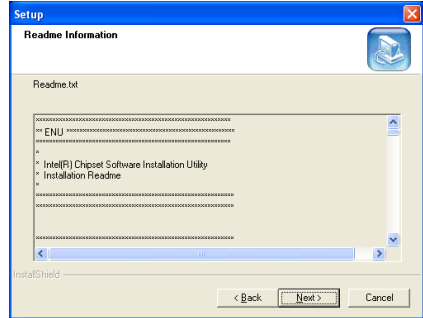

3. Click [Next].

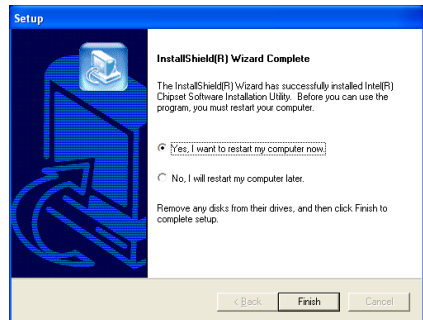

4. Choose [Yes, I want to restart my computer now.], and click [Finish] to complete setup.



Appendix B. Install Intel Application Accelerator

NOTE: Please make sure to install the “Intel Chipset Driver” first and to reboot the system before installing this “Intel Application Accelerator”.

The installation procedures and screen shots in this section are based on Windows XP operating system. For those of other OS, please follow its on-screen instruction.

Insert the Driver & Utility CD into CD-ROM drive, it should execute the installation program automatically. If not, double-click the execution file at the main directory of this CD to enter the installation menu.

After entering the installation menu, move your cursor to [Driver] tab. Click [Intel Application Accelerator]. The following screen appears.

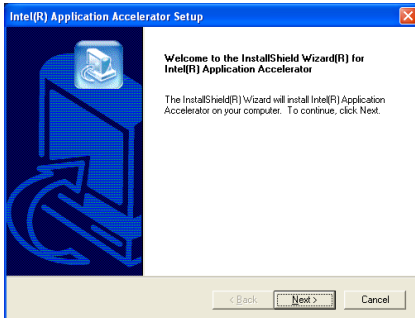

1. Click [Next].

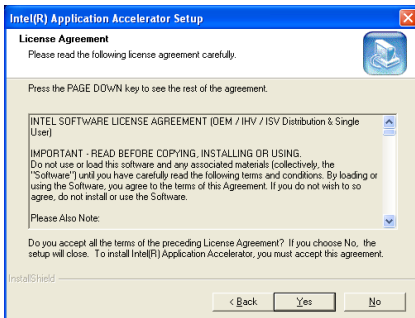

2. Click [Yes].

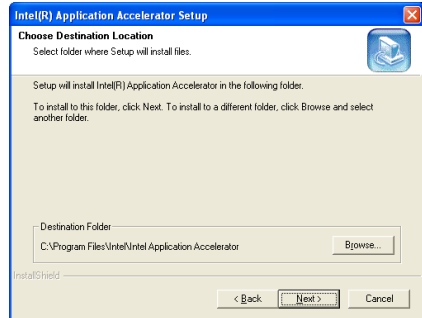

3. Click [Next].

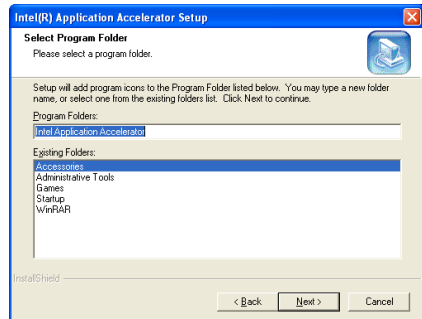

4. Click [Next].

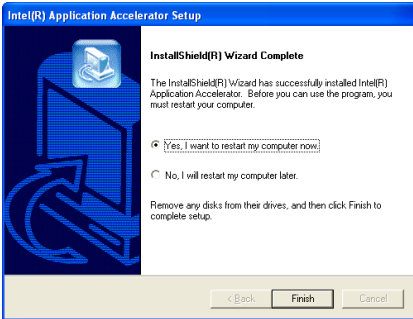

5. Choose [Yes, I want to restart my computer now.], and click [Finish] to complete setup.

Appendix C. Install Audio Driver

The installation procedures and screen shots in this section are based on Windows XP operating system. For those of other OS, please follow its on-screen instruction.

Insert the Driver & Utility CD into CD-ROM drive, it should execute the installation program automatically. If not, double-click the execution file at the main directory of this CD to enter the installation menu.

After entering the installation menu, move your cursor to [Driver] tab. Click [RealTek ALC650 Audio Driver]. The following screen appears.

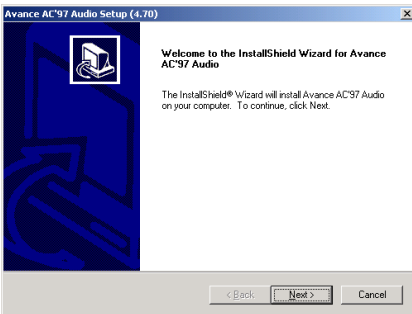

1. Click [Next].



2. Click [Continue Anyway].

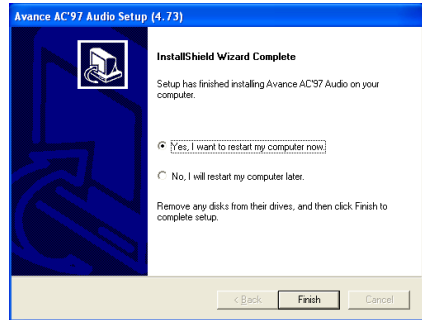

3. Choose [Yes, I want to restart my computer now.], and click [Finish] to complete setup.

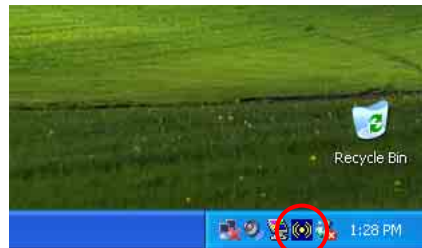

4. After the system restarted, a shortcut icon appears at the right corner of Windows task bar.

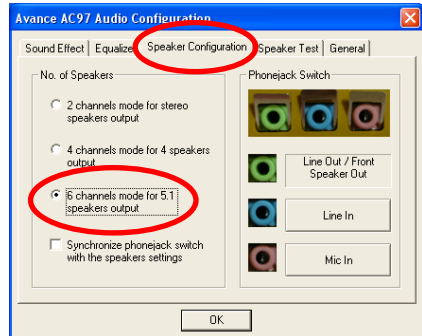

5. In this Speaker Configuration tab, select [6 channels mode for 5.1 speakers output] to enable 6-channel audio system.

Note: To keep a normal operation of 5.1 speakers output, please do not change the settings of “Line In” and “Mic In” in this menu.

Appendix D. Install LAN Driver

The installation procedures and screen shots in this section are based on Windows XP operating system. For those of other OS, please follow its on-screen instruction.

Insert the Driver & Utility CD into CD-ROM drive, it should execute the installation program automatically. If not, double-click the execution file at the main directory of this CD to enter the installation menu.

For BE7 and BE7-RAID:

After entering the installation menu, move your cursor to [Driver] tab. Click [RealTek LAN Driver]. The following screen appears.

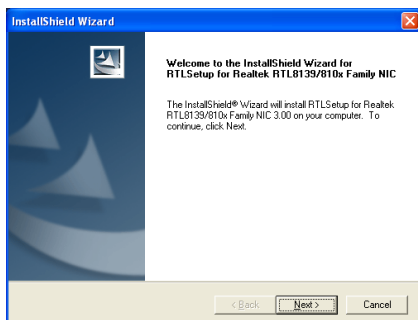

1. Click [Next].

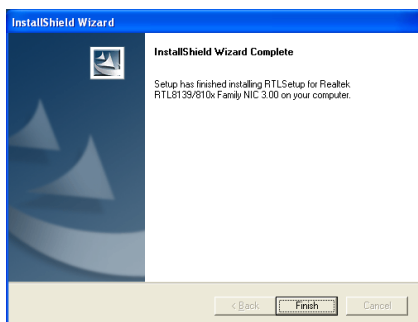

2. Click [Finish] to complete setup.

For BE7-S and BE7-B:

After entering the installation menu, move your cursor to [Driver] tab. Click [Broadcom 10/100 LAN Driver]. The following screen appears.

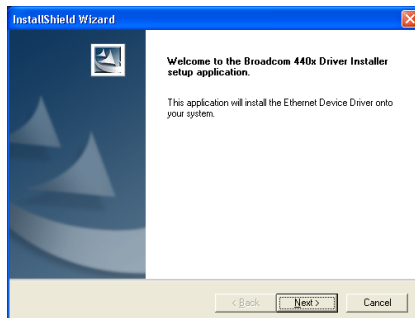

1. Click [Next].

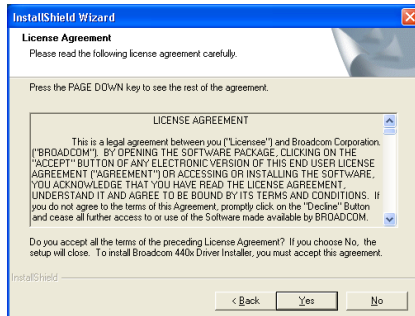

2. Click [Yes] to accept the license agreement. Reboot the system to make the driver effective.

Note: In order to enable the WOL (Wake-up On LAN) function for BE7-S and BE7-B model in Windows 2000 and Windows XP, it is necessary to change the value of the “Wake Up Capabilities” property into “Magic Frame”. Please refer to the following two steps:

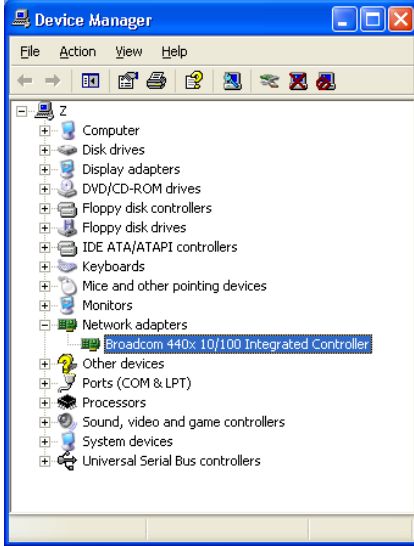

1. After finished the driver installation, check the [Network adapters] in the [Device Manager]. You will find the [Broadcom 440x 10/100 Integrated Controller] is successfully installed.

Select [Broadcom 440x 10/100 Integrated Controller]. Right click your mouse to enter its properties.

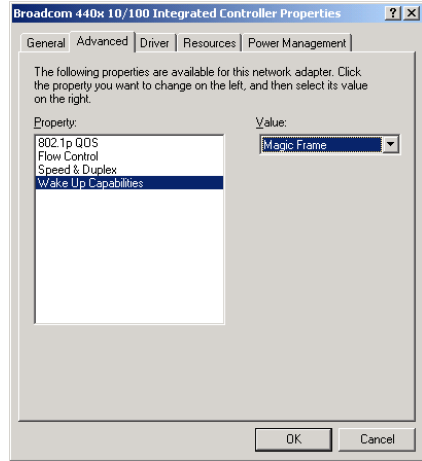

2. Select [Advanced] tab. Move your cursor to select the [Wake Up Capabilities] property option and then set the value option to [Magic Frame]. Click [OK] and restart your computer to complete setup.

For BE7-G:

Note: There is no need to set up Gigabit LAN driver for Windows XP. The following installation procedures and screen shots in this section are based on Windows 2000.

After entering the installation menu, move your cursor to [Driver] tab. Click [Broadcom Gigabit LAN Driver]. The following screen appears.

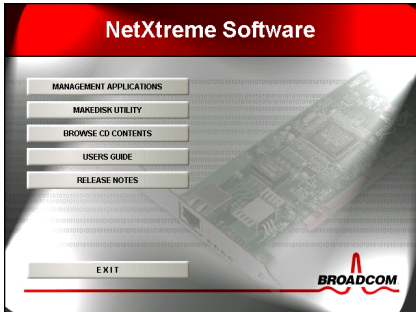

1. Click [MAKEDISK UTILITY].

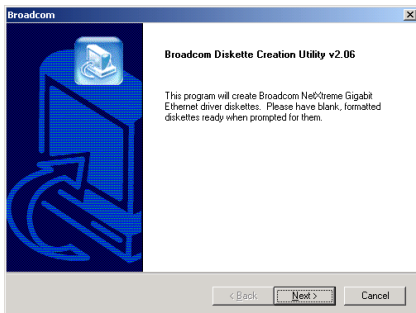

2. Click [Next].

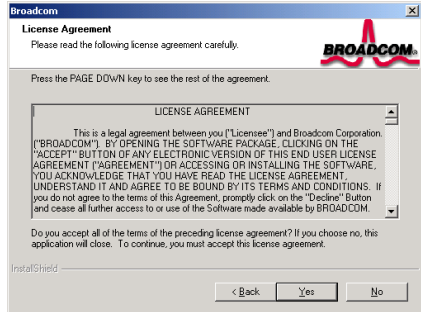

3. Click [Yes].

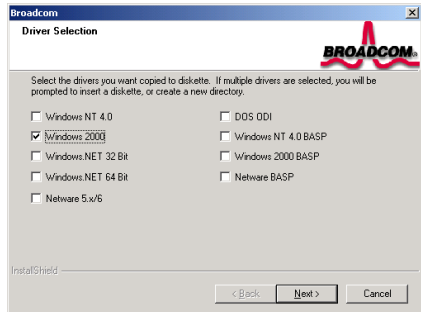

4. Select Windows 2000. Click [Next].



5. Insert a blank floppy disk to [A] drive. You may also create a new directory in your hard disk by clicking [Browse]. Click [Next] to start copying files.

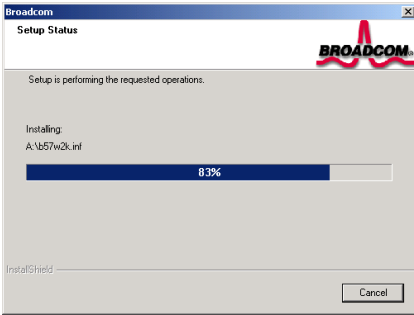

6. The setup wizard is copying files to floppy disk.

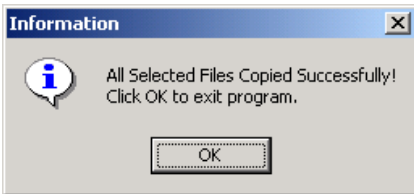

7. The setup wizard finish copying files to floppy disk. Click [OK] to exit.

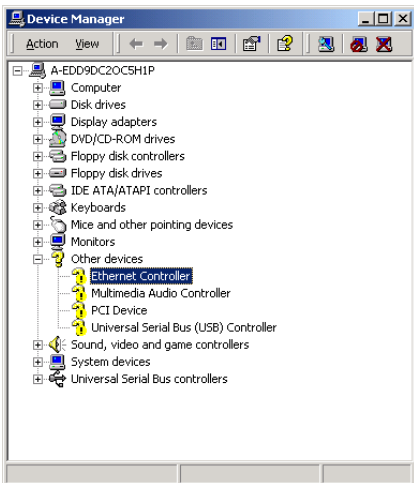

8. Check [Device Manager]. Click [Ethernet Controller].

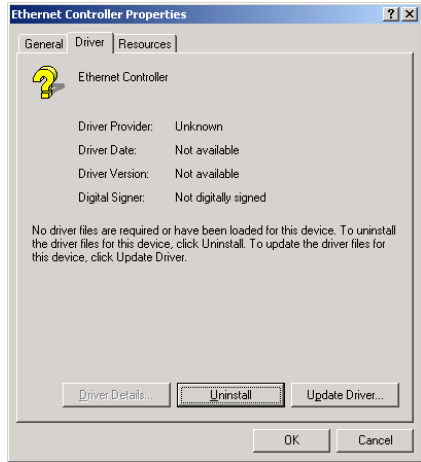

9. Select [Driver] tab in the [Ethernet Controller Properties]. Click [Update Driver].



10. The upgrade wizard appears. Click [Next] to continue.

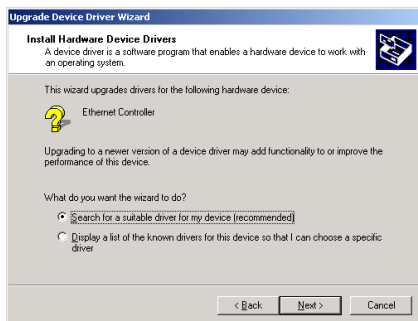

11. Select [Search for a suitable driver for my device]. Click [Next].

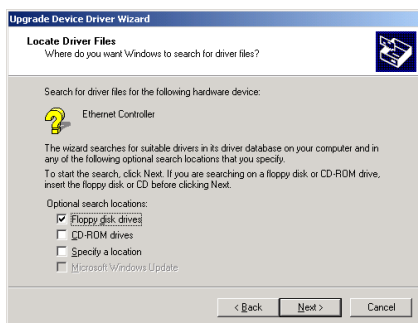

12. Select [Floppy disk drives]. Click [Next].

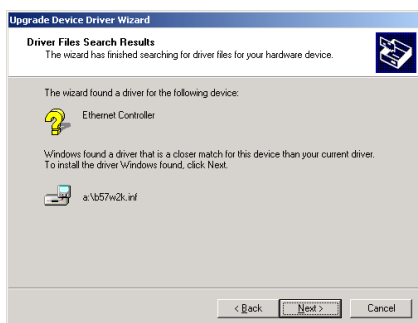

13. Click [Next].



14. Click [Finish].

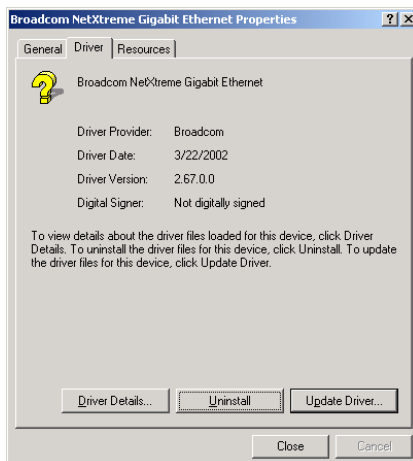

15. Back to the [Ethernet Controller Properties]. Click [Close] to finish driver update.

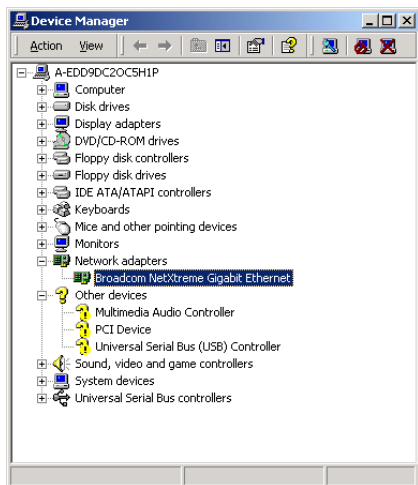

16. Check [Device Manager] again. [Broadcom NetXtreme Gigabit Ethernet] is successfully upgraded.

Appendix E. Install USB 2.0 Driver

The installation procedures and screen shots in this section are based on Windows XP operating system. For those of other OS, please follow its on-screen instruction.

Insert the Driver & Utility CD into CD-ROM drive, it should execute the installation program automatically. If not, double-click the execution file at the main directory of this CD to enter the installation menu.

After entering the installation menu, move your cursor to [Driver] tab. Click [USB 2.0 Driver]. The following screen appears.

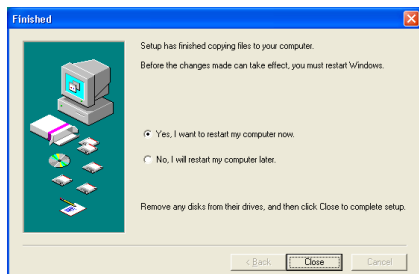

1. Choose [Yes, I want to restart my computer now], and click [Close] to reboot the system.

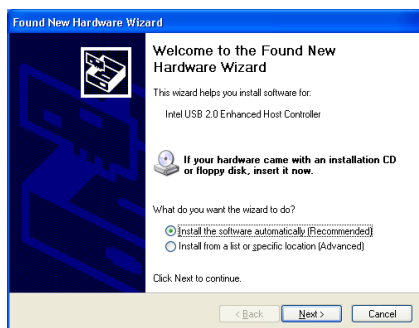

2. Click [Next].



3. Click [Finish].



4. Click [Next].



5. Click [Finish].



Appendix F. Install Serial ATA RAID Driver (For BE7-G & BE7-S)

The installation procedures and screen shots in this section are based on Windows XP operating system. For those of other OS, please follow its on-screen instruction.

Insert the Driver & Utility CD into CD-ROM drive, it should execute the installation program automatically. If not, double-click the execution file at the main directory of this CD to enter the installation menu.

After entering the installation menu, move your cursor to [Driver] tab. Click [Serial ATA RAID Driver]. The following screen appears.

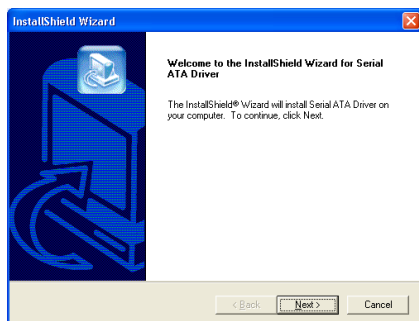

1. Click [Next].



2. Click [Continue Anyway].



3. Choose [Yes, I want to restart my computer now.], and click [Finish] to complete setup.

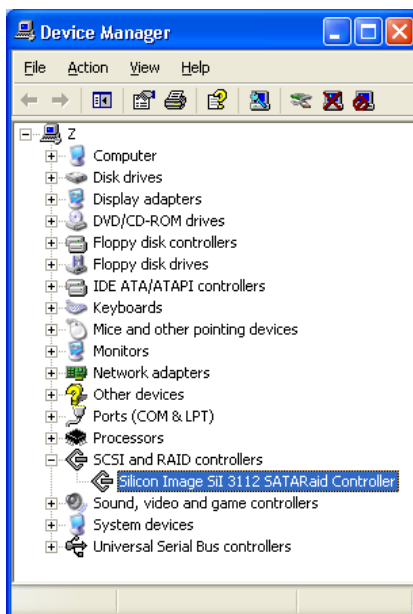

4. Check [Device Manager]. [Silicon Image Sil 3112 SATA RAID Controller] is successfully installed.



Appendix G. HPT 372 Setup (For BE7-RAID)

Driver Installation

The installation procedures and screen shots in this section are based on Windows XP operating system. For those of other OS, please follow its on-screen instruction.

Insert the Driver & Utility CD into CD-ROM drive, it should execute the installation program automatically. If not, double-click the execution file at the main directory of this CD to enter the installation menu.

After entering the installation menu, move your cursor to [Driver] tab. Click [HPT 372 Driver]. The following screen appears.

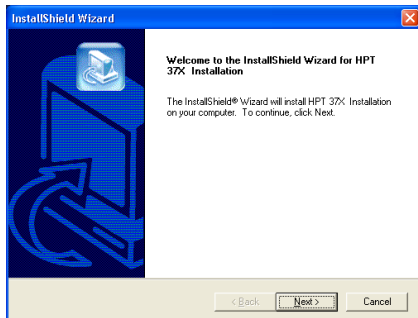

1. Click [Next].



2. Click [Continue Anyway] to continue.



3. Click [Finish].

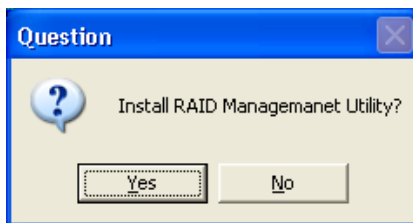

4. Click [Yes].

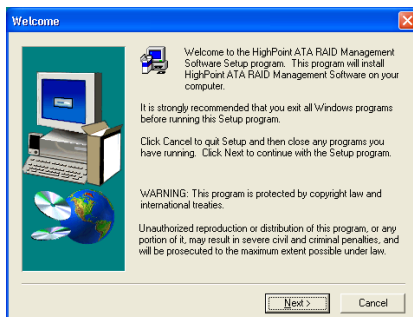

5. Click [Next].

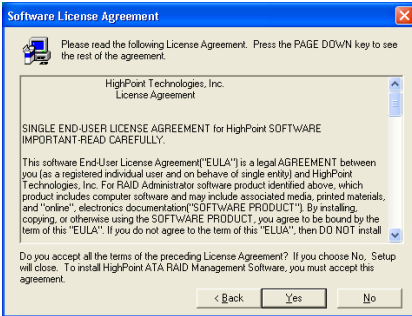

6. Click [Yes].

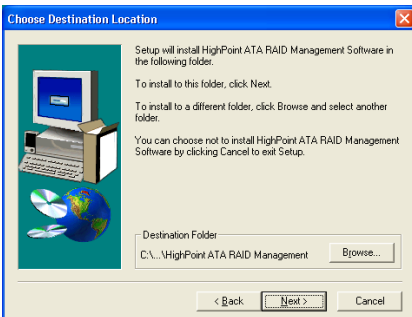

7. Click [Next].

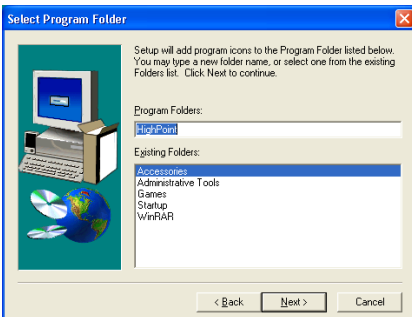

8. Click [Next].

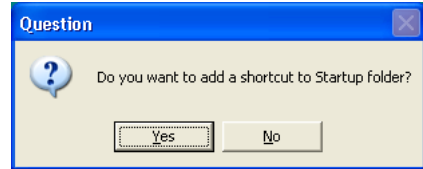

9. Click [Yes] if you want to add a shortcut to startup folder.

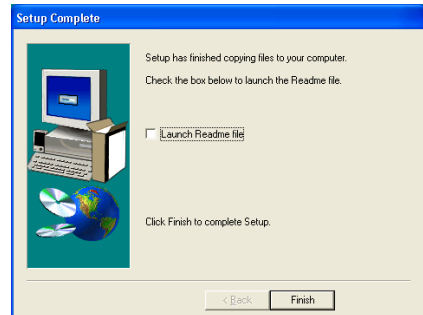

10. Click [Finish] to end the setup.

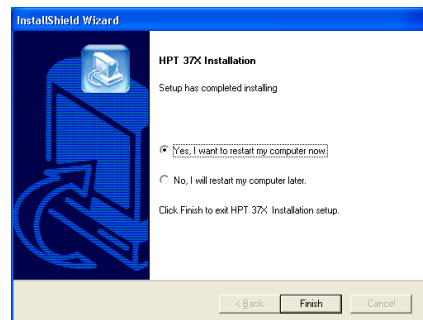

11. Choose [Yes, I want to restart my computer now.], and click [Finish] to complete setup.



12. Execute the [RAID Management Software] by entering the Windows menu: [Start] → [All Programs] → [HighPoint] → [HighPoint ATA RAID Management Software].

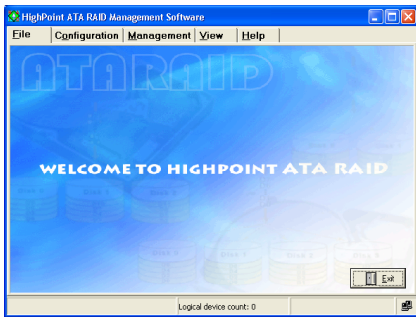

13. The [RAID Management Software] screen pops up.

BIOS Setup for RAID

For further information on RAID concept, you can find it on the “**Technological Terms**” from our WEB site, or you can search the related information on the Internet.

This motherboard supports the RAID operation of “**Striping (RAID 0)**”, “**Mirroring (RAID 1)**”, or “**Striping/Mirroring (RAID 0+1)**”. For the striping operation, the identical drives can read and write data in parallel to increase system performance. The Mirroring operation creates a complete backup of your files. Striping with Mirroring operation offers both read/write performance and fault tolerance.

After completed the installation of HPT37X driver, you have to enable the RAID function in BIOS setup menu. Enter the “**Advanced BIOS Features**” in the BIOS setup menu. Change the settings of “**First Boot Device**”, “**Second Boot Device**” and “**Third Boot Device**” to “**ATA133RAID**”. See the figure below:



NOTE: The option of “SCSI” cannot be worked as a booting device if this “ATA133RAID” had been selected as booting device, and vice versa.

BIOS Setting Utility

Main Menu

Reboot your system. Press <CTRL> and <H> key while booting up the system to enter the BIOS setting menu. The main menu of BIOS Setting Utility appears as shown below:

```

HP370/372 <BIOS Setting Utility>

Menu
1. Create RAID
2. Delete RAID
3. Rebuild Mirror Array
4. Add Spare Disk
5. Remove Spare Disk
6. Set Disk Mode
7. Set Root Disk

Help
Create a Disk Array with the
hard disks attached to the
HP370/372

F1: View Array Status
T.1: Move to next item
Enter: Confirm the selection
Esc: Return to top menu

Channel Status
Channel      Drive Name      Mode  Size (M)  Status
Primary Master  ST320414A      UDMA5  19551  HDD0
Primary Slave   No Drive
Secondary Master ST320414A      UDMA5  19551  HDD1
Secondary Slave No Drive

(C)1999-2001. HighPoint Technologies, Inc.
All rights reserved
  
```

To select the option in this menu, you may:

- Press <F1> to view array status.
- Press <↑ ↓> (up, down arrow) to choose the option you want to confirm or to modify.
- Press <Enter> to confirm the selection.
- Press <Esc> to return to top menu.

NOTE: If you want to create a RAID 0 (striping) array or RAID 0+1 array, all the data stored in the hard disks will first be erased! Please backup the hard disk data before starting to create these RAID arrays.

If you want to create a RAID 1 (mirroring) array, please make sure which hard disk is the source disk and which one is the destination disk. If you make a mistake, you may copy the blank data to the source disk, which will result in both hard disks becoming blank!

Option 1 Create RAID

This item allows you to create a RAID array.

```

HP370/372 <BIOS Setting Utility>

Menu
Create New Array  Array #1
1. Array Mode      Striping (RAID 0)
2. Select Disk Drives
3. Stripe Size     64K
4. Start Creation Process

Help
Select RAID mode for the
Disk Array to be created

F1: View Array Status
T.1: Move to next item
Enter: Confirm the selection
Esc: Return to top menu

Channel Status
Channel      Drive Name      Mode  Size (M)  Status
Primary Master  ST320414A      UDMA5  19551  HDD0
Primary Slave   No Drive
Secondary Master ST320414A      UDMA5  19551  HDD1
Secondary Slave No Drive

(C)1999-2001. HighPoint Technologies, Inc.
All rights reserved
  
```

- **Array Mode:**
This item allows you to select the appropriate RAID mode for the desired array. There are four modes to choose.

NOTE: It is highly recommended to attach hard disks with the same model in reaching the RAID performance.

Striping (RAID 0): This item is recommended for **high performance** usage. Requires at least 2 disks.

Mirror (RAID 1): This item is recommended for **data security** usage. Requires at least 2 disks.

Striping and Mirror (RAID 0+1): This item is recommended for **data security and high performance** usage. Allows Mirroring with a Strip Array. Require 4 disks.

Span (JBOD): This item is recommended for **high capacity without redundancy or performance** features usage. Requires at least 2 disks.

NOTE: When you choose to create RAID 1, and your source disk is not empty, you have to **Duplicate Mirror Disk** to copy data to destination disk. Otherwise, it will only copy the partition table to the destination disk, not the physical date.

- **Select Disk Drives:**
This item allows you to select the disk drives to be used with the RAID array.
- **Stripe Size:**
This item allows you to select the stripe size of the RAID array. There are five options: 4K, 8K, 16K, 32K, and 64K.
- **Start Creation Process:**
After you have made your selection, choose this item and press <Enter> to start creation.

Option 2 Delete RAID

This item allows you to remove a RAID Array on this IDE RAID controller.

NOTE: After you have made and confirmed this selection, all the data stored in the hard disk will be lost. (The entire partition configuration will be deleted too.)

Option 3 Rebuild Mirror Disk

This item allows you to select the disk you wish to rebuild in preparation for a “Mirror Disk Array”.

After you have selected the function you want in the main menu, you may press <Enter> key to enter the sub menu as shown below:

HPT370/372 <BIOS Setting Utility>

Menu

1. Select Source Disk: None
2. Select Target Disk: None
3. Start Duplication Process

Help

Select an array to synchronize or select a broken disk to rebuild

F1: View Array Status
F4: Move to next item
Enter: Confirm the selection
Esc: Return to top menu

Channel Status

Channel	Drive Name	Mode	Size (M)	Status
Primary Master	ST320414A	UDMA5	19551	HDD0
Primary Slave	No Drive			
Secondary Master	ST320414A	UDMA5	19551	HDD1
Secondary Slave	No Drive			

(C) 1999-2001. HighPoint Technologies, Inc.
All rights reserved

- **Select Source Disk:**
This item selects the source disk. The size of source disk must be smaller or equal to the size of target disk.
- **Select Target Disk:**
This item selects the target disk. The size of target disk must be greater or equal to the size of source disk.
- **Start Duplicating Process:**
After you had selected this item, the BIOS setting will take up to 30 minutes to run the duplication. Please wait, or you may press <Esc> to cancel.

Option 4 Add Spare Disk

To add the spare disk:

1. Select “4. Add Spare Disk” in the Main Menu, and press <Enter> to confirm.
2. In menu zone of the pop up sub interface, select “1. Select Mirror Array: None” and press <Enter> to confirm.

HPT370/372 <BIOS Setting Utility>

Menu

1. Select Mirror Array: None
2. Select Spare Drive: None

Help

F1: View Array Status
F4: Move to next item
Enter: Confirm the selection
Esc: Return to top menu

Channel Status

Channel	Drive Name	Mode	Size (M)	Status
Primary Master	ST320414A	UDMA5	19551	HDD0
Primary Slave	No Drive			
Secondary Master	ST320414A	UDMA5	19551	HDD1
Secondary Slave	No Drive			

(C) 1999-2001. HighPoint Technologies, Inc.
All rights reserved

3. In the validated channel status zone, select the mirror array and press <Enter> to confirm.
4. In the menu zone of the pop up subinterface, select “2. Select Spare Drive: None” and press <Enter> to confirm.
5. In the validated channel status zone, select the spare disk to be added and press <Enter> to confirm.

Option 5 Remove Spare Disk

To remove the spare disk:

1. Select “5. Remove Spare Disk” in the Main Menu, and press <Enter> to confirm.
2. The item “1. Select Mirror Array: None” appears in the menu zone of pop up sub interface.
3. In the validated channel status zone, select the spare disk to be removed and press <Enter> to confirm.

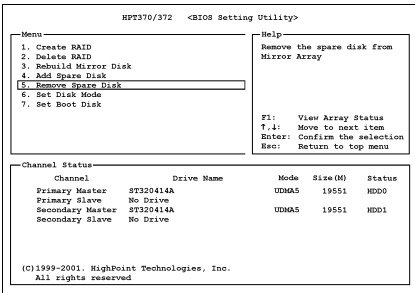

Option 6 Set Disk Mode

This item allows you to select transfer mode for hard disk(s).

To set disk mode:

1. Select “6. Set Disk Mode” in the Main Menu, and press <Enter> to confirm.
2. In the Channel Status, select the channel you would like to set and press <Enter>, an asterisk mark appears in the parentheses to indicate that the channel has been selected.
3. Choose the mode from the pop-up menu. You can choose from PIO 0 ~ 4, MW DMA 0 ~ 2, and UDMA 0 ~ 5.

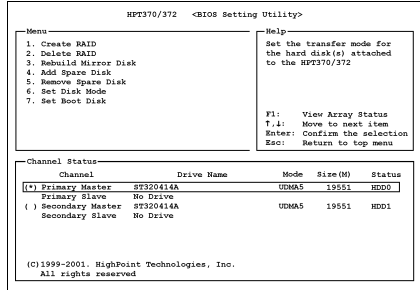

Option 7 Set Boot Disk

This item allows you to select boot disk among hard disk(s).

To set disk mode:

1. Select “7. Set Boot Disk” in the Main Menu, and press <Enter> to confirm.
2. In the Channel Status, select the channel you would like to set as bootable disk and presses <Enter>, an asterisk mark appears in the parentheses to indicate that the channel has been selected.

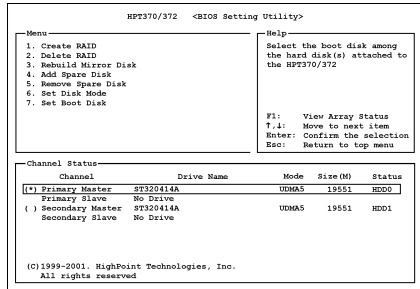

Appendix H. BIOS Update Guide

The procedure illustrated here is based on the model SE6 as an example; all other models follow the same process.

1. First, find out the model name and version number of this motherboard. You can find a sticker with model name and version number on one slot or at the back of the motherboard.



2. Find out the current BIOS ID.

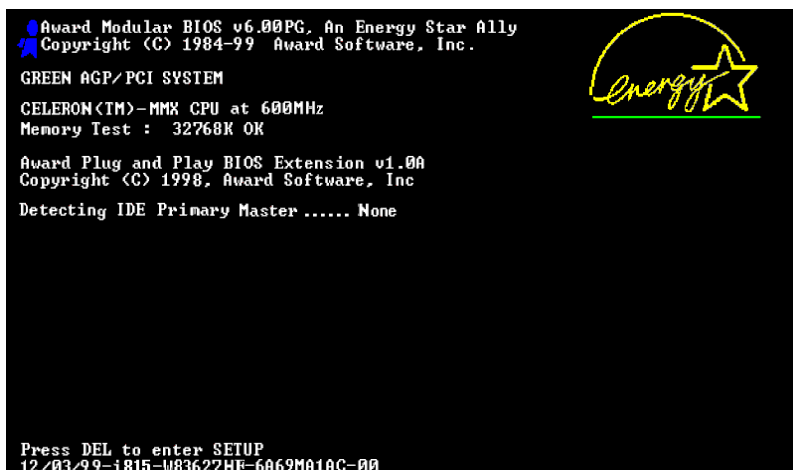

"00" is the BIOS ID number

"6A69MA1AC" is the BIOS part number

For example, in this case, the current BIOS ID is "00". If you already have the latest BIOS, no any update action is necessary. If your BIOS is not the latest BIOS, go on to the next step.

3. Download the correct BIOS file from our Web site.

[SE6]

Filename:

[SE6SW.EXE](#)

Date: 07/06/2000

ID: SW

NOTE:

1. Fixes SCSI HDD detection problem when booting from SCSI CD-ROM and executing FDISK.
2. Supports 512MB memory modules.
3. Sets the In-Order Queue Depth default to 4, increasing the integrated video performance.

Go to our Web site and choose the correct BIOS file and download it.

4. Double click the download file, it will self-extract to .bin file.

```
LHA's SFX 2.13S <c> Yoshi, 1991
SE6_SW.BIN .....
```

5. Make a bootable floppy disk and copy the necessary files onto it.

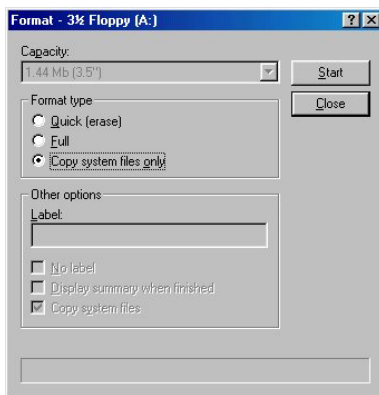

You may make a floppy disk bootable either in Explorer or in the DOS prompt mode.

```
[c:\]format a: /s
```

After formatting and transferring the system to the floppy disk, copy two files into it. One is the BIOS flash utility “**awdf flash.exe**” and the other is the decompressed BIOS binary file.

6. Boot off floppy disk.

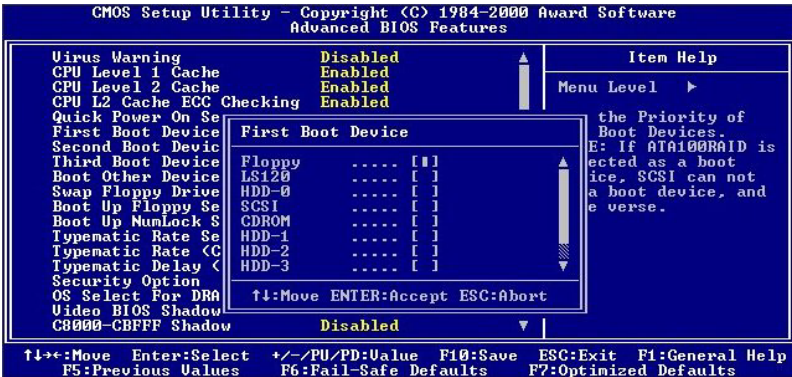
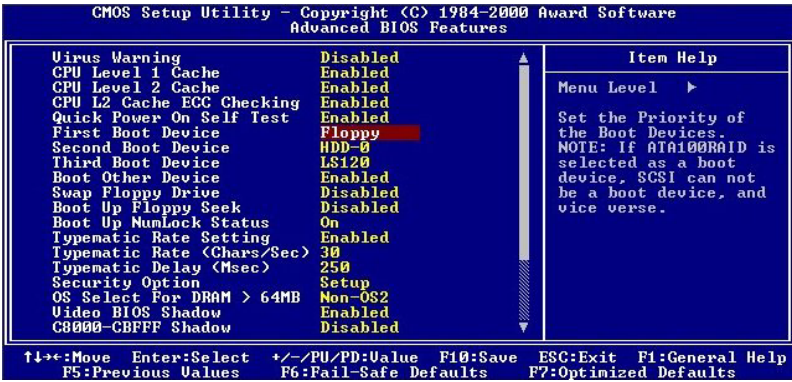
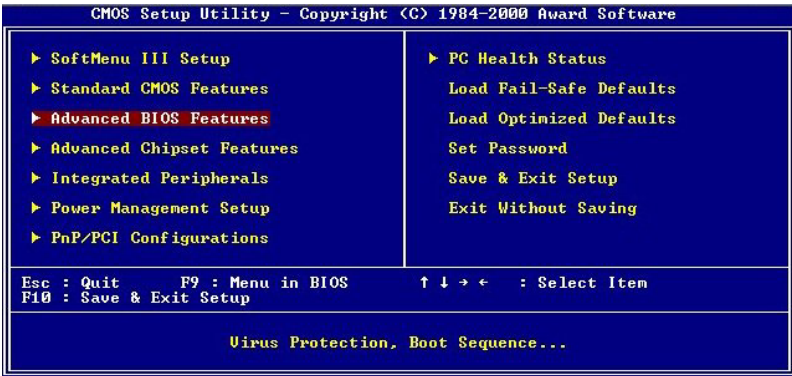

Please set the first boot sequence as "floppy" in BIOS and boot off the floppy disk.

- Flash the BIOS in pure DOS mode.

```
A:\>awdf flash se6_sw.bin /cc /cd /cp /py /sn /cks /r_
```

After successfully booting off of the floppy, execute the flash utility according to these instructions.

Note

- We strongly recommend you use the above parameters following 'awdf flash' to flash your BIOS. **DO NOT** just type "awdf flash se6_sw.bin" without the above parameters following the ".bin" file.
- The Award flash utility cannot be completed under the Windows environment. It must be done in a pure DOS environment.
- You should check which BIOS file is to be used with your motherboard, don't flash with the wrong BIOS file. Otherwise, it may cause system malfunctions.
- Please do not use the Award flash memory writer version earlier than Version 7.52C to flash the BIOS. Otherwise, it may cause flash fail or un-anticipated problems.
- During the updating, the progress will be measured by white blocks. The last four *blue* blocks of the flash update process represent the "BIOS boot block". The BIOS boot block is used to prevent the BIOS from becoming corrupt during programming. It should not be programmed every time. If this "BIOS boot block" remains intact when the BIOS becomes corrupt during programming, then you can boot from a bootable floppy next time you boot your computer. This allows you to flash your BIOS again without the need for technical support from the dealer.

Appendix I. Hardware Monitoring (The Winbond Hardware Doctor Utility)

The Winbond Hardware Doctor is a self-diagnostic system for PCs used with Winbond W83627HF chipset. It protects PC hardware by monitoring several critical items including power supply voltages, CPU & system fan speeds and CPU and system temperatures. These items are important for the system operation. Errors may result in permanent damage to the PC. Once any item is out of its normal range, a warning message pops up reminding you to take proper measures.

The installation procedures and screen shots in this section are based on Windows XP operating system. For those of other OS, please follow its on-screen instruction.

Insert the Driver & Utility CD into CD-ROM drive, it should execute the installation program automatically. If not, double-click the execution file at the main directory of this CD to enter the installation menu.

After entering the installation menu, move your cursor to [Hardware Doctor] tab. Click [Install Hardware Doctor]. The following screen appears.

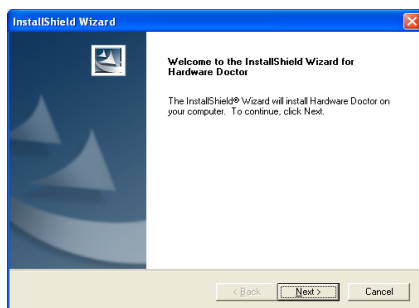

1. Click [Next].

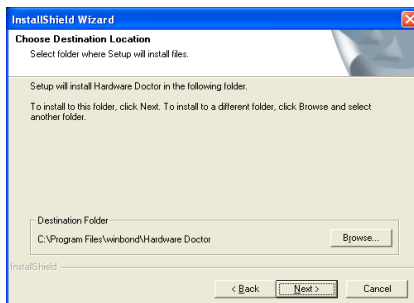

2. Click [Next].

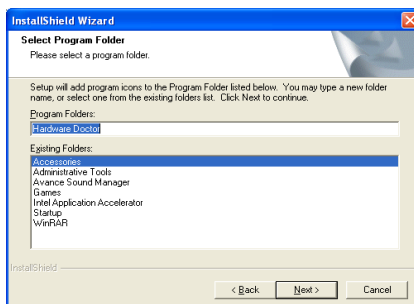

3. Click [Next].

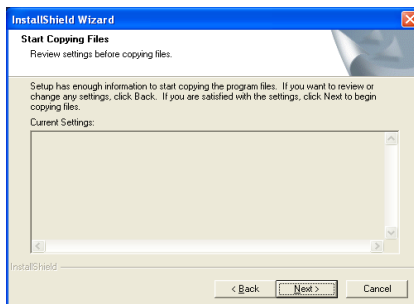

4. Click [Next].

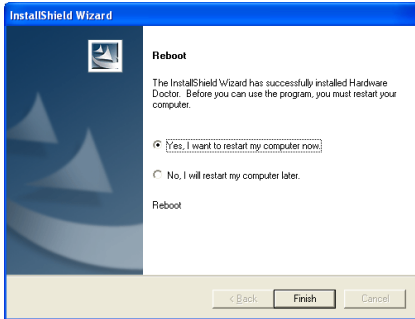

5. Choose [Yes, I want to restart my computer now.] and click [Finish] to complete setup.



6. Execute the Hardware Doctor by entering the Windows Menu [Start] → [Programs] → [Winbond] → [Hardware Doctor].

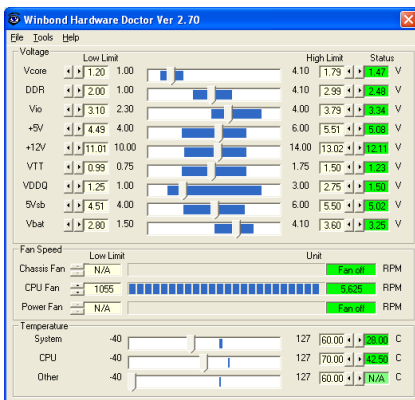

7. This screen appears. Hardware Doctor shows you the status of Voltage, Fan Speed, and Temperature readings as well. If any reading is

critical or over its limitation, the reading turns red. Also, a pop-up window appears warning you the system has a problem!



8. This is the warning message window:

Ignore: You can ignore the warning message of the item, but it will pop up again when an error of the same item reoccurs.

Disable: The chosen item will be no longer monitored thereafter, unless you activate it in the “**Configuration**” page.

Shutdown: Choosing this button will shutdown the computer.

Help: You can read more information and self-diagnose simple problems.

If the warning message pops up due to the wrong warning limit, you can adjust it in the “**Configuration**” option. For example, if you set the temperature high limit to 40°C, you will easily exceed the “proper” temperature.

Pay attention to two things when you want to make any change to the “**Configuration**” option. Firstly, you have to make sure your new setting is in the proper range. Secondly, after you finished the configuration, you have to save it. Otherwise, the program will start with the default value next time.

If you encounter any problem or have any question about the software settings and adjustments, please use the Winbond hardware doctor on-line help. It should give you enough information to answer your questions.

Appendix J. Installation Guide for Suspend to RAM

Suspend To RAM (STR) is a cost-effective, optimal implementation of the ACPI 1.0 specification. The ACPI specification defines the S3 sleep state, in which all system context is lost except system memory. CPU, cache, and chip set context are lost in this state. Hardware maintains memory context and restores some CPU and L2 configuration context.

The STR function enables a PC to achieve the S3 state during idle periods, then quick “wake up” and retrieve the last “state” of the system before it went to sleep. When idle, STR-enabled systems consume only a small fraction of the power used for full operation. Instead of shutting down the system to save power when not in use and then having to reboot later, users can let the STR function take over and not have to worry about using power to run all the electronics, fans and disks. When needed, a PC with STR function can restore all applications and features to an operational state within a few seconds.

The following description will tell you how to install the STR function and to use it.

After the operating system had been installed successfully, reboot your computer, you can see these ACPI items show up in the “Device Manager” menu by entering *Start* → *Settings* → *Control Panel* → *System* → *System Properties* → *Hardware*:

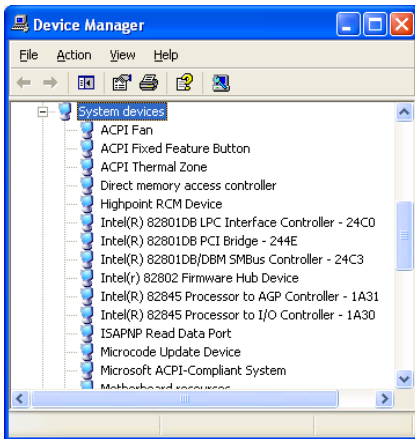

How to use the STR function:

There are two ways to put your system into STR mode:

Method 1: Select [Stand by] in the [Turn Off Computer...] area.



1. Click [Start] in the Windows Tools Bar, and then select [Turn Off Computer...]

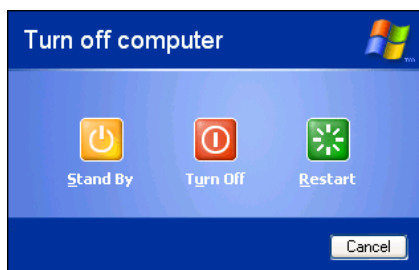

2. Click [Stand by].

Method 2: Define the chassis's [Power] button to initiate STR sleep Mode

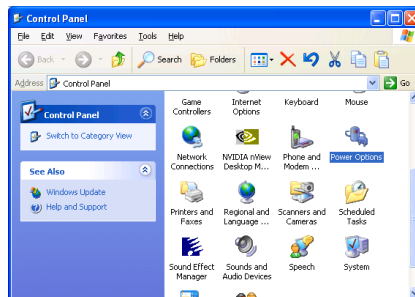

1. Open [Control Panel], and then enter [Power Options].

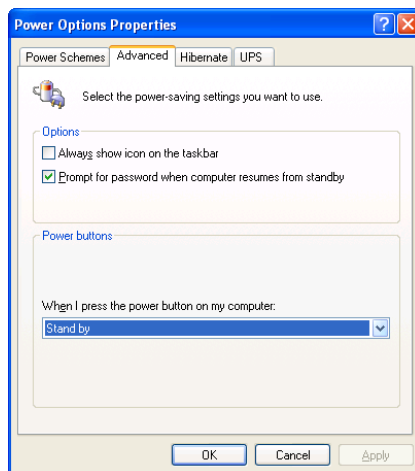

2. Select [Advanced] tab. Set the [Power Buttons] option to [Stand by].

Restart your computer to put these settings into effect. Now you will only need to press the [Power] button on the front panel of the chassis when you want to put your computer into STR sleep mode.

Appendix K. Troubleshooting (Need Assistance?)

Motherboard Troubleshooting:

Q & A:

Q: Do I need to clear the CMOS before I use a new motherboard to assemble my new computer system?

A: Yes, we highly recommend that you clear the CMOS before installing a new motherboard. Please move the CMOS jumper from its default 1-2 position to 2-3 for a few seconds, and then back. When you boot up your system for the first time, follow the instructions in the user's manual to load the optimized defaults.

Q: If my systems hang when I update the BIOS or set the wrong CPU parameters, what should I do?

A: Whenever you update the BIOS or if the system hangs due to wrong CPU parameters setting, always clear CMOS jumper before booting up again.

Q: Why the system failed to boot up and nothing was displayed on the screen after I did some over-clocking or non-standard settings inside the BIOS? Is the motherboard dead? Do I need to return it to where I bought from or go through an RMA process?

A: It should not cause hardware or permanent damage to motherboard when BIOS settings were changed from default to over-clocking or non-standard status.

We suggest the following three troubleshooting methods to discharge CMOS data, recover the hardware default status, and then make the motherboard working again. No need to bother returning the motherboard to where you bought from or go through an RMA process.

Step 1. Switch off the power supply unit and then switch it on again after one minute. If there is no power switch on the power supply unit, disconnect its power cord for one minute and then connect it back.

Press and hold the <Insert> key on the keyboard, press the power-on button to boot up system. If it works, loose the <Insert> key and hit key to enter the BIOS setup page to do the correct settings.

If the situation remains the same, repeat the procedures in Step 1 for three times, or try Step 2.

Step 2. Switch off the power supply unit or disconnect the power cord. Open the chassis cover. Locate the CCMOS jumper near the button battery. Change the jumper position from default 1-2 to 2-3 for one minute to discharge the CMOS data, and then put it back to default 1-2 position.

Close the chassis and switch on the power supply unit or plug in the power cord. Press the power-on button to boot up system. If it works, hit key to enter the BIOS setup page to do the correct settings.

If the situation remains the same, try Step 3.

Step 3. The same procedure as Step 2, but in the meantime of discharging the CMOS data, pull out ATX power connectors from motherboard and remove the button battery during CMOS discharging.

Q: How can I get a quick response to my request for technical support?

A: Be sure to follow the guidelines as stated in the “Technical Support Form” section of this manual.

If you have a problem during operation, in order to help our technical support personnel quickly determine the problem with your motherboard and give you the answers you need, before filling in the technical support form, eliminate any peripheral that is not related to the problem, and indicate it on the form. Fax this form to your dealer or to the company where you bought the hardware in order to benefit from our technical support. (You can refer to the examples given below)

Example 1:

With a system including: motherboard (with CPU, DRAM, COAST...) HDD, CD-ROM, FDD, VGA CARD, MPEG CARD, SCSI CARD, SOUND CARD, etc. After the system is assembled, if you cannot boot up, check the key components of the system using the procedure described below. First remove all interface cards except the VGA card and try to reboot.

If you still cannot boot up: Try installing another brand/model VGA card and see if the system will start. If it still does not start, note the VGA card model, motherboard model, Bios identification number, CPU on the technical support form (refer to main instructions), and describe the problem in the problem description space provided.

If you can boot up: Insert the interface cards you have removed back into the system, one by one and try to start the system each time you insert a card, until the system will not start. Keep the VGA card and the interface card that caused the problem inserted on the motherboard, remove any other cards or peripheral, and start again. If you still cannot start, note the information related to both cards in the add-on Card space provided, and don't forget to indicate the motherboard model, version, BIOS identification number, CPU (refer to main instructions), and give a description of the problem.

Example 2:

With a system including the motherboard (with CPU, DRAM, COAST...) HDD, CD-ROM, FDD, VGA CARD, LAN CARD, MPEG CARD, SCSI CARD, SOUND CARD, after assembly and after having installed the Sound Card Driver, when you restart the system, when it runs the Sound Card Driver, it resets automatically. This problem may be due to the Sound Card Driver. During the Starting DOS... procedure, press SHIFT (BY-PASS) key, to skip CONFIG.SYS and AUTOEXEC.BAT; edit CONFIG.SYS with a text editor, and in function the line that loads the Sound Card Driver, add a remark REM, in order to disable the Sound Card Driver. See the example below.

```
CONFIG.SYS:
DEVICE=C:\DOS\HIMEM.SYS
DEVICE=C:\DOS\EMM386.EXE HIGHSCAN
DOS=HIGH, UMB
FILES=40
BUFFERS=36
REM DEVICEHIGH=C:\PLUGPLAY\DWCFMG.MSYS
LASTDRIVE=Z
```

Restart the system. If the system starts and does not reset, you can be sure that the problem is due to the Sound Card Driver. Write down the Sound Card model, motherboard model, BIOS identification number on the technical support file (refer to main instructions), and describe the problem in the space provided.

We will show you how to fill the “**Technical Support Form**”.

Main instructions:

To fill in this “**Technical Support Form**”, refer to the step-by-step instructions given below:

- 1* **MODEL:** Note the model number given in your user’s manual.
Example: BE7/BE7-RAID.
- 2* **Motherboard model number (REV):** Note the motherboard model number labeled on the motherboard as “REV:*.***”.
Example: REV: 1.01
- 3* **BIOS ID and Part Number:** See the on screen message.
- 4. **DRIVER REV:** Note the driver version number indicated on the DEVICE DRIVER disk (if any) as “Release *.***”. For example:

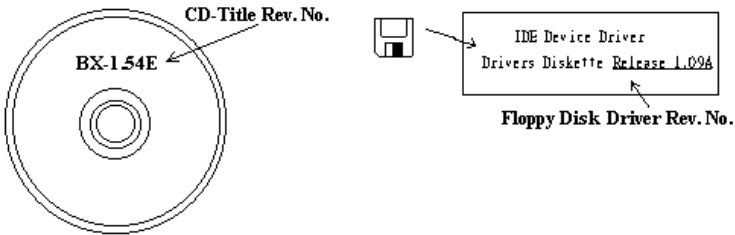

- 5* **OS/APPLICATION:** Indicate the operating system and applications you are running on the system.
Example: MS-DOS® 6.22, Windows® 98 SE, Windows® 2000, etc...
- 6* **CPU:** Indicate the brand and the speed (MHz) of your CPU.
Example:(A) In the “Brand” space, write “Intel”; in the “Specifications” space, write “Pentium® 4 1.9GHz”.
- 7. **HDD:** Indicate the brand and specifications of your HDD(s); specify if the HDD is using IDE1 or IDE2. If you know the disk capacity, indicate it and check (“✓”) “”; in case you give no indication, we will consider that your HDD is “IDE1” Master.
Example: In the “HDD” space, check the box; in the Brand space, write “Seagate”; in the Specifications space, write “ST31621A (1.6GB)”.
- 8. **CD-ROM Drive:** Indicate the brand and specifications of your CD-ROM drive. Specify if it uses IDE1 or IDE2 , and check (“✓”) “”; in case you give no indication, we will consider that your CD-ROM is “IDE2” Master.
Example: In the “CD-ROM drive” space, check the box, in the Brand space, write “Mitsumi”, in the Specifications space, write “FX-400D”.
- 9. **System Memory (DDR SDRAM):** Indicate the brand and specifications (DDR DIMM) of your system memory. Such as Density, Description, Module Components, Module Part Number, CAS Latency, and Speed (MHz).
For example: In the Brand space, write “**Micron**”; in the Specifications space, write: **Density:** 128MB, **Description:** SS 16 Megx72 2.5V ECC Gold, **Module Components:** (9) 16 Megx 8, **Module Part Number:** MT9VDDT1672AG, **CAS Latency:** 2, **Speed (MHZ):** 200 MHz.

Please give us the detailed information of your DDR SDRAM module; it will help us to simulate the problems you met.

- 10. ADD-ON CARD:** Indicate which add-on cards you are *absolutely sure* are related to the problem. If you cannot identify the problem's origin, indicate all the add-on cards inserted into your system.

NOTE: Items between the “**” are absolutely necessary.

RAID Troubleshooting

Q & A:

Q: May I use hard drives with different capacity or transfer mode?

A: In order to get optimized performance, we suggest using hard drives with the same model.

Q: How to assign a booting device?

A: You may press <Ctrl> <H> to assign a booting device in RAID BIOS (See Appendix G for detailed information).

Q: Why can't I see correct capacity in FDISK utility?

A: It's a well-known issue of Windows® 95/98's FDISK utility. If an IBM 75GB hard disk DTLA 307075 only gets 7768MB in Windows® 95/98's FDISK utility, please contact Microsoft® for a latest version of FDISK utility or download IBM's Disk Manager DiskGo! 2.5 to fix it. For windows® 2000, there is no such a 64GB issue.

<http://www.storage.ibm.com/techsup/hddtech/welcome.htm>

Q: How to create a striping and mirror array (RAID 0+1)?

A: You need four HDD drives, every two of them on the same channel/cable build a striping array. Then create a mirror array by these two striping arrays (See Appendix G for detailed information).

1. Press <Ctrl> <H> to setup configuration
2. Choose item 1 to Create RAID.
3. Choose item 1 to set Array Mode as Striping and Mirror (RAID 0+1).
4. Choose item 2 to Select Disk Drives. There are two striping arrays built automatically and you only have to enter twice.
5. Choose item 4 to Start Creation Process.
6. Press <Esc> to finish setting and leave RAID BIOS.

Q: How to rebuild a mirror array when one of the drives corrupts?

A: You need to delete previous array setting, duplicate the data, and then rebuild a new array setting (See Appendix G for detailed information).

1. Press <Ctrl> <H> to setup configuration
2. Choose item 2 to Delete Array.
3. Choose item 3 to Rebuild Mirror Array.
4. Choose sub item 1 to Select Source Disk, the one with data on it.
5. Choose sub item 2 to Select Target Disk, the brand new and empty one.
6. Choose sub item 3 to Start Duplication Process.
7. After duplication process completes, press <Esc> to leave RAID BIOS.

Q: Why I see “NO ROM BASIC SYSTEM HALTED” when booting?

A: There isn't any activated primary partition in you system. Please use FDISK or any other utilities to create/set one.

Do & Don't:

1. **Do** always use the same model drives to achieve best quality and performance. Different firmware has different timing characteristic, thus may somewhat decrease the RAID performance.
2. If you have two drives, do connect them on two different channels as master drive please.
3. When attach drives to the RAID card, do make sure the master/slave jumper settings are correct please. If there is only one drive on one channel/cable, do set it as master or single drive.
4. **Do** always use 80 conductor cables please.
5. **Don't** connect any ATAPI devices (CD-ROM, LS-120, MO, ZIP, removable HD etc.) on the RAID card please.
6. For the best performance result, please do use the Ultra DMA 66/100 Hard Disks.



Technical Support Form

Company Name:

Phone Number:

Contact Person:

Fax Number:

E-mail Address:

Model	*	BIOS ID #	*
Motherboard Model No.		DRIVER REV	
OS/Application	*		
Hardware Name	Brand	Specifications	
CPU	*		
HDD			
	<input type="checkbox"/> IDE1		
	<input type="checkbox"/> IDE2		
CD-ROM-Drive			
	<input type="checkbox"/> IDE1		
	<input type="checkbox"/> IDE2		
System Memory			
ADD-ON CARD			

Problem Description:



Appendix L. How to Get Technical Support

(From our website) <http://www.abit.com.tw>

(In North America) <http://www.abit-usa.com>

(In Europe) <http://www.abit.nl>

Thank you for choosing ABIT products. ABIT sells all our products through distributors, resellers and system integrators; we have no direct sales to end-users. Before sending email for tech support please check with your resellers or integrators if you need any services, they are the ones who sold you your system and they should know best as to what can be done, how they serve you is a good reference for future purchases.

We appreciate every customer and would like to provide the best service to you. Providing fast service to our customers is our top priority. However we receive many phone calls and a huge amount of email from all over the world. At the present time it is impossible for us to respond to every single inquiry. Therefore it is quite possible that if you send an email to us that you may not receive a response.

We have done many compatibility tests and reliability tests to make sure our products have the best quality and compatibility. In case you need service or technical support, please understand the constraint we have and **always check with the reseller who sold the product to you first.**

To expedite service, we recommend that you follow the procedures outlined below before contacting us. With your help, we can meet our commitment to provide the best service to the **greatest number of ABIT customers:**

- 1. Check the Manual.** It sounds simple but we have taken a lot of care in making a well-written and thorough manual. It is full of information that doesn't only pertain to motherboards. The CD-ROM included with your board will have the manual as well as drivers. If you don't have either one, go to our Program Download Area of the Website or FTP server.
- 2. Download latest BIOS, software or drivers.** Please go to our Program Download area on our Website to check to see if you have the latest BIOS. They are developed over periods of time to fix bugs or incompatibilities. **Also please make sure you have the latest drivers from your peripheral cards makers!**
- 3. Check the ABIT Technical Terms Guide and FAQ on our Website.** We are trying to expand and make the FAQs more helpful and information rich. Let us know if you have any suggestions. For hot topics check out our HOT FAQ!

4. **Internet Newsgroups.** They are a great source of information and many people there can offer help. ABIT's Internet News group, alt.comp.periphs.mainboard.abit, is an ideal forum for the public to exchange information and discuss experiences they have had with ABIT products. Many times you will see that your question has already been asked before. This is a public Internet news group and it is reserved for free discussions. Here is a list of some of the more popular ones:

alt.comp.periphs.mainboard.abit

comp.sys.ibm.pc.hardware.chips

alt.comp.hardware.overclocking

alt.comp.hardware.homebuilt

alt.comp.hardware.pc-homebuilt

5. **Ask your reseller.** Your ABIT authorized distributor should be able to provide the fastest solution to your technical problem. We sell our products through distributors who sell to resellers and stores. Your reseller should be very familiar with your system configuration and should be able to solve your problem much more efficiently than we could. After all, your reseller regards you as an important customer who may purchase more products and who can urge your friends to buy from him or her as well. They integrated and sold the system to you. They should know best what your system configuration is and your problem. They should have reasonable return or refund policies. How they serve you is also a good reference for your next purchase.
6. **Contacting ABIT.** If you feel that you need to contact ABIT directly you can send email to the ABIT technical support department. First, please contact the support team for the branch office closest to you. They will be more familiar with local conditions and problems and will have better insight as to which resellers offer what products and services. Due to the huge number of emails coming in every day and other reasons, such as the time required for problem reproduction, we will not be able to reply to every email. Please understand that we are selling through distribution channels and don't have the resources to serve every end-user. However, we will try to do our best to help every customer. Please also remember that for many of our technical support team English is a second language, you will have a better chance of getting a helpful answer if your question can be understood in the first place. Be sure to use very, simple, concise language that clearly states the problem, avoid rambling or flowery language and always list your system components. Here is the contact information for our branch offices:

North America and South America:

ABIT Computer (U.S.A.) Corporation

45531 Northport Loop West,
Fremont, California 94538, U.S.A.

Tel: 1-510-623-0500

Fax: 1-510-623-1092

sales@abit-usa.com

technical@abit-usa.com

U.K. and Ireland:

ABIT Computer (U.K.) Corporation Ltd.

Unit 3, 24-26 Boulton Road,
Stevenage, Herts SG1 4QX, U.K.

Tel: 44-1438-228888

Fax: 44-1438-226333

sales@abitcomputer.co.uk

technical@abitcomputer.co.uk

Germany, Benelux (Belgium, Netherlands, Luxembourg), Denmark, Norway, Sweden, Finland, and Switzerland:

AMOR Computer B.V. (ABIT's European Office)

Van Coehoornstraat 7,
5916 PH Venlo, The Netherlands

Tel: 31-77-3204428

Fax: 31-77-3204420

sales@abit.nl

technical@abit.nl

Austria, Czech, Romania, Bulgaria, Yugoslavia, Slovakia, Slovenia, Croatia, Bosnia and Serbia:

Asguard Computer Ges.m.b.H

Schmalbachstrasse 5,
A-2201 Gerasdorf/wien, Austria

Tel: 43-1-7346709

Fax: 43-1-7346713

asguard@asguard.at

Japan:**ABIT Computer (Japan) Co. Ltd.**

Fax: 81-3-5396-5110

<http://www.abit4u.jp>***Shanghai:*****ABIT Computer (Shanghai) Co. Ltd.**

Tel: 86-21-6235-1829

Fax: 86-21-6235-1832

<http://www.abit.com.cn>***Russia:*****ABIT Computer (Russia) Corporation Ltd.**

Fax: 7 (095) 937 8237

<http://www.abit.ru>***France:*****ABIT Computer France SARL**

4, Place La Defense,

92974 Paris La Defense cedex, France

Fax: 33-1-5858-0047

<http://www.abit.com.tw>***All other territories not covered above please contact******Taiwan Head Office:***

When contacting our headquarters please Note we are located in Taiwan and we are 8+ GMT time. In addition, we have holidays that may be different from those in your country.

ABIT Computer Corporation

No.323, YangGuang St., Neihu,

Taipei, 114, Taiwan

Tel: 886-2-8751-8888

Fax: 886-2-8751-3381

sales@abit.com.twmarket@abit.com.twtechnical@abit.com.tw<http://www.abit.com.tw>

7. **RMA Service.** If your system has been working but it just stopped, but you have not installed any new software or hardware recently, it is likely that you have a defective component. Please contact the reseller from whom you bought the product. You should be able to get RMA service there.

8. **Reporting Compatibility Problems to ABIT.** Because of tremendous number of email messages we receive every day, we are forced to give greater weight to certain types of messages than to others. For this reason, any compatibility problem that is reported to us, giving detailed system configuration information and error symptoms will receive the highest priority. For the other questions, we regret that we may not be able to reply directly. But your questions may be posted to the Internet news group in order that a larger number of users can have the benefit of the information. Please check the news group from time to time.

9. The information listed below are some **chipset vendors' WEB site addresses** for your reference:
ALi's WEB site: <http://www.ali.com.tw/>
HighPoint Technology Inc.'s WEB site: <http://www.highpoint-tech.com/>
Intel's WEB site: <http://www.intel.com/>
SiS' WEB site: <http://www.sis.com.tw/>
VIA's WEB site: <http://www.via.com.tw/>

Thank You
ABIT Computer Corporation
<http://www.abit.com.tw>