

AZ31

MAINBOARD MANUAL

DOC No.: M00402

Rev. : A2

Date : 7, 2000

Part No. : 25-11523-22

Handling Precautions

Warning:

1. Static electricity may cause damage to the integrated circuits on the motherboard. Before handling any motherboard outside of its protective packaging, ensure that there is no static electric charge in your body.
2. There is a danger of explosion if the battery is incorrectly replaced. Replace only with the same or an equivalent type recommended by the manufacturer.
3. Discard used batteries according to the manufacturer's instructions.

Observe the following basic precautions when handling the motherboard or other computer components:

- Wear a static wrist strap which fits around your wrist and is connected to a natural earth ground.
- Touch a grounded or anti-static surface or a metal fixture such as a water pipe.
- Avoid contacting the components on add-on cards, motherboards, and modules with the *golden fingers* connectors plugged into the expansion slot. It is best to handle system components by their mounting brackets.

The above methods prevent static build-up and cause it to be discharged properly.

Trademark

All trademarks mentioned in this manual are registered properly of the respective owners.

Handling Precautions

This manual may not, in whole or in part, be photocopied, reproduced, transcribed, translated, or transmitted in whatever form without the written consent of the manufacturer, except for copies retained by the purchaser for personal archival purposes.

Chapter 1 Overview

Package Checklist 1-2
 The AZ31 Mainboard 1-3
Main Features 1-4
ACPI Ready 1-6
FIC Unique Innovation for UsersII (NOVUS II) -
Enhanced Mainboard Features and System Support 1-6

Chapter 2 Installation Procedures

Quick Reference (from Page 2-2 to 2-4) 2-2
 Mainboard Layout 2-2
 1). Clear CMOS, FSB Speed Select, Over Voltage Driving 2-3
 2). Front Panel Block Cable Connection 2-4
 3). CPU Fan Installation 2-4
1). Set System Jumpers 2-5
 Clear CMOS: CLR_CMOS 2-6
 Enabling Over Voltage Driving: Magic Tuner 2-6
 FSB Speed Select: 100MHz/133MHz 2-6
2). Install RAM Modules 2-7
 Install and Remove DIMMs 2-7
3). Install the CPU 2-8
4). Install Expansion Cards 2-9
5). Connect Devices 2-10
 Floppy Diskette Drive Connector: FDD 2-10
 IDE HDD Device Connectors: PRIMARY, SECONDARY .. 2-11
 ATX Power Connector: ATX_PWR 2-11
 CPU Fan Connector: CPU_FAN 2-12
 System Case Fan Connectors: CHS_FAN, SYS_FAN 2-12
 CD Audioo-In Connectors: CD_IN1, CD_IN2 2-13
 Front Panel Block Connector: FPNL 2-13
 PS/2 Keyboard and Mouse Connector: PS2_KB, PS2_MS 2-15
 Universal Serial Bus Connectors: Rear USBs, Front USBs 2-15
 Printer Connector: LPT 2-16
 Serial Port Connectors: COM 2-16
 Audio I/O Jacks: LINE_OUT, LINE_IN, MIC_IN 2-17
 NOVUS II Module Connector: NOVUS II 2-17

Chapter 3 BIOS Setup

CMOS Setup Utility	3-1
Standard CMOS Setup	3-2
Hard Disk Configurations	3-2
Advanced BIOS Features	3-3
Advanced Chipset Features	3-6
Integrated Peripherals	3-11
Power Management Setup	3-15
PNP/PCI Configurations	3-20
PC Health Status	3-21
Frequency/Voltage Control	3-22
Load Fail-Safe Defaults	3-23
Load Optimized Defaults	3-23
Supervisor/User Password	3-24
Save and Exit Setup	3-25
Exit without Saving	3-25
Quick Reference (German)	G-1
Quick Reference (French)	F-1
Quick Reference (Spanish)	S-1
Quick Reference (Japanese)	J-1
Quick Reference (Chinese)	C-1
Quick Reference (Simplified Chinese)	SC-1

Overview

The new Socket A 1stMainboard AZ31 is an microATX sized motherboard supporting the latest generation of AMD Athlon and Duron processors at industry leading speeds. By utilizing DDR (Double Data Rate) transfer rate the 100 MHz AMD Athlon system bus effectively reaches speeds of 200 MHz. The AMD Athlon processor offers high-performance cache technology, including 128KB of on-chip level one (L1) , while the Duron features full-speed, on-chip L2 cache memory, and enhanced 3DNow!TM technology. The 1stMainboard AZ31 has 3 DIMM, for up to 1.5 GB of SDRAM, utilizes the latest PC133 SDRAM technology and is equipped with ECC memory support.

The 1stMainboard AZ31 is based around the high performance KT133 chipset comprised of VIA VT 8363 system controller for the North Bridge, and the VIA 686A (Super South). The KT133's support for AGP 4x provides the end-user a photo-realistic 3D experience suitable for the most robust 3D games and software environments. Onboard AC97 sound ensures high quality audio, but with the option of being disabled through the BIOS.

The 1stMainboard AZ31 also comes equipped with the new NOVUS II range of innovative features that assist in the installation and maintenance of your 1stMainboard. The features include *Easy Key*, which provides instant keyboard access to the BIOS for adjustments to Clock and Default settings and *LogoGenie*, which allows you to create your own customized logo to be displayed during system boot up. The *BIOS Guardian* is an Anti Virus utility that prevents viruses from damaging your system BIOS and rendering your system inoperative. Clockometer is a user friendly Graphic User Interface (GUI) that allows you to change clock speed settings directly, without having to enter the BIOS Sub-Menus. Moreover, audio alert II (mfg. optional) , a friendly onboard voice caution, will advice the error during system boot up.

Expansion is provided by 1 AGP and 3 PCI slots. In addition, the 1stMainboard AZ31 is equipped with 2 dual channeled enhanced PCI bus master IDE connectors. Standard I/O connections include 1 serial port, 1 parallel port, 1 PS/2 mouse and keyboard connector, 2 USB connectors, 2 front USB pin-headers and 1 media connector (Line-In, Line-Out, Mic-In).

Package Checklist

If you discover any item below was damaged or lost, please contact your vendor.

- The mainboard
- This user manual
- One FDD cable
- One HDD cable
- One ATA/66 cable
- Audio Alert II module (optional)
- Two software CDs (CD Pro, CD Plus and its manual)



IMPORTANT: AMD CPU HEAT SINK INSTALLATION

Be ware finish heat hink install. Before you boot system, please check the heat sink is complete contact with die of CPU.

The poor contact will bring about over heat, it may damage your processor.

It is strongly recommended that at least a 200-watt ATX power pupply be used for this motherboard. Make sure that your ATX power supply can supply at least 20 amperes on teh +5-Volt lead and 10ma on the +5-Volt standby lead (+5VSB). Your system may become unstable / unreliable and may experience difficulty in powering up if your power supply is inadequate.

The AZ31 Mainboard

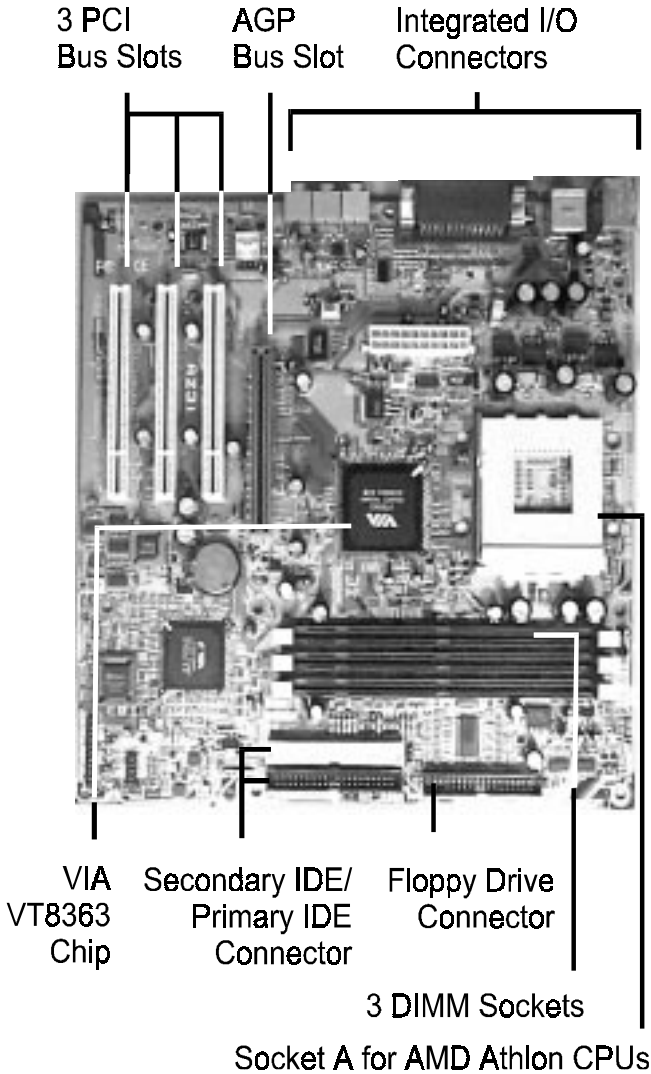

Main Features

■ Easy Installation

BIOS with support for Plug and Play, auto detection of IDE hard drives, LS-120 drives, IDE ZIP drives, Windows 95, Windows 98, Windows NT 4.0, Windows 2000, and OS/2.

■ Leading Edge Chipset

VIA VT8363 and 686A (Super South) provide integrated DRAM controllers with new Dynamic Power Management Architecture (DPMA), concurrent PCI (2.2), AGP 1.0/2.0 compliant and USB.

■ Versatile Main Memory Support

Accepts up to 1.5GB DRAM using three DIMMs of 32, 64, 128, 256, 512MB with support for lightning-fast SDRAM (100/133MHz). The latest Virtual Channel Memory (VCM) SDRAM also supported. *This board allows the FSB and DRAM to be asynchronous.*

■ AMD® Athlon™ Processors Support

Duron Socket A CPU 600/650/700/750MHz at 100MHz FSB with AMD bus for double data transfer rate at 100MHz for an effective 200MHz transfer rate.

Athlon Socket A CPU 750/800/850/900*/950*MHz and up to 1GHz* at 100MHz FSB with AMD Athlon bus for double data rate transfers at 100MHz for effective 200MHz transfer rate.

■ Enhanced PCI Bus Master IDE Controller with Ultra DMA/33 and Ultra DMA/66 Support

Integrated Enhanced PCI Bus Master IDE controller features two dual-channel connectors that up to four Enhanced IDE devices, including CD-ROM and Tape Backup Drives, as well as Hard Disk Drives supporting the new Ultra DMA/66 protocol. Standard PIO Mode 3, PIO Mode 4, DMA Mode 2, DMA Mode 4 devices are also supported.

■ AGP and PCI Expansion Slots

One AGP Bus expansion slot and three PCI Bus expansion slots provided the room to install a full range of add-on cards.

■ Compact Onboard Audio Subsystem

Embedded in VIA 686A®, the audio processor offers an integrated PCI audio controller, DOS games compatible engine, and offers the feature of high-quality music synthesizer. The subsystem utilizes line-out, line-in, and MIC mini-jack external jacks, one joystick port with MIDI interface.

■ Super Multi Input/Output (I/O) Support

Integrated Plug and Play multi-I/O chipset features one high-speed UART 16550 compatible serial port, one EPP/ECP capable parallel port, and one FDD connector.

■ Convenient Rear Panel USB Connection Support

Two USB ports integrated in the rear I/O panel with two manufacturing optional USB front panel connections allow convenient and high-speed Plug and Play connections to the growing number of USB compliant peripheral devices on the market.

■ Onboard Accelerated Graphics Port (AGP)

The motherboard is installed one 32-bit AGP bus with a dedicated 66MHz/133MHz path from the graphics card to the system memory offering much greater bandwidth than the 32-bit PCI bus does. AGP enabled 3D graphics cards can directly access main memory across this fast path instead of using local memory. To make use of the improved AGP performance, the motherboard should be installed with SDRAM type memory and the VGA card and drivers should also be fully AGP compliant. Using Microsoft's Windows 98 and Windows 2000 which implement DirectDraw will allow the system to take full use of AGP's benefits without the need to install additional drivers.

ACPI Ready

This mainboard fully implements the new ACPI (Advanced Configuration and Power Interface) 1.0B Hardware and BIOS requirement. If you install ACPI aware of operating system, such as Windows 98, you fully utilized the power saving under ACPI. (*Windows 2000 Professional supports ACPI functions.*)

It is compatible with all other none ACPI operating systems. If you want to setup ACPI feature under Windows 98, please follow the description below: Run Windows 98 setup by using **setup/p j** on the command line for installing Windows 98 with the ACPI control feature.

If you type **setup** without the parameter **/p j**, Windows 98 will be installed as APM, PnP mode, no ACPI will be used. For more detail information, please visit the web site of Microsoft. Its address is: www.microsoft.com/hwtest/.



NOTE: If BIOS date is after 12/02/1999, the ACPI will be installed automatically. Users do not need to setup in the above-mentioned way.

FIC Unique Innovation for Users II (NOVUS II) - Enhanced Mainboard Features and System Support

■ LogoGenie

A user friendly GUI supporting Windows 98, LogoGenie allows you to customize, create or select a Logo which will be displayed when the system is booting.

Before execute this LogoGenie function, please make sure the related BIOS feature, BIOS Guardian, is disabled; and refer to its related README file.



NOTE:

1. LogoGenie supports Award BIOS only.
2. If you create a Logo file (.bmp) by LogoGenie, the file size must be 640 x 464 x 16 colors (around 145K).

To enable this utility, please proceed as follows:

1. Insert CD Pro 4.X. Select LogoGenie from the Menu and follow the installation instructions.
2. After LogoGenie has been installed, go to Windows Start Box. In Programs Menu, select LogoGenie. Click three check boxes in the pop-up menu for making sure of the BIOS feature (*BIOS Guardian*) and other anti-virus software are disabled. Read README file carefully. After all these, the next procedure proceeds.
3. In LogoGenie Dialogue Box, choose one of 3 options; and then proceed as introduced in 4 or 5 steps listed on the left hand side of the Dialogue Box.
4. After complete the last step, press OK. The system will reboot to restore the BIOS with your new customized Logo.
5. The system will automatically restart with your customized Logo that appears in background.



WARNING: While excute Step3 below, please do not turn off the system power in order to avoid BIOS damage.

■ BIOS Guardian

BIOS Guardian by default is enabled. It must be disabled in order to reflash BIOS, thus effectively acts as a fire-wall against viruses that can attack the BIOS while the system is running.

BIOS Guardian can be disabled as follows:

1. Go to BIOS Set Up Menu. (Press **Del** key while booting.)
2. Go to Advanced BIOS Features Set Up Submenu.
3. Disable BIOS Guardian.
4. Save the setting, and restart system.



NOTE: However, if it is disabled and while boot the system, the POST screen will be held and shows you the message to let you know the current status of BIOS Guardian. To press **G** key will enable the BIOS Guardian again; or simply to press the **space bar** will continue the booting process.

■ Easy Key

Instead of completing the multi-layered BIOS setup process these 3 Easy Key functions provide direct access to Sub-Menu's when completing BIOS settings adjustments.

Easy-Keys are as follows:

- Ctrl + c:** To enter clock settings menu.
- Ctrl + p:** To load Performance Default settings and restart.
- Ctrl + f:** To load Fail-Safe Default settings and restart.

■ Overclock Partner

Should the system not start because clock speed settings have been increased to a speed incompatible with the system, the Overclock Partner allows you to reboot at system default settings, protecting hardware from any damages.

Complete the following steps:

1. Turn the system off.
2. Restart while holding down the **Insert** key. It is important that the **Insert** key is held down until the default clock speed is shown on the POST screen.
3. Enter BIOS settings menu, and re-set clock speed desired or default.

■ Clockometer

Clockometer is a Windows 98 compatible, attractive and user friendly Graphic User Interface (GUI). Clockometer enables you to change clock speed settings directly, without having to enter the BIOS Sub-Menus. With the on-screen display panel you can easily monitor your new clock speed settings with gauges that identify your system speed, Front Side Bus settings and CPU Ratios

On screen buttons:

1. "+" and "-" buttons : adjust the Front Side Bus (FSB)and CPU ratio. (the 'hand' cursor means the active button)
2. "OK" button : changes the FSB and CPU ratio (if adjustable) settings right away. If you do not save your new setting, your system will not implement the new setting when rebooting the next time.
3. "SAVE" button : save your new settings for rebooting the computer.
4. "Quit" button will escape the Clockometer program.
5. In order to run the other application programs more smoothly, it is strongly recommended to restart your computer after completing any adjustments.

■ Audio Alert II (optional)

After complete a system upgrade, should the computer be assembled incorrectly, a friendly onboard voice caution, will advice the error during system boot up.

A convenient onboard LED will also flash, warning that there is a system problem. If you do not hear the Audio Alert , please check that your speakers are connected.

Audio warning are activated as follows:

No CPU: 'Caution! Processor not detected. Please check your PC'

No Memory: 'Caution! Memory not detected. Please check your PC'

No Graphics: 'Caution! VGA not detected. Please check your PC'

Installation Procedures

The mainboard has several user-adjustable jumpers on the board that allow you to configure your system to suit your requirements. This chapter contains information on the various jumper settings on your mainboard.

To set up your computer, you must complete the following steps:

- Step 1 - Set system jumpers
- Step 2 - Install memory modules
- Step 3 - Install the Central Processing Unit (CPU)
- Step 4 - Install expansion cards
- Step 5 - Connect ribbon cables, cabinet wires, and power supply
- Step 6 - Set up BIOS software
- Step 7 - Install supporting software tools



WARNING: Excessive torque may damage the mainboard. When using an electric screwdriver on the mainboard, make sure that the torque is set to the allowable range of 5.0 ~ 8.0kg/cm.

Mainboard components contain very delicate Integrated Circuit (IC) chips. To prevent static electricity from harming any of the mainboard's sensitive components, you should follow the following precautions whenever working on the computer:

1. Unplug the computer when working on the inside.
2. Hold components by the edges and try not to touch the IC chips, leads, or circuitry.
3. Wear an anti-static wrist strap which fits around the wrist.
4. Place components on a grounded anti-static pad or on the bag that came with the component whenever the components are separated from the system.

Quick Reference (from Page 2-2 to 2-4)

Mainboard Layout

Chapter 2
Installation
Procedures

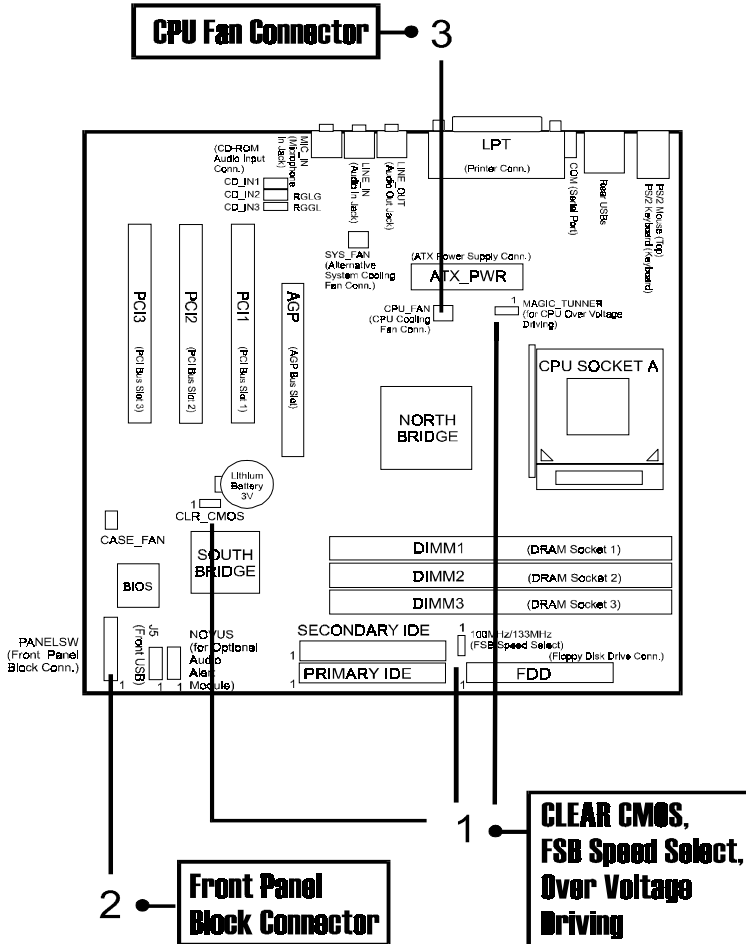

1). **Clear CMOS, FSB Speed Select, Over Voltage Driving**

CLR_CMOS
(Clear CMOS)



Normal
(Default)



Clear CMOS

100MHZ/133MHZ
(FSB Speed Select)

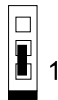

133 MHZ

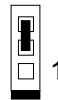

100 MHZ
(Default)

MAGIC_TUNNER
(for CPU Over Voltage Driving)



Over Voltage
Driving



Normal
(Default)

2). Front Panel Block Cable Connection

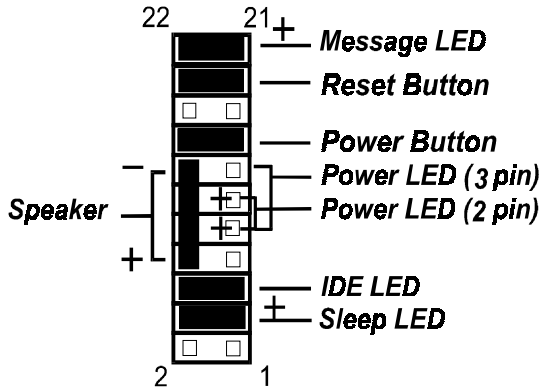

3). CPU Fan Installation

This connector is linked to the CPU fan. Without sufficient air circulation, the CPU may overheat resulting in damage to both the CPU and the mainboard. ***Damage may occur to the mainboard and/or the CPU fan if these pins are used incorrectly. These are not jumpers, do not place jumper caps over these pins.***

1). Set System Jumpers

Jumpers are used to select the operation modes for your system. Some jumpers on the board have three metal pins with each pin representing a different function. A “1” is written besides pin 1 on jumpers with three pins. To **set** a jumper, a black cap containing metal contacts is placed over the jumper pin/s according to the required configuration. A jumper is said to be **shorted** when the black cap has been placed on one or two of its pins. The types of jumpers used in this manual are shown below:

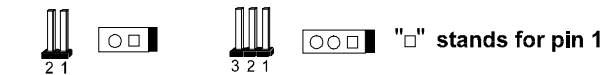
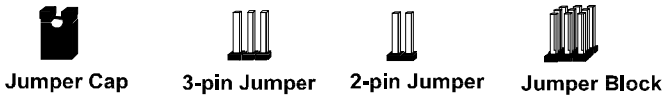

Jumper are shown llke above



Jumper cap like above



Jumpers in a Block



NOTE: Users are not encouraged to change the jumper settings not listed in this manual. Changing the jumper settings improperly may adversely affect system performance.

Clear CMOS: CLR_CMOS

The CMOS RAM is powered by the onboard button cell battery. To clear the RTC data: (1). Turn off your computer, (2). Move the jumper to CLEAR, (3). Move the jumper back to NORMAL, (4). Turn on your computer, (5). Hold down the <Delete> key during bootup and enter BIOS Setup to re-enter user preferences.

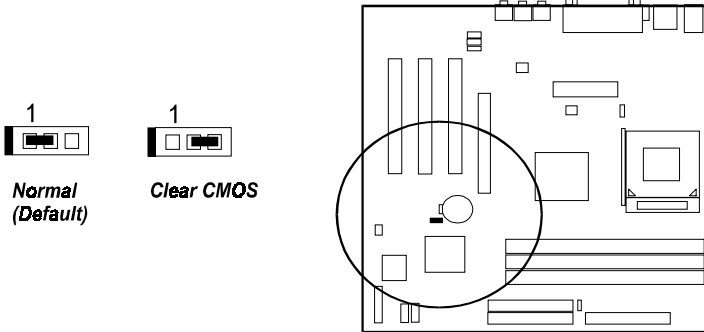

Enabling Over Voltage Driving : Magic Tunner

The 3-pin jumper allows you to start the over voltage driving capability of this mainboard to approach the best performance.



WARNING: Voltage and frequency above CPU's original specifications are not guaranteed to be stable.

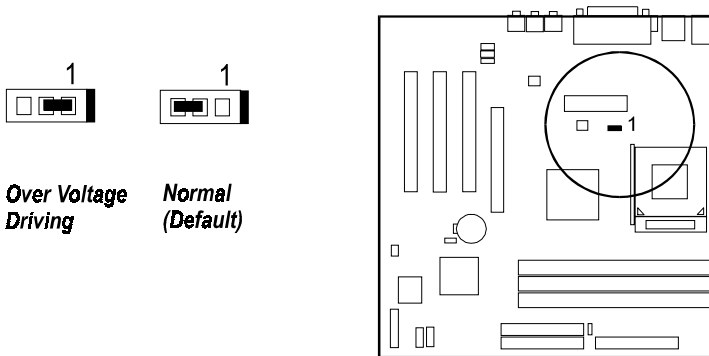

FSB Speed Select: 100MHz/133MHz

The jumper allows users to select the front side bus speed.

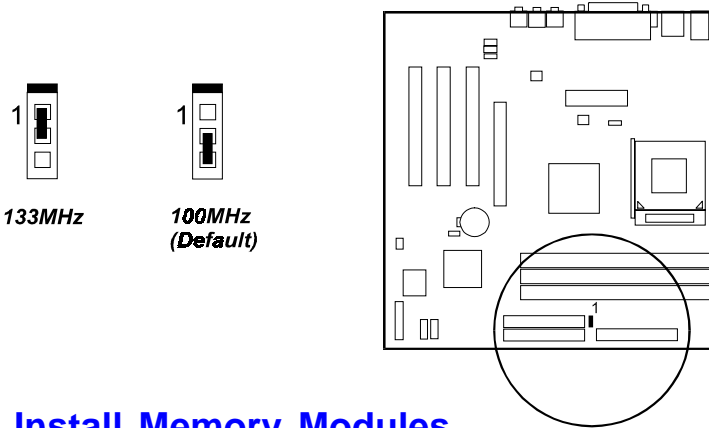

2). Install Memory Modules

Install and Remove DIMMs

1. Locate the DIMM slots on the mainboard.
2. Install the DIMM straight down into the DIMM slot using both hands.
3. The clip on both ends of the DIMM slot will close up to hold the DIMM in place when the DIMM reaches the slot's bottom.

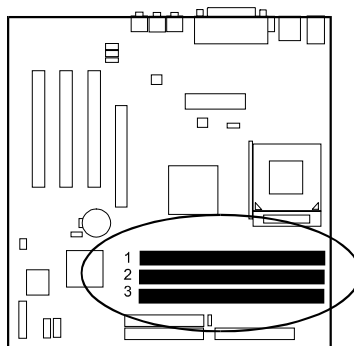

Press the clips with both hands to remove the DIMM.

3). Install the CPU

The AMD Athlon CPU module resides in the Socket A socket on the board. The Retention Mechanism Assembly that is foldable for saving space when shipping and packing had been installed on the mainboard by the manufacturer. Please follow the steps introduced below to complete the CPU installation.

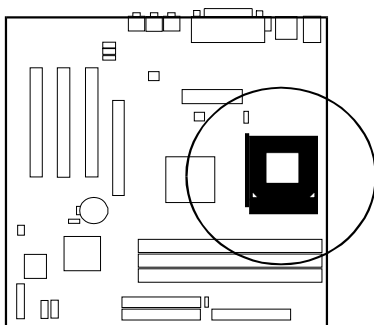

CAUTION: Make sure to unplug the power supply when adding or removing expansion cards or other system components. Failure to do so may cause severe damage to both the mainboard and expansioncards.

Always observe static electricity precautions.

Please read "Handling Precautions" at the start of this manual.

To install the CPU, do the following:

1. Lift the lever on the side of the CPU socket.
2. Handle the chip by its edges and try not to touch any of the pins.
3. Place the CPU in the socket. The chip has two notches to correctly locate the chip. Align two notches of the processor with the two triangular marks on the socket. Do not force the chip. The CPU should slide easily into the socket.
4. Swing the lever to the down position to lock the CPU in place.
5. Place the cooling fan with heatsink on top of the installed CPU.

4). Install Expansion Cards

This section describes how to connect an expansion card to one of your system's expansion slots. Expansion cards are printed circuit boards that, when connected to the mainboard, increase the capabilities of your system. For example, expansion cards can provide video and sound capabilities. The mainboard features five PCI bus and one AGP bus expansion slots.

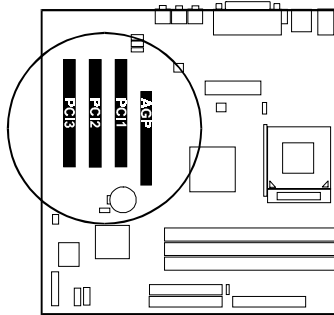

CAUTION: Make sure to unplug the power supply when adding or removing expansion cards or other system components. Failure to do so may cause severe damage to both the mainboard and expansion cards.

Always observe static electricity precautions.

Please read "Handling Precautions" at the start of this manual.

To install an expansion card, follow the steps below:

1. Remove the computer chassis cover and select an empty expansion slot.
2. Remove the corresponding slot cover from the computer chassis. Unscrew the mounting screw that secures the slot cover and pull the slot cover out from the computer chassis. Keep the slot cover mounting screw nearby.

3. Holding the edge of the peripheral card, carefully align the edge connector with the expansion slot.
4. Push the card firmly into the slot. Push down on one end of the expansion card, then the other. Use this “rocking” motion until the add-on card is firmly seated inside the expansion slot.
5. Secure the board with the mounting screw removed in Step 2. Make sure that the card has been placed evenly and completely into the expansion slot.
6. Replace the computer system’s cover.
7. Setup the BIOS if necessary.
8. Install the necessary software drivers for the expansion card.

5). Connect Devices

Floppy Diskette Drive Connector: FDD

This connector provides the connection with your floppy disk drive. The red stripe of the ribbon cable must be the same side with the Pin 1.

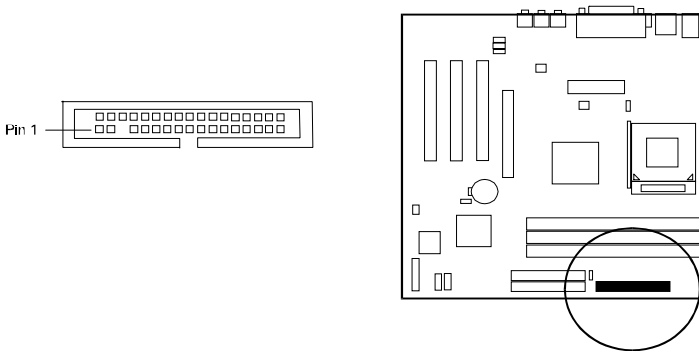

IDE Device Connectors: ***PRIMARY, SECONDARY***

These two connectors are used for your IDE hard disk drives, CD drives, LS-120 drives, or IDE ZIP drives. The red stripe of the ribbon cable must be the same side with the Pin 1.

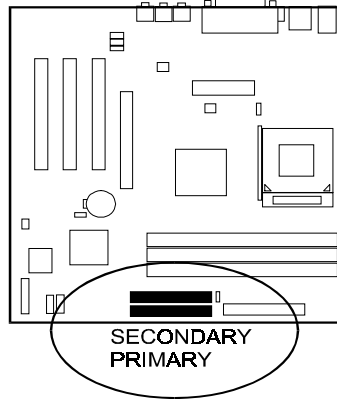
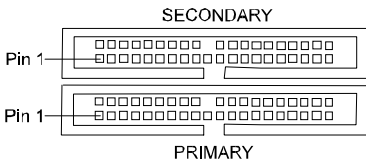

**Chapter 2
Installation
Procedures**

ATX Power Connector: ***ATX_PWR***

This 20-pin male block connector is connected to the ATX power supply. The plug from the power supply will only insert in one orientation because of the different hole sizes. Find the proper orientation and push down firmly making sure that the pins are aligned.

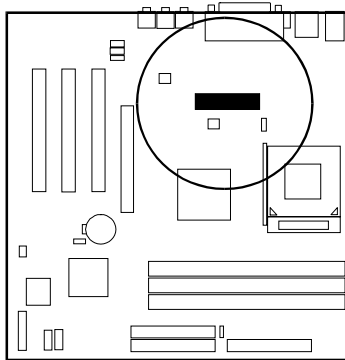
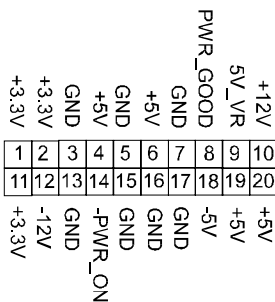

CPU Fan Connector: CPU_FAN

This connector is linked to the CPU fan to lower the CPU temperature. Please refer to the CPU fan installation manual for more information.

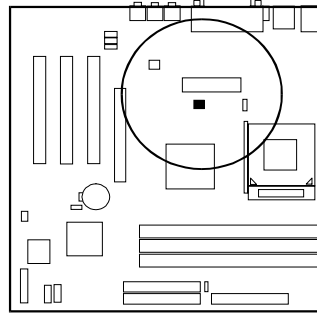
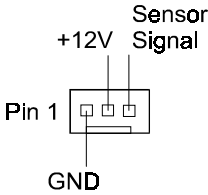

Chapter 2
Installation
Procedures

System Case Fan Connectors: CHS_FAN, SYS_FAN

Either of these two 3-pin connectors allows you to link with the cooling fan on the system case to lower the system temperature.

SYS_FAN

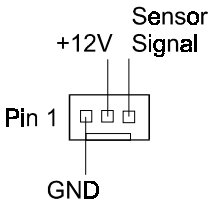

CASE_FAN

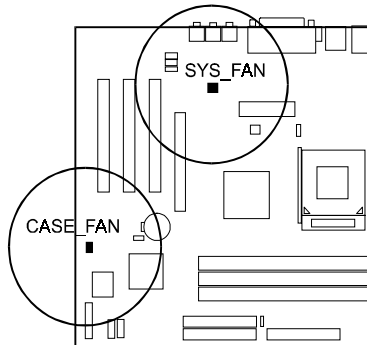
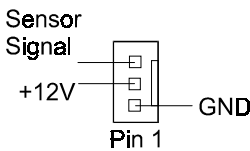

CD Audio-In Connectors: CD_IN1, CD_IN2

These three 4-pin connectors are used for different types of the AUDIO-OUT port from your CD drive.

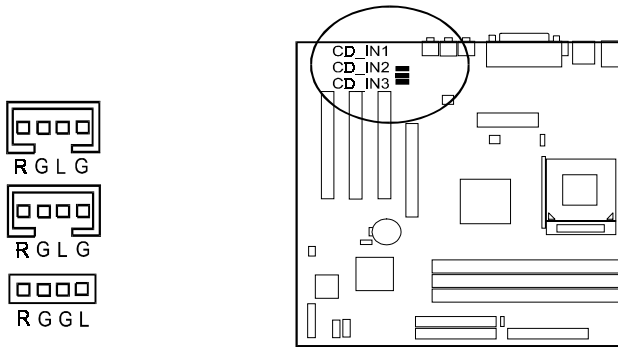

**Chapter 2
Installation
Procedures**

Front Panel Block Connector: FPNL

This block connector includes the connectors for linking with IDE LED, power LED, remote power button, message LED, suspend button, reset button and speaker on the front panel of the system case. Please identify polarities of plug wires for the case speaker and LEDs. Please ask vendor about this information when you buy them and install the system by yourself. The plug wires' polarities of these buttons will not affect the function.

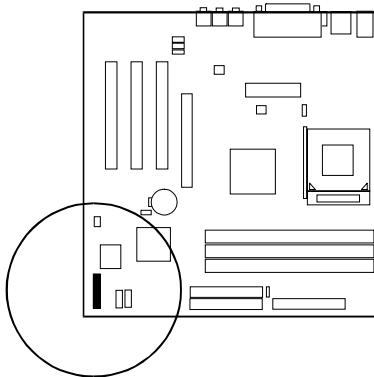

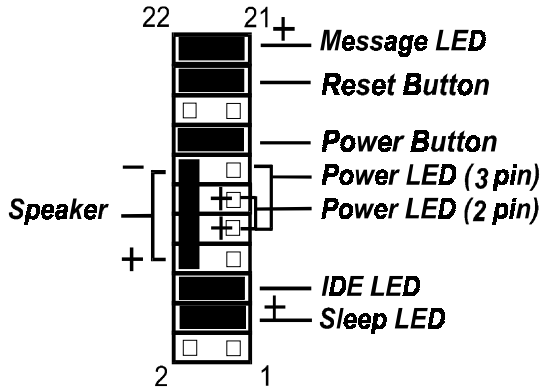

Message LED is connected with the message LED. When the system is running normally, the indicator is off. It is controlled by the operating system or application software.

Reset Button is connected to the reset button. Push this switch to reboot the system instead of turning the power button off and on.

Power Button is connected with power button. Push this switch allows the system to be turned on and off rather than using the power supply button.

Power LED is connected with the system power indicator to indicate whether the system is on/off. It will blink when the system enters suspend mode.

Speaker is connected with the case speaker.

IDE LED is connected to the IDE device indicator. This LED will blink when the hard disk drives are activated.

Sleep LED is connected with sleep mode indicator.

PS/2 Keyboard and Mouse Connector: PS2_KB, PS2_MS

These two 6-pin female (PS/2 keyboard is purple color and PS/2 mouse is green color) connectors are used for your PS/2 keyboard and PS/2 mouse.

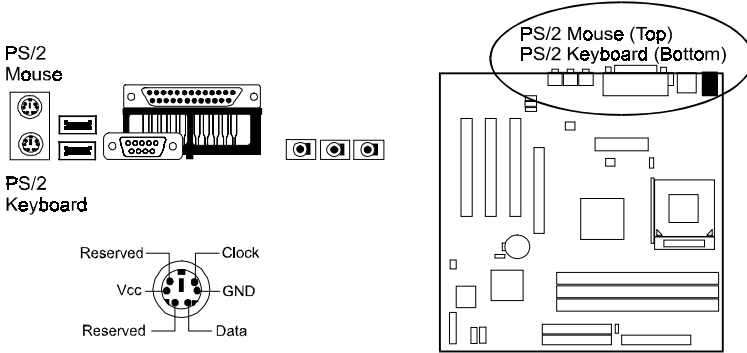

Universal Serial Bus Connectors: Rear USBs, Front USBs

These two black connectors integrated on the edge of the board are used for linking with USB peripheral devices. This board also provides a connector J5 for linking with the two USB sockets on the front panel of some system cases. Please note your operating system must support USB features, such as MS Windows 98, MS Windows 95 OSR2.5 with USB Supplement.

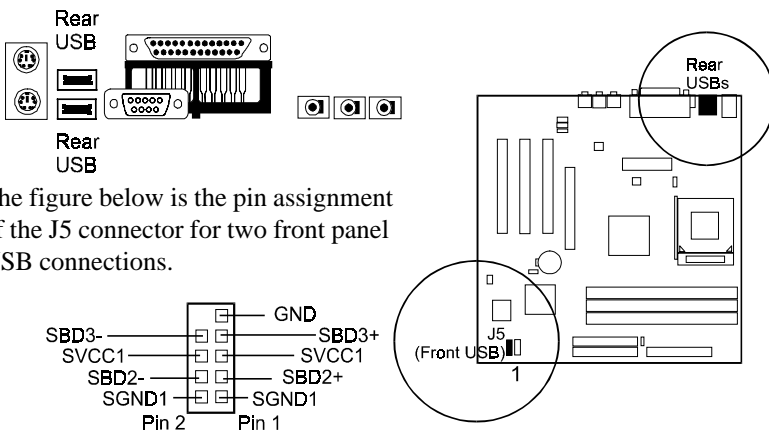

Printer Connector: LPT

This 25-pin D-Sub female burgundy-colored connector is attached to your printer.

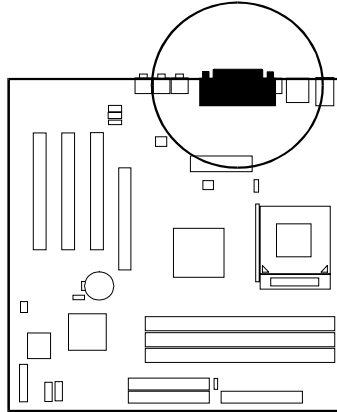
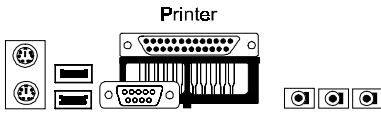

Serial Port Connector: COM

COM allows you to connect with your devices that use serial ports, such as a serial mouse or an external modem.

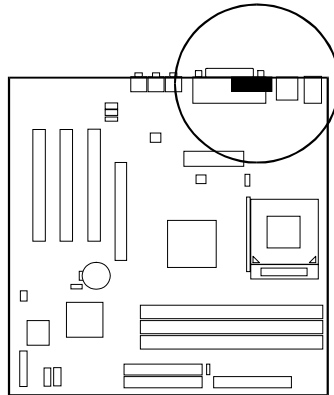
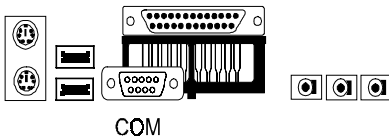

Audio I/O Jacks: LINE_OUT, LINE_IN, MIC_IN

LINE_OUT (lime) can be connected to headphones or preferably powered speakers. LINE_IN (light blue) allows tape players or other audio sources to be recorded by your computer or played through the LINE_OUT. MIC_IN (pink) allows microphones to be connected for voice input.

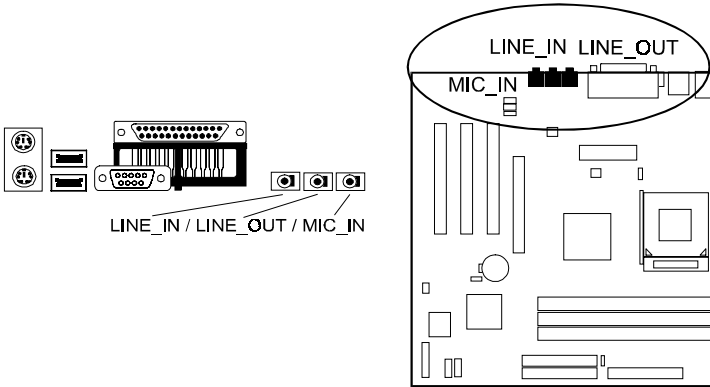

**Chapter 2
Installation
Procedures**

NOVUS II Module Connector: NOVUS II

The connector provides the linkage with optional NOVUS II module for having some more helpful features.

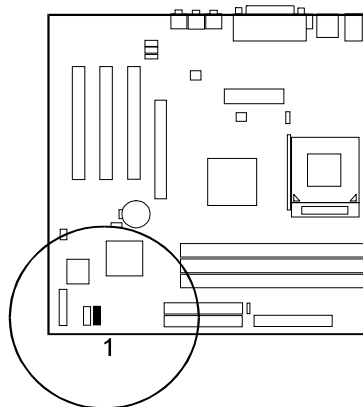

This Page Left Blank for Note

BIOS Setup

CMOS Setup Utility

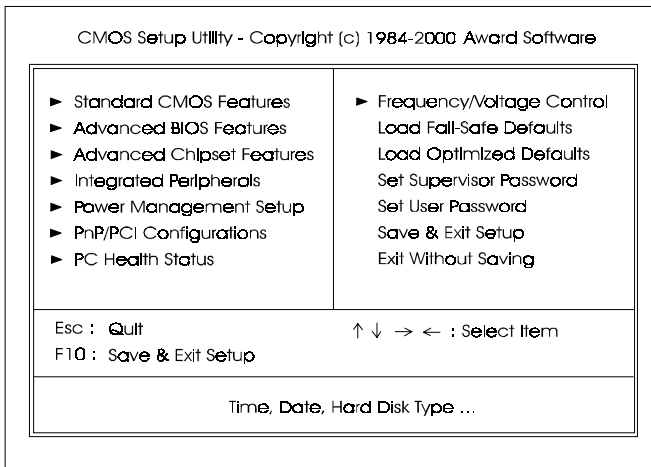

A Setup program, built into the system BIOS, is stored in the CMOS RAM. This Setup utility program allows changes to the mainboard configuration settings. It is executed when the user changes system configuration; user changes system backup battery; or the system detects a configuration error and asks the user to run the Setup program. Use the arrow keys to select and press **Enter** to run the selected program.



NOTE: Please disable this BIOS feature about BIOS Guardian before you start to reflash BIOS.
(Please read Page 1-7, Page 3-6 for detail information).

Standard CMOS Setup

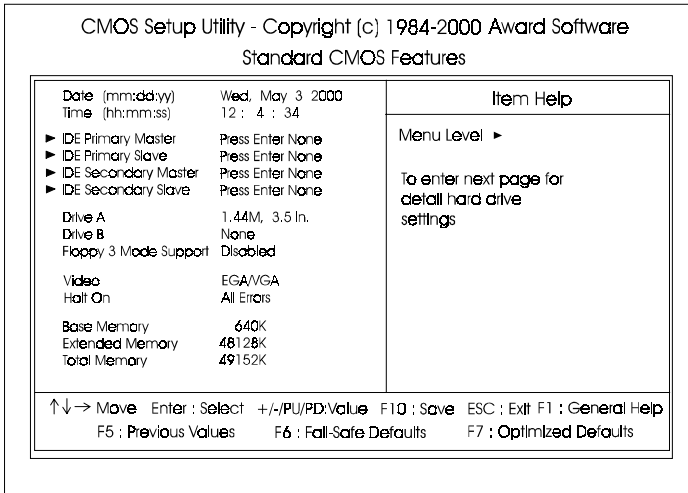

The Standard CMOS Setup screen is displayed above. Each item may have one or more option settings. The system BIOS automatically detects memory size, thus no changes are necessary. Use the arrow keys to highlight the item and then use **PgUp** or **PgDn** keys to select the value you want in each item.

Hard Disk Configurations

Capacity: The hard disk size. The unit is Mega Bytes.

Cylinder: The cylinder number of the hard disk.

Head: The read/write head number of hard disk.

Precomp: The cylinder number at which the disk drive changes the write current.

Landing Zone: The cylinder number that the disk drive heads (read/write) are seated when the disk drive is parked.

Sector: The sector number of each track defined on the hard disk.

Advanced BIOS Features

CMOS Setup Utility - Copyright (c) 1984-2000 Award Software
Advanced BIOS Features

Anti-Virus Protection	Enabled	▲ Item Help Menu Level ▶ Allows you to choose feature for IDE Hard Disk boot sector protection. If this function is enabled and someone attempt to write data into this area, BIOS will show a warning message on screen and alarm beep ▼
CPU Internal Cache	Enabled	
External Cache	Enabled	
Quick Power On Self Test	Enabled	
First Boot Device	Floppy	
Second Boot Device	HDD-0	
Third Boot Device	CDROM	
Boot Other Device	Enabled	
Swap Floppy Drive	Disabled	
Boot Up Floppy Seek	Enabled	
Boot Up NumLock Status	On	
Gate A20 Option	Normal	
Memory Parity/ECC Check	Disabled	
Typeomatic Rate Setting	Disabled	
x Typeomatic Rate (Chars/Sec)	6	
x Typeomatic Delay (Msec)	250	
Security Option	Setup	
OS Select For DRAM > 64MB	Non-OS2	
HDD S.M.A.R.T. Capability	Disabled	

↑↓→ Move Enter : Select +/-/PU/PD/Value F10 : Save ESC : Exit F1 : General Help
 F5 : Previous Values F6 : Fail-Safe Defaults F7 : Optimized Defaults

Chapter 3
BIOS Setup

CMOS Setup Utility - Copyright (c) 1984-2000 Award Software
Advanced BIOS Features

Quick Power On Self Test	Enabled	▲ Item Help Menu Level ▶ ▼
First Boot Device	Floppy	
Second Boot Device	HDD-0	
Third Boot Device	CDROM	
Boot Other Device	Enabled	
Swap Floppy Drive	Disabled	
Boot Up Floppy Seek	Enabled	
Boot Up NumLock Status	On	
Gate A20 Option	Normal	
Memory Parity/ECC Check	Disabled	
Typeomatic Rate Setting	Disabled	
x Typeomatic Rate (Chars/Sec)	6	
x Typeomatic Delay (Msec)	250	
Security Option	Setup	
OS Select For DRAM > 64MB	Non-OS2	
HDD S.M.A.R.T. Capability	Disabled	
Report No FDD For WIN 95	No	
Video BIOS Shadow	Enabled	
BIOS Guardian	Enabled	

↑↓→ Move Enter : Select +/-/PU/PD/Value F10 : Save ESC : Exit F1 : General Help
 F5 : Previous Values F6 : Fail-Safe Defaults F7 : Optimized Defaults

Anti-Virus Protection

This feature starts the virus scan tool to detect if boot virus in boot sector of the first hard disk drive when booting up.

The options are: Enabled (Default), Disabled.

CPU Internal Cache

When enabled, improves the system performance. Disable this item when testing or trouble-shooting. The options are: Enabled (Default), Disabled.

External Cache

When enabled, supports an optional cache SRAM. This feature allows you to disable the cache function when the system performance is unstable to run some software. The options are: Enabled (Default), Disabled.

Quick Power On Self Test

When enabled, allows the BIOS to bypass the extensive memory test.

The options are: Enabled (Default), Disabled.

First Boot Device

This feature allows user to select the boot device priority.

The options are: Floppy (Default), LS120, HDD-0, SCSI, CDROM, HDD-1, HDD-2, HDD-3, ZIP100, LAN, Disabled.

Second Boot Device

This feature allows user to select the boot device priority.

The options are: Floppy, LS120, HDD-0 (Default), SCSI, CDROM, HDD-1, HDD-2, HDD-3, ZIP100, LAN, Disabled.

Third Boot Device

This feature allows user to select the boot device priority.

The options are: Floppy, LS120, HDD-0, SCSI, CDROM (Default), HDD-1, HDD-2, HDD-3, ZIP100, LAN, Disabled.

Boot Other Device

This feature allows user to select the boot device priority.

The options are: Enabled (Default), Disabled.

Swap Floppy Drive

Allows you to switch the order in which the operating system accesses the floppy drives during boot up.

The options are: Enabled, Disabled (Default).

Boot Up Floppy Seek

When enabled, assigns the BIOS to perform floppy diskette drive tests by issuing the time-consuming seek commands.

The options are: Enabled (Default), Disabled.

Boot Up Numlock Status

When set to On, allows the BIOS to automatically enable the Num Lock Function when the system boots up. The options are: On (Default), Off.

Gate A20 Option

When set at Fast, allows a faster access response under Protected mode.

The options are: Fast, Normal (Default).

Memory Parity/ECC Check

Enabling it will add a parity/ECC check to the boot-up memory tests. Set at Enabled only if the system DRAM contains parity.

The options are: Disabled (Default), Enabled.

Typematic Rate Setting

The term typematic means that when a keyboard key is held down, the character is repeatedly entered until the key is released.

The options are: Disabled (Default), Enabled.

Typematic Rate (Chars/Sec)

This feature is available only if the above item, Typematic Rate Setting, is set at Enabled. Sets the rate of a character repeat when the key is held down. The options are: 6 (Default), 8, 10, 12, 15, 20, 24, 30.

Typematic Delay (Msec)

This feature is available only if the item, Typematic Rate Setting, is set at Enabled. Sets the delay time before a character is repeated.

The options are: 250 (Default), 500, 750, 1000 millisecond.

Security Option

Allows you to set the security level of the system.
The options are: Setup (Default), System.

OS Select For DRAM > 64MB

If your operating system (OS) is OS/2, select the option OS2. Otherwise, stay with the default setting Non-OS2.
The options are: Non-OS2 (Default), OS2.

HDD S.M.A.R.T. Capability

S.M.A.R.T. stands for Self-Monitoring and Analysis Reporting Technology which allows your hard disk drive to report any read/write errors and issues a warning with LDCM installed.
The options are: Disabled (Default); Enabled.

Report No FDD For WIN 95

When the field under the Standard CMOS Setup Menu for Drive A and/or Drive B is set at None, users must set this field is set at Yes for it to function properly. Otherwise, set at No, even if field for Drive A and/or Drive B is set at None, system will still detect and recognize of a floppy drive(s).
The options are: Yes (Default), No.

Video BIOS Shadow

Allows the BIOS to copy the video ROM code of the add-on video card to the system memory for faster access.
The options are: Enabled (Default), Disabled.

BIOS Guardian

It allows the system to prevent computer viruses. Users will need to disable it to update BIOS. The options are: Enabled (Default), Disabled.



NOTE: Please disable this BIOS feature about BIOS Guardian before you start to reflash BIOS.

Advanced Chipset Features

CMOS Setup Utility - Copyright (c) 1984-2000 Award Software

Advanced Chipset Features

Bank 0/1 DRAM Timing	SDRAM 8/10ns	↑ Item Help Menu Level ▶ ↓
Bank 2/3 DRAM Timing	SDRAM 8/10ns	
Bank 4/5 DRAM Timing	SDRAM 8/10ns	
SDRAM Cycle Length	3	
DRAM Clock	Host CLK	
Memory Hole	Disabled	
PCI Master Pipeline Req	Enabled	
P2C/C2P Concurrency	Enabled	
Fast R-W Turn Around	Disabled	
System BIOS Cacheable	Enabled	
Video BIOS Cacheable	Enabled	
Video RAM Cacheable	Disabled	
AGP Aperture Size	64M	
AGP-4X Mode	Enabled	
AGP Driving Control	Auto	
x AGP Driving Value	DA	
AGP Fast Write	Enable	
K7 CLK_CTL Select	Optimal	
OnChip USB	Enabled	

↑↓→ Move Enter : Select +/-/PU/PD:Value F10 : Save ESC : Exit F1 : General Help
 F5 : Previous Values F6 : Fail-Safe Defaults F7 : Optimized Defaults

Chapter 3
BIOS Setup

CMOS Setup Utility - Copyright (c) 1984-2000 Award Software

Advanced Chipset Features

Video BIOS Cacheable	Enabled	↑ Item Help Menu Level ▶ ↓
Video RAM Cacheable	Disabled	
AGP Aperture Size	64M	
AGP-4X Mode	Enabled	
AGP Driving Control	Auto	
x AGP Driving Value	DA	
K7 CLK_CTL Select	Optimal	
OnChip USB	Enabled	
OnChip USB2	Enabled	
USB Keyboard Support	Enabled	
OnChip Sound	Enable	
CPU to PCI Write Buffer	Enabled	
PCI Dynamic Bursting	Enabled	
PCI Master 0 WS Write	Enabled	
PCI Delay Transaction	Disabled	
PCI#2 Access #1 Retry	Enabled	
AGP Master 1 WS Write	Disabled	
AGP Master 1 WS Read	Disabled	

↑↓→ Move Enter : Select +/-/PU/PD:Value F10 : Save ESC : Exit F1 : General Help
 F5 : Previous Values F6 : Fail-Safe Defaults F7 : Optimized Defaults

Bank 0/1/2/3/4/5 DRAM Timing

This feature allows you to select the DRAM read/write speed.

The options are: SDRAM 8/10ns (Default), Normal, Medium, Fast, Turbo.

SDRAM Cycle Length

This item will function only when SDRAM DIMM/s are installed on the mainboard (BIOS auto detection). If the CAS latency of your SDRAM DIMM is 2, set it at 2 to enhance your system performance. If the CAS latency of your SDRAM DIMM is 3, stay with the default setting, 3.

The options are: Auto, 3 (Default), 2.

DRAM Clock

The feature allows users to select the DRAM clock.

The options are: Auto, HCLK-33M, HCLK+33M, Host Clock (Default).

Memory Hole

When you install a Legacy ISA card, this feature allows you to select the memory hole's address range of the ISA cycle when the processor accesses the selected address area. Please read your card manual for detail information. When disabled, the memory hole at the 14MB (or 15MB) address will be treated as a DRAM cycle when the processor accesses the 14~16MB (or 15~16MB) address area.

The options are: 15M - 16M, Disabled (Default).

PCI Master Pipeline Req

This feature allows users to disable PCI master device pipeline controller request when necessary. The options are: Enabled (Default), Disabled.

P2C/C2P Concurrency

This feature allows users to set PCI/AGP Master-to-CPU/ CPU-to-PCI/ AGP Slave concurrent. The options are: Enabled (Default), Disabled.

Fast R-W Turn Around

It allows users to set DRAM fast read-to-write turn around.

The options are: Enabled, Disabled (Default).

System BIOS Cacheable

When enabled, allows the ROM area F000H-FFFFH to be cacheable when cache controller is activated. The options are: Enabled (Default), Disabled.

Video BIOS Cacheable

As with caching the system BIOS above, enabling the video BIOS cache will cause access to the video BIOS addressed at C0000H-C7FFFH to be cached, if the cache controller is also enabled.

The options are Enabled (default), Disabled.

Video RAM Cacheable

When enabled, allows the video RAM area (A000H-B000H) to be cacheable.

The options are: Enabled, Disabled (Default).

AGP Aperture Size

It allows you to select the main memory frame size for AGP use.

The options are 4M, 8M, 16M, 32M, 64M (Default), 128M.

AGP-4X Mode

This feature allows user to select the AGP mode be to 2x or 4x when an AGP add-in card installed. However, when set at Enabled and the AGP card only support 1x mode, the system will fall back 1x mode automatically.

The options are: Enabled (Default), Disabled.

AGP Driving Control / AGP Driving Value

These two features allow user to improve the performance of AGP card manually by pressing Page Down/Page UP key if necessary.

The options of AGP Driving Control are: Auto (Default), Manual.

K7 CLK_CTL Select

This item allows users to set K7 CPU clock ramp rate according to the system clock multiplier (CLKMUL) and the system bus speed.

The options are: Default, Optimal (Default).

OnChip USB/USB 2

When enabled, this feature allows you to use the onboard USB/USB2 feature. The options are: Enabled (Default), Disabled.

USB Keyboard Support

This feature will appear only if the above item Onchip USB is set at Enabled. Set this feature to Enabled to use a USB keyboard with your system.

The options are: Disabled (Default), Enabled.

OnChip Sound

When disabled, this feature allows you to disable the onboard audio feature. The options are: Enable (Default), Disable.

CPU to PCI Write Buffer

When enabled, allows data and address access to the internal buffer of the system controller; so the processor can be released from the waiting state. The options are: Enabled (Default), Disabled.

PCI Dynamic Bursting

When enabled, the PCI controller allows Bursting PCI transfer if the consecutive PCI cycles come with the address falling in same 1KB space. This improves the PCI bus throughput.

The options are: Enabled (Default), Disabled.

PCI Master 0 WS Write

When enabled, allows a zero-wait-state-cycle delay when the PCI master drive writes data to DRAM. The options are: Enabled (Default), Disabled.

PCI Delay Transaction

Enable this feature to abort the current CPI master cycle and to accept the new PCI master request, it reaccepts the original PCI master and returns the PCI data phase to the original PCI master.

The options are: Disabled (Default), Enabled.

PCI#2 Access #1 Retry

When enabled, the AGP (PCI#2) access to PCI (PCI#1) will be retried until the maximum count. The options are: Disabled; Enabled (Default).

AGP Master 1 WS Write

When enabled, the AGP bus master write access to DRAMs will add one wait-state cycle. The options are: Enabled; Disabled (Default).

AGP Master 1 WS Read

When enabled, the AGP bus master read access to the DRAMs will add one wait-state cycle. The options are: Disabled (Default); Enabled.

Integrated Peripherals

CMOS Setup Utility - Copyright (c) 1984-2000 Award Software

Integrated Peripherals

OnChip IDE Channel 0	Enabled	↑ Item Help Menu Level ▶ ↓
OnChip IDE Channel 1	Enabled	
IDE Prefetch Mode	Enabled	
Primary Master PIO	Auto	
Primary Slave PIO	Auto	
Secondary Master PIO	Auto	
Secondary Slave PIO	Auto	
Primary Master UDMA	Auto	
Primary Slave UDMA	Auto	
Secondary Master UDMA	Auto	
Secondary Slave UDMA	Auto	
Init Display First	PCI Slot	
IDE HDD Block Mode	Enabled	
Onboard FDD Controller	Enabled	
Onboard Serial Port 1	3F8/IRQ4	
Onboard Parallel Port	378/IRQ7	
Onboard Parallel Mode	Normal	
ECP Mode Use DMA	3	
Parallel Port EPP Type	EPP1.7	

↑↓ → Move Enter : Select +/-/PU/PD:Value F10 : Save ESC : Exit F1 : General Help
 F5 : Previous Values F6 : Fail-Safe Defaults F7 : Optimized Defaults

Chapter 3
BIOS Setup

CMOS Setup Utility - Copyright (c) 1984-2000 Award Software

Integrated Peripherals

Secondary Master PIO	Auto	↑ Item Help Menu Level ▶ ↓
Secondary Slave PIO	Auto	
Primary Master UDMA	Auto	
Primary Slave UDMA	Auto	
Secondary Master UDMA	Auto	
Secondary Slave UDMA	Auto	
Init Display First	PCI Slot	
IDE HDD Block Mode	Enabled	
Onboard FDD Controller	Enabled	
Onboard Serial Port 1	3F8/IRQ4	
Onboard Parallel Port	378/IRQ7	
Onboard Parallel Mode	Normal	
ECP Mode Use DMA	3	
Parallel Port EPP Type	EPP1.7	
Onboard Legacy Audio	Enabled	
Sound Blaster	Disabled	
SB I/O Base Address	220H	
SB IRQ Select	IRQ 5	
SB DMA Select	DMA 1	

↑↓ → Move Enter : Select +/-/PU/PD:Value F10 : Save ESC : Exit F1 : General Help
 F5 : Previous Values F6 : Fail-Safe Defaults F7 : Optimized Defaults

OnChip IDE Channel0

When enabled, allows you to use the onboard primary PCI IDE. If a hard disk controller card is used, set at Disabled.

The options are: Enabled (Default), Disabled.

OnChip IDE Channel1

When enabled, allows you to use the onboard secondary PCI IDE. If a hard disk controller card is used, set at Disabled.

The options are: Enabled (Default), Disabled.

IDE Prefetch Mode

When set at Enabled, it allows data to be posted to and prefetched from the primary IDE data ports. Data prefetching is initiated when a data port read occurs. The read prefetch eliminates latency to the IDE data ports and allows them to be performed back to back for the highest possible PIO data transfer rates. The first data port read of a sector is called the demand read. Subsequent data port reads from the sector are called prefetch reads. The demand read and all prefetch reads must be of the same size (16 or 32 bits).

The options are: Enabled (Default), Disabled.

Primary Master PIO

Allows an automatic or a manual configuration of the PCI primary IDE hard disk (master) mode. The options are: Auto (Default), Mode 0, Mode 1, Mode 2, Mode 3, Mode 4.

Primary Slave PIO

Allows an automatic or a manual configuration of the PCI primary IDE hard disk (slave) mode. The options are: Auto (Default), Mode 0, Mode 1, Mode 2, Mode 3, Mode 4.

Secondary Master PIO

Allows an automatic or a manual configuration of the PCI secondary IDE hard disk (master) mode. The options are: Auto (Default), Mode 0, Mode 1, Mode 2, Mode 3, Mode 4.

Secondary Slave PIO

Allows an automatic or a manual configuration of the PCI secondary IDE hard disk (slave) mode. The options are: Auto (Default), Mode 0, Mode 1, Mode 2, Mode 3, Mode 4.

Primary Master UDMA

Allows you to select the first PCI IDE channel of the first master hard disk mode or to detect it by the BIOS if the hard disk supports UDMA (Ultra DMA, faster than DMA). The options are: Auto (Default), Disable.

IDE Primary Slave UDMA

Allows you to select the first PCI IDE channel of the first slave hard disk mode or to detect it by the BIOS if the hard disk supports UDMA (Ultra DMA, faster than DMA). The options are: Auto (Default), Disable.

IDE Secondary Master UDMA

Allows you to select the second PCI IDE channel of the secondary master hard disk mode or to detect it by the BIOS if the hard disk supports UDMA (Ultra DMA, faster than DMA). The options are: Auto (Default), Disable.

IDE Secondary Slave UDMA

Allows you to select the second PCI IDE channel of the secondary slave hard disk mode or to detect it by the BIOS if the hard disk supports UDMA (Ultra DMA, faster than DMA). The options are: Auto (Default), Disable.

Init Display First

When you install an AGP VGA card and a PCI VGA card on the board, this feature allows you to select the first initiation of the monitor display from which card. The options are: PCI Slot (Default), AGP.

IDE HDD Block Mode

When enabled, the system executes read/write requests to hard disk in block mode. The options are: Enabled (Default), Disabled.

Onboard FDD Controller

When enabled, the floppy diskette drive (FDD) controller is activated. The options are: Enabled (Default), Disabled.

Onboard Serial Port 1

If the serial port 1 uses the onboard I/O controller, you can modify your serial port parameters. If an I/O card needs to be installed, COM3 and COM4 may be needed. The options are: 3F8/IRQ4 (Default), 2F8/IRQ3, 3E8/IRQ4, 2E8/IRQ3, Disabled.

Onboard Parallel Port

Allows you to select from a given set of parameters if the parallel port uses the onboard I/O controller.

The options are: 378/IRQ7 (Default), 278/IRQ5, 3BC/IRQ7, Disabled.

Onboard Parallel Port Mode

Allows you to connect with an advanced printer.

The options are: Normal (Default), EPP, ECP, ECP/ ECP.

ECP Mode Use DMA

This feature allows you to select Direct Memory Access (DMA) channel if the ECP mode selected. The options are: 3 (Default), 1.

Parallel Port EPP Type

This feature allows you to select the EPP type for the parallel port.

The options are: EPP1.9, EPP1.7 (Default).

Onboard Legacy Audio

Allow use the audio function under DOS mode.

The options are: Enabled (Default), Disabled.

Sound Blaster

This feature allows you to select the Sound Blaster, if the onboard Legacy audio chosen. The options are: Enabled, Disabled (Default).

SB I/O Base Address

This feature allows you to select the SB I/O base address, if the onboard Legacy audio chosen. The options are: 220H (Default), 240H, 260H, 280H.

SB IRQ Select

This feature allows you to select the SB IRQ, if the onboard Legacy audio chosen. The options are: IRQ 5 (Default), IRQ 7, IRQ 9, IRQ 10.

SB DMA Select

This feature allows you to select the SB DMA channel, if the onboard Legacy audio chosen.

The options are: DMA 1 (Default), DMA 2, DMA 3, DMA0.

Power Management Setup

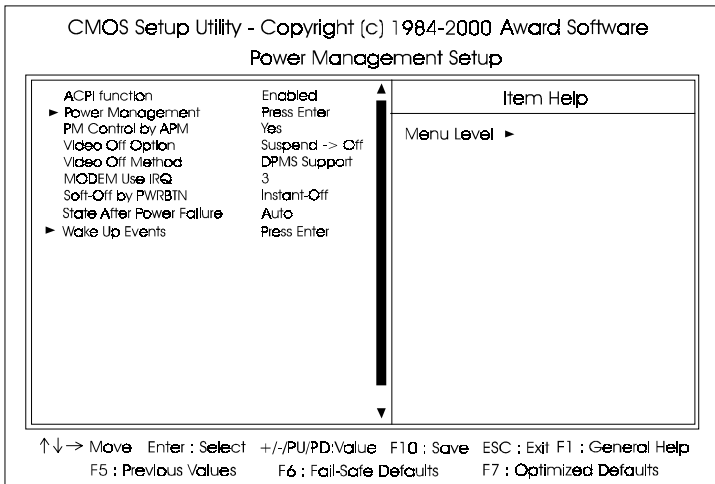

ACPI function

This item allows you to disable the ACPI function.
The options are: Enabled (Default), Disabled.

Power Management

This item allows you to adjust the power management features.

Select User Define for configuring your own power management features. Min Saving initiates all predefined timers in their minimum values. Max Saving, on the other hand, initiates maximum values. The options are: User Define (Default), Min Saving, Max Saving.

HDD Power Down

The option lets the BIOS turn the HDD motor off when system is in Suspend mode. Selecting 1 Min..15 Min allows you define the HDD idle time before the HDD enters the Power Saving Mode.

The options 1 Min..15 Min will not work concurrently. When HDD is in the Power Saving Mode, any access to the HDD will wake the HDD up.

The options are: Disable (Default), 1 Min..15 Min.

Doze Mode

When disabled, the system will not enter Doze mode. The specified time option defines the idle time the system takes before it enters Doze mode.

The options are: Disable (Default), 10, 20, 30, 40 Sec, 1, 2, 4, 6, 8, 10, 20, 30, 40 Min, 1 Hour.

Suspend Mode

When disabled, the system will not enter Suspend mode. The specified time option defines the idle time the system takes before it enters Suspend mode. The options are: Disable (Default), 10, 20, 30, 40 Sec, 1, 2, 4, 6, 8, 10, 20, 30, 40 Min, 1 Hour.

PM Control by APM

The option No allows the APM (Advanced Power Management) specification be ignored. Selecting Yes will allow the BIOS wait for APM's prompt before it enters Doze mode, Standby mode, or Suspend mode. If the APM is installed, it will prompt the BIOS to set the system into power saving mode when all tasks are done. The options are: No, Yes (Default).

Video Off Option

This feature provides the selections of the video display power saving mode. The option Suspend - Off allows the video display to go blank if the system enters Suspend mode. The option All Modes - Off allows the video display to go blank if the system enters Doze mode or Suspend mode. The option Always On allows the video display to stay in Standby mode even when the system enters Doze or Suspend mode.

The options are: Suspend - Off (Default), All Modes -> Off, Always On.

Video Off Method

The option *V/H SYNC+Blank* allows the BIOS to blank off screen display by turning off the V-Sync and H-Sync signals sent from add-on VGA card. *DPMS Support* allows the BIOS to blank off screen display by your add-on VGA card which supports DPMS (Display Power Management Signaling function). *Blank Screen* allows the BIOS to blank off screen display by turning off the red-green-blue signals.

The options are: V/H SYNC+Blank, DPMS Support (Default), Blank Screen.

MODEM Use IRQ

This feature allows you to select the IRQ# to meet your modem's IRQ#.

The options are: 3 (Default), 4, 5, 7, 9, 10, 11.

Soft-Off by PWR-BTTN

The selection Delay 4 Sec. will allow the system shut down after 4 seconds after the power button is pressed. The selection Instant-Off will allow the system shut down immediately once the power button is pressed.

The settings are: Delay 4 Sec, Instant-Off (Default).

State After Power Failure

The item allows you to select the state that your personal computer returns to after a power failure. If set at Off, the system will not boot after a power failure. If set On, the system will restart after power failure.

The settings are: Auto (Default), On, Off.

VGA

ON enables the power management timers when a no activity events is detected in the VGA. *OFF* disables the PM timer even if a no activity event is detected. The options are: OFF (Default), ON.

LPT & COM

LPT/COM enables the power management timers when a no activity event is detected in the LPT and COM ports. *LPT (COM)* enables the power management timers when a no activity event is detected in the LPT (COM) ports. *NONE* to disable the PM timer even if a no activity event is detected. The options are: LPT/COM (Default), LPT, COM, NONE.

HDD & FDD

ON will enable the power management timers when no activity event is detected in the hard drive and floppy drive. *OFF* disables the PM timer even if no activity event is detected. The options are: OFF, ON (Default).

PCI Master

To set this feature at ON activates that Power Management feautre (PM) wake-up event for the DMA or bus master (of the LAN card or/and SCSI card). The options are: OFF (Default), ON.

PowerOn by PCI Card

When set at Enabled, any PCI-PM event awakes the system from a PCI-PM controlled state.

The options are Disabled (Default) or Enabled.

RTC Alarm Resume

Enabled allows you to set the time the system will be turned on from the system power-off status. The options are: Enabled, Disabled (Default).

Date (of Month)

This feature allows you to set the day of the alarm starts when the RTC Alarm Resume From Soft Off is set to be Enabled. The options are: 0, 1..31.

Resume Time (hh:mm:ss)

If an ATX power supply is installed and when RTC Alarm Resume is Enabled, this feature allows you to set the time of the alarm starts when the RTC Alarm Resume From Soft Off is set to be Enabled.

The options are: 7: 0: 0 (Default). hh (*hour*) - 0, 1, 2,..., 23; mm (*minute*) - 0, 1, 2,...,59; ss (*second*) - 0, 1, 2,...,59.

Primary INTR

When the Primary interrupt (the Primary option in the feature of IRQ# Activity) generates will make the Power Management feature (PM) wake-up event on. If set at OFF, all the primary interrupt will not wake-up the system. The options are: OFF, ON (Default).

IRQs Activity Monitoring

After the time period which you set, the system advances from doze mode to suspend mode in which the CPU clock stops and the screen display is off. At this moment, if the IRQ activity occurs, the system goes back to full-on mode directly.

If the IRQ activity which is defined as Non Primary takes place, the system remains off until the corresponding IRQ handler finishes.

The options of IRQ 3, 4, 5, 6, 7, 8, 9, 10, 11, 12, 13, 14, 15 are: Enabled, Disabled.

The default is Disabled for the IRQ8, 9, 10, 11, 15.

The default of rest are Enabled.

PnP/PCI Configurations

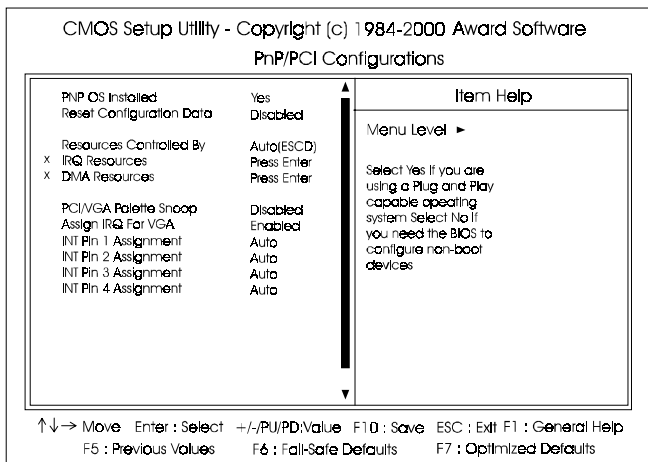

PNP OS Installed

If your operating system is a Plug-and-Play one, such as Windows NT, Windows 95, select Yes. The options are: No, Yes (Default).

Reset Configuration Data

Enabling it to reset the system Extended System Configuration Data (ESCD) when you exit Setup if you have installed a new add-on card and the system reconfiguration has caused such a serious conflict that the operating system can not boot. The options are: Disabled (Default), Enabled.

Resources Controlled By

If set at Auto, the BIOS arranges all system resources. If there exists conflict, select Manual. The options are: Auto (ESCD) (Default), Manual.

The manual options of **IRQ-** /**DMA-** assigned to are: PCI/ISA PnP, Legacy ISA.

PCI/VGA Palette Snoop

Set this feature to be enabled if any ISA adapter card installed in the system requires the VGA palette snoop function.

The options are: Disabled (Default), Enabled.

Assign IRQ For VGA

If your PCI VGA card devices do not need an IRQ, select Disabled; therefore, an IRQ can be released for the system use.

The options are: Enabled (Default), Disabled.

INT Pin 1/2/3/4 Assignment

This feature allows you to assign the PCI IRQ numbers for PCI slots. Selecting the default, Auto, allows the PCI controller to automatically allocate the IRQ numbers.

The options are: Auto (Default), 3, 4, 5, 7, 9, 10, 11, 12, 14, 15.

PC Health Status

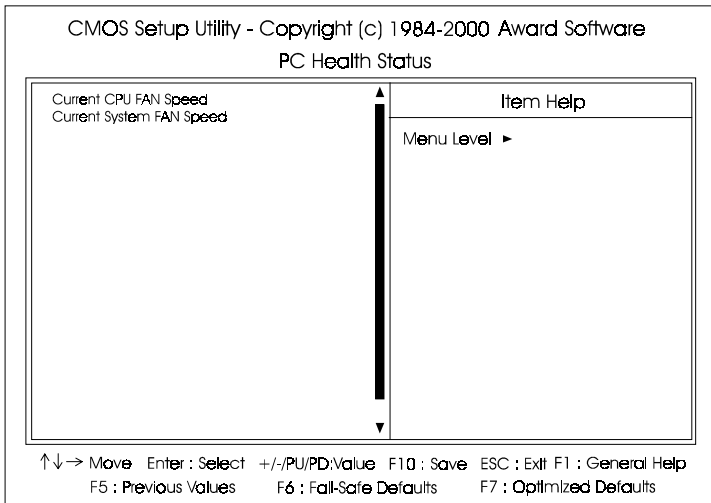

It allows you and technicians to monitor data provided by the BIOS on this mainboard. Some of them are not user-configurable.

Current CPU FAN Speed / Current System FAN Speed

These items allow end users and technicians to monitor data provided by the BIOS on this mainboard. It is not user-configurable.

Frequency/Voltage Control

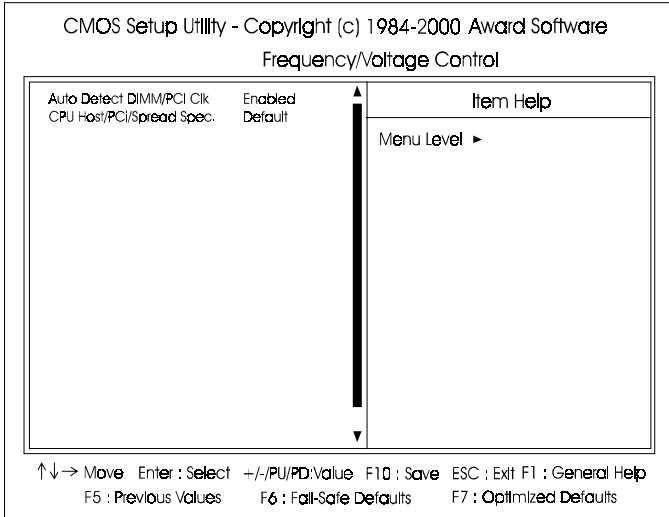

Auto Detect DIMM/PCI Clk

When enabled, BIOS will detect the PCI slot and DIMM slot if no any device in, BIOS will auto disable its clock.

The options are: Enabled (Default), Disabled.

CPU Host/PCI/Spread Spec.

This feature allows you to select the combinations of CPU/PCI clock frequency and the Spread Spectrum. The default setting, Default, will detect your CPU/PCI clock frequency/ Spread Spectrum automatically. The recommended CPU clock frequencies are 100 and 133MHz. The other options may effect the system performance. If you set a unappropriate option which leads to a booting problem, keep pressing the Insert key until the display appears will solve it. The options listed all combinations that provided by the system BIOS.

Load Fail-Safe Defaults

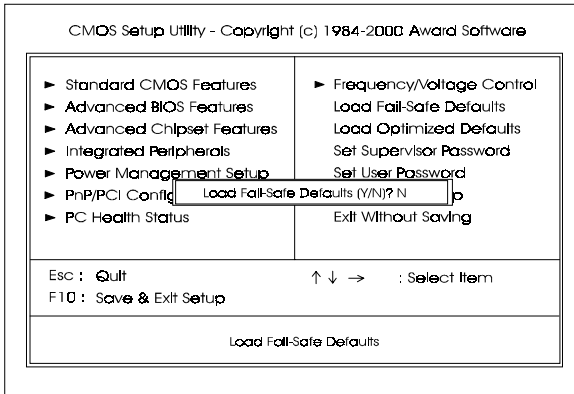

This submenu is selected to diagnose the problem after the computer boots, if the computer will not boot. These settings do not give optimal performance.

Load Optimized Defaults

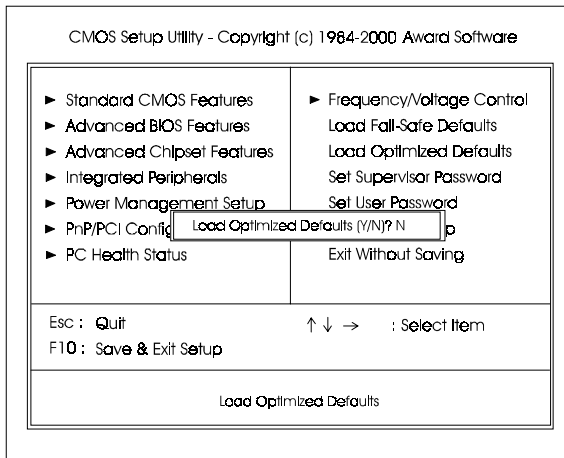

This submenu is selected for settings which provide the best system performance.

Save and Exit Setup

After you have made changes under Setup, press Esc to return to the main menu. Move cursor to Save and Exit Setup or press F10 and then press Y to change the CMOS Setup. If you did not change anything, press Esc again or move cursor to Exit Without Saving and press Y to retain the Setup settings. The following message will appear at the center of the screen to allow you to save data to CMOS and exit the setup utility: **SAVE to CMOS and EXIT (Y/N)?**

Exit without Saving

If you select this feature, the following message will appear at the center of the screen to allow you to exit the setup utility without saving CMOS modifications: **Quit Without Saving (Y/N)?**

This Page Left Blank for Note