

AX6BC Pro II

Millennium Edition

Online Manual

DOC. NO. : AX6BCP2M-OL-E9912A

Before You Start



This Online Manual is in [PDF format](#), we recommend using Adobe Acrobat Reader 4.0 for online viewing, it is included in [Bonus CD disc](#) or you can get free download from [Adobe web site](#).

Although this Online Manual is optimized for screen viewing, it is still capable for hardcopy printing, you can print it by A4 paper size and set 2 pages per A4 sheet on your printer. To do so, choose **File > Page Setup** and follow the instruction of your printer driver.

Thanks for the help of saving our earth.

Quick Installation Procedure

This page gives you a quick procedure on how to install your system. Follow each step accordingly.

- [1 Installing CPU and Fan](#)
- [2 Installing System Memory \(DIMM\)](#)
- [3 Connecting Front Panel Cable](#)
- [4 Connecting IDE and Floppy Cable](#)
- [5 Connecting ATX Power Cable](#)
- [6 Connecting Back Panel Cable](#)
- [7 Power-on and Load BIOS Setup Default](#)
- [8 Setting CPU Frequency](#)
- 9 Reboot
- 10 Installing Operating System (such as Windows 98)
- 11 [Installing Driver and Utility](#)

Motherboard Map

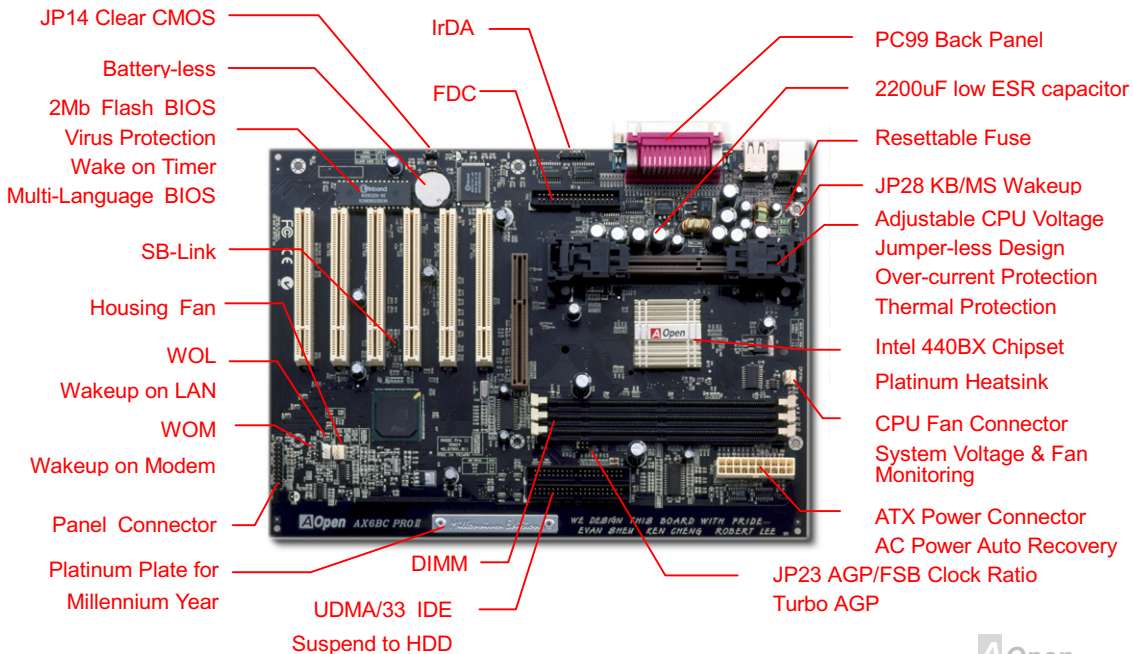

Block Diagram

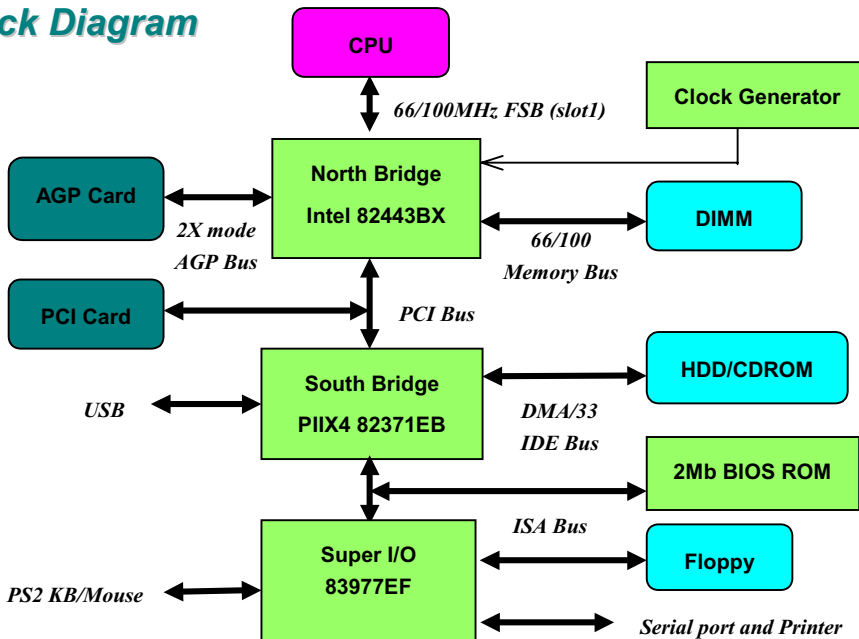

Hardware

This chapter describes jumpers, connectors and hardware devices of this motherboard.



Note: *Electrostatic discharge (ESD) can damage your processor, disk drives, expansion boards, and other components. Always observe the following precautions before you install a system component.*

- 1. Do not remove a component from its protective packaging until you are ready to install it.*
- 2. Wear a wrist ground strap and attach it to a metal part of the system unit before handling a component. If a wrist strap is not available, maintain contact with the system unit throughout any procedure requiring ESD protection.*

JP14 Clear CMOS



Normal Operation
(default)



Clear CMOS

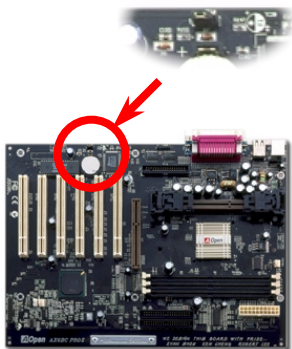

You can clear CMOS to restore system default setting. To clear the CMOS, follow the procedure below.

1. Turn off the system and unplug the AC power.
2. Remove ATX power cable from connector PWR2.
3. Locate JP14 and short pins 2-3 for a few seconds.
4. Return JP14 to its normal setting by shorting pins 1-2.
5. Connect ATX power cable back to connector PWR2.

Tip: *When should I Clear CMOS?*

1. *Boot fail because of overclocking...*
2. *Forget password...*
3. *Troubleshooting...*

JP28 Keyboard/Mouse Wakeup

This jumper is used to enable or disable Keyboard/Mouse Wake Up function. If you select Enable, you can decide the wake up mode from BIOS Setup, Integrated Peripherals > [Power On Function](#). To implement this function, the power supply 5V standby current must be greater than 800mA. Note that only PS/2 mouse supports Wake on Mouse function.

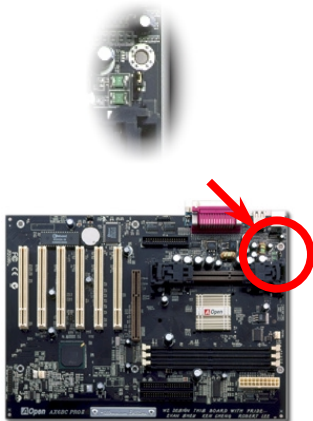

1

2

3

Disable



1

2

3

Enable

Tip: You have to wait for system to successfully boot from operation system (such as Windows or DOS) before the Wake-On-Keyboard/Mouse can take effect. This is because the information of how to support this function must be stored into Winbond W83977EF and then you can use it for next power on.

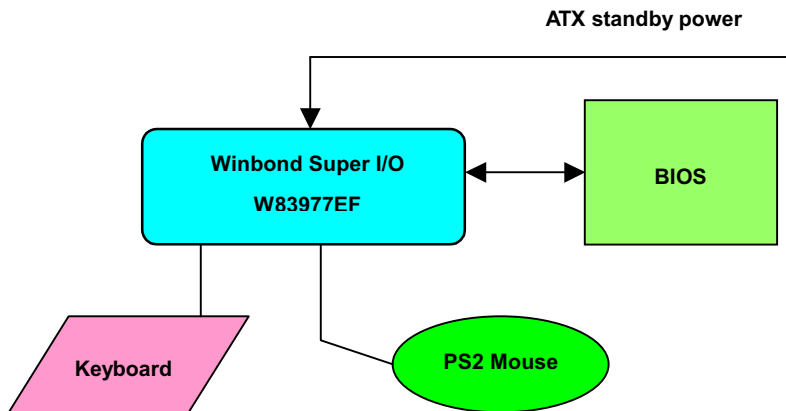

CPU Slot and Fan Connector



Plug CPU to slot1 connector. Be careful of CPU orientation. Plug in the fan cable to the 3-pin **CPUFAN** or **FAN** connector.

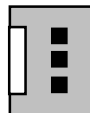
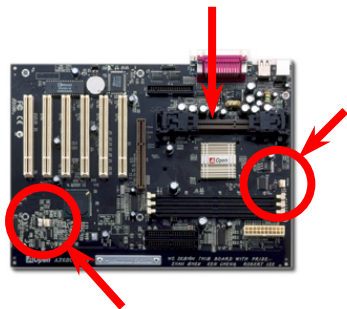

GND
+12V
SENSE

Note: Some CPU fans do not have sense pin, so that cannot support fan monitoring.

CPU Jumper-less Design

CPU VID signal and [SMBus](#) clock generator provide CPU voltage auto-detection and allows the user to set the CPU frequency through the [BIOS setup](#), therefore no jumpers or switches are used. The correct CPU information is saved into the [EEPROM](#). With these technologies, the disadvantages of the Pentium based jumper-less designs are eliminated. There will be no worry of wrong CPU voltage detection and no need to re-open the housing in case of CMOS battery loss.

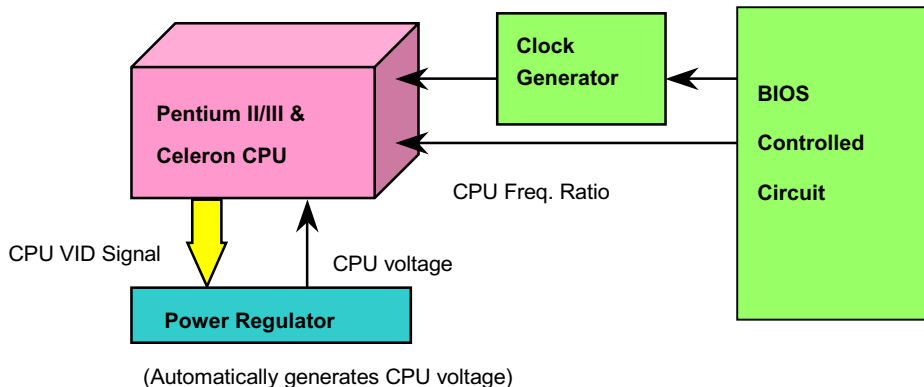

Setting CPU Core Voltage

This motherboard supports CPU VID function. The CPU core voltage will be automatically detected and the range is from 1.3V to 3.5V.. But this motherboard also supports Adjustable CPU Core Voltage for overclockers.

BIOS Setup > Chipset Features Setup > [CPU Voltage Setting](#)



Warning: High CPU core voltage may be able to increase CPU speed for overclocking, but you may damage the CPU or reduce the CPU lifecycle.

Setting CPU Frequency

This motherboard is CPU jumper-less design, you can set CPU frequency through the BIOS setup, no jumpers or switches are needed.

BIOS Setup > Chipset Features Setup > [CPU Clock Frequency](#)

BIOS Setup > Chipset Features Setup > [CPU Clock Ratio](#)

CPU Ratio	1.5x, 2x, 2.5x, 3x, 3.5x, 4x, 4.5x, 5x, 5.5x, 6x, 6.5x, 7x, 7.5x, and 8x
CPU FSB	66.8, 68.5, 75, 83.3, 100, 103, 112, 117, 124, 129, 133.3, 138, 143, 148 and 153 MHz.



Warning: INTEL 440BX chipset supports maximum 100MHz FSB and 66MHz AGP clock, higher clock setting may cause serious system damage.



Tip: If your system hangs or fails to boot because of overclocking, simply use <Home> key to restore the default setting (233MHz).



Home

Core Frequency = CPU FSB Clock * CPU Ratio

CPU	CPU Core Frequency	FSB Clock	Ratio
Celeron 300A	300MHz =	66MHz	4.5x
Celeron 366	366MHz=	66MHz	5.5x
Celeron 366	366MHz=	66MHz	5.5x
Celeron 400	400MHz=	66MHz	6x
Pentium II 233	233MHz =	66MHz	3.5x
Pentium II 333	333MHz =	66MHz	5x
Pentium II 350	350MHz=	100MHz	3.5x
Pentium II 400	400MHz =	100MHz	4x
Pentium III 450	450MHz=	100MHz	4.5x
Pentium III 500	500MHz =	100MHz	5x
Pentium III 550E	550MHz =	100MHz	5.5x
Pentium III 600E	600MHz =	100MHz	6x
Pentium III 650E	650MHz =	100MHz	6.5x
Pentium III 700E	700MHz =	100MHz	7x

JP23 AGP / FSB Clock Ratio (Turbo AGP)

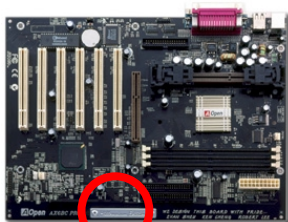

1 3 5

Auto (default)



1 3 5

2/3



1 3 5

1/1

It is recommended to set JP23 at Auto unless you are overclocking. There are two CPU types, 66MHz FSB and 100/133MHz FSB. If JP23 is set at Auto, the [AGP](#) clock ratio will be automatically determined by chipset. For 66M CPU, it is 1/1, for 100/133M CPU, it is 2/3. You can also manually decide AGP frequency if you are overclocking.

AGP Clock = CPU FSB Clock x Clock Ratio

Clock Ratio	CPU FSB Clock	AGP Clock
Auto with 66MHz CPU, 1/1	66MHz	66MHz
Auto with 100/133MHz CPU, 2/3	100MHz	66MHz
Auto with 100/133MHz CPU, 2/3, overclocking	133MHz	88.6MHz
2/3, overclocking	100MHz	66MHz
2/3, overclocking	133MHz	88.6MHz
2/3, overclocking	153MHz	102MHz
1/1, overclocking	100MHz	100MHz
1/1, overclocking	133MHz	133MHz
1/1, overclocking	153MHz	153MHz



Warning: INTEL 440BX chipset supports maximum 100MHz FSB and 66MHz AGP clock, higher clock setting may cause serious system damage.

DIMM Socket

This motherboard has three 168-pin [DIMM sockets](#) that allow you to install system memory up to **768MB**. Both [SDRAM](#) and Registered (Buffered) SDRAM are supported. But note that mixing SDRAM and Registered SDRAM is not allowed.

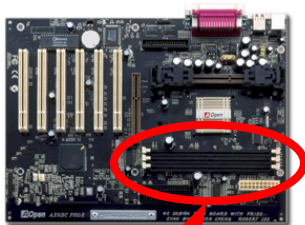

Pin 1

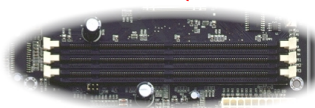

DIMM1
DIMM2
DIMM3

Tip: The driving capability of new generation chipset is limited due to the lack of a memory buffer (to improve performance). This makes DRAM chip count an important factor to take into consideration when you install DIMMs. Unfortunately, there is no way that the BIOS can identify the correct chip count, you need to calculate the chip count by yourself. The simple rule is: **By visual inspection, use only DIMMs which are less than 16 chips..**

DIMM can be single side or double side, it has 64 bit data and 2 or 4 clock signals. We strongly recommend choosing 4-clock SDRAM for its reliability



Tip: To identify 2-clock and 4-clock DIMM, you may check if there are traces connected to the golden finger pins 79 and 163 of the SDRAM. If there are traces, the SDRAM is probably 4-clock; Otherwise, it is 2-clock.



Tip: To identify single-side or double-side DIMM, check golden finger pin 114 and pin 129. If there are traces connected to pin 114 and pin 129, the DIMM is probably double-side; otherwise, it is single-side.

Front Panel Connector

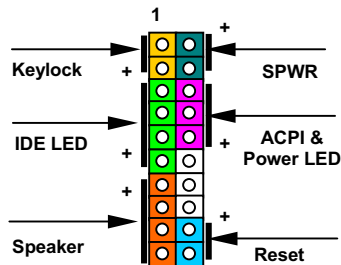
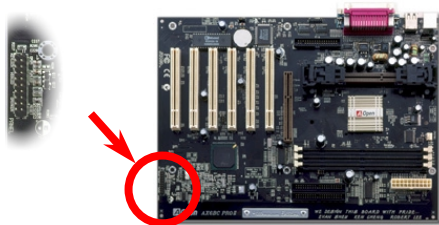

Attach the power LED, keylock, speaker, and reset switch connectors to the corresponding pins. If you enable "[Suspend Mode](#)" item in BIOS Setup, the ACPI & Power LED will keep flashing while the system is in suspend mode.

Locate the power switch cable from your ATX housing. It is 2-pin female connector from the housing front panel. Plug this connector to the soft-power switch connector marked **SPWR**.

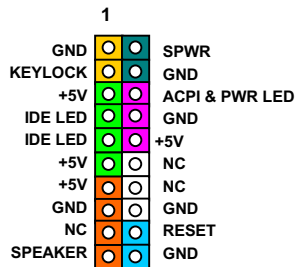

ATX Power Connector

The ATX power supply uses 20-pin connector shown below. Make sure you plug in the right direction.

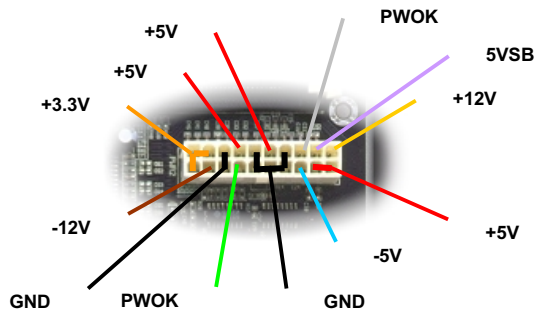
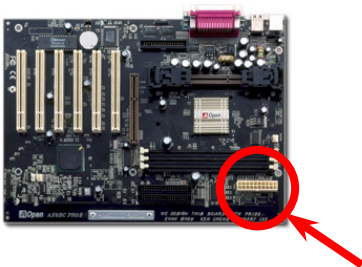

AC Power Auto Recovery

A traditional ATX system should remain at power off stage when AC power resumes from power failure. This design is inconvenient for a network server or workstation, without an UPS, that needs to keep power-on. This motherboard implements an AC Power Auto Recovery function to solve this problem. If BIOS Setup > Integrated Peripherals > [AC PWR Auto Recovery](#) is set to "Enabled" the system will automatically power-on after AC power resumes.

IDE and Floppy Connector

Connect 34-pin floppy cable and 40-pin IDE cable to floppy connector FDC and IDE connector **IDE1**, **IDE2**. Pin1 of cable is normally marked with red color. Be careful of the pin1 orientation. Wrong orientation may cause system damage.

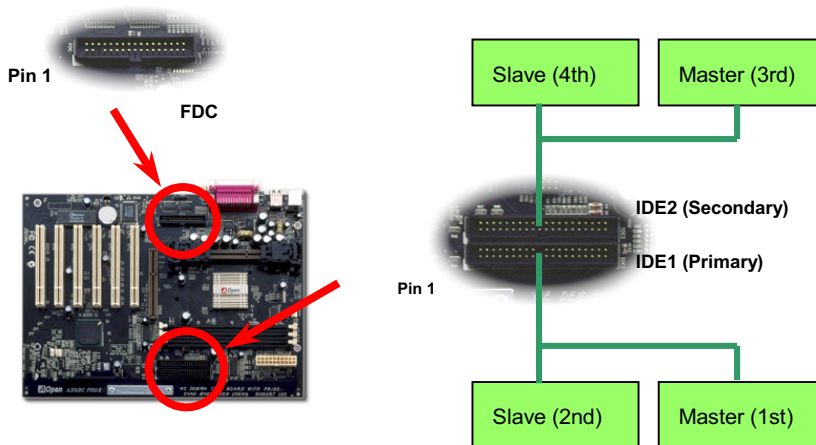

IDE1 is also known as the primary channel and IDE2 as the secondary channel. Each channel supports two IDE devices that make a total of four devices. In order to work together, the two devices on each channel must be set differently to **master** and **slave** mode. Either one can be the hard disk or the CDROM. The setting as master or slave mode depends on the jumper on your IDE device, so please refer to your hard disk and CDROM manual accordingly.



Warning: *The specification of the IDE cable is a maximum of 46cm (18 inches), make sure your cable does not exceed this length.*



Tip: *For better signal quality, it is recommended to set the far end side device to master mode and follow the suggested sequence to install your new device. Please refer to above diagram.*

This motherboard supports [Ultra DMA/33](#) mode. Following table lists the transfer rate of IDE PIO and DMA modes. The IDE bus is 16-bit, which means every transfer is two bytes.

Mode	Clock per 33MHz PCI	Clock Count	Cycle Time	Data Transfer Rate
PIO mode 0	30ns	20	600ns	$(1/600\text{ns}) \times 2\text{byte} = 3.3\text{MB/s}$
PIO mode 1	30ns	13	383ns	$(1/383\text{ns}) \times 2\text{byte} = 5.2\text{MB/s}$
PIO mode 2	30ns	8	240ns	$(1/240\text{ns}) \times 2\text{byte} = 8.3\text{MB/s}$
PIO mode 3	30ns	6	180ns	$(1/180\text{ns}) \times 2\text{byte} = 11.1\text{MB/s}$
PIO mode 4	30ns	4	120ns	$(1/120\text{ns}) \times 2\text{byte} = 16.6\text{MB/s}$
DMA mode 0	30ns	16	480ns	$(1/480\text{ns}) \times 2\text{byte} = 4.16\text{MB/s}$
DMA mode 1	30ns	5	150ns	$(1/150\text{ns}) \times 2\text{byte} = 13.3\text{MB/s}$
DMA mode 2	30ns	4	120ns	$(1/120\text{ns}) \times 2\text{byte} = 16.6\text{MB/s}$
UDMA/33	30ns	4	120ns	$(1/120\text{ns}) \times 2\text{byte} \times 2 = 33\text{MB/s}$

IrDA Connector

The IrDA connector can be configured to support wireless infrared module, with this module and application software such as Laplink or Windows 95 Direct Cable Connection, the user can transfer files to or from laptops, notebooks, PDA devices and printers. This connector supports HPSIR (115.2Kbps, 2 meters) and ASK-IR (56Kbps).

Install the infrared module onto the **IrDA** connector and enable the infrared function from BIOS Setup, [UART Mode Select](#), make sure to have the correct orientation when you plug in the IrDA connector.

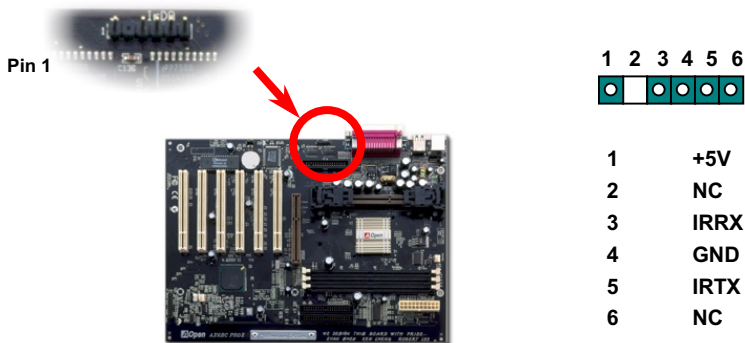

WOM (Zero Voltage Wake on Modem)

This motherboard implements special circuit to support Wake On Modem, both Internal modem card and external box modem are supported. Since Internal modem card consumes no power when system power is off, it is recommended to use an internal modem. To use internal modem, connect 4-pin cable from **RING** connector of modem card to the **WOM** connector on the motherboard.

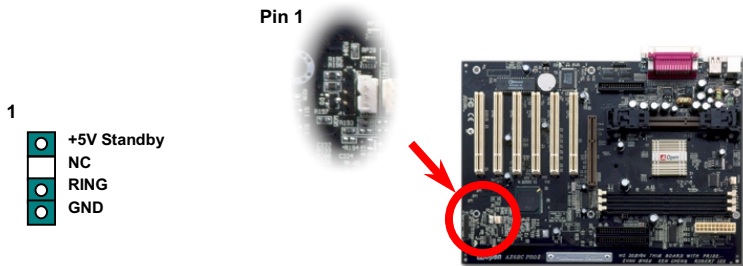

WOM by External BOX Modem

Traditional Green PC suspend mode does not really turn off the system power supply, it uses external box modem to trigger MB COM port and resume back to active.

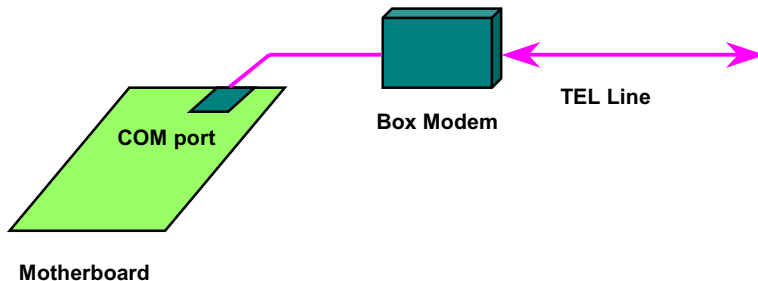

WOM by Internal Modem Card

With the help of the ATX soft power On/Off, it is possible to have a system totally power off, and wakeup to automatically answer a phone call as an answering machine or to send/receive a fax. You may identify whether or not your system is in true power off mode by checking to see if the fan of your power supply is off. Both an external box modem and an internal modem card can be used to support Modem Wake Up, but if you use an external modem, you have to leave your box modem on.

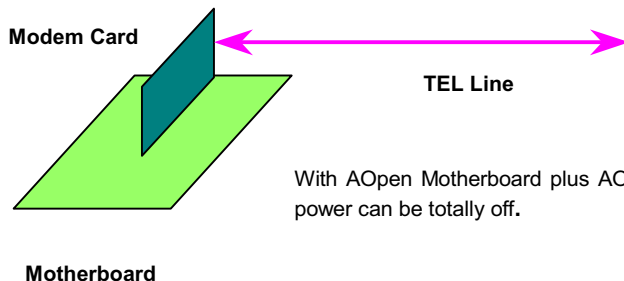

With AOpen Motherboard plus AOpen Modem Card, the power can be totally off.

WOL (Wake on LAN)

This feature is very similar as [Wake On Modem](#), but it goes through local area network. To use Wake On LAN function, you must have a network card with chipset that supports this feature, and connect a cable from LAN card to motherboard WOL connector. The system identification information (probably IP address) is stored on network card and because there is a lot of traffic on the Ethernet, you need to install a network management software, such as ADM, for the checking of how to wake up the system. Note that, at least 600mA ATX standby current is required to support the LAN card for this function.

Pin 1



+5V Standby
GND
LID

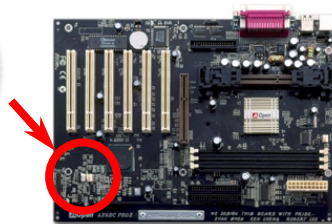
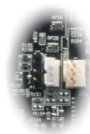

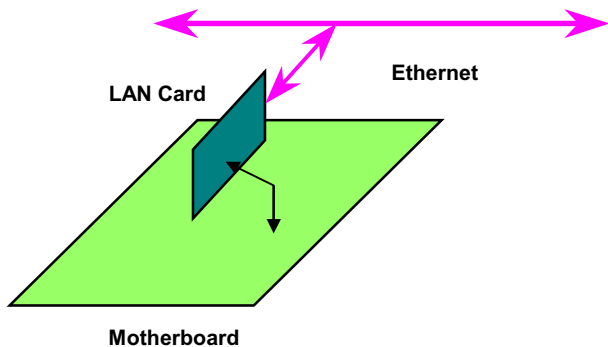

Sound Blaster SB-Link

SB-LINK is used to connect Creative PCI sound card. If you have a Creative PCI sound card installed, it is necessary to link the card to this connector for compatibility issue under DOS environment. Note that Windows environment does not need this connector.

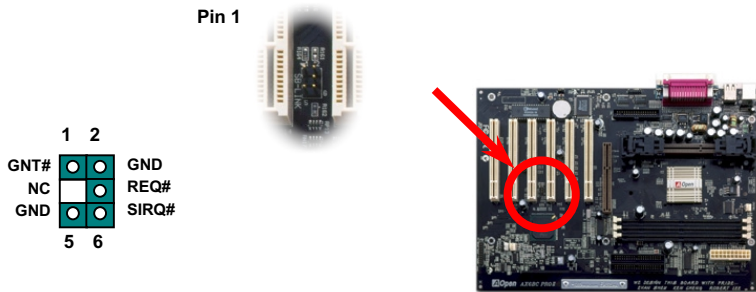

PCI Slot

Although there are 6 PCI slots, this motherboard supports only 5 PCI masters, you can only install PCI slave card on the 6th PCI slot (PCI 6). For example, a PCI VGA card.

6th PCI slot
(slave only)

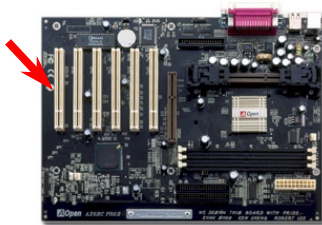

Note: The 3rd PCI slot (PCI3) shares an IRQ with the 6th PCI slot (PCI6) because of the hardware limitation; and just the same the 4th PCI slot (PCI4) shares an IRQ with the 5th PCI slot (PCI5).

PC99 Color Coded Back Panel

The onboard I/O devices are PS/2 Keyboard, PS/2 Mouse, serial ports COM1 and COM2, Printer and two [USB](#) ports. The view angle of drawing shown here is from the back panel of the housing.

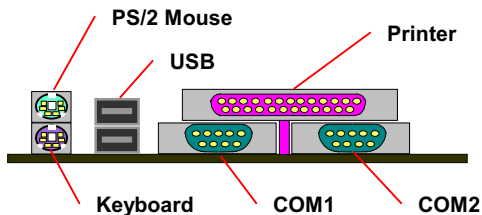

Battery-less and Long Life Design

This Motherboard implements [EEPROM](#) and a special circuit that allows you to save your current CPU and CMOS Setup configurations without the need of a battery. The RTC (real time clock) can also keep running as long as the power cord is plugged. If you lose your CMOS data by accident, you can just reload the CMOS configurations from EEPROM and the system will recover as usual.



Tip: For your convenience, this motherboard is still shipped with one Lithium (CR-2032) battery in the battery socket. If you prefer to use battery, you can keep it in the socket. The RTC will still keep running even power cord is removed.

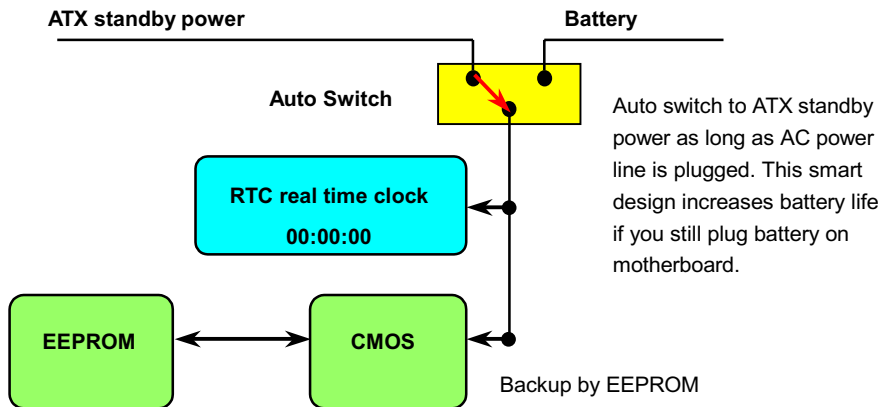

Over-current Protection

The Over Current Protection was very popular implemented on ATX 3.3V/5V/12V switching power supply. However, the new generation CPU uses different voltage that has regulator to transfer 5V to CPU voltage (for example, 2.0V), and makes 5V over current protection useless. This motherboard with switching regulator onboard support CPU over-current protection, in conjunction with 3.3V/5V/12V power supply provide the full line over-current protection.

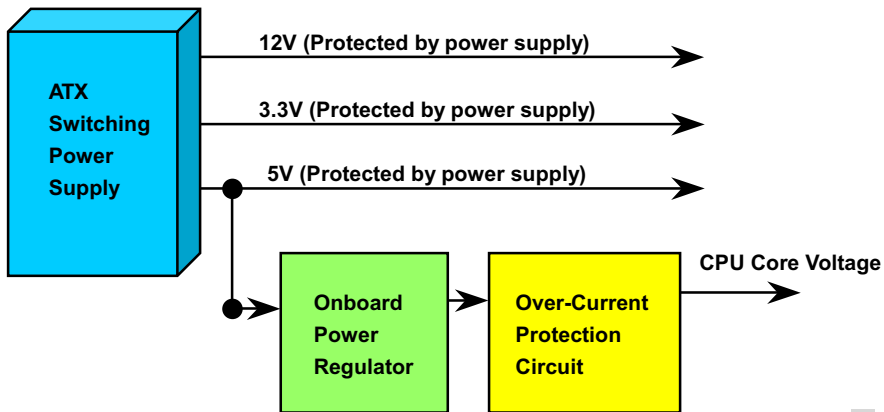



Note: *Although we have implemented protection circuit try to prevent any human operating mistake, there is still certain risk that CPU, memory, HDD, add-on cards that install on this motherboard may be damaged because of component failure, human operating error or unknown nature reason. **AOpen cannot guaranty the protection circuit will always work perfectly.***

Hardware Monitoring

This motherboard implements a hardware monitoring system. As you turn on your system, this smart design will continue to monitor your system's working voltage, fan status and CPU temperature. If any of these system's status go wrong, there will be an alarm through the AOpen [Hardware Monitoring Utility](#) to warn the user.

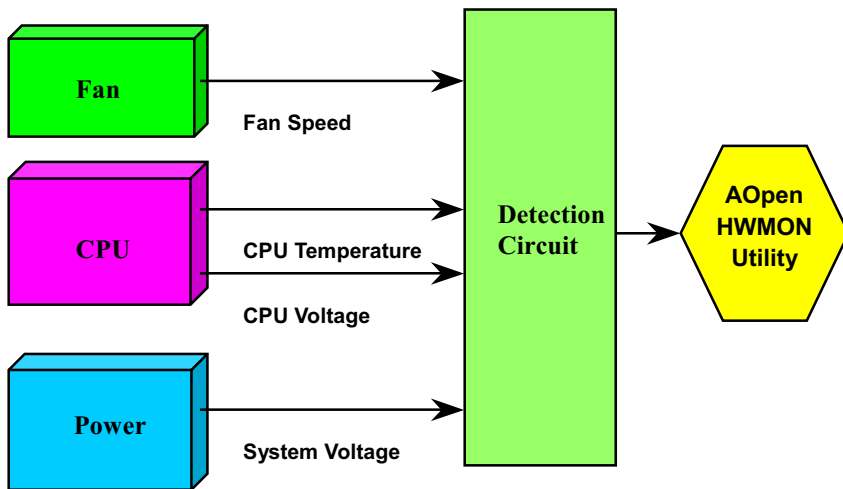

Resettable Fuse

Traditional motherboard has fuse for Keyboard and [USB](#) port to prevent over-current or shortage. These fuses are soldered onboard that when it is broken (did the job to protect motherboard), user still cannot replace it and the motherboard is still malfunction.

With expensive Resettable Fuse, the motherboard can back to normal function after fuse did the protection job.

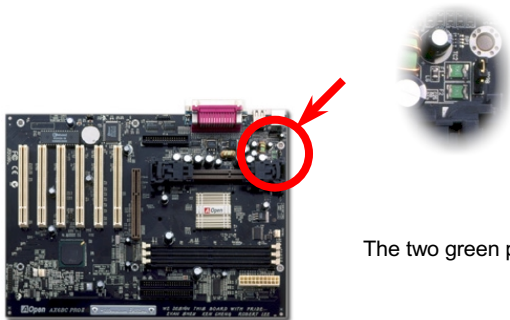

The two green parts at left side of JP28.

BIOS Write Protection

Recently, many viruses have been found that may destroy bios code and data area. This motherboard implements two layers firewall to protect from unauthorized writing to BIOS. One is hardware and the other is [software](#).

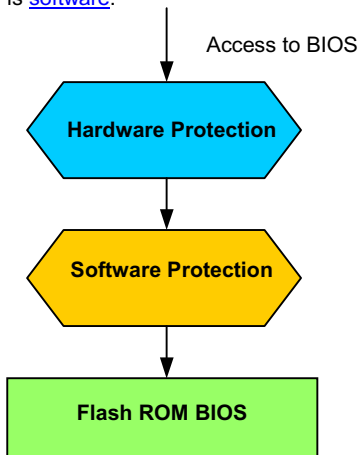

Year 2000 (Y2K)

Y2K is basically a problem of the identification of year code. To save storage space, traditional software uses only two digits for year identification. For example, 98 for 1998 and 99 for 1999, but 00 will be confused with 1900 and 2000.

There is an RTC circuit (Real Time Clock) in conjunction with 128 bytes of CMOS RAM data in the chipset of the motherboard. The RTC has only two digits and the CMOS has another 2 digits.

Unfortunately, this circuit's behavior is like this 1997 → 1998 → 1999 → 1900, that means it may have the Y2K problem. Below is a diagram of how applications work with the OS, BIOS and RTC. In order to keep the best compatibility in the PC industry there is a rule that applications must call the OS to get services and OS must call the BIOS, and then only BIOS is allowed to access the hardware (RTC) directly.

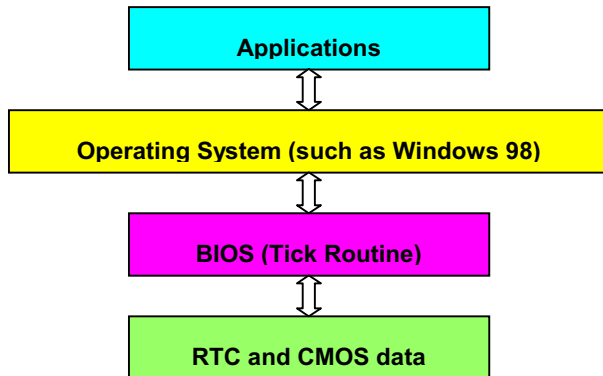

There is a Tick Routine (that goes live around every 50m sec) in the BIOS to keep record of date/time information. In general the BIOS, this Tick Routine does not update the CMOS every time because the CMOS is a very slow device which degrades system performance. The Tick Routine of the AOpen BIOS has 4 digits for year coding, as long as applications and the operating system follow the rule to get date/time information. There will be no Y2K problem (such as NSTL's test program). But unfortunately again, we found some test programs (such as Checkit 98) accesses RTC/CMOS directly. To ensure risk free operation, the AOpen BIOS team implemented a selection [option in the CMOS setup](#), that allows Tick Routine to update the CMOS. The coding of this routine has been well taken care of for minimum system performance loss.

2200uF Low ESR Capacitor

The quality of low ESR capacitor (Low Equivalent Series Resistor) during high frequency operation is very important for stability of CPU power. The location of where to put these capacitors is another knowhow that requires experience and detail calculation.

Not only that, this motherboard implements **2200uF capacitors**, which is much larger than normal (1000 or 1500uF) and provide better stability for CPU power.

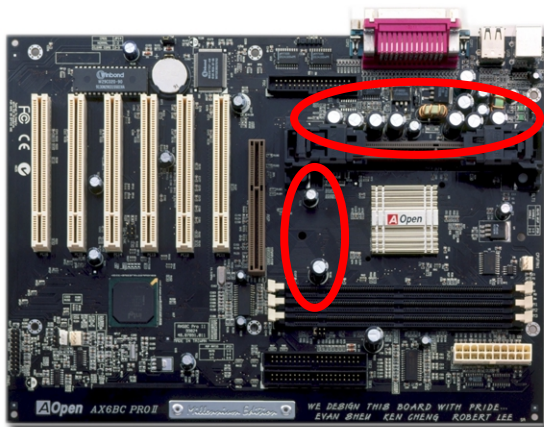

The power circuit of the CPU core voltage must be checked to ensure system stability for high speed CPUs (such as the new Pentium III, or when overclocking). A typical CPU core voltage is 2.0V, so a good design should control voltage between 1.860V and 2.140V. That is, the transient must be below 280mV. Below is a timing diagram captured by a Digital Storage Scope, it shows the voltage transient is only 143mv even when maximum 18A current is applied.

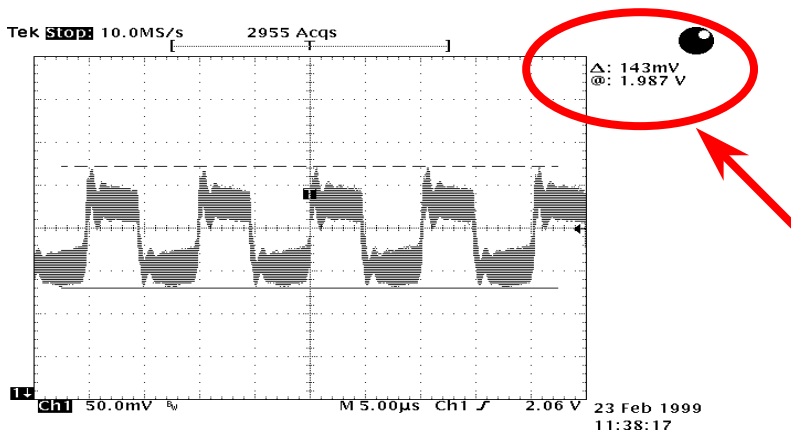

Layout (Frequency Isolation Wall)

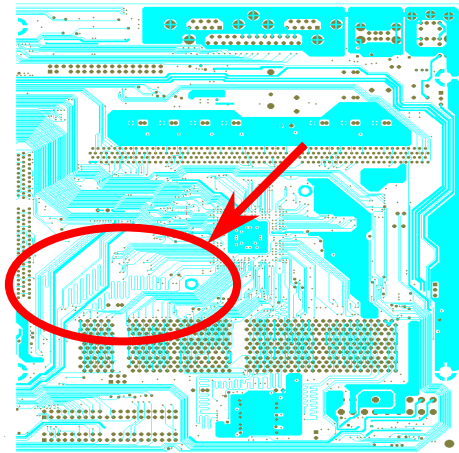

Note: This diagram is for example only, it may not be exactly the same as this motherboard.

For high frequency operation, especially overclocking, layout is the most important factor to make sure chipset and CPU working in stable condition. The layout of this motherboard implements AOpen's unique design called "Frequency Isolation Wall". Separating each critical portion of motherboard into regions where each region operates in a same or similar frequency range to avoid crosstalk and frequency interference between each region's operations and condition. The trace length and route must be calculated carefully. For example, the clock trace must be equal length (not necessarily as short as possible) so that clock skew will be controlled within few a pico second ($1/10^{12}$ Sec)

Platinum Heatsink

Cool down CPU and Chipset is important for system reliability. **Platinum Heatsink** provides better heat consumption especially when you are trying to overclock.

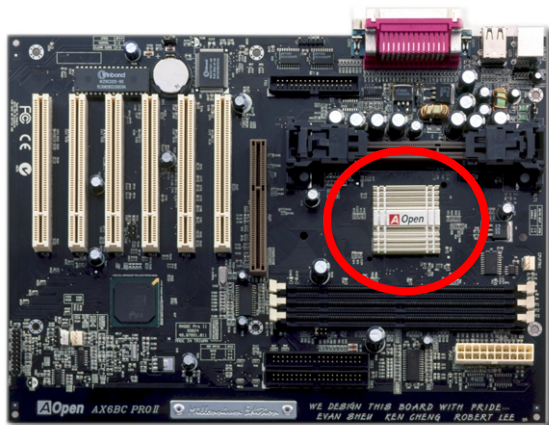

Platinum Plate

In celebrating the Millennium Year, a platinum plate is put on the motherboard.



Driver and Utility

There are motherboard drivers and utilities included in [AOpen Bonus CD disc](#). You don't need to install all of them in order to boot your system. But after you finish the hardware installation, you have to install your operation system first (such as Windows 98) before you can install any drivers or utilities. Please refer to your operation system's installation guide.



Tip: For Intel BX motherboard, no utility or driver is essential to boot this motherboard, you can run your system without installing any utility or driver described in this installation guide.

Autorun Menu from Bonus CD Disc

You can use the autorun menu of Bonus CD disc. Choose the utility and driver and select model name

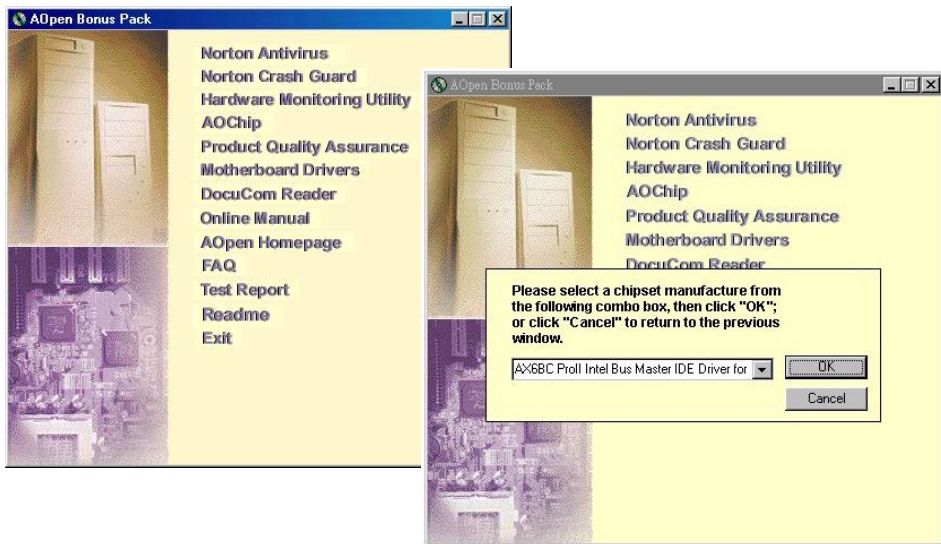

Eliminate “?” mark from Windows 95

Windows 95 cannot recognize this chipset, because it was released before Intel 440BX. You can run AOchip.exe from [AOpen Bonus Pack](#) to eliminate the “?” marks.



Installing Bus Master IDE Driver

There is no need to install [Bus Master IDE](#) driver to support [Ultra DMA/33](#) hard disk. If you need this driver, you can find it in the [AOpen Bonus Pack](#) CD disc.

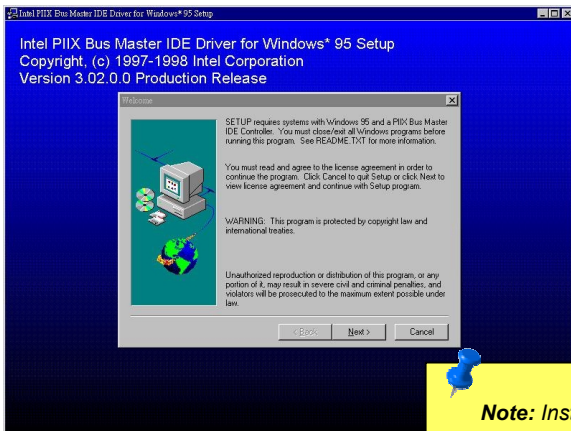

Note: Installing this Bus Master IDE driver may cause Suspend to Hard Drive failure.

Installing Hardware Monitoring Utility

You can install Hardware Monitoring Utility to monitor CPU temperature, fans and system voltage.

You can find it in the [AOpen Bonus Pack](#) CD disc.



APM Suspend to Hard Drive

APM Suspend to Hard Drive is a private design of AOpen motherboard **BIOS**. It saves your current work (system status, memory and screen image) into hard disk, and then the system can be totally power off. Next time, when power is on, you can resume your original work directly from hard disk within few seconds without go through the Windows booting process and run your application again. If your memory is 64MB, normally, you need to reserve at least 64MB HDD space to save your memory image

BIOS is required to take care all important registers in the chipset and the chipset itself must also support power management function.. Because motherboard is an open architecture, there are many different add-on cards can be added on the motherboard, it is more difficult to support this function then the notebook close architecture. The add-on card (and chipset on it) is also required to support APM function, so that normally we will have a test report specify what kind of add-on cards have been tested. Note that you have to use VESA compatible PCI VGA, Sound Blaster compatible sound card and sound driver that supports APM for Suspend to Hard Drive to work properly.



Note: *This function does not support SCSI hard disks.*

When go into Suspend:

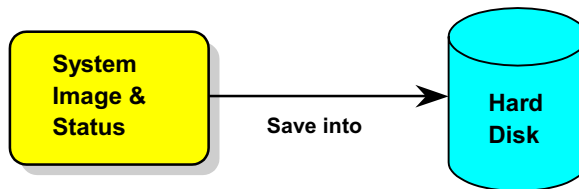

When power-on next time:

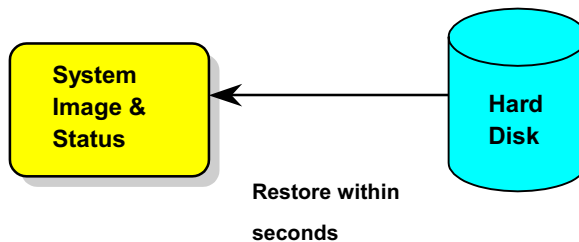

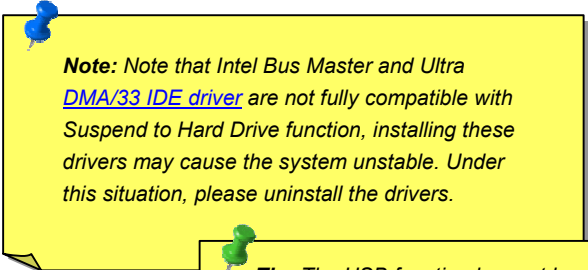

Note: Note that Intel Bus Master and Ultra [DMA/33 IDE driver](#) are not fully compatible with Suspend to Hard Drive function, installing these drivers may cause the system unstable. Under this situation, please uninstall the drivers.

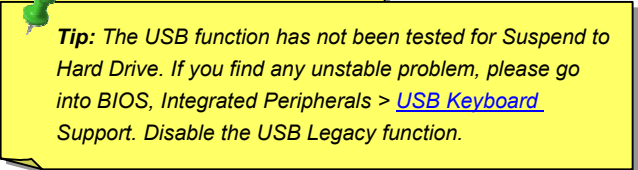

Tip: The USB function has not been tested for Suspend to Hard Drive. If you find any unstable problem, please go into BIOS, Integrated Peripherals > [USB Keyboard Support](#). Disable the USB Legacy function.

Setup APM Suspend to Hard Drive:

1. Go into BIOS setup, **Power Management** > [Suspend Mode Option](#), select "Suspend to Disk".
2. Go into BIOS setup, **PNP/PCI Configuration** > [PnP OS Installed](#), select "No". This can give BIOS the capability to allocate system resources for Suspend to Hard Drive.
3. Boot up your system into DOS command prompt. If you are Win'95 user, Please restart your Windows 95 under "Command Prompt" by pressing "**F8**" while system shows "Windows 95 Starting ...". Choose "**Safe Mode Command Prompt Only**" from selection so that system will start in DOS command prompt.
4. Copy AOZVHDD.EXE to the root directory of your C: drive.
5. **Option 1:** Use **/file** switch (applied to FAT16 file system):

Please use following command to create a hidden file in the root directory of your hard disk for Suspend to Hard Drive to save the system status and memory image.

```
C:>AOZVHDD /c /file
```

Please make sure that you have enough continuous HDD space for creating this hidden file. For example, if you have 32MB of system memory and 4MB of VGA memory, you need at least 36MB (32MB + 4MB) of continuous HDD space. If AOZVHDD failed to allocate the HDD space, you may run "DEFRAG" Utility or "Disk Defragmenter" which come with MS-DOS or Win'95 to free HDD space.

Option2: Use **/partition** switch (applied to FAT16/FAT32 file system):

To create a separate partition for Suspend to Hard Drive, please make sure you have reserved a free partition. We suggest you reserve the free partition which space is appropriate for your future memory expansion. For example, if you have 32MB of system memory and 4MB of VGA memory currently, but you plan to upgrade system memory to 64MB in the near future, then you may reserve a 68MB (64MB+4MB) space by using a disk utility (such as fdisk). Next, use following command to create a suspend partition:

C:>AOZVHDD /c /partition

If there is no extra free partition and you don't want your data lost, please do not use this partition method.

6. After creating above partition or hidden file, please reboot your system.
7. Push suspend switch (momentary mode) or use Win95 Suspend icon to force system goes into Suspend to Hard Drive mode and then turn system power off by power switch of your power supply.
8. Next time when you turn on your system, it will resume to your original work automatically.

VESA Compatible VGA Card List

Following VGA cards have been tested & recognized as VESA compatible VGA device.

AOpen PV90 (Trident 9680)
AOpen PT60 (S3 Virge/BIOS R1.00-01)
AOpen PV60 (S3 Tiro64V+)
AOpen PT70 (S3 Virge/DX)
ProLink Trident GD-5440
ProLink Cirrus GD-5430
ProLink Cirrus GD-5446
ATI Mach 64 GX
ATI 3D RAGE II
Diamond Stealth64D (S3 868)
Diamond Stealth64V (S3 968)
KuoWei ET-6000
ATI 3D RAGE PRO 2x (AGP)
PLOTTECH 3D IMAGE 9850 (AGP)
CARDEX S3 Virge/GX (AGP)

APM Compatible Sound Card List

Following sound cards have been tested OK for Suspend to Hard Drive

AOpen AW32

AOpen AW35

AOpen MP32

Creative SB 16 Value PnP

Creative SB AWE32 PnP

ESS 1868 PnP



Tip: If your sound card can not work after resume from Suspend to Hard Drive, check your sound card vendor see if there is driver to support APM, and install it again.

ACPI Suspend to Hard Drive

[ACPI](#) Suspend to Hard Drive is basically controlled by Windows operation system, check what kind of operation you want and follow the procedures step by step.

Fresh installation of Windows 98 on a new system

1. Execute "**Setup.exe /p j**" to install Windows 98
2. After Windows 98's installation is complete, go to the **Control Panel --> Power Management**.
 - a. Set All Power Schemes to "Never".
 - b. Click on "**Hibernate**" and select "Enable Hibernate Support".
 - c. Click on the Advance tab and check the "Hibernate" box.
3. Clean boot into DOS and run "**AOZVHDD /C /File**" to create the suspend hidden file.
4. Reboot system.

Changing from APM to ACPI (Windows 98 only)

1. Run "**Regedit.exe**"
 - a. Go through the following path

HKEY_LOCAL_MACHINE

SOFTWARE

MICROSOFT

WINDOWS

CURRENT VERSION

DETECT

- b. Select "ADD Binary" and name it as "**ACPIOPTION**".
 - c. Right click and select Modify, add "01" after "0000" to make it "0000 01".
 - d. Save changes.
2. Select "Add New Hardware" under Control Panel. Allow Windows 98 to detect new hardware. (It will find "**ACPI BIOS**" and remove "**Plug and Play BIOS**")
3. Reboot system.
4. Clean boot into DOS and run "AOZVHDD.EXE /C /File"

Changing from ACPI to APM

1. Run "Regedit.exe"

- a. Go through the following path

HKEY_LOCAL_MACHINE

SOFTWARE

MICROSOFT

WINDOWS

CURRENT VERSION

DETECT

ACPI OPTION

- b. Right click and select "Modify, change "01" to "00" to make it "0000 02".

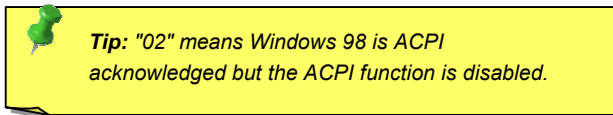

- c. Save changes.

2. Select "Add New Hardware" under Control Panel. Allow Windows 98 to detect new hardware. (It will find "**Plug and Play BIOS**" and remove "**ACPI BIOS**")
3. Reboot system.
4. Run "Add New Hardware" again and it will find "Advanced Power Management Resource".
5. Click "OK".



***Tip:** Currently we found only ATI 3D Rage Pro AGP card would support ACPI suspend to disk. Please refer to AOpen web site for latest update.*

AWARD BIOS

System parameters can be modified by going into [BIOS](#) Setup menu, this menu allows you to configure the system parameters and save the configuration into the 128 byte CMOS area, (normally in the RTC chip or in the main chipset). [To enter to BIOS setup menu](#), press when [POST \(Power-On Self Test\)](#) screen is shown on your monitor.

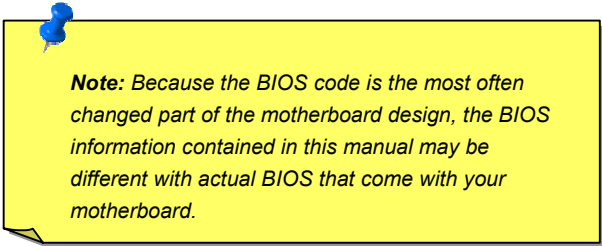

Note: Because the BIOS code is the most often changed part of the motherboard design, the BIOS information contained in this manual may be different with actual BIOS that come with your motherboard.

Enter BIOS Setup

Del

After you finish the setting of jumpers and connect correct cables. Power on and enter the BIOS Setup, press during POST (Power-On Self Test). Choose "Load Setup Defaults" for recommended optimal performance.

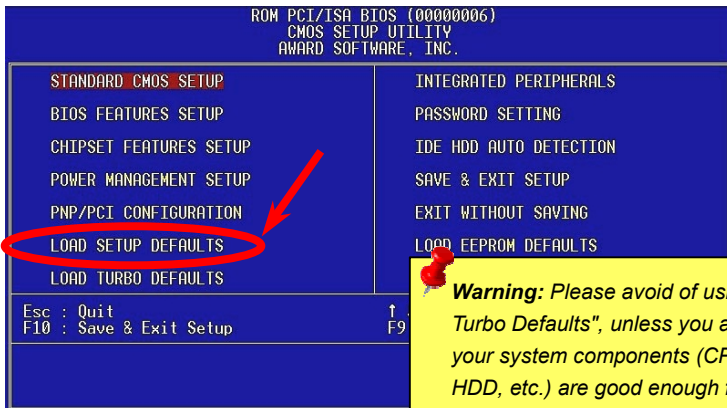

Warning: Please avoid of using "Load Turbo Defaults", unless you are sure your system components (CPU, DRAM, HDD, etc.) are good enough for turbo setting.

Change Language

F9

You can change language by press <F9>. Depends on available BIOS space. The possible languages are English, German, Japanese and Chinese.

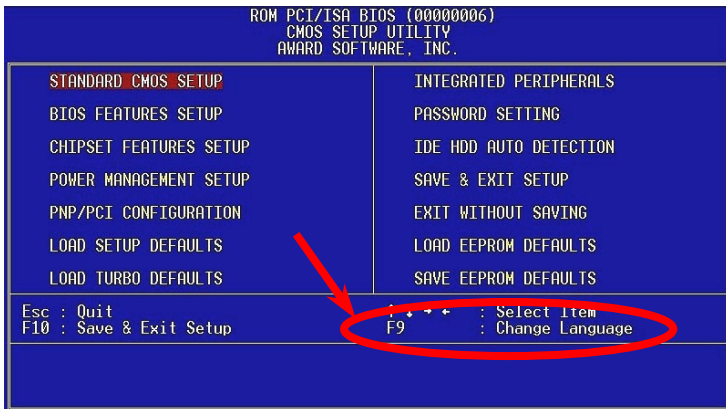

Standard CMOS Setup



The "Standard CMOS Setup" sets the basic system parameters such as the date, time, and the hard disk type. Use the arrow keys to highlight an item and <PgUp> or <PgDn> to select the value for each item.

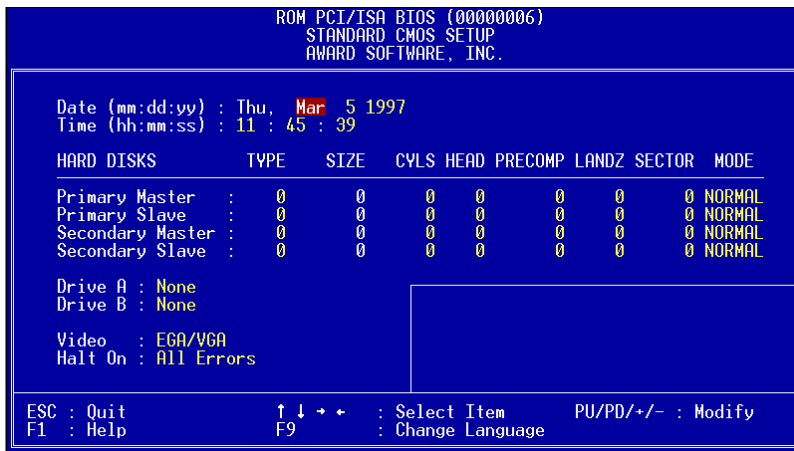



Standard CMOS > Date

To set the date, highlight the Date parameter. Press <PgUp> or <PgDn> to set the current date. The date format is month, date, and year.

Standard CMOS > Time

To set the time, highlight the Time parameter. Press <PgUp> or <PgDn> to set the current time in hour, minute, and second format. The time is based on the 24 hour military clock.

Standard CMOS > Primary Master > Type

Standard CMOS > Primary Slave > Type

Standard CMOS > Secondary Master > Type

Standard CMOS > Secondary Slave > Type

Type

Auto

User

None

This item lets you select the IDE hard disk parameters that your system supports. These parameters are Size, Number of Cylinder, Number of Head, Start Cylinder for Pre-compensation, Cylinder number of Head Landing Zone and Number of Sector per Track. The default setting is **Auto**, which enables BIOS to automatically detect the parameters of installed HDD (Hard Disk Drive) at [POST](#) (Power-On Self Test). If you prefer to enter HDD parameters manually, select **User**. Select **None** if no HDD is connected to the system.

The IDE CDROM is always automatically detected.



Tip: For an IDE hard disk, we recommend that you use the "[IDE HDD Auto Detection](#)" to enter the drive specifications automatically. See the section "IDE

Standard CMOS > Primary Master > Mode

Standard CMOS > Primary Slave > Mode

Standard CMOS > Secondary Master > Mode

Standard CMOS > Secondary Slave > Mode

Mode

Auto

Normal

LBA

Large

The enhanced IDE feature allows the system to use a hard disk with a capacity of more than 528MB. This is made possible through the Logical Block Address (LBA) mode translation. The LBA is now considered a standard feature of current IDE hard disk on the market because of its capability to support capacity larger than 528MB. Note that if a HDD is formatted with LBA On, it will not be able to boot with LBA Off.

Standard CMOS > Drive A**Standard CMOS > Drive B****Drive A**

None

360KB 5.25"

1.2MB 5.25"

720KB 3.5"

1.44MB 3.5"

2.88MB 3.5"

These items select the floppy drive type. The available settings and types supported by the motherboard are listed to the left.

Standard CMOS > Video**Video**

EGA/VGA

CGA40

CGA80

Mono

This item specifies the type of video card in use. The default setting is VGA / EGA. Since current PCs use VGA only, this function is almost useless and may be disregarded in the future.

Standard CMOS > Halt On

Halt On

No Errors

All Errors

All, But Keyboard

All, But Diskette

All, But Disk/Key

This parameter enables you to control the system stops in case of Power-On Self Test ([POST](#)) error.

BIOS Features Setup

This screen appears when you select the option "BIOS Features Setup" from the main menu.

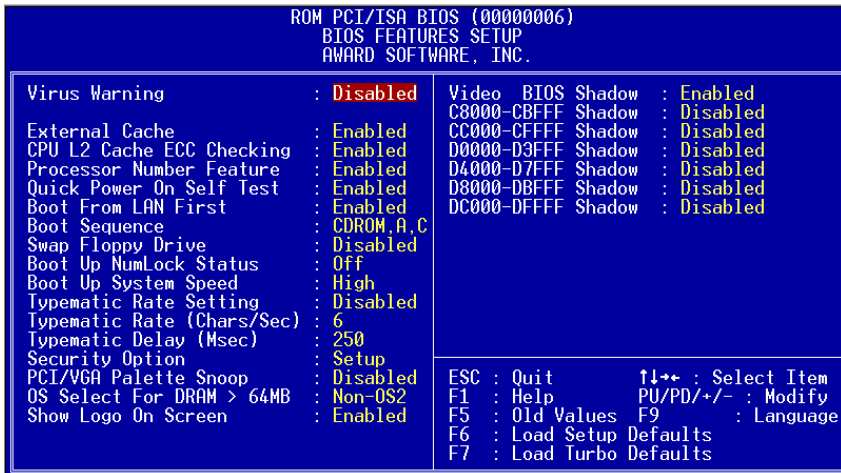

BIOS Features > Virus Warning**Virus Warning**

Enabled

Disabled

Set this parameter to Enabled to activate the warning message.

This feature protects the boot sector and partition table of your hard disk from virus intrusion. Any attempt during boot up to write to the boot sector of the hard disk drive stops the system and the following warning message appears on the screen. Run an anti-virus program to locate the problem.

! WARNING !

Disk Boot Sector is to be modified
Type "Y" to accept write, or "N" to abort write
Award Software, Inc.

BIOS Features > External Cache

External Cache

Enabled
Disabled

Enabling this parameter activates the secondary cache (currently, PBRAM cache). Disabling the parameter slows down the system. Therefore, we recommend that you leave it enabled unless you are troubleshooting a problem.

BIOS Features > CPU L2 Cache ECC Checking

**CPU L2 Cache ECC
Checking**

Enabled
Disabled

This item lets you enable or disable L2 Cache [ECC](#) checking.

BIOS Features > Processor Number Feature

**Processor Number
Feature**

Enabled
Disabled

This item is used to enable or disable Pentium III CPU Number Feature.

BIOS Features > Quick Power On Self Test**Quick Power on Self
test**

Enable

Disabled

This parameter speeds up [POST](#) by skipping some items that are normally checked.

BIOS Features > Boot From LAN First**Boot From LAN First**

Enable

Disabled

This item is used to boot the system from a network server.

BIOS Features > Boot Sequence

<u>Boot Sequence</u>
A,C,SCSI
C,A,SCSI
C,CDROM,A
CDROM,C,A
CDROM,A,C
D,A,SCSI
E,A,SCSI
F,A,SCSI
SCSI,A,C
SCSI,C,A
C only
LS/ZIP,C

This parameter allows you to specify the system boot up search sequence. The hard disk ID are listed below:

- C: Primary master
- D: Primary slave
- E: Secondary master
- F: Secondary slave
- LS: LS120
- Zip: IOMEGA ZIP Drive

BIOS Features > Swap Floppy Drive

<u>Swap Floppy Drive</u>
Enabled
Disabled

This item allows you to swap floppy drives. For example, if you have two floppy drives (A and B), you can assign the first drive as drive B and the second drive as drive A or vice-versa.



BIOS Features > Boot Up NumLock Status

Boot Up NumLock Status

On
Off

Setting this parameter to On enables the numeric function of the numeric keypad. Set this parameter to Off to disregard the function. Disabling the numeric function allows you to use the numeric keypad for cursor control.

BIOS Features > Boot Up System Speed

Boot Up System Speed

High
Low

Select High or Low system speed after boot.

BIOS Features > Typematic Rate Setting

Typematic Rate Setting

Enabled
Disabled

Set this parameter to Enable/Disable the keyboard repeat function. When enabled, continually holding down a key on the keyboard will generate repeatedly keystrokes.

BIOS Features > Typematic Rate (Chars/Sec)**Typematic Rate**

6
8
10
12
15
20
24
30

This item allows you to control the speed of repeated keystrokes. The default is 30 characters/sec.

BIOS Features > Typematic Delay (Msec)**Typematic Delay**

250
500
750
1000

This parameter allows you to control the delay time between the first and the second keystroke (where the repeated keystrokes begin). The typematic delay settings are 250, 500, 750, and 1000 msec.

BIOS Features > Security Option

Security Option

Setup
System

The **System** option limits access to both the System boot and BIOS setup. A prompt asking you to enter your password appears on the screen every time you boot the system.

The **Setup** option limits access only to BIOS setup.

To disable the security option, select Password Setting from the main menu, don't type anything and just press <Enter>.

BIOS Features > PCI/VGA Palette Snoop

PCI/VGA Palette

Snoop

Enabled
Disabled

Enabling this item informs the PCI VGA card to keep silent (and to prevent conflict) when palette register is updated (i.e., accepts data without responding any communication signals).

This is useful only when two display cards use the same palette address and plugged in the PCI bus at the same time (such as MPEQ or Video capture). In such case, PCI VGA is silent while MPEQ/Video capture is set to function normally.

BIOS Features > OS Select for DRAM > 64MB**OS Select for DRAM**
> 64MB

OS/2

Non-OS/2

Set to OS/2 if your system is utilizing an OS/2 operating system and has a memory size of more than 64 MB.

BIOS Features > Show Logo On Screen**Show Logo On Screen**

Enabled

Disabled

This item lets you show or hide AOpen logo on the [POST](#) screen.

BIOS Features > Video BIOS Shadow**Video BIOS Shadow**

Enabled

Disabled

VGA BIOS Shadowing means to copy video display card BIOS into the DRAM area. This enhances system performance because DRAM access time is faster than ROM.

BIOS Features > C800-CBFF Shadow

BIOS Features > CC00-CFFF Shadow

BIOS Features > D000-D3FF Shadow

BIOS Features > D400-D7FF Shadow

BIOS Features > D800-DBFF Shadow

BIOS Features > DC00-DFFF Shadow

C800-CBFF

Shadow

Enabled

Disabled

These six items are for shadowing ROM code on other expansion cards. Before you set these parameters, you need to know the specific addresses of that ROM code. If you do not know this information, enable all the ROM shadow settings.



Note: *The F000 and E000 segments are always shadowed because BIOS code occupies these areas.*

Chipset Features Setup

The "Chipset Features Setup" includes settings for the chipset dependent features. These features are related to system performance.

```
ROM PCI/ISA BIOS (00000006)
CHIPSET FEATURES SETUP
AWARD SOFTWARE, INC.

SDRAM CAS Latency      : 2 T
SDRAM RAS# to CAS# Delay : 2 T
SDRAM RAS# Precharge   : 2 T
SDRAM Precharge Control : Disabled
DRAM ECC Function      : Disabled
System BIOS Cacheable  : Disabled
Video BIOS Cacheable   : Disabled
Video RAM Cacheable    : Disabled
8 Bit I/O Recovery Time : NA
16 Bit I/O Recovery Time : NA
Memory Hole At 15M-16M : Disabled
Passive Release        : Disabled
Delayed Transaction     : Disabled
AGP Aperture Size (MB) : 4
Pentium II Micro Codes : Disabled

***** Jumperless Setup *****
Manufacture Freq Default :
CPU Voltage Detected     :
CPU Voltage Setting      : 2.20 V
Clock Spread Spectrum    : Off
CPU Clock Frequency      : 68.5 MHz
CPU Clock Ratio          : 2.0
Setup CPU Speed          : 137.0 MHz
V2K CMOS Update         : Disabled
```



Warning: Make sure you fully understand the items contained in this menu before you try to change anything. You may change the parameter settings to improve system performance. However, it may cause your system to be unstable if the setting is not correct for your system configuration.

Chipset Features > SDRAM CAS Latency

Chipset Features > SDRAM RAS# to CAS# Delay

SDRAM CAS Latency

2T
3T
Auto

These are timing of [SDRAM](#) CAS Latency and RAS to CAS Delay, calculated by clocks. They are important parameters affects SDRAM performance, default is **Auto**. If you install DIMMs with [SPD](#) and set this item to Auto, BIOS will automatically detect your DIMMs and then set to a appropriate timing; If you use DIMMs without SPD and set this item to Auto, BIOS will set it to 3/3. To make sure all of these settings in BIOS are correct, it is recommended to use DIMMs with SPD.

Chipset Features > SDRAM RAS# Precharge

SDRAM RAS# precharge

2T
3T
Auto

The RAS Precharge means the timing to inactive RAS and the timing for DRAM to do precharge before next RAS can be issued. RAS is the address latch control signal of DRAM row address. The default setting is **Auto**.

Chipset Features > DRAM ECC Function

DRAM ECC Function

Auto
Disabled

This lets you enable or disable DRAM [ECC](#) function. The ECC algorithm has the ability to detect double bit error and automatically correct single bit error.

Chipset Features > Video BIOS Cacheable

Video BIOS Cacheable

Enabled
Disabled

This item lets you cache Video RAM C000.

Chipset Features > Video RAM Cacheable

Video RAM Cacheable

Enabled
Disabled

This item lets you cache Video RAM A000 and B000.

Chipset Features > 8 Bit I/O Recovery Time

8 Bit I/O Recovery Time

1
2
3
4
5
6
7
8
NA

For some old I/O chips, after the execution of an I/O command, the device requires a certain amount of time (recovery time) before the execution of the next I/O command. Because of new generation CPU and motherboard chipset, the assertion of I/O command is faster, and sometimes shorter than specified I/O recovery time of old I/O devices. This item lets you specify the delay of 8-bit I/O command by count of ISA bus clock. If you find any unstable 8-bit I/O card, you may try to extend the I/O recovery time via this item. The BIOS default value is **4 ISA clock**. If set to NA, the chipset will insert 3.5 system clocks.

Chipset Features > 16 Bit I/O Recovery Time

<u>16 Bit I/O Recovery Time</u>
--

1
2
3
4
NA

The same as 16-bit I/O recovery time. This item lets you specify the recovery time for the execution of 16-bit I/O commands by count of ISA bus clock. If you find any of the installed 16-bit I/O cards unstable, try extending the I/O recovery time via this item. The BIOS default value is **1 ISA clocks**. If set to NA, the chipset will automatically insert 3.5 system clocks.

Chipset Features > Memory Hole At 15M-16M

<u>Memory Hole At 15M-16M</u>

Enabled
Disabled

This option lets you reserve system memory area for special ISA cards. The chipset accesses code/data of these areas from the ISA bus directly. Normally, these areas are reserved for memory mapped I/O card.

Chipset Features > Passive Release

Passive Release

Enabled
Disabled

This item lets you control the Passive Release function of the PIIX4E chipset (Intel PCI to ISA bridge). This function is used to meet latency of ISA bus master. Try to enable or disable it, if you have ISA card compatibility problem.

Chipset Features > Delayed Transaction

Delayed Transaction

Enabled
Disabled

This item lets you control the Delayed Transaction function of the PIIX4E chipset (Intel PCI to ISA bridge). This function is used to meet latency of PCI cycles to or from ISA bus. Try to enable or disable it, if you have ISA card compatibility problem.

Chipset Features > AGP Aperture Size (MB)

**AGP Aperture Size
(MB)**

4, 8, 16, 32, 64, 128, 256

This item lets you determine the effective size of the [AGP](#) Graphic Aperture.

Chipset Features > Pentium II Micro Codes

Pentium II Micro Codes

Enabled

Disabled

The micro codes are used to fix bugs of Pentium II CPU, we strongly recommend to enable this item for system reliability reason. However, this microcode may slightly reduce CPU performance. We provide this option for your convenience if you like to test it.

Chipset Features > Manufacture Frequency Default

Manufacture Frequency Default

Depends on the CPU type

This item only reminds you the actual CPU frequency while clearing CMOS or pressing "Home" key. The default setting is 233 MHz, you can modify it to match the actual CPU frequency by using the utility - flash.exe.

Chipset Features > CPU Voltage Setting

CPU Voltage Setting

Auto detected, manual adjustable to add 0.1V or 0.2V.

This item is designed for overclockers. The default setting is auto detected from existing CPU. You may try to add 0.1V or 0.2V at current CPU voltage for overclocking to a higher [FSB](#) clock, however, doing so is probably harmful to your CPU.

Chipset Features > Clock Spread Spectrum

Clock Spread Spectrum

On
Off

This item is used to set clock spread spectrum for EMI testing. Normally, you don't need to change the default setting.

Chipset Features > CPU Clock Frequency

CPU Clock Frequency

66.8 MHz, 68.5 MHz,
75.0 MHz, 83.3 MHz,
100 MHz, 103 MHz,
112 MHz, 117 MHz,
124 MHz, 129 MHz,
133.3 MHz, 138 MHz,
143 MHz, 148 MHz,
153 MHz

This item lets you set external clock (bus clock). The correct setting may vary because of different CPU products, refer to your CPU specification for more details.

Chipset Features > CPU Clock Ratio

CPU Clock Ratio

1.5, 2.0, 2.5, 3.0, 3.5, 4.0,
4.5, 5.0, 5.5, 6.0, 6.5, 7.0,
7.5, 8.0

Intel Pentium II is designed to have different Internal (Core) and External (Bus) frequency. This item lets you select the ratio of Core/Bus frequency. The default value is 3.5x.

Chipset Features > Setup CPU Speed

Setup CPU Speed

The CPU Speed is derived from the product of "CPU Clock Frequency" and "CPU Clock Ratio".

Chipset Features > Y2K CMOS Update

Y2K CMOS Update

Enabled
Disabled

This item is designed for some [Y2K](#) testing programs, for example, Check It 98. If you are using this kind of program to test your system and fails, enable this item and redo the test again.

Power Management Setup

The Power Management Setup screen enables you to control the motherboard green features. See the following screen.

```

ROM PCI/ISA BIOS (00000006)
POWER MANAGEMENT SETUP
AWARD SOFTWARE, INC.

ACPI function      : Enabled
Power Management  : Disabled
PM Control by APM : Yes
Video Off Method  : V/H SYNC+Blank
Video Off After   : Standby
Doze Mode         : Disabled
Standby Mode      : Disabled
Suspend Mode     : Disabled
HDD Power Down   : Disabled
OV Wake On Modem : Disabled
Wake On Lan      : Disabled
Suspend Mode Option : PowerOn Suspend
Throttle Duty Cycle : 62.5%
VGA Active Monitor : Disabled
Soft-Off by PWR-BTTN : Delay 4 Sec.
Wake On RTC Timer : Disabled

** Break Event From Suspend **
IRQ 8 Break Suspend : Disabled

** Reload Global Timer Events **
IRQ[3-7,9-15],NMI : Enabled
Primary IDE 0      : Disabled
Primary IDE 1      : Disabled
Secondary IDE 0    : Disabled
Secondary IDE 1    : Disabled
Floppy Disk        : Disabled
Serial Port        : Enabled
Parallel Port      : Disabled

ESC : Quit          ↑↓+* : Select Item
F1  : Help          PU/PD/+/- : Modify
F5  : Old Values   F9      : Language
F6  : Load Setup Defaults
F7  : Load Turbo Defaults
  
```

Power Management > ACPI Function

ACPI Function

Enabled
Disabled

If your OS is ACPI enabled you have to set this item to Enabled, or there may be unexpected errors. If your OS is APM mode, you can remain the Disabled setting.

Power Management > Power Management

Power Management

Max Saving
Mix Saving
User Define
Disabled

This function allows you to set the default parameters of power-saving modes. Set to **Disable** to turn off the power management function. Set to User Define to choose your own parameters.

Mode	Doze	Standby	Suspend	HDD Power Down
Min Saving	1 hour	1 hour	1 hour	15 min
Max Saving	1 min	1 min	1 min	1 min

Power Management > PM Controlled by APM

PM Controlled by APM

Yes

No

If "Max Saving" is selected, you can turn on this item, transfer power management control to APM (Advanced Power Management) and enhance power saving function. For example, stop CPU internal clock.

Power Management > Video Off Method

Video Off Method

V/H SYNC + Blank

DPMS

Blank Screen

This determines the way that the monitor is off. Blank Screen writes blanks to video buffer. V/H SYNC + Blank allows BIOS to control VSYNC and HSYNC signals. This function applies only for DPMS (Display Power Management Standard) monitor. The DPMS mode uses DPMS functions provided by the VGA card.

Power Management > Video Off After

Video Off AfterN/A, Doze, Standby,
Suspend

To turn off video monitor at which power down mode.

Power Management > Doze Mode

Doze Mode

Disabled, 1 Min, 2 Min,
4 Min, 8 Min, 12 Min,
20 Min, 30 Min, 40
Min, 1 Hour

This item lets you set the period of time after which the system enters into Doze mode. The system activity (or event) is detected by monitoring the IRQ signals or other events (such as I/O).

Power Management > Standby Mode

Standby Mode

Disabled, 1 Min, 2 Min,
4 Min, 8 Min, 12 Min,
20 Min, 30 Min, 40
Min, 1 Hour

This item lets you set the period of time after which the system enters into Standby mode. In this mode, the monitor power-saving feature activates. Any activity detected returns the system to full power. The system activity (or event) is detected by monitoring the IRQ signals or other events (such as I/O).

Power Management > Suspend Mode

Suspend Mode

Disabled, 1 Min, 2 Min,
4 Min, 8 Min, 12 Min,
20 Min, 30 Min, 40
Min, 1 Hour

This item lets you set the period of time after which the system enters into Suspend mode. The Suspend mode can be Power On Suspend or Suspend to Hard Drive, selected by "[Suspend Mode Option](#)".

Power Management > HDD Power Down

HDD Power Down

Disabled, 1 Min,,
15 Min

This option lets you specify the IDE HDD idle time before the device enters the power down state. This item is independent from the power states previously described in this section (Standby and Suspend).

Power Management > 0V Wake On Modem

0V Wake On Modem

Enabled
Disabled

This option lets you specify enable or disable Wake On Modem function.

Power Management > Wake On LAN

Wake On LAN

Enabled

Disabled

This option lets you specify enable or disable Wake On LAN function.

Power Management > Suspend Mode Option

Suspend Mode Option

PowerOn Suspend

Suspend to Disk

You can select suspend mode by this item. **Power On Suspend** is the traditional Green PC suspend mode, the CPU clock is stop, all other devices are shut off. But power must be kept On to detect activities from modem, keyboard/mouse and returns the system to full power. The system activities is detected by monitoring the IRQ signals or I/O. **Suspend to Hard Drive** saves system status, memory and screen image into hard disk, then the power can be totally Off. Next time, when power is turned On, the system goes back to your original work within just few seconds, which depending on your memory size. You need utility AOZVHDD to reserve disk space.

Power Management > Throttle Duty Cycle

Throttle Duty Cycle

12.5 %
25.0 %
37.5 %
50.0 %
62.5 %
75.0 %
87.5 %

Clock Throttling means at the Doze/Standby state, the CPU clock count in a given time (not the frequency) is reduced to the ratio specified in this parameter. Actually, the period per CPU clock is not changed. For example, a 66MHz CPU clock remains the same 30ns clock period when system goes into Doze/Suspend. The chipset generates the STPCLK (stop clock) signal periodically to prevent CPU for accepting clock from clock generator. For full power on, the CPU can receive 66M count in one second. If the Slow Clock Ratio is set to 50%, the CPU will only receive 33M clock count in one second. This will effectively reduce CPU speed as well as CPU power.

Power Management > VGA Active Monitor

VGA Active Monitor

Enabled
Disabled

To enable or disable the detection of VGA activity for power down state transition.

Power Management > Soft-Off by PWR-BTTN

Soft-Off by PWR-BTTN

Delay 4 sec.

Instant-Off

This is a specification of ACPI and supported by hardware. When **Delay 4 sec.** is selected, the soft power switch on the front panel can be used to control power On, Suspend and Off. If the switch is pressed for less than 4 seconds during power On, the system will go into Suspend mode. If the switch is pressed for longer than 4 seconds, the system will be turned Off. The default setting is **Instant-Off**. If **Instant-Off** is selected the soft power switch is only used to control On and Off, so there is no need to press it for 4 seconds, and there is no Suspend.

Power Management > Wake On RTC Timer

Wake On RTC Timer

By Date

By Week

Disabled

The Wake Up Timer is more like an alarm, which wakes up and powers on your system at a pre-defined time for a specific application. It can be set to wake up everyday or on specific date within a month. The date/time is accurate to within a second. This option lets you enable or disable the RTC Wake Up function.

Power Management > Date (of Month)

Date (of Month)

0, 1,, 31

This item is displayed when you enable the Wake On RTC Timer option. Here you can specify what date you want to wake up the system. For Example, setting to 15 will wake up the system on the 15th day of every month.



Tip: Setting this item to 0 will wake up the system on the specified time (which can be set in the Wake On RTC Timer) every day.

Power Management > Time (hh:mm:ss)

Time (hh:mm:ss)

hh:mm:ss

This item is displayed when you enable the Wake On RTC Timer option. Here you can specify what time you want to wake up the system.

Power Management > IRQ 8 Clock Event

IRQ 8 Clock Event

Enabled

Disabled

To enable or disable the detection of IRQ8 (RTC) event for power down state transition. OS2 has periodically IRQ8 (RTC) interruptions, If IRQ8 is not set to **Disabled**, OS/2 may fail to go into Doze/Standby/Suspend mode.

Power Management > IRQ [3-7,9-15],NMI

IRQ [3-7,9-15],NMI

Enabled

Disabled

To enable or disable the detection of IRQ3-7, IRQ9-15 or NMI interrupt events for power down state transition.

Power Management > Primary IDE 0

Power Management > Primary IDE 1

Power Management > Secondary IDE 0

Power Management > Secondary IDE 1

Power Management > Floppy Disk

Power Management > Serial Port

Power Management > Parallel Port

<u>Primary IDE 0</u>

Enabled

Disabled

These items enable or disable the detection of IDE, floppy, serial and parallel port activities for power down state transition. Actually it detects the read/write to/from I/O port.

PNP/PCI Configuration Setup

The [PNP](#)/PCI Configuration Setup allows you to configure the ISA and PCI devices installed in your system. The following screen appears if you select the option "PNP/PCI Configuration Setup" from the main menu.

```

ROM PCI/ISA BIOS (00000006)
PNP/PCI CONFIGURATION
AWARD SOFTWARE, INC.

PNP OS Installed      : No
Resources Controlled By : Manual

IRQ-3 assigned to : PCI/ISA PnP
IRQ-4 assigned to : PCI/ISA PnP
IRQ-5 assigned to : PCI/ISA PnP
IRQ-7 assigned to : PCI/ISA PnP
IRQ-9 assigned to : PCI/ISA PnP
IRQ-10 assigned to : PCI/ISA PnP
IRQ-11 assigned to : PCI/ISA PnP
IRQ-12 assigned to : PCI/ISA PnP
IRQ-14 assigned to : PCI/ISA PnP
IRQ-15 assigned to : PCI/ISA PnP
DMA-0 assigned to : PCI/ISA PnP
DMA-1 assigned to : PCI/ISA PnP
DMA-3 assigned to : PCI/ISA PnP
DMA-5 assigned to : PCI/ISA PnP
DMA-6 assigned to : PCI/ISA PnP
DMA-7 assigned to : PCI/ISA PnP

PCI IDE IRQ Map To : PCI-AUTO
Primary IDE INT# : A
Secondary IDE INT# : B

Assign IRQ For USB : Enabled
Assign IRQ For VGA : Enabled
MODEM Use IRQ : 3

Used MEM base addr : N/A

PCI Slot 1 IRQ (Right) : Auto
PCI Slot 2 IRQ : Auto
PCI Slot 3/6 IRQ : Auto
PCI Slot 4/5 IRQ : Auto

ESC : Quit          ↑↓↓ : Select Item
F1 : Help          PU/PD/+- : Modify
F5 : Old Values   F9 : Language
F6 : Load Setup Defaults
F7 : Load Turbo Defaults
  
```

PNP/PCI Configuration > PnP OS Installed

PnP OS Installed

Yes
No

Normally, the PnP resources are allocated by BIOS during [POST](#) (Power-On Self Test). If you are using a [PnP](#) operating system (such as Windows 95), set this item to **Yes** to inform BIOS to configure only the resources needed for booting (VGA/IDE or SCSI). The rest of system resources will be allocated by PnP operating system.

PNP/PCI Configuration > Resources Controlled By

Resources Controlled by

Auto
Manual

Setting this option to Manual allows you to individually assign the IRQs and DMAs to the ISA and PCI devices. Set this to **Auto** to enable the auto-configuration function.

PNP/PCI Configuration > Reset Configuration Data

Reset Configuration Data

Enabled
Disabled

In case conflict occurs after you assign the IRQs or after you configure your system, you can enable this function, allow your system to automatically reset your configuration and reassign the IRQs, DMAs, and I/O address.

PNP/PCI Configuration > IRQ3 (COM2)

PNP/PCI Configuration > IRQ4 (COM1)

PNP/PCI Configuration > IRQ5 (Network/Sound or Others)

PNP/PCI Configuration > IRQ7 (Printer or Others)

PNP/PCI Configuration > IRQ9 (Video or Others)

PNP/PCI Configuration > IRQ10 (SCSI or Others)

PNP/PCI Configuration > IRQ11 (SCSI or Others)

PNP/PCI Configuration > IRQ12 (PS/2 Mouse)

PNP/PCI Configuration > IRQ14 (IDE1)

PNP/PCI Configuration > IRQ15 (IDE2)

IRQ 3

Legacy ISA

PCI/ISA PnP

If your ISA card is not PnP compatible and requires a special IRQ to support its function, set the selected IRQ to **Legacy ISA**. This setting informs the PnP BIOS to reserve the selected IRQ for the installed legacy ISA card. The default is **PCI/ISA PnP**. Take note that PCI cards are always PnP compatible (except old PCI IDE card).

[PNP/PCI Configuration > DMA 0](#)

[PNP/PCI Configuration > DMA 1](#)

[PNP/PCI Configuration > DMA 3](#)

[PNP/PCI Configuration > DMA 5](#)

[PNP/PCI Configuration > DMA 6](#)

[PNP/PCI Configuration > DMA 7](#)

DMA 0

Legacy ISA

PCI/ISA PnP

If your ISA card is not PnP compatible and requires a special DMA channel to support its function, set the selected DMA channel to **Legacy ISA**. This setting informs the PnP BIOS to reserve the selected DMA channel for the installed legacy ISA card. The default is **PCI/ISA PnP**. Take note that PCI card does not require DMA channel.

PNP/PCI Configuration > PCI IDE IRQ Map To

PCI IDE IRQ Map To

ISA
PCI-Slot1
PCI-Slot2
PCI-Slot3
PCI-Slot4
PCI-Auto

Some old PCI IDE add-on cards are not fully PnP compatible. These cards require you to specify the slot in use to enable BIOS to properly configure the PnP resources. This function allows you to select the PCI slot for any PCI IDE add-on card present in your system. Set this item to **Auto** to allow BIOS to automatically configure the installed PCI IDE card(s).

PNP/PCI Configuration > Primary IDE INT#

PNP/PCI Configuration > Secondary IDE INT#

Primary IDE INT#

A
B
C
D

These two items, in conjunction with item "PCI IDE IRQ Map To", specify the IRQ routing of the primary or secondary channel of the PCI IDE add-on card (not the onboard IDE). Each PCI slot has four PCI interrupts aligned as listed in the table below. You must specify the slot in the "PCI IDE IRQ Map To", and set the PCI interrupt (INTx) here according to the interrupt connection on the card.

PCI Slot	Location 1 (pin A6)	Location 2 (pin B7)	Location 3 (pin A7)	Location 4 (pin B8)
Slot 1	INTA	INTB	INTC	INTD
Slot 2	INTB	INTC	INTD	INTA
Slot 3	INTC	INTD	INTA	INTB
Slot 4	INTD	INTA	INTB	INTC
Slot 5 (if any)	INTD	INTA	INTB	INTC

PNP/PCI Configuration > Modem Use IRQ

Modem Use IRQ

N/A, 3, 4, 5, 7, 9, 10, 11

This item lets you set an IRQ for the modem.

PNP/PCI Configuration > Used MEM Base Addr

Used MEM Base Addr

N/A
C800
CC00
D000
D400
D800
DC00

This item, in conjunction with the "Used MEM Length", lets you set a memory space for non-PnP compatible ISA card. This item specifies the memory base (start address) of the reserved memory space. The memory size is specified in the "Used MEM Length".

PNP/PCI Configuration > Used MEM Length

Used MEM Length

8K
16K
32K
64K

If your ISA card is not PnP compatible and requires special memory space to support its function, specify the memory size in this parameter to inform the PnP BIOS to reserve the specified memory space for installed legacy ISA card.

PNP/PCI Configuration > PCI Slot1 IRQ (Right)

PNP/PCI Configuration > PCI Slot2 IRQ

PNP/PCI Configuration > PCI Slot3/6 IRQ

PNP/PCI Configuration > PCI Slot4/5 IRQ (Left)

PCI Slot1 IRQ

3, 4, 5, 7, 9, 10, 11, 12,
14, 15, Auto

This item is reserved for engineering purpose to let you assign an IRQ manually to the add-on card on each PCI slot. If you select Auto, system will automatically assign an available value to the device.

It is suggested to use default setting, which is Auto, in order to comply with PnP specification completely.

Load Setup Defaults

The "Load Setup Defaults" option loads optimized settings for optimum system performance. Optimal settings are relatively safer than the Turbo settings. **All the product verification, compatibility/reliability test report and manufacture quality control are based on "Load Setup Defaults"**. We recommend to use this settings for normal operation. "Load Setup Defaults" is not the slowest setting for this motherboard. If you need to verify an unstable problem, you may manually set the parameter in the "[BIOS Features Setup](#)" and "[Chipset Features Setup](#)" to get slowest and safer setting.

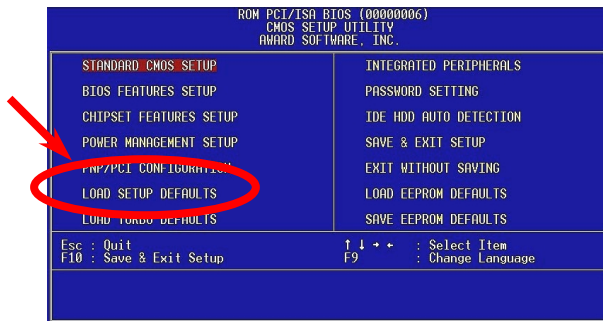

Load Turbo Defaults

The "Load Turbo Defaults" option gives better performance than "Load Setup Defaults". It is provided for the convenience of power user who wants to push the motherboard to get better performance. Turbo setting does not go through all the detail reliability and compatibility test, it is tested only with limited configuration and loading (for example, a system that contains only a VGA card and two DIMMs). **Use Turbo setting only when you fully understand the items in Chipset Setup menu.** The performance improvement of Turbo setting is normally around 3% to 5%, depending on the chipset and the application.

Integrated Peripherals

The following screen appears if you select the option "Integrated Peripherals" from the main menu. This option allows you to configure the I/O features.

```

ROM PCI/ISA BIOS (00000006)
INTEGRATED PERIPHERALS
AWARD SOFTWARE, INC.

IDE HDD Block Mode      : Disabled
IDE Primary Master PIO  : Auto
IDE Primary Slave PIO   : Auto
IDE Secondary Master PIO : Auto
IDE Secondary Slave PIO : Auto
IDE Primary Master UDMA : Auto
IDE Primary Slave UDMA  : Auto
IDE Secondary Master UDMA : Auto
IDE Secondary Slave UDMA : Auto
On-Chip Primary PCI IDE : Enabled
On-Chip Secondary PCI IDE : Enabled
USB Keyboard Support    : Disabled
Init Display First      : PCI

POWER ON Function      :
KB Power ON Password   : Enter
Hot Key Power ON       : Ctrl-F1
AC PWR Auto Recovery    : Off

Onboard FDC Controller :
Onboard Serial Port 1  : 3F8/IRQ4
Onboard Serial Port 2  :
UART Mode Select       :
Rx/D , Tx/D Active     : Hi,Lo
IR Transmission delay  : Enabled
Onboard Parallel Port  :
Parallel Port Mode     :
ECP Mode Use DMA       : 3
EPP Mode Select        : EPP1.9

ESC : Quit          ↑↓↔ : Select Item
F1  : Help         PU/PD/+/- : Modify
F5  : Old Values   F9      : Language
F6  : Load Setup Defaults
F7  : Load Turbo Defaults

```

Integrated Peripherals > IDE HDD Block Mode

IDE HDD Block Mode

Enabled

Disabled

This feature enhances disk performance by allowing multisector data transfers and eliminates the interrupt handling time for each sector. Most IDE drives, except with old designs, can support this feature.

Integrated Peripherals > IDE Primary Master UDMA

Integrated Peripherals > IDE Primary Slave UDMA

Integrated Peripherals > IDE Secondary Master UDMA

Integrated Peripherals > IDE Secondary Slave UDMA

**IDE Primary Master
UDMA**

Auto

Disabled

This item allows you to set the [Ultra DMA/33](#) mode supported by the hard disk drive connected to your primary IDE connector.

Integrated Peripherals > On-Chip Primary PCI IDE

Integrated Peripherals > On-Chip Secondary PCI IDE

On-Chip Primary PCI IDE

Enabled
Disabled

This parameter lets you enable or disable the IDE device connected to the primary IDE connector.

Integrated Peripherals > USB Keyboard Support

USB Keyboard Support

Enabled
Disabled

This item lets you enable or disable the [USB](#) keyboard driver within the onboard BIOS. The keyboard driver simulates legacy keyboard command and let you use USB keyboard during [POST](#) or after boot if you don't have USB driver in the operating system.



Note: You cannot use both USB driver and USB legacy keyboard at the same time. Disable "[USB Keyboard Support](#)" if you have USB driver in the operating system.

Integrated Peripherals > Init Display First**Init Display First**

PCI

AGP

If you installed a PCI VGA card and an [AGP](#) card at the same time, this item lets you decide which one is the initial display card.

Integrated Peripherals > Power On Function

Power On Function

Button Only
Keyboard 98
Password
Hot Key
Mouse Left
Mouse Right

This item is used to select Wake on Keyboard/Mouse mode.

Button Only: Disable Wake on KB/MS function. You can boot up your system by power button only.

Keyboard 98: If selecting this option, you can boot up the system by power button and the "Wake" key on keyboard which complies to Keyboard 98 standard.

Password: Disable the function of power button and let the system can only be powered on through the preset keys (like a password).

Hot Key: If selecting this option, you also need to specify the hot key from "Hot Key Power On" item.

Mouse Left: This function allows you wake up the system by clicking left mouse button twice successively. Note that the mouse can't be moved while double clicking.

Mouse Right: This function allows you wake up the system by clicking right mouse button twice successively. Note that the mouse can't be moved while double clicking.

**Note:**

- *Whenever you change this item, it will only take effect after you restart the system and successfully boot the Windows or DOS.*
- *To implement Wake on Keyboard/Mouse function, you must set [JP28](#) to Enabled.*
- *Wake on Mouse function applies to PS/2 mouse only.*
- *If you set a password but forget it, please [clear CMOS](#).*
- *If you want to use Wake on Mouse function in DOS, it is necessary to install the DOS driver of the mouse.*

Integrated Peripherals > Keyboard Power On Password

Keyboard Power On Password

You can specify 1-5 keys as a password.



Note: Before setting a password you have to make sure JP28 has been enabled, or your system cannot be boot up properly any more. Under this situation, the only solution is to [clear CMOS](#).

Integrated Peripherals > Hot Key Power On

Hot Key Power On

Ctrl-F1, Ctrl-F2, Ctrl-F3,
Ctrl-F4, Ctrl-F5, Ctrl-F6,
Ctrl-F7, Ctrl-F8, Ctrl-F9,
Ctrl-F10, Ctrl-F11,
Ctrl-F12

If you select "Hot Key" option in "[Power On Function](#)" Item, you need to specify a hot key here.

Integrated Peripherals > AC PWR Auto Recovery

AC PWR Auto Recovery

Former-Sts

On

Off

A traditional ATX system should remain at power off stage when AC power resumes from power failure. This design is inconvenient for a network server or workstation, without an UPS, that needs to keep power-on. This item is used to solve this problem. Selecting On enabling system to automatically power-on after AC power resumes; in the other hand, the system will remain power-off if you select Off. If Former-Sts (former status) option is selected, the system will power-on or power-off based on the original state.

Integrated Peripherals > Onboard FDC Controller

Onboard FDC Controller

Enabled

Disabled

Setting this parameter to **Enabled** allows you to connect your floppy disk drives to the onboard floppy disk connector instead of a separate controller card. Change the setting to Disabled if you want to use a separate controller card.

Integrated Peripherals > Onboard Serial Port 1**Integrated Peripherals > Onboard Serial Port 2****Onboard Serial Port 1**

Auto

3F8/IRQ4

2F8/IRQ3

3E8/IRQ4

2E8/IRQ3

Disabled

This item allow you to assign address and interrupt for the board serial port. Default is **Auto**.



Note: *If you are using network card, make sure that the IRQ do not conflict.*

Integrated Peripherals > UART Mode Select

UART Mode Select

Standard

HPSIR

ASKIR

This item is configurable only if the "[Onboard Serial Port 2](#)" is enabled. This allows you to specify the mode of serial port2. The available mode selections are:

Standard

Sets serial port 2 to operate in normal mode. This is the default setting.

HPSIR

This setting allows infrared serial communication at a maximum baud rate of 115K baud.

SASKIR

This setting allows infrared serial communication at a maximum baud rate of 19.2K baud.

Integrated Peripherals > RxD, TxD Active

RxD, TxD Active

Hi, Hi
Hi, Lo,
Lo, Hi
Lo, Lo

This item is used to select RxD (Receive Data) and TxD (Transmit Data) mode for UART, for instance, IR device, modem, etc. Normally, we suggest you keep the default setting. Please see the documentation that comes with your device.

Integrated Peripherals > IR Transmission Delay

IR Transmission Delay

Enabled
Disabled

If Enabled is selected, there will be a 4 character delay when SIR is changed from TX mode to RX mode.

Integrated Peripherals > Onboard Parallel Port

Onboard Parallel Port

3BC/IRQ7

378/IRQ7

278/IRQ5

Disabled

This item controls the onboard parallel port address and interrupt.



Note: *If you are using an I/O card with a parallel port, make sure that the addresses and IRQ do not conflict.*

Integrated Peripherals > Parallel Port Mode

Parallel Port Mode

SPP, EPP, ECP,
ECP + EPP

This item lets you set the parallel port mode. The mode options are SPP (Standard and Bidirection Parallel Port), EPP (Enhanced Parallel Port) and ECP (Extended Parallel Port).

SPP (Standard and Bidirection Parallel Port)

SPP is the IBM AT and PS/2 compatible mode.

EPP (Enhanced Parallel Port)

EPP enhances the parallel port throughput by directly writing/reading data to/from parallel port without latch.

ECP (Extended Parallel Port)

ECP supports DMA and RLE (Run Length Encoded) compression and decompression.

Integrated Peripherals > ECP Mode Use DMA

ECP Mode Use DMA

3

1

This item lets you set the DMA channel of ECP mode.

Integrated Peripherals > EPP Mode Select

EPP Mode Select

EPP1.7

EPP1.9

This item lets you select EPP mode protocol.

Password Setting

Password prevents unauthorized use of your computer. If you set a password, the system prompts for the correct password before boot or access to Setup.

To set a password:

1. At the prompt, type your password. Your password can be up to 8 alphanumeric characters. When you type the characters, they appear as asterisks on the password screen box.
2. After typing the password, press.
3. At the next prompt, re-type your password and press again to confirm the new password. After the password entry, the screen automatically reverts to the main screen.

To disable the password, press when prompted to enter the password. The screen displays a message confirming that the password has been disabled.

IDE HDD Auto Detection

If your system has an IDE hard drive, you can use this function to detect its parameters and enter them into the "Standard CMOS Setup" automatically.

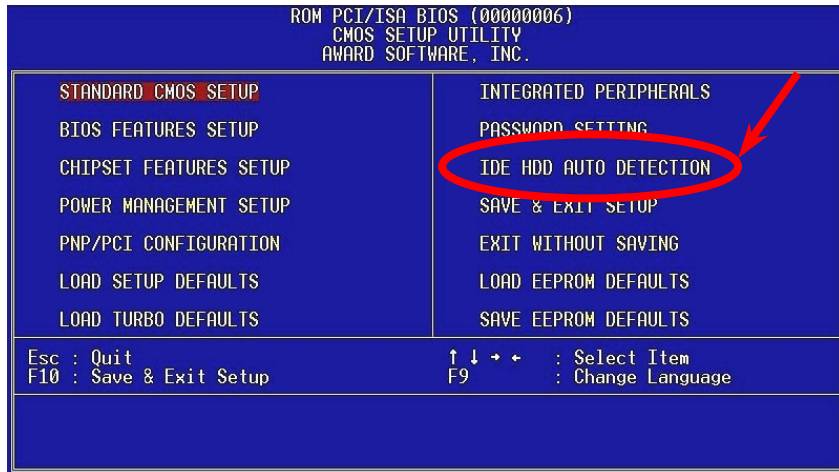

This routine only detects one set of parameters for your IDE hard drive. Some IDE drives can use more than one set of parameters. If your hard disk is formatted using different parameters than those detected, you have to enter the parameters manually. If the parameters listed do not match the ones used to format the disk, the information on that disk will not be accessible. If the auto-detected parameters displayed do not match those that used for your drive, ignore them. Type **N** to reject the values and enter the correct ones manually from the Standard CMOS Setup screen.

Save & Exit Setup

This function automatically saves all CMOS values before leaving Setup.

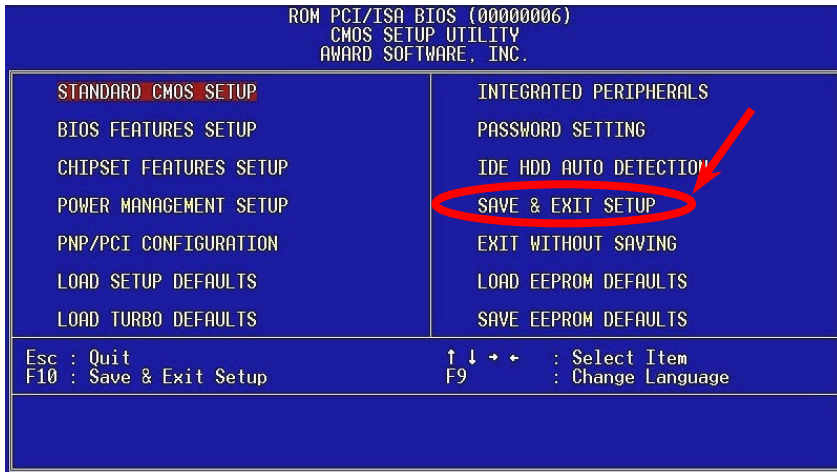

Load EEPROM Default

Except "Load Setup Default" and "Load Turbo Default", you may also use "Save EEPROM Default " to save your own settings into [EEPROM](#), and reload by using this item.

Save EEPROM Default

You may use this item to save your own settings into [EEPROM](#). Then, if the data in CMOS is lost or you forget the previous settings, you may use "Load EEPROM Default " to reload.

Exit without Saving

Use this function to exit Setup without saving the CMOS value changes. Do not use this option if you want to save the new configuration.

NCR SCSI BIOS and Drivers

Due to [Flash ROM](#) space limitation, some BIOS versions do not include NCR 53C810 SCSI BIOS (supports DOS, Windows 3.1 and OS/2) into the system BIOS. Many SCSI cards have its own SCSI BIOS on card, for better system performance, you may use the drivers that come with the NCR SCSI card or with your operating system. For details, refer to the installation manual of your NCR 53C810 SCSI card.

BIOS Upgrade

AOpen Easy Flash is more user friendly than traditional flash method. The [BIOS](#) binary file and flash routine are combined together and you simply run a single file to complete the flash process.

1. Get new BIOS upgrade program from AOpen's web site. For example, 6BCP201.EXE. It is recommended to save it to a bootable DOS floppy diskette for error recovery.
2. Reboot the system to DOS mode without loading any memory handler (such as EMM386) or device driver. It needs around 520K free memory space.
3. Execute A:> 6BCP201

DO NOT turn off the power during FLASH PROCESS.

Del

4. Reboot system and press to [enter BIOS setup](#). Choose "[Load Setup Defaults](#)", then "[Save & Exit Setup](#)". Done!



Warning: The upgrade of new BIOS will permanently replace your original BIOS content after flashing. The original BIOS setting and Win95/Win98 PnP information will be refreshed and you probably need to re-configure your system.

Overclocking

As a leading manufacturer in motherboard industry, AOpen always listens to what customers want and develop products to fit different user's requirements. Reliability, compatibility, leading technology and friendly features are our basic goals when designing motherboards. Other than above mentioned design criteria, there are power users who are always seeking to push the limitation of the system performance by overclocking which we call them "Overclocker".

This section is dedicated to Overclockers.

This high performance motherboard is designed for maximum **100MHz** CPU bus clock. But it comes with clock generator of **153MHz** when we design it to accommodate future CPU bus clock. Our lab test results shown that **133.3MHz** is achievable when proper setting and qualified components were presented, we feel quite comfortable overclocking to 133.3MHz. Not only that, this motherboard has full-range (CPU core voltage) settings and an option to adjust CPU core voltage. The CPU clock ratio can be up to 8X, that supports almost all of Pentium II / Pentium III / Celeron CPUs in the future and provides flexibility for overclockers. For your reference, the following configurations are what we feel comfortable at 133.3 MHz bus clock.

But not guaranty. 😊



Warning: *The design of this product follows CPU and chipset vendor's design guideline. Any attempts to push beyond product specification are not recommended and you are taking your own risk to damage your system or important data. Before doing overclocking, you must make sure your components are able to tolerate such abnormal setting, especially CPU, DRAMs, hard disks, and AGP VGA cards.*



Tip: *Note that overclocking may also cause thermal problem. Please make sure that the cooling fan and the heatsink were adequate to dissipate excessive heat that's generated by overclocking the CPU.*

VGA and HDD are key components for overclocking, for your reference, the following list are what have been successful overclocked in our lab. Please note that AOpen can not guaranty they can be successful overclocked again.

VGA Card

VGA model/ Vendor	Chipset model	Driver
Asus	S3 –Virge/dx(86c375)	Asus
VENUS T-775	S3 Trio 64V2(86C775)	Venus
VENUS 67TV	Trident 9685	Venus
GALAXIE	Trident 9685 (PS-68)	Venus
ATI	MACH 64 210888GX00	Win95 default
MATROX	MY220P/4+	MGA
MATROX	MGA-MIL/4+	MGA
MATROX	MIL2P/4+	MGA

Hard Disk

Vender	Model	Size
Maxtor	90680D4	6.8G
Maxtor	90845D5	8.4G
Maxtor	72004AP	2.0G
Maxtor	82560A4	2.5G
Seagate	ST36530A	6.5G
Seagate	ST31277A	1.2G
Quantum	FireballST4320AT	4.3G
Quantum	T-Rex Bigfoot TX6.0AT	6.0G
Quantum	T-Rex Bigfoot TX8.0AT	8.0G
Quantum	T-Rex Bigfoot TX12.0AT	12.0G

IBM	DHEA-34330	4.3G
IBM	DTTA-351010	10.1G
IBM	DTTA-350840	8.4G
IBM	DTTA-350640	6.4G
IBM	DAQA-32160	2.1G

Recommended Overclocking Settings

The following table lists the overclocking settings in AOpen's lab for your reference.

CPU	Pentium II 350
DRAM	ISEC KOREA 752 KM48S8030BT-GH 32MB
HDD	IBM DHEA-34330
VGA	ATI 3D RAGE PRO AGP 2X
OS	Windows 95 OSR2
BIOS	Load BIOS Turbo Default 100 MHz * 4 = 400 MHz (OK) 112 MHz * 3.5 = 392 MHz (OK) 133.3MHz * 3 = 400 MHz (OK)

Glossary

ACPI (Advanced Configuration & Power Interface)

ACPI is the power management specification of PC97 (1997). It intends to save more power by taking full control of power management to operating system and bypass [BIOS](#). The chipset or super I/O chip needs to provide standard register interface to operating system (such as Windows 98). This is a bit similar as the [PnP](#) register interface. ACPI defines ATX momentary soft power switch to control the power state transition.

AGP (Accelerated Graphic Port)

AGP is a bus interface targeted for high-performance 3D graphic. AGP supports only memory read/write operation and single-master single-slave one-to-one only. AGP uses both rising and falling edge of the 66MHz clock, for 2X AGP, the data transfer rate is $66\text{MHz} \times 4\text{byte} \times 2 = 528\text{MB/s}$. AGP is now moving to 4X mode, $66\text{MHz} \times 4\text{byte} \times 4 = 1056\text{MB/s}$. AOpen is the first company to support 4X AGP motherboards by both AX6C (Intel 820) and MX64/AX64 (VIA 694x), started from Oct 1999.

AOpen Bonus Pack CD

A disc bundled with AOpen motherboard product, there are motherboard drivers, Acrobat Reader for [PDF](#) online manual and other useful utilities.

APM

Unlike [ACPI](#), BIOS controls most APM power management functions. AOpen Suspend to Hard Drive is a good example of APM power management.

ATA/66

ATA/66 uses both rising edge and falling edge but doubles [UDMA/33](#) transfer rate. The data transfer rate is 4 times of the PIO mode 4 or DMA mode 2, 16.6MB/s x4 = 66MB/s. To use ATA/66, you need special ATA/66 IDE cable.

BIOS (Basic Input/Output System)

BIOS is a set of assembly routine/program that reside in [EPROM](#) or [Flash ROM](#). BIOS controls Input/output devices and other hardware devices of motherboard. In general, to provide hardware independent portability, operation system and drivers is required to access BIOS without directly access hardware devices.

Bus Master IDE (DMA mode)

The traditional PIO (Programmable I/O) IDE requires the CPU to involve in all the activities of the IDE access including waiting for the mechanical events. To reduce the workload of the CPU, the bus master IDE device transfers data from/to memory without interrupting CPU, and releases CPU to operate concurrently while data is transferring between memory and IDE device. You need the bus master IDE driver and the bus master IDE HDD to support bus master IDE mode.

DIMM (Dual In Line Memory Module)

DIMM socket has total 168-pin and supports 64-bit data. It can be single or double side, the golden finger signals on each side of PCB are different, that is why it was called Dual In Line. Almost all DIMMs are made by [SDRAM](#), which operate at 3.3V. Note that some old DIMMs are made by FPM/[EDO](#) and only operate at 5V. Do not confuse them with SDRAM DIMM..

ECC (Error Checking and Correction)

The ECC mode needs 8 ECC bits for 64-bit data. Each time memory is accessed, ECC bits are updated and checked by a special algorithm. The ECC algorithm has the ability to detect double-bit error and automatically correct single-bit error while parity mode can only detect single-bit error.

EDO (Extended Data Output) Memory

The EDO DRAM technology is actually very similar to FPM (Fast Page Mode). Unlike traditional FPM that tri-states the memory output data to start the pre-charge activity, EDO DRAM holds the memory data valid until the next memory access cycle, that is similar to pipeline effect and reduces one clock state.

EEPROM (Electronic Erasable Programmable ROM)

Also known as E²PROM. Both EEPROM and [Flash ROM](#) can be re-programmed by electronic signals, but the interface technology is different. Size of EEPROM is much smaller than flash ROM, AOpen motherboard uses EEPROM for jumper-less and battery-less design.

EPROM (Erasable Programmable ROM)

Traditional motherboard stores BIOS code in EPROM. EPROM can only be erased by ultra-violet (UV) light. If BIOS has to be upgraded, you need to remove EPROM from motherboard, clear by UV light, re-program, and then insert back.

FCC DoC (Declaration of Conformity)

The DoC is component certification standard of FCC EMI regulations. This standard allows DIY component (such as motherboard) to apply DoC label separately without a shielding of housing.

Flash ROM

Flash ROM can be re-programmed by electronic signals. It is easier for BIOS to upgrade by a flash utility, but it is also easier to be infected by virus. Because of increase of new functions, BIOS size is increased from 64KB to 256KB (2M bit). AOpen AX5T is the first board to implement 256KB (2Mbit) Flash ROM. Now flash ROM size is moving to 4M bit on AX6C (Intel 820) and MX3W (Intel 810) motherboard.

FSB (Front Side Bus) Clock

FSB Clock means CPU external bus clock.

CPU internal clock = CPU FSB Clock x CPU Clock Ratio

I2C Bus

See [SMBus](#).

P1394

P1394 (IEEE 1394) is a standard of high-speed serial peripheral bus. Unlike low or medium speed [USB](#), P1394 supports 50 to 1000Mbit/s and can be used for video camera, disk and LAN.

PBSRAM (Pipelined Burst SRAM)

For Socket 7 CPU, one burst data read requires four QWord (Quad-word, $4 \times 16 = 64$ bits). PBSRAM only needs one address decoding time and automatically sends the remaining QWords to CPU according to a predefined sequence. Normally, it is 3-1-1-1, total 6 clocks, which is faster than asynchronous SRAM. PBSRAM is often used on L2 (level 2) cache of Socket 7 CPU. Slot 1 and Socket 370 CPU do not need PBSRAM.

PC100 DIMM

[SDRAM](#) DIMM that supports 100MHz CPU [FSB](#) bus clock.

PC133 DIMM

[SDRAM](#) DIMM that supports 133MHz CPU [FSB](#) bus clock.

PDF Format

A file format for electronic document, PDF format is independent from platform, you can read PDF file under Windows, Unix, Linux, Mac ... with different PDF reader. You can also read PDF file by web browser such as IE and Netscape, note that you need to install PDF plug-in first (Included in Acrobat Reader).

PnP (Plug and Play)

The PnP specification suggests a standard register interface for both BIOS and operating system (such as Windows 95). These registers are used by BIOS and operating system to configure system resource and prevent any conflicts. The IRQ/DMA/Memory will be automatically allocated by PnP BIOS or operating system. Currently, almost all the PCI cards and most ISA cards are already PnP compliant.

POST (Power-On Self Test)

The BIOS self test procedure after power-on, sometimes, it is the first or the second screen shown on your monitor during system boot.

RDRAM (Rambus DRAM)

Rambus is a memory technology that uses large burst mode data transfer. Theoretically, the data transfer should be high than [SDRAM](#). RDRAM is cascaded in channel operation. For Intel 820, only one RDRAM channel is supported, 16-bit data per channel, and this channel may have maximum 32 RDRAM devices, no matter how many [RIMM](#) sockets.

RIMM

184-pin memory module that supports [RDRAM](#) memory technology. A RIMM memory module may contain up to maximum of 16 RDRAM devices.

SDRAM (Synchronous DRAM)

SDRAM is one of the DRAM technologies that allows DRAM to use the same clock as the CPU host bus ([EDO](#) and FPM are asynchronous and do not have clock signal). It is similar as [PBRAM](#) to use burst mode transfer. SDRAM comes in 64-bit 168-pin [DIMM](#) and operates at 3.3V. AOpen is the first company to support dual-SDRAM DIMMs onboard (AP5V), from Q1 1996

SIMM (Single In Line Memory Module)

SIMM socket is only 72-pin, and is only single side. The golden finger signals on each side of PCB are identical. That is why it was called Single In Line. SIMM is made by FPM or [EDO](#) DRAM and supports 32-bit data. SIMM had been phased out on current motherboard design.

SMBus (System Management Bus)

SMBus is also called I2C bus. It is a two-wire bus developed for component communication (especially for semiconductor IC). For example, set clock of clock generator for jumper-less motherboard. The data transfer rate of SMBus is only 100Kbit/s, it allows one host to communicate with CPU and many masters and slaves to send/receive message.

SPD (Serial Presence Detect)

SPD is a small ROM or [EEPROM](#) device resided on the [DIMM](#) or [RIMM](#). SPD stores memory module information such as DRAM timing and chip parameters. SPD can be used by [BIOS](#) to decide best timing for this DIMM or RIMM.

Ultra DMA/33

Unlike traditional PIO/DMA mode, which only uses the rising edge of IDE command signal to transfer data. UDMA/33 uses both rising edge and falling edge, the data transfer rate is double of the PIO mode 4 or DMA mode 2.

16.6MB/s x2 = 33MB/s

USB (Universal Serial Bus)

USB is a 4-pin serial peripheral bus that is capable of cascading low/medium speed peripherals (less than 10Mbit/s) such as keyboard, mouse, joystick, scanner, printer and modem. With USB, the traditional complex cables from back panel of your PC can be eliminated.



Troubleshooting

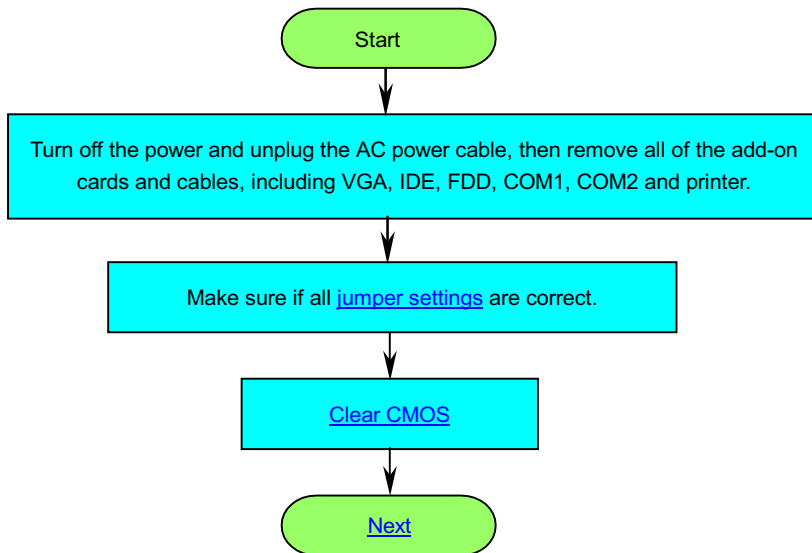

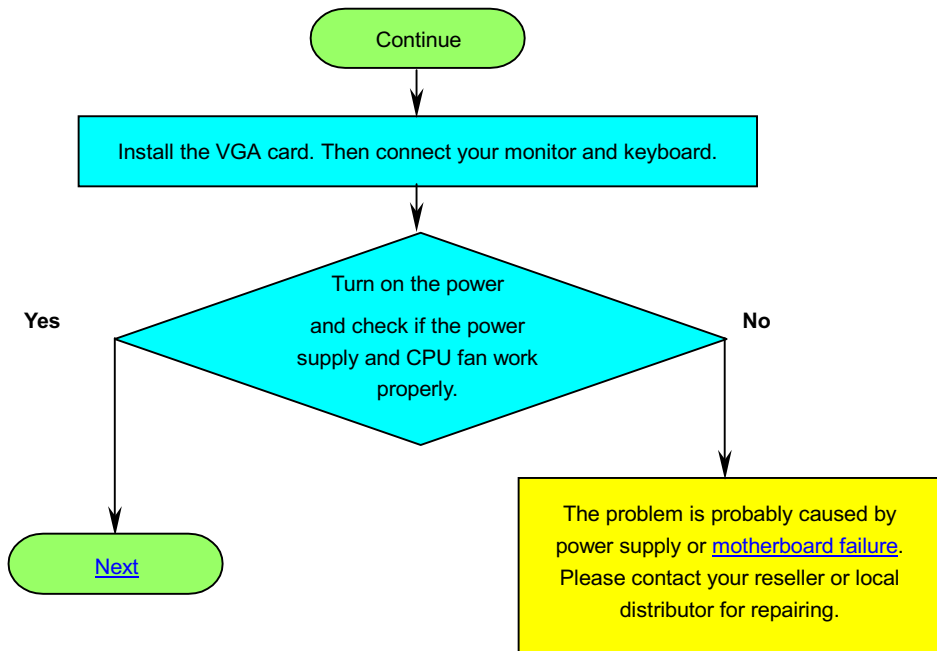

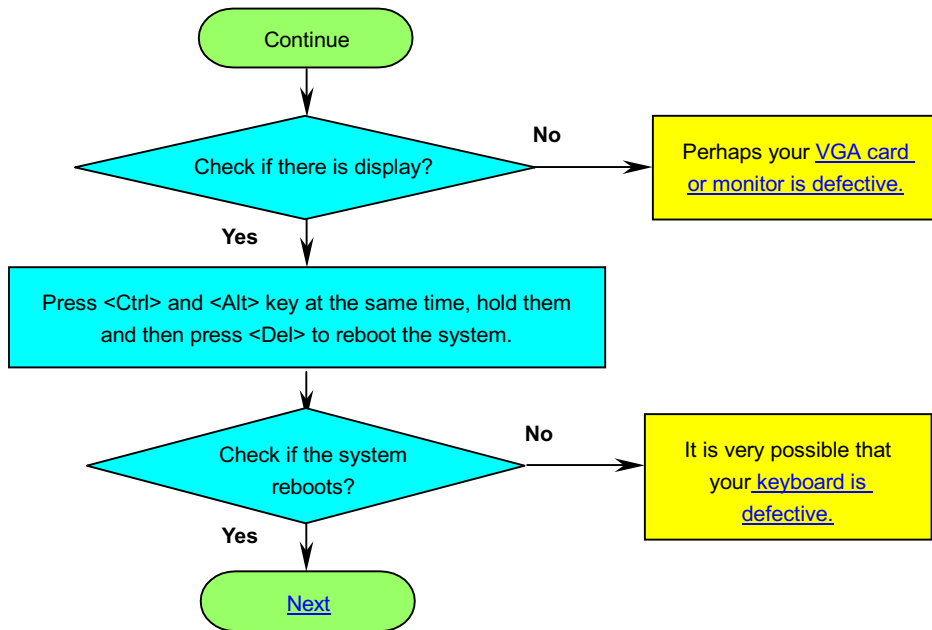

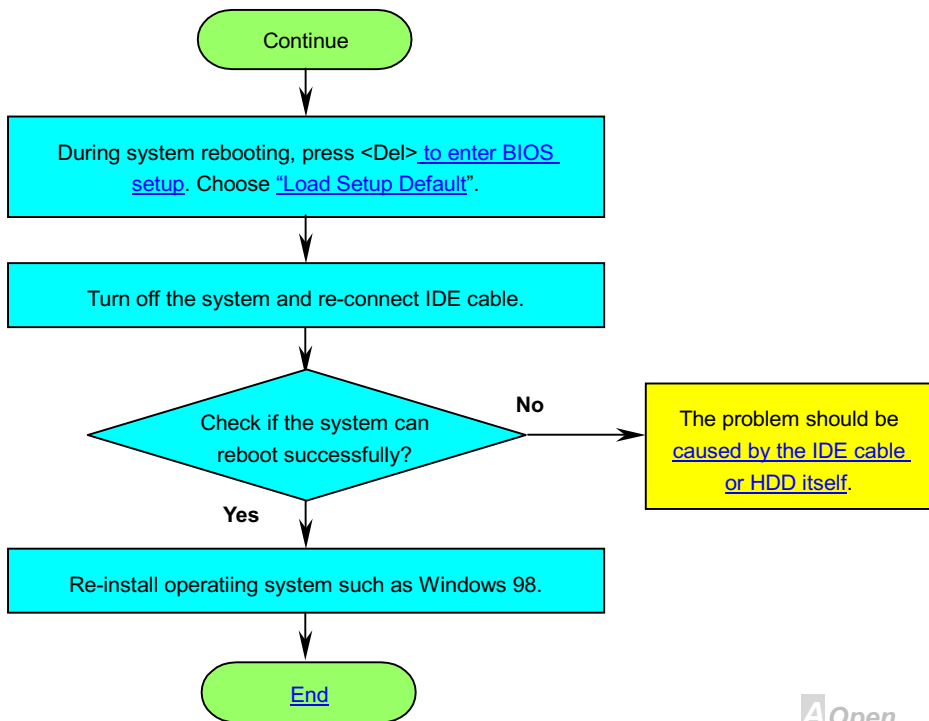



Technical Support

Dear Customer,

Thanks for choosing AOpen products. To provide the best and fastest service to our customer is our first priority. However, we receive numerous emails and phone-calls worldwide everyday, it is very hard for us to serve everyone on time. We recommend you follow the procedures below and seek help before contact us. With your help, we can then continue to provide the best quality service to more customers.

Thanks very much for your understanding!

AOpen Technical Supporting Team

1

Online Manual: Please check the manual carefully and make sure the jumper settings and installation procedure are correct.

<http://www.aopen.com.tw/tech/download/manual/default.htm>

2

Test Report: We recommend to choose board/card/device from the compatibility test reports for assembling your PC.

<http://www.aopen.com.tw/tech/report/default.htm>

3

FAQ: The latest FAQ (Frequently Asked Questions) may contain a solution to your problem.

<http://www.aopen.com.tw/tech/faq/default.htm>

4

Download Software: Check out this table to get the latest updated BIOS/utility and drivers.

<http://www.aopen.com.tw/tech/download/default.htm>

5

News Group: Your problem probably had been answered by our support engineer or professional users on the news group.

<http://www.aopen.com.tw/tech/newsgroup/default.htm>

6

Contact Distributors/Resellers: We sell our products through resellers and integrators. They should know your system configuration very well and should be able to solve your problem more efficiently than us. After all, their attitude of service is an important reference for you if next time you want to buy something else from them.

7

Contact Us: Please prepare detail system configuration and error symptom before contacting us. The **part number**, **serial number** and **BIOS version** are also very helpful.

Part Number and Serial Number

The Part Number and Serial number are printed on bar code label. You can find this bar code label on the outside packing, on ISA/CPU slot or on component side of PCB. For example:



P/N: 91.88110.201 is part number, **S/N: 91949378KN73** is serial number

Model name and BIOS version

Model name and BIOS version can be found on upper left corner of first boot screen ([POST](#) screen).

For example:

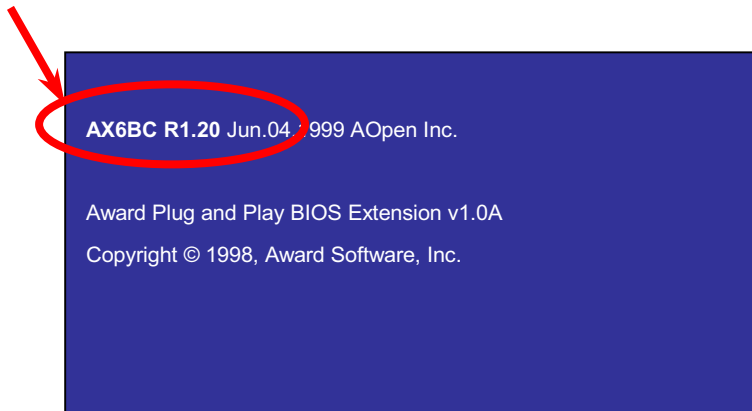

AX6BC is model name of motherboard, **R1.20** is BIOS version.

Web : <http://www.aopen.com/>

Email : Send us email by going through the contact form below.

English <http://www.aopen.com.tw/tech/contact/techusa.htm>

Japanese <http://aojp.aopen.com.tw/tech/contact/techjp.htm>

Chinese <http://w3.aopen.com.tw/tech/contact/techtw.htm>

TEL:

USA	650-827-9688
Netherlands	+31 73-645-9516
China	(86) 755-375-3013
Taiwan	(886) 2-2696-1333