

AX4PER-G

AX4PER-GN

Online Manual

DOC. NO: AX4PERGN-OL-E0302A



What's in this manual

AX4PER-G / AX4PER-GN	1
<i>What's in this manual</i>	2
<i>You Must Notice</i>	8
<i>Before You Start</i>	9
<i>Overview</i>	10
<i>Feature Highlight</i>	11
<i>Quick Installation Procedure</i>	14
<i>Motherboard Map</i>	15
<i>Block Diagram</i>	16
Hardware Installation	17
<i>About "Manufacturer Upgrade Optional" and "User Upgrade Optional"</i>	18
<i>JP14 Clear CMOS Data</i>	19
<i>CPU Installation</i>	20
<i>CPU Jumper-less Design</i>	23
<i>AOpen "Watch Dog ABS"</i>	24
<i>Setting CPU Frequency</i>	25
<i>CPU and System Fan Connector (with H/W Monitoring)</i>	27



JP28 Keyboard/Mouse Wake-up Jumper 28

DIMM Sockets 29

Front Panel Connector 31

ATX Power Connector 32

AC Power Auto Recovery 32

IDE and Floppy Connector 33

AGP (Accelerated Graphic Port) Expansion Slot 35

IrDA Connector 36

PC99 Color Coded Back Panel 37

Support 10/100 Mbps LAN onboard (For AX4PER-GN) 38

 *Support USB 2.0 Connectors* 39

Game Port Bracket Supported 40

Case Open Connector 41

CD Audio Connector 42

Front Audio Connector 43



Battery-less and Long Life Design 44

CPU Over-current Protection 45

Hardware Monitoring 46

 *AOConfig Utility* 47



2200µF Low ESR Capacitor	49
Layout (Frequency Isolation Wall)	50
Enlarged Aluminum Heatsink	51
Wake On Modem / Wake On LAN / Wake On PCI Card	52
 Open JukeBox Player.....	53
 Vivid BIOS technology.....	57
Driver and Utility	58
Auto-run Menu from Bonus CD	58
Installing Intel® Chipset Software Installation Utility	59
Installing Intel IAA Driver.....	60
Installing Onboard Sound Driver	61
Installing LAN Driver (For AX4PER-GN).....	62
Installing USB 2.0 Driver.....	66
Phoenix-AWARD BIOS.....	71
How To Use Phoenix-Award™ BIOS Setup Program	72
How To Enter BIOS Setup.....	74
 BIOS Upgrade under Windows environment	75
Glossary	77
AC97 CODEC	77



<i>ACPI (Advanced Configuration & Power Interface)</i>	77
<i>ACR (Advanced Communication Riser)</i>	77
<i>AGP (Accelerated Graphic Port)</i>	78
<i>AMR (Audio/Modem Riser)</i>	78
<i>ATA (AT Attachment)</i>	78
<i>BIOS (Basic Input/Output System)</i>	79
<i>Bluetooth</i>	79
<i>CNR (Communication and Networking Riser)</i>	80
<i>DDR (Double Data Rate) RAM</i>	80
<i>ECC (Error Checking and Correction)</i>	80
<i>EEPROM (Electronic Erasable Programmable ROM)</i>	80
<i>EPROM (Erasable Programmable ROM)</i>	81
<i>EV6 Bus</i>	81
<i>FCC DoC (Declaration of Conformity)</i>	81
<i>FC-PGA (Flip Chip-Pin Grid Array)</i>	81
<i>FC-PGA2 (Flip Chip-Pin Grid Array)</i>	81
<i>Flash ROM</i>	82
<i>Hyper Threading</i>	82
<i>IEEE 1394</i>	82

Parity Bit 83

PCI (Peripheral Component Interface) Bus 83

PDF Format..... 83

PnP (Plug and Play)..... 83

POST (Power-On Self Test) 84

PSB (Processor System Bus) Clock..... 84

RDRAM (Rambus Dynamic Random Access Memory)..... 84

RIMM (Rambus Inline Memory Module) 84

SDRAM (Synchronous DRAM)..... 84

SATA (Serial ATA) 85

SMBus (System Management Bus)..... 85

SPD (Serial Presence Detect)..... 85

USB 2.0 (Universal Serial Bus) 85

VCM (Virtual Channel Memory)..... 86

Wireless LAN – 802.11b..... 86

ZIP file..... 86

Troubleshooting..... **87**

Technical Support **91**

Product Registration **94**



How to Contact Us95

You Must Notice



Adobe, the Adobe logo, Acrobat is trademarks of Adobe Systems Incorporated.

AMD, the AMD logo, Athlon and Duron are trademarks of Advanced Micro Devices, Inc.

Intel, the Intel logo, Intel Celeron, Pentium II, Pentium III, Pentium 4 are trademarks of Intel Corporation.

Microsoft, Windows, and Windows logo are either registered trademarks or trademarks of Microsoft Corporation in the United States and/or other countries.

All product and brand names used on this manual are used for identification purposes only and may be the registered trademarks of their respective owners.

All of the specifications and information contained in this manual are subject to change without notice. AOpen reserves the right to revise this publication and to make reasonable changes. AOpen assumes no responsibility for any errors or inaccuracies that may appear in this manual, including the products and software described in it.

This documentation is protected by copyright law. All rights are reserved.

No part of this document may be used or reproduced in any form or by any means, or stored in a database or retrieval system without prior written permission from AOpen Corporation.

Copyright© 1996-2003, AOpen Inc. All Rights Reserved.



Before You Start

This Online Manual will introduce to the user how this product is installed. All useful information will be described in later chapters. Please keep this manual carefully for future upgrades or system configuration changes. This Online Manual is saved in [PDF format](#), we recommend using Adobe Acrobat Reader 5.0 for online viewing, it is included in Bonus CD disc or you can get free download from [Adobe web site](#).

Although this Online Manual is optimized for screen viewing, it is still capable for hardcopy printing, you can print it by A4 paper size and set 2 pages per A4 sheet on your printer. To do so, choose **File > Page Setup** and follow the instruction of your printer driver.

Thanks for the help of saving our earth.

Overview

Thank you for choosing AOpen AX4PER-G / AX4PER-GN motherboard. The AX4PER-G / AX4PER-GN is Intel® Socket 478 motherboard (M/B) based on the ATX form factor featuring the [Intel® 845PE chipset](#). As high performance chipset built in the M/B, the AX4PER-G / AX4PER-GN motherboard can support Intel® Socket 478 Pentium® 4 533 MHz [Front Side Bus \(FSB\)](#) clock. In the AGP performance, it has one 1.5V AGP interface with 4x SBA/Data Transfer and 4x Fast Write capability and pipelined spilt-transaction long burst transfer up to 1056MB/sec. According to different customer's requirements, the Intel 845PE chipset memory interface supports DDR333/266 SDRAM devices with densities of 64, 128, 256, 512Mb DDR SDRAM DIMM modules and the maximum memory size can be up to 2 GB. The onboard IDE controller supports [Ultra DMA 33/66/100](#) mode and the transfer rate up to 100MB/s. More than that, on the strength of RealTek RTL8101L controller (for AX4PER-GN) on board, which is a highly-integrated Platform LAN Connect device, it provides 10/100M bps Ethernet for office and home use. Besides, the AX4PER-G / AX4PER-GN has an [AC97 CODEC](#) chipset onboard, providing high performance and magic surround stereo sound to let people enjoy working with it. Now, let's enjoy all features from AOpen AX4PER-G / AX4PER-GN motherboard.

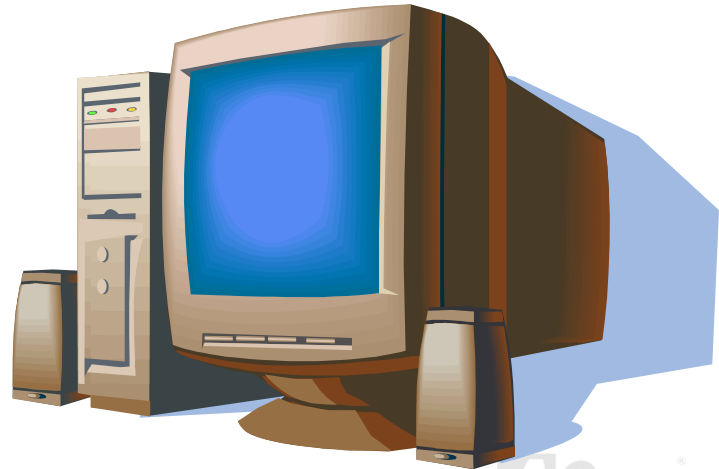

AOpen

Feature Highlight

CPU

Supports Intel® Socket 478 Pentium® 4 1.4GHz~3.06GHz+ with 533MHz [Front Side Bus \(FSB\)](#) designed for Socket 478 technology.

Chipset

The 845PE chipset contains two core components designed for the desktop platform: the 845PE Graphics Memory Controller Hub (GMCH), and the Intel I/O Controller Hub 4 (ICH4). These components are interconnected via an Intel proprietary interface called Hub Interface. The Hub Interface is designed into the 845PE chipset to provide an efficient, high bandwidth communication channel between the GMCH and the ICH4. The GMCH component provides the processor interface, system memory interface, Hub interface, AGP interface, and an integrated graphics device with analog and digital display ports. The ICH4 integrates a Universal Serial Bus 2.0 controller, Ultra ATA/100 Controller, Low Pin Count interface, Firmware Hub Flash BIOS interface controller, PCI interface controller, integrated LAN, AC'97 digital controller, and a Hub Interface for communication with the GMCH.

Expansion Slots

Including six 32-bit/33MHz [PCI](#) and one AGP 4X slots. The [PCI](#) local bus throughput can be up to 132MB/s. For [AGP](#) performance, it has one 1.5V AGP interface with 4x SBA/Data Transfer and 4x Fast Write capability and pipelined spilt-transaction long burst transfer up to 1056MB/sec. Of six PCI slots provided, all of them are master PCI slots with arbitration and decoding for all integrated functions and LPC bus. However, if you enable onboard LAN, the 6th PCI slot will become a slave PCI slot.

Memory

Provide two 184-pin DDR [SDRAM](#) DIMM sockets that support up to 2GB of [DDR333/266](#) compliant DDR SDRAM (Synchronous Dynamic Random Access Memory). You may install 64, 128, 256, 512Mb DDR SDRAM DIMM modules into each socket.

LAN Port (For AX4PER-GN)

On the strength of RealTek RTL8101L controller on board, which is a highly-integrated Platform LAN Connect device, it provides 10/100 Mbps Ethernet for office and home use.

Ultra DMA 33/66/100 Bus Master IDE

Comes with an on-board PCI Bus Master IDE controller with two connectors that supports four IDE devices in two channels, supports Ultra DMA 33/66/100, PIO Modes 3 and 4 and Bus Master IDE DMA Mode 5, and supports Enhanced IDE devices.

On-board AC'97 Sound

AX4PER-G / AX4PER-GN use the [AC97](#) sound chip. This on-board audio includes a complete audio recording and playback system.

1MHz Stepping Frequency Adjustment

Provides "1MHz Stepping Frequency Adjustment" function in the BIOS. This magic function allows you adjust FSB frequency from 100~255 by 1MHz stepping adjustment, and lets your system can get maximum performance.

WatchDog ABS

Includes AOpen “WatchDog ABS” function that can auto-reset default settings in 4.8 seconds when you fail to system overclocking.

Six USB 2.0 Connectors

Provides four ports, one [USB](#) 2.0 connector for USB interface devices, such as mouse, keyboard, modem, scanner, etc. Compared to traditional USB 1.0/1.1 with the speed of 12Mbps, USB 2.0 has a fancy speed up to 480Mbps, which is 40 times faster than the traditional one.

Power Management/Plug and Play

Supports the power management function that confirms to the power-saving standards of the U.S. Environmental Protection Agency (EPA) Energy Star program. It also offers [Plug-and-Play](#), which helps save users from configuration problems, thus making the system much user-friendlier.

Hardware Monitoring Management

Supports CPU or system fans status, temperature and voltage monitoring and alert, through the on-board hardware monitor module.

Quick Installation Procedure

This page gives you a quick procedure on how to install your system. Follow each step accordingly.

1. [Installing CPU and Fan](#)
2. [Installing System Memory \(DIMM\)](#)
3. [Connecting Front Panel Cable](#)
4. [Connecting IDE and Floppy Cable](#)
5. [Connecting ATX Power Cable](#)
6. [Connecting Back Panel Cable](#)
7. [Power-on and Load BIOS Setup Default](#)
8. [Setting CPU Frequency](#)
9. Reboot
10. Installing Operating System (such as Windows XP)
11. [Installing Driver and Utility](#)

Motherboard Map

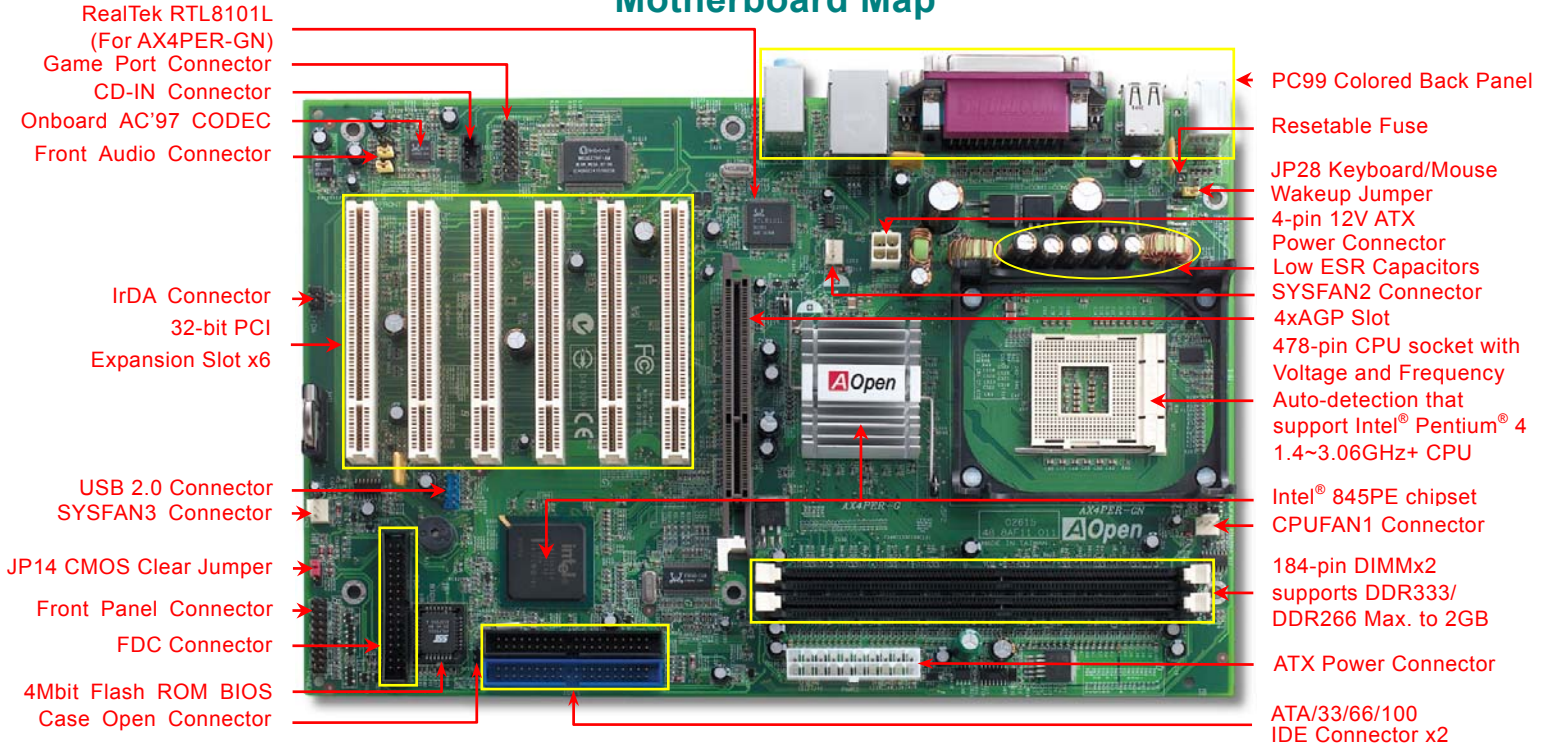

PS. Here we use AX4PER-GN motherboard as illustration.



Block Diagram

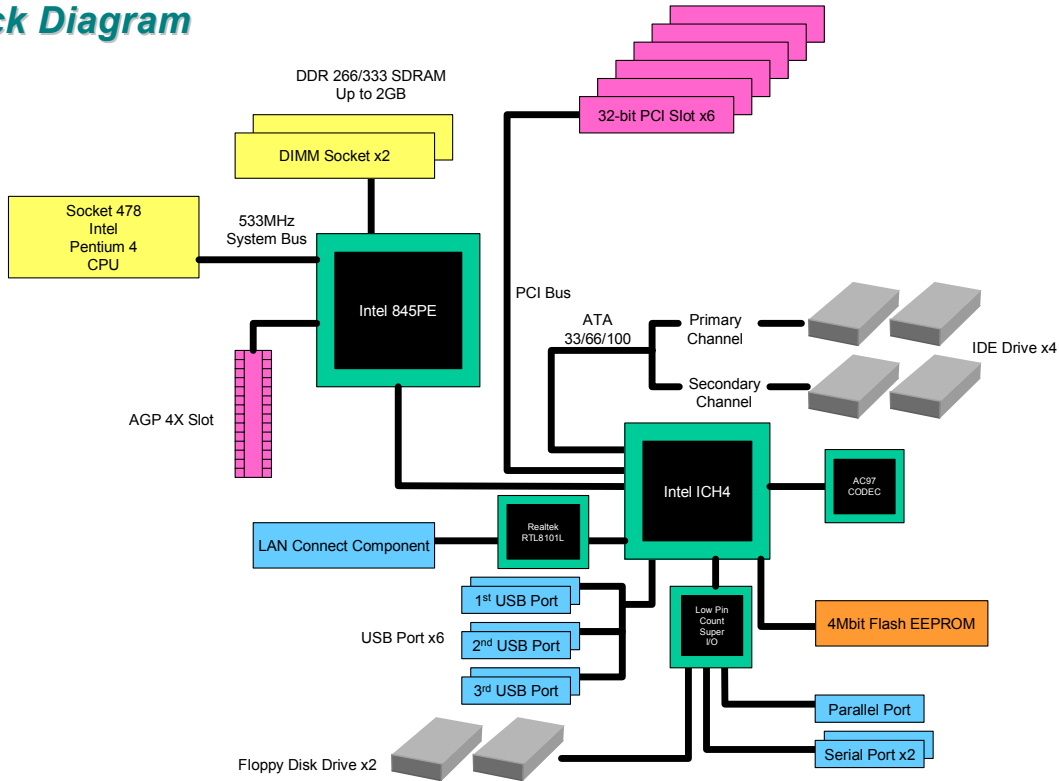

Hardware Installation

This chapter describes jumpers, connectors and hardware devices of this motherboard.



Note: *Electrostatic discharge (ESD) can damage your processor, disk drives, expansion boards, and other components. Always observe the following precautions before you install a system component.*

1. *Do not remove a component from its protective packaging until you are ready to install it.*
2. *Wear a wrist ground strap and attach it to a metal part of the system unit before handling a component. If a wrist strap is not available, maintain contact with the system unit throughout any procedure requiring ESD protection.*

About “Manufacturer Upgrade Optional” and “User Upgrade Optional”...

When you read this online manual and start to assemble your computer system, you may find some of functions are called “Manufacturer Upgrade Optional”, and some are called “User Upgrade Optional”. Though all AOpen motherboards include many amazing and powerful features, in some situations, these powerful features are not used to every user. Hence, we changed some key features as “Manufacturer Upgrade Optional” for you to choose. Some optional functions that can be upgraded by users, we call them “User Upgrade Optional”. As for those optional functions that can't be upgraded by ourselves, we call them “Manufacturer Upgrade Optional”. If needed, you can contact our local distributors or resellers for purchasing “User Upgrade Optional” components, and again you can visit AOpen official web site: www.aopen.com for more detail information.



JP14 Clear CMOS Data

You can clear CMOS to restore system default setting. To clear the CMOS, follow the procedure below.

1. Turn off the system and unplug the AC power.
2. Remove ATX power cable from connector PWR2.
3. Locate JP14 and short pins 2-3 for a few seconds.
4. Return JP14 to its normal setting by shorting pin 1 & pin2.
5. Connect ATX power cable back to connector PWR2.

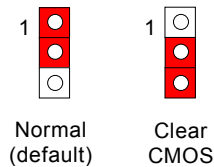
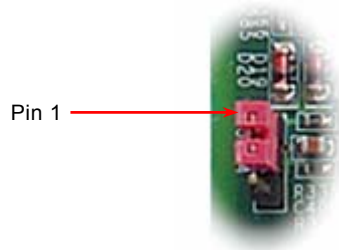

Tip: When should I Clear CMOS?

1. Boot fail because of overclocking...
2. Forget password...
3. Troubleshooting...



CPU Installation

This motherboard supports Intel® Pentium 4 Socket 478 series CPU. Be careful of CPU orientation when you plug it into CPU socket.

1. Pull up the CPU socket lever and up to 90-degree angle.

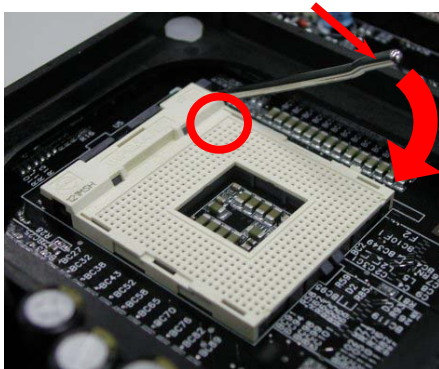

2. Locate Pin 1 in the socket and look for a cut edge on the CPU upper interface. Match Pin 1 and cut edge, then insert the CPU into the socket.

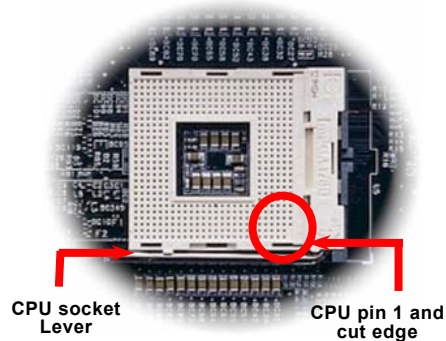

Note: These pictures are for example only; it may not exactly be the same motherboard.

3. Press down the CPU socket lever and finish CPU installation.

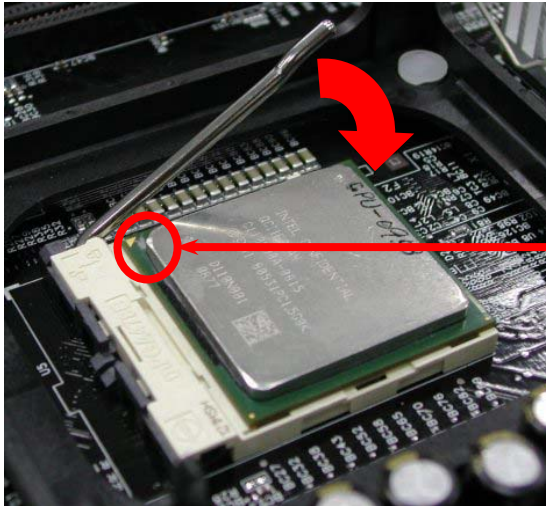

CPU cut edge

Note: If you do not match the CPU socket Pin 1 and CPU cut edge well, it may damage the CPU.

Note: This socket supports Micro-FC-PGA2 package CPU, which is the latest CPU package developed by Intel. Other forms of CPU package are impossible to be fitted in.

Note: This picture is for example only; it may not exactly be the same motherboard.

CPU Fan Installation

This motherboard comes with a retention module attached on the CPU socket when shipped, we strongly recommend you to install AOpen special designed CPU Fan as shown below on the retention module for better heat dissipation. Please install the CPU Fan correctly as the following pictures shown.

1. Gently put the CPU Fan down on the retention module with clips aligning correctly to the four corners.

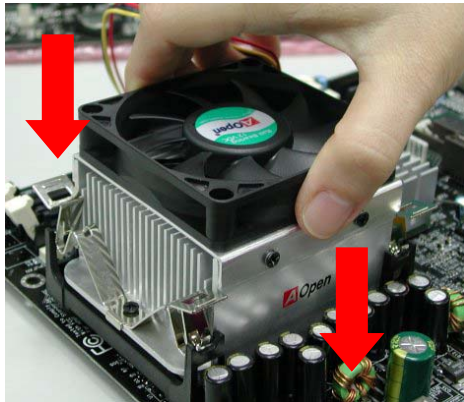

2. Pressing down the four clips with force one by one on the retention module.

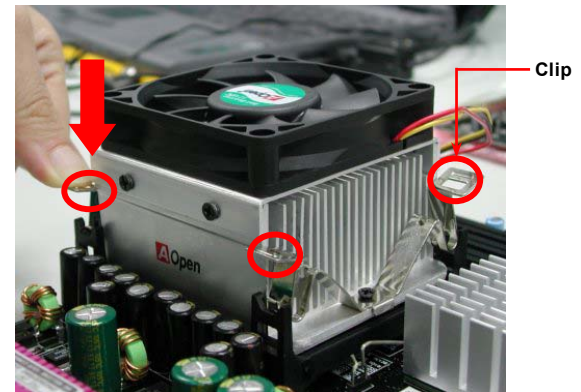

CPU Jumper-less Design

CPU VID signal and [SMBus](#) clock generator provide CPU voltage auto-detection and allows the user to set the CPU frequency through the [BIOS](#) setup, therefore no jumpers or switches are used. The disadvantages of the Pentium based jumper-less designs are eliminated. There will be no worry of wrong CPU voltage detection.

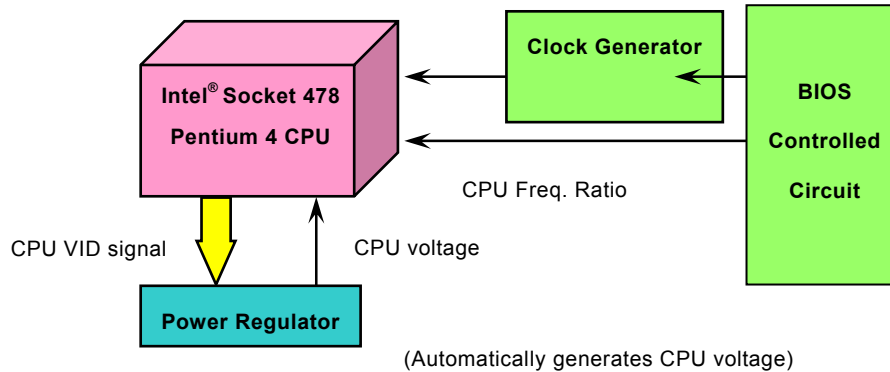

AOpen “Watch Dog ABS”



With this motherboard, AOpen provides a very special, useful feature for overclockers. When you power-on the system, the BIOS will check last system [POST](#) status. If it succeeded, the BIOS will enable “Watch Dog ABS” function immediately, and set the CPU [FSB](#) frequency by user’s setting that stored in the BIOS. If system failed in BIOS POST, the “Watch Dog ABS” will reset the system to reboot in five seconds. Then, BIOS will detect the CPU’s default frequency and POST again. With this special feature, you can easily overclock your system to get higher system performance, and without removing the cover of system housing to set the jumper to clear CMOS data when your system hanged.

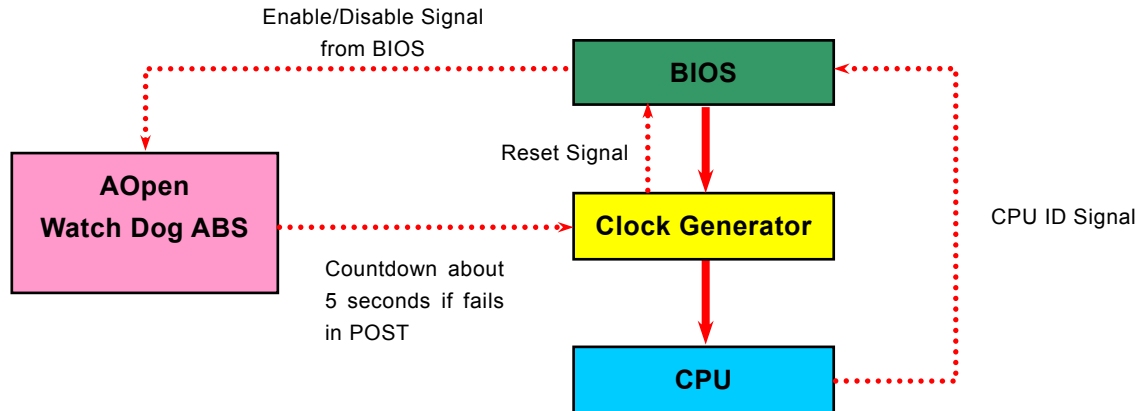

Setting CPU Frequency

BIOS Setup > Frequency/Voltage Control > CPU Frequency Setting

This motherboard is CPU jumper-less design, you can set CPU frequency through the BIOS setup, and no jumpers or switches are needed. The default setting is "table select mode". You can adjust the FSB from "CPU Host/SDRAM/PCI Clock" for overclocking.

Core Frequency = CPU FSB Clock * CPU Ratio

PCI Clock = CPU FSB Clock / Clock Ratio

AGP Clock = PCI Clock x 2

CPU Ratio	8x, 9x, 10x,...22x, 23x, 24x
CPU FSB	100~255MHz

Northwood CPU	CPU Core Frequency	FSB Clock	System Bus	Ratio
Pentium 4 1.6G	1600MHz	133MHz	533MHz	12x
Pentium 4 1.7G	1700MHz	133MHz	533MHz	13x
Pentium 4 1.8G	1800MHz	100MHz	400MHz	18x
Pentium 4 2.0G	2000MHz	100MHz	400MHz	20x
Pentium 4 2.2G	2200MHz	100MHz	400MHz	22x
Pentium 4 2.26G	2260MHz	133MHz	533MHz	17x
Pentium 4 2.4G	2400MHz	100MHz	400MHz	24x
Pentium 4 2.4G	2400MHz	133MHz	533MHz	18x
Pentium 4 2.53G	2530MHz	133MHz	533MHz	19x
Pentium 4 2.66G	2660MHz	133MHz	533MHz	20x
Pentium 4 2.8G	2800MHz	133MHz	533MHz	21x
Pentium 4 3.06G	3060MHz	133MHz	533MHz	23x

Willamette CPU	CPU Core Frequency	FSB Clock	System Bus	Ratio
Pentium 4 1.5G	1500MHz	100MHz	400MHz	15x
Pentium 4 1.6G	1600MHz	100MHz	400MHz	16x
Pentium 4 1.7G	1700MHz	100MHz	400MHz	17x
Pentium 4 1.8G	1800MHz	100MHz	400MHz	18x
Pentium 4 1.9G	1900MHz	100MHz	400MHz	19x
Pentium 4 2.0G	2000MHz	100MHz	400MHz	20x

Celeron CPU	CPU Core Frequency	FSB Clock	System Bus	Ratio
Celeron 1.7G	1700MHz	100MHz	400MHz	17x
Celeron 1.8G	1800MHz	100MHz	400MHz	18x
Celeron 2.0G	2000MHz	100MHz	400MHz	20x
Celeron 2.1G	2100MHz	100MHz	400MHz	21x

Warning: Intel® 845PE chipset supports maximum 400/533MHz (100/133MHz*4) system bus and 66MHz AGP clock; higher clock setting may cause serious system damage.

Note: Since the latest processor, Northwood, would detect the clock ratio automatically, you may not be able to adjust the clock ratio in BIOS manually.



CPU and System Fan Connector (with H/W Monitoring)

Plug in the CPU fan cable to the 3-pin **CPUFAN1** connector. If you have chassis fan, you can also plug it on **SYSFAN2** or **SYSFAN3** connector.

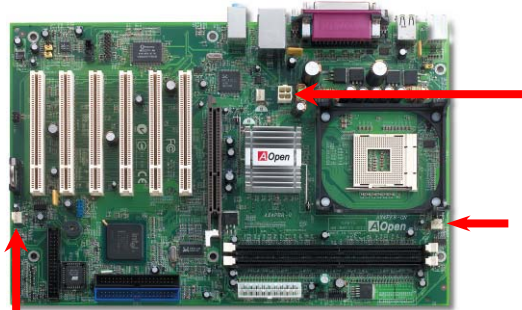

SYSFAN2 Connector

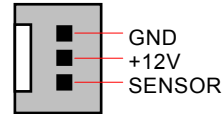

CPUFAN1 Connector

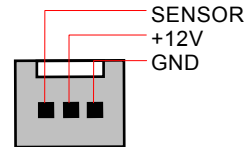

SYSFAN3 Connector

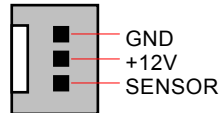

Note: Some CPU fans do not have sensor pin, so that they cannot support hardware monitoring function.

JP28 Keyboard/Mouse Wake-up Jumper

This motherboard provides keyboard / mouse wake-up function. You can use JP28 to enable or disable this function, which could resume your system from suspend mode with keyboard or mouse installed. The factory default setting is set to "Disable"(1-2), and you may enable this function by setting the jumper to 2-3.

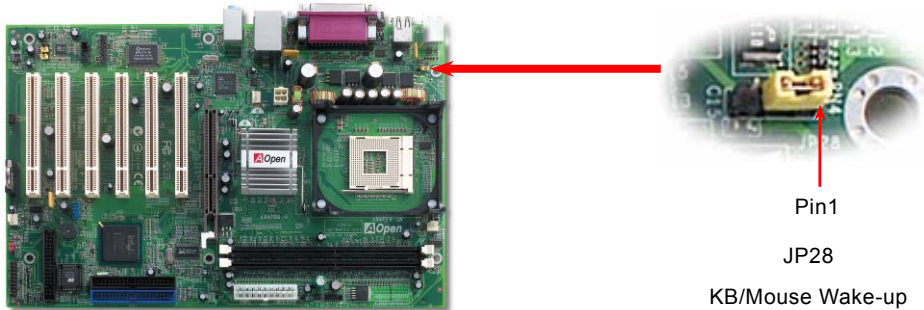

Enable



Disable
(Default)

DIMM Sockets

This motherboard has two 184-pin DDR DIMM sockets that allow you to install PC266/333 memory up to 2GB. Both ECC and Non-ECC DDR SDRAM are supported, but you can't install them both on DIMM. Otherwise, it will cause serious damage on memory sockets or SDRAM module.

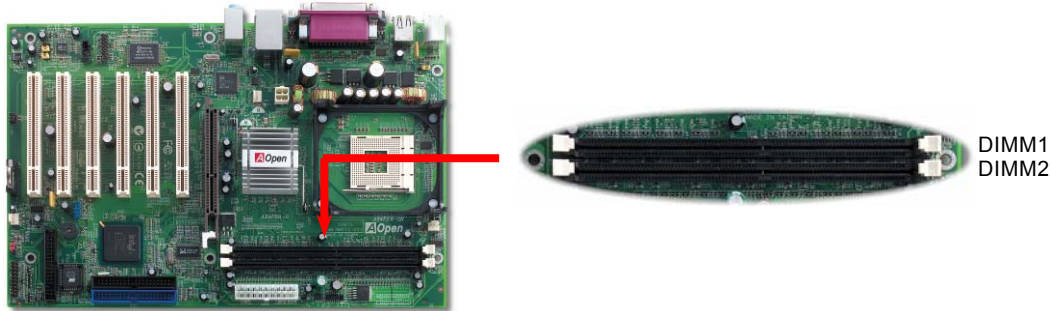

How to Install Memory Modules

Please follow the procedure as shown below to finish memory installation.

1. Make sure the DIMM module's pin face down and match the socket's size as depicted below.

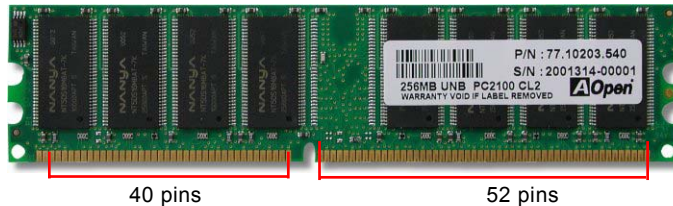

2. Insert the module straight down to the DIMM slot with both hands and press down firmly until the DIMM module is securely in place.

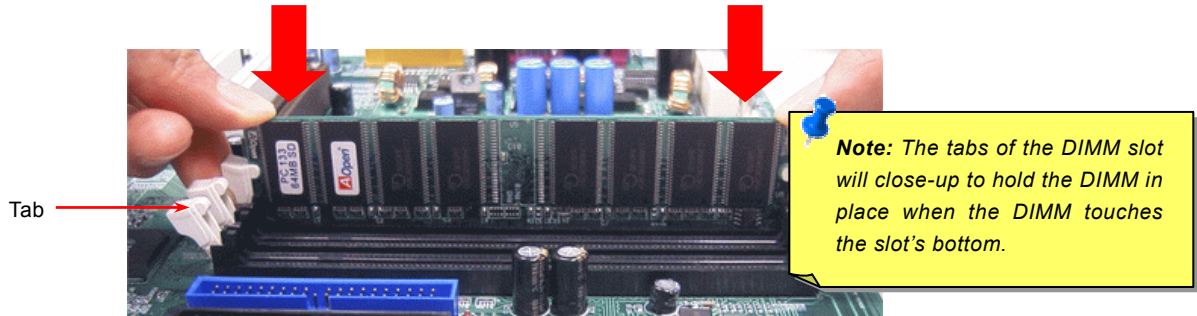

3. Repeat step 2 to finish additional DIMM modules installation.

Front Panel Connector

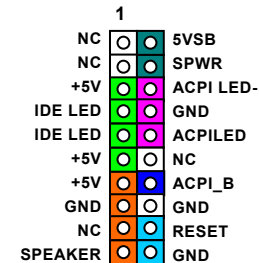
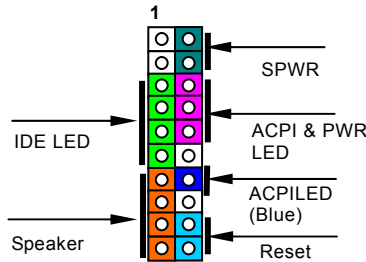
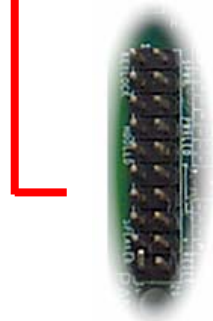
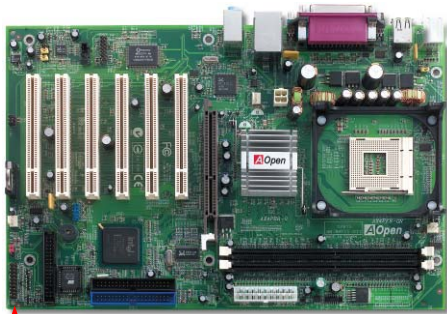

Attach the power LED, speaker, power and reset switch connectors to the corresponding pins. If you enable "Suspend Mode" item in BIOS Setup, the ACPI & Power LED will keep flashing while the system is in suspend mode.

Locate the power switch cable from your ATX housing. It is 2-pin female connector from the housing front panel. Plug this connector to the soft-power switch connector marked **SPWR**.

Suspend Type	ACPI LED
Power on Suspend (S1) or Suspend to RAM (S3)	Blinking between green and red
Suspend to Disk (S4)	The LED will be turned off

ATX Power Connector

This motherboard comes with a 20-pin and 4-pin ATX power connector. Make sure you plug in the right direction. We strongly recommend you to connect the 4-pin 12V ATX connector before connecting the 20-pin ATX power connector and use standard power supply specially designed for Pentium 4 system.

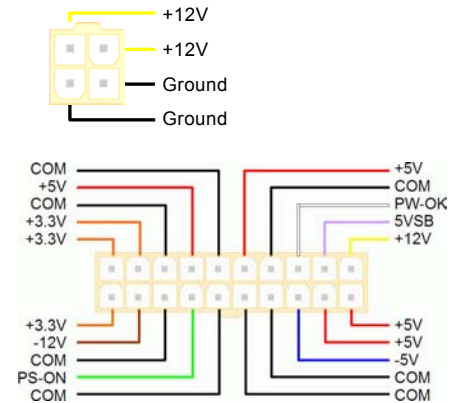
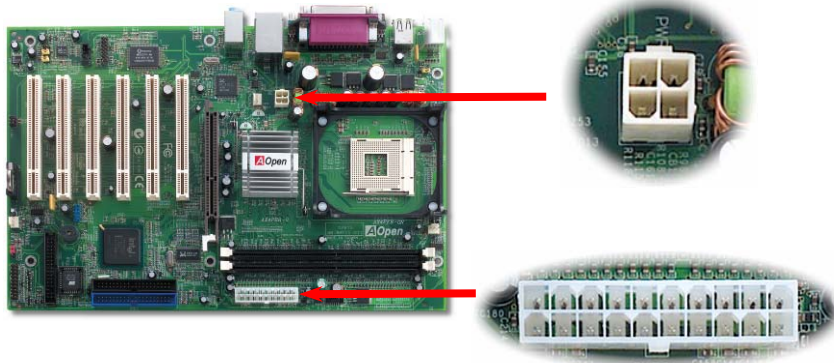

AC Power Auto Recovery

A traditional ATX system should remain at power off stage when AC power resumes from power failure. This design is inconvenient for a network server or workstation, without an UPS, that needs to keep power-on. This motherboard implements an AC Power Auto Recovery function to solve this problem.

IDE and Floppy Connector

Connect 34-pin floppy cable and 40-pin IDE cable to floppy connector FDC and IDE connector. The blue connector is IDE1 for clear identification. Be careful of the pin1 orientation. Wrong orientation may cause system damage.

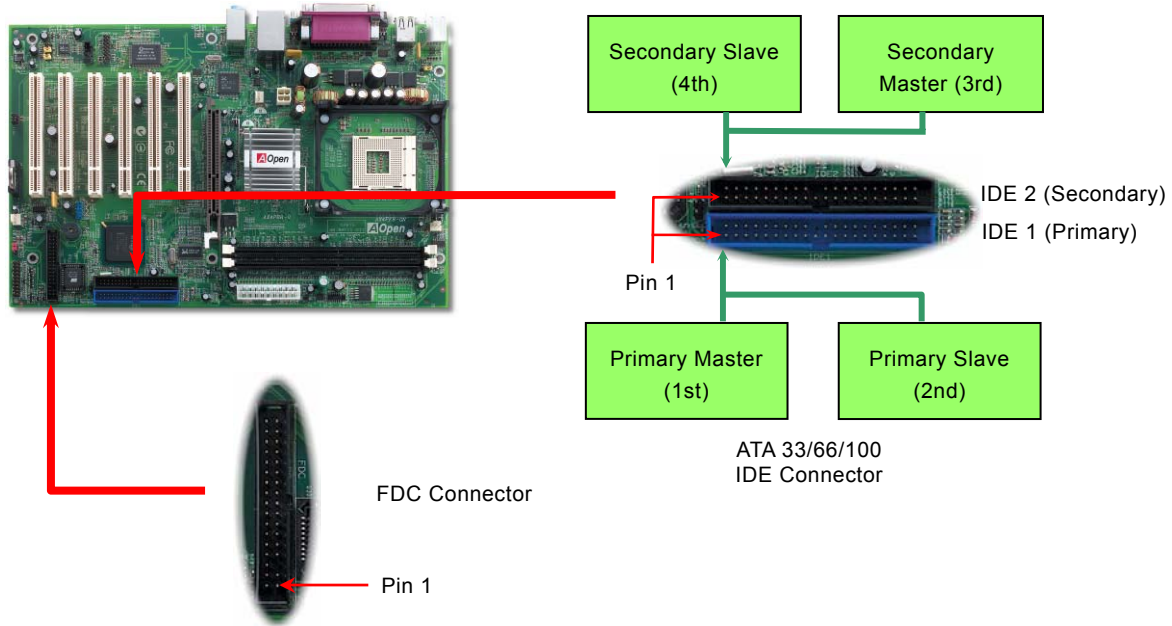

IDE1 is also known as the primary channel and IDE2 as the secondary channel. Each channel supports two IDE devices that make a total of four devices. In order to work together, the two devices on each channel must be set differently to **Master** and **Slave** mode. Either one can be the hard disk or the CDRom. The setting as master or slave mode depends on the jumper on your IDE device, so please refer to your hard disk and CDRom manual accordingly.

This motherboard supports [ATA33](#), [ATA66](#) or [ATA100](#) IDE devices. Following table lists the transfer rate of IDE PIO and DMA modes. The IDE bus is 16-bit, which means every transfer is two bytes.

Mode	Clock Period	Clock Count	Cycle Time	Data Transfer Rate
PIO mode 0	30ns	20	600ns	(1/600ns) x 2byte = 3.3MB/s
PIO mode 1	30ns	13	383ns	(1/383ns) x 2byte = 5.2MB/s
PIO mode 2	30ns	8	240ns	(1/240ns) x 2byte = 8.3MB/s
PIO mode 3	30ns	6	180ns	(1/180ns) x 2byte = 11.1MB/s
PIO mode 4	30ns	4	120ns	(1/120ns) x 2byte = 16.6MB/s
DMA mode 0	30ns	16	480ns	(1/480ns) x 2byte = 4.16MB/s
DMA mode 1	30ns	5	150ns	(1/150ns) x 2byte = 13.3MB/s
DMA mode 2	30ns	4	120ns	(1/120ns) x 2byte = 16.6MB/s
ATA 33	30ns	4	120ns	(1/120ns) x 2byte x2 = 33MB/s
ATA 66	30ns	2	60ns	(1/60ns) x 2byte x2 = 66MB/s
ATA100	20ns	2	40ns	(1/40ns) x 2byte x2 = 100MB/s

Tip:

- For better signal quality, it is recommended to set the far end side device to master mode and follow the suggested sequence to install your new device. Please refer to above diagram
- To achieve the best performance of Ultra DMA 33/66/100 hard disks, a special **80-wires IDE cable** for Ultra DMA 33/66/100 is required.

Warning: The specification of the IDE cable is a maximum of 46cm (18 inches); make sure your cable does not exceed this length.



AGP (Accelerated Graphic Port) Expansion Slot

This motherboard provides an [AGP](#) 4x slot. The AGP 4x is a bus interface targeted for high-performance 3D graphic. AGP supports only memory read/write operation and single-master single-slave one-to-one only. AGP uses both rising and falling edge of the 66MHz clock, for 2X AGP, the data transfer rate is $66\text{MHz} \times 4\text{bytes} \times 2 = 528\text{MB/s}$. AGP is now moving to AGP 4x mode, $66\text{MHz} \times 4\text{bytes} \times 4 = 1056\text{MB/s}$.

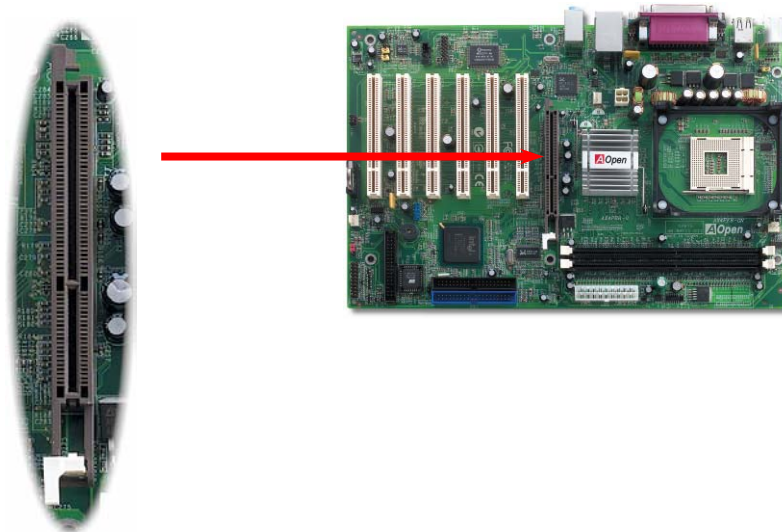

IrDA Connector

The IrDA connector can be configured to support wireless infrared module, with this module and application software such as Laplink or Windows 95 Direct Cable Connection, the user can transfer files to or from laptops, notebooks, PDA devices and printers. This connector supports HPSIR (115.2Kbps, 2 meters) and ASK-IR (56Kbps).

Install the infrared module onto the **IrDA** connector and enable the infrared function from BIOS Setup, UART Mode, make sure to have the correct orientation when you plug in the IrDA connector.

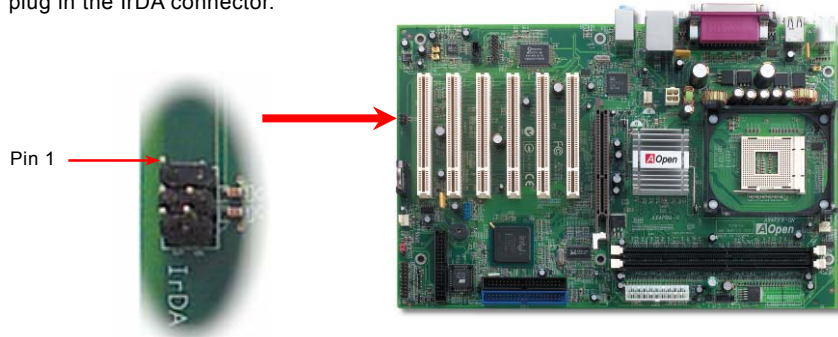

Pin 1

1

NC		KEY
+5V		GND
IR_TX		IR_RX

IrDA Connector



PC99 Color Coded Back Panel

The onboard I/O devices are PS/2 Keyboard, PS/2 Mouse, COM1, Printer, USB, AC97 sound and game ports. The view angle of drawing shown here is from the back panel of the housing.

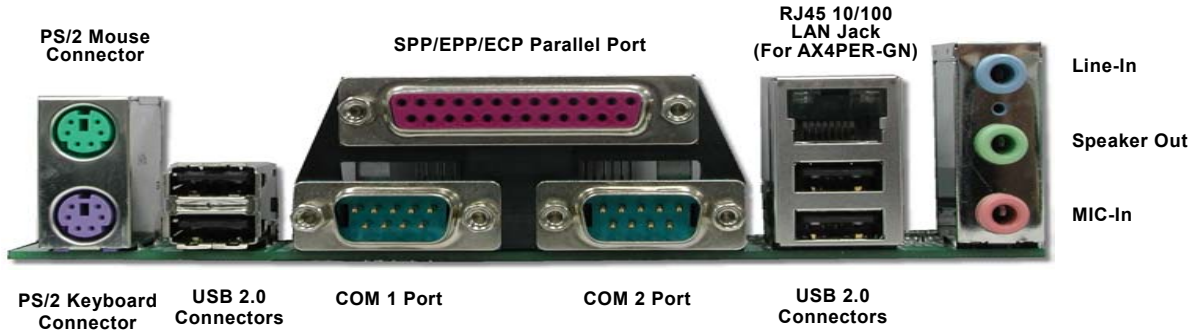

- PS/2 Keyboard:** For standard keyboard, which use a PS/2 plug.
- PS/2 Mouse:** For PC-Mouse, which use a PS/2 plug.
- USB Port:** Available for connecting USB devices.
- Parallel Port:** To connect with SPP/ECP/EPP printer.
- COM1/COM2 Port:** To connect with pointing devices, modem or others serial devices.
- Speaker Out:** To External Speaker, Earphone or Amplifier.
- Line-In:** Comes from the signal sources, such as CD/Tape player.
- MIC-In:** From Microphone.
- LAN Port:** Available for 10/100 LAN connection.

Support 10/100 Mbps LAN onboard (For AX4PER-GN)

The South Bridge ICH4 includes a fast Ethernet controller on chip. On the strength of RealTek 8100BL LAN controller on board, which is a highly-integrated Platform LAN Connect device, it provides 10/100M bps Ethernet for office and home use, the Ethernet RJ45 connector is located on top of USB connectors. The orange LED indicates the link mode, it lights when linking to network. The green LED indicates the transfer mode, and it lights when data is transferring. To enable or disable this function, you may simply adjust it through BIOS.





Support USB 2.0 Connectors

This motherboard provides six [USB 2.0](#) ports to connect USB devices such as mouse, keyboard, modem, printer, etc. There are one USB connector on the board for you to connect four USB devices and two other ports on the back panel. You can use proper cables to connect USB devices from PC99 back panel or connect the front USB connector to the front panel of chassis.

Compared to traditional USB 1.0/1.1 with the speed of 12Mbps, USB 2.0 has a fancy speed up to 480Mbps which is 40 times faster than the traditional one. Except for the speed increase, USB 2.0 supports old USB 1.0/1.1 software and peripherals, offering impressive and even better compatibility to customers. On this motherboard, all six ports support USB 2.0 function.

Pin 1



USB 2.0 Connector

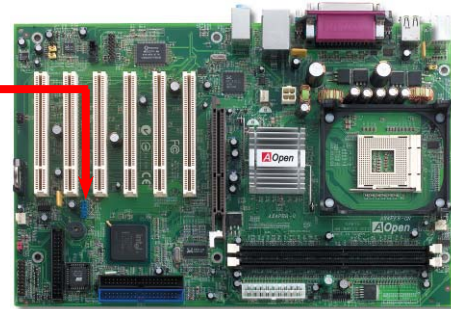

	1	
+5V	● ●	+5V
SBD2-	● ●	SBD3-
SBD2+	● ●	SBD3+
GND	● ●	GND
KEY	□ ●	NC

USB 2.0 Connector

Game Port Bracket Supported

This motherboard comes with a game port (Joystick-Midi) for you to connect any midi devices or joysticks. To use this function you have to have a joystick module and connect it with a game port cable to this port on the motherboard.

Joystick Module
(User Upgrade Optional)



Pin1

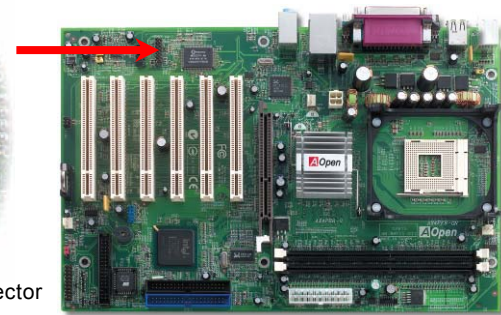

Game Port Connector



	1		
+5V	●	●	+5V
JAB1	●	●	JBB1
JACX	●	●	JBCX
GND	●	●	MIDI_TXD
GND	●	●	JBCY
JACY	●	●	JBB2
JAB2	●	●	MIDI_RXD
+5V	●	□	KEY

Note: This picture is for example only; it may not exactly look the same with the motherboard you purchased.

Case Open Connector

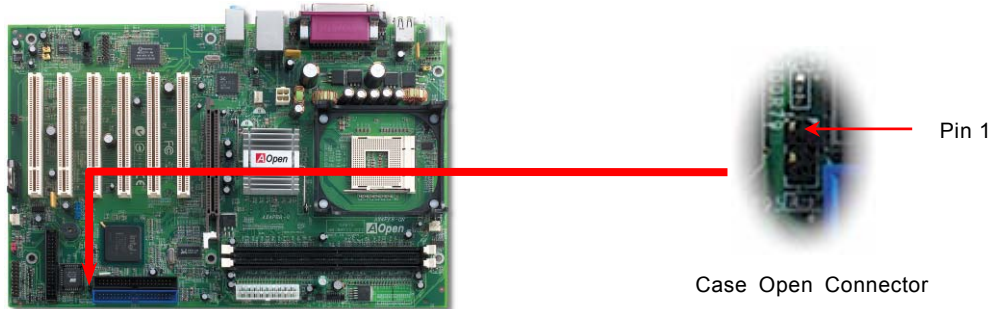
The “CASE OPEN” header provides chassis intrusion-monitoring function. To make this function works, you have to enable it in the system BIOS, connect this header to a sensor somewhere on the chassis. So, whenever the sensor is triggered by lights or by the opening of the chassis, the system will beep to inform you. Please be informed that this useful function only applies to advanced chassis, you may purchase an extra sensor, attach it on your chassis, and make a good use of this function.



- 1
-  Sensor
 -  GND

CD Audio Connector

This connector is used to connect CD Audio cable from CDROM or DVD drive to onboard sound.

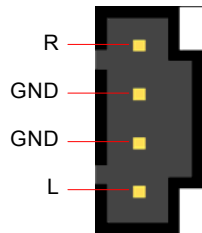

CD-IN Connector

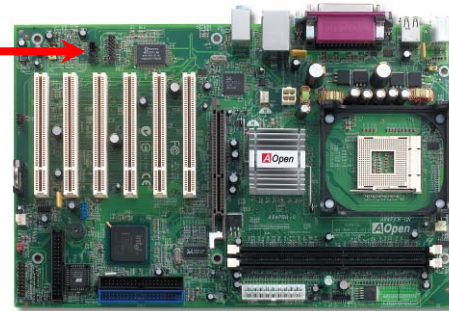

Note: Though some of the latest Windows versions support "Digital Audio" through IDE bus. However, in order to use Open Jukebox player, which is driven under BIOS, it is a **MUST** to insert audio cable to CD-IN connector on the motherboard.

Front Audio Connector

If the housing has been designed with an audio port on the front panel, you'll be able to connect onboard audio to front panel through this connector. By the way, please remove the jumper caps from the Front Audio Connector before you connect the cable. Do not remove the yellow jumper caps if your housing doesn't have an audio port on the front panel.

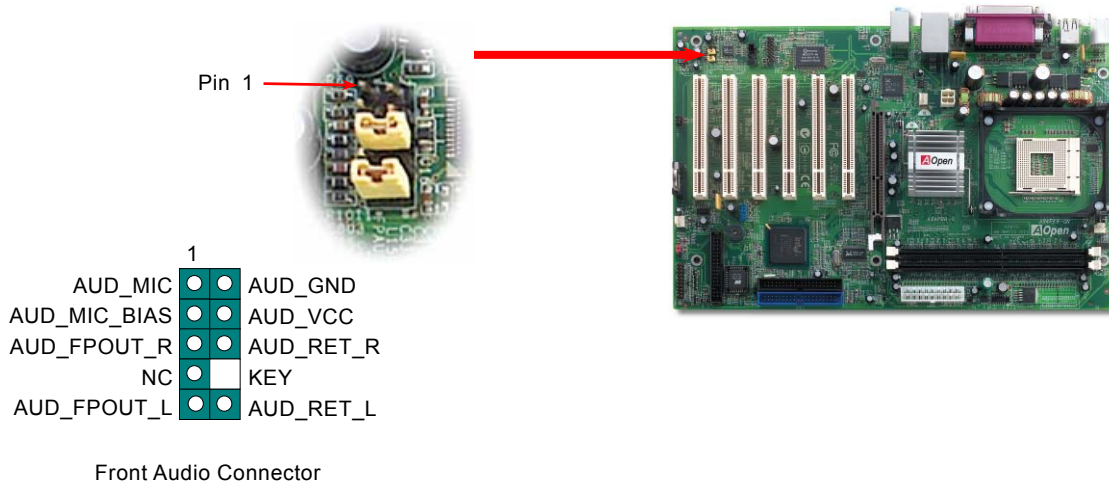

Note: Please remove the jumper cap from the Front Panel Audio Connector before you connect the cable. Do not remove this yellow jumper cap if housing without an audio port on the front panel.

Battery-less and Long Life Design

This Motherboard implements [Flash ROM](#) and a special circuit that allows you to save your current CPU and CMOS Setup configurations without the need of a battery. The RTC (real time clock) can also keep running as long as the power cord is plugged. If you lose your CMOS data by accident, you can just reload the CMOS configurations from Flash ROM and the system will recover as usual.

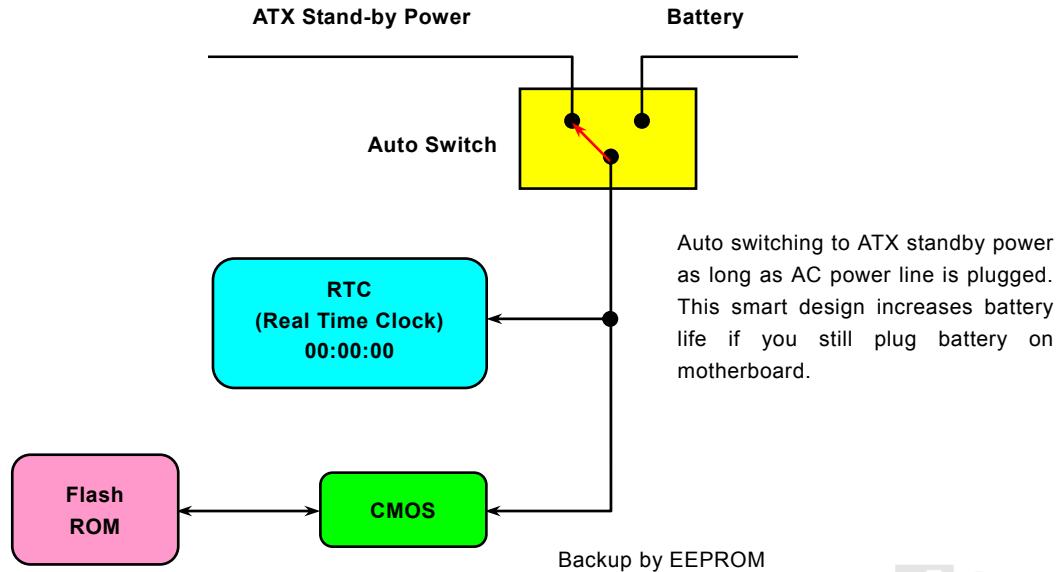

CPU Over-current Protection

Over Current Protection has been popularly implemented on ATX 3.3V/5V/12V switching power supply for a while. However, new generation CPU is able to use regulator of different voltages to transfer 12V to CPU voltage (for example, to 2.0V). This motherboard is with switching regulator onboard that supports CPU over-current protection, and it applies to 3.3V/5V/12V power supply for providing full line over-current protection.

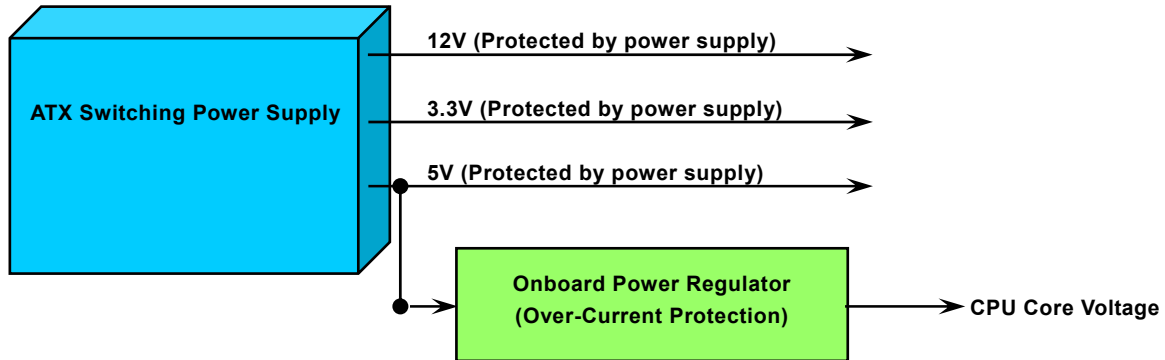

Note: Although we have implemented protection circuit try to prevent any human operating mistake, there is still certain risk that CPU, memory, HDD, add-on cards installed on this motherboard may be damaged because of component failure, human operating error or unknown nature reason. **AOpen cannot guaranty the protection circuit will always work perfectly.**

Hardware Monitoring

This motherboard implements a hardware monitoring system. As you turn on your system, this smart design will continue to monitor your system's working voltage, fan status and CPU temperature. If any of these systems' status goes wrong, there will be an alarm through the chassis external speaker or buzzer of motherboard (if existed) to warn the user.

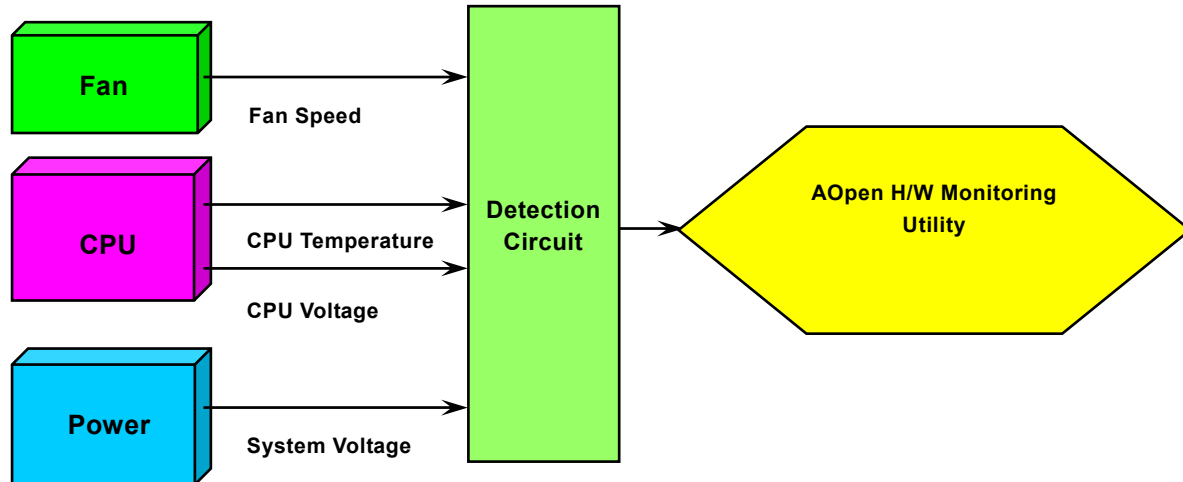

AOConfig Utility



AOConfig

AOpen always dedicated to provide users a much friendlier computer environment. We now bring you a comprehensive system detective utility. AOconfig is a Windows based utility with user-friendly interface that allows users to obtain information of the operation system and hardware such as motherboard, CPU, memory, PCI devices and IDE devices. The powerful utility also displays the version of BIOS and firmware for your convenience of maintenance.

Moreover, AOconfig allows users to save information in *.BMP or *.TXT format which users may collect the system information in detail and send them to AOpen directly for technical support or further diagnosis of system problem.

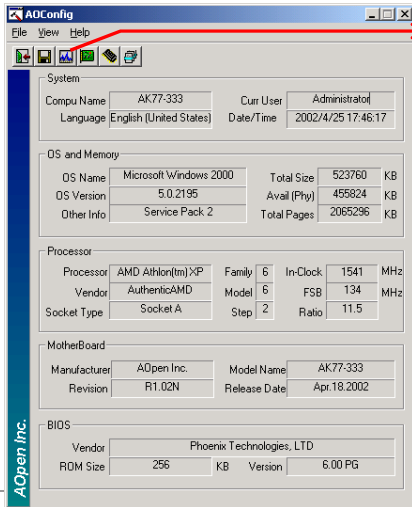

1. The system page shows the detail information of the motherboard, the operating system, the processor, and BIOS version.

2. The PCI device page shows the configurations of all PCI devices installed on your motherboard.

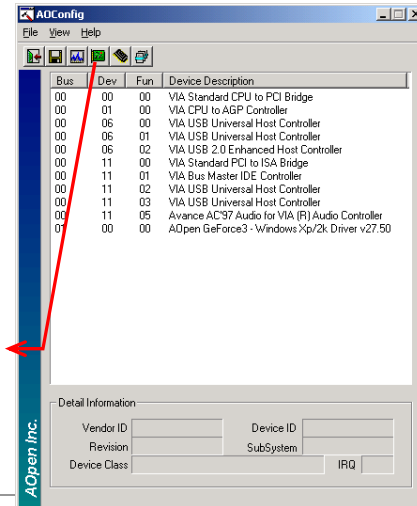

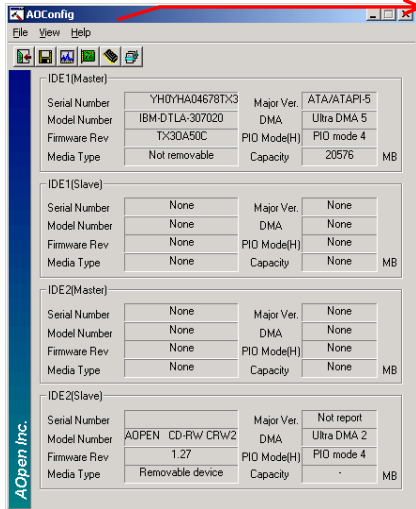

3. This page presents the IDE devices information, such as the serial number, the manufacturer, the firmware version, and capacity.

4. From this page, users may obtain the technical support information of AOpen. Moreover, detailed information could be saved in .bmp or .txt format.

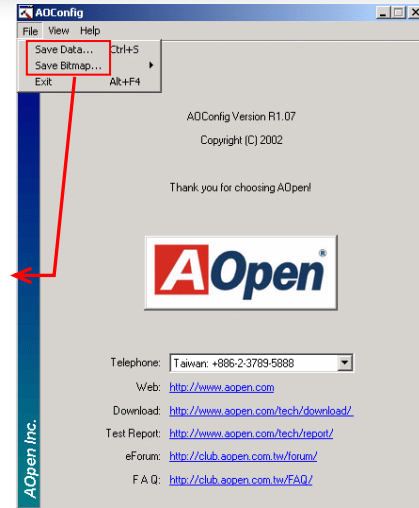

NOTE: AOconfig can be used in Windows 98SE/ME, NT4.0/2000, or even the latest Windows XP. Please be informed that AOconfig can only be operated in a system equipped with an AOpen motherboard. Meanwhile, all applications must be closed before starting AOconfig.

2200 μF Low ESR Capacitor

The quality of low ESR capacitor (Low Equivalent Series Resistance) during high frequency operation is very important for the stability of CPU power. The idea of where to put these capacitors is another know-how that requires experience and detail calculation.

Not only that, AX4PER-G / AX4PER-GN implements 2200 μF capacitors, which is much larger than normal capacitor (1000 and 1500 μF) and it provides better stability for CPU power.

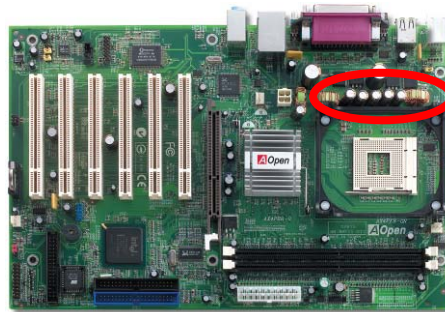

Layout (Frequency Isolation Wall)

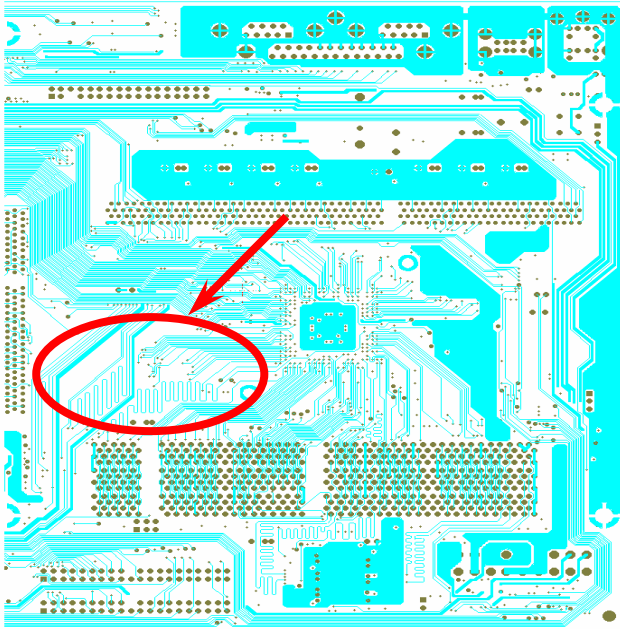

For high frequency operation, especially overclocking, layout is the most important factor to make sure chipset and CPU working in stable condition. The layout of this motherboard implements AOpen's unique design called " Frequency Isolation Wall". Separating each critical portion of motherboard into regions where each region operates in a same or similar frequency range to avoid cross talk and frequency interference between each region's operations and condition. The trace length and route must be calculated carefully. For example, the clock trace must be equal length (not necessarily as short as possible) so that clock skew will be controlled within few a pico second ($1/10^{12}$ Sec)

Note: This diagram for example only; it may not be exactly the same as this motherboard.

Enlarged Aluminum Heatsink

Cool down CPU and Chipset are important for system reliability. Enlarged aluminum heat sink provides better heat consumption especially when you are trying to over-clock the CPU.

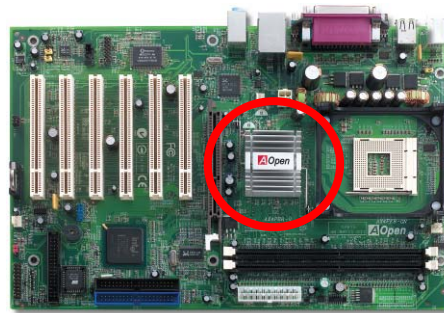

Wake On Modem / Wake On LAN / Wake On PCI Card

This motherboard implements special circuit to support Wake On Modem, Wake On LAN and Wake On PCI Card.

Green PC suspend mode does not really turn off the system power supply, it can be triggered by Modem, LAN or Other PCI Cards and resume back to active. If you have an external Modem card and want to use this wake-up feature, Please enable the "Wake On Modem" item. For an internal modem, LAN and other PCI cards, please enable the "Wake On PCI Card" item.

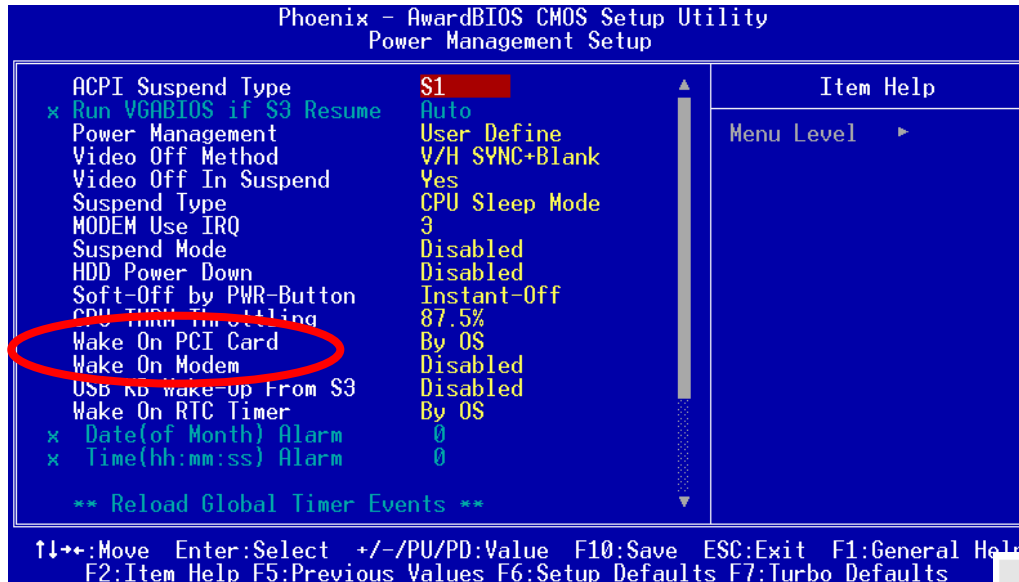



Open JukeBox Player

Here we are pleased to provide you a brand-new powerful interface—Open JukeBox. Without any cost you can have your PC turn into a fashionable CD player! This latest Open JukeBox motherboard aims at helping you directly operate your CD player on the PC without any hassle of entering Windows operation system.

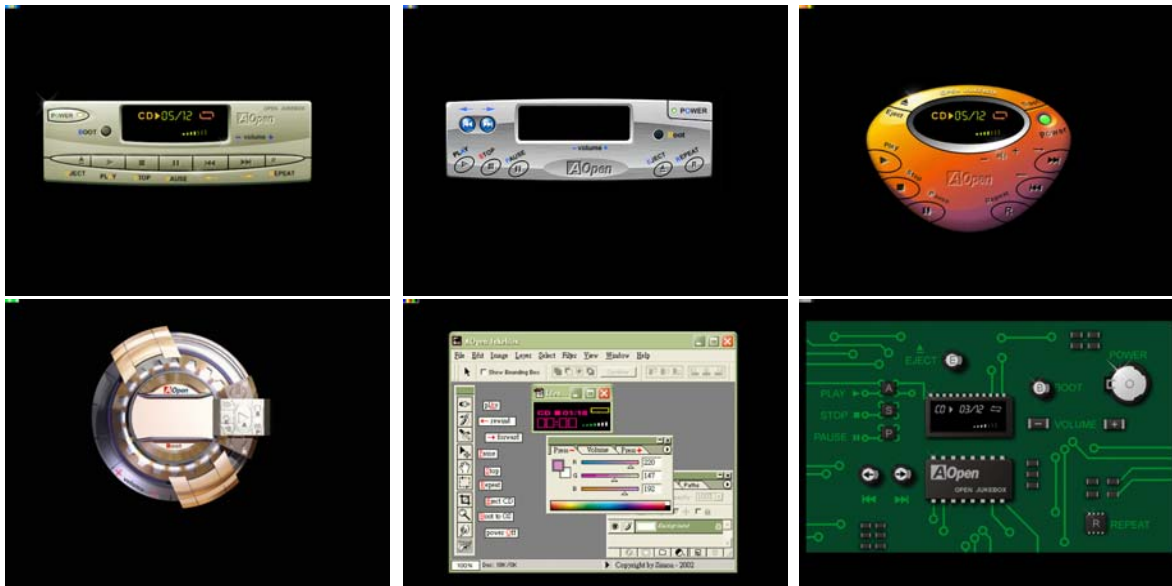

How Your Open JukeBox Works

The operation of Open JukeBox Player is the same as other CD players. By pressing specific keys on the keyboard you will find playing Open JukeBox Player couldn't be easier than the traditional CD Players. Below is the function description of respective buttons.



Power: Pressing **O**, to directly power off your computer with no hassle of entering Windows Operation System.

Boot: Pressing **B**, to intelligently boot to Windows Operation System for you.

Play: Pressing **A**, to start playing CD music.

Stop: Pressing **S**, to stop the music playing.

Pause: Pressing **P**, to pause the music playing temporarily.

Eject: Pressing **E**, to eject CD tray for you to change CD disc.

Repeat: Like other CD Players, pressing **R**, to shift the repeat mode.

Volume +/-: Pressing **+** or **-** to adjust the volume of playing music.

Rewind/Forward **← / →**: Pressing **arrow keys**, to rewind or forward the music.

Note: Though some of the latest version of Windows support "Digital Audio" through IDE bus. However, in order to use Open Jukebox player, which is driven under BIOS, it is a **MUST** to insert audio cable to CD-IN connector on the motherboard.

Your Open JukeBox Settings in BIOS

There are three Open JukeBox settings in BIOS as follows.

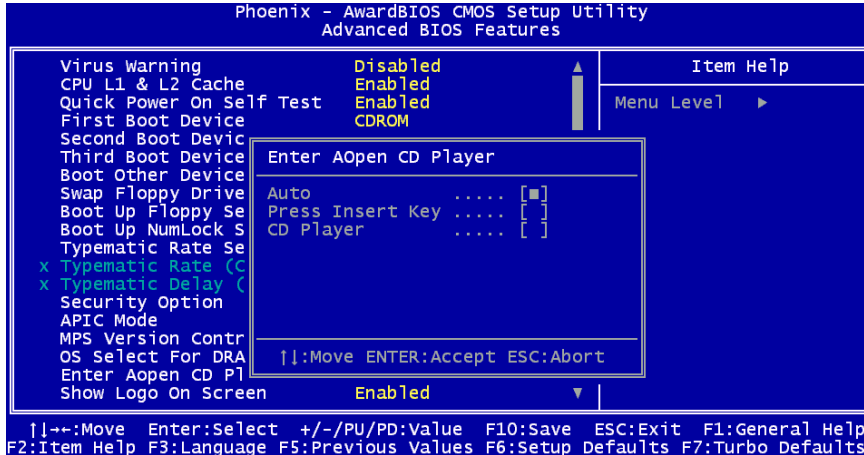

Auto: The default setting is “Auto” with which the Open JukeBox will automatically check the CD player every time you power on. The Open JukeBox will automatically be launched when it detects a music CD in your CD player.

Press Insert Key: Choosing this setting will allow a reminder message popped up on the screen during BIOS POST. It reminds you of pressing “Ins” key on your keyboard to start Open JukeBox Player; otherwise the system will launch the Windows Operation System.

CD Player: Choosing this setting allows the system to launch Open JukeBox Player every time you power on. However, by pressing **B** on your keyboard the Windows Operation System will be launched.

Your Open JukeBox EzSkin



Except these powerful functions above, Open JukeBox Player is also equipped with another fancy feature for you to change its “skin”. You can download as many skins as you want from AOpen Website, and changing them whenever you want by using this useful utility – **EzSkin** – which may also be downloaded from our website.

Even more, you may design your own skins with innovative idea and sharing them to users around the world by uploading to our website. For further technical information, we welcome you to visit our website at

<http://english.aopen.com.tw/tech/download/skin>



Vivid BIOS technology



Have you been fed up with the conservative and immutable POST screen? Let's rule out the tradition idea that POST screen are stiff and frigid, and let AOpen show you the newly developed VividBIOS to experience the lively vivid colorful POST screen!

Unlike earlier graphic POST screen which could occupy the whole screen and mask text information during POST, AOpen VividBIOS deals with graphics and texts separately, and makes them running simultaneously during POST. With this innovative design, VividBios now brings you a beautiful and sleek 256 colors screen without missing any important information shown on POST screen.

In addition, the limited space of BIOS ROM is another big issue. When all of the traditional BIOS can only show space-consuming and uncompressed Bitmap, AOpen has considerably tuned the BIOS to next generation, to recognize the smaller-sized GIF format and even dynamic-showing GIF animation.



Vivid BIOS shares the same fundamental technology with Open JukeBox CD Player, you may use the same EzSkin utility to

change your Vivid BIOS screen or to download your favorite Open JukeBox skin. If you see this little logo  shown beside your model name on the BIOS download page, <http://english.aopen.com.tw/tech/download/skin>, it is assured that your motherboard supports this innovative feature!

Driver and Utility

There are motherboard drivers and utilities included in AOpen Bonus CD. You don't need to install all of them in order to boot your system. But after you finish the hardware installation, you have to install your operation system first (such as Windows XP) before you can install any drivers or utilities. Please refer to your operation system's installation guide.

Auto-run Menu from Bonus CD

You can use the auto-run menu of Bonus CD. Choose the utility and driver and select model name.

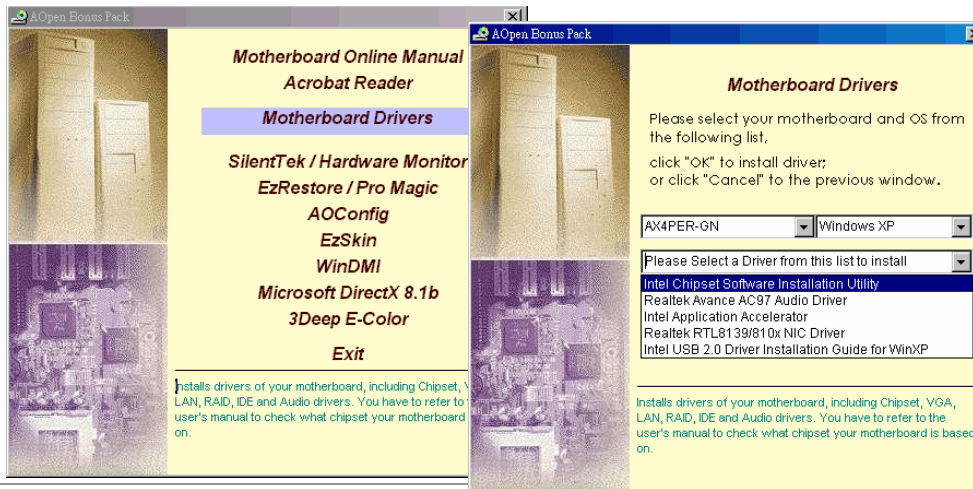

Installing Intel® Chipset Software Installation Utility

The Intel® Chipset Software Installation Utility should be installed onto the target system and the Windows * INF files outline the operating system how the chipset components will be configured. It is recommended that the Intel® Chipset Software Installation utility be installed onto the target system prior to the installation of other drivers.

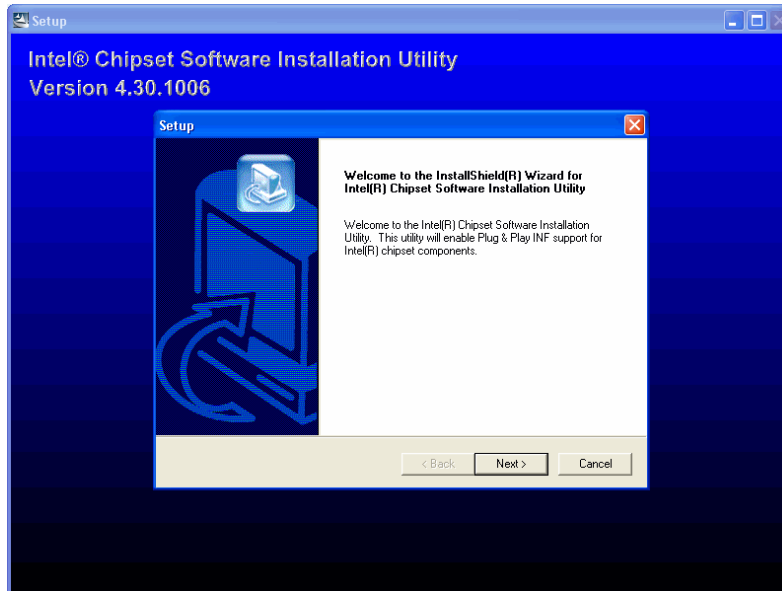

Installing Intel IAA Driver

The Intel(R) Application Accelerator is designed to improve performance of the storage sub-system and overall system performance. This software delivers improved performance through several ingredient technologies (components). Installation of the Intel(R) Chipset Software Installation Utility should be prior to loading the Intel(R) Application Accelerator.

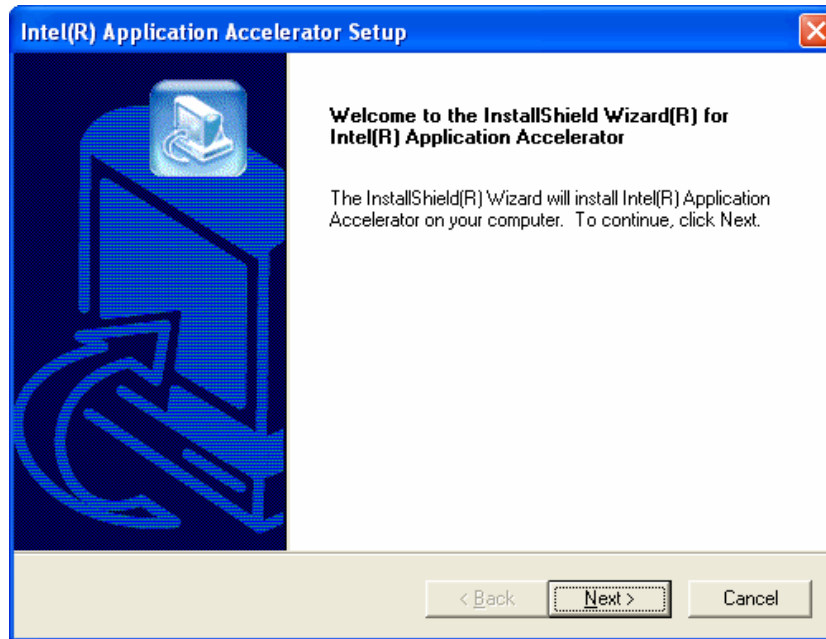

Installing Onboard Sound Driver

This motherboard comes with [AC97 CODEC](#). You can find the audio driver from the Bonus Pack CD auto-run menu.

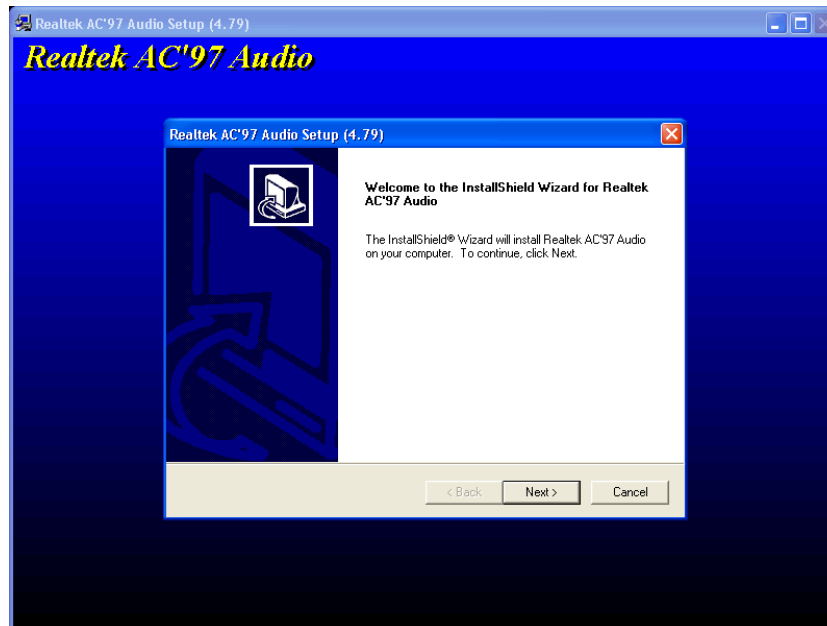

Installing LAN Driver (For AX4PER-GN)

This motherboard integrates Realtek 10/100Mbps PCI LAN Chip. You can find LAN driver from the Bonus Pack CD disc auto-run menu.

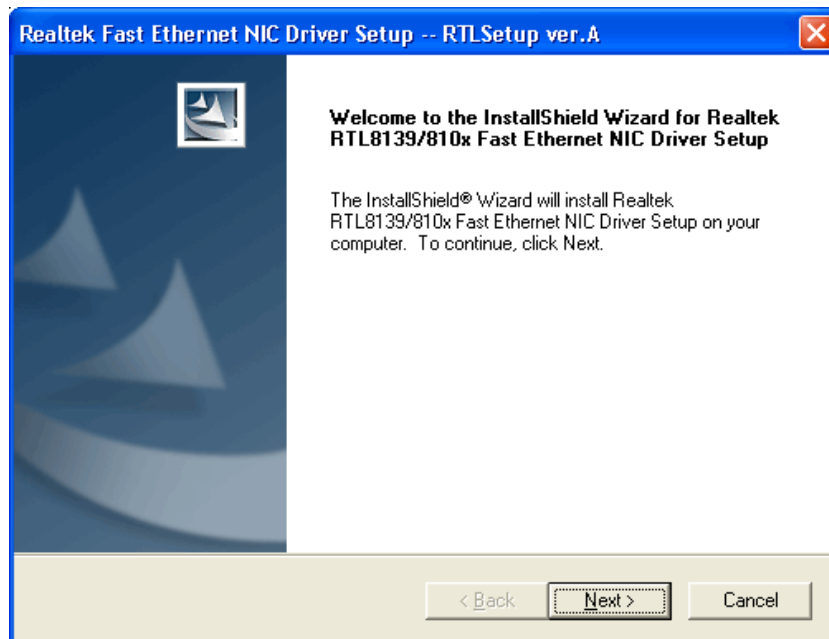

Install Windows 95 (Golden version), Win95A, OSR2, Windows NT v4.0 driver for Realtek RTL8139 PCI Fast Ethernet adapter.

[Windows 95 (Golden version), Win95A and OSR2]

Installing driver procedure on Microsoft Windows 95:

1. Ask you to select which driver you want to install, select "Driver from disk provided by hardware manufacturer".
2. Specify the setup file pathname
[CD-ROM]:\Driver\LAN\RTL8100\Windows\95\WIN95A (for Windows 95 and Win95A) or
[CD-ROM]:\Driver\LAN\RTL8100\Windows\95\W95OSR2 (for Windows 95 OSR2).
3. Windows 95 will appear some messages to insert Windows 95 system disk to complete setup step.
4. Windows 95 will finish the other installation procedure automatically, then you restart the system.

[Windows NT 3.5, 3.51 & 4.0]

Installing driver procedure on Microsoft Windows NT:

When you are in Windows NT:

1. In the Main group of NT, select the "Control Panel" icon.

2. In the Control Panel window, choose the "Network" icon.
3. In the Network Settings dialog box, choose the "Add Adapter" button. The Add Network Adapter dialog box appears.
4. In the list of network cards, select "<other> Requires disk from manufacturer", and then press <Enter> button.
5. Enter drive and pathname [CD-ROM]:\Driver\LAN\RTL8100\Windows\NT (for NT 4.0) which is the path where the setup file OEMSETUP.INF is located, and then choose the OK button.
6. The screen will appear "Select Line Speed" dialog box which is provide by RTL8139.SYS driver. The default value is "auto" so that the RTL8139 PCI Fast Ethernet adapter and its driver RTL8139.SYS will auto-detect the line speed, 10 Mb or 100Mb, while the TL8139.SYS is loading. The other values, "10" or "100", are only used when you want to forced RTL8139 PCI Fast Ethernet adapter to 10Mb or 100Mb.
7. The screen will appear "Input Ethernet ID" dialog box which is provided by RTL8139.SYS driver. This option is only required when you have more than one Realtek RTL8139 PCI Fast Ethernet adapters on this computer. Select "SKIP" if only one adapter is installed on this computer.
8. "Bus Location" display in next screen. Your machine contains more than one hardware bus, please select the Bus Type and Bus number on which your network adapter card is installed.
9. NT will then perform the binding process. If any additional network software options were installed, you may be prompted for specific information for these packages.
10. Restarting your system you will acquire network service.

NOTES:

* Installing Multiple LAN Adapters:

Enter Windows NT and follow above setup procedure step 2, in the "Network Settings" dialog box, choose the "Configure" button. The



"Input Ethernet ID" dialog box appears and input adapter's Ethernet ID. Last step is to select OK and close NETWORK SETUP. Select SKIP if only one adapter is installed on this computer.

Installing USB 2.0 Driver

This motherboard has six USB 2.0 ports. You can find USB driver from the Bonus Pack CD disc auto-run menu.

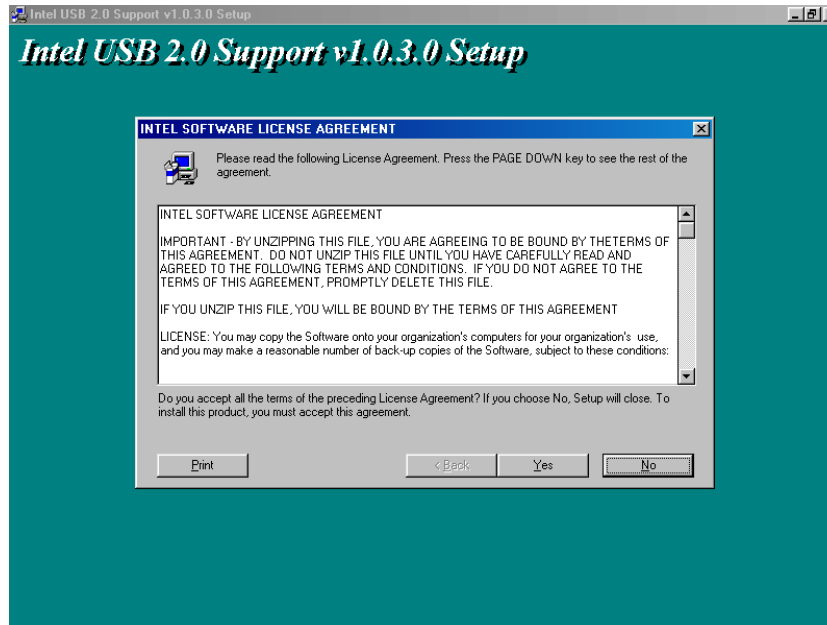

Windows 2000 Installation Guide

Installing Driver in Existing Windows 2000 System

After enabling the USB 2.0 controller and rebooting your system, Windows 2000 setup will show a "New Hardware Found" dialog box. Under Windows 2000, "Universal Serial Bus (USB) Controller" will be displayed.

1. Choose "Search for a suitable driver for my device (Recommended)".from the list, and then press "Enter".
2. Choose "Specify a location." and then press "Next"
3. Insert the Bonus CD in CD-ROM.
4. Type "[CD-ROM]:\Driver\Intel\USB2.0\Win2000" in the text box that appears. Press "OK ".
5. Click on "Next." A message informing you that Windows has found "Intel PCI to USB Enhanced Host Controller A1" should appear.
6. Click on "Next," and then on "Finish."

Confirming Windows 2000 Installation

1. From Windows 2000, open the Control Panel from "My Computer" followed by the System icon.
2. Choose the "Hardware" tab, and then click the "Device Manager" tab.
3. Click the "+" in front of "Universal Serial Bus controllers". "Intel PCI to USB Enhanced Host Controller A1" should appear.

Windows XP Installation Guide

Installing Driver in Existing Windows XP System

After enabling the USB 2.0, Windows XP setup will show a "Found New Hardware" dialog box. Under Windows XP, "Universal Serial Bus (USB) Controller" will be displayed.

1. Click on "Next," and from the generated list box, choose "Install from a list or special location (Advanced)", click "Next"
2. Click on "Next," and from the generated choices, choose "Include this location in the search:"
3. Insert the Bonus CD in CD-ROM.
4. Type "[CD-ROM]:\Driver\Intel\USB2.0\WinXP" in the text box that appears.
5. Click on "Next." A message informing you that Windows XP has found "Intel PCI to USB Enhanced Host Controller A1" should appear.
6. When the New Hardware Wizard has finished installing the USB driver, click on "Finish"

Confirming Windows XP Installation

1. Tools/Folder Options/View. Change below item:
2. Enable "Display the full path in the title bar".
3. Enable "Show Hidden files and folders".
4. Disable "Hide extensions of known files types".
5. Disable "Hide protected operating system files (Recommended)".
6. Check USB driver version from My Computer, Local Disk C:, Show the content of this drive, Windows directory, Show the content of this drive, System32 directory, Show the content of this drive, Drivers directory, Show the content of this drive, View, Details.

1. USBEHCI.SYS - 3/20/2002.

2. USBPORT.SYS - 8/17/2001.

3. USBHUB.SYS - 8/17/2001.

So, new 3616 driver does not install complete.

[Install by manual]

1. Disable Windows File Protection (WFP)



1. Start button/run/Regedit
2. Set HKEY_LOCAL_MACHINE\Software\Microsoft\Windows NT\CurrentVersion\Winlogon\SFCDisable = 1
2. Copy all USB files from CD to HDD.
 1. Copy all test drivers to %windir%\driver cache\i386.
 2. Copy all test drivers to %windir%\system32\dlcache You need to copy file to this directory first. Otherwise, Windows XP will replace file from this directory to system32\drivers.
 3. Copy all test drivers to %windir%\system32\drivers.
3. Check USB driver version again.
 1. USBEHCI.SYS - 3/20/2002.
 2. USBPORT.SYS - 3/20/2001.
 3. USBHUB.SYS - 3/20/2001.

Test USB 2.0 HDD with restart for 10 times. The USB 2.0 HDD can detection with any problem for all 10 times.

Phoenix-AWARD BIOS

System parameters can be modified by going into [BIOS](#) Setup menu, this menu allows you to configure the system parameters and save the configuration into the 128 bytes CMOS area, (normally in the RTC chip or in the main chipset).

The Phoenix-Award BIOS™ that installed in the [Flash ROM](#) of the motherboard is a custom version of an industry standard BIOS. The BIOS provides critical low-level support for standard devices such as hard disk drives, serial and parallel ports.

Most BIOS setting of AX4PER-G / AX4PER-GN had been optimized by AOpen's R&D engineering team. But, the default setting of BIOS still can't fine-tune the chipset controlling entire system. Hence, the rest of this chapter is intended to guide you through the process of configuring your system using setup.

To enter to BIOS setup menu, press when [POST \(Power-On Self Test\)](#) screen is shown on your monitor.

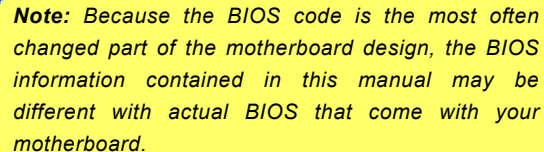

***Note:** Because the BIOS code is the most often changed part of the motherboard design, the BIOS information contained in this manual may be different with actual BIOS that come with your motherboard.*

How To Use Phoenix-Award™ BIOS Setup Program

Generally, you can use the arrow keys to highlight items that you want to choose, then press <Enter> key to select, and use the <Page Up> and <Page Down> key to change setting value. You also can press <F1> key for help and press <Esc> key to quit Phoenix-Award™ BIOS setup program. The following table provides details about how to use keyboard in the Award™ BIOS setup program. By the way, all products of AOpen also provides a special function in the BIOS setup, you can press <F3> key selecting preferred menu language to display.

Key	Description
Page Up or +	Changing setting to next value or increase the value.
Page Down or -	Changing setting to previous value or decrease value.
Enter	Select the item.
Esc	1. In main menu: Quit and don't save any change. 2. In sub menu: Exit current menu to main menu.
Up Arrow	Highlight previous item.
Down Arrow	Highlight next item.
Left Arrow	Move the light bar to left side of menu.
Right Arrow	Move the light bar to right side of menu.
F1	Get menu or item help description.
F5	Load previous setting value from CMOS.

Key	Description
F6	Load Setup Default setting value from CMOS.
F7	Load turbo setting value from CMOS.
F10	Save changed setting and exit setup program.

How To Enter BIOS Setup

After you finish the setting of jumpers and connect correct cables. Power on and enter the BIOS Setup, press during [POST \(Power-On Self Test\)](#). Choose "Load Setup Defaults" for recommended optimal performance.

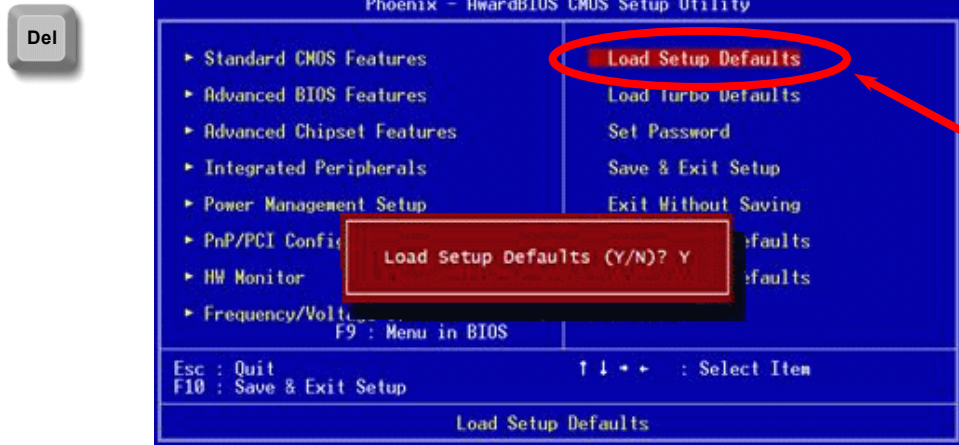

Warning: Please avoid of using "Load Turbo Defaults", unless you are sure your system components (CPU, DRAM, HDD, etc.) are good enough for turbo setting.



BIOS Upgrade under Windows environment



With outstanding R&D ability of AOpen, we now bring you a whole new BIOS Flash wizard ---- EzWinFlash. With an eye to users convenience, EzWinFlash combines the BIOS binary code and flash module together, so the only thing you have to do is just clicking on the utility you downloaded from web and let it helps you complete the flash process automatically. EzWinFlash detects your motherboard and checks the BIOS version cleverly to prevent your system from any possible failure. Moreover, EzWinFlash has been taken into consideration to go with any windows platform you might be using, no matter if you're using Windows 95/98, 98SE/ME, NT4.0/2000, or Windows XP.

In the meanwhile, in order to provide a much more user-friendly operating environment, AOpen EzWinFlash is natively designed to have multi-language function to provide easier way for users' usage in changing BIOS setting.

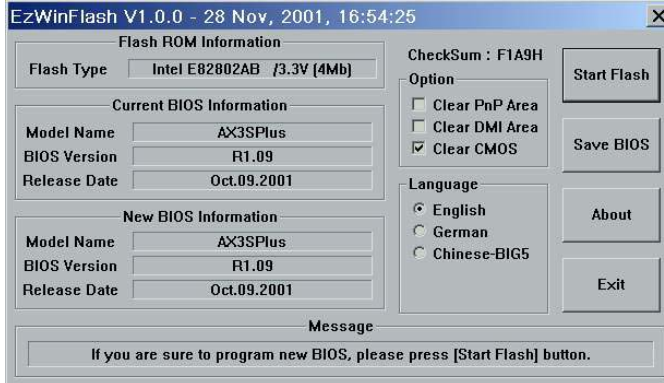

Caution: By updating your motherboard, you are taking a risk of BIOS flash failure. If your motherboard is working stable, and there are no major bugs that had been fixed by a latter BIOS revision, we recommend that you DO NOT try to upgrade your BIOS.

If you intent on upgrading, PLEASE BE SURE to get the right BIOS revision for the right motherboard model to avoid any possibility failure.

Note: The model name on this BIOS picture is for reference only. It may not be the exact model name.



You may accomplish BIOS upgrade procedure with EzWinFlash by the following steps, and it's STRONGLY RECOMMENDED to close all the applications before you start the upgrading.

1. Download the new version of BIOS package zip file from AOpen official web site. (ex: <http://www.aopen.com>)
2. Unzip the download BIOS package (ex: WPRGN102.ZIP) with WinZip (<http://www.winzip.com>) in Windows environment.
3. Save the unzipped files into a folder, for example, WPRGN102.EXE & WPRGN102.BIN.
4. Double click on the WPRGN102.EXE, EzWinFlash will detect the model name and BIOS version of your motherboard. If you had got the wrong BIOS, you will not be allowed to proceed with the flash steps.
5. You may select preferred language in the main menu, then click [Start Flash] to start the BIOS upgrade procedure.
6. EzWinFlash will complete all the process automatically, and a dialogue box will pop up to ask you to restart Windows. You may click [YES] to reboot Windows.
7. Press at POST to enter BIOS setup, choose "Load Setup Defaults", then "Save & Exit Setup". Done!

It is strongly recommended NOT to turn off the power or run any application during FLASH PROCESS.

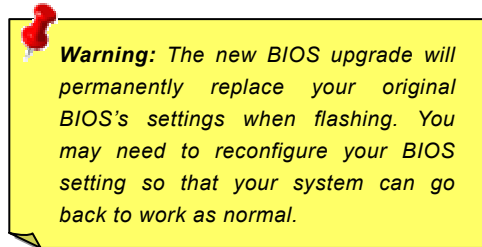

Glossary

AC97 CODEC

Basically, AC97 CODEC is the standard structure of PCI sound card. As we know, computer is digital-based, but music is based on analog-based. Therefore, there must be a process to turn digital into analog during the last stage processing of sound in computer. Hence, the component on sound card that play this important task is what we called CODEC.

Audio CODEC 97 (briefly called AC97) is the specification regulated by Intel, and it's about the structure of audio conversion. The special place about CODEC is that it is separated from sound card (CODEC is an independent chipset). Therefore, PCI sound card could possess with 90db and do other application process as well. We called CODEC that meets this structure AC97 CODEC.

ACPI (Advanced Configuration & Power Interface)

ACPI is the power management specification of PC97 (1997). It intends to save more power by taking full control of power management to operating system and bypass [BIOS](#). The chipset or super I/O chip needs to provide standard register interface to operating system (such as Windows 98). This is a bit similar as the [PnP](#) register interface. ACPI defines ATX momentary soft power switch to control the power state transition.

ACR (Advanced Communication Riser)

Building on the PC motherboard riser architecture, ACR slot is backward compatible with AMR but beyond the limitation of it. The ACR specification is designed to support modem, audio, Local Area Network (LAN) and Digital Subscriber Line (DSL).

AGP (Accelerated Graphic Port)

The main function of AGP simply put is to tell monitor what screen information had to be shown, a visual transmission device actually. With the rapid developing of AGP card, we can see that it had been developed from single colorful AGP card to 2D and 3D graphic. AGP supports only memory read/write operation and single-master single-slave one-to-one only. Though AGP and PCI share the same algorithm of 32-bit, its frequencies are 66MHz and 33MHz respectively. AGP interface had been developed from 2X to 8x.

1X AGP, data transfer rate is $66\text{MHz} \times 4\text{byte} \times 1 = 264\text{MB/s}$

2X AGP, data transfer rate is $66\text{MHz} \times 4\text{byte} \times 2 = 528\text{MB/s}$

4X AGP, data transfer rate is $66\text{MHz} \times 4\text{byte} \times 4 = 1056\text{MB/s}$.

8X AGP, data transfer rate is $66\text{MHz} \times 4\text{byte} \times 8 = 2112\text{MB/s}$.

AMR (Audio/Modem Riser)

The CODEC circuit of AC97 sound/modem solution can be put on motherboard or put on a riser card (AMR card) that connects to motherboard through AMR connector.

ATA (AT Attachment)

Before talking about ATA (AT Attachment), we must understand **DMA** (Direct Memory Access), which allows devices to skip the CPU devices and access memory directly. DMA specification could not only eliminate the workload of CPU, but also accelerate the transmission of data. DMA begins with a data transfer rate of 16.6MB/Sec, but afterward developed to new data rate of 33.3MB/Sec, which is twice the data rate and we called it **Ultra DMA**. **ATA** details power and data signals between the drive and integrated drive controller and the computer's motherboard. Two drives (master and slave) are supported. The ATA specification allows the drive to connect directly to the ISA bus on the computer. ATA transfer rate then had been developed to 133MHz/Sec and would come out with fastest rate later (please refer to [Serial ATA](#)).

DMA, data transfer rate is 16.6MHz/s.

Ultra DMA, data transfer rate is 16.6MHz x 2 = 33MB/s.

ATA/66, data transfer rate is 16.6MHz x 4 = 66MB/s.

ATA/100, data transfer rate is 16.6MHz x 6 = 100MB/s.

ATA/133, data transfer rate is 16.6MHz x 8 = 133MB/s.

(ATA/133 uses both rising edge and falling edge as ATA/66 but clock cycle time is reduced to 30ns.)

BIOS (Basic Input/Output System)

BIOS, is a set of assembly routine/program that reside in [EPROM](#) or [Flash ROM](#). BIOS controls Input/output devices and other hardware devices of motherboard. In general, to provide hardware independent portability, operation system and drivers is required to access BIOS without directly access hardware devices.

Bluetooth

Bluetooth is a wireless transferring technology that enables short-range wireless connections between desktop and laptop computers, personal digital assistants (PDAs), cellular phones, printers, scanners, digital cameras and even home appliances. The principle of Bluetooth (a chipset) is to transfer information and voices at the frequency of ISM Band. Every Bluetooth technology devices do come with a standard address for you to connect one-to-one or one-to-seven (to form a Pico-net), with transferring range up to 10 meters (100 meters to follow), using low power radio. Bluetooth do not only possess high transfer rate of 1MB/s, it also could be encrypted with pin code. With hopping rate of 1600 hops per second, it's difficult to be intercepted and are less interrupted by electromagnetic wave.

CNR (Communication and Networking Riser)

The CNR specification provides the PC industry the opportunity to deliver a flexible and cost reduced method of implementing LAN, home networking, DSL, USB, wireless, audio and modem subsystems widely used in today's "connected PCs". The CNR specification is an open industry specification and is supported by OEMs, IHV card manufacturers, silicon supplier and Microsoft.

DDR (Double Data Rate) RAM

DDR RAM utilizes the existing [SDRAM](#) (For ex, PC-100, PC-133) infrastructure and technology while doubling the nominal bandwidth available to systems in an easy to design and simple to adopt way. Based on FSB frequency, DDR RAM on the market are DDR200, DDR266 and DDR333 with more coming around soon.

DDR200, transfer bandwidth up to $200 \times 64 / 8 = 1600 \text{MB/s}$ (PC1600)

DDR266, transfer bandwidth up to $266 \times 64 / 8 = 2100 \text{MB/s}$ (PC2100)

DDR333, transfer bandwidth up to $333 \times 64 / 8 = 2700 \text{MB/s}$ (PC2700)

DDR400, transfer bandwidth up to $400 \times 64 / 8 = 3200 \text{MB/s}$ (PC3200)

ECC (Error Checking and Correction)

The ECC mode needs 8 ECC bits for 64-bit data. Each time memory is accessed; ECC bits are updated and checked by a special algorithm. The ECC algorithm has the ability to detect double-bit error and automatically correct single-bit error while parity mode can only detect single-bit error.

EEPROM (Electronic Erasable Programmable ROM)

Also known as E²PRM. Both EEPROM and [Flash ROM](#) can be re-programmed by electronic signals, but the interface technology is different. Size of EEPROM is much smaller than flash ROM.



EPROM (Erasable Programmable ROM)

Traditional motherboard stores BIOS code in EPROM. EPROM can only be erased by ultra-violet (UV) light. If BIOS has to be upgraded, you need to remove EPROM from motherboard, clear by UV light, re-program, and then insert back.

EV6 Bus

EV6 Bus is the technology of Alpha processor from Digital Equipment Corporation. EV6 bus uses both rising and falling clock edge to transfer data, similar as DDR RAM or ATA/66 IDE bus.

EV6 Bus Speed = CPU external bus clock x 2.

200 MHz EV6 bus, 200MHz = 100 MHz external bus clock x 2

FCC DoC (Declaration of Conformity)

The DoC is component certification standard of FCC EMI regulations. This standard allows DIY component (such as motherboard) to apply DoC label separately without a shielding of housing.

FC-PGA (Flip Chip-Pin Grid Array)

FC means Flip Chip, FC-PGA is a package of Intel for Pentium III for 0.18µm process CPU, which can be plugged into SKT370 socket.

FC-PGA2 (Flip Chip-Pin Grid Array)

After FC-PGA, FC-PGA2 is the package for 0.13µm process CPU developed by Intel, which can be plugged into SKT423/478 socket as well.

Flash ROM

Flash ROM can be re-programmed by electronic signals. It is easier for BIOS to upgrade by a flash utility, but it is also easier to be infected by virus. Because of increase of new functions, BIOS size is increased from 64KB to 512KB (4M bit).

Hyper Threading

Hyper-Threading technology is an innovative design from Intel that enables multi-threaded software applications to process threads in parallel within each processor resulting in increased utilization of processor execution resources. As a result, an average improvement of ~40% in CPU resource utilization yields higher processing throughput.

IEEE 1394

IEEE 1394, which also called Firewire, is a serial data transfer protocol and interconnection system. The main feature of the Firewire that assures its adoption for the digital video and audio (A/V) consumer application is its low cost. Fire wire interface is capable of supporting various high-end digital A/V applications, such as consumer A/V device control and signal routing, Digital Video (DV) editing, home networking, and more than 32 channels of digital mixing. Gone are those days of expensive video capture cards. Firewire allows for video capture from both newer DV camcorders with Firewire ports and older analog equipment using A/V to Firewire converters.

The advantages of the IEEE1394:

High data transfer rate – Start from 400 Mbps, (with 800/1600/3200 Mbps coming soon), which is about 30 times faster than USB 1.1.

Supports up to 63 devices (16 - daisy chained) with cable length up to about 4.5 m (14 feet).

Hot-pluggable (like USB). No need to turn of your device to connect or disconnect, and you don't need to reboot your PC. Also, it is a plug-and-play bus.

IEEE1394 is very easy to connect (Like USB1.1/2/0).

Parity Bit

The parity mode uses 1 parity bit for each byte, normally it is even parity mode, that is, each time the memory data is updated, parity bit will be adjusted to have even count "1" for each byte. When next time, if memory is read with odd number of "1", the parity error is occurred and this is called single bit error detection.

PCI (Peripheral Component Interface) Bus

Developed by Intel, Peripheral Component Interconnect (PCI) is a local bus standard. A bus is a channel used to transfer data to (input) and from (output) a computer and to or from a peripheral device. Most PCs have a PCI bus usually implemented at 32-bits providing a 33 MHz clock speed with a throughput rate of 133 MBps.

PDF Format

With PDF file, it is easy to do universal document exchange. Virtually any document may be converted in Portable Document Format (PDF). Contents in PDF documents are exactly the same as the original file, including fonts and graphics, and they can be distributed by e-mail or stored on the World Wide Web, an intranet, a file system, or a CD-ROM for other users to view on any platforms. You may download Acrobat Reader in order to read PDF file from its website (www.adobe.com).

PnP (Plug and Play)

Oversimplified, Plug-and-Play automatically tells the software (device drivers) where to find various pieces of hardware (devices) such as modems, network cards, sound cards, etc. Plug-and-Play's task is to match up physical devices with the software (device drivers) that operates them and to establish channels of communication between each physical device and its driver.

POST (Power-On Self Test)

The BIOS self-test procedure after power-on, sometimes, it is the first or the second screen shown on your monitor during system boot.

PSB (Processor System Bus) Clock

PSB Clock means the external bus clock of CPU.

CPU internal clock = CPU PSB Clock x CPU Clock Ratio

RDRAM (Rambus Dynamic Random Access Memory)

A DRAM technology developed by Rambus Corporation*, to achieve high speed of memory through the use of multiple channels in parallel by 16-bits. Basically, RDRAM uses new structure of Multibank, which is quite different from FPM, EDO, SDRAM. Using different memory module as well, RDRAM uses "RIMM" with transfer rate of 600/700/800MHz, providing bandwidth as high to 1.6GB.

RIMM (Rambus Inline Memory Module)

184-pin memory module that supports [RDRAM](#) memory technology. A RIMM memory module may contain up to maximum of 16 RDRAM devices.

SDRAM (Synchronous DRAM)

SDRAM is one of the DRAM technologies that allow DRAM to use the same clock as the CPU host bus (EDO and FPM are asynchronous and do not have clock signal). It is similar as PBSRAM to use burst mode transfer. SDRAM comes in 64-bit 168-pin DIMM and operates at 3.3V, and have been gradually replaced by DDR RAM.

SATA (Serial ATA)

The Serial ATA specification is designed to overcome speed limitations while enabling the storage interface to scale with the growing media rate demands of PC platforms. Serial ATA is to replace parallel [ATA](#) with the compatibility with existing operating systems and drivers, adding performance headroom for years to come. It is developed with data transfer rate of 150 Mbytes/second, and 300M/bs, 600M/bs to come. It reduces voltage and pins count requirements and can be implemented with thin and easy to route cables.

SMBus (System Management Bus)

SMBus is also called I²C bus. It is a two-wire bus developed for component communication (especially for semiconductor IC). For example, set clock of clock generator for jumper-less motherboard. The data transfer rate of SMBus is only 100Kbit/s, it allows one host to communicate with CPU and many masters and slaves to send/receive message.

SPD (Serial Presence Detect)

SPD is a small ROM or [EEPROM](#) device resided on the DIMM or [RIMM](#). SPD stores memory module information such as DRAM timing and chip parameters. SPD can be used by [BIOS](#) to decide best timing for this DIMM or RIMM.

USB 2.0 (Universal Serial Bus)

A Universal Serial Bus (USB) is an external bus (an interconnect) standard that supports data transfer rates of 12 Mbps. A single USB port can be used to connect up to 127 peripheral devices, such as mouse, modems and keyboards. Introduced in 1996, USB has completed replaced serial and parallel ports. It also supports plug-and-play installations and hot plugging. Plug-and-play is the ability to add and remove devices to a computer while the computer is running and have the operating system automatically recognize the change. USB 2.0, which supports data transfer rates of 480 Mbps, has been widely used in motherboard these days.

VCM (Virtual Channel Memory)

NEC's Virtual Channel Memory (VCM) is a new DRAM core architecture that dramatically improves the memory system's ability to service multimedia requirements. VCM increases memory bus efficiency and performance of any DRAM technology by providing a set of fast static registers between the memory core and I/O pins. Using VCM technology results in reduced data access latency and reduced power consumption.

Wireless LAN – 802.11b

802.11 is a specification developed by IEEE and Wireless LAN technology, which is an interface between a wireless client and a base station or between two wireless clients.

802.11 family includes the following specifications and with more coming:

802.11 = 1 or 2 Mbps transmission in the 2.4 GHz band, using either frequency hopping spread spectrum (FHSS) or direct sequence spread spectrum (DSSS).

802.11a = 54 Mbps in the 5GHz band, using orthogonal frequency division multiplexing)

802.11b (11 Mbps transmission in the 2.4 GHz band, using direct sequence spread spectrum (DSSS).

ZIP file

A compressed file format to reduce file size. To unzip file, run shareware PKUNZIP (<http://www.pkware.com/>) for DOS and other operating system or WINZIP (<http://www.winzip.com/>) for windows environment.



Troubleshooting

If you encounter any trouble to boot your system, follow the procedures accordingly to resolve the problem.

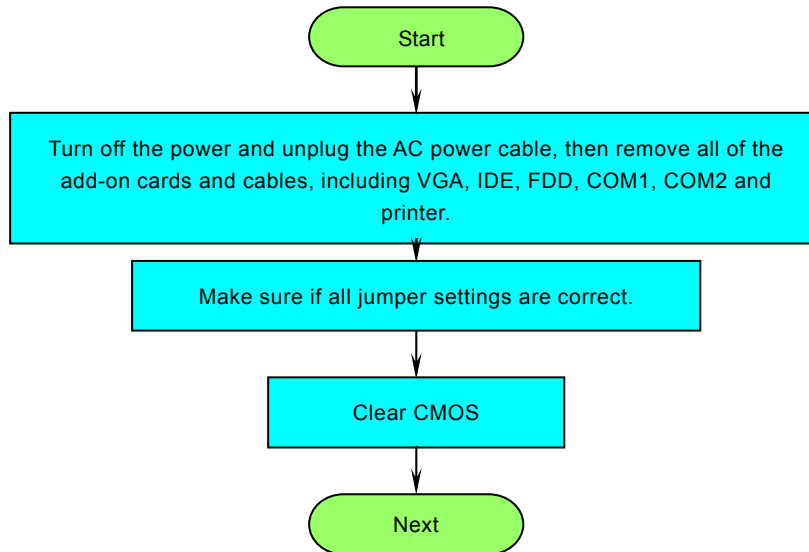

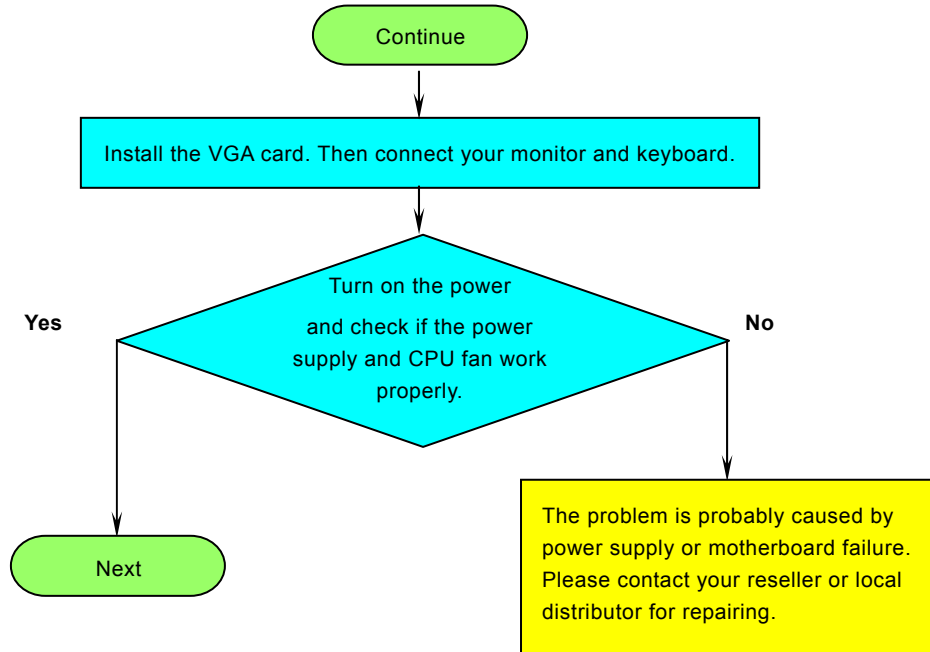

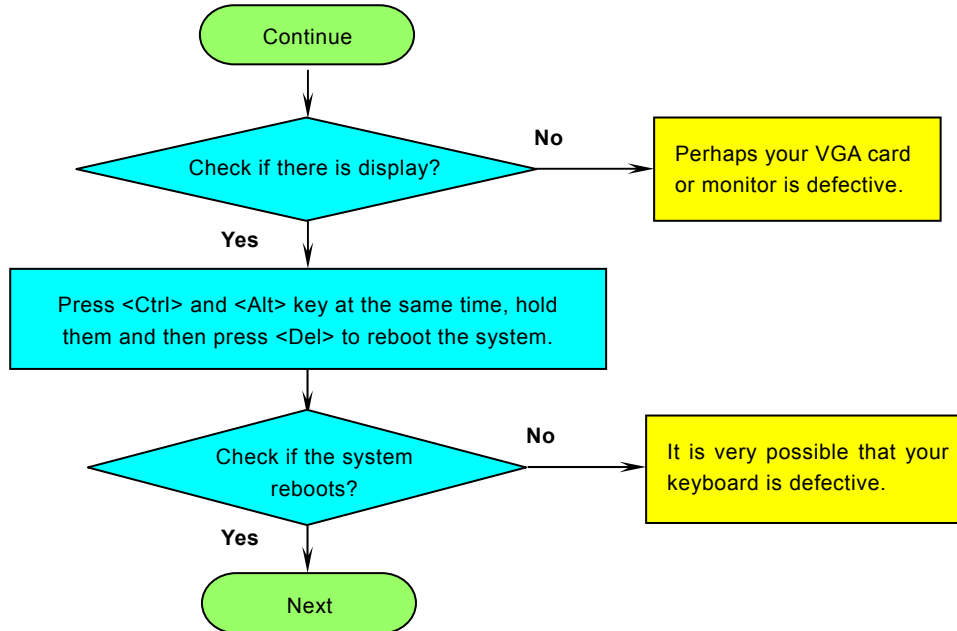

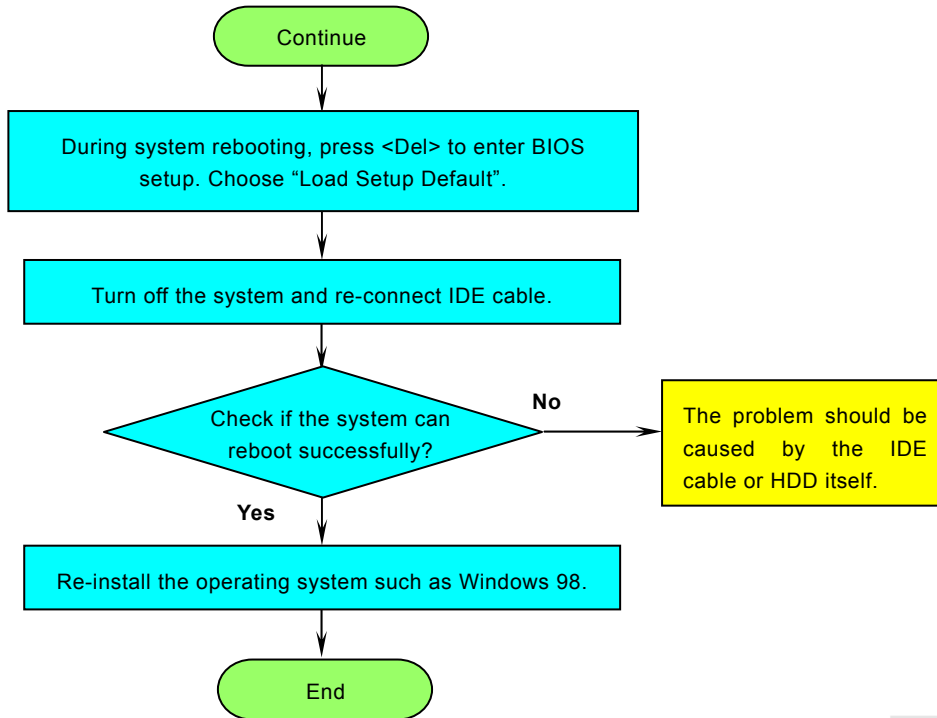



Technical Support

Dear Customer,

Thanks for choosing AOpen products. To provide the best and fastest service to our customer is our first priority. However, we receive numerous emails and phone-calls worldwide everyday, it is very hard for us to serve everyone on time. We recommend you follow the procedures below and seek help before contact us. With your help, we can then continue to provide the best quality service to more customers.

Thanks very much for your understanding!

AOpen Technical Supporting Team

1

Online Manual: To download manual, please log on and then select your preferred language. Under “Type” directory, choose “Manuals” to go to our manual database. You can also find the manual and EIG in AOpen Bonus Pack.

<http://club.aopen.com.tw/downloads>

2

Test Report: We recommend you to choose board/card/device from the compatibility test reports for assembling your PC. It may prevent incompatibility problems.

<http://english.aopen.com.tw/tech/report/default.htm>

3

FAQ: Here we list problems that users often encounter and FAQ (Frequently Asked Questions). You may be able to find a solution to your problem.

<http://club.aopen.com.tw/faq/>

4

Download Software: After log on and having language selected, you may get the latest updated BIOS/utility and drivers you need under “Type” directory. In most case, newer versions of drivers and BIOS have solved earlier bugs or compatibility problems.

<http://club.aopen.com.tw/downloads>

5

eForum: AOpen eForum is provided to discuss our products with other users, in which your problem probably had been discussed before or will be answered. After log on, you may select your preferred language under “Multi-language”.

<http://club.aopen.com.tw/forum/>

6

Contact Distributors/Resellers: We sell our products through resellers and integrators. They should know your system configuration very well and should be able to solve your problem efficiently and provide important reference for you.

7

Contact Us: Please prepare detail system configuration and error symptom before contacting us. The **part number**, **serial number** and **BIOS version** are also very helpful.

Part Number and Serial Number

The Part Number and Serial number are printed on bar code label. You can find this bar code label on the outside packing or on the component side of PCB. For example:



P/N: 91.88110.201 is part number, **S/N: 91949378KN73** is serial number.

Model name and BIOS version

Model name and BIOS version can be found on upper left corner of first boot screen ([POST](#) screen). For example:

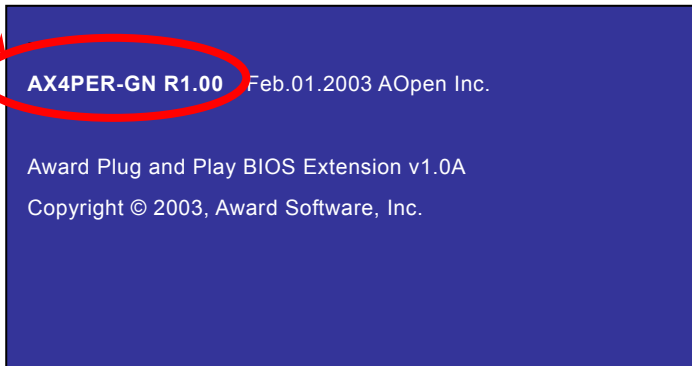

AX4PER-GN is model name of motherboard; **R1.00** is BIOS version.



Product Registration

ClubAOpen

Welcome to AOpen Inc.



Thank you for choosing AOpen product. AOpen encourages you to spend few minutes in completing the following product registration. To register your product will ensure the high quality of services from AOpen. After the registration, you will:

- Have opportunities to play online slot machine and win a prize from AOpen by accumulating your bonuses for later prize exchange.
- Be upgraded to gold membership of Club AOpen program.
- Receive email notification about product safety alerts. Its purpose is to alert consumers quickly and conveniently when products contain technical issues.
- Receive email notification about latest product's announcements.
- Be able to personalize your AOpen web pages.
- Receive e-mail notification about latest BIOS/Driver/Software release information.
- Have opportunities to participate special product promotional programs.
- Enjoy higher service priority to receive technical assistance provided by AOpen specialists worldwide.
- Be able to join the discussions of web-based news groups.

AOpen makes sure that the information you provide is encrypted, so that it cannot be read or intercepted by other people or companies. Further, AOpen will not disclose any of information you submitted under any conditions. Please consult our [online privacy policy](#) for further information on our company policy.



Note: *If registering products purchased from different dealers/retails and/or purchased on different dates, please submit a separate form for each product.*

AOpen



How to Contact Us



Please do not hesitate contact us if you have any problem about our products. Any opinion will be appreciated.

Pacific Rim
AOpen Inc.
Tel: 886-2-3789-5888
Fax: 886-2-3789-5899

Europe
AOpen Computer b.v.
Tel: 31-73-645-9516
Fax: 31-73-645-9604

America
AOpen America Inc.
Tel: 1-408-922-2100
Fax: 1-408-922-2935

China
艾爾鵬國際貿易(上海)有限公司
Tel: 86-21-6225-8622
Fax: 86-21-6225-7926

Germany
AOpen Computer GmbH.
Tel: 49-2102-157700
Fax: 49-2102-157799

Japan
AOpen Japan Inc.
Tel: 81-048-290-1800
Fax: 81-048-290-1820

Web Site: <http://www.aopen.com.tw>

E-mail: Send us email by going through the contact form below.

English <http://english.aopen.com.tw/tech/default.htm>

Japanese <http://www.aopen.co.jp/tech/default.htm>

Chinese <http://www.aopen.com.tw/tech/default.htm>

German <http://www.aopencom.de/tech/default.htm>

Simplified Chinese <http://www.aopen.com.cn/tech/default.htm>

