

AX4GE FM

Online Manual

DOC. NO.: AX4GEFM-OL-E0209A





What's in this manual

AX4GE FM	1
<i>What's in this manual</i>	2
<i>You Must Notice</i>	9
<i>Before You Start</i>	10
<i>Overview</i>	11
<i>Feature Highlight</i>	12
<i>Quick Installation Procedure</i>	16
<i>Motherboard Map</i>	17
<i>Block Diagram</i>	18
Hardware Installation.....	19
<i>About "Manufacturer Upgrade Optional" and "User Upgrade Optional"</i>	20
<i>JP14 Clear CMOS Data</i>	21
<i>CPU Installation</i>	22
<i>CPU Jumper-less Design</i>	25
<i>CPU Core Voltage Auto Detectable</i>	27
<i>CPU and System Fan Connector (with H/W Monitoring)</i>	30
<i>JP28 Keyboard/Mouse Wake-up Enable/Disable Jumper</i>	31



<i>DIMM Sockets</i>	32
<i>Front Panel Connector</i>	34
<i>ATX Power Connector</i>	35
<i>STBY LED and BOOT LED</i>	36
<i>AC Power Auto Recovery</i>	37
<i>IDE and Floppy Connector</i>	38
<i>IrDA Connector</i>	40
<i>S/PDIF (Sony/Philips Digital Interface) Connector</i>	41
<i>Super 5.1 Channel Audio Effect</i>	42
<i>AGP Slot</i>	43
<i>AGP Protection Technology</i>	44
<i>ADD Card (Intel 845GE chipset supported)</i>	45
<i>WOM (Zero Voltage Wake on Modem) Connector</i>	46
<i>WOM by External BOX Modem</i>	47
<i>WOM by Internal Modem Card</i>	48
<i>WOL (Wake on LAN)</i>	49
<i>CNR (Communication and Network Riser) Expansion Slot</i>	51
<i>PC99 Color Coded Back Panel</i>	52
<i>Support 10/100 Mbps LAN onboard</i>	53

JP13 LAN Enable/Disable Jumper	54
Support Six USB2.0 Connectors	55
Chassis Intrusion Connector	56
CD Audio Connector	57
AUX-IN Connector	58
Front Audio Connector	59
Dr. LED Connector	60
JP15/JP16 Dr. Voice III Language Select Jumpers	62
JP2 Buzzer/Speaker Select Jumper	63
Battery-less and Long Life Design	64
CPU Over-current Protection	65
 AConfig Utility	66
Die-Hard BIOS and JP24 Die-Hard BIOS Select Jumper	68
Resetable Fuse	69
3300µF Low ESR Capacitor	70
Layout (Frequency Isolation Wall)	71
Enlarged Aluminum Heatsink	72
 FM Radio Card	73
 The noise is gone!! ---- Silent PC	75



Open JukeBox FM Player 79

Driver and Utility 83

Auto-run Menu from Bonus CD Disc 84

Installing Intel® Chipset Software Installation Utility..... 85

Intel VGA driver..... 86

Installing Intel IAA Driver..... 87

Installing Onboard Sound Driver 88

Installing LAN Driver 90

Installing USB2.0 Driver..... 92

PHOENIX-AWARD BIOS..... 94

About BIOS Function Description..... 95

How To Use Phoenix-Award™ BIOS Setup Program 96

How To Enter BIOS Setup..... 98

BIOS Upgrade under Windows environment 99

Overclocking 101

VGA Card & Hard Disk..... 102

Glossary 103

AC97..... 103

ACPI (Advanced Configuration & Power Interface) 103



<i>AGP (Accelerated Graphic Port)</i>	103
<i>AMR (Audio/Modem Riser)</i>	104
<i>AOpen Bonus Pack CD</i>	104
<i>APM (Advanced Power Management)</i>	104
<i>ATA (AT Attachment)</i>	104
<i>ATA/66</i>	104
<i>ATA/100</i>	105
<i>ATA/133</i>	105
<i>BIOS (Basic Input/Output System)</i>	105
<i>Bus Master IDE (DMA mode)</i>	106
<i>CNR (Communication and Networking Riser)</i>	106
<i>CODEC (Coding and Decoding)</i>	106
<i>DDR (Double Data Rated) SDRAM</i>	106
<i>DIMM (Dual In Line Memory Module)</i>	107
<i>DMA (Direct Memory Access)</i>	107
<i>ECC (Error Checking and Correction)</i>	107
<i>EDO (Extended Data Output) Memory</i>	107
<i>EEPROM (Electronic Erasable Programmable ROM)</i>	108
<i>EPROM (Erasable Programmable ROM)</i>	108

EV6 Bus 108

FCC DoC (Declaration of Conformity) 108

FC-PGA (Flip Chip-Pin Grid Array) 109

Flash ROM 109

FSB (Front Side Bus) Clock 109

I²C Bus 109

IEEE 1394 110

Parity Bit 110

PBSRAM (Pipelined Burst SRAM) 110

PC-100 DIMM 111

PC-133 DIMM 111

PC-1600, PC-2100 or PC-2700 DDR DRAM 111

PCI (Peripheral Component Interface) Bus 111

PDF Format 112

PnP (Plug and Play) 112

POST (Power-On Self Test) 112

RDRAM (Rambus DRAM) 112

RIMM (Rambus Inline Memory Module) 113

SDRAM (Synchronous DRAM) 113



<i>Shadow E²PROM</i>	113
<i>SIMM (Single In Line Memory Module)</i>	113
<i>SMBus (System Management Bus)</i>	114
<i>SPD (Serial Presence Detect)</i>	114
<i>Ultra DMA</i>	114
<i>USB (Universal Serial Bus)</i>	115
<i>USB2.0 (Universal Serial Bus)</i>	115
<i>VCM (Virtual Channel Memory)</i>	115
<i>ZIP file</i>	115
Troubleshooting	116
Technical Support	120
Product Registration	123
How to Contact Us	124

You Must Notice



Adobe, the Adobe logo, Acrobat is trademarks of Adobe Systems Incorporated.

AMD, the AMD logo, Athlon and Duron are trademarks of Advanced Micro Devices, Inc.

Intel, the Intel logo, Intel Celeron, Pentium II, Pentium III, Pentium 4 are trademarks of Intel Corporation.

Microsoft, Windows, and Windows logo are either registered trademarks or trademarks of Microsoft Corporation in the United States and/or other countries.

All product and brand names used on this manual are used for identification purposes only and may be the registered trademarks of their respective owners.

All of the specifications and information contained in this manual are subject to change without notice. AOpen reserves the right to revise this publication and to make reasonable changes. AOpen assumes no responsibility for any errors or inaccuracies that may appear in this manual, including the products and software described in it.

This documentation is protected by copyright law. All rights are reserved.

No part of this document may be used or reproduced in any form or by any means, or stored in a database or retrieval system without prior written permission from AOpen Corporation.

Copyright© 1996-2002, AOpen Inc. All Rights Reserved.



Before You Start

This Online Manual will introduce to the user how this product is installed. All useful information will be described in later chapters. Please keep this manual carefully for future upgrades or system configuration changes. This Online Manual is saved in [PDF format](#), we recommend using Adobe Acrobat Reader 4.0 for online viewing, it is included in [Bonus CD disc](#) or you can get free download from [Adobe web site](#).

Although this Online Manual is optimized for screen viewing, it is still capable for hardcopy printing, you can print it by A4 paper size and set 2 pages per A4 sheet on your printer. To do so, choose **File > Page Setup** and follow the instruction of your printer driver.

Thanks for the help of saving our earth.

Overview

Thank you for choosing AOpen AX4GE FM motherboard. The AX4GE FM is Intel® Socket 478 motherboard (M/B) based on the ATX form factor featuring the [Intel® 845GE \(Brookdale\) chipset](#). As high performance chipset built in the M/B, the AX4GE FM motherboard can support Intel® Socket 478 Pentium® 4 (Brookdale) and 400/533 MHz [Front Side Bus \(FSB\)](#) clock. According to different customer's requirements, the Intel 845GE chipset memory interface supports DDR333/266 SDRAM devices with densities of 64, 128, 256, 512Mb DDR RAM DIMM modules and the maximum memory size can be up to 2 GB (Please note that only CPU FSB 533 supports DDR333). The onboard IDE controller supports [Ultra DMA 33/66/100](#) mode and the transfer rate up to 100MB/s. Further flexibility can be achieved by taking advantage of the [Communication and Network Riser \(CNR\)](#) card option that allows audio, modem configuration on a single baseboard design. More than that, on the strength of RealTek RTL8100BL controller on board, which is a highly integrated Platform LAN Connect device, it provides 10/100M bps Ethernet for office and home use. Besides, the AX4GE FM has an [AC97 CODEC](#) chipset onboard, providing high performance and magic surround stereo sound to let people enjoy working with it. Now, let's enjoy all features from AOpen AX4GE FM motherboard.

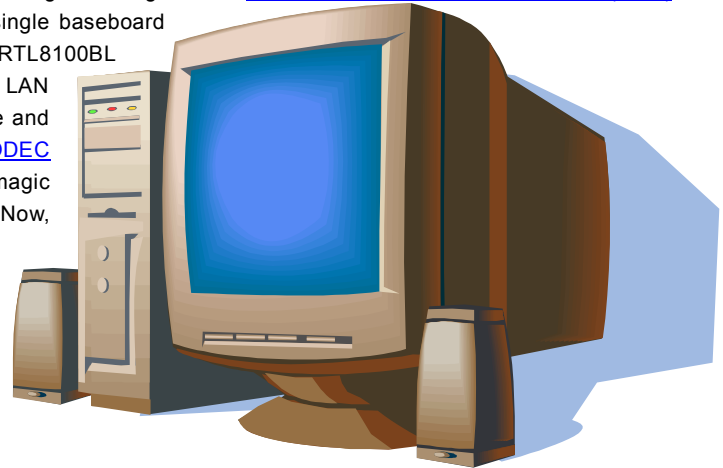

Feature Highlight

CPU

Supports Intel® Socket 478 Pentium® 4 1.4GHz~2.80GHz+ with 400/533MHz [Front Side Bus \(FSB\)](#) designed for Socket 478 technology.

Chipset

With the Intel® 845GE chipset, Intel delivers a discrete graphics solution with all the performance, innovative features and proven reliability of the Intel® 845GE chipset. With its highly scalable design, the new 845GE chipset offers an ideal, leading-edge AGP graphics solution for Intel® Pentium® 4 processor platforms. And the smart integration in the Intel 845GE chipset's I/O Controller Hub (ICH4) features USB controllers supporting six USB ports. With support for 5.1 channels of AC'97 audio and the ability to make the most of soft audio/modem technology, the 845GE chipset delivers an ideal solution for innovative new form factors.

Expansion Slots

Including six 32-bit/33MHz PCI, one CNR and one AGP 4X slots. The [PCI](#) local bus throughput can be up to 132MB/s. The [Communication & Networking Riser \(CNR\)](#) slot provided from AX4GE FM can support CNR interface for a Modem/Audio/LAN card. The [Accelerated Graphics Port \(AGP\)](#) specification provides a new level of video display sophistication and speed which supports data transfer rate up to 1056MB/s. AX4GE FM motherboard can support 4X mode. Of six PCI slots provided, all of them are master PCI slots with arbitration and decoding for all integrated functions and LPC bus.

Memory

Provides three 184-pin DDR [RAM](#) DIMM sockets that support up to 2GB of [PC-266/333](#) compliant DDR RAM (Synchronous Dynamic Random Access Memory). You may install 64, 128, 256, 512Mb DDR RAM DIMM modules into each socket. (Please note that only CPU FSB 533 supports DDR333).

LAN Port

On the strength of RealTek RTL8100BL controller on board, which is a highly-integrated Platform LAN Connect device, it provides 10/100 Mbps Ethernet for office and home use.

Ultra DMA 33/66/100 Bus Master IDE

Comes with an on-board PCI Bus Master IDE controller with two connectors that supports four IDE devices in two channels, supports [Ultra DMA](#) 33/66/100, PIO Modes 3 and 4 and Bus Master IDE DMA Mode 5, and supports Enhanced IDE devices.

On-board AC'97 Sound

AX4GE FM uses the [AC97](#) sound chip. This on-board audio includes a complete audio recording and playback system.

1MHz Stepping Frequency Adjustment

Provides "1MHz Stepping Frequency Adjustment" function in the BIOS. This magic function allows you adjust [FSB](#) frequency from 100~248 by 1MHz stepping adjustment, and lets your system can get maximum performance.

Watch Dog Timer

Includes AOpen "Watch Dog Timer" function that can auto-reset default settings in 4.8 seconds when you fail to system overclocking.

S/PDIF Connectors

S/PDIF (Sony/Philips Digital Interface) is a newest audio transfer file format, which provides impressive quality through optical fiber and allows you to enjoy digital audio instead of analog audio.

Six USB2.0 Connectors

Provides three ports, six [USB](#) connectors for USB interface devices, such as mouse, keyboard, modem, scanner, etc. Compared to traditional USB 1.0/1.1 with the speed of 12Mbps, USB 2.0 has a fancy speed up to 480Mbps, which is 40 times faster than the traditional one.

Dr. LED (User Upgrade Optional)

The [Dr. LED](#) has 8 LEDs on this AX4GE FM M/B to easily show what kind of problems you may encounter.

Power Management/Plug and Play

Supports the power management function that conforms to the power-saving standards of the U.S. Environmental Protection Agency (EPA) Energy Star program. It also offers [Plug-and-Play](#), which helps save users from configuration problems, thus making the system much user-friendlier.

Hardware Monitoring Management

Supports CPU or system fans status, temperature and voltage monitoring and alert, through the on-board hardware monitor module.

Enhanced ACPI

Fully implement the [ACPI](#) standard for Windows® 98/ME/2000/XP series compatibility, and supports Soft-Off, STR (Suspend to RAM, S3), STD (Suspend to Disk, S4) features.

Super Multi-I/O

Provides two high-speed UART compatible serial ports and one parallel port with EPP and ECP capabilities. UART can also be directed from COM1 to the Infrared Module for the wireless connections.

Quick Installation Procedure

This page gives you a quick procedure on how to install your system. Follow each step accordingly.

1. [Installing CPU and Fan](#)
2. [Installing System Memory \(DIMM\)](#)
3. [Connecting Front Panel Cable](#)
4. [Connecting IDE and Floppy Cable](#)
5. [Connecting ATX Power Cable](#)
6. [Connecting Back Panel Cable](#)
7. [Power-on and Load BIOS Setup Default](#)
8. [Setting CPU Frequency](#)
9. Reboot
10. Installing Operating System (such as Windows 98)
11. [Installing Driver and Utility](#)

Motherboard Map

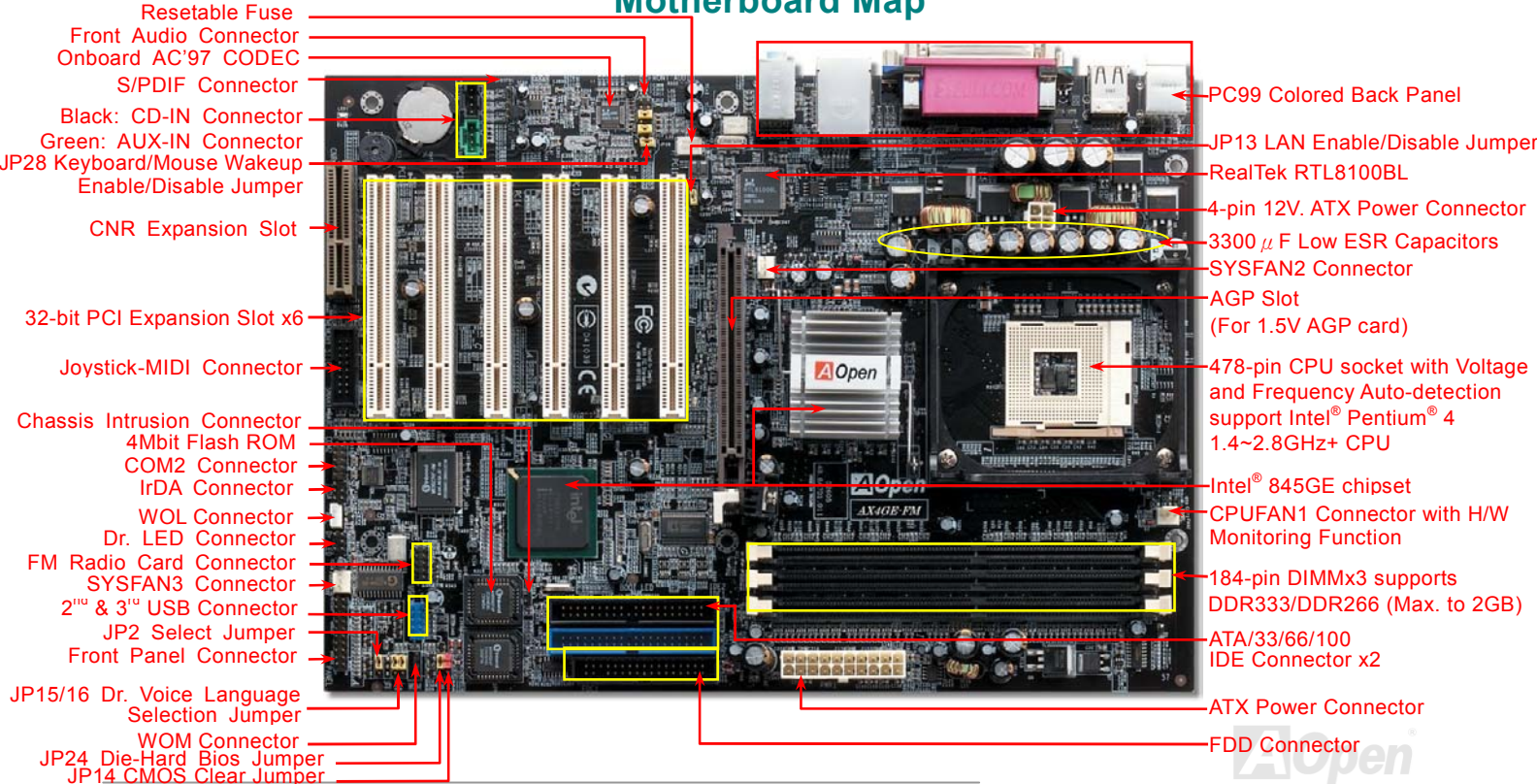

Block Diagram

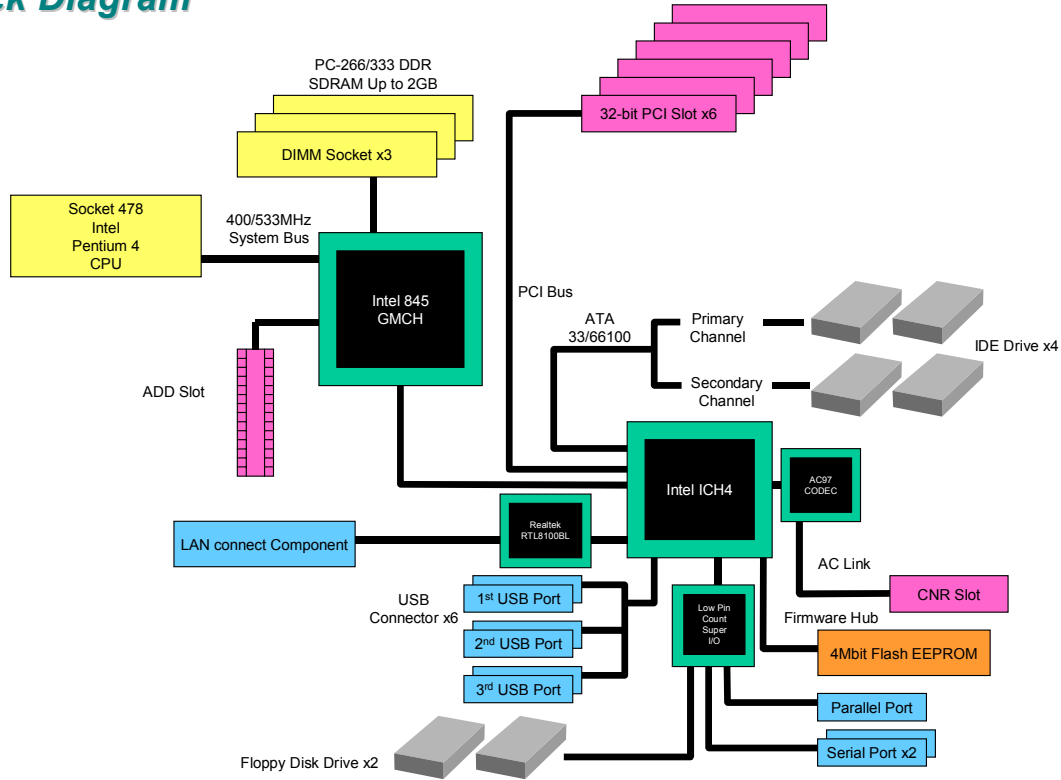

Hardware Installation

This chapter describes jumpers, connectors and hardware devices of this motherboard.



Note: *Electrostatic discharge (ESD) can damage your processor, disk drives, expansion boards, and other components. Always observe the following precautions before you install a system component.*

1. *Do not remove a component from its protective packaging until you are ready to install it.*
2. *Wear a wrist ground strap and attach it to a metal part of the system unit before handling a component. If a wrist strap is not available, maintain contact with the system unit throughout any procedure requiring ESD protection.*

About “Manufacturer Upgrade Optional” and “User Upgrade Optional”...

When you read this online manual and start to assemble your computer system, you may find some of functions are called “Manufacturer Upgrade Optional”, and some are called “User Upgrade Optional”. Though all AOpen motherboards include many amazing and powerful features, in some situations, these powerful features are not used to every user. Hence, we changed some key features as “Manufacturer Upgrade Optional” for you to choose. Some optional functions that can be upgraded by users, we call them “User Upgrade Optional”. As for those optional functions that can't be upgraded by ourselves, we call them “Manufacturer Upgrade Optional”. If needed, you can contact our local distributors or resellers for purchasing “User Upgrade Optional” components, and again you can visit AOpen official web site: www.aopen.com for more detail information.



JP14 Clear CMOS Data

You can clear CMOS to restore system default setting. To clear the CMOS, follow the procedure below.

1. Turn off the system and unplug the AC power.
2. Remove ATX power cable from connector PWR2.
3. Locate JP14 and short pins 2-3 for a few seconds.
4. Return JP14 to its normal setting by shorting pins 1 & pin2.
5. Connect ATX power cable back to connector PWR2.

Pin 1

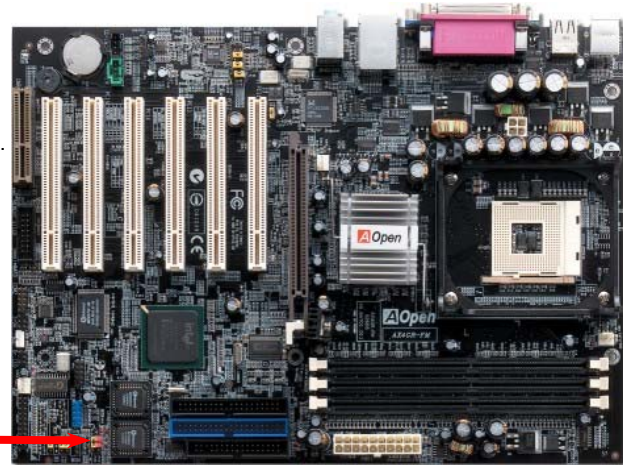
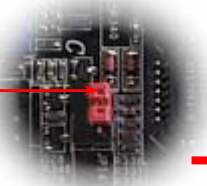

Normal Operation
(default)



Clear CMOS

Tip: When should I Clear CMOS?

1. Boot fail because of overclocking...
2. Forget password...
3. Troubleshooting...

CPU Installation

This motherboard supports Intel® Pentium 4 Socket 478 series CPU. Be careful of CPU orientation when you plug it into CPU socket.

1. Pull up the CPU socket lever and up to 90-degree angle.

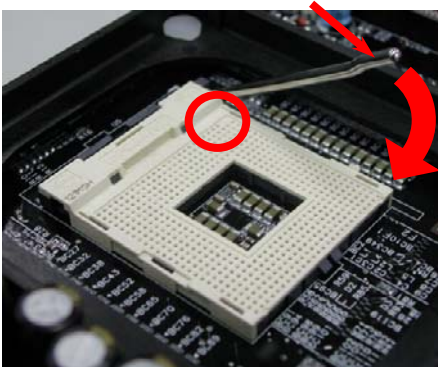

2. Locate Pin 1 in the socket and look for a cut edge on the CPU upper interface. Match Pin 1 and cut edge, then insert the CPU into the socket.

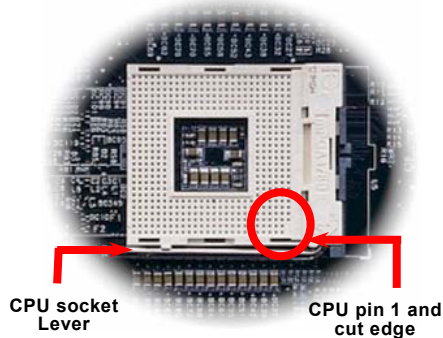

Note: These pictures are for example only, it may not exactly be the same motherboard.

3. Press down the CPU socket lever and finish CPU installation.

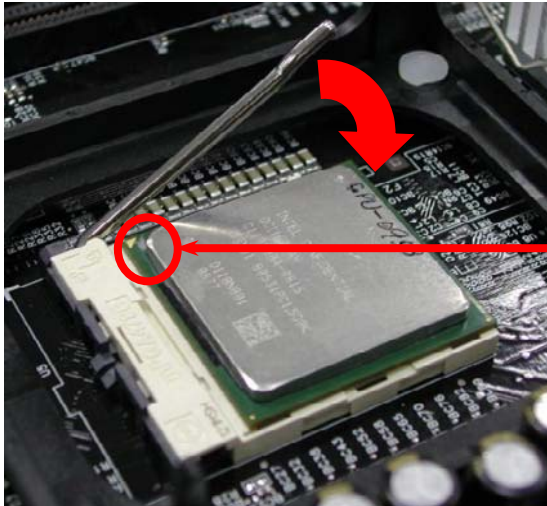

CPU cut edge

Note: If you do not match the CPU socket Pin 1 and CPU cut edge well, it may damage the CPU.

Note: This socket supports Micro-FC-PGA2 package CPU, which is the latest CPU package developed by Intel. Other forms of CPU package are impossible to be fitted in.

Note: This picture is for example only, it may not exactly be the same motherboard.

CPU Fan Installation

This motherboard comes with a retention module attached on the CPU socket when shipped, we strongly recommend you to install AOpen special designed CPU Fan as shown below on the retention module for better heat dissipation. Please install the CPU Fan correctly as the following pictures shown.

1. Gently put the CPU Fan down on the retention module with clips aligning correctly to the four corners.

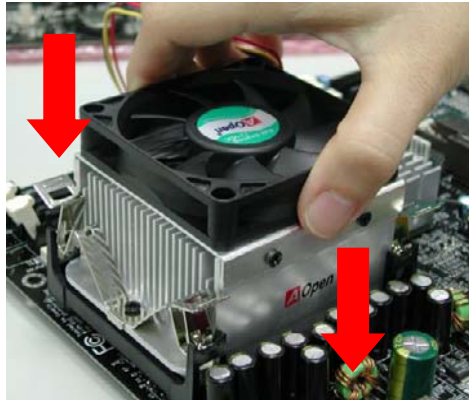

2. Pressing down the four clips with force one by one on the retention module.

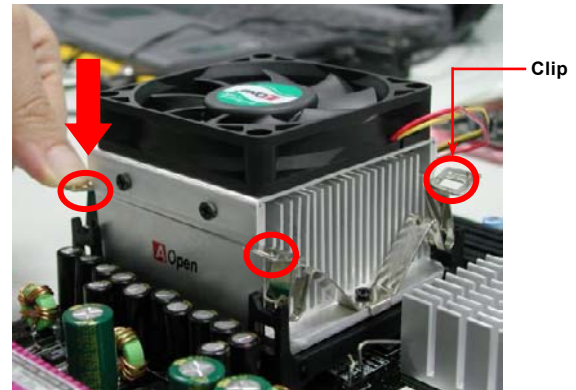

CPU Jumper-less Design

CPU VID signal and [SMBus](#) clock generator provide CPU voltage auto-detection and allows the user to set the CPU frequency through the [BIOS setup](#), therefore no jumpers or switches are used. The disadvantages of the Pentium based jumper-less designs are eliminated. There will be no worry of wrong CPU voltage detection.

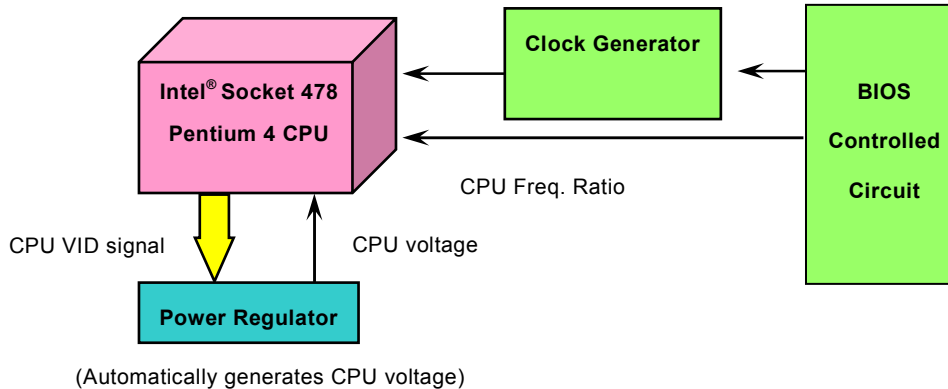

AOpen “Watch Dog Timer”



With this motherboard, AOpen provides a very special, useful feature for overclockers. When you power-on the system, the BIOS will check last system [POST](#) status. If it succeeded, the BIOS will enable “Watch Dog Timer” function immediately, and set the CPU [FSB](#) frequency by user’s setting that stored in the BIOS. If system failed in BIOS POST, the “Watch Dog Timer” will reset the system to reboot in five seconds. Then, BIOS will detect the CPU’s default frequency and POST again. With this special feature, you can easily overclock your system to get higher system performance, and without removing the cover of system housing to set the jumper to clear CMOS data when your system hanged.

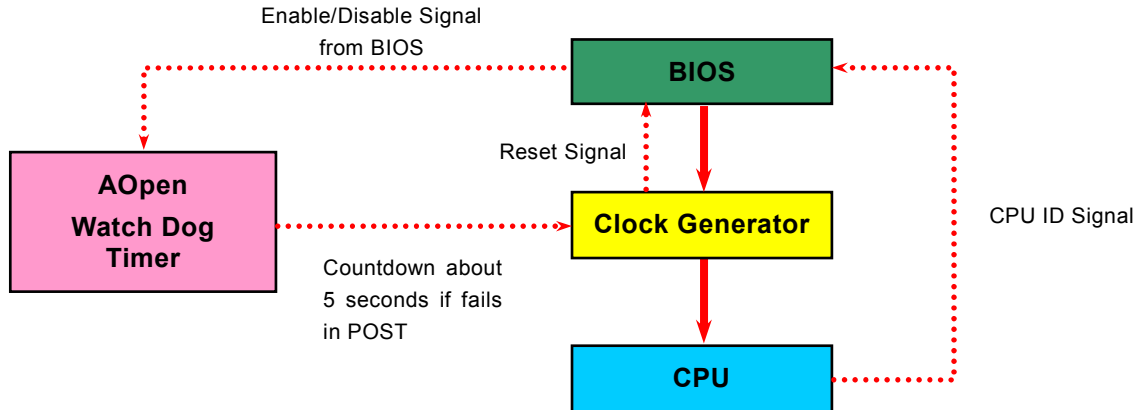

CPU Core Voltage Auto Detectable

The CPU core voltage will be automatically detected. It is not necessary to set CPU core voltage.

Setting CPU Frequency

BIOS Setup > Frequency/Voltage Control > CPU Clock Setting

This motherboard is CPU jumper-less design, you can set CPU frequency through the BIOS setup, and no jumpers or switches are needed.

CPU Ratio	8x, 9x, 10x,...22x, 23x, 24x
CPU FSB	100~248MHz



Tip: If your system hangs or fails to boot because of overclocking, simply use <Home> key to restore the default setting or you can wait the AOpen "Watch Dog Timer" reset the system after five seconds and system will auto-detect hardware again.

Core Frequency = CPU FSB Clock * CPU Ratio

PCI Clock = CPU FSB Clock / Clock Ratio

AGP Clock = PCI Clock x 2

Northwood CPU	CPU Core Frequency	FSB Clock	System Bus	Ratio
Pentium 4 1.6G	1600MHz	100MHz	400MHz	16x
Pentium 4 1.6G	1600MHz	133MHz	533MHz	12x
Pentium 4 1.7G	1700MHz	133MHz	533MHz	13x
Pentium 4 1.8G	1800MHz	100MHz	400MHz	18x
Pentium 4 2.0G	2000MHz	100MHz	400MHz	20x
Pentium 4 2.2G	2200MHz	100MHz	400MHz	22x
Pentium 4 2.26G	2260MHz	133MHz	533MHz	17x
Pentium 4 2.4G	2400MHz	100MHz	400MHz	24x
Pentium 4 2.4G	2400MHz	133MHz	533MHz	18x
Pentium 4 2.53G	2530MHz	133MHz	533MHz	19x
Pentium 4 2.66G	2660MHz	133MHz	533MHz	20x
Pentium 4 2.80G	2800MHz	133MHz	533MHz	21x

Note: Since the latest processor, Northwood, would detect the clock ratio automatically, you may not be able to adjust the clock ratio in BIOS manually.

Willamette CPU	CPU Core Frequency	FSB Clock	System Bus	Ratio
Pentium 1.8G	4 1800MHz	100MHz	400MHz	18x
Pentium 1.9G	4 1900MHz	100MHz	400MHz	19x
Pentium 2.0G	4 2000MHz	100MHz	400MHz	20x

Celeron CPU	CPU Core Frequency	FSB Clock	System Bus	Ratio
1.7G	1700MHz	100MHz	400MHz	17x
1.8G	1800MHz	100MHz	400MHz	18x

Warning: Intel® 845GE chipset supports maximum 400/533MHz (100/133MHz*4) system bus and 66MHz AGP clock; higher clock setting may cause serious system damage.

CPU and System Fan Connector (with H/W Monitoring)

Plug in the CPU fan cable to the 3-pin **CPUFAN1** connector. If you have chassis fan, you can also plug it on **SYSFAN2** or **SYSFAN3** connector.

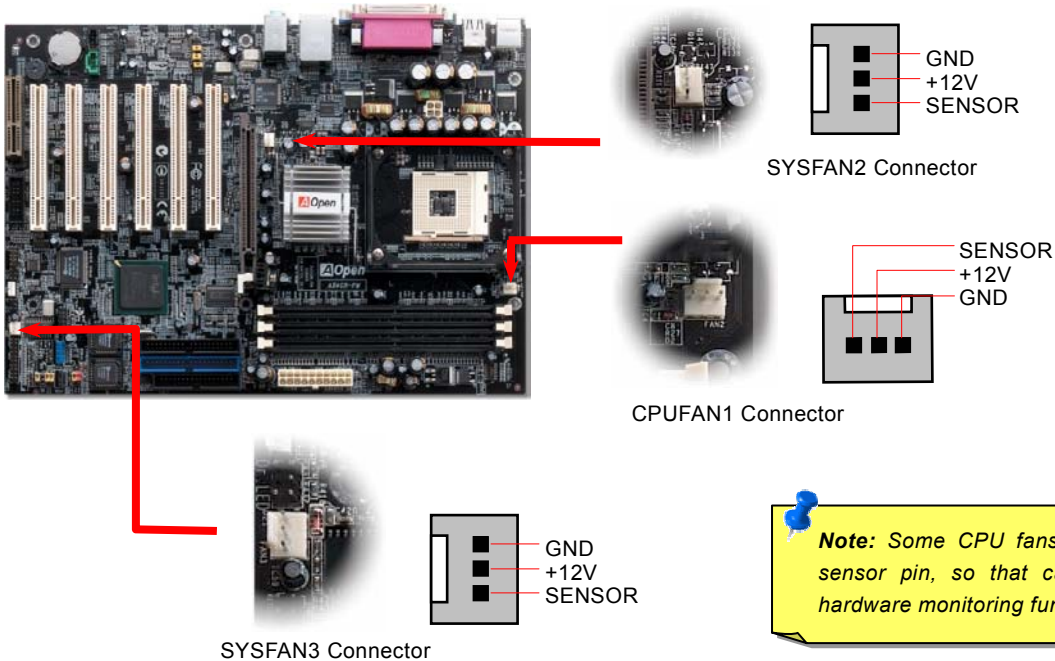

Note: Some CPU fans do not have sensor pin, so that cannot support hardware monitoring function.



JP28 Keyboard/Mouse Wake-up Enable/Disable Jumper

This motherboard provides keyboard / mouse wake-up function. You can use JP28 to enable or disable this function, which could resume your system from suspend mode with keyboard or mouse installed. The factory default setting is set to "Disable"(1-2), and you may enable this function by setting the jumper to 2-3.

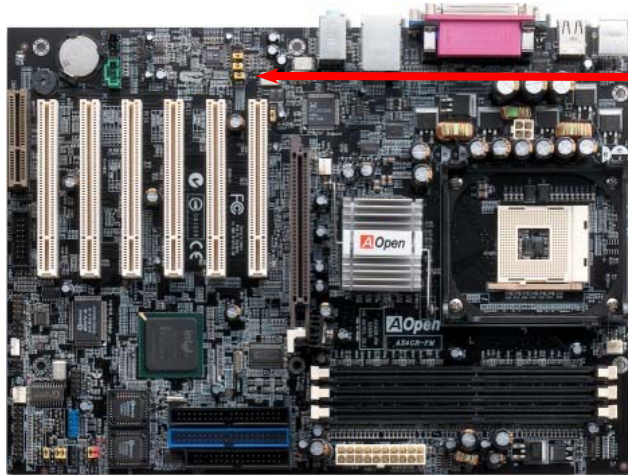

JP28

KB/Mouse Wake-up

Pin 1



Disable
(Default)



Enable

DIMM Sockets

This motherboard has three 184-pin DDR [DIMM](#) sockets that allow you to install [PC266](#) or [PC333](#) memory up to 2 GB. Only Non-ECC DDR RAM are supported, otherwise, it will cause serious damage on memory sockets or SDRAM module (Please note that only CPU FSB 533 supports DDR333).

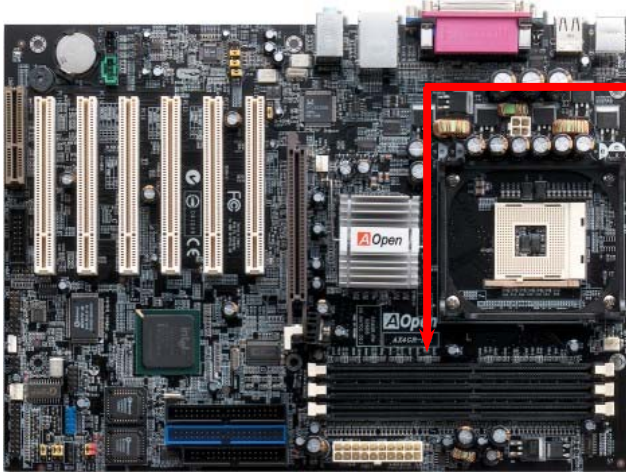

DIMM1
DIMM2
DIMM3

Warning: Please note that double-side DDR RAM is not allowed to be installed on both DIMM2 and DIMM3. But if you have had installed two double-side DDR RAM on them, the system can only read one side DDR RAM on each DIMM2 and DIMM3. However, you are not recommended to do so, otherwise, it will cause serious damage on memory sockets or SDRAM module.

How to Install Memory Modules

Please follow the procedure as shown below to finish memory installation.

1. Make sure the DIMM module's pin face down and match the socket's size as depicted below.



2. Insert the module straight down to the DIMM slot with both hands and press down firmly until the DIMM module is securely in place.

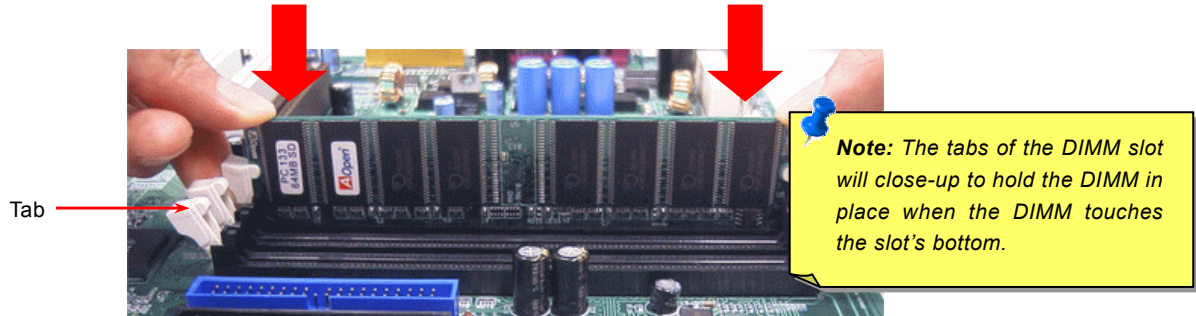

3. Repeat step 2 to finish additional DIMM modules installation.

Front Panel Connector



Attach the power LED, speaker, power and reset switch connectors to the corresponding pins. If you enable “Suspend Mode” item in BIOS Setup, the ACPI & Power LED will keep flashing while the system is in suspend mode.

Locate the power switch cable from your ATX housing. It is 2-pin female connector from the housing front panel. Plug this connector to the soft-power switch connector marked **SPWR**.

Suspend Type	ACPI LED
Power on Suspend (S2) or Suspend to RAM (S3)	Flashing for every second
Suspend to Disk (S4)	The LED will be turned off

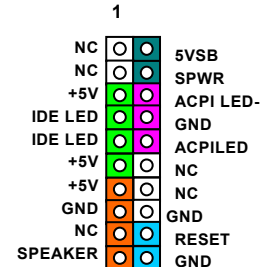
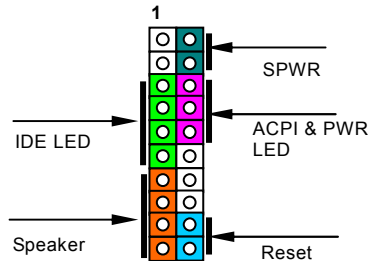
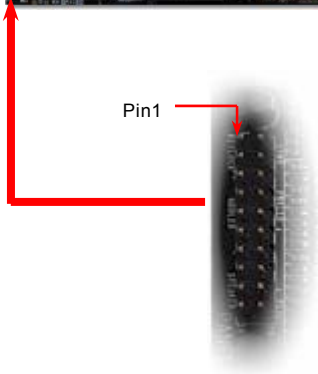

ATX Power Connector

This motherboard comes with a 20-pin and 4-pin ATX power connector. Make sure you plug in the right direction. We strongly recommend you to connect the 4-pin 12V ATX power connector before connecting the 20-pin ATX power connector and use standard power supply specially designed for Pentium 4 system.

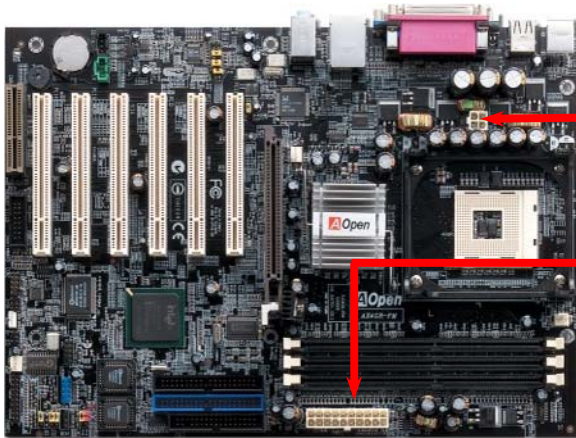

Pin1

4-Pin 12V ATX Power Connector

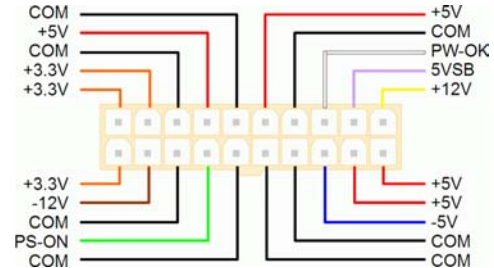
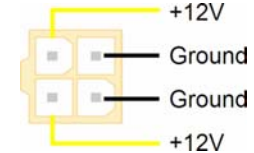

20-Pin Power Connector



STBY LED and BOOT LED

Both STBY LED and BOOT LED are AOpen's considerate designs that we aim at providing you friendly system information. The STBY LED will light up when power is provided to the motherboard. This is a convenient indication for you to check the system power status in many circumstances such as power on/off, stand-by mode and RAM power status during [Suspend to RAM mode](#).

BOOT LED will keep blinking when you power the system on and when your system is under [POST \(Power-On Self Test\)](#). After POST diagnoses everything alright and finishes the booting, the LED will stay on otherwise it will remain flashing to warn you that mistakes have occurred during POST.

STBY LED



Warning: Do not install or remove the DIMM module or others devices when the STBY

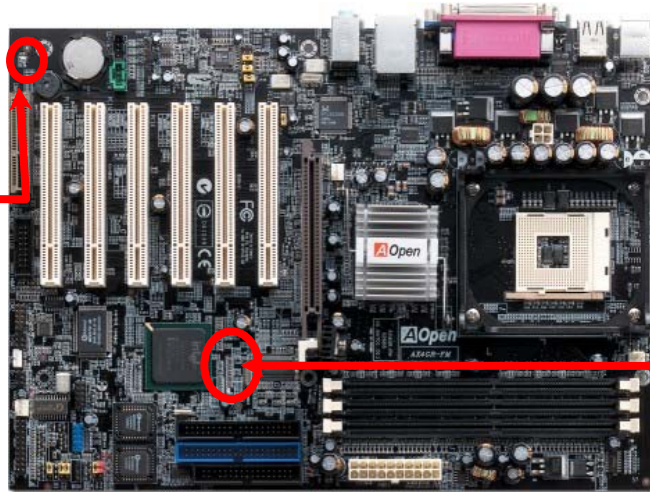

BOOT LED

AC Power Auto Recovery

A traditional ATX system should remain at power off stage when AC power resumes from power failure. This design is inconvenient for a network server or workstation, without an UPS, that needs to keep power-on. This motherboard implements an AC Power Auto Recovery function to solve this problem.



IDE and Floppy Connector

Connect 34-pin floppy cable and 40-pin IDE cable to floppy connector FDC and IDE connector. The blue connector is IDE1 for clear identification. Be careful of the pin1 orientation. Wrong orientation may cause system damage.

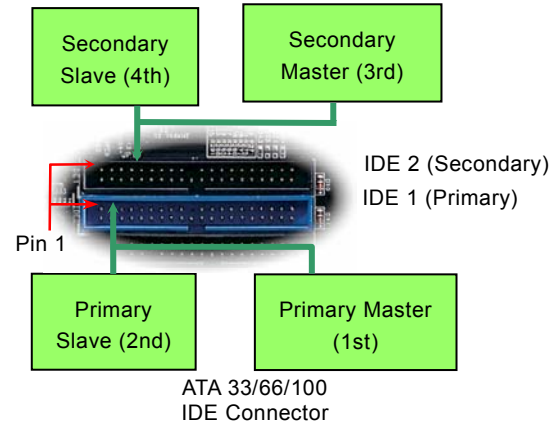
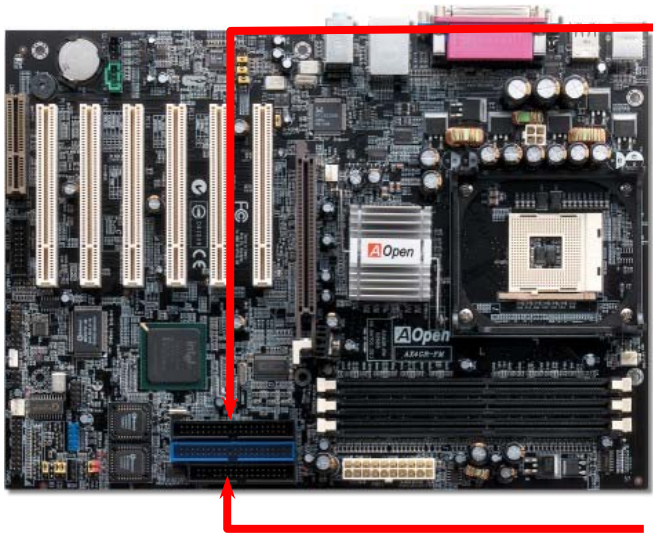

IDE1 is also known as the primary channel and IDE2 as the secondary channel. Each channel supports two IDE devices that make a total of four devices. In order to work together, the two devices on each channel must be set differently to **Master** and **Slave** mode. Either one can be the hard disk or the CDROM. The setting as master or slave mode depends on the jumper on your IDE device, so please refer to your hard disk and CDROM manual accordingly.

This motherboard supports [ATA33](#), [ATA66](#) or [ATA100](#) IDE devices. Following table lists the transfer rate of IDE PIO and DMA modes. The IDE bus is 16-bit, which means every transfer is two bytes.

Mode	Clock Period	Clock Count	Cycle Time	Data Transfer Rate
PIO mode 0	30ns	20	600ns	(1/600ns) x 2byte = 3.3MB/s
PIO mode 1	30ns	13	383ns	(1/383ns) x 2byte = 5.2MB/s
PIO mode 2	30ns	8	240ns	(1/240ns) x 2byte = 8.3MB/s
PIO mode 3	30ns	6	180ns	(1/180ns) x 2byte = 11.1MB/s
PIO mode 4	30ns	4	120ns	(1/120ns) x 2byte = 16.6MB/s
DMA mode 0	30ns	16	480ns	(1/480ns) x 2byte = 4.16MB/s
DMA mode 1	30ns	5	150ns	(1/150ns) x 2byte = 13.3MB/s
DMA mode 2	30ns	4	120ns	(1/120ns) x 2byte = 16.6MB/s
ATA 33	30ns	4	120ns	(1/120ns) x 2byte x2 = 33MB/s
ATA 66	30ns	2	60ns	(1/60ns) x 2byte x2 = 66MB/s
ATA100	20ns	2	40ns	(1/40ns) x 2byte x2 = 100MB/s

Warning: The specification of the IDE cable is a maximum of 46cm (18 inches); make sure your cable does not exceed this length.

Tip:

- For better signal quality, it is recommended to set the far end side device to master mode and follow the suggested sequence to install your new device. Please refer to above diagram
- To achieve the best performance of Ultra DMA 33/66/100 hard disks, a special **80-wires IDE cable** for Ultra DMA 33/66/100 is required.



IrDA Connector

The IrDA connector can be configured to support wireless infrared module, with this module and application software such as Laplink or Windows 95 Direct Cable Connection, the user can transfer files to or from laptops, notebooks, PDA devices and printers. This connector supports HPSIR (115.2Kbps, 2 meters) and ASK-IR (56Kbps).

Install the infrared module onto the **IrDA** connector and enable the infrared function from BIOS Setup, UART Mode, make sure to have the correct orientation when you plug in the IrDA connector.

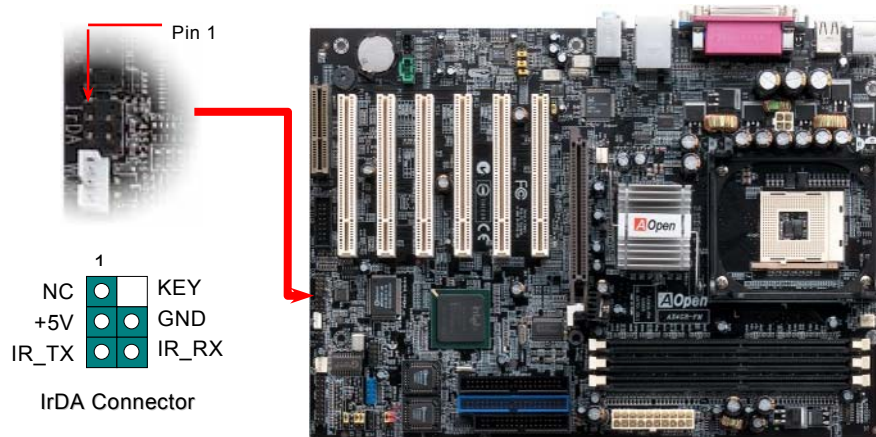



S/PDIF (Sony/Philips Digital Interface) Connector

S/PDIF (Sony/Philips Digital Interface) is a newest audio transfer file format, which provides impressive audio quality through optical fiber and allows you to enjoy digital audio instead of analog audio. Normally there are two S/PDIF outputs as shown, one for RCA connector, the most common one used for consumer audio products, and the other for optical connector with better audio quality. Through a specific audio cable, you can connect the S/PDIF connector to other end of the S/PDIF audio module, which bears S/PDIF digital output. However, you must have a S/PDIF supported speaker/amplifier/decoder with S/PDIF digital input to connect to the S/PDIF digital output to make the most out of this function.

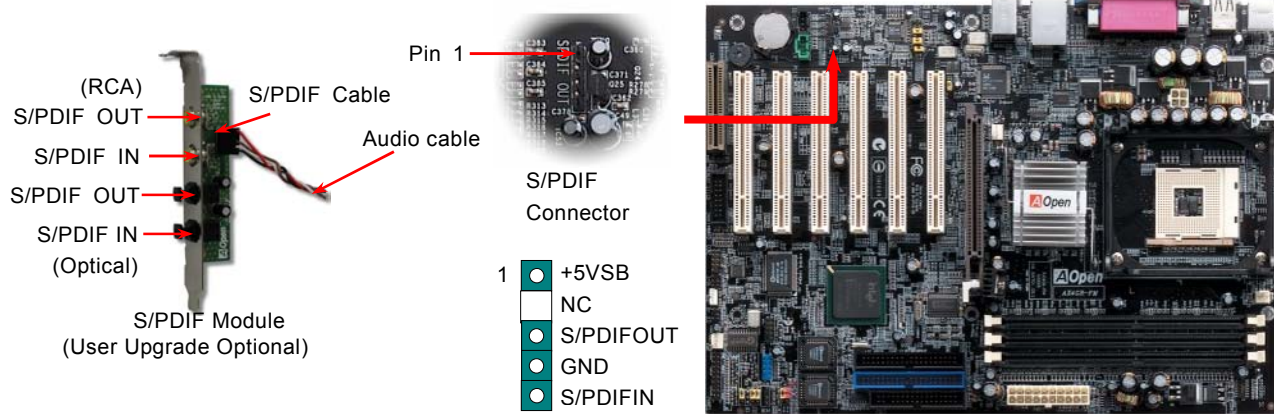



Super 5.1 Channel Audio Effect

This motherboard comes with an ALC650 CODEC, which supports high quality of 5.1 Channel audio effect, bringing you a brand new audio experience. On the strength of the innovative design of ALC650, you're able to use standard line-jacks for surround audio output without connecting any external module. To apply this function, you have to install the audio driver in the Bonus Pack CD as well as an audio application supporting 5.1 Channel. Picture bellow represents the standard location of all speakers in 5.1 Channel sound track. Please connect the plug of your front speakers to the green "Speaker out" port, rear speakers' plug to the blue "Line in" port and both of the center and subwoofer speakers to the red "MIC in" port.

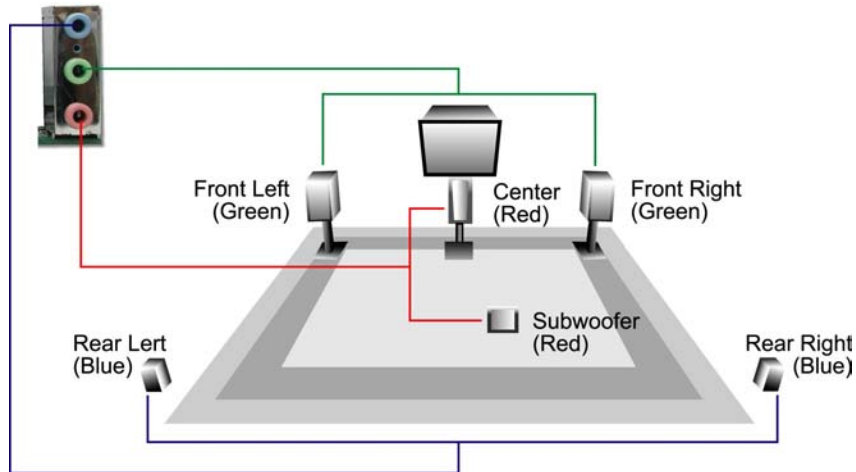



AGP Slot

With Intel 845GE chipset implemented, this AGP slot could automatically become an AGP slot or a Multiplexed Intel DVO Output depending on what kind of cards inserted, like AGP, or ADD (AGP Digital Display) cards. With ADD card cabled to this slot, Multiplexed Intel DVO output could provide high-speed digital connection for digital displays or TV-OUT functionality. As for AGP function, it supports 1.5V AGP card only, please do not insert 3.3V AGP card, otherwise, it could cause serious damage to the motherboard.

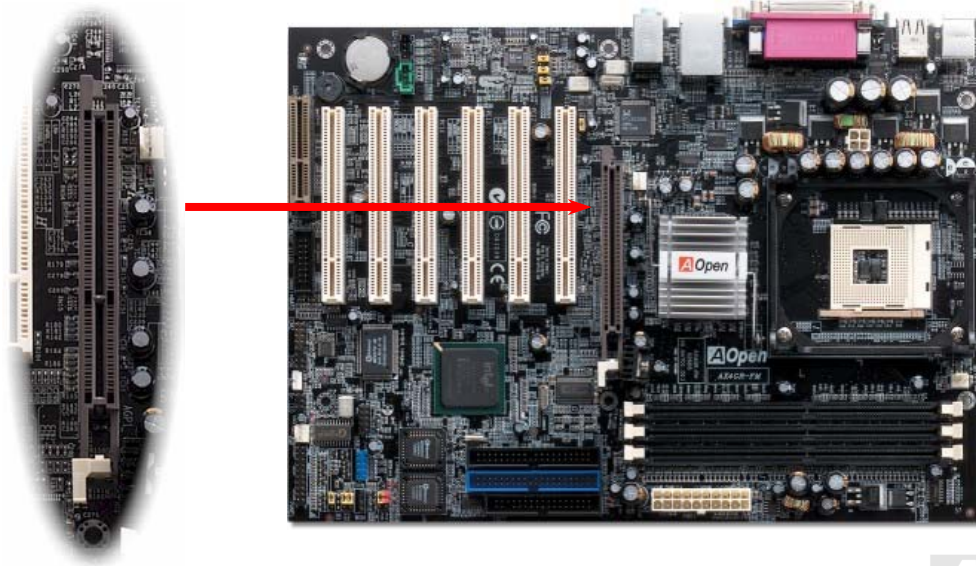

AGP Protection Technology

With the outstanding R&D ability of AOpen and its specially developed circuit, AX4GE FM implements a brand new technology to protect your motherboard from being damaged by over-voltaging of AGP card. When AGP Protection Technology is implemented, this motherboard will automatically detect the voltage of AGP card and prevent your chipsets from being burnt out. Please note that if you install an AGP card with 3.3V, which is not supported by Intel 845E, the AGP LED will light up to warn you the possible damage of the exceeding voltage. You may contact your AGP card vendor for further support.

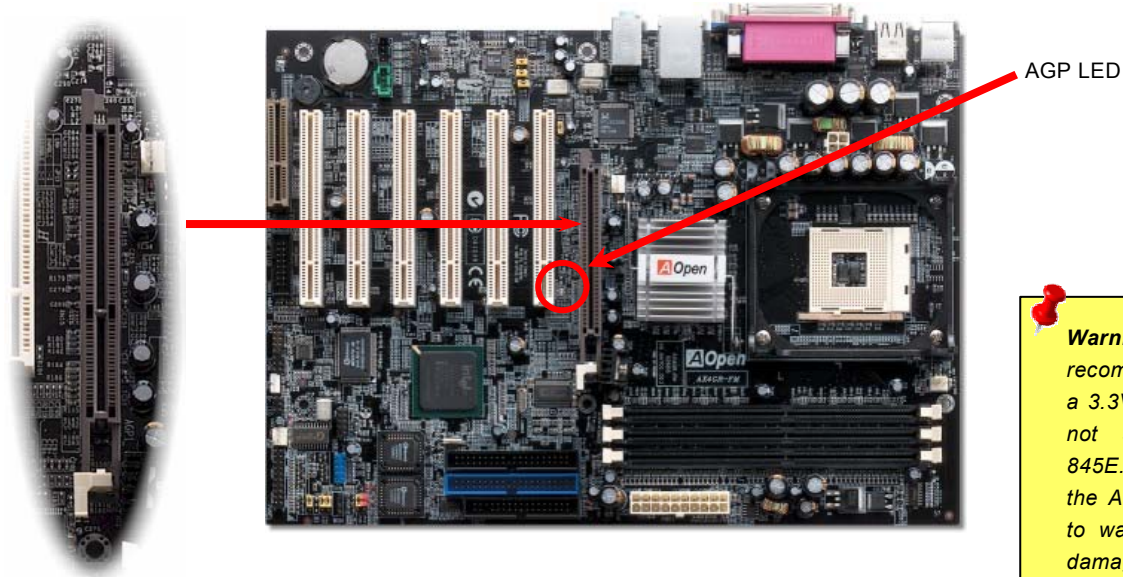

ADD Card (Intel 845GE chipset supported)



This motherboard supports ADD Card. ADD (AGP Digital Display) card is designed by Intel to multiplex the AGP signal interface with two DVO ports, and is designed to plug into the special-designed purple slot as you can see, which we call ADD slot here. The function of these two DVO ports is to support a variety of digital display devices, such as LCDs and Digital-input CRT, and is possible to use in dual-channel mode to support higher resolution and refresh rate, while deliver digital signal from source to display to preserve signal integrity and the viewable image quality.

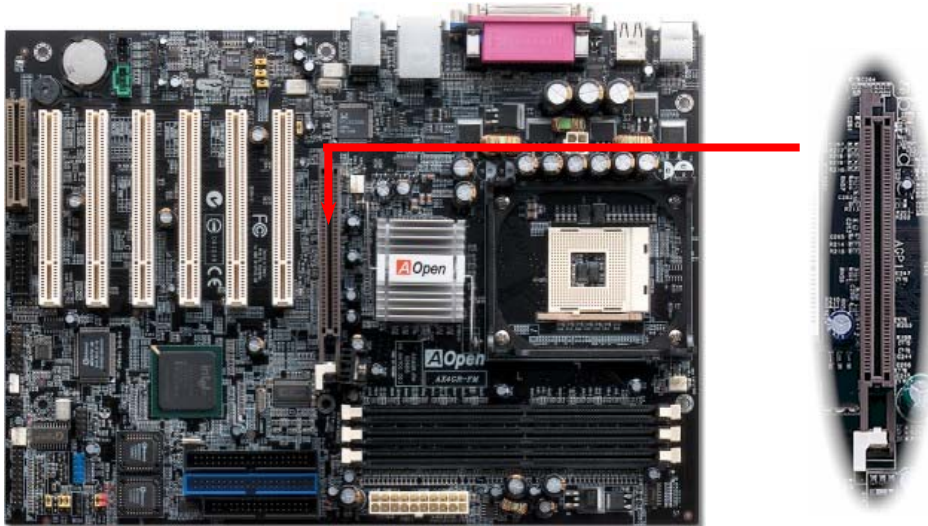

WOM (Zero Voltage Wake on Modem) Connector

This motherboard implements special circuit to support Wake On Modem, both Internal modem card and external box modem are supported. Since Internal modem card consumes no power when system power is off, it is recommended to use an internal modem. To use internal modem, connect 4-pin cable from RING connector of modem card to the WOM connector on the motherboard.

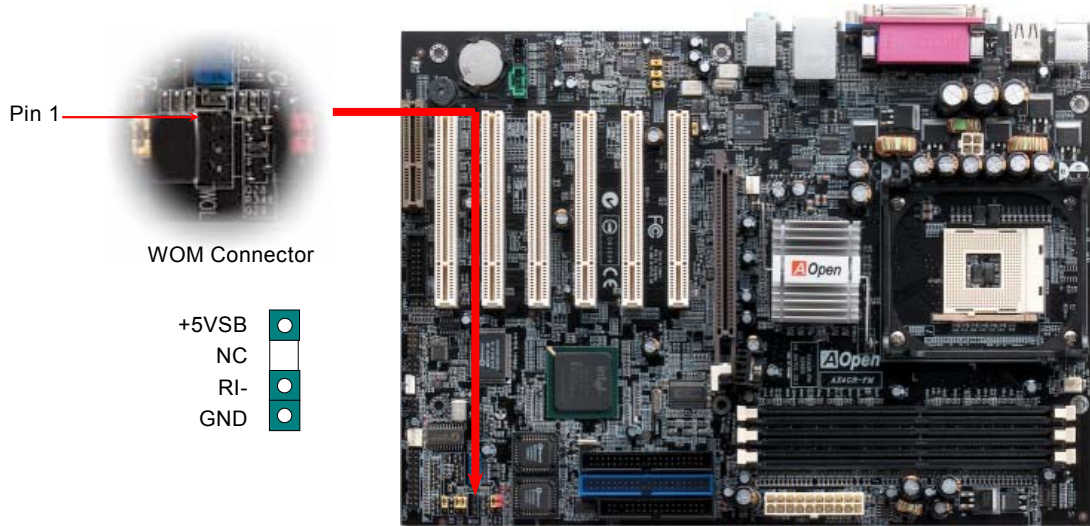

WOM by External BOX Modem

Traditional Green PC suspend mode does not really turn off the system power supply, it uses external box modem to trigger MB COM port and resume back to active.

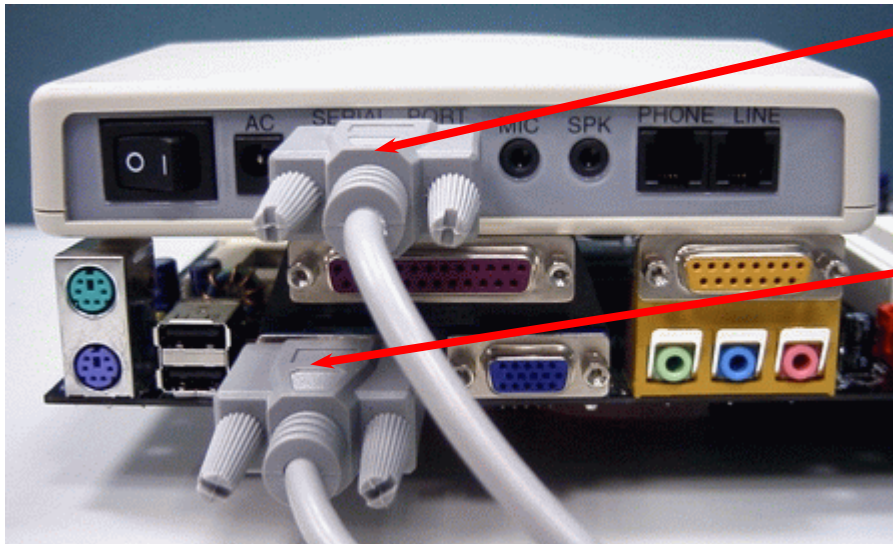

Serial Port
(Modem Side)

Serial Port
(Motherboard Side)

Note: This picture is for example only, it may not be exactly the same as this motherboard.

WOM by Internal Modem Card

With the help of the ATX soft power On/Off, it is possible to have a system totally power off, and wakeup to automatically answer a phone call as an answering machine or to send/receive a fax. You may identify whether or not your system is in true power off mode by checking to see if the fan of your power supply is off. Both an external box modem and an internal modem card can be used to support Modem Wake Up, but if you use an external modem, you have to leave your box modem on.

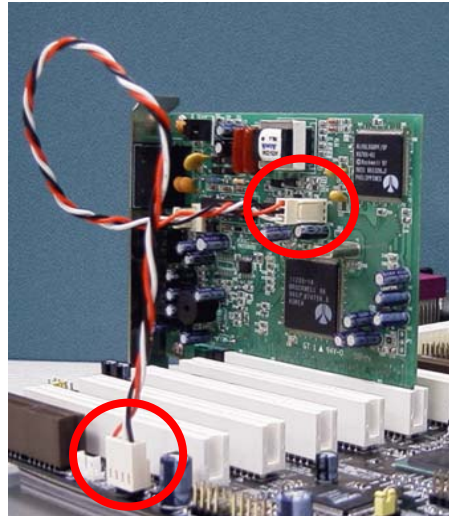

Note: This picture is for example only, it may not be exactly the same as this motherboard.

WOL (Wake on LAN)

This feature is very similar as [Wake On Modem](#), but it goes through local area network. To use Wake On LAN function, you must have a network card with chipset that supports this feature, and connect a cable from LAN card to motherboard WOL connector. The system identification information (probably IP address) is stored on network card and because there is a lot of traffic on the Ethernet, you need to install network management software, such as ADM, for the checking of how to wake up the system. Note that, at least 600mA ATX standby current is required to support the LAN card for this function.

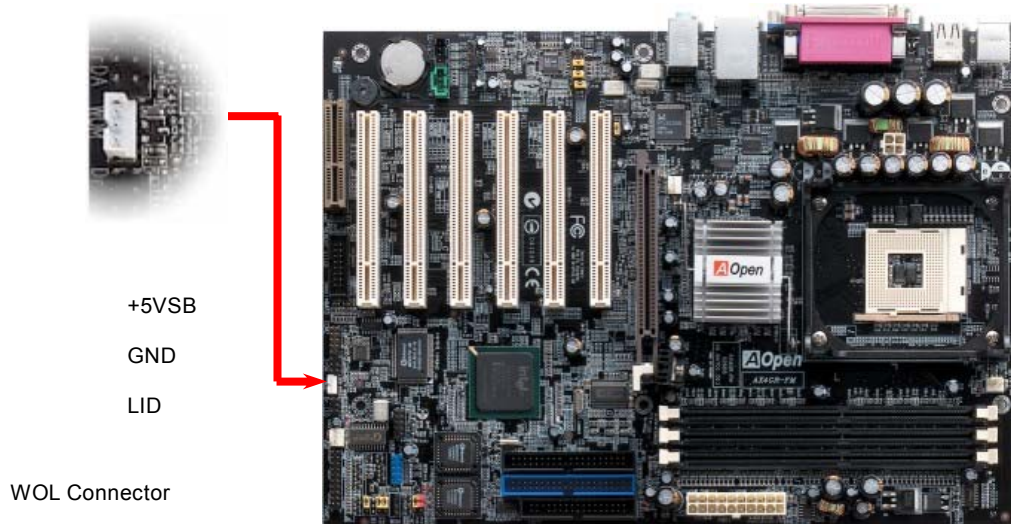

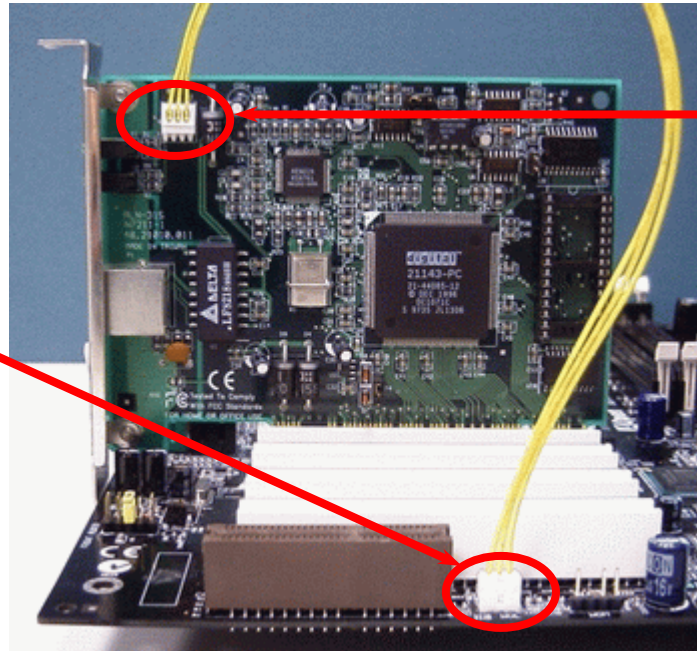

WOL Connector
(Ethernet Card Side)

WOL Connector
(Motherboard Side)

Note: This picture is for example only, it may not exactly be the same motherboard.

CNR (Communication and Network Riser) Expansion Slot

[CNR](#) is a riser card specification to replace the [AMR \(Audio/Modem Riser\)](#) that supports V.90 analog modem, multi-channel audio, and phone-line based networking. Owing to CPU computing power getting stronger, the digital processing job can be implemented in main chipset and share CPU power. The analog conversion ([CODEC](#)) circuit requires a different and separate circuit design, which is put on CNR card. This motherboard implements sound CODEC on board, but reserves CNR slot for the option of modem function. Note that you can still use PCI modem card. Please note that if you want to use CNR audio card on CNR slot, you must disable the sound output of CODEC from BIOS to prevent the CODEC from making out noises at the same time. Please be noted that the power cord must be removed before installing CNR LAN card.

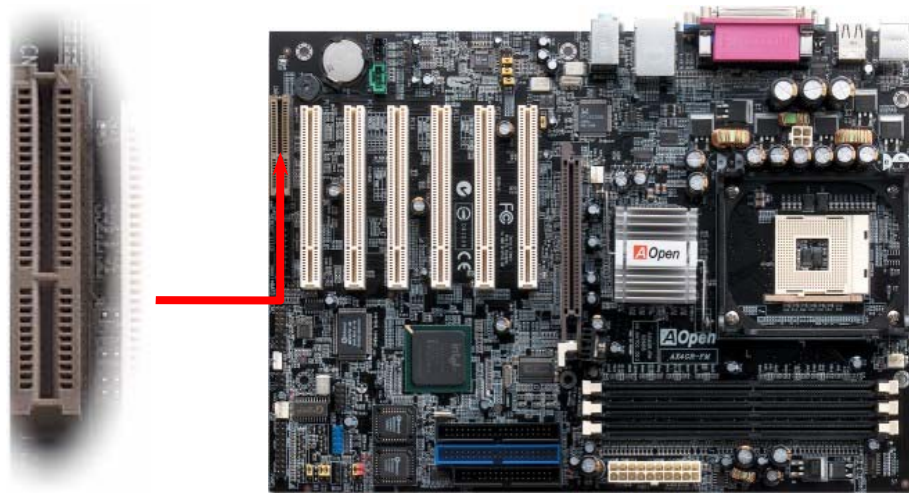

PC99 Color Coded Back Panel

The onboard I/O devices are PS/2 Keyboard, PS/2 Mouse, COM1 and VGA, RJ45 LAN, Printer, [USB](#), and AC97 sound. The view angle of drawing shown here is from the back panel of the housing.

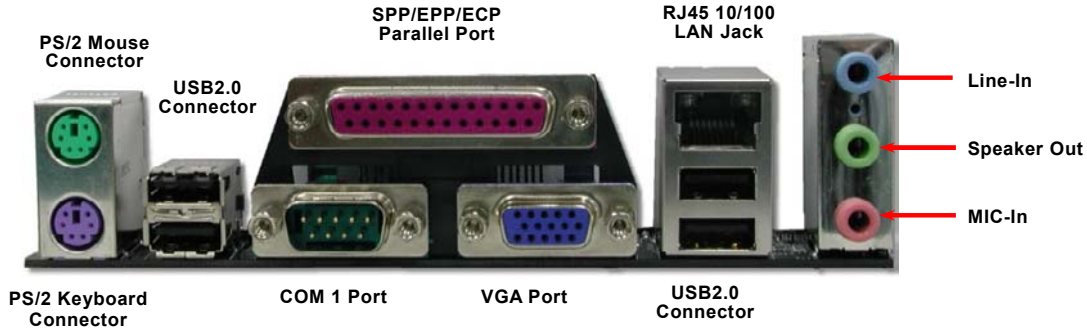

- PS/2 Keyboard: For standard keyboard, which is using a PS/2 plug.
- PS/2 Mouse: For PC-Mouse, which is using a PS/2 plug.
- USB Port: Available for connecting USB devices.
- Parallel Port: To connect with SPP/ECP/EPP printer.
- COM1/COM2 Port: To connect with pointing devices, modem or others serial devices.
- VGA Connector: To connect with PC monitor.
- Speaker Out: To External Speaker, Earphone or Amplifier.
- Line-In: Comes from the signal sources, such as CD/Tape player.
- MIC-In: From Microphone.

Support 10/100 Mbps LAN onboard

The South Bridge ICH4 includes a fast Ethernet controller on chip. On the strength of Realtek 8100BL LAN controller on board, which is a highly-integrated Platform LAN Connect device, it provides 10/100M bps Ethernet for office and home use, the Ethernet RJ45 connector is located on top of USB connectors. The green LED indicates the link mode, it lights when linking to network and blinking when transferring data. The orange LED indicates the transfer mode, and it lights when data is transferring in 100Mbps mode. To enable or disable this function, you may simply adjust it through BIOS.

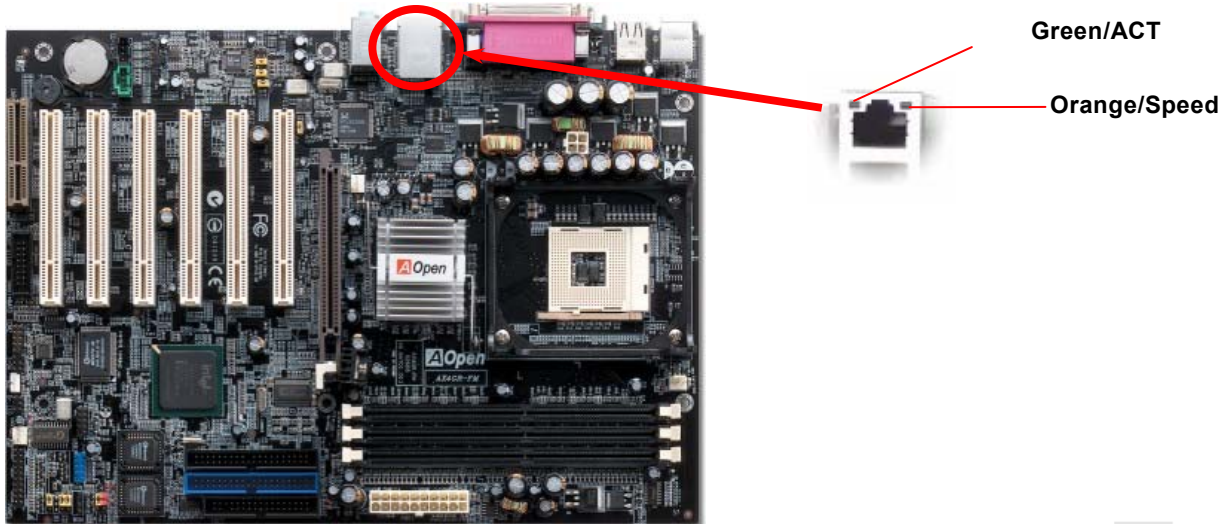

JP13 LAN Enable/Disable Jumper

JP13 is used to enable or disable onboard LAN. If you don't want to enable the Onboard LAN, you should set this jumper to 2-3.

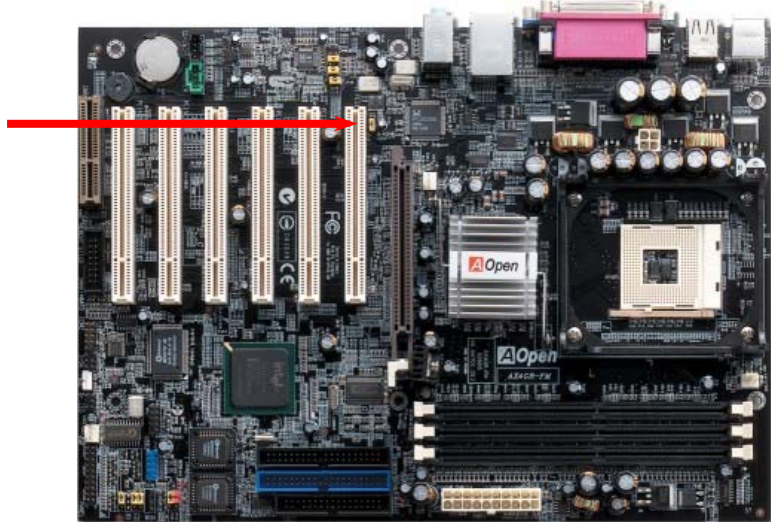
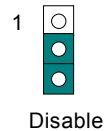
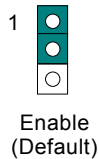



Support Six USB2.0 Connectors

Compared to traditional USB 1.0/1.1 with the speed of 12Mbps, USB 2.0 has a fancy speed up to 480Mbps, which is 40 times faster than the traditional one. Except for the speed increase, USB 2.0 supports old USB 1.0/1.1 software and peripherals, offering impressive and even better compatibility to customers. On this motherboard, all six USB connectors support USB 2.0 function. To connect those two headers, you have to use proper USB cables and connect them to any USB models.

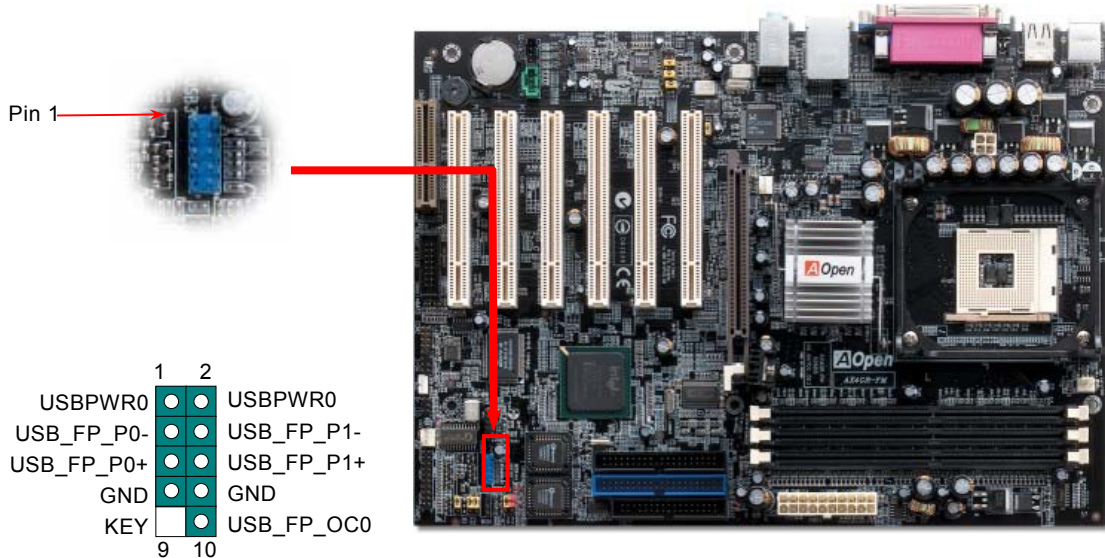

Chassis Intrusion Connector

The “CASE OPEN” header provides chassis intrusion-monitoring function. To make this function works, you have to enable it in the system BIOS, connect this header to a sensor somewhere on the chassis. So, whenever the sensor is triggered by lights or the opening of the chassis, the system will send out beep sound to inform you. Please be informed that this useful function only applies to advanced chassis, you may purchase an extra sensor, attach it on your chassis, and make a good use of this function.

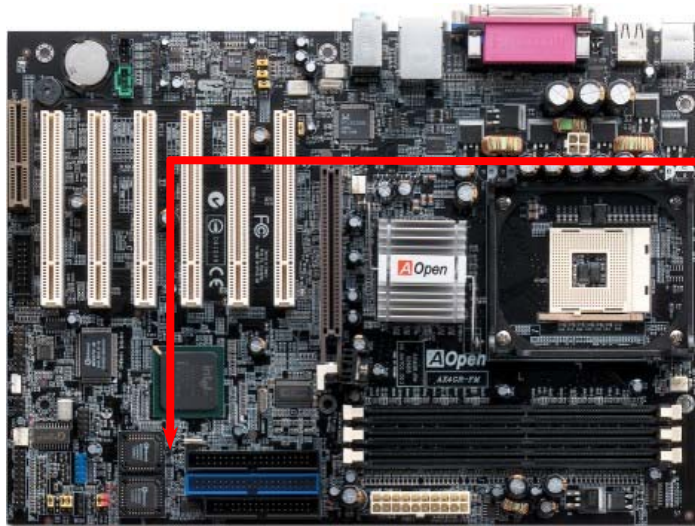

- 1  SENSOR
- 2  GND

Chassis Intrusion Connector

CD Audio Connector

This connector is used to connect CD Audio cable from CDROM or DVD drive to onboard sound.

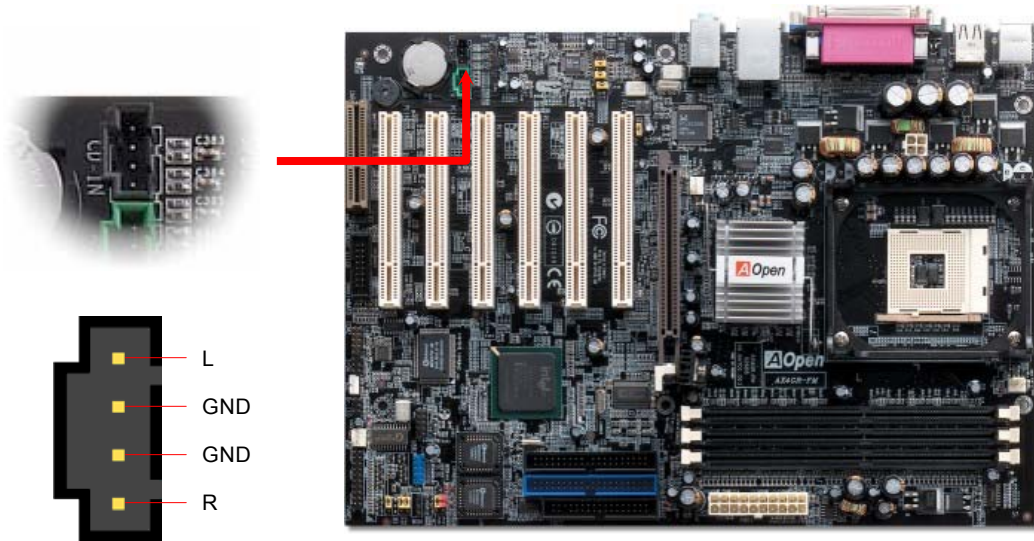

CD-IN Connector

AUX-IN Connector

This connector is used to connect MPEG Audio cable from MPEG card to onboard sound.

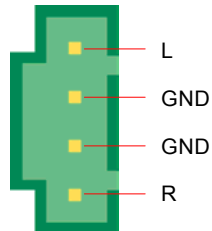

AUX-IN Connector

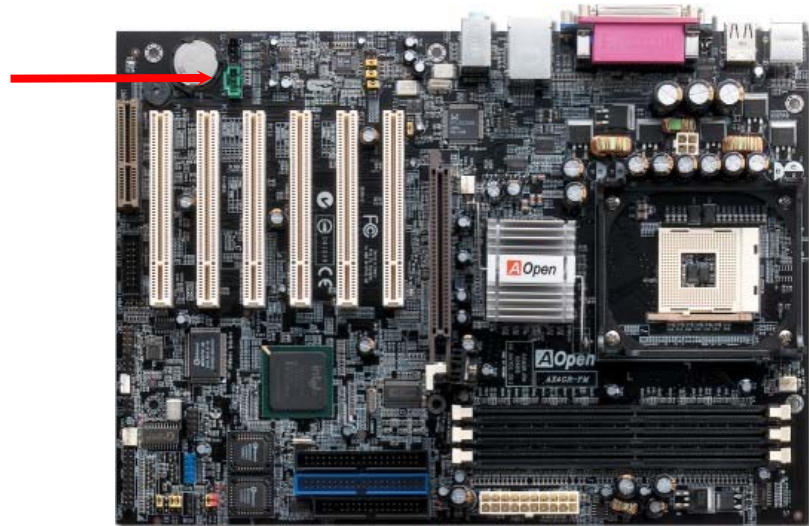

Front Audio Connector

If the housing has been designed with an audio port on the front panel, you'll be able to connect onboard audio to front panel through this connector. By the way, please remove 5-6 and 9-10 jumper caps from the Front Audio Connector before connecting the cable. Please do not remove these 5-6 and 9-10 yellow jumper caps if there's no audio port on the front panel.

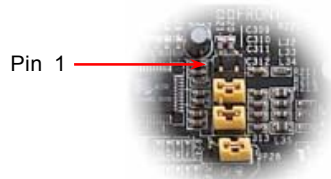

	1	2	
AUD_MIC	●	●	AUD_GND
AUD_MIC_BIAS	●	●	AUD_VCC
AUD_FPOUT_R	●	●	AUD_RET_R
NC	●	□	KEY
AUD_FROUT_L	●	●	AUD_RET_L
	9	10	

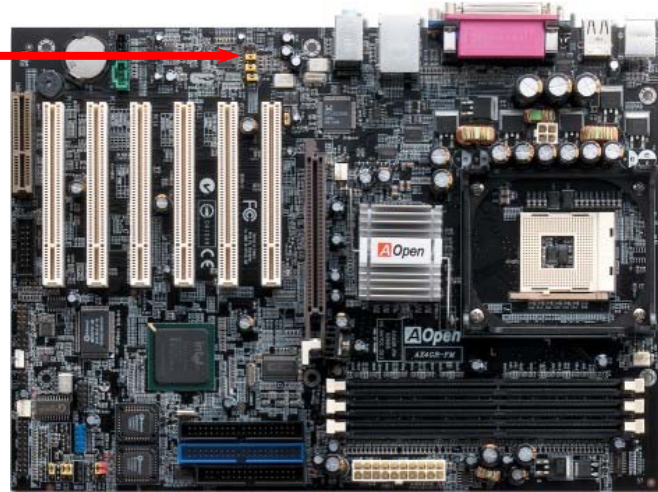

Note: Please remove the jumper cap from the Front Panel Audio Connector before you connect the cable. Do not remove this yellow jumper cap if housing without an audio port on the front panel.

Dr. LED Connector

In conjunction with Dr. LED (Upgrade Optional), which can easily shows what kind of problems may occur on your system during assembly. It can clearly indicate whether there is a component issue or an installed issue by the 8 LEDs on the front panel of Dr. LED. This can help you to have a self-diagnostic to your system status quickly.

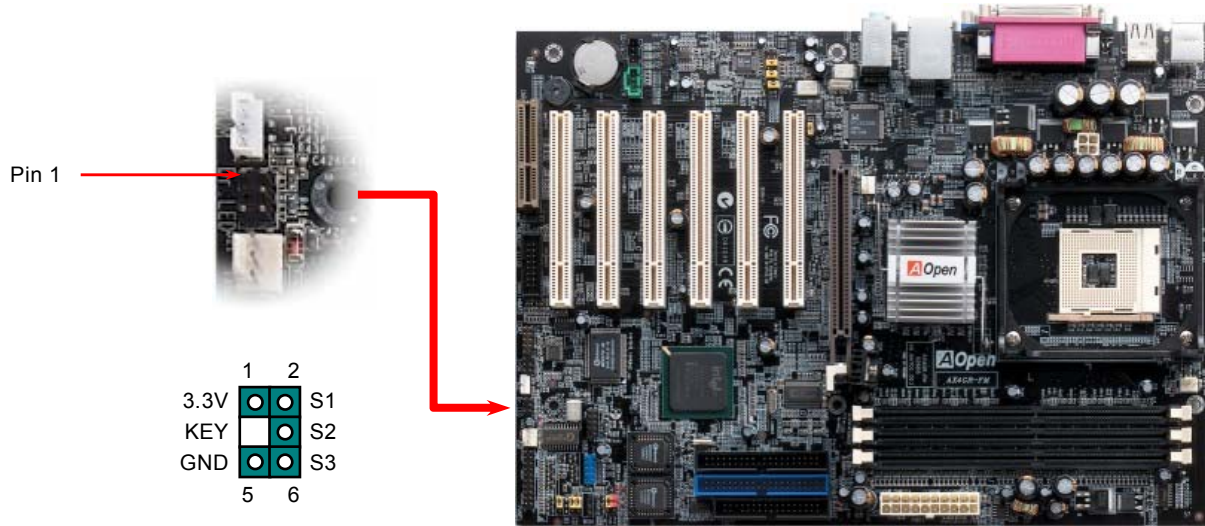

Dr. LED is a CD disc storage box with 8 LEDs on its front panel, the size of Dr. LED is exactly the same as 5.25 in floppy drive, so that it can be mount into normal 5.25 in drive bay of any housing.

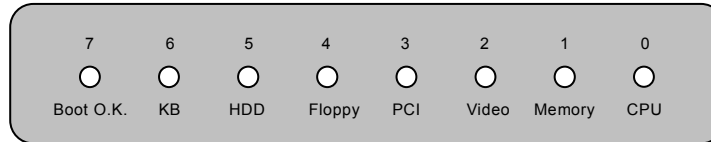

The total 8 LEDs light up alternatively if the system fails in one of eight stages. Once the LED7 (latest LED) is lit, this indicates that the system has completed its boot-up procedure.

The 8 LEDs indicate the following messages when lit:

LED 0 - Indicates that the CPU may have been installed incorrectly or is damaged.

LED 1 - Indicates that the memory may have been installed incorrectly or is damaged.

LED 2 - Indicates that the AGP may have been installed incorrectly or is damaged.

LED 3 - Indicates that the PCI card may have been installed incorrectly or is damaged.

LED 4 - Indicates that the floppy disk drive may have been installed incorrectly or is damaged.

LED 5 - Indicates that the HDD may have been installed incorrectly or is damaged.

LED 6 - Indicates that the keyboard may have been installed incorrectly or is damaged.

LED 7 - Indicates that the system is OK.

Note: During POST (Power On Self Test) procedure, the Debug LED will light on sequentially from LED0 to LED7 until the system boot O.K

JP15/JP16 Dr. Voice III Language Select Jumpers

Dr. VoiceIII is a great feature of AX4GE FM, which can identify the problems you may encounter in the operating system. It can clearly “**tell you**” whether the problem is caused from components or improper installation such as CPU, memory module, VGA, PCI add-on card, FDD, HDD or keyboard. Dr. VoiceIII provides four language versions: **Minnan, Shanghai, Guangdong** and **Beijing**. You can select your preferred language by **JP15 & JP16** jumpers.

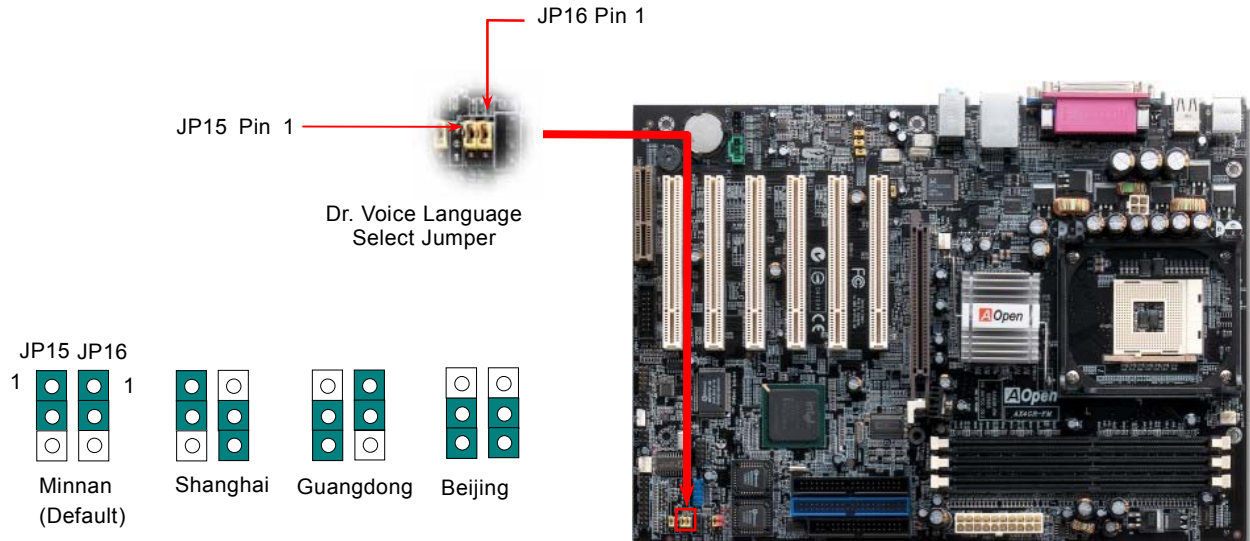

JP2 Speaker and Buzzer Select Jumper

This motherboard comes with another considerate option that allows you to turn off the voice from buzzer and speaker. You can choose not to be bothered by the warning made from Dr. Voice when it detects any error in operating system. You may also set JP2 to choose sending out voices from buzzer or speaker.

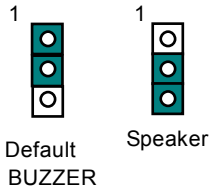

Pin1

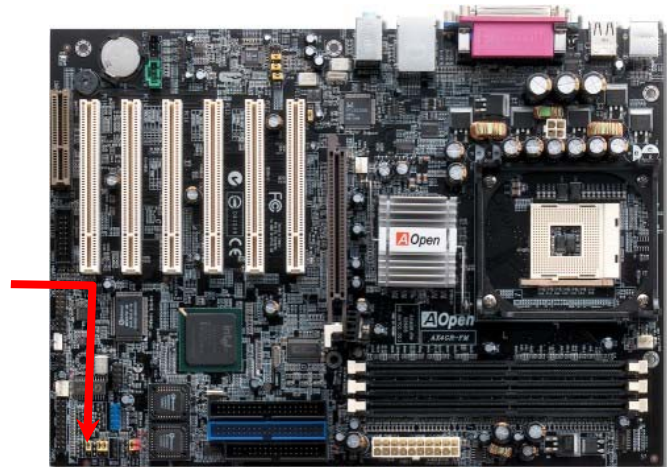

Battery-less and Long Life Design

This Motherboard implements [Flash ROM](#) and a special circuit that allows you to save your current CPU and CMOS Setup configurations without the need of a battery. The RTC (real time clock) can also keep running as long as the power cord is plugged. If you lose your CMOS data by accident, you can just reload the CMOS configurations from Flash ROM and the system will recover as usual.

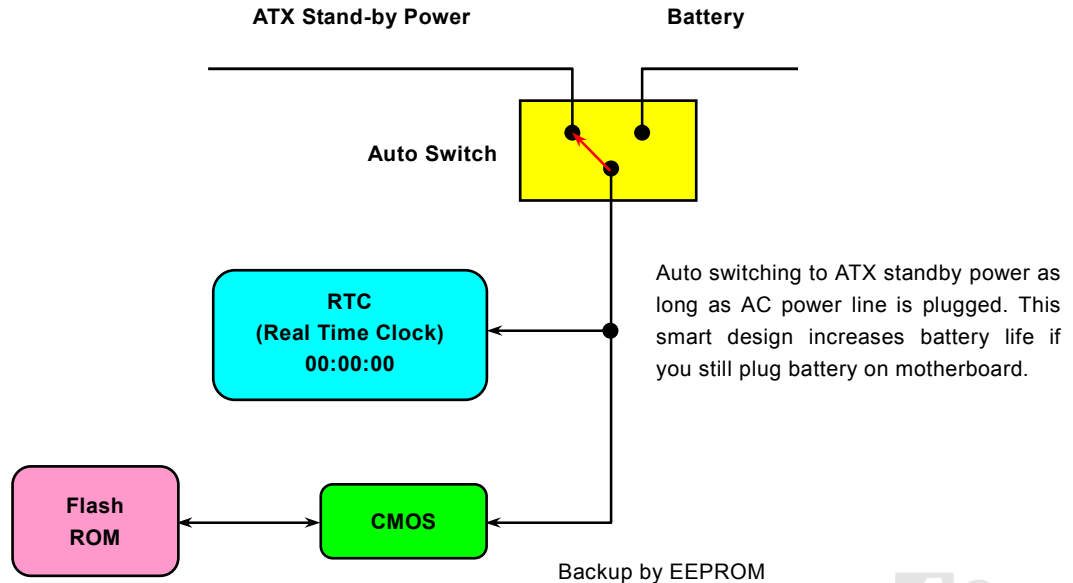

CPU Over-current Protection

Over Current Protection has been popularly implemented on ATX 3.3V/5V/12V switching power supply for a while. However, new generation CPU is able to use regulator of different voltages to transfer 12V to CPU voltage (for example, to 2.0V). This motherboard is with switching regulator onboard that supports CPU over-current protection, and it applies to 3.3V/5V/12V power supply for providing full line over-current protection.

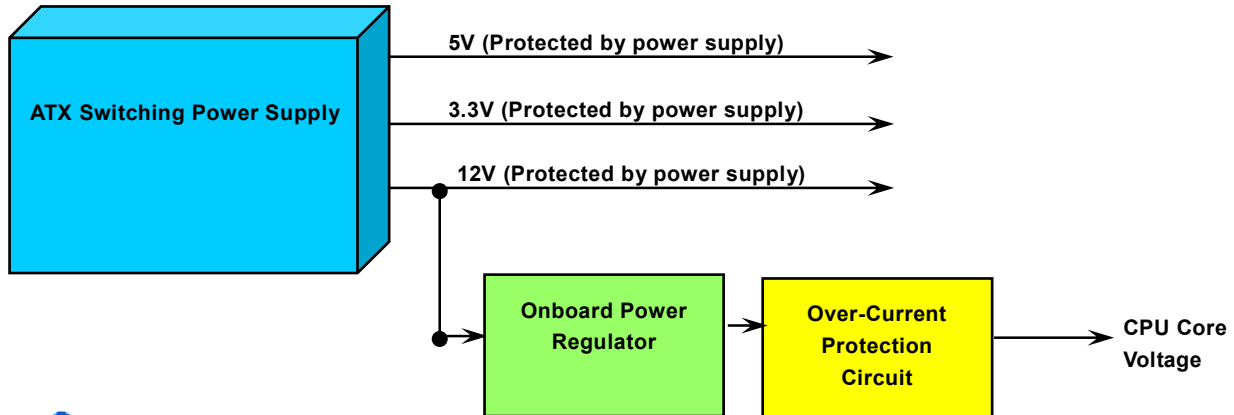

Note: Although we have implemented protection circuit try to prevent any human operating mistake, there is still certain risk that CPU, memory, HDD, add-on cards installed on this motherboard may be damaged because of component failure, human operating error or unknown nature reason. **AOpen cannot guaranty the protection circuit will always work perfectly.**

AOConfig Utility



AOOpen always dedicated to provide users a much friendlier computer environment. We now bring you a comprehensive system detective utility. AOConfig is a Windows based utility with user-friendly interface that allows users to obtain information of the operation system and hardware such as motherboard, CPU, memory, PCI devices and IDE devices. The powerful utility also displays the version of BIOS and firmware for your convenience of maintenance.

Moreover, AOConfig allows users to save information in *.BMP or *.TXT format which users may collect the system information in detail and send them to AOOpen directly for technical support or further diagnosis of system problem.

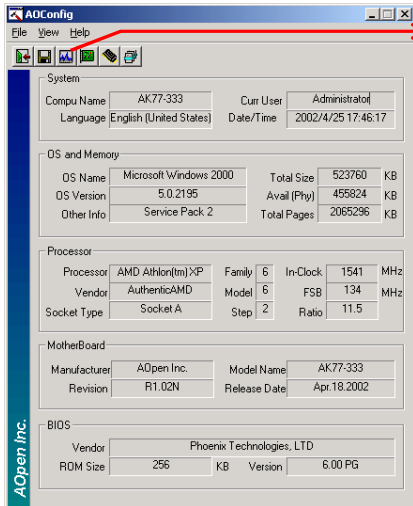

1. The system page shows the detail information of the motherboard, the operating system, the processor, and BIOS version.

2. The PCI device page shows the configurations of all PCI devices installed on your motherboard.

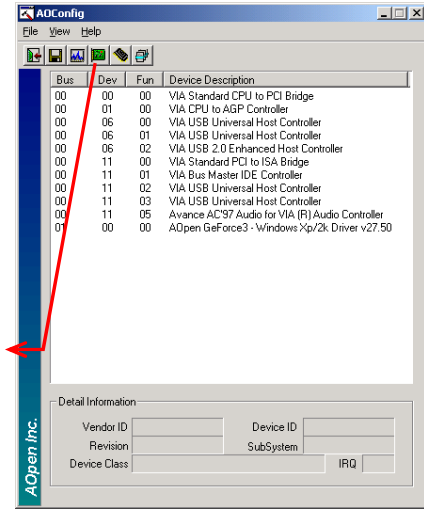

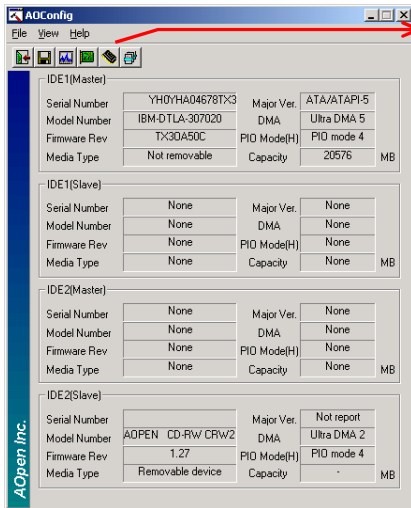

3. This page presents the IDE devices information, such as the serial number, the manufacturer, the firmware version, and capacity.

4. From this page, users may obtain the technical support information of AOpen. Moreover, detailed information could be saved in .bmp or .txt format.

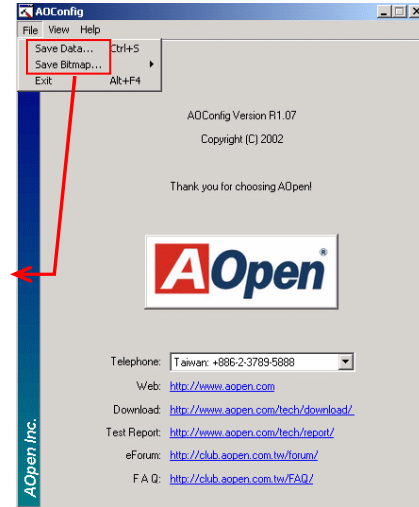

NOTE: AOconfig can be used in Windows 98SE/ME, NT4.0/2000, or even the latest Windows XP. Please be informed that AOconfig can only be operated in a system equipped with an AOpen motherboard. Meanwhile, all applications must be closed before starting AOconfig.

Die-Hard BIOS and JP24 Die-Hard BIOS Select Jumper

Many viruses have been found that may destroy bios code and data area lately. This motherboard implements a very effective hardware protection method without any software or BIOS coding involved, therefore it is 100% virus free. You may restore the originally mounted BIOS with 2nd BIOS ROM by setting JP24 to pin 2-3 if it fails to act normally. This motherboard comes with one BIOS ROM, you may contact our local distributors or resellers for purchasing an extra BIOS ROM. Please visit our website: www.aopen.com for details.

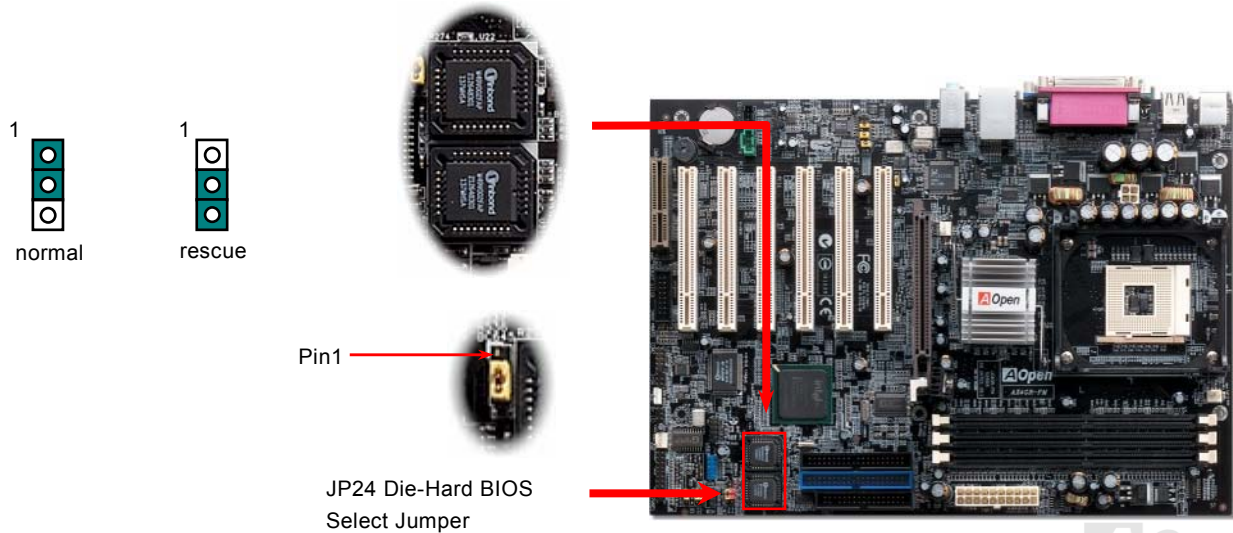

Resetable Fuse

Traditional motherboard has fuse for Keyboard and [USB](#) port to prevent over-current or shortage. These fuses are soldered onboard that when it is broken (function as protecting the motherboard), user still cannot replace it and the motherboard is still malfunctioning.

With expensive Resetable Fuse, the motherboard can be resumed back to normal function after the fuse had done its protection job.

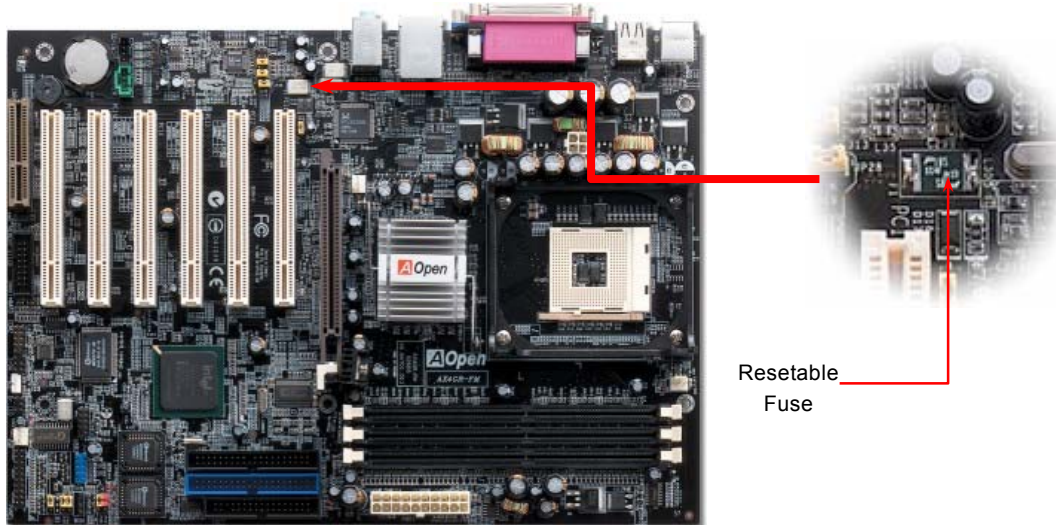

3300 μF Low ESR Capacitor

The quality of low ESR capacitor (Low Equivalent Series Resistance) during high frequency operation is very important for the stability of CPU power. The idea of where to put these capacitors is another know-how that requires experience and detail calculation.

Not only that, AX4GE FM implements 3300 μF capacitors, which is much larger than normal capacitor (1000 and 1500 μf) and it provides better stability for CPU power.

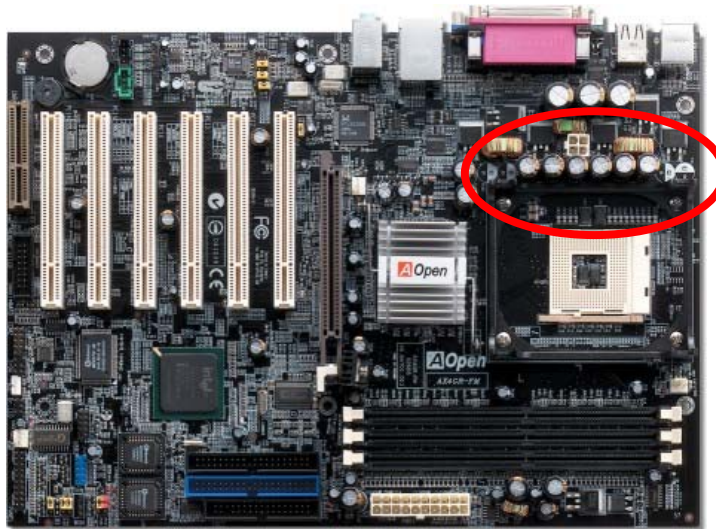

Layout (Frequency Isolation Wall)

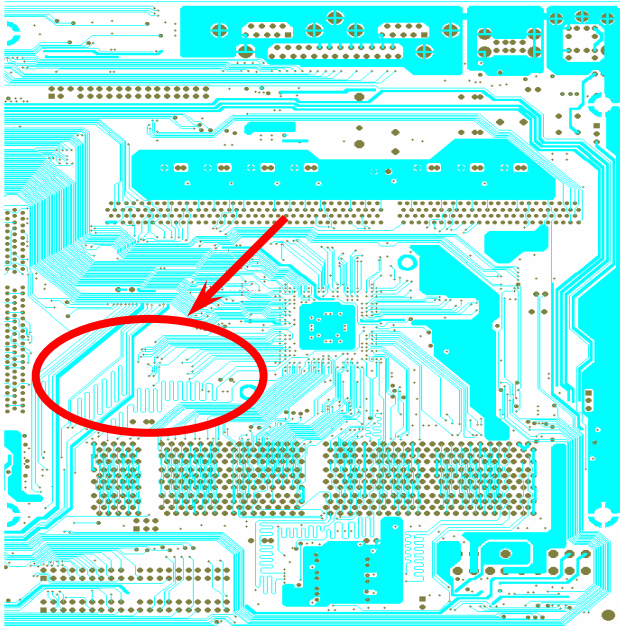

For high frequency operation, especially overclocking, layout is the most important factor to make sure chipset and CPU working in stable condition. The layout of this motherboard implements AOpen's unique design called " Frequency Isolation Wall". Separating each critical portion of motherboard into regions where each region operates in a same or similar frequency range to avoid cross talk and frequency interference between each region's operations and condition. The trace length and route must be calculated carefully. For example, the clock trace must be equal length (not necessarily as short as possible) so that clock skew will be controlled within few a pico second ($1/10^{12}$ Sec)

Note: This diagram for example only, it may not be exactly the same as this motherboard.

Enlarged Aluminum Heatsink

Cool down CPU and Chipset is important for system reliability. Enlarged aluminum heat sink provides better heat consumption especially when you are trying to over clocking the CPU.

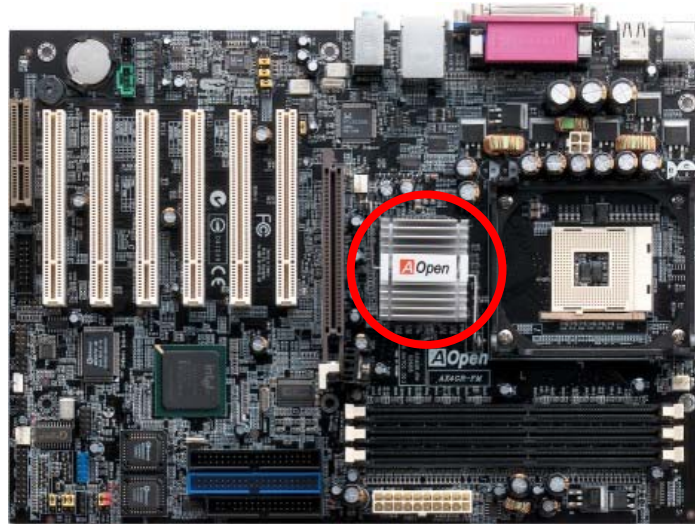

FM Radio Card



Do you enjoy listening baseball live broadcast while playing your PC at the same time? Though you can connect to few designated broadcasting channels through some small broadcasting utilities on your PC, there's always some abominable problems such as the on and off listening quality, audience number limitation and the long hours of connecting to the broadcasting server. To solve the above said torments for our users, AOpen had integrated the FM frequency radio function into a little piece of expansion card, to allow you listening to exciting game broadcasting, without missing any good moments, even, taping down any exciting pitch for replaying. Additionally, you could even using convert the .WAV file into .MP3 file, to preserve its original sounds into compressed file for long term keeping, setting 10 of your favorite frequency as fixed channel for click and play, which is very convenient. To be more considerate for our users, you may use JukeBox FM, integrated in our BIOS, to listening to radio without entering operating system after installing this FM Radio Expansion card. It's never been easier with FM Radio!

Installing FM Radio Card:

Please unplug your power cord before processing the following steps.

1. Unpacking your FM Radio Card out from the box.
2. To connect the signal cable to FM header onboard.

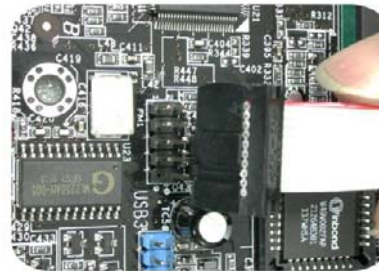

	1	2	
Audio Left	<input checked="" type="checkbox"/>	<input checked="" type="checkbox"/>	Audio Right
GND	<input checked="" type="checkbox"/>	<input checked="" type="checkbox"/>	GND
WREN	<input checked="" type="checkbox"/>	<input checked="" type="checkbox"/>	CLK
STEREO	<input checked="" type="checkbox"/>	<input checked="" type="checkbox"/>	DATA
KEY	<input type="checkbox"/>	<input checked="" type="checkbox"/>	+3.3V

FM Connector



3. To connect the FM Radio Card onto the chassis.

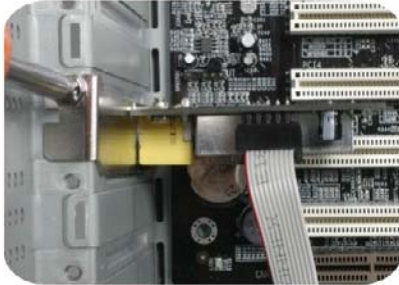

4. To connect antenna connector to expansion card port.



5. Stretch the antenna out and have it secured firmly.

Tip :

Please use the audio antenna that comes along with this expansion card to get the best receiving quality.

Setting the position of your PC at different places and angles would have had different receiving quality. Please adjust the angle of your antenna for best receiving by yourself, and try to stretch it out as wide as possible.

General speaking, it would be better to receive frequency with antenna located beside windows.

Installing FM Radio software:

After necessary hardware had been installed, you may power and reboot the system. Please run the AOpen Bonus Pack CD after entering Window system. An installation program will prompt up automatically on the screen, please select FM Radio for starting installation. Please refer to the FM Radio User Manual enclosed in the package for detailed illustration.

The noise is gone!! ---- Silent PC **NEW!**



As the clock of CPU keeps rocketing higher and higher, it inevitably brings higher heat and system temperature in a relative way. The way we deal with this heat problem, however, is to spare no effort to add one fan after another to protect our pampered system, expecting these fans could cool down our machine as much as it could.

But at the same time, we believe that same amount of users are affected terribly while working with their PC by the irritating noises of these fans. As a matter of fact, we do not have to get our fans running at such a high speed in most cases;

on the contrary, we discovered that having your fans running at appropriate time and speed could not only reduce the noise, but also consume the least power the system needed, so as to prevent over-wasting of energy resource.

Today, AOpen Motherboard is honored to bring you a new overall solution, SilentPC, to have your system quiet. To collocate with hardware circuit, BIOS and the utility under Windows, SilentPC combined "Hardware-Status Monitoring", "Overheat Warning" and "Fan Speed Control" with user-friendly interfaces to provide you a perfect balance between noises, system performance and stability.

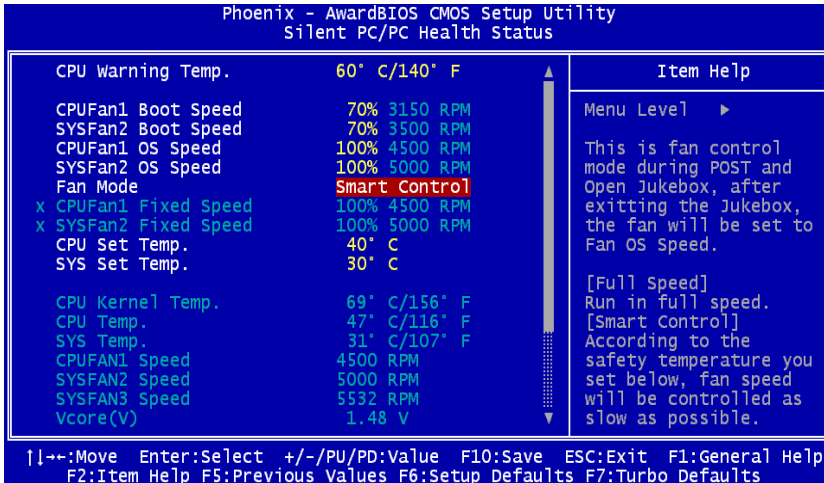

The first image you have here is the Voltage Status page. You can find current status of all voltages and set your expected margins of warning level.

In “Temp/Fan/Case” page, you may get aware of the current temperature of CPU and the heat inside chassis, plus checking if fans are running properly.

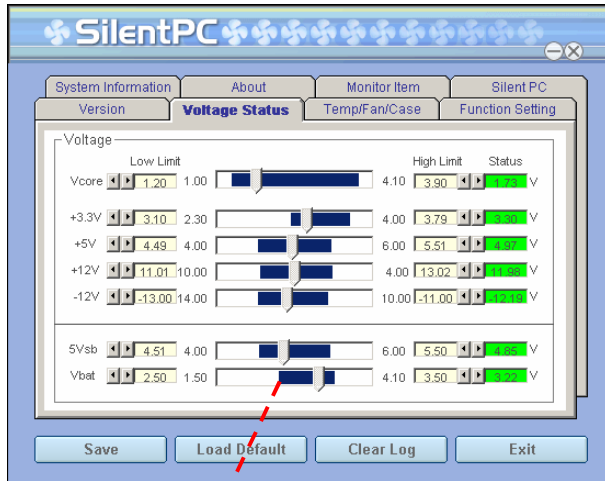

You may check your system voltage from the indicating bar here.

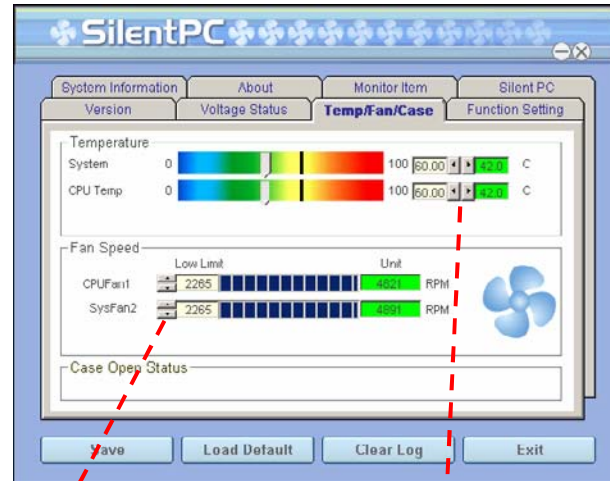

Of course, you may set your defaulted lowest margin for your fans and the SilentPC would also pop up a message box and alarm you when the fan is rotating slower than this specified speed.

You may set the highest margin of your CPU and system temperature as default, and SilentPC would pop up a message box and alert you with alarm when the temperature goes beyond the specified margin.

The following page is sure to be the most important part of this utility; you may control the rotation speed of specific fans you got with options inside in this page. Respectively illustrate as follow:

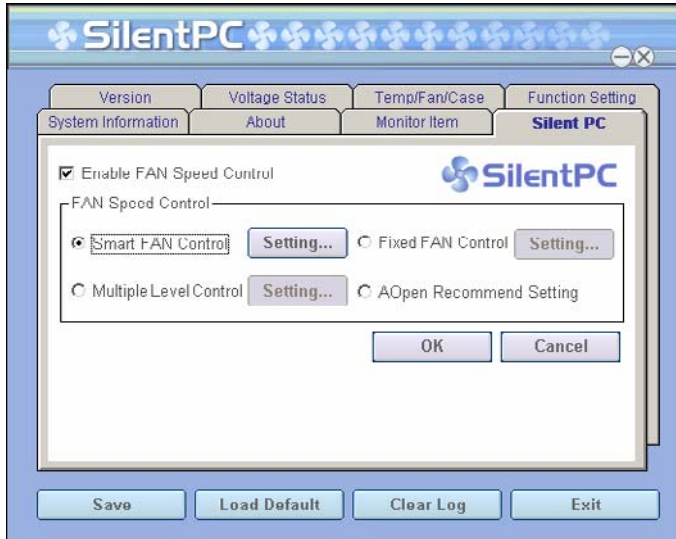

Note: Due to there are hundreds different brands of fan on the market, there might be some inaccuracy occurred when you have had adjusted your rotation speed; this is still under criterion and please assured that it won't cause any problem to your system.

1. **Smart FAN Control:** This is the default setting of SilentPC and can be used for any branded computer housing. With a special algorithm developed by AOpen, the fan speed is automatically adjusted by the factors of CPU and ambient temperature. Ease-of-use and trouble free at your service.
2. **Fixed FAN Control:** Under this setting, a desired fan speed is set fixed when operating.
3. **Multiple Level Control:** This is the most versatile setting that allows you to set fan speed in relation to temperature. You may find this setting fits best.
4. **AOpen Recommend Setting:** This setting is designed specifically for AOpen housing. A series of lab tests were conducted under the real world scenario to determine optimum fan speed to reduce noise level within CPU working condition and temperature. Most of the time, the fan would remain still when CPU is not fully utilized.

Vivid BIOS technology



Have you been fed up with the conservative and immutable POST screen? Let's rule out the tradition idea that POST screen are stiff and frigid, and let AOpen show you the newly developed VividBIOS to experience the lively vivid colorful POST screen!

Unlike earlier graphic POST screen which could occupy the whole screen and mask text information during POST, AOpen VividBIOS deals with graphics and texts separately, and makes them running simultaneously during POST. With this innovative design, VividBios now brings you a beautiful and sleek 256 colors screen without missing any important information shown on POST screen.

In addition, the limited space of BIOS ROM is another big issue. When all of the traditional BIOS can only show space-consuming and uncompressed Bitmap, AOpen has considerably tuned the BIOS to next generation, to recognize the smaller-sized GIF format and even dynamic-showing GIF animation.



Vivid BIOS shares the same fundamental technology with Open JukeBox CD Player, you may use the same EzSkin utility to

change your Vivid BIOS screen or to download your favorite Open JukeBox skin. If you see this little logo  shown beside your model name on the BIOS download page, <http://english.aopen.com.tw/tech/download/skin>, it is assured that your motherboard supports this innovative feature!



Open JukeBox FM Player



Here we are pleased to provide you a brand-new powerful interface—Open JukeBox FM. Without any cost you can have your PC turn into a fashionable CD player! This latest Open JukeBox FM motherboard aims at helping you directly operate your CD player on the PC without any hassle of entering Windows operation system. Moreover, users can take the advantage of FM Radio function to enjoy FM programs. Please refer to the bundled FM Radio Manual for detailed introduction about FM Radio.



How Your Open JukeBox FM Works

The operation of Open JukeBox FM Player is the same as other CD players. By pressing specific keys on the keyboard you will find playing Open JukeBox FM Player couldn't be easier than the traditional CD Players. Below is the function description of respective buttons.



- Power:** Pressing **Q**, to directly power off your computer with no hassle of entering Windows Operation System.
- Boot:** Pressing **B**, to intelligently boot to Windows Operation System for you.
- Play:** Pressing **A**, to start playing CD music.
- Stop:** Pressing **S**, to stop the music playing.
- Pause:** Pressing **P**, to pause the music playing temporarily.
- Eject:** Pressing **E**, to eject CD tray for you to change CD disc.
- Repeat:** Like other CD Players, pressing **R**, to shift the repeat mode.
- Volume +/-:** Pressing **+** or **-** to adjust the volume of playing music.
- Rewind/Forward** **← / →**: Pressing **arrow keys**, to rewind or forward the music.
- F1, F2, F3, F4:** Pressing keys to save your favorite channels.
- 1, 2, 3, 4:** Pressing the number keys to load your favorite channels.

Note: Though some of the latest version of Windows support "Digital Audio" through IDE bus. However, in order to use Open Jukebox FM player, which is driven under BIOS, it is a **MUST** to insert audio cable to CD-IN connector on the motherboard.

Your Open JukeBox FM Settings in BIOS

There are three Open JukeBox FM settings in BIOS as follows.

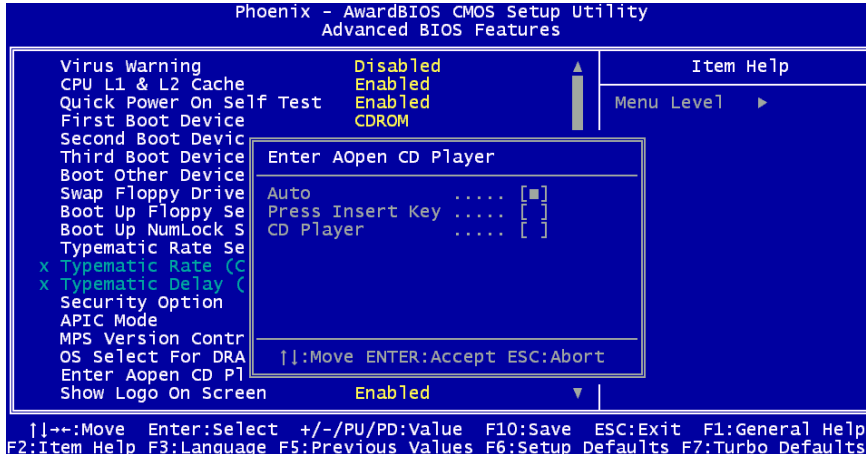

Auto: The default setting is “Auto” with which the Open JukeBox FM will automatically check the CD player every time you power on. The Open JukeBox FM will automatically be launched when it detects a music CD in your CD player.

Press Insert Key: Choosing this setting will allow a reminder message popped up on the screen during BIOS POST. It reminds you of pressing “Ins” key on your keyboard to start Open JukeBox FM Player; otherwise the system will launch the Windows Operation System.

CD Player: Choosing this setting allows the system to launch Open JukeBox FM Player every time you power on. However, by pressing **B** on your keyboard the Windows Operation System will be launched.

Your Open JukeBox FM EzSkin



Except these powerful functions above, Open JukeBox FM Player is also equipped with another fancy feature for you to change its “skin”. You can download as many skins as you want from AOpen Website, and changing them whenever you want by using this useful utility – **EzSkin** – which may also be downloaded from our website.

Even more, you may design your own skins with innovative idea and sharing them to users around the world by uploading to our website. For further technical information, we welcome you to visit our website at

<http://english.aopen.com.tw/tech/download/skin>.



Driver and Utility

There are motherboard drivers and utilities included in [AOpen Bonus CD disc](#). You don't need to install all of them in order to boot your system. But after you finish the hardware installation, you have to install your operation system first (such as Windows 98) before you can install any drivers or utilities. Please refer to your operation system's installation guide.



Note: Please follow recommended procedure to install Windows 2000 and [Windows 98](#).

Auto-run Menu from Bonus CD Disc

You can use the auto-run menu of Bonus CD disc. Choose the utility and driver and select model name.



Installing Intel® Chipset Software Installation Utility

You can install the Intel INF Update Utility from the Bonus Pack CD auto-run menu to eliminate the “?” marks.



Intel VGA driver

You can install Intel VGA Driver to get the best graphics function of the chipset. You can find it in the [AOpen Bonus Pack](#) CD disc.



Installing Intel IAA Driver

You can install Intel IAA Driver to increase the performance of software applications and reduce PC boot times. You can find it in the [AOpen Bonus Pack](#) CD disc.



Installing Onboard Sound Driver

This motherboard comes with [AC97 CODEC](#). You can find the audio driver from the Bonus Pack CD disc auto-run menu.

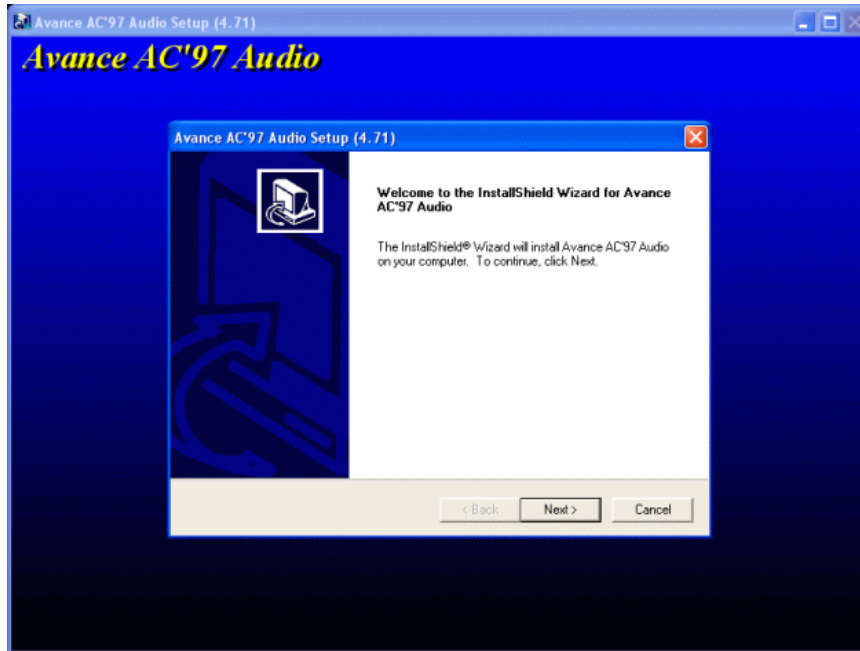

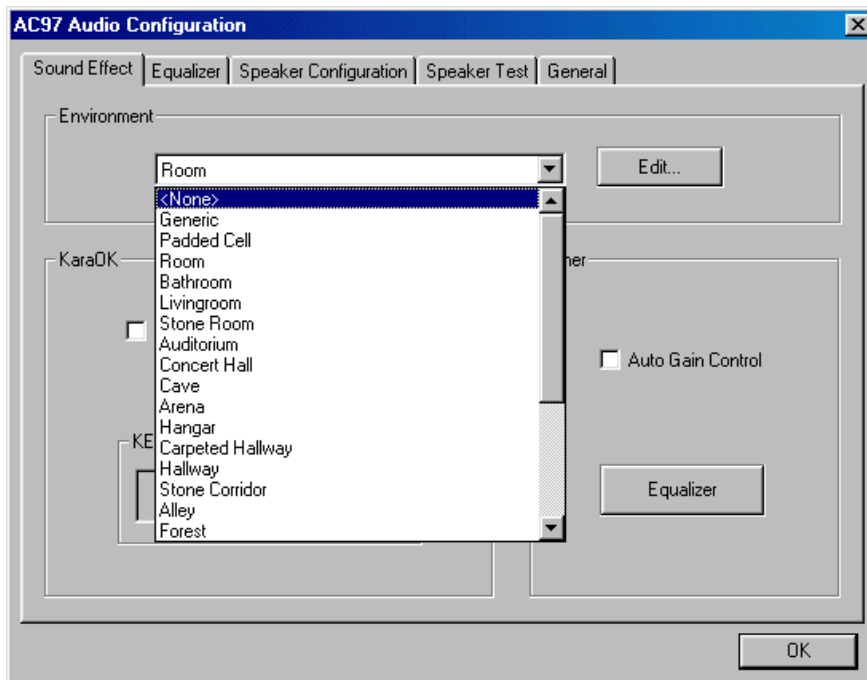

Installing LAN Driver

Introduction:

This document describes the procedure to install Windows 95 (Golden version), Win95A, OSR2, Windows 98/98 SE, Windows 2000, Windows ME, Windows NT v4.0 driver for Realtek RTL8139 PCI Fast Ethernet adapter.

[Windows 95 (Golden version), Win95A and OSR2]

Installing driver procedure on Microsoft Windows 95 :

1. Ask you to select which driver you want to install, select "Driver from disk provided by hardware manufacturer".
2. Specify the setup file pathname
[CD-ROM]:Driver\LAN\RTL8100\Windows\Win95\WIN95A (for Windows 95 and Win95A) or
[CD-ROM]:Driver\LAN\RTL8100\Windows\Win95 (for Windows 95 OSR2).
3. Windows 95 will appear some messages to insert Windows 95 systemdisk to complete setup step.
4. Windows 95 will finish the other installation procedure automatically, then you restart the system.

[Windows 98, Windows 98 SE, Windows2000, Windows ME, Windows XP]

Installing driver for Win98/Win98 SE/Windows2000/Windows ME/Windows XP :

1. Ask you to select which driver you want to install, select "Driver from disk provided by hardware manufacturer".
2. Specify the setup file pathname
[CD-ROM]:Driver\LAN\RTL8100\Windows\WIN98 (for Windows 98/98 SE) or
[CD-ROM]:Driver\LAN\RTL8100\Windows\WIN2000 (for Windows 2000) or
[CD-ROM]:Driver\LAN\RTL8100\Windows\WINME (for Windows ME) or
[CD-ROM]:Driver\LAN\RTL8100\Windows\WinXP (for Windows XP)
3. Win98/Win98 SE/Windows2000/Windows ME will appear some messages to insert Win98/Win98 SE/Windows2000/Windows ME system disk to complete setup step.
4. Win98/Win98 SE/Windows2000/Windows ME will finish the other installation procedure automatically, then you restart the system.

[Windows NT 3.5, 3.51 & 4.0]

Installing driver procedure on Microsoft Windows NT :

When you are in Windows NT :

1. In the Main group of NT, select the "Control Panel" icon.
2. In the Control Panel window, choose the "Network" icon.
3. In the Network Settings dialog box, choose the "Add Adapter" button.
The Add Network Adapter dialog box appears.
4. In the list of network cards, select "<other> Requires disk from manufacturer", and then press <Enter> button.
5. Enter drive and pathname
[CD-ROM]:\Driver\LAN\RTL8100\Windows\WinNT4 (for NT 4.0) which is the path where the setup file OEMSETUP.INF is located, and then choose the OK button.
6. The screen will appear "Select Line Speed" dialog box which is provided by RTL8139.SYS driver. The default value is "auto" so that the RTL8139 PCI Fast Ethernet adapter and its driver RTL8139.SYS will auto-detect the line speed, 10 Mb or 100Mb, while the RTL8139.SYS is loading. The other values, "10" or "100", are only used when you want to force the RTL8139 PCI Fast Ethernet adapter to 10Mb or 100Mb.
7. The screen will appear "Input EthernetID" dialog box which is provided by RTL8139.SYS driver. This option is only required when you have more than one Realtek RTL8139 PCI Fast Ethernet adapters on this computer. Select "SKIP" if only one adapter is installed on this computer.
8. "Bus Location" display in next screen. Your machine contains more than one hardware bus, please select the Bus Type and Bus number on which your network adapter card is installed.
9. NT will then perform the binding process. If any additional network software options were installed, you may be prompted for specific information for these packages.
10. Restarting your system you will acquire network service.

NOTES:

* Installing Multiple LAN Adapters:

Enter Windows NT and follow above setup procedure step 2, in the "Network Settings" dialog box, choose the "Configure.." button. The "Input Ethernet ID" dialog box appears and input adapter's Ethernet ID. Last step to select OK and close NETWORK SETUP. Select SKIP if only one adapter is installed on this computer.

Installing USB2.0 Driver

* Windows 2000 Installation Guide

```
*****  
Installing Driver in Existing Windows 2000 System  
*****
```

After enabling the USB 2.0 controller and rebooting your system, Windows 2000 setup will show a "New Hardware Found" dialog box. Under Windows 2000, "Universal Serial Bus (USB) Controller" will be displayed.

1. Choose "Search for a suitable driver for my device (Recommended)". from the list, and then press "Enter".
2. Choose "Specify a location." and then press "Next"
3. Insert the Bonus CD in CD-ROM.
4. Type "[CD-ROM]:\Driver\Intel\USB2.0" in the text box that appears. Press " OK ".
5. Click on "Next." A message informing you that Windows has found "Intel (R) USB Enhanced Host Controller (ICH4)" should appear.
6. Click on "Next," and then on "Finish."

```
*****  
Confirming Windows 2000 Installation  
*****
```

1. From Windows 2000, open the Control Panel from "My Computer" followed by the System icon.
2. Choose the "Hardware" tab, and then click the "Device Manager" tab.
3. Click the "+" in front of "Universal Serial Bus controllers". "Intel (R) USB Enhanced Host Controller (ICH4)" should appear.

* Windows XP Installation Guide

Installing Driver in Existing Windows XP System

After enabling the USB 2.0, Windows XP setup will show a "Found New Hardware" dialog box. Under Windows XP, "Universal Serial Bus (USB) Controller" will be displayed.

1. Click on "Next," and from the generated list box, choose "Install from a list or special location (Advanced)", click "Next"
2. Click on "Next," and from the generated choices, choose "Include this location in the search:"
3. Insert the Bonus CD in CD-ROM.
4. Type "[CD-ROM]:\Driver\Intel\USB2.0" in the text box that appears.
5. Click on "Next." A message informing you that Windows XP has found "Intel (R) USB Enhanced Host Controller (ICH4)" should appear.
6. When the New Hardware Wizard has finished installing the USB driver, click on "Finish"

Confirming Windows XP Installation

1. From Windows XP, open the Control Panel from "My Computer".
2. Click on "Performance and maintenance".
3. Click on the "System" icon.
4. Choose the "Hardware" tab, and then click the "Device Manager" tab.
5. Click the "+" in front of "Universal Serial Bus Controllers". "Intel (R) USB Enhanced Host Controller (ICH4)" should appear.

PHOENIX-AWARD BIOS

System parameters can be modified by going into [BIOS](#) Setup menu, this menu allows you to configure the system parameters and save the configuration into the 128 bytes CMOS area, (normally in the RTC chip or in the main chipset).

The Phoenix-AwardBIOS™ that installed in the [Flash ROM](#) of the motherboard is a custom version of an industry standard BIOS. The BIOS provides critical low-level support for standard devices such as hard disk drives, serial and parallel ports.

Most BIOS setting had been optimized by AOpen's R&D engineering team. But, the default setting of BIOS still can't fine-tune the chipset controlling entire system. Hence, the rest of this chapter is intended to guide you through the process of configuring your system using setup.

Currently there are two kinds of beep sound when system fails to boot at POST. The first type of beep sound consists of a single long beep and two short beeps, indicating a video error has failed BIOS from initializing video screen for displaying any additional information. The 2nd type of beep sound is a single long beep that beeping repeatedly, signaling a DRAM error has occurred. You may look over the indicated error according to different beep significances.

[To enter to BIOS setup menu](#), press when [POST \(Power-On Self Test\)](#) screen is shown on your monitor.

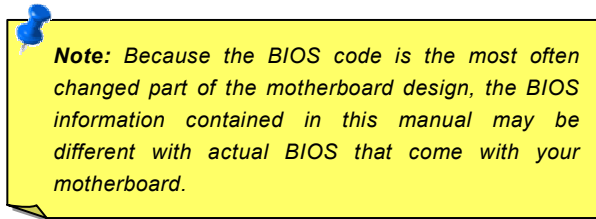

Note: *Because the BIOS code is the most often changed part of the motherboard design, the BIOS information contained in this manual may be different with actual BIOS that come with your motherboard.*

About BIOS Function Description...

AOpen always dedicates to give users a friendlier computer system. Now, we include all function descriptions of BIOS setup program into the BIOS Flash ROM. When you select one function of BIOS setup program, the function description will appeared at right side of screen. Hence, you don't need read this manual while you changing the BIOS setting.

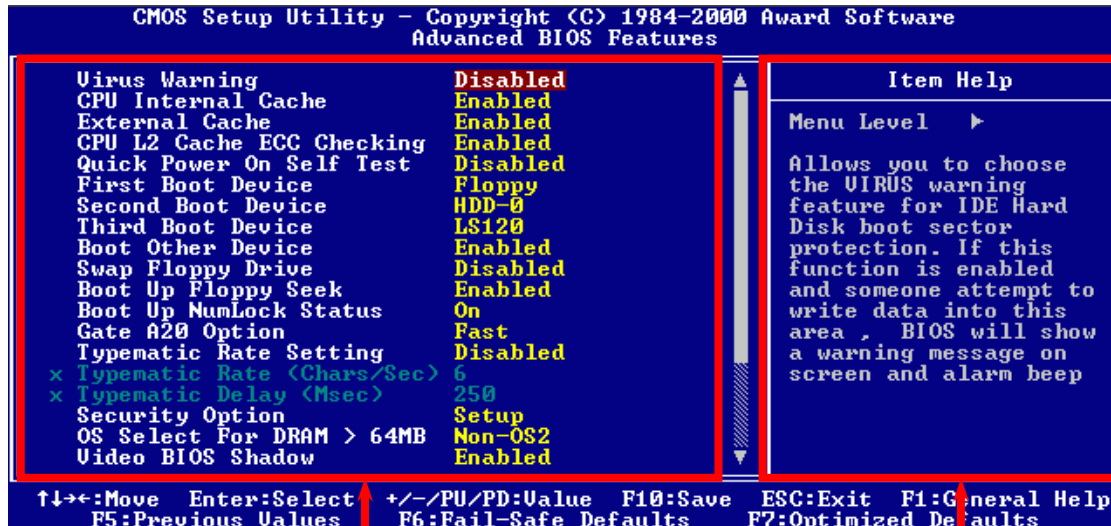

Menu Items Select Window

Item Function Description Window



How To Use Phoenix-Award™ BIOS Setup Program

Generally, you can use the arrow keys to highlight items that you want to choose, then press <Enter> key to select, and use the <Page Up> and <Page Down> key to change setting value. You also can press <F1> key for help and press <Esc> key to quit Phoenix-Award™ BIOS setup program. The following table provides details about how to use keyboard in the Phoenix-Award™ BIOS setup program. By the way, all products of AOpen also provides a special function in the BIOS setup, you can press <F3> key selecting preferred menu language to display

Key	Description
Page Up or +	Changing setting to next value or increase the value.
Page Down or -	Changing setting to previous value or decrease value.
Enter	Select the item.
Esc	1. In main menu: Quit and don't save any change. 2. In sub menu: Exit current menu to main menu.
Up Arrow	Highlight previous item.
Down Arrow	Highlight next item.
Left Arrow	Move the light bar to left side of menu.
Right Arrow	Move the light bar to right side of menu.
F1	Get menu or item help description.
F3	Changing menu language.
F5	Load previous setting value from CMOS.

Key	Description
F6	Load Setup Default setting value from CMOS.
F7	Load turbo setting value from CMOS.
F10	Save changed setting and exit setup program.

How To Enter BIOS Setup

After you finish the setting of jumpers and connect correct cables. Power on and enter the BIOS Setup, press during [POST \(Power-On Self Test\)](#). Choose "Load Setup Defaults" for recommended optimal performance.

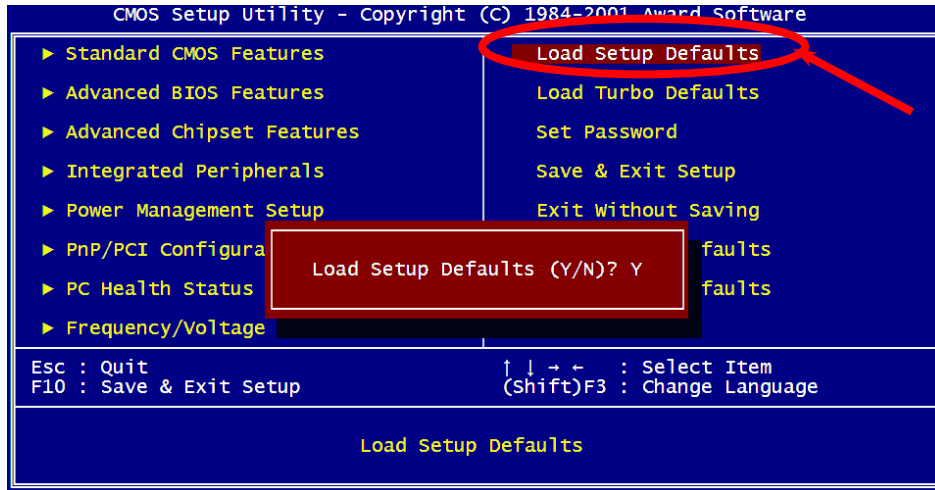

Warning: Please avoid of using "Load Turbo Defaults", unless you are sure your system components (CPU, DRAM, HDD, etc.) are good enough for turbo setting.



BIOS Upgrade under Windows environment



With outstanding R&D ability of AOpen, we now bring you a whole new BIOS Flash wizard ---- EZWinFlash. With an eye to users convenience, EZWinFlash combines the BIOS binary code and flash module together, so the only thing you have to do is just clicking on the utility you downloaded from web and let it helps you complete the flash process automatically. EZWinFlash detects your motherboard and checks the BIOS version cleverly to prevent your system from any possible failure. Moreover, EZWinFlash has been taken into consideration to go with any windows platform you might be using, no matter if you're using Windows 95/98, 98SE/ME, NT4.0/2000, or even the latest Windows XP.

In the meanwhile, in order to provide a much more user-friendly operating environment, AOpen EZWinFlash is natively designed to have multi-language function to provide easier way for users' usage in changing BIOS setting.

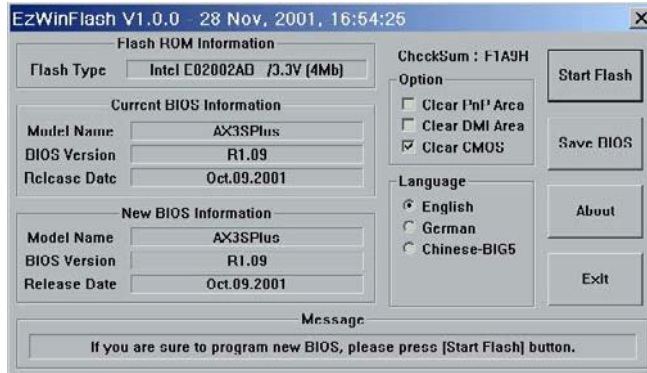

Caution: By updating your motherboard, you are taking a risk of BIOS flash failure. If your motherboard is working stable, and there are no major bugs that had been fixed by a latter BIOS revision, we recommend that you DO NOT try to upgrade your BIOS.

If you intent on upgrading, PLEASE BE SURE to get the right BIOS revision for the right motherboard model to avoid any possibility failure.

Note: The model name on this BIOS picture is for reference only. It may not be the exact model name.

You may accomplish BIOS upgrade procedure with EZWinFlash by the following steps, and it's STRONGLY RECOMMENDED to close all the applications before you start the upgrading.

1. Download the new version of BIOS package zip file from AOpen official web site. (ex: <http://english.aopen.com.tw>)
2. Unzip the download BIOS package (ex: WAX4GEFM102.ZIP) with WinZip (<http://www.winzip.com>) in Windows environment.
3. Save the unzipped files into a folder, for example, WAX4GEFM102.EXE & WAX4GEFM102.BIN.
4. Double click on the WAX4GEFM102.EXE, EZWinFlash will detect the model name and BIOS version of your motherboard. If you had got the wrong BIOS, you will not be allowed to proceed with the flash steps.
5. You may select preferred language in the main menu, then click [Start Flash] to start the BIOS upgrade procedure.
6. EZWinFlash will complete all the process automatically, and a dialogue box will pop up to ask you to restart Windows. You may click [YES] to reboot Windows.
7. Press at POST to enter BIOS setup, choose "Load Setup Defaults", then "Save & Exit Setup". Done!

It is strongly recommended NOT to turn off the power or run any application during FLASH PROCESS.

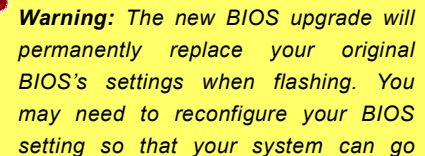

Warning: The new BIOS upgrade will permanently replace your original BIOS's settings when flashing. You may need to reconfigure your BIOS setting so that your system can go

Overclocking

As a leading manufacturer in motherboard industry, AOpen always listens to what customers want and develop products to fit different user's requirements. Reliability, compatibility, leading technology and friendly features are our basic goals when designing motherboards. Other than above mentioned design criteria, there are power users who are always seeking to push the limitation of the system performance by overclocking which we call them "Overclocker".

This section is dedicated to overclockers.

This high performance motherboard is designed for maximum **400MHz** CPU bus clock. But it comes with clock generator of **248MHz** when we design it to accommodate with future CPU bus clock. Our lab test results showed that **120MHz** is achievable when proper setting and qualified components were presented. Not only that, the CPU clock ratio can be up to 24x that supports almost all of Pentium® 4 CPUs in the future and provides flexibility for overclockers. For your reference, the configuration we feel appropriate for this motherboard is **120MHz** bus clock.

But not guaranty. 😊

***Tip:** Note that overclocking may also cause thermal problem. Please make sure that the cooling fan and the heatsink were adequate to dissipate excessive heat that's generated by overclocking the CPU.*

***Warning:** The design of this product follows CPU and chipset vendor's design guideline. Any attempts to push beyond product specification are not recommended and you are taking your own risk to damage your system or important data. Before doing overclocking, you must make sure your components are able to tolerate such abnormal setting, especially CPU, DRAMs, hard disks, and AGP VGA cards.*

VGA Card & Hard Disk

VGA and HDD is key components for overclocking, for your reference, the following list are what have been successful overclocked in our lab. Please note that AOpen can not guaranty they can be successful overclocked again. Please check the **Available Vendor List (AVL)** by link to our official website.

VGA: <http://english.aopen.com.tw/tech/report/overclk/mb/vga-oc.htm>

HDD: <http://english.aopen.com.tw/tech/report/overclk/mb/hdd-oc.htm>

Glossary

AC97

Basically, AC97 specification separates sound/modem circuit to two parts, digital processor and a [CODEC](#) for analogy I/O they are linked by AC97 link bus. Since digital processor can be put into motherboard main chipset, the cost of sound/modem onboard solution can be reduced.

ACPI (Advanced Configuration & Power Interface)

ACPI is the power management specification of PC97 (1997). It intends to save more power by taking full control of power management to operating system and bypass [BIOS](#). The chipset or super I/O chip needs to provide standard register interface to operating system (such as Windows 98). This is a bit similar as the [PnP](#) register interface. ACPI defines ATX momentary soft power switch to control the power state transition.

AGP (Accelerated Graphic Port)

AGP is a bus interface targeted for high-performance 3D graphic. AGP supports only memory read/write operation and single-master single-slave one-to-one only. AGP uses both rising and falling edge of the 66MHz clock, for 2X AGP, the data transfer rate is $66\text{MHz} \times 4\text{byte} \times 2 = 528\text{MB/s}$. AGP is now moving to 4X mode, $66\text{MHz} \times 4\text{byte} \times 4 = 1056\text{MB/s}$. AOpen is the first company to support 4X AGP motherboards by both AX6C (Intel 820) and MX64/AX64 (VIA 694x), started from Oct 1999.

AMR (Audio/Modem Riser)

The [CODEC](#) circuit of AC97 sound/modem solution can be put on motherboard or put on a riser card (AMR card) that connects to motherboard through AMR connector.

AOpen Bonus Pack CD

A disc bundled with AOpen motherboard product; there are motherboard drivers, Acrobat Reader for [PDF](#) online manual and other useful utilities.

APM (Advanced Power Management)

Unlike [ACPI](#), BIOS controls most APM power management functions. AOpen Suspend to Hard Drive is a good example of APM power management.

ATA (AT Attachment)

ATA is the specification of diskette interface. In 80's, many software and hardware manufacturers instituted the ATA specification together. The AT is meaning International Business Machines Corporation (IBM) personal computer/AT's bus structure.

ATA/66

ATA/66 uses both rising edge and falling edge but doubles [UDMA/33](#) transfer rate. The data transfer rate is 4 times of the PIO mode 4 or DMA mode 2, 16.6MB/s x4 = 66MB/s. To use ATA/66, you need special ATA/66 IDE cable.

ATA/100

ATA/100 is a new IDE specification under developing. ATA/100 uses both rising edge and falling edge as [ATA/66](#) but clock cycle time is reduced to 40ns. The data transfer rate is $(1/40\text{ns}) \times 2 \text{ bytes} \times 2 = 100\text{MB/s}$. To use ATA/100, you need special 80-wire IDE cable, the same as ATA/66.

ATA/133

Compared to traditional ATA/100, ATA/133 has been up to 33 percent increase in interface speed with transfer rate of 133MB/s. ATA/133 performance is ideal for new operating systems, such as Window XP, that demand more storage space and faster data transfer rates from more responsive computing experiences.

BIOS (Basic Input/Output System)

BIOS is a set of assembly routine/program that reside in [EPROM](#) or [Flash ROM](#). BIOS controls Input/output devices and other hardware devices of motherboard. In general, to provide hardware independent portability, operation system and drivers is required to access BIOS without directly access hardware devices.

Bus Master IDE (DMA mode)

The traditional PIO (Programmable I/O) IDE requires the CPU to involve in all the activities of the IDE access including waiting for the mechanical events. To reduce the workload of the CPU, the bus master IDE device transfers data from/to memory without interrupting CPU, and releases CPU to operate concurrently while data is transferring between memory and IDE device. You need the bus master IDE driver and the bus master IDE HDD to support bus master IDE mode.

CNR (Communication and Networking Riser)

The CNR specification provides the PC industry the opportunity to deliver a flexible and cost reduced method of implementing LAN, home networking, DSL, USB, wireless, audio and modem subsystems widely used in today's "connected PCs". The CNR specification is an open industry specification and is supported by OEMs, IHV card manufacturers, silicon supplier and Microsoft.

CODEC (Coding and Decoding)

Normally, CODEC means a circuit that can do digital to analog conversion and also the analog to digital conversion. It is part of [AC97](#) sound/modem solution.

DDR (Double Data Rated) SDRAM

DDR RAM utilizes the existing DRAM infrastructure and technology while doubling the nominal bandwidth available to systems in an easy to design and simple to adopt way. Initially a perfect solution for memory intensive server and workstation applications, DDR low cost and low voltage will ultimately make it an ideal solution for all segments of the PC market, high performance desktop and mobile PCs, Value PCs and even Internet Appliances and mobile devices.

DIMM (Dual In Line Memory Module)

DIMM socket has total 168-pin and supports 64-bit data. It can be single or double side, the golden finger signals on each side of PCB are different, and that is why it was called Dual In Line. Almost all DIMMs are made by [SDRAM](#), which operate at 3.3V. Note that some old DIMMs are made by FPM/[EDO](#) and only operate at 5V. Do not confuse them with SDRAM DIMM.

DMA (Direct Memory Access)

Channel for communications between the memory and surrounding devices.

ECC (Error Checking and Correction)

The ECC mode needs 8 ECC bits for 64-bit data. Each time memory is accessed; ECC bits are updated and checked by a special algorithm. The ECC algorithm has the ability to detect double-bit error and automatically correct single-bit error while parity mode can only detect single-bit error.

EDO (Extended Data Output) Memory

The EDO DRAM technology is actually very similar to FPM (Fast Page Mode). Unlike traditional FPM that tri-states the memory output data to start the pre-charge activity, EDO DRAM holds the memory data valid until the next memory access cycle, that is similar to pipeline effect and reduces one clock state.

EEPROM (Electronic Erasable Programmable ROM)

Also known as E²PROM. Both EEPROM and [Flash ROM](#) can be re-programmed by electronic signals, but the interface technology is different. Size of EEPROM is much smaller than flash ROM.

EPROM (Erasable Programmable ROM)

Traditional motherboard stores BIOS code in EPROM. EPROM can only be erased by ultra-violet (UV) light. If BIOS has to be upgraded, you need to remove EPROM from motherboard, clear by UV light, re-program, and then insert back.

EV6 Bus

EV6 Bus in the technology of Alpha processor from Digital Equipment Corporation. EV6 bus uses both rising and falling clock edge to transfer data, similar as DDR RAM or ATA/66 IDE bus.

EV6 Bus Speed = CPU external bus clock x 2.

For example, 200 MHz EV6 bus is actually using 100 MHz external bus clock, but the equivalent speed is 200 MHz.

FCC DoC (Declaration of Conformity)

The DoC is component certification standard of FCC EMI regulations. This standard allows DIY component (such as motherboard) to apply DoC label separately without a shielding of housing.

FC-PGA (Flip Chip-Pin Grid Array)

FC means Flip Chip, FC-PGA is a package of Intel for Pentium III CPU. It can only be plugged into SKT370 socket, but require motherboard to add some signals on socket 370. That is, the motherboard needs to be redesigned. Intel is going to ship FC-PGA 370 CPU and phase out slot1 CPU.

Flash ROM

Flash ROM can be re-programmed by electronic signals. It is easier for BIOS to upgrade by a flash utility, but it is also easier to be infected by virus. Because of increase of new functions, BIOS size is increased from 64KB to 256KB (2M bit). AOpen AX5T is the first board to implement 256KB (2Mbit) Flash ROM. Now flash ROM size is moving to 4M bit on AX6C (Intel 820) and MX3W (Intel 810) motherboard. , AOpen motherboard uses EEPROM for jumper-less and battery-less design.

FSB (Front Side Bus) Clock

FSB Clock means CPU external bus clock.

CPU internal clock = CPU FSB Clock x CPU Clock Ratio

I²C Bus

See [SMBus](#).

IEEE 1394

IEEE 1394 is a low-cost digital interface originated by Apple Computer as a desktop LAN and developed by the IEEE 1394 working group. The IEEE 1394 can transport data at 100, 200 or 400 Mbps. One of the solutions to connect digital television devices together at 200 Mbps. Serial Bus Management provides overall configuration control of the serial bus in the form of optimizing arbitration timing, guarantee of adequate electrical power for all devices on the bus, assignment of isochronous channel ID, and notification of errors. There are two type of IEEE 1394 data transfer: asynchronous and isochronous. Asynchronous transport is the traditional computer memory-mapped, load and store interface. Data requests are sent to a specific address and an acknowledgment is returned. In addition to an architecture that scales with silicon technology, IEEE 1394 features a unique isochronous data channel interface. Isochronous data channels provide guaranteed data transport at a pre-determined rate. This is especially important for time-critical multimedia data where just-in-time delivery eliminates the need for costly buffering.

Parity Bit

The parity mode uses 1 parity bit for each byte, normally it is even parity mode, that is, each time the memory data is updated, parity bit will be adjusted to have even count "1" for each byte. When next time, if memory is read with odd number of "1", the parity error is occurred and this is called single bit error detection.

PBSRAM (Pipelined Burst SRAM)

For Socket 7 CPU, one burst data read requires four QWord (Quad-word, $4 \times 16 = 64$ bits). PBSRAM only needs one address decoding time and automatically sends the remaining QWords to CPU according to a predefined sequence. Normally, it is 3-1-1-1, total 6 clocks, which is faster than asynchronous SRAM. PBSRAM is often used on L2 (level 2) cache of Socket 7 CPU. Slot 1 and Socket 370 CPU do not need PBSRAM.

PC-100 DIMM

[SDRAM](#) DIMM that supports 100MHz CPU [FSB](#) bus clock.

PC-133 DIMM

[SDRAM](#) DIMM that supports 133MHz CPU [FSB](#) bus clock.

PC-1600, PC-2100 or PC-2700 DDR DRAM

Based on FSB frequency, the DDR DRAM has 200MHz, 266MHz and 333MHz three types of working frequency. Because DDR DRAM data bus is 64-bit, it provides data transfer bandwidth up to $200 \times 64 / 8 = 1600 \text{MB/s}$, $266 \times 64 / 8 = 2100 \text{MB/s}$ and $333 \times 64 / 8 = 2700 \text{MB/s}$ in these current three DDR DRAM. Therefore, the PC-1600 DDR DRAM is working with 100MHz, PC-2100 DDR DRAM is working with 133MHz and PC-2700 with 166MHz FSB frequency.

PCI (Peripheral Component Interface) Bus

Bus for the internal connection of peripheral devices, high-speed data channel between the computer and expansion card.

PDF Format

A file format for electronic document, PDF format is independent from platform, you can read PDF file under Windows, Unix, Linux, Mac ... with different PDF reader. You can also read PDF file by web browser such as IE and Netscape, note that you need to install PDF plug-in first (Included in Acrobat Reader).

PnP (Plug and Play)

The PnP specification suggests a standard register interface for both BIOS and operating system (such as Windows 95). These registers are used by BIOS and operating system to configure system resource and prevent any conflicts. PnP BIOS or operating system will automatically allocate the IRQ/DMA/Memory. Currently, almost all the PCI cards and most ISA cards are already PnP compliant.

POST (Power-On Self Test)

The BIOS self-test procedure after power-on, sometimes, it is the first or the second screen shown on your monitor during system boot.

RDRAM (Rambus DRAM)

Rambus is a memory technology that uses large burst mode data transfer. Theoretically, the data transfer should be high than [SDRAM](#). RDRAM is cascaded in channel operation. For Intel 820, only one RDRAM channel is supported, 16-bit data per channel, and this channel may have maximum 32 RDRAM devices, no matter how many [RIMM](#) sockets.

RIMM (Rambus Inline Memory Module)

184-pin memory module that supports [RDRAM](#) memory technology. A RIMM memory module may contain up to maximum of 16 RDRAM devices.

SDRAM (Synchronous DRAM)

SDRAM is one of the DRAM technologies that allow DRAM to use the same clock as the CPU host bus ([EDO](#) and FPM are asynchronous and do not have clock signal). It is similar as [PBSRAM](#) to use burst mode transfer. SDRAM comes in 64-bit 168-pin [DIMM](#) and operates at 3.3V. AOpen is the first company to support dual-SDRAM DIMMs onboard (AP5V), from Q1 1996

Shadow E²PROM

A memory space in Flash-ROM to simulate E²PROM operation, AOpen motherboard uses Shadow E²PROM for jumper-less and battery-less design

SIMM (Single In Line Memory Module)

SIMM socket is only 72-pin, and is only single side. The golden finger signals on each side of PCB are identical. That is why it was called Single In Line. SIMM is made by FPM or [EDO](#) DRAM and supports 32-bit data. SIMM had been phased out on current motherboard design.

SMBus (System Management Bus)

SMBus is also called I2C bus. It is a two-wire bus developed for component communication (especially for semiconductor IC). For example, set clock of clock generator for jumper-less motherboard. The data transfer rate of SMBus is only 100Kbit/s, it allows one host to communicate with CPU and many masters and slaves to send/receive message.

SPD (Serial Presence Detect)

SPD is a small ROM or [EEPROM](#) device resided on the [DIMM](#) or [RIMM](#). SPD stores memory module information such as DRAM timing and chip parameters. SPD can be used by [BIOS](#) to decide best timing for this DIMM or RIMM.

Ultra DMA

Ultra DMA (or, more accurately, Ultra DMA/33) is a protocol for transferring data between a hard disk drive through the computer's data path (or bus) to the computer's random access memory (RAM). The Ultra DMA/33 protocol transfers data in burst mode at a rate of 33.3MB/s, twice as fast as the previous [Direct Access Memory \(DMA\)](#) interface. Ultra DMA was developed as a proposed industry standard by the Quantum corporation, makes of hard disk drives, and Intel, makes of chipset that support computer bus technology. Ultra DMA support in your computer means that it will boot (start) and open new applications more quickly. It will help users of graphic-intensive and applications that require large amounts of access to data on the hard disk drive. Ultra DMA uses Cyclical Redundancy Checking (CRC), offering a new level of data protection. Ultra DMA uses the same 40-pin IDE interface cable as PIO and DMA.

16.6MB/s x2 = 33MB/s

16.6MB/s x4 = 66MB/s

16.6MB/s x6 = 100MB/s

USB (Universal Serial Bus)

USB is a 4-pin serial peripheral bus that is capable of cascading low/medium speed peripherals (less than 10Mbit/s, but the newly design USB2.0 has a fancy speed up to 480Mbps) such as keyboard, mouse, joystick, scanner, printer and modem. With USB, the traditional complex cables from back panel of your PC can be eliminated.

USB2.0 (Universal Serial Bus)

Compared to traditional USB 1.0/1.1 with the speed of 12Mbps, USB 2.0 has a fancy speed up to 480 Mbps that is 40 times faster than the traditional one. Except for the speed increase, USB 2.0 supports old USB 1.0/1.1 software and peripherals, offering impressive and even better compatibility to customers.

VCM (Virtual Channel Memory)

NEC's Virtual Channel Memory (VCM) is a new DRAM core architecture that dramatically improves the memory system's ability to service multimedia requirements. VCM increases memory bus efficiency and performance of any DRAM technology by providing a set of fast static registers between the memory core and I/O pins. Using VCM technology results in reduced data access latency and reduced power consumption.

ZIP file

A compressed file format to reduce file size. To unzip file, run shareware PKUNZIP (<http://www.pkware.com/>) for DOS and other operating system or WINZIP (<http://www.winzip.com/>) for windows environment.



Troubleshooting

If you encounter any trouble to boot your system, follow the procedures accordingly to resolve the problem.

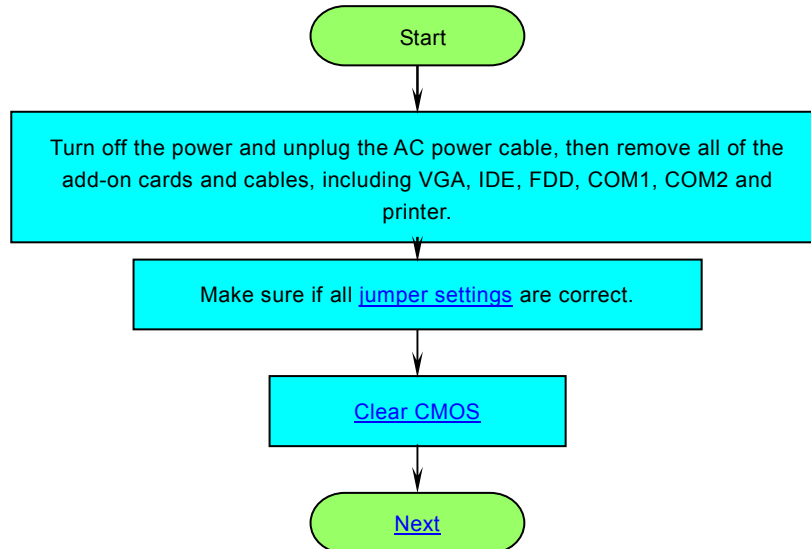

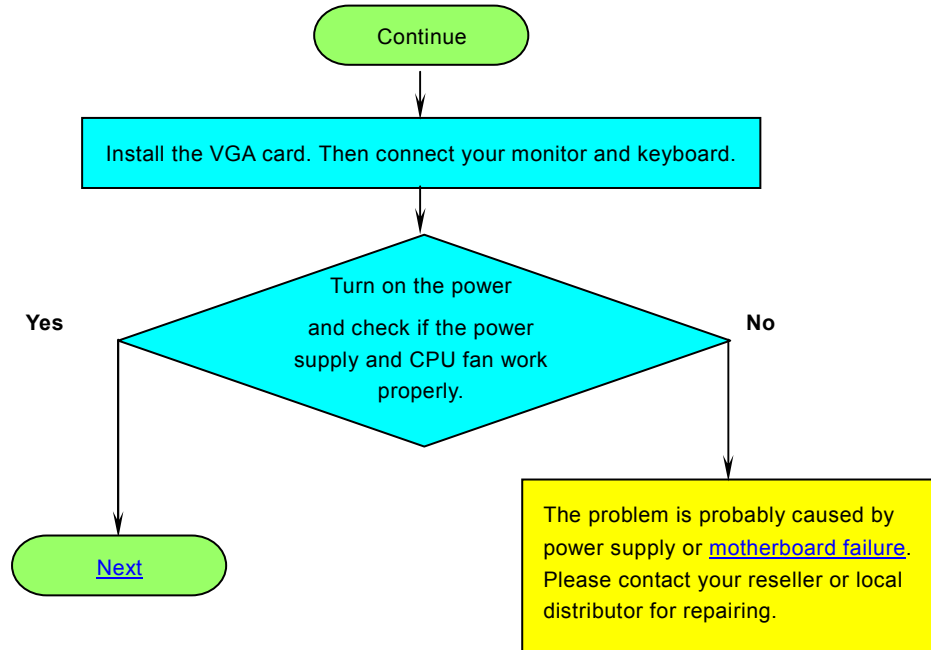

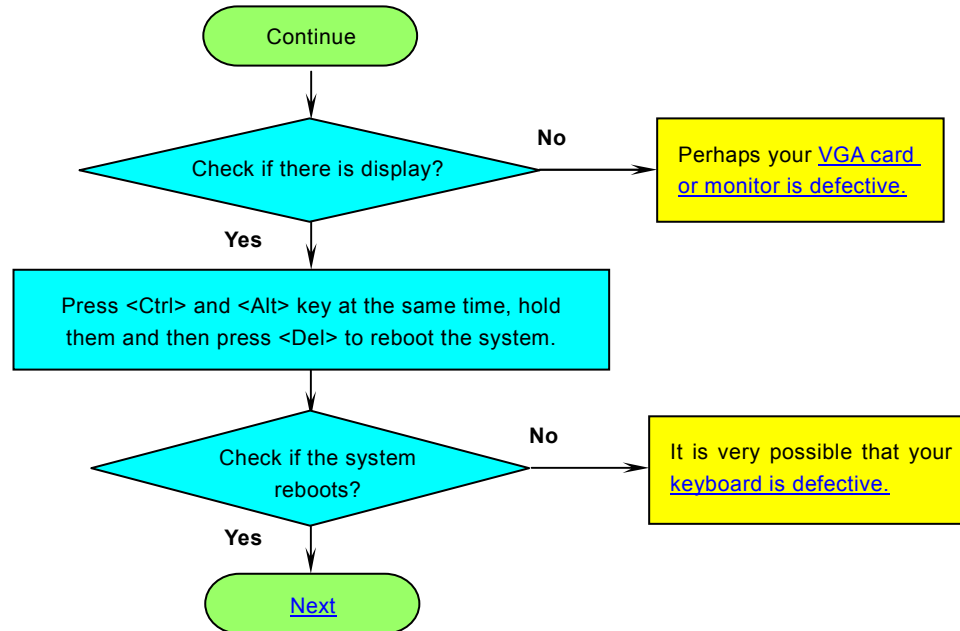

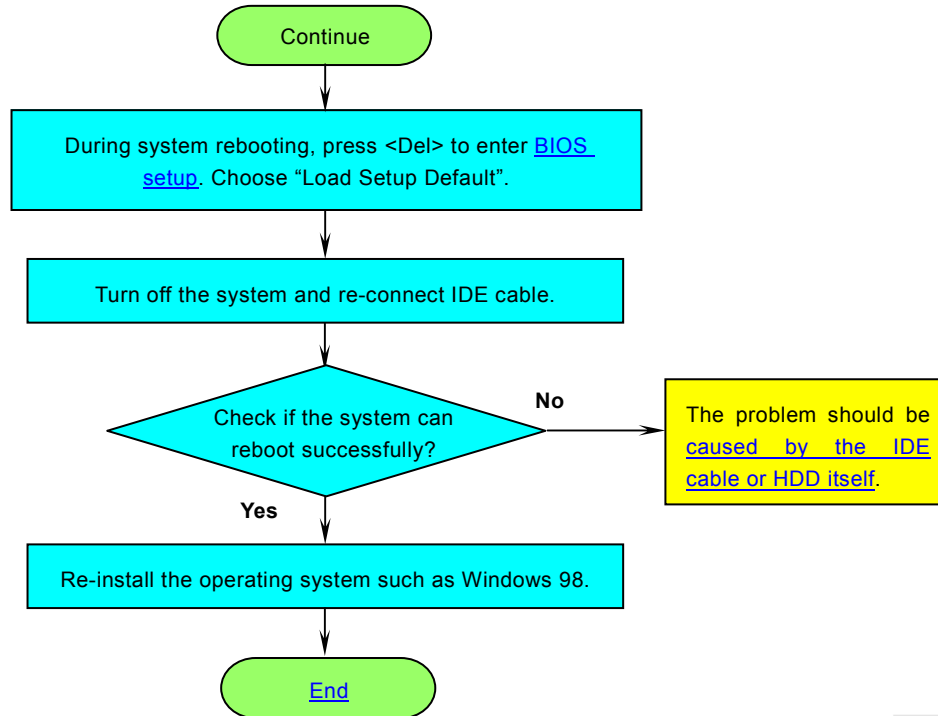



Technical Support

Dear Customer,

Thanks for choosing AOpen products. To provide the best and fastest service to our customer is our first priority. However, we receive numerous emails and phone-calls worldwide everyday, it is very hard for us to serve everyone on time. We recommend you follow the procedures below and seek help before contact us. With your help, we can then continue to provide the best quality service to more customers.

Thanks very much for your understanding!

AOpen Technical Supporting Team

1

Online Manual: Please check the manual carefully and make sure the jumper settings and installation procedure are correct.

<http://english.aopen.com.tw/tech/download/manual/default.htm>

2

Test Report: We recommend choosing board/card/device from the compatibility test reports for assembling your PC.

<http://english.aopen.com.tw/tech/report/default.htm>

3

FAQ: The latest FAQ (Frequently Asked Questions) may contain a solution to your problem.

<http://english.aopen.com.tw/tech/faq/default.htm>

4

Download Software: Check out this table to get the latest updated BIOS/utility and drivers.

<http://english.aopen.com.tw/tech/download/default.htm>

5

News Group: News posted by computer experts, you are welcome to join any discussion and learning from it.
<http://english.aopen.com.tw/tech/newsgrp/default.htm>

6

Contact Distributors/Resellers: We sell our products through resellers and integrators. They should know your system configuration very well and should be able to solve your problem more efficiently than us. After all, their attitude of service is an important reference for you if next time you want to buy something else from them.

7

Contact Us: Please prepare detail system configuration and error symptom before contacting us. The **part number**, **serial number** and **BIOS version** are also very helpful.

Part Number and Serial Number

The Part Number and Serial number are printed on bar code label. You can find this bar code label on the outside packing or on component side of PCB. For example:



P/N: 91.88110.201 is part number, **S/N: 91949378KN73** is serial number.

Model name and BIOS version

Model name and BIOS version can be found on upper left corner of first boot screen ([POST](#) screen). For example:



AX4GEFM R1.20 Mar.01.2002 AOpen Inc.

Phoenix-Award Plug and Play BIOS Extension v1.0A

Copyright © 1998, Award Software, Inc.

AX4GEFM is model name of motherboard; **R1.20** is BIOS version.



Product Registration

ClubAOpen

Welcome to AOpen Inc.



Thank you for choosing AOpen product. AOpen encourages you to spend few minutes in completing the following product registration. To register your product will ensure the high quality of services from AOpen. After the registration, you will:

- Have opportunities to play online slot machine and win a prize from AOpen by accumulating your bonuses for later prize exchange.
- Be upgraded to gold membership of Club AOpen program.
- Receive email notification about product safety alerts. Its purpose is to alert consumers quickly and conveniently when products contain technical issues.
- Receive email notification about latest product's announcements.
- Be able to personalize your AOpen web pages.
- Receive e-mail notification about latest BIOS/Driver/Software release information.
- Have opportunities to participate special product promotional programs.
- Enjoy higher service priority to receive technical assistance provided by AOpen specialists worldwide.
- Be able to join the discussions of web-based news groups.

AOpen makes sure that the information you provide is encrypted, so that it cannot be read or intercepted by other people or companies. Further, AOpen will not disclose any of information you submitted under any conditions. Please consult our [online privacy policy](#) for further information on our company policy.

Note: *If registering products purchased from different dealers/retails and/or purchased on different dates, please submit a separate form for each product.*

AOpen



How to Contact Us



Please do not hesitate contact us if you have any problem about our products. Any opinion will be appreciated.

Pacific Rim

AOpen Inc.

Tel: 886-2-3789-5888

Fax: 886-2-3789-5899

Europe

AOpen Computer b.v.

Tel: 31-73-645-9516

Fax: 31-73-645-9604

America

AOpen America Inc.

Tel: 1-510-489-8928

Fax: 1-510-489-1998

China

艾爾鵬國際貿易(上海)有限公司

Tel: 86-21-6225-8622

Fax: 86-21-6225-7926

Germany

AOpen Computer GmbH.

Tel: 49-1805-559191

Fax: 49-2102-157799

Japan

AOpen Japan Inc.

Tel: 81-048-290-1800

Fax: 81-048-290-1820

Web Site: english.aopen.com.tw

E-mail: Send us email by going through the contact form below.

English <http://english.aopen.com.tw/tech/default.htm>

Japanese <http://www.aopen.co.jp/tech/default.htm>

Chinese <http://www.aopen.com.tw/tech/default.htm>

German <http://www.aopencom.de/tech/default.htm>

Simplified Chinese <http://www.aopen.com.cn/tech/default.htm>

