



AX12260
AMD LX Family PC/104 CPU Module
With CRT, LCD and Ethernet
User's Manual

Disclaimers

This manual has been carefully checked and believed to contain accurate information. AXIOMTEK Co., Ltd. assumes no responsibility for any infringements of patents or any third party's rights, and any liability arising from such use.

AXIOMTEK does not warrant or assume any legal liability or responsibility for the accuracy, completeness or usefulness of any information in this document. AXIOMTEK does not make any commitment to update the information in this manual.

AXIOMTEK reserves the right to change or revise this document and/or product at any time without notice.

No part of this document may be reproduced, stored in a retrieval system, or transmitted, in any form or by any means, electronic, mechanical, photocopying, recording, or otherwise, without the prior written permission of AXIOMTEK Co., Ltd.

CAUTION

If you replace wrong batteries, it causes the danger of explosion. It is recommended by the manufacturer that you follow the manufacturer's instructions to only replace the same or equivalent type of battery, and dispose of used ones.

**©Copyright 2008 AXIOMTEK Co., Ltd.
All Rights Reserved
February 2008, Version A1
Printed in Taiwan**

ESD Precautions

Computer boards have integrated circuits sensitive to static electricity. To prevent chipsets from electrostatic discharge damage, please take care of the following jobs with precautions:

- Do not remove boards or integrated circuits from their anti-static packaging until you are ready to install them.
- Before holding the board or integrated circuit, touch an unpainted portion of the system unit chassis for a few seconds. It discharges static electricity from your body.
- Wear a wrist-grounding strap, available from most electronic component stores, when handling boards and components.

Trademarks Acknowledgments

AXIOMTEK is a trademark of AXIOMTEK Co., Ltd.

Windows[®] is a trademark of Microsoft Corporation.

Phoenix & AWARD are trademarks of Phoenix Technology Ltd.

IBM, PC/AT, PS/2, VGA are trademarks of International Business Machines Corporation.

VIA is a trademark of VIA Technologies, Inc.

Intel[®] and Pentium[®] are trademarks of Intel Corporation.

Winbond is a trademark of Winbond Electronics Corp.

Other brand names and trademarks are the properties and registered brands of their respective owners.

Table of Contents

Disclaimers.....	ii
ESD Precautions.....	iii
Chapter 1 Introduction	1
Specifications	2
Chapter 2 Jumpers and Connectors	5
2.1 Board Dimensions and Fixing Holes	5
2.2 Board Layout	7
2.3 Jumper Settings	9
2.3.1 Audio Line Out/Speaker Out (JP1).....	9
2.3.2 CMOS Clear Jumper (JP2)	10
2.4 Connectors	11
2.4.1 Audio Connector (CN1).....	12
2.4.2 +12V-IN Power Connector (CN2).....	12
2.4.3 Digital I/O Connector (CN3)	13
2.4.4 External Speaker & Internal Buzzer Connector (CN4).....	14
2.4.5 Hard Disk LED Connector (CN5)	14
2.4.6 Power Reset Connector (CN6).....	14
2.4.7 Power Button Connector (CN7).....	15
2.4.8 +5V Standby & PS on Connector (CN8)	15
2.4.9 Power LED Connector (CN9)	15
2.4.10 +5V-IN Power Connector (CN10).....	16
2.4.11 SM BUS Connector (CN11)	16
2.4.12 Serial Port Connectors (COM1, COM2).....	16
2.4.13 Parallel IDE Connector (IDE1)	17
2.4.14 PC/104 Slot (ISA1)	18
2.4.15 6-Pin Keyboard/Mouse Connector (KM1)	20
2.4.16 LAN Connector (LAN1)	20
2.4.17 LCD Connector (LCD1)	21
2.4.18 PCI-104 Slot (PCI1).....	21
2.4.19 USB Connectors (USB1, USB2)	23
2.4.20 VGA Connector (VGA1)	24
Chapter 3 Hardware Description.....	25
3.1 Processor	25
3.2 CPU Bus Clock.....	25
3.3 BIOS.....	25
3.4 System Memory.....	25
3.5 I/O Port Address Map.....	26
3.6 Interrupt Controller	27
Chapter 4 Award BIOS Utility	29
4.1 Entering Setup.....	29
4.2 Control Keys.....	30
4.3 Getting Help	30
4.4 The Main Menu	31
4.5 Standard CMOS Setup Menu.....	32
4.6 Advanced BIOS Features.....	34

4.7	Advanced Chipset Features	37
4.8	Integrated Peripherals	39
4.9	Power Management Setup	43
4.10	PnP/PCI Configuration Setup	45
4.11	PC Health Status	47
4.12	Load Optimized Defaults	48
4.13	Set Supervisor/User Password	49
4.14	Save & Exit Setup	50
4.15	Exit Without Saving	51
Appendix A Watchdog Timer		53
Appendix B Digital I/O		55

MEMO

Chapter 1

Introduction



The **AX12260 Series**, a powerful engine of PC/104 form factor CPU Module, comes with high-performance VIA AMD LX complaint processors and integrates chipsets AMD LX800 + CS5536AD that features FSB 500MHz, both CRT and TTL TFT LCD, PC/104-Plus expansion interfaces which includes one PC/104 for 16-bit ISA and one PCI-104 for 32-bit/33MHz PCI expansion.

It is a PC/104 form factor board with support for one 200-pin DDR DIMM maximum up to 1GB, and graphics UMA with maximum up to 254MB memory, also equipped with four USB2.0 ports, one PATA-100 IDE port, two serial ports for RS-232, one 6-pin wafer for both PS/2 keyboard and mouse, an interface for Fast Ethernet and a digital I/O.

The built-in Watchdog Timer has enhanced the system reliability that achieves a unique feature to distinguish itself from other boards.

Specifications

- **CPU**
 - **AMD LX compliant processors**
- **System Chipset**
 - Integrated chipsets AMD :LX800 and CS5536AD
- **System memory**
 - One 200-pin DDR DIMM maximum up to 1GB
- **BIOS**
 - AWARD BIOS, Plug-and-Play 4Mbit Flash ROM with integrated Ethernet Novell RPL and Windows PXE Boot ROM functions
- **SSD**
 - IDE for DOM or USB 3/4 for PQI USB DOM (DiskOnModule[®])
- **Standard I/O**
 - Two serial ports, support RS-232
 - One PATA-100 IDE Interface with 44-pin 2.0 pitch box-header
 - One PS/2 Keyboard & Mouse Interface
- **Ethernet**
 - One RTL8139DL Fast Ethernet controllers with integrated Boot ROM with RPL and PXE
- **Audio**
 - AC'97 Codec Audio
- **Power Management**
 - Supports Plug & Play, APM (ACPI support)
- **Watchdog Timer**
 - Generates a system reset
 - Software programmable time interval
 - 255 levels, 1~255 seconds
- **Graphics**
 - UMA with maximum up to 254MB memory

- Supports both CRT and TTL TFT LCD
- **Expansion Interface**
 - PC/104 for 16-Bit ISA Bus Expansion
 - PCI-104 for 32-Bit /33MHz PCI Bus Expansion
- **Operating system**
 - Windows XP
- **Form Factor**
 - PC/104+-Plus form factor
- **Power Input**
 - +5V input only supported



NOTE *All specifications and images are subject to change without notice.*

MEMO

Chapter 2 Jumpers and Connectors

2.1 Board Dimensions and Fixing Holes

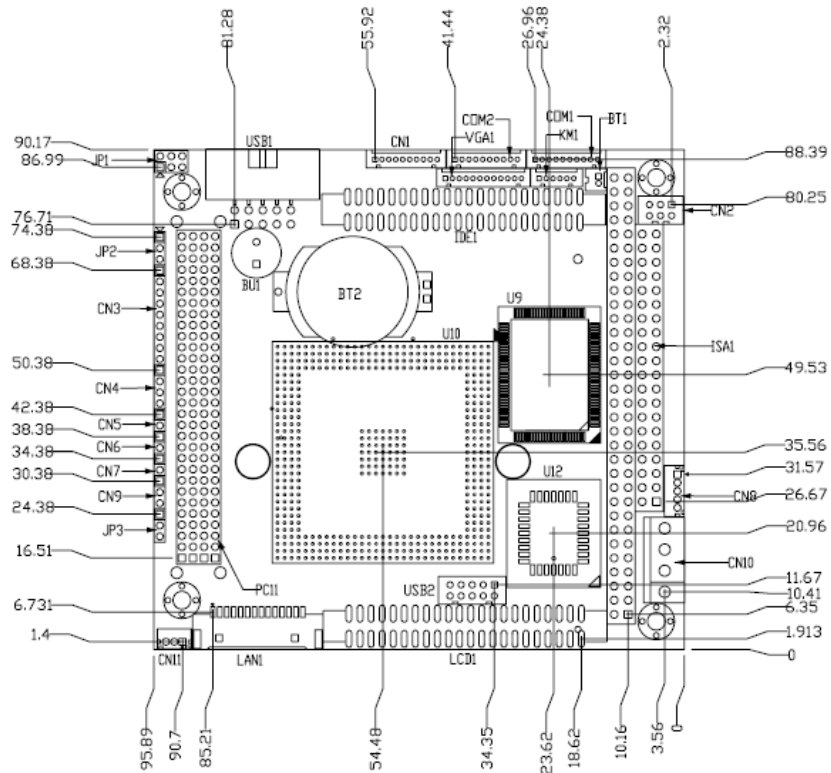

Component Side



Note The Limited Height of Component side is 8.76 mm.

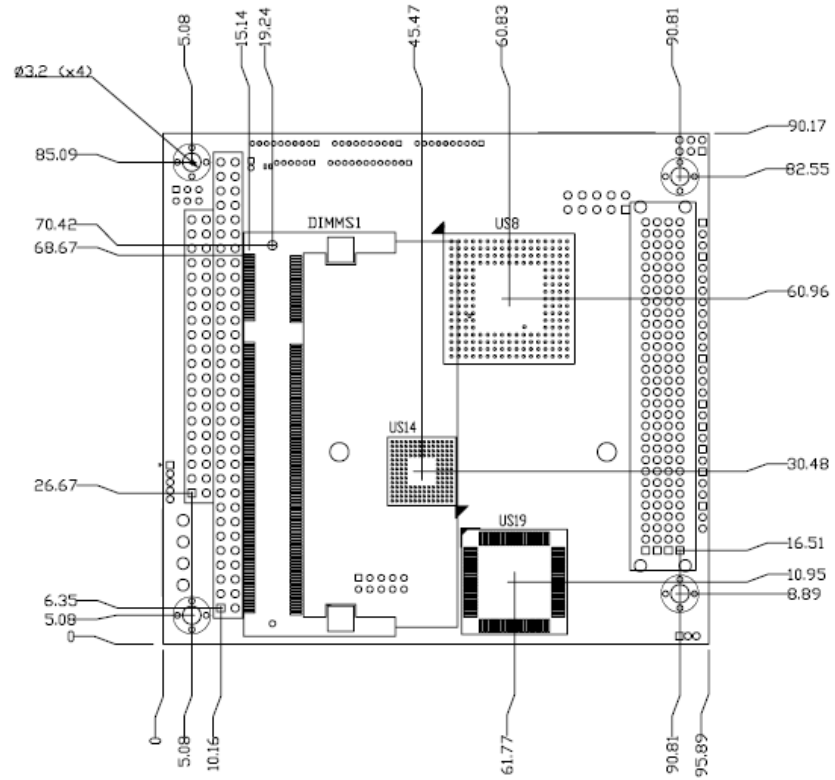

Solder Side

 **Note** The Limited Height of Solder side is 4.83 mm.

2.2 Board Layout

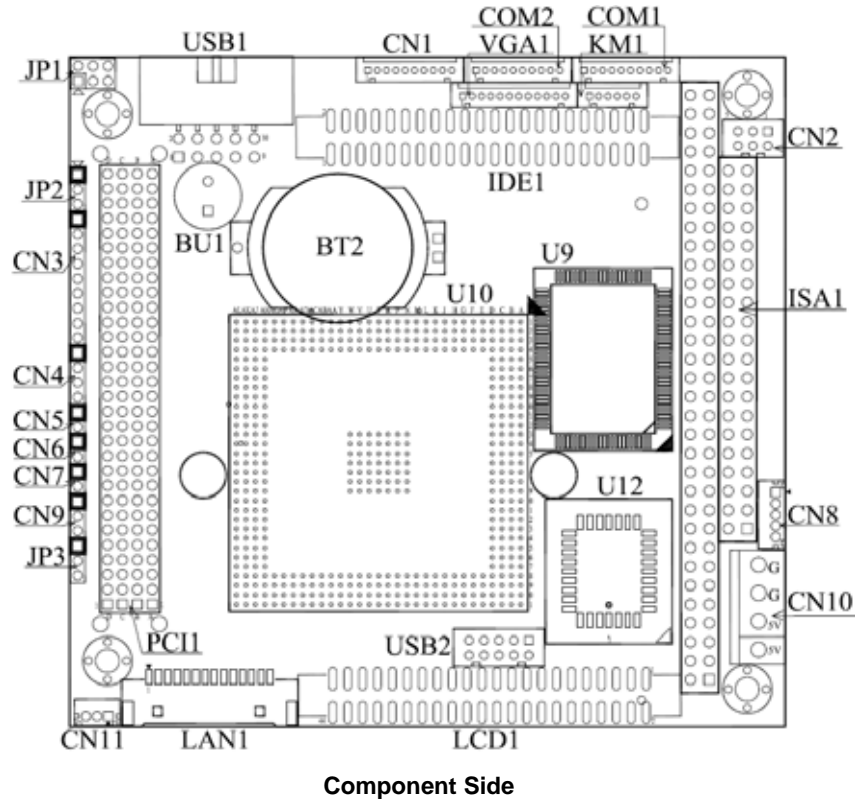

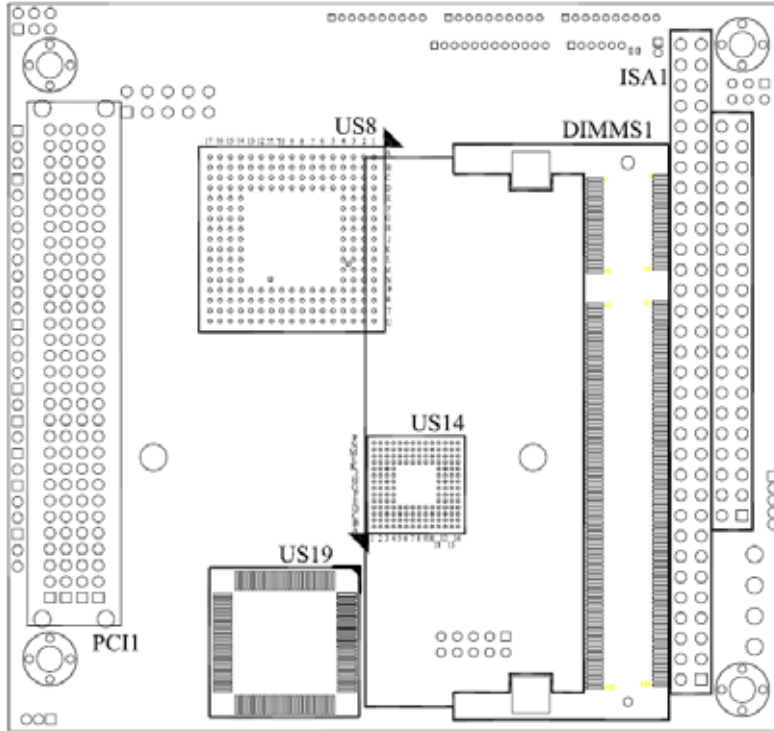

Solder Side



2.3 Jumper Settings

Proper jumper settings configure the **AX12260** to meet your application purpose. We are herewith listing a summary table of all jumpers and default settings for onboard devices, respectively.

Jumper	Description	Jumper Setting
JP1	Audio Line Out/Speaker Out: Line Out	Short 1-3, 2-4
JP2	Clear CMOS setting: Normal	Short 1-2
JP3	LVDS Voltage Select: 3.3V	Short 1-2



2.3.1 Audio Line Out/Speaker Out (JP1)

This jumper makes the selection of Audio output.

Description	Function	Jumper Setting
Audio Line Out/Speaker Out	Line Out (Default)	<p>JP1</p> <p>2 4 6</p>  <p>1 3 5</p>
	Speak Out	<p>JP1</p> <p>2 4 6</p>  <p>1 3 5</p>



2.3.2 CMOS Clear Jumper (JP2)

You may need to use this jumper to clear the CMOS memory if incorrect settings in the Setup Utility.

Description	Function	Jumper Setting
CMOS Clear	Normal (Default)	
	Clear CMOS	

2.3.3 LVDS Voltage Select Jumper (JP3)

This jumper is to select the voltage for LVDS interface.

Description	Function	Jumper Setting
LVDS Voltage Select	3.3V (Default)	
	5V	

2.4 Connectors

Connectors connect the CPU card with other parts of the system. If some problems occur to your system, it might be caused by loose or improper connections. Make sure all connectors are properly and firmly connected. Here is a summary table shows you all connectors on the AX12260 Series.

Connectors	Label
Audio Connector	CN1
+12V-IN Power Connector	CN2
Digital I/O Connector	CN3
External Speaker & Internal Buzzer Connector	CN4
Hard Disk LED Connector	CN5
Power Reset Connector	CN6
Power Button Connector	CN7
+5V Standby & PS on Connector	CN8
Power LED Connector	CN9
+5V-IN Power Connector	CN10
SM BUS Connector	CN11
Serial Port1 Connector	COM1
Serial Port2 Connector	COM2
DDR SO-DIMM	DIMMS1
Parallel IDE Connector	IDE1
PC/-104 Slot	ISA1
6-Pin Keyboard / Mouse Connector	KM1
LAN1 Connector	LAN1
LCD Connector	LCD1
PCI-104 Plus Slot	PCI1
USB Port0 & Port1 Connector	USB1
USB Port2 & Port3 Connector	USB2
VGA Connector	VGA1

2.4.1 Audio Connector (CN1)

CN1 is a 10-pin connector to support the audio interface.

Pin	Signal
1	MIC_IN
2	GND
3	LINE_IN_L
4	GND
5	LINE_IN_R
6	GND
7	AUDIO_OUT_L
8	GND
9	AUDIO_OUT_R
10	GND

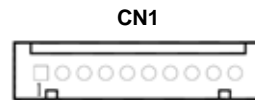

2.4.2 +12V-IN Power Connector (CN2)

Pin	Signal
1	+12V
2	+12V
3	+12V
4	GND
5	GND
6	GND

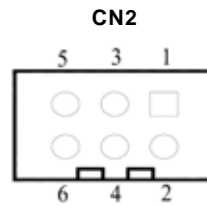

2.4.3 Digital I/O Connector (CN3)

The board is equipped an 8-channel digital I/O connector **CN3** that meets requirements for a system customary automation control. The digital I/O can be configured to control cash drawers, sense warning signals from an Uninterrupted Power System (UPS), or perform store security control. The digital I/O is controlled via software programming.

Pin	Signal	Pin	Signal
1	Digital Input/Output 5	2	Digital Input/Output 6
3	Digital Input/Output 7	4	GND
5	Digital Input/Output 0	6	Digital Input/Output 1
7	Digital Input/Output 2	8	Digital Input/Output 3
9	Digital Input/Output 4		

CN3	
■	1
□	2
□	3
□	4
□	5
□	6
□	7
□	8
□	9

W83627UHG GPIO PIN Number	121 (GP1 7)	122 (GP1 6)	123 (GP1 5)	124 (GP1 4)	125 (GP1 3)	126 (GP1 2)	127 (GP1 1)	128 (GP1 0)
GPIO	Bit 7	Bit 6	Bit 5	Bit 4	Bit 3	Bit 2	Bit 1	Bit 0
CN3	PIN 3	PIN 2	PIN 1	PIN 9	PIN 8	PIN 7	PIN 6	PIN 5
PIN Define	Digita I/O 7	Digita I/O 6	Digita I/O 5	Digita I/O 4	Digita I/O 3	Digita I/O 2	Digita I/O 1	Digita I/O 0

2.4.4 External Speaker & Internal Buzzer Connector (CN4)

This 4-pin **CN4** connector (Pin 1, 2, 3, 4) can be connected to the case-mounted speaker unit or internal buzzer. While connecting the CPU card to an internal buzzer, please short pins 1-2; while connecting to an external speaker, you need to set these pins **Open** and connect the speaker cable to pin 4 (+) and pin 1 (-).

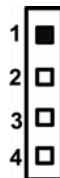

2.4.5 Hard Disk LED Connector (CN5)

This connection is linked to hard drive activity LED on the control panel. LED flashes when HDD is being accessed. The 2-pin **CN5** connector (Pin 1, 2) connects the hard disk drive to the front panel HDD LED, Pin 1 assigned as +, and Pin 2 as -.



2.4.6 Power Reset Connector (CN6)

This 2-pin **CN6** connector (Pin 1, 2) can be connected to the case-mounted reset switch that reboots your computer instead of turning OFF the power switch. It is a better way to reboot your system for a longer life of the system's power supply.



2.4.7 Power Button Connector (CN7)

This 2-pin **CN7** connector (Pin 1, 2) connects the front panel's ATX power button to the CPU card, which allows users to control ATX power supply to be power on/off.



2.4.8 +5V Standby & PS on Connector (CN8)

Pin	Signal
1	+5V_SBY
2	+5V_SBY
3	GND
4	GND
5	PS-ON



2.4.9 Power LED Connector (CN9)

This 3-pin **CN9** connector (Pin 1, 2, 3) connects a LED indicator to the system power switch on the case. Pin 1 is assigned as +, and Pin 2, 3 as -. The Power LED lights up when the system is powered ON.



2.4.10 +5V-IN Power Connector (CN10)

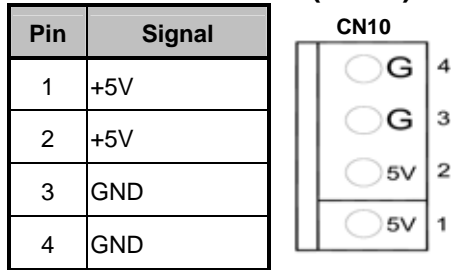

2.4.11 SM BUS Connector (CN11)

Connector SMBUS1 is for SMBUS interface support.

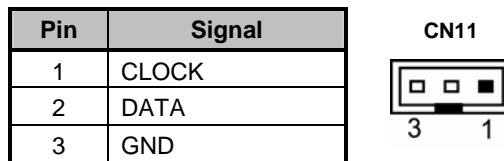

2.4.12 Serial Port Connectors (COM1, COM2)

The board has two serial port connectors COM1 and COM2 for connecting various hardware components via serial port, such as mouse, modem, network, and printer.

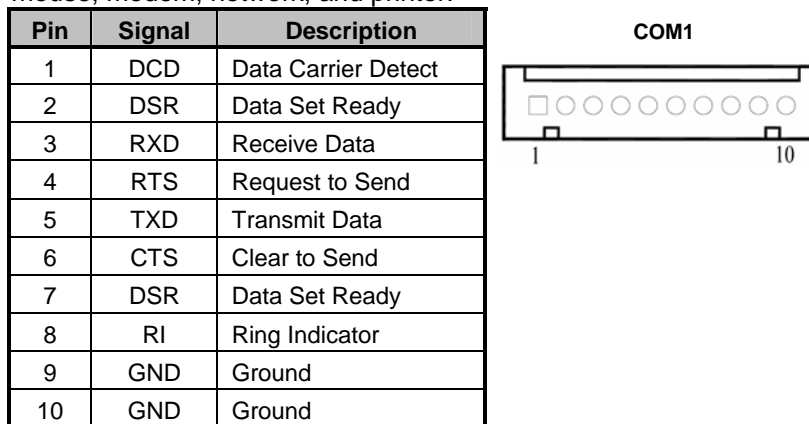

Pin	Signal	Description
1	DCD	Data Carrier Detect
2	DSR	Data Set Ready
3	RXD	Receive Data
4	RTS	Request to Send
5	TXD	Transmit Data
6	CTS	Clear to Send
7	DSR	Data Set Ready
8	RI	Ring Indicator
9	GND	Ground
10	GND	Ground

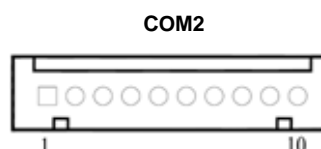

2.4.13 Parallel IDE Connector (IDE1)

An IDE device can be connected to the computer via an IDE connector. One IDE connector is for one single IDE cable to connect two IDE devices. If you want to install two IDE devices, please configure one IDE device as Master, and the other as Slave by setting the jumper.

Pin	Signal	Pin	Signal	Pin	Signal
1	Reset-	2	GND	3	Data 7
4	Data 8	5	Data 6	6	Data 9
7	Data 5	8	Data 10	9	Data 4
10	Data 11	11	Data 3	12	Data 12
13	Data 2	14	Data 13	15	Data 1
16	Data 14	17	Data 0	18	Data 15
19	GND	20	No connector	21	No connector
22	GND	23	IOW-	24	GND
25	IOR-	26	GND	27	IOCHRDY
28	No connector	29	No connector	30	GND-Default
31	Interrupt	32	No connector	33	SA1
34	No connector	35	SA0	36	SA2
37	HDC CS0-	38	HDC CSI-	39	HDD Active-
40	GND	41	+5V	42	+5V
43	GND	44	No connector		

IDE1

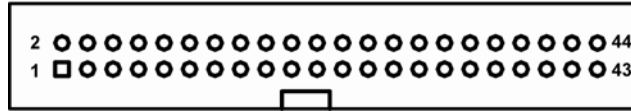

2.4.14 PC/104 Slot (ISA1)

Pin	Signal	Pin	Signal	Pin	Signal	Pin	Signal
1	IOCHCHK*	2	0V	3	SD7	4	RESETDRV
5	SD6	6	+5V	7	SD5	8	IRQ9
9	SD4	10	-5V	11	SD3	12	DRQ2
13	SD2	14	-12V	15	SD1	16	ENDXFR*
17	SD0	18	+12V	19	IOCHRDY	20	(KEY)
21	AEN	22	SMEMW*	23	SA19	24	SMEMR*
25	SA18	26	IOW*	27	SA17	28	IOR *
29	SA16	30	DACK3*	31	SA15	32	DRQ3
33	SA14	34	DACK1*	35	SA13	36	DRQ1
37	SA12	38	REFRESH*	39	SA11	40	SYSCLK
41	SA10	42	IRQ7	43	SA9	44	IRQ6
45	SA8	46	IRQ5	47	SA7	48	IRQ4
49	SA6	50	IRQ3	51	SA5	52	DACK2*
53	SA4	54	TC	55	SA3	56	SALE
57	SA2	58	+5V	59	SA1	60	OSC
61	SA0	62	0V	63	0V	64	0V

Pin	Signal	Pin	Signal	Pin	Signal	Pin	Signal
1	0V	2	0V	3	MEMCS16*	4	SBHE*
5	IOCS16*	6	LA23	7	IRQ10	8	LA22
9	IRQ11	10	LA21	11	IRQ12	12	LA20
13	IRQ15	14	LA19	15	IRQ14	16	LA18
17	DACK0*	18	LA17	19	DRQ0	20	MEMR*
21	DACK5*	22	MEMW*	23	DRQ5	24	SD8
25	DACK6*	26	SD9	27	DRQ6	28	SD10

Pin	Signal	Pin	Signal	Pin	Signal	Pin	Signal
29	DACK7*	30	SD11	31	DRQ7	32	SD12
33	+5V	34	SD13	35	MASTER*	36	SD14
37	0V	38	SD15	39	0V	40	(KEY)



ISA1

2.4.15 6-Pin Keyboard/Mouse Connector (KM1)

The 6-pin **KM1** connector is for PS/2 Mouse and PS/2 keyboard connection. The board supports a keyboard and Mouse interface.

Pin	Signal
1	Keyboard Data
2	Mouse Data
3	GND
4	+5V
5	Keyboard CLK
6	Mouse CLK

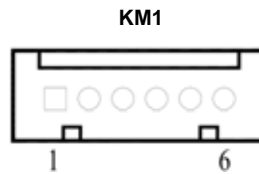

2.4.16 LAN Connector (LAN1)

Pin	Signal
1	+3.3V
2	100 LAN LED
3	GND
4	N.C.
5	N.C.
6	RX- (Data reception negative)
7	N.C.
8	N.C.
9	RX+ (Data reception positive)
10	TX- (Data transmission negative)
11	TX+ (Data transmission positive)
12	N.C.
13	+3.3V
14	Active LED

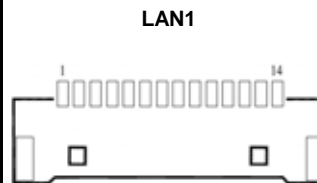

2.4.17 LCD Connector (LCD1)

Pin	Signal	Pin	Signal	Pin	Signal
1	N.C.	2	+12VM	3	GND
4	GND	5	VDDM	6	VDDM
7	FPDISP	8	GND	9	B0 (P0)
10	B1 (P1)	11	N2 (P2)	12	B3 (P3)
13	B4 (P4)	14	B5 (P5)	15	B6 (P6)
16	B7 (P7)	17	G0 (P8)	18	G1 (P9)
19	G2 (P10)	20	G3 (P11)	21	G4 (P12)
22	G5 (P13)	23	G6 (P14)	24	G7 (P15)
25	R0 (P16)	26	R1 (P17)	27	R2 (P18)
28	R3 (P19)	29	R4 (P20)	30	R5 (P21)
31	R6 (P22)	32	R7 (P23)	33	GND
34	GND	35	FPCLK	36	FPVSYNC (FLM)
37	M (DE)	38	FPHSYNC (LP)	39	GND
40	FPENABKL	41	GND	42	N.C.
43	VDDM	44	VDDM		

LCD1

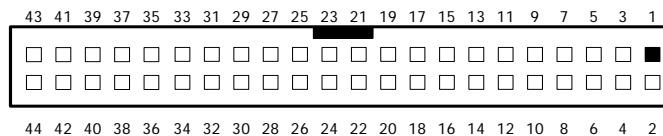

2.4.18 PCI-104 Plus Slot (PCI1)

Pin	Signal	Pin	Signal	Pin	Signal	Pin	Signal
A1	N.C	B1	Reserved	C1	+5V	D1	AD0
A2	N.C	B2	AD2	C2	AD1	D2	+5V
A3	AD5	B3	GND	C3	AD4	D3	AD3
A4	C/BE0#	B4	AD7	C4	GND	D4	AD6
A5	GND	B5	AD9	C5	AD8	D5	GND
A6	AD11	B6	N.C	C6	AD10	D6	M66EN
A7	AD14	B7	AD13	C7	GND	D7	AD12
A8	+3.3V	B8	C/BE1#	C8	AD15	D8	+3.3V
A9	SERR#	B9	GND	C9	SB0#	D9	PAR

Pin	Signal	Pin	Signal	Pin	Signal	Pin	Signal
A10	GND	B10	PERR#	C10	+3.3V	D10	SDONE
A11	STOP*	B11	+3.3V	C11	LOCK#	D11	GND
A12	+3.3V	B12	TRDY#	C12	GND	D12	DEVSEL#
A13	FRAME#	B13	GND	C13	IRDY#	D13	+3.3V
A14	GND	B14	AD16	C14	+3.3V	D14	C/BE2#
A15	AD18	B15	+3.3V	C15	AD17	D15	GND
A16	AD21	B16	AD20	C16	GND	D16	AD19
A17	+3.3V	B17	AD23	C17	AD22	D17	+3.3V
A18	IDSEL0	B18	GND	C18	IDSEL1	D18	IDSEL2
A19	AD24	B19	C/BE3#	C19	N.C.	D19	IDSEL3
A20	GND	B20	AD26	C20	AD25	D20	GND
A21	AD29	B21	+5V	C21	AD28	D21	AD27
A22	+5V	B22	AD30	C22	GND	D22	AD31
A23	REQ0#	B23	GND	C23	REQ1#	D23	N.C.
A24	GND	B24	REQ2#	C24	+5V	D24	GNT0#
A25	GNT1#	B25	N.C	C25	GNT2#	D25	GND
A26	+5V	B26	CLK0	C26	GND	D26	CLK1
A27	CLK2	B27	+5V	C27	CLK3	D27	GND
A28	GND	B28	INTD#	C28	+5V	D28	RST#
A29	+12V	B29	INTA#	C29	INTB#	D29	INTC#
A30	-12V	B30	Reserved	C30	Reserved	D30	GND

-- End of PCI104 Plus Slot (PCI1) Pin Assignment Table --

2.4.19 USB Connectors (USB1, USB2)

The Universal Serial Bus (USB) connectors on the board are for the installation of peripherals supporting the USB interface. **USB1** and **USB2** are 10-pin standard onboard USB connectors.

Pin	Signal
1	+5V
2	+5V
3	USB D2-
4	USB D3-
5	USB D2+
6	USB D3+
7	GND
8	GND
9	GND
10	GND

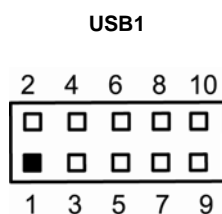

Pin	Signal
1	+5V
2	+5V
3	USB D0-
4	USB D0-
5	USB D1+
6	USB D1+
7	GND
8	GND
9	GND
10	GND

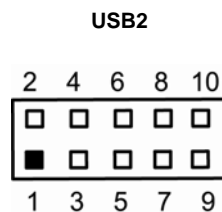

2.4.20 VGA Connector (VGA1)

Pin	Signal
1	RED
2	AGND
3	GREEN
4	AGND
5	BLUE
6	AGND
7	+5V
8	DCC DATA
9	DCC CLK
10	GND
11	Horizontal Sync
12	Vertical Sync

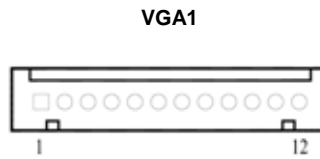

Chapter 3

Hardware Description

This chapter provides you with detailed description about the **AX12260 Series** CPU board's hardware features.

3.1 Processor

The **AX12260 Series** comes with embedded high-performance AMD compliant processors. The CPU can be operated under Windows CE, Windows XP, Windows XP Embedded and Embedded Linux systems.

3.2 CPU Bus Clock

The Host Clock can be doubled inside the CPU to operate in a range of 500MHz.

3.3 BIOS

The **AX12260 Series** uses Award Plug and Play BIOS with a single 4Mbit Flash EPROM.

3.4 System Memory

The **AX12260 Series** PC/104 CPU module supports one 200-pin DDR memory onboard with maximum system memory 1GB unbuffered SDRAMs.

3.5 I/O Port Address Map

The CPU card communicates via I/O ports. A total 1KB port addresses can be assigned to other devices via I/O expansion cards.

Address	Devices
000-00F	DMA controller #1
020-021	Interrupt controller #1
022-03F, 044-047 04C-06F, 072-07F 090-09F, 0A2-0BF 0E0-0EF, 100-CF7 D00-FFF	PCI Bus
040-043	Timer Controller
060	Keyboard controller
061	System speaker
064	Kbd Ctr, CMD, STAT Byte
070-071	Real Time Clock
081-091	DMA page register
0A0-A1	Interrupt controller #2
0C0-0DE	DMA controller #1
0F0-0FF	Reset Numeric Error
1F0-1F7	Primary IDE Channel
274-27F 279, A79	ISAPNP Read Data Port
2F8-2FF	Serial Port 2#2 (COM2)
3F6	IDE Command Port
3F7	Standard floppy disk controller
3F8-3FF	Serial Port 1#1 (COM1)
FC00-FCFF	Realtek RTL8139 Family PCI Fast Ethernet NIC
FE00-FE7F	GeodeLX Audio Driver(WDM)

3.6 Interrupt Controller

The **AX12260** is a fully PC compatible control board. The mapping list of the 16 interrupt request lines is shown as below:

NMI	Parity check error
IRQ0	System timer output
IRQ1	Keyboard
IRQ2	Interrupt rerouting from IRQ8 through IRQ15
IRQ3	Serial port #2
IRQ4	Serial port #1
IRQ5	Standard Enhanced PCI to USB Host Controller
IRQ5	Standard OpenHCD USB Host Controller
IRQ8	Real time clock
IRQ9	ACPI Controller
IRQ10	GeodeLX Audio Driver (WDM)
IRQ11	Advanced Micro Devices Win2K/XP Graphics Driver
IRQ11	GeodeLX AES Crypto Driver
IRQ12	PS/2 Mouse
IRQ13	Math coprocessor
IRQ14	Primary IDE channel
IRQ15	Realtek RTL8139 Family PCI Fast Ethernet NIC

MEMO

Chapter 4

Award BIOS Utility

The Phoenix-Award BIOS provides users with a built-in Setup program to modify basic system configuration. All configured parameters are stored in a battery-backed-up RAM (CMOS RAM) to save the Setup information whenever the power is turned off.

4.1 Entering Setup

There are two ways to enter the Setup program. You may either turn ON the computer and press immediately, or press the and/or <Ctrl>, <Alt>, and <Esc> keys simultaneously when the following message appears at the bottom of the screen during POST (Power on Self Test).

TO ENTER SETUP PRESS DEL KEY

If the message disappears before you respond and you still want to enter Setup, please restart the system to try it again. Turning the system power OFF and ON, pressing the "RESET" button on the system case or simultaneously pressing <Ctrl>, <Alt>, and keys can restart the system. If you do not press keys at the right time and the system doesn't boot, an error message will pop out to prompt you the following information:

PRESS <F1> TO CONTINUE, <CTRL-ALT-ESC> OR TO ENTER SETUP

4.2 Control Keys

Up arrow	Move cursor to the previous item
Down arrow	Move cursor to the next item
Left arrow	Move cursor to the item on the left hand
Right arrow	Move to the item in the right hand
Esc key	Main Menu -- Quit and delete changes into CMOS Status Page Setup Menu and Option Page Setup Menu -- Exit current page and return to Main Menu
PgUp/“+” key	Increase the numeric value or make changes
PgDn/“-“ key	Decrease the numeric value or make changes
F1 key	General help, only for Status Page Setup Menu and Option Page Setup Menu
(Shift) F2 key	Change color from total 16 colors. F2 to select color forward, (Shift) F2 to select color backward
F3 key	Reserved
F4 key	Reserved
F5 key	Restore the previous CMOS value from CMOS, only for Option Page Setup Menu
F6 key	Reserved
F7 key	Load the Setup default, only for Option Page Setup Menu
F8 key	Reserved
F9 key	Reserved
F10 key	Save all the CMOS changes, only for Main Menu

4.3 Getting Help

- Main Menu**
 The online description of the highlighted setup function is displayed at the bottom of the screen.
- Status Page Setup Menu/Option Page Setup Menu**
 Press <F1> to pop out a small Help window that provides the description of using appropriate keys and possible selections for highlighted items. Press <F1> or <Esc> to exit the Help Window.

4.4 The Main Menu

Once you enter the Award BIOS CMOS Setup Utility, the Main Menu appears on the screen. In the Main Menu, there are several Setup functions and a couple of Exit options for your selection. Use arrow keys to select the Setup Page you intend to configure then press <Enter> to accept or enter its sub-menu.

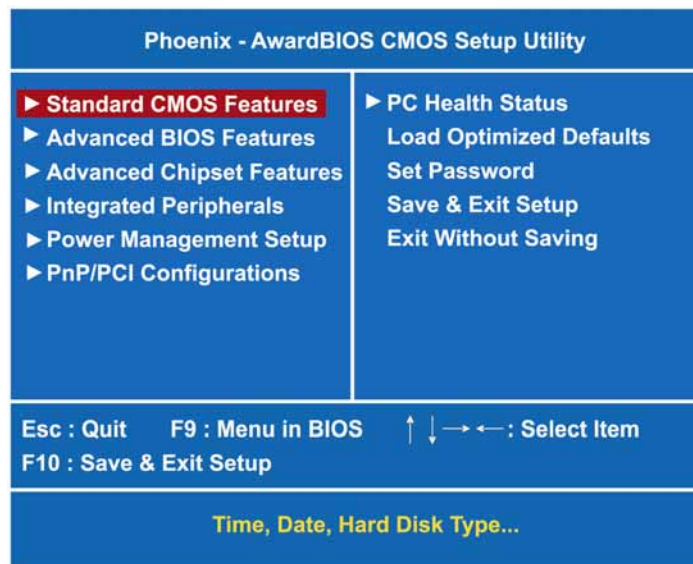

 **NOTE** *If your computer can not boot after making and saving system changes with Setup, the Award BIOS will reset your system to the CMOS default settings via its built-in override feature.*

It is strongly recommended that you should avoid changing the chipset's defaults. Both Award and your system manufacturer have carefully set up these defaults that provide the best performance and reliability.

4.5 Standard CMOS Setup Menu

The Standard CMOS Setup Menu displays basic information about your system. Use arrow keys to highlight each item, and use <PgUp> or <PgDn> key to select the value you want in each item.

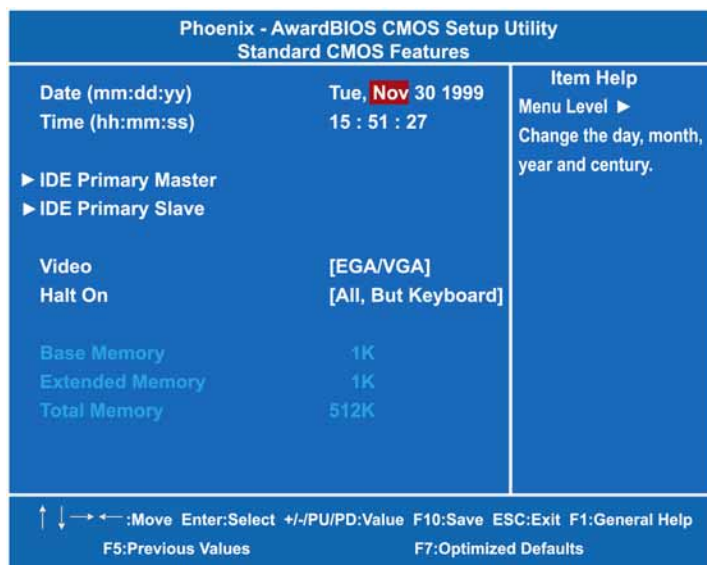

- Date**
 The date format is <day>, <date> <month> <year>. Press <F3> to show the calendar.

day	It is determined by the BIOS and read only, from Sunday to Saturday.
date	It can be keyed with the numerical/ function key, from 1 to 31.
month	It is from January to December.
year	It shows the current year of BIOS.

- Time**
 This item shows current time of your system with the format <hour> <minute> <second>. The time is calculated based on the 24-hour military-time clock. For example, 1 p.m. is 13:00:00.

- **IDE Primary Master/Primary Slave**

These items identify the types of each IDE channel installed in the computer. There are 45 predefined types (Type 1 to Type 45) and 2 user's definable types (Type User) for Enhanced IDE BIOS.

Press <PgUp>/<+> or <PgDn>/<-> to select a numbered hard disk type, or directly type the number and press <Enter>. Please be noted your drive's specifications must match the drive table. The hard disk will not work properly if you enter improper information. If your hard disk drive type does not match or is not listed, you can use Type User to manually define your own drive type.

If selecting Type User, you will be asked to enter related information in the following items. Directly key in the information and press <Enter>. This information should be provided in the documentation from your hard disk vendor or the system manufacturer.

If the HDD interface controller supports ESDI, select "Type 1".

If the HDD interface controller supports SCSI, select "None".

If the HDD interface controller supports CD-ROM, select "None".

CYLS.	number of cylinders	LANDZONE	landing zone
HEADS	number of heads	SECTORS	number of sectors
PRECOMP	write precom	MODE	HDD access mode

If there is no hard disk drive installed, select NONE and press <Enter>.

- **Video**

Select the display adapter type for your system.

- **Halt On**

This item determines whether the system will halt or not, if an error is detected while powering up.

No errors	The system booting will halt on any errors detected. (default)
All errors	Whenever BIOS detects a non-fatal error, the system will stop and you will be prompted.
All, But Keyboard	The system booting will not stop for a keyboard error; it will stop for other errors.

Press <Esc> to return to the Main Menu page.

4.6 Advanced BIOS Features

This section allows you to configure and improve your system, to set up some system features according to your preference.

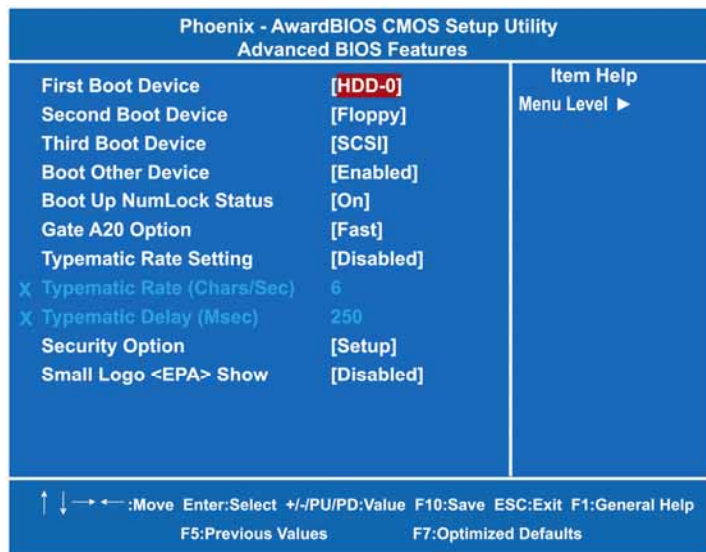

- First/Second/Third Boot Device**
 These items let you select the 1st, 2nd, and 3rd devices that the system will search for during its boot-up sequence. The wide range of selection includes *Floppy*, *LS120*, *ZIP100*, *HDD0~3*, *SCSI*, and *CDROM*.
- Boot Other Device**
 This item allows users to enable or disable the boot device not listed in the First/Second/Third boot devices option above. The default setting is “*Enabled*”.
- Boot Up NumLock Status**
 Set the the Num Lock status when the system is powered on. The default value is “*On*”.

- **Gate A20 Option**

The default value is "Fast".

Normal	The A20 signal is controlled by keyboard controller or chipset hardware.
Fast	Default: Fast. The A20 signal is controlled by Port 92 or chipset specific method.

- **Typematic Rate Setting**

This item determines the typematic rate of the keyboard. The default value is "Disabled".

Enabled	Enable typematic rate and typematic delay programming.
Disabled	Disable typematic rate and typematic delay programming. The system BIOS will use default value of these 2 items, controlled by keyboard.

- **Typematic Rate (Chars/Sec)**

This option refers to character numbers typed per second by the keyboard. The default value is "6".

6	6 characters per second
8	8 characters per second
10	10 characters per second
12	12 characters per second
15	15 characters per second
20	20 characters per second
24	24 characters per second
30	30 characters per second

- **Typematic Delay (Msec)**

This option defines how many milliseconds must elapse before a held-down key begins generating repeat characters. The default value is "250".

250	250 msec
500	500 msec
750	750 msec
1000	1000 msec

- **Security Option**

This item allows you to limit access to the system and Setup, or just to Setup. The default value is "Setup".

System	If a wrong password is entered at the prompt, the system will not boot, the access to Setup will be denied, either.
Setup	If a wrong password is entered at the prompt, the system will boot, but the access to Setup will be denied.



NOTE *To disable the security, select **PASSWORD SETTING** at Main Menu and then you will be asked to enter a password. Do not type anything, just press <Enter> and it will disable the security. Once the security is disabled, the system will boot and you can enter Setup freely.*

- **Small Logo (EPA) Show**
If enabled, the EPA logo will appear during system booting up; if disabled, the EPA logo will not appear.

Press <Esc> to return to the Main Menu page.

4.7 Advanced Chipset Features

This section contains completely optimized chipset's features on the board that you are strongly recommended to leave all items on this page at their default values unless you are very familiar with the technical specifications of your system hardware.

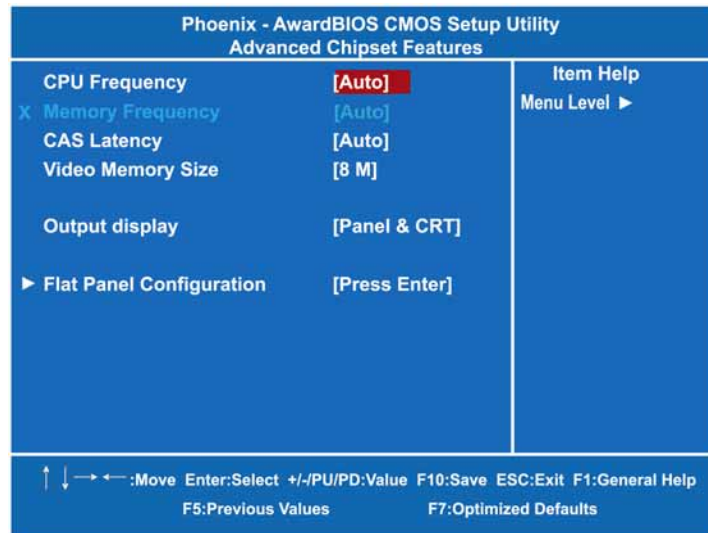

- **CPU Frequency**
This item helps you set CPU frequency.
- **Memory Frequency**
This item helps you set main memory frequency. When using an external graphics card, it can be adjusted to enable the best performance for your system.
- **CAS Latency**
You can select CAS latency time to HCLKs 2, 3, or Auto. The board designer should have set up these values in accordance with the installed DRAM. Do not change these values unless you have to change the specifications of the installed DRAM or CPU.
- **Output display**
Use this item to select output display from these options: "Panel & CRT", "Flat Panel" and "CRT".

- **Flat Panel Configuration**

Scroll to this item and press <Enter> to view the sub menu Flat Panel Configuration for configure the panel resolution.

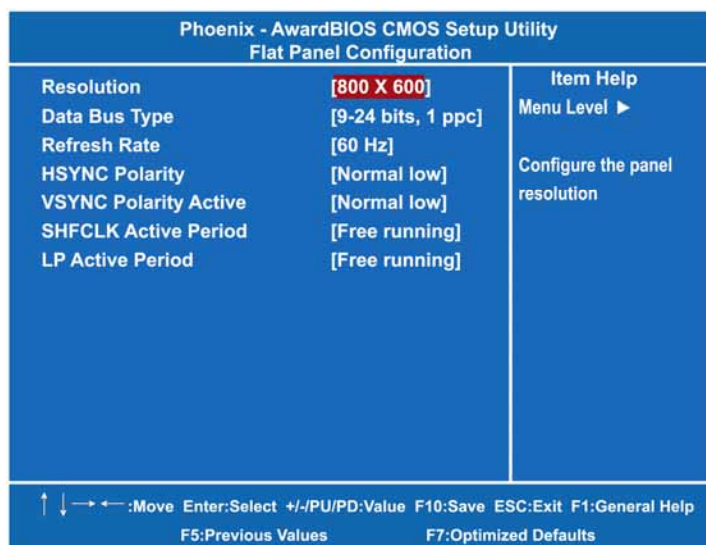

Press <Esc> to return to the Advanced Chipset Features page, and press it again to the Main Menu page

4.8 Integrated Peripherals

This section allows you to configure your Super IO Device, IDE Function Setup, Onboard Device, and ITE8888 configure.

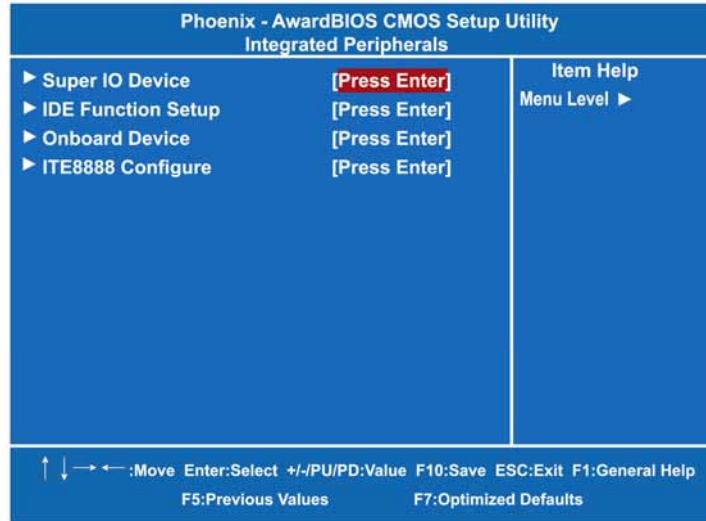

- **Super IO Device**

Scroll to this item and press <Enter> to view the sub menu Super IO Device.

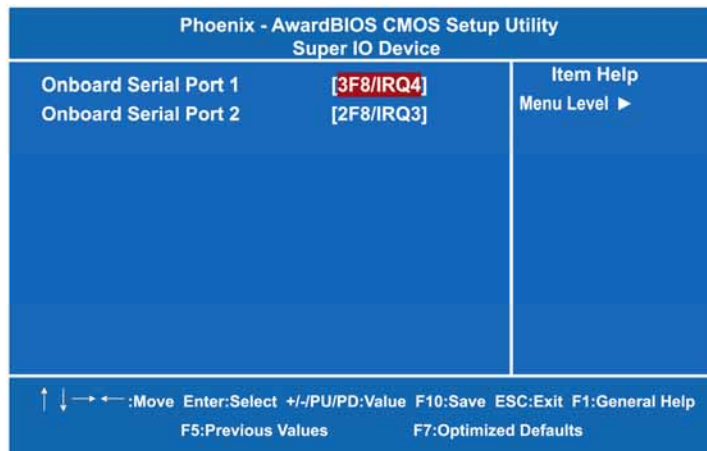

➤ **Onboard Serial Port 1 / 2**

Select an address and corresponding interrupt for the serial port. Options: 3F8/IRQ4, 2E8/IRQ3, 3E8/IRQ4, 2F8/IRQ3, Disabled, Auto.

Press <Esc> to return to the Integrated Peripherals page.

● **IDE Function Setup**

Scroll to this item and press <Enter> to view the sub menu IDE Function Setup.



➤ **Master/Slave Drive PIO**

The four IDE PIO (Programmed Input/Output) fields let you set a PIO mode (0-4) for each of the four IDE devices that the onboard IDE interface supports. Modes 0 to 4 provide successively increased performance. In Auto mode, the system automatically determines the best mode for each device.

➤ **IDE Master/Slave UDMA**

Select the mode of operation for the IDE drive. Ultra DMA-33/66/100/133 implementation is possible only if your IDE hard drive supports it and the operating environment includes a DMA driver. If your hard drive and system

software both support Ultra DMA-33/66/100/133, select Auto to enable UDMA mode by BIOS.

- **IDE DMA transfer access**
Automatic data transfer between system memory and IDE device with minimum CPU intervention. This improves data throughput and frees CPU to perform other tasks.
- **IDE HDD Block Mode**
Block mode is also called block transfer, multiple commands, or multiple sector read/write. If your IDE hard drive supports block mode (most new drives do), select Enabled for automatic detection of the optimal number of block read/writes per sector the drive can support.

Press <Esc> to return to the Integrated Peripherals page.

- **Onboard Device**

Scroll to this item and press <Enter> to view the sub menu Onboard Device.

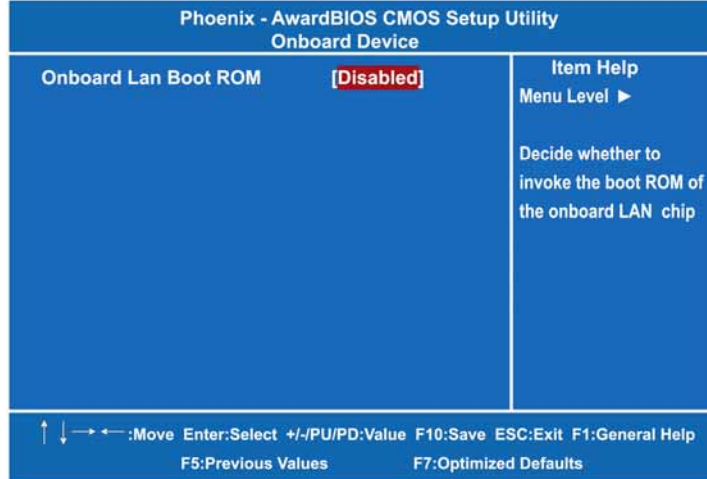

- **Onboard Lan Boot ROM**
Use this item to enable or disable the Boot ROM function of the onboard LAN chip when the system boots up.

Press <Esc> to return to the Integrated Peripherals page.

- **ITE8888 Configure**

Scroll to this item and press <Enter> to view the sub menu ITE8888 Configure.

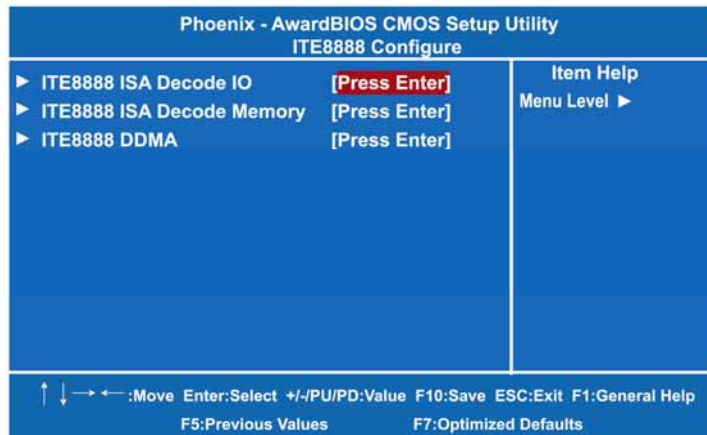

Press <Esc> to return to the Integrated Peripherals, and next to the Main Menu page.

4.9 Power Management Setup

The Power Management Setup allows you to save energy of your system effectively. It will shut down the hard disk and turn OFF video display after a period of inactivity.

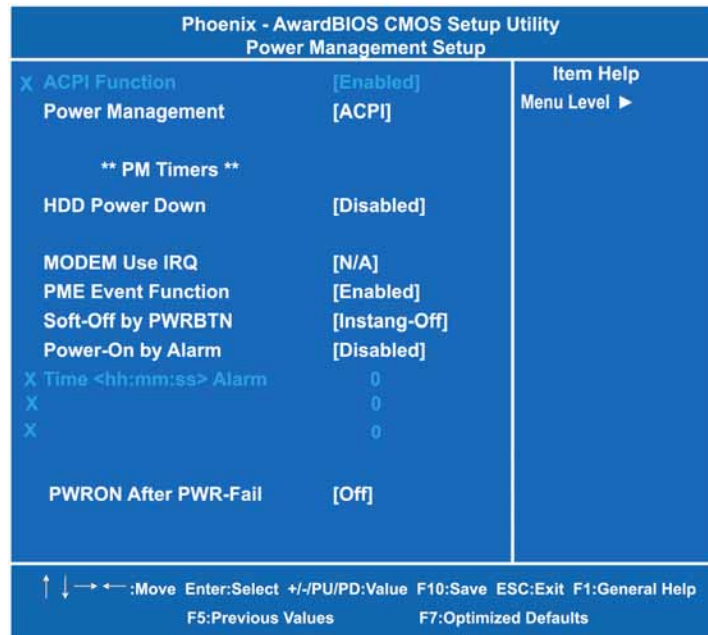

- ACPI Function**
 This item allows you to enable/disable the Advanced Configuration and Power Management (ACPI). The function is always Enabled.
- Power Management**
 This option allows you to select the type of power Management. The options available are APM, ACPI.
- HDD Power Down**
 If HDD activity is not detected for a specified length of time in this field, the hard disk drive will be powered down while other devices remain active.
- Modem Use IRQ**
 If you want an incoming call on a modem to automatically resume

the system from a powersaving mode, use this item to specify the interrupt request line (IRQ) used by the modem. You might have to connect the fax/modem to the board Wake On Modem connector for working this feature.

- **Soft-Off by PWR-BTTN**

This option only works with systems using an ATX power supply. It also allows users to define which type of soft power OFF sequence the system will follow. The default value is "Instant-Off".

Instant-Off	This option follows the conventional manner of system performance when turning the power to OFF. Instant-Off is a software power OFF sequence requiring the power supply button is switched to OFF.
Delay 4 Sec.	Upon the system's turning OFF through the power switch, this option will delay the complete system power OFF sequence approximately 4 seconds. Within this delay period, the system will temporarily enter into the Suspend Mode enabling you to restart the system at once.

- **Power-On by Alarm**

If enable this item, the system can automatically be powered on after a fixed time in accordance with the system's RTC (realtime clock).

- **PWRON After PWR-Fail**

This item enables your computer to automatically restart or return to its operating status.

Press <Esc> to return to the Main Menu page.

4.10 PnP/PCI Configuration Setup

This section describes the configuration of PCI (Personal Computer Interconnect) bus system, which allows I/O devices to operate at speeds close to the CPU speed while communicating with other important components. This section covers very technical items that only experienced users could change default settings.

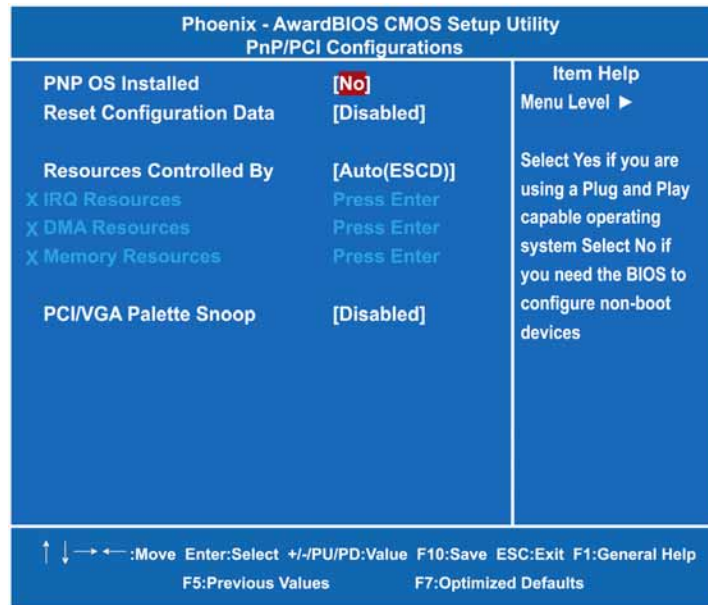

- PNP OS Installed**
 Select Yes if the system operating environment is Plug-and-Play aware (e.g., Windows 95). The default value is "No".
- Reset Configuration Data**
 Normally, you leave this item Disabled. Select Enabled to reset Extended System Configuration Data (ESCD) when you exit Setup or if installing a new add-on cause the system reconfiguration a serious conflict that the operating system can not boot. Options are: "Enabled, Disabled"stem can not boot. The options available are *Enabled* and *Disabled*.
- Resources Controlled By**
 The Award Plug and Play BIOS can automatically configure all boot and Plug and Play-compatible devices. If you select Auto, all

interrupt request (IRQ), DMA assignment, and Used DMA fields disappear, as the BIOS automatically assigns them. The default value is *Manual*.

- **IRQ Resources**

When resources are controlled manually, assign each system interrupt to one of the following types in accordance with the type of devices using the interrupt:

1. Legacy ISA Devices compliant with the original PC AT bus specification, requiring a specific interrupt (such as IRQ4 for serial port 1).
2. PCI/ISA PnP Devices compliant with the Plug and Play standard, whether designed for PCI or ISA bus architecture.

The default value is *PCI/ISA PnP*.

- **DMA Resources**

When resources are controlled manually, assign each system DMA channel as one of the following types, depending on the type of device using the interrupt:

Legacy ISA Devices compliant with the original PC AT bus specification, requiring a specific DMA channel.

PCI/ISA PnP Devices compliant with the Plug and Play standard, whether designed for PCI or ISA bus architecture. The default value is *PCI/ISA PnP*.

- **PCI/VGA Palette Snoop**

Some non-standard VGA display cards may not show colors properly. This item allows you to set whether MPEG ISA/VESA VGA Cards can work with PCI/VGA or not. When enabled, a PCI/VGA can work with a MPEG ISA/VESA VGA card; when disabled, a PCI/VGA cannot work with a MPEG ISA/VESA Card.

Press <Esc> to return to the Main Menu page.

4.11 PC Health Status

This section describes about the hardware monitoring that lets you monitor the parameters for critical voltages, critical temperatures, and fan speeds.

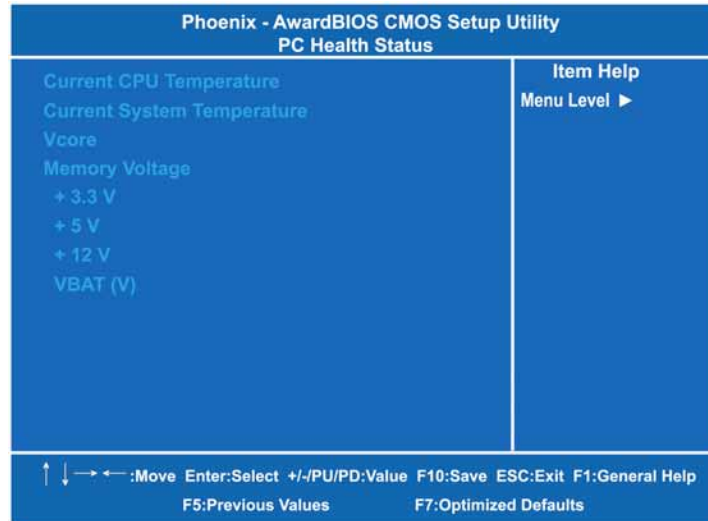

- **Current CPU Temperature**
These read-only fields reflect the functions of the hardware thermal sensor that monitors the chip blocks and system temperatures to ensure the system is stable.
- **Current SYSTEM Temperature**
Show you the current system temperature.
- **Vcore +3.3V/+5V/+12V/VBAT(V)/5VSB**
Show you the voltage of +3.3V/+5V/+12V.

Press <Esc> to return to the Main Menu page.

4.12 Load Optimized Defaults

This option allows you to load your system configuration with default values. These default settings are optimized to enable high performance features.

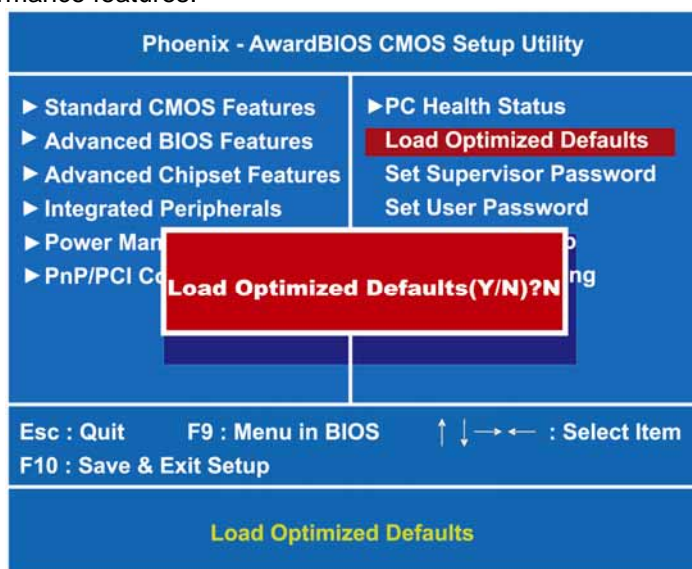

To load CMOS SRAM with SETUP default values, please enter “Y”. If not, please enter “N”.

4.13 Set Supervisor/User Password

You can set a supervisor or user password, or both of them. The differences between them are:

1. **Supervisor password:** You can enter and change the options on the setup menu.
2. **User password:** You can just enter, but have no right to change the options on the setup menu.

When you select this function, the following message will appear at the center of the screen to assist you in creating a password.

ENTER PASSWORD

Type a maximum eight-character password, and press <Enter>. This typed password will clear previously entered password from the CMOS memory. You will be asked to confirm this password. Type this password again and press <Enter>. You may also press <Esc> to abort this selection and not enter a password.

To disable the password, just press <Enter> when you are prompted to enter a password. A message will confirm the password is getting disabled. Once the password is disabled, the system will boot and you can enter Setup freely.

PASSWORD DISABLED

When a password is enabled, you have to type it every time you enter the Setup. It prevents any unauthorized persons from changing your system configuration.

Additionally, when a password is enabled, you can also require the BIOS to request a password every time the system reboots. This would prevent unauthorized use of your computer.

You decide when the password is required for the BIOS Features Setup Menu and its Security option. If the Security option is set to "System", the password is required during booting up and entry into the Setup; if it is set as "Setup", a prompt will only appear before entering the Setup.

4.14 Save & Exit Setup

This section allows you to determine whether or not to accept your modifications. Type "Y" to quit the setup utility and save all changes into the CMOS memory. Type "N" to bring you back to the Setup utility.

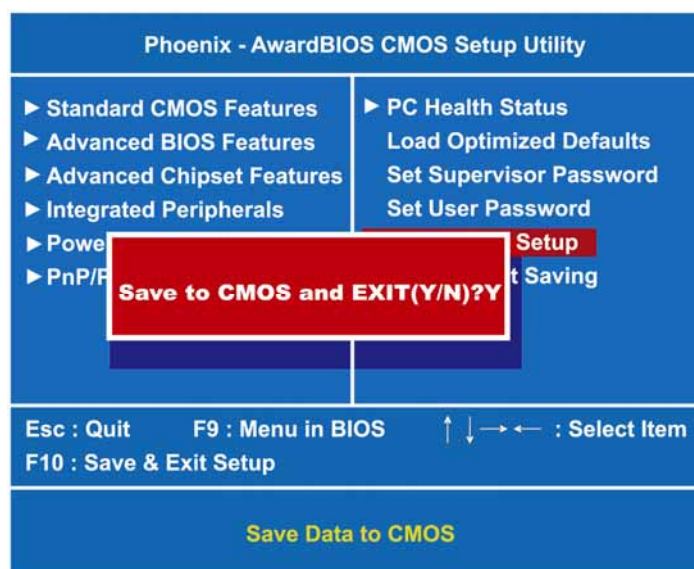

4.15 Exit Without Saving

Select this option to exit the Setup utility without saving changes you have made in this session. Type "Y", and it will quit the Setup utility without saving your modifications. Type "N" to return to the Setup utility.

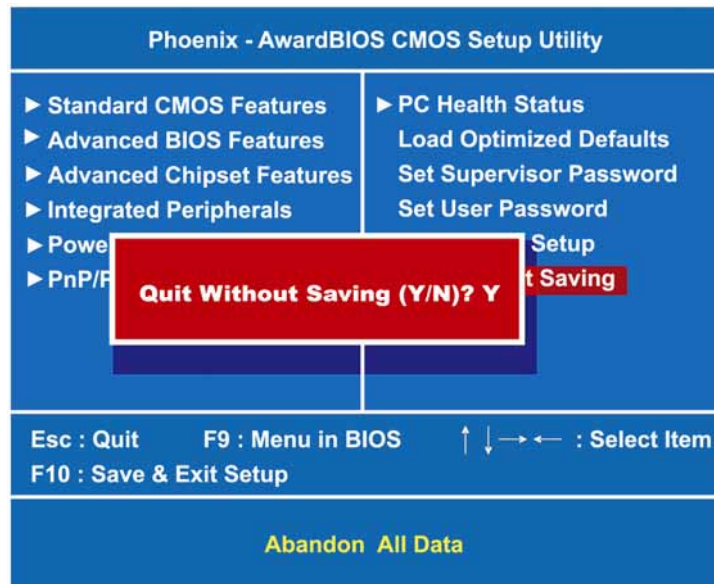

MEMO

Appendix A Watchdog Timer

Watdog Timer Setting

After the system stops working for a while, it can be auto-reset by the Watchdog Timer. The integrated Watchdog Timer can be set up in the system reset mode by program.

- Timeout Value Range
 - 1 to 255
 - Minute / Second

Using the Watchdog Function

Start

↓

Un-Lock WDT :
O 2E 87 ; Un-lock super I/O
O 2E 87 ; Un-lock super I/O

↓

Select Logic device :
O 2E 07
O 2F 08

↓

Activate WDT :
O 2E 30
O 2F 01

↓

Set Second or Minute :
O 2E F5
O 2F N =00 or 08(See below table)

↓

Set base timer :
O 2E F6

↓
WDT counting re-set timer : O 2F M=00,01,02,...FF(Hex) ,Value=0 to 255
: O 2E F6
: O 2F M ; M=00,01,02,...FF (See below table)

; IF to disable WDT :
: O 2E 30
: O 2F 00 ; Can be disable at any time

- Program Sample

2E, 87	Enter the extended function mode
2E, 87	Enter the extended function mode
2E, 07	
2F, 08	Logical Device 8
2E, 30	Activate
2F, 01	
2E F5	
2F N	Set Minute or Second N=08 (Min) ,00 (Sec)
2E, F6	
2F, M	Set Value M=00~FF
Q	Quite

Appendix B

Digital I/O

Digital I/O Software Programming

- GPI program sample:

O 2E 87	Un-Lock Super I/O
O 2E 87	Un-Lock Super I/O
O 2E 2A	Select Multiplexed pin to GPIO Function
O 2F FF	
O 2E 07	Select Logic device
O 2F 07	
O 2E 30	Select Logic device (Active or inactive)
O 2F 01	Set 01 (Active), 00 (inactive)
O 2E F0	Select CRF0 (Set the PINs to be GPO or GPI Function)
O 2F FF	Set the PINs to be GPI When set to a '1', respective GPIO port programmed as input port. When set to a '0', respective GPIO port programmed as output port.
O 2E F1	Read Data
I 2F XX	XX is input Data; if no input source, the value is FF
Q	Quit debug

- GPO program sample:

O 2E 87	Un-Lock Super I/O
O 2E 87	Un-Lock Super I/O
O 2E 2A	Select Multiplexed pin to GPIO Function
O 2F FF	
O 2E 07	Select Logic device
O 2F 07	
O 2E 30	Select Logic device (Active or inactive)
O 2F 01	Set 01 (Active), 00 (inactive)
O 2E F0	Select CRF0 (Set the PINs to be GPO or GPI Function)
O 2F 00	Set the PINs to be GPI When set to a '1', respective GPIO port programmed as input port. When set to a '0', respective GPIO port programmed as output port.
O 2E F1	Output Data
I 2F XX	XX=00,01,02,...FF (XX is Output Data)
Q	Quit debug