



Pentium 4 Full-Size CPU Card
With VGA/LCD, 4LANs, 6USB, Micro AGP Bus
PCI/ISA Bus, PICMG Compliant

User's Manual

© Copyright 2002. All Rights Reserved

Manual edition 1.0, May.2002

This document contains proprietary information protected by copyright. All rights are reserved, no part of this manual may be reproduced, copied, translated or transmitted in any form or by any means without prior written permission of the manufacturer.

The content of this manual is intended to be accurate and reliable, the original manufacturer assumes no responsibility for any inaccuracies that may be contained in this manual. The original manufacturer reserves the right to make improvements to the products described in this manual at any time without prior notice.

Trademarks

IBM, EGA, VGA, XT/AT, OS/2 and PS/2 are registered trademarks of International Business Machine Corporation

Intel and Pentium 4 are registered trademarks of Intel Corporation

AMD is a trademark of Advanced Micro Devices, Inc

Award is a trademark of Award Software International, Inc

ATI is a trademark of ATI Technologies Inc

SMI is a trademark of Silicon Motion, Inc

Promise is a trademark of Promise Technology, Inc

Microsoft, Windows, Windows NT and MS-DOS are ether trademarks or registered trademarks of Microsoft Corporation

All other product names mentioned herein are used for identification purpose only and may be trademarks and/or registered trademarks of their respective companies.

Limitation of Liability

While reasonable efforts have been made to ensure the accuracy of this manual, the manufacturer and distributor assume no liability resulting from errors or omissions in this manual, or from the use of the information contained herein.

Table of Contents

Chapter 1. General Information	
1.1 Introduction-----	1
1.2 Specification-----	2
1.3 AW-F701 Package-----	4
1.4 Board Layout-----	5
1.5 Board Dimension-----	5
Chapter 2. Connectors Location and Configuration	
2.1 Connectors Location and Define-----	6
2.2 Jumpers Location and Define-----	7
2.3 Installing CPU-----	8
2.4 Installing System Memory-----	9
2.5 Connector and Jumpers Settings-----	10
2.6 VGA/LCD Controller Optional-----	28
Chapter 3. BIOS Setup-----	34
Chapter 4. Drivers and Utilities Installation-----	56
Appendix A. Programming the Watchdog Timer-----	67
Appendix B. AC-97 Audio Kit Optional-----	69
Appendix C: System Resources-----	72
Appendix D: Order Information-----	73
Appendix E. Optional Cable List-----	73

Chapter 1. General Information

1.1 Introduction

The AW-F701 is fully function of socket 478 Pentium® 4 CPU Card, which is PCI/ISA bus and PICMG compliant. The AW-F701 with Intel® 845G and ICH4 chipset supports Intel® Pentium® 4 processors with 533/400MHz system bus, with two 184-pin DDR DIMM sockets for DDR SDRAM to 2Gbytes. The AW-F701 supports four Ethernet Interface and optional two each of 1000/100/10Mbps and 100/10Mbps Ethernet Interface, six USB 2.0 compliant ports.

Furthermore, the AW-F701 with Promise® PDC20265 or PDC20275/276 series chipset, supports RAID-0 striping or RAID-1 mirroring and dual Ultra ATA/133 master up to four IDE devices.

RAID-0, disk striping offers superior speed because it simultaneously access all drives through concurrent parallel read and writes; however, it does not offer redundancy. RAID-0 is suitable, for example, for temporary synchronized video files.

RAID-1, disk mirroring. Two identical disks operate side-by-side in parallel, providing a complete, continuously updated backup of all data. Should one of the drives fail, the surviving mirrored drive provides read and writes. A replacement controller (with new drive or power supply) can be hot-swapped. Data is backed-up to the new drive and full redundancy resumes. Disk mirroring offers the highest level of “mission critical” redundancy. RAID-1 is suited for moderate-size file servers.

In addition the onboard CRT display, the AW-F701 with a Micro AGP Slot for different VGA Interface through the VGA Adapter which included ATI M6 AGP 4x supports TMDS, dual LVDS, CRT, TV-Out interface or SMI Lynx3DM supports dual LCD, TV-Out function.

1.2 Specification

Specifications

General Functions

CPU	Socket 478 Pentium® 4 processor with 533MHz system bus
BIOS	Award® 4Mbit Flash BIOS
Chipset	Intel 845G + ICH4
I/O Chipset	Winbond® 83627HF-AW
Memory	Onboard two 184-pin DDR DIMM sockets supports up to 2Gbytes
Enhanced IDE	Support up to four IDE devices. Ultra DMA 33/ 66/100
FDD interface	Supports 34-pin header up to two floppy disk drives
Parallel port	One bi-directional parallel port. Supports SPP/ECP/EPP
Serial port	One RS-232 and one RS-232/422/485 serial ports
IR interface	Support one IrDA Tx/Rx header
KB/Mouse connector	6-pin Mini-DIN connector for PC/AT keyboard & PS/2 mouse
USB connectors	Six USB 2.0 compliant ports
Battery	Lithium battery for data retention up to 10years(in normal condition)
Watchdog Timer	Can generate a system reset, support 1-256 second selectable timeout interval
System Monitoring	Built in W83627HF-AW; supports temperatures, Fan speed, and voltages monitoring
Bus interface	PCI/ISA bus, PICMG compliant
Power management	Supports ATX power supply; LAN wake up & modem ring-in functions

VGA Interface through Micro AGP 4x Bus (option)

(1)SMI chipset

Chipset	SMI Lynx3DM
Display memory	Built-in 4MB/8MB for Lynx3DM SMI721
Display type	Simultaneous supports CRT and LCD displays.
Resolution	Flat panel displays support up to 1024 x 768 16M colors and CRT monitors up to 1280x1024 16M colors

TV-Out Interface (option)

TV Format	Support NTSC, NTSC-EIA(Japan) and PAL signals format
Output connector	Support RCA (Composite) video and S-video connector
Resolution	Support 640 x480 and 800 x 600 resolutions

(2)ATI chipset

Chipset	ATI Mobility M6 AGP 4x, supports TMDS, LVDS, CRT, TV-Out Interface
Display memory	16MB DDR Embedded (32MB/64MB Optional)
Display type	Dual Independent displays (LCD/LCD, LCD/CRT, LCD/TV, CRT/TV)

Ethernet Interface

Chipset	Four 82551QM 100Base-Tx Fast Ethernet controller Two Intel® 82551QM and two Intel®82540EM optional
Ethernet interface	PCI 1000/100/10 Mbps Ethernet controller IEEE 802.3U protocol compatible

IDE RAID Interface (Option)

Chipset	Promise® Ultra ATA/133 IDE controller (Optional)
RAID	Support RAID-0 striping or RAID-1 mirroring (Optional)
Interface	Support dual Ultra ATA/133 master up to four IDE devices

Sound Interface (Optional daughter card)

Chipset	AC 97 codec (ADI 1881A)
Audio interface	Mic in, Line in, Speaker out and CD audio in

SSD Interface	One 32-pin DIP socket supports DiskOnChip 2000 up to 288MB
----------------------	--

ISA High Drive	ISA High Driving capability upto 64 mA
-----------------------	--

Mechanical and Environmental

Power supply voltage	VCC (4.75V to 5.25V), +12V(11.4V to 12.6V),-12V (-11.4V to -12.6V)
Max. power requirements	10A @ 5 V, 10A @ +12 V, 60mA @ -12V (Max.)
Operating temperature	32 to 140°F (0 to 60°C)
Weight	13.3"(L) x 4.8"(W) (338mm x 122mm)

User's manual

1.3 AW-F701 Package

Please make sure that the following items have been included in the package before installation.

1. AW-F701 Socket 478 Single Board
2. Quick Installation Guide
3. Cable: Please refer to Appendix C Optional Cables
4. CD-ROM which contains the following folders:
 - (1) Manual
 - (2) LAN Driver
 - (3) Tools
 - (4) Chipset Driver
 - (5) VGA Driver
 - (6) Promise Driver
 - (7) Sound Driver
 - (8) USB 2.0 Driver

If any of these items are missing or damaged, please contact your dealer from whom you purchased the board at once. Save the shipping materials and carton in the event that you want to ship or store the board in the future. After you unpack the board, inspect it to assure an intact shipment. Do not apply power to the board if it appears to have been damaged.

Leave the board in its original packing until you are ready to install
--

Precautions

Please make sure you properly ground yourself before handling the AW-F701 board or other system components. Electrostatic discharge can be easily damage the AW-F701 board.

1. Do not remove the anti-static packing until you are ready to install the AW-F701 board.
2. Ground yourself before removing any system component from its protective anti-static packaging. To ground yourself, grasp the expansion slot covers or other unpainted parts of the computer chassis.
3. Handle the AW-F701 board by its edges and avoid touching its component.

1.4 Board Layout

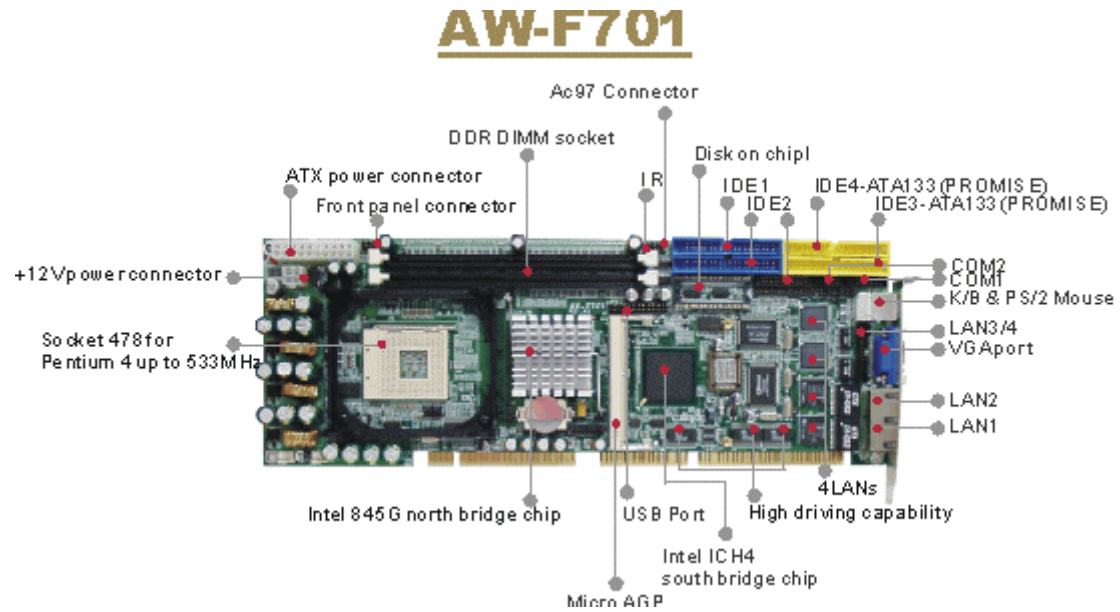

1.5 Board Dimension

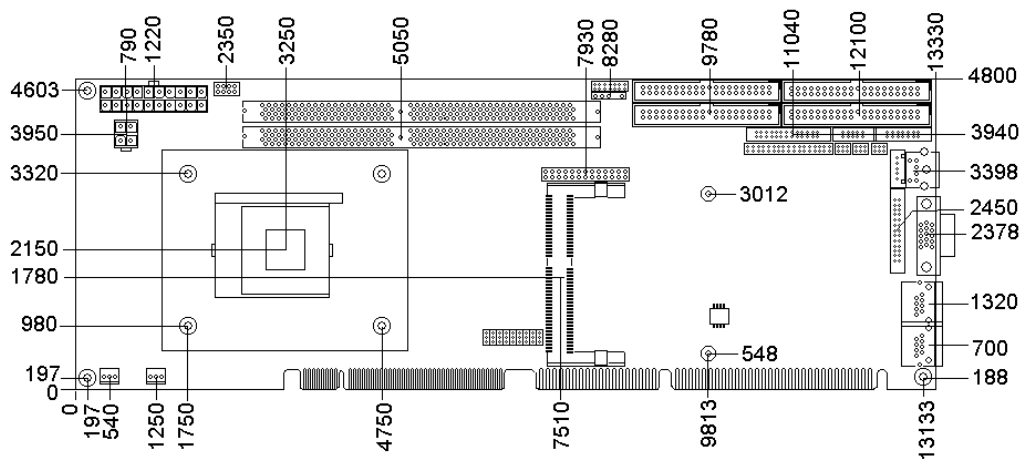

Chapter 2. Connectors Location and Configuration

2.1 Connectors Location and Define

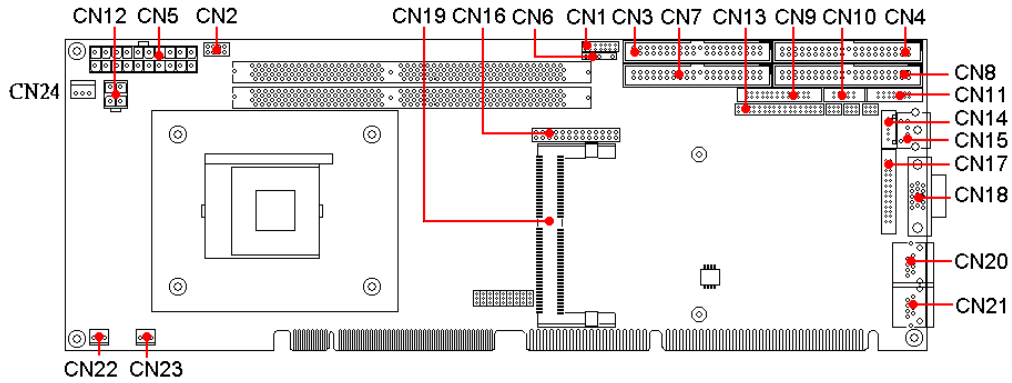

Connector	Define	Connectors	Define
CN1	AC-97 Connector	CN13	Floppy Connector
CN2	Front Panel	CN14	Internal Keyboard Connector
CN3	IDE1	CN15	Keyboard/Mouse Connector
CN4	IDE4 (Promise)	CN16	USB Connector
CN5	ATX Power Connector	CN17	LAN3, LAN4 Connector
CN6	IR	CN18	VGA Connector (D-Sub)
CN7	IDE2	CN19	Micro AGP Bus
CN8	IDE3 (Promise)	CN20	LAN2
CN9	LPT Connector	CN21	LAN1
CN10	COM1 Connector	CN22	FAN
CN11	COM2 Connector	CN23	FAN
CN12	ATX Power 12V	CN24	5VSB Connector (Ver.A2 only)

2.2 Jumpers Location and Define

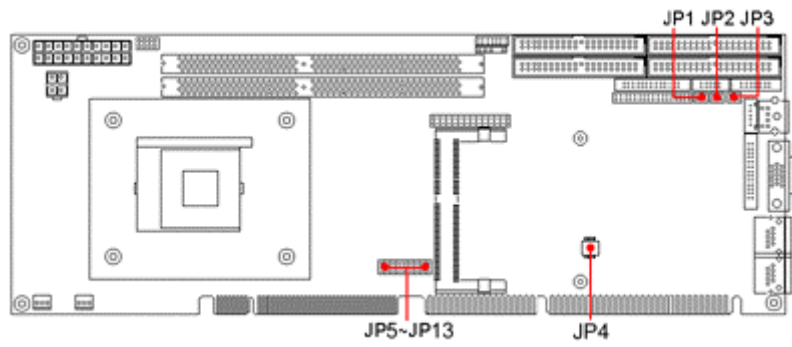

Jumper	Define	Jumper	Define
JP1	COM1 Voltage Select	JP5	CMOS Setting
JP2	COM2 Voltage Select	JP6	CPU Speed Select
JP3	RS232/422/485 Select	JP7 ~ 13	VGA Select
JP4	DOC Address Select		

User's manual

2.3 Installing CPU

The AW-F701 with 478 socket supports Intel® Pentium® 4 processors, up to 533MHz system bus.

The m478PGA form factor is a chip packaging designed for the Intel® Pentium 4 processors up to 533MHz System Bus. On the m478PGA package, the processor's silicon core faced up, and is expose. This allows the core to have direct contact with a heatsink/fan.

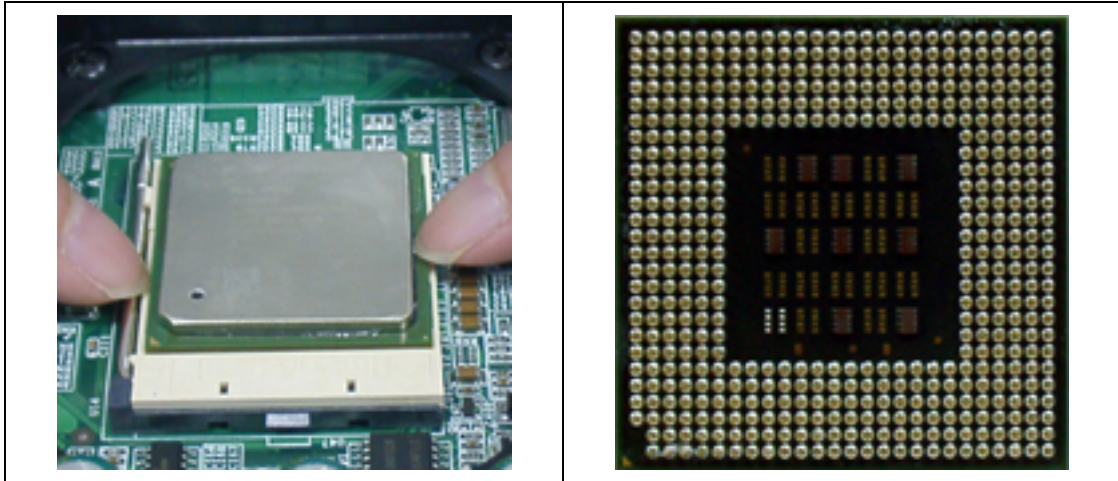

Locating Pin 1 on your CPU and ZIP Socket

All Pentium 4 CPUs use a small golden triangle to indicate the location of pin 1. One the corner to the right of pin 1 is an orange dot.

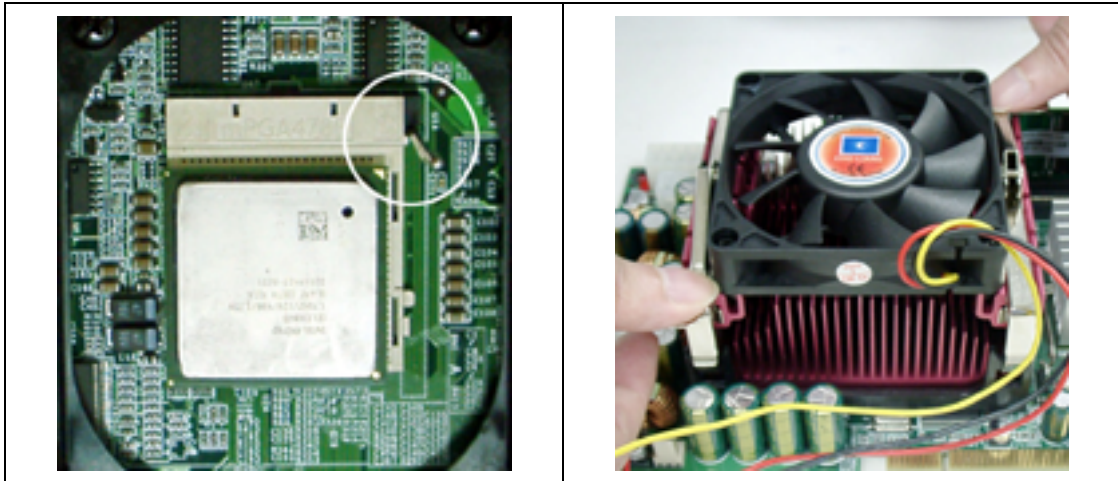

2.4 Installing System Memory

The AW-F701 supports two 184-pin DDR DIMM sockets, memory up to 2Gbytes.

To insert a DDR DIMM Memory: Please align the module with the socket key and press down until the levers at each end of the socket snap close up.

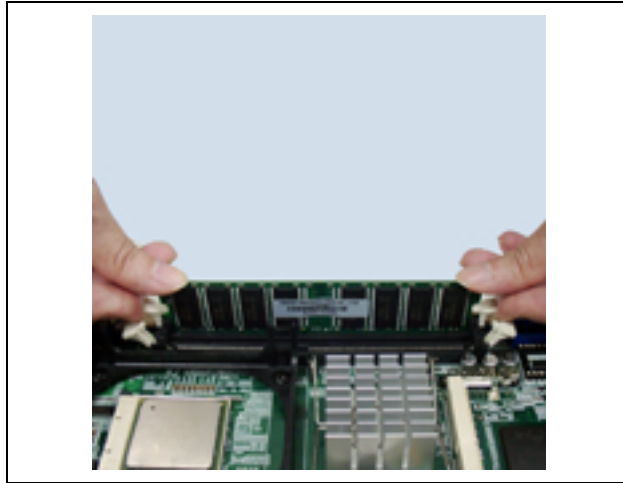

Note: There is only one direction for installing a module in the socket. Do not attempt to force the module into the socket incorrectly.

To remove a DDR DIMM Memory: Press down on the levers at both end of module until the module pops out.

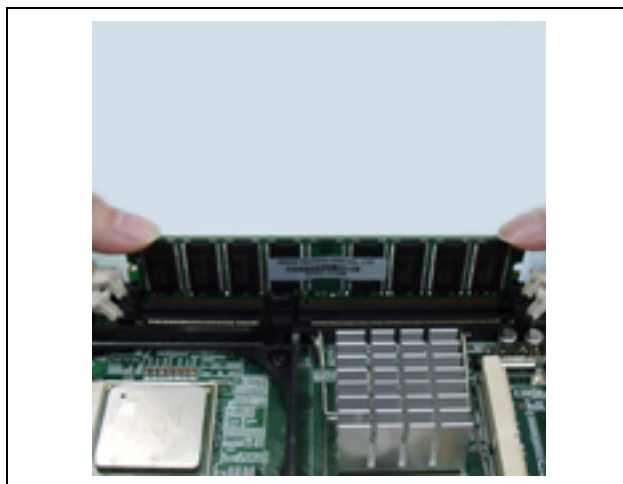

User's manual

2.5 Connector and Jumper Settings

CN1: AC-97 Connector

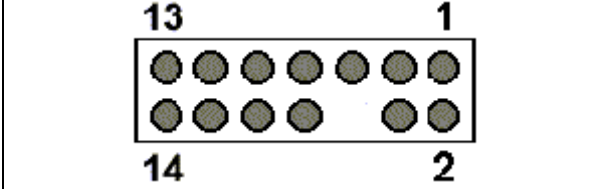

Pin	Define	Pin	Define
1	+12V	2	Ground
3	Ground	4	AC97_BTCLK
5	+3.3V	6	KEY PIN
7	AC97_SDIN0	8	AC97-SYNC
9	Ground	10	AC97-RESET
11	AC97-SDOUT	12	PC-BEEP
13	AC97-SDIN1	14	Ground

CN2: Front Panel Connector

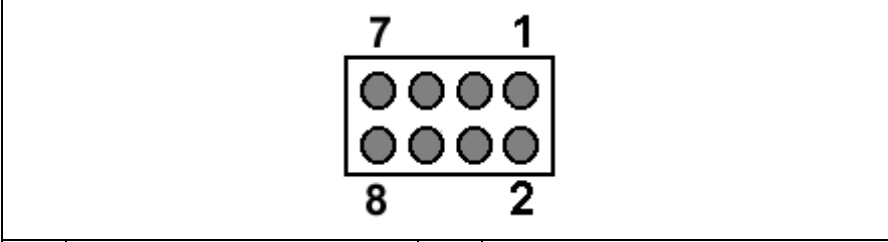

Pin	Define	Pin	Define
1	Power LED+ (+5V)	2	Power LED – (GND)
3	IDE_LED+ (+5V)	4	IDE_LED- (ACTIVE)
5	POWER ON SWITCH+	6	POWER ON SWITCH- (GND)
7	RESET SWITCH+	8	RESET SWITCH- (GND)

Pin 1-2: this 2-pin connector connects to the case-mounted power LED

Pin 3-4: this 2-pin connector connects to the case-mounted HDD LED & indicates hard disk drive activity

Pin 5-6: this 2-pin connector connects to case-mounted ATX power button

Pin 7-8: this 2-pin connector connects to case-mounted Reset Switch, you can use it to reboot the system

CN3: IDE1 Connector

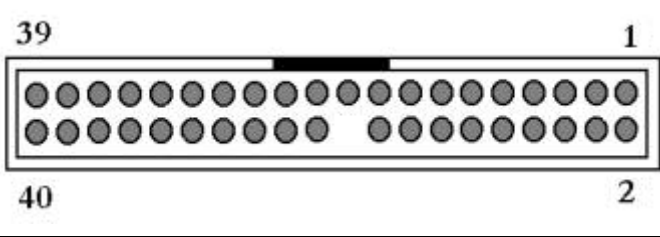

Pin	Define	Pin	Define
1	RESET*	2	Ground
3	DATA7	4	DATA8
5	DATA6	6	DATA9
7	DATA5	8	DATA10
9	DATA4	10	DATA11
11	DATA3	12	DATA12
13	DATA2	14	DATA13
15	DATA1	16	DATA14
17	DATA0	18	DATA15
19	Ground	20	KEY PIN
21	DREQ	22	Ground
23	DIOW*	24	Ground
25	DIOR*	26	Ground
27	IOCHRDY	28	CSEL
29	DACK*	30	Ground
31	IRQ14	32	N/C
33	A1	34	DETECT
35	A0	36	A2
37	HD SELECT 0*	38	HD SELECT 1*
39	ACTIVE*	40	Ground

CN4: IDE4 (Promise) Connector

The AW-F701 supports different options for the IDE ATA133 and IDE RAID-0 or IDE RAID-1 by using Promise PDC20275 or PDC20276 chipset.

User's manual

Pin	Define	Pin	Define
1	SHDRVRST#	2	Ground
3	SSHD7	4	SSHD8
5	SSHD6	6	SSHD9
7	SSHD5	8	SSHD10
9	SSHD4	10	SSHD11
11	SSHD3	12	SSHD12
13	SSHD2	14	SSHD13
15	SSHD1	16	SSHD14
17	SSHD0	18	SSHD15
19	Ground	20	NC
21	SSDRVREQ	22	Ground
23	SSIOW#	24	Ground
25	SSIOR#	26	Ground
27	SSIORDY	28	Ground
29	SSDMACK#	30	Ground
31	SSIDEINT	32	NC
33	SSDA1	34	SPDIAGN
35	SSDA0	36	SSDA2
37	SSDCS0#	38	SSDCS1#
39	SDASP#	40	Ground

CN5: ATX Power Connector

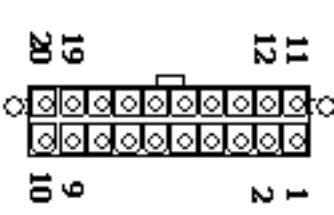

Pin	Define	Pin	Define
11	+3.3V	1	+3.3V
12	-12V	2	+3.3V
13	Ground	3	Ground
14	PS_ON*	4	+5V
15	Ground	5	Ground
16	Ground	6	+5V
17	Ground	7	Ground
18	-5V	8	POWER GOOD
19	+5V	9	5VSB
20	+5V	10	+12V

CN6: IR Connector

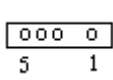

Pin	Define
1	5V
2	NC
3	IRRX
4	Ground
5	IRTX

User's manual

CN7: IDE2 Connector

Pin	Define	Pin	Define
1	PCIRST#0	2	Ground
3	SDD7	4	SDD8
5	SDD6	6	SDD9
7	SDD5	8	SDD10
9	SDD4	10	SDD11
11	SDD3	12	SDD12
13	SDD2	14	SDD13
15	SDD1	16	SDD14
17	SDD0	18	SDD15
19	Ground	20	
21	SDREQ	22	Ground
23	SDIOW#	24	Ground
25	SDIOR#	26	Ground
27	SIORDY	28	DETECT
29	SDDACK#	30	Ground
31	IRQ15	32	NC
33	SDA1	34	DETECT
35	SDA0	36	SDA2
37	SDCS#1	38	SDCS#3
39	IDEACTS#	40	Ground

CN8: IDE3 (Promise) Connector

The AW-F701 supports different options for the IDE ATA133 and IDE RAID-0 or IDE RAID-1 by using Promise PDC20275 or PDC20276 chipset.

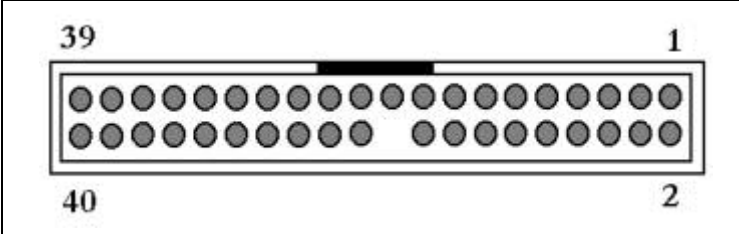

Pin	Define	Pin	Define
1	PHDRVRST#	2	Ground
3	PPHD7	4	PPHD8
5	PPHD6	6	PPHD9
7	PPHD5	8	PPHD10
9	PPHD4	10	PPHD11
11	PPHD3	12	PPHD12
13	PPHD2	14	PPHD13
15	PPHD1	16	PPHD14
17	PPHD0	18	PPHD15
19	Ground	20	
21	PPDRVREQ	22	Ground
23	PPIOW#	24	Ground
25	PPIOR#	26	Ground
27	PPIORDY	28	Ground
29	PPDMACK#	30	Ground
31	PPIDEINT	32	NC
33	PPDA1	34	PPDIAGN
35	PPDA0	36	PPDA2
37	PPDCS#0	38	PPDCS1#
39	PDASP#	40	Ground

User's manual

CN9: LPT Connector

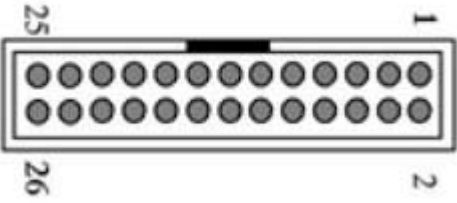

Pin	Define	Pin	Define
1	STROBE	14	AFD#
2	PD0	15	ERR#
3	PD1	16	INIT#
4	PD2	17	SLIN#
5	PD3	18	Ground
6	PD4	19	Ground
7	PD5	20	Ground
8	PD6	21	Ground
9	PD7	22	Ground
10	ACK#	23	Ground
11	BUSY	24	Ground
12	PE	25	Ground
13	SLCT	26	NC

CN10: COM1 Connector

The AW-F701 supports one RS-232 (COM1) and one RS-232/422/485 (COM2) serial ports.

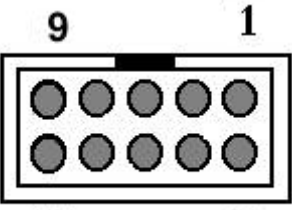

Pin	Define	Pin	Define
1	DCD0	2	DSR0
3	RXDD0	4	RTS0
5	TXDD0	6	CTS0
7	DTR0	8	RI
9	Ground	10	NC

CN11: COM2 Connector

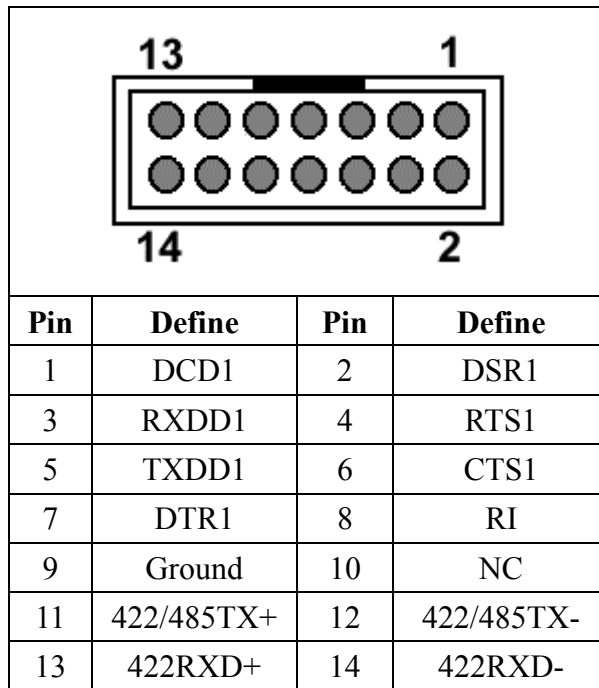

CN12: 12V ATX Power Connector

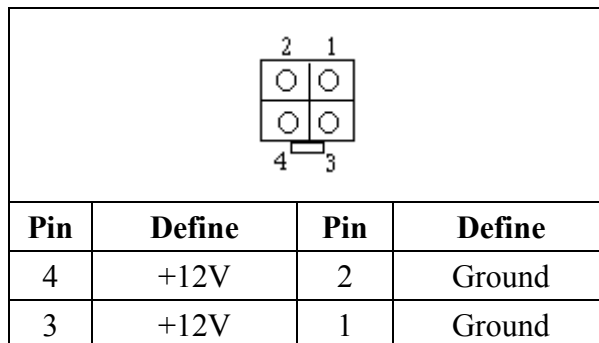

User's manual

CN13: Floppy Connector

Pin	Define	Pin	Define
1	Ground	2	DENSITY SELECT0*
3	Ground	4	NC
5	Ground	6	DENSITY SELECT1*
7	Ground	8	INDEX*
9	Ground	10	MOTOR ENABLE 0*
11	Ground	12	DRIVE SELECT 1*
13	Ground	14	DRIVE SELECT 0*
15	Ground	16	MOTOR ENABLE 1*
17	Ground	18	DIRECTION*
19	Ground	20	STEP*
21	Ground	22	WRITE DATA *
23	Ground	24	WRITE GATE*
25	Ground	26	TRAK00*
27	Ground	28	WRITE PROTECT*
29	Ground	30	READ DATA*
31	Ground	32	SIDE 1 SELECT*
33	Ground	34	DISK CHANGG*

CN14: Internal Keyboard Connector

Pin	Define
1	KB-CLK
2	KB-DATA
3	NC
4	Ground
5	+5V

CN15: Keyboard/Mouse Connector

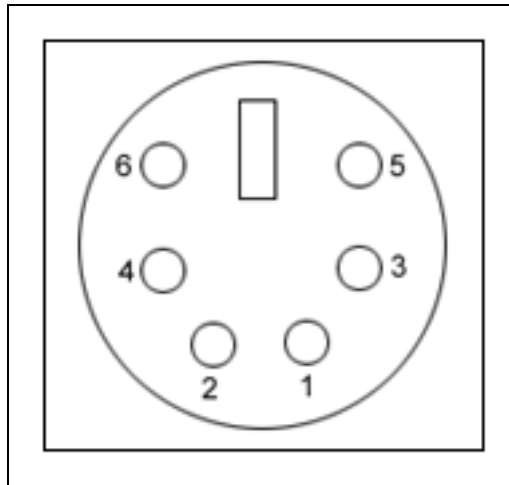

Pin	Define
1	KB-DATA
2	MS-DATA
3	Ground
4	+5V
5	KB-CLK
6	MS-CLK

User's manual

CN16: USB Connector

The AW-F701 supports 6 USB 2.0 compliant ports, which give complete plug and play, hot attach/detach for up to 127 external devices. You need an adapter cable to support six USB connectors. The cable has 26-pin connectors on one end and six USB connectors on the other with bracket.

Please pay attention on the connecting should be connected from pin17 to pin 26 if your package includes two ports of USB bracket.

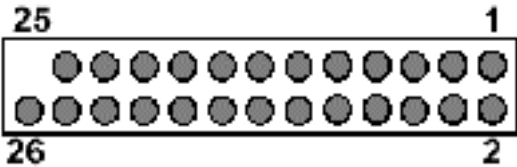
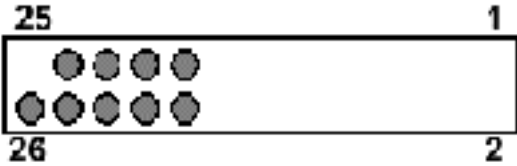
(1) For Six USB Ports Using			
			
(2) For two USB Ports Using			
			
Pin	Define	Pin	Define
1	VCC	2	VCC
3	D0-	4	D1-
5	D0+	6	D1+
7	Ground	8	Ground
9	VCC	10	VCC
11	D2-	12	D3-
13	D2+	14	D3+
15	Ground	16	Ground
17	VCC	18	VCC
19	D4-	20	D5-
21	D4+	22	D5+
23	Ground	24	Ground
25	NC	26	Ground

CN17: LAN3, LAN4 Connector

The AW-F701 supports four Ethernet ports for different options, please refer to the Appendix C for Order Information.

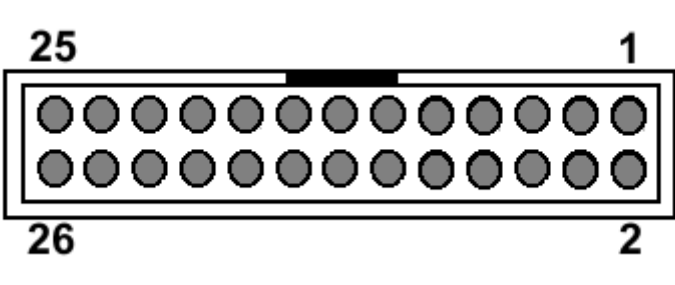

Pin	Define	Pin	Define
1	CTXD3+	2	CTXD3-
3	CRXD3+	4	G3-3
5	G3-1	6	CRXD3-
7	G3-2	8	G3-4
9	ACTLED3	10	LINK3
11	VCC3	12	SPEED3
13	CGND	14	CGND
15	CTXD4+	16	CTXD4-
17	CRXD4+	18	G4-3
19	G4-1	20	CRXD4-
21	G4-2	22	G4-4
23	ACTLED4	24	LINK4
25	VCC3	26	SPEED4

User's manual

CN18: VGA Connector (D-Sub)

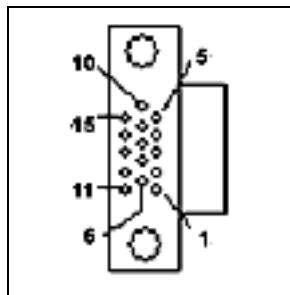

Pin	Define
1	RED
2	GREEN
3	BLUE
4	MONID0
5	Ground
6	Ground
7	Ground
8	Ground
9	+5V
10	Ground
11	MONID1
12	DDC DATA
13	HSYNC
14	VSYNC
15	DDC CLOCK

CN19: Micro AGP Bus

The AW-F701 onboard with a Micro AGP Bus supports 4X AGP 2.0. The Micro AGP Bus is for the optional VGA/LCD

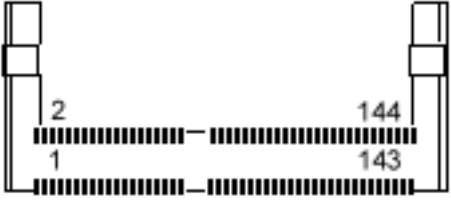

Pin	Define	Pin	Define	Pin	Define	Pin	Define	Pin	Define	Pin	Define
1	+12V	25	+1.5V	49	GDEVESEL-	73	GAD25	97	SBA2	121	Ground
2	+12V	26	+1.5V	50	GTRDY-	74	GAD24	98	SBA3	122	Ground
3	+12V	27	GAD8	51	GIRDY-	75	GAD27	99	+3.3V	123	DDCA_CLK
4	+12V	28	GC/BE0-	52	GFRAME-	76	GAD26	100	+3.3V	124	Reserved
5	Reserved	29	GAD10	53	+1.5V	77	+3.3V	101	SBA0	125	Ground
6	Reserved	30	GAD9	54	+1.5V	78	+3.3V	102	SBA1	126	DDCA_DATA
7	Ground	31	Ground	55	GC/BE2-	79	GAD29	103	Reserved	127	HSYNC
8	Ground	32	Ground	56	GAD16	80	GAD28	104	GWBF-	128	Ground
9	VREF_AGP	33	GAD12	57	GAD17	81	GAD31	105	Ground	129	VSYNC
10	Reserved	34	GAD11	58	GAD18	82	GAD30	106	Ground	130	Blue
11	GAD1	35	GAD14	59	Ground	83	+3.3V	107	GRBF-	131	Ground
12	GAD0	36	GAD13	60	Ground	84	+3.3V	108	GPIPE-	132	Ground
13	+1.5V	37	+1.5V	61	GAD19	85	3.3VSB	109	GST2	133	Green
14	+1.5V	38	+1.5V	62	GAD20	86	Reserved	110	Reserved	134	Red
15	GAD3	39	GC/BE1-	63	GAD21	87	Ground	111	GST0	135	Ground
16	GAD2	40	GAD15	64	GAD22	88	Reserved	112	GST1	136	Ground
17	GAD5	41	GSERR-	65	+1.5V	89	SBA6	113	+3.3V	137	MONID0
18	GAD4	42	GPAR	66	+1.5V	90	SBA7	114	+3.3V	138	MONID1
19	Ground	43	Ground	67	GAD23	91	SBA4	115	REQ-	139	+5V
20	Ground	44	Ground	68	GC/BE3-	92	SBA5	116	GNT-	140	+5V
21	GAD7	45	GPERR-	69	GAD_STB1+	93	Ground	117	GCLK	141	+5V
22	GAD6	46	PCI_PME-	70	GAD_STB1-	94	Ground	118	RST-	142	+5V
23	GAD_STB0+	47	+1.5V	71	Ground	95	SB_STB+	119	INTB-	143	Reserved
24	GAD_STB0-	48	GSTOP-	72	Ground	96	SB_STB-	120	INTA-	144	Reserved

User's manual

CN20, CN21: LAN2/LAN1 Connectors

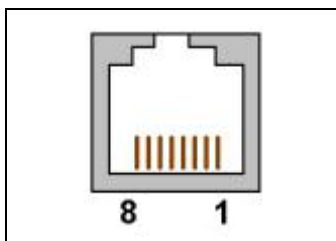

Pin	Define
1	MDI0+
2	MDI0-
3	MDI1+
4	MDI2+
5	MDI2-
6	MDI1-
7	MDI3+
8	MDI3-
9	LINK100_N
10	LINK1000_N
11	LINK_UP_N
12	ACTIVITY_N

LED:

Bi-Color Speed LED	
10 Mbps	Off
100 Mbps	Green
1000 Mbps	Yellow
Link/Activity LED	
Link	Green
Activity	Blink

CN22, CN23: FAN1, FAN2 Connectors

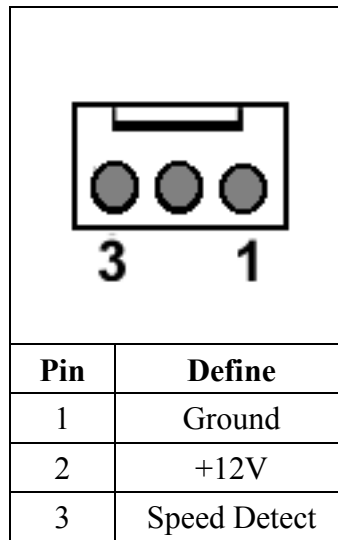

CN24: 5VSB Connector (For PCB Version A2 only)

The AW-F701/F702 Version A2 reserved a 20-pin ATX Power Connector (CN5) and a 3-pin 5VSB connector (CN24). User can choose to use either onboard ATX power or Backplane Card power. When your system using Backplane for power offering, please make sure that you have the 5VSB (P/N: 46-I701X3-00) cable connected to Backplane card. Please pay attention to the backplane pin-out is matched with AW-F701/F702 onboard CN24 when choosing to use CN24 to instead of CN5

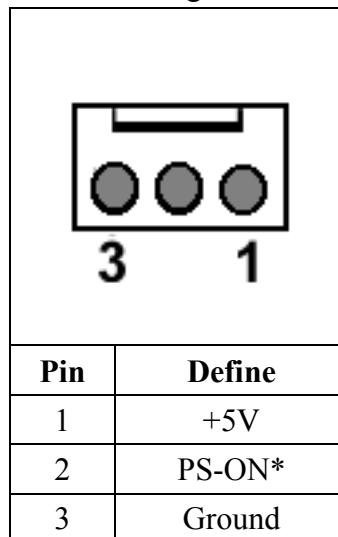

User's manual

JP1: COM1 Voltage Select

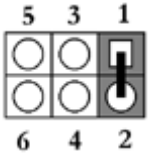
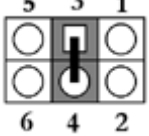
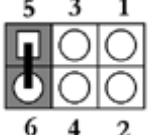
Setting		Define
	1-2	Ring
	3-4	5V
	5-6	12V

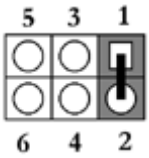
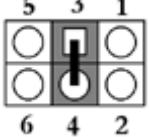
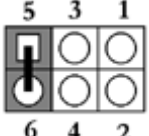

JP2: COM2 Voltage Select

Setting		Define
	1-2	Ring
	3-4	5V
	5-6	12V

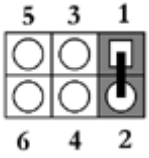
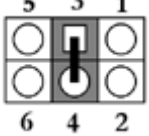
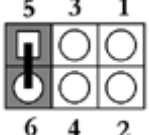
JP3: RS232/422/485 Select

Setting		Define
	1-2	RS-232
	3-4	RS-422
	5-6	RS-485

JP4: DiskOnChip Address Select

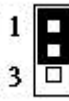
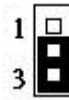

Setting		Define
	1-2	CC000 ~ CFFFF
	3-4	D4000 ~ D7FFF

JP5: CMOS Setting



Setting		Define
	1-2	Normal
	2-3	Clear CMOS

User's manual

JP6: CPU Speed Select

Setting		Define
	1-2	CPU Default Speed
	2-3	Setting CPU 100MHz

JP7 ~ JP13: VGA Select

Setting		Define
	1-2	Onboard VGA
	2-3	Micro AGP VGA Card

2.6 VGA/LCD Controller (Optional)

The AW-F701 is a powerful, compact and full function single board computer that can be used in multitude of embedded applications. The VGA/LCD controller is unnecessary for many network applications but if customers do need VGA/LCD controller supports, there are two powerful VGA/LCD controllers available.

(1) AW-VGA1 SMI Lynx3DM 721 with 8MB VRAM built-in

AW-VGA-1

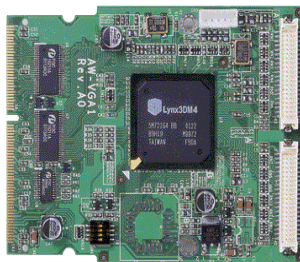

(2) AW-VGA2 ATI M6 with 32MB DDR RAM built-in

AW-VGA-2

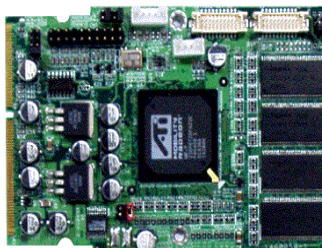

(3) AW-TV-1 for AW-VGA1 & AW-VGA2

AW-TV-1

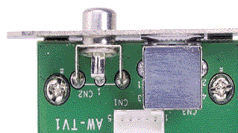

User's manual

AW-VGA1 Pin Define

CN1, CN2: Flat Panel Connector

CN1: DF13A-40DP-1.25V				CN2: DF13A-40DP-1.25V			
Pin	Signal	Pin	Signal	Pin	Signal	Pin	Signal
1	+5V	2	+5V	1	+5V	2	+5V
3	Ground	4	Ground	3	Ground	4	Ground
5	+3.3V	6	+3.3V	5	+3.3V	6	+3.3V
7	NC	8	Ground	7	NC	8	Ground
9	LCD_FD24	10	LCD_FD25	9	LCD_FD0	10	LCD_FD1
11	LCD_FD26	12	LCD_FD27	11	LCD_FD2	12	LCD_FD3
13	LCD_FD28	14	LCD_FD29	13	LCD_FD4	14	LCD_FD5
15	LCD_FD30	16	LCD_FD31	15	LCD_FD6	16	LCD_FD7
17	LCD_FD32	18	LCD_FD33	17	LCD_FD8	18	LCD_FD9
19	LCD_FD34	20	LCD_FD35	19	LCD_FD10	20	LCD_FD11
21	LCD_FD36	22	LCD_FD37	21	LCD_FD12	22	LCD_FD13
23	LCD_FD38	24	LCD_FD39	23	LCD_FD14	24	LCD_FD15
25	LCD_FD40	26	LCD_FD41	25	LCD_FD16	26	LCD_FD17
27	LCD_FD42	28	LCD_FD43	27	LCD_FD18	28	LCD_FD19
29	LCD_FD44	30	LCD_FD45	29	LCD_FD20	30	LCD_FD21
31	LCD_FD46	32	LCD_FD47	31	LCD_FD22	32	LCD_FD23
33	Ground	34	Ground	33	Ground	34	Ground
35	SHFCLK2	36	LCD_FD23	35	LCD_FPSCCLK	36	FLM/VSYNC
37	LCD_FD15	38	LCD_FD22	37	DE	38	LP/HSYNC
39	ENABKL	40	ENVBIAS	39	ENABKL	40	ENVBIAS

CN2: TV-Out Connector

The AW-F701 AW-VGA1 with TV-Out interface optional, supports NTSC, NTSC-EIA(for Japan System) and PAL signals. The NTSC format's resolution is 640x480 and PAL format's resolution is 800x600 and above.

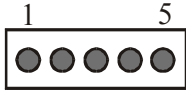
	
Pin	Assignment
1	LUMINANCE OUT
2	CHROMIANCE OUT
3	Ground
4	Ground
5	COMPOSITE OUT

AW-VGA2 Pin Define

Jumper	Define	Connector	Define
JP1	LVDS Panel ID Detection	CN1	LVDS-0
JP4	Panel Voltage Select	CN2	LVDS-1
JP5	Control Backlight On/Off Voltage Select	CN3	LVDS Power Connector
		CN4	TV-Out Connector
		CN5	DVI

JP1: LVDS Panel ID Detection

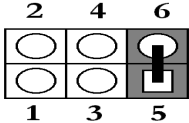
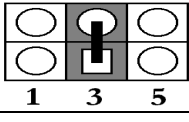
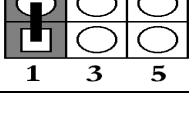
1-2	3-4	5-6	Setting	Resolution
0	0	1		1280 x 1024 18bit
0	1	0		1024 x 768 18bit
1	0	0		800 x 600 18bit

Note: 1 = Hi (Jumper close)

0 = Lo (Jumper open)

User's manual

JP4: Panel Voltage Select

Panel VDD	Jumper
3.3V	1-2, 7-8 close
5V	3-4, 5-6 close

JP5: Control Backlight On/Off Voltage Select

Voltage	Jumper
-12V	1-2
-5V	3-4
+12V	5-6
+5V	7-8

CN1: LVDS-0

Pin	Define	Pin	Define
1	LVDS lower data channel 0 (+)	2	LVDS lower data channel 1 (+)
3	LVDS lower data channel 0 (-)	4	LVDS lower data channel 1 (+)
5	Ground	6	Ground
7	LVDS lower data channel 2 (+)	8	LVDS lower data channel 3 (+)
9	LVDS lower data channel 2 (+)	10	LVDS lower data channel 3 (+)
11	Ground	12	Ground
13	LVDS lower clock channel (+)	14	Panel VDD
15	LVDS lower clock channel (+)	16	Panel VDD
17	Ground	18	BL_CTRL
19	+12V	20	+12V

CN2: LVDS-1

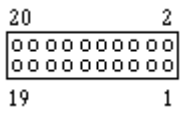
			
Pin	Define	Pin	Define
1	LVDS Upper data channel 0 (+)	2	LVDS Upper data channel 1 (+)
3	LVDS Upper data channel 0 (-)	4	LVDS Upper data channel 1 (+)
5	Ground	6	Ground
7	LVDS Upper data channel 2 (+)	8	LVDS Upper data channel 3 (+)
9	LVDS Upper data channel 2 (+)	10	LVDS Upper data channel 3 (+)
11	Ground	12	Ground
13	LVDS Upper clock channel (+)	14	Panel VDD
15	LVDS Upper clock channel (+)	16	Panel VDD
17	Ground	18	NC
19	+12V	20	+12V

CN3: LVDS Power Connector

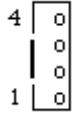
	
Pin	Define
1	+12V
2	Ground
3	Panel VDD
4	Control Backlight On/Off

CN4: TV-Out

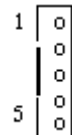
	
Pin	Define
1	LUMINANCE OUT
2	CHROMIANCE OUT
3	Ground
4	Ground
5	COMPOSITE OUT

User's manual

CN5: TMDS

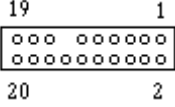
			
Pin	Define	Pin	Define
1	DVI-DDCCLK	2	+3.3V
3	DVI-DDCDATA	4	+3.3V
5	PANEL DETECTION	6	+5V
7	+3.3V	8	Ground
9	DVI data channel 0 (-)	10	DVI clock channel (-)
11	DVI data channel 0 (+)	12	DVI clock channel (+)
13	NC	14	Ground
15	DVI data channel 2 (-)	16	DVI data channel 1 (-)
17	DVI data channel 2 (+)	18	DVI data channel 1 (+)
19	Ground	20	Ground

Chapter 3. BIOS Setup

The ROM chip of your AW-F701 board is configured with a customized Basic Input/Output System (BIOS) from Phoenix-Award BIOS. The BIOS is a set of permanently recorded program routines that give the system its fundamental operational characteristics. It also tests the computer and determines how the computer reacts to instructions that are part of programs.

The BIOS is made up of code and programs that provide the device-level control for the major I/O devices in the system. It contains a set of routines (called POST, for Power-On Self Test) that check out the system when you turn it on. The BIOS also includes CMOS Setup program, so no disk-based setup program is required CMOS RAM stores information for:

- Date and time
- Memory capacity of the main board
- Type of display adapter installed
- Number and type of disk drives

The CMOS memory is maintained by battery installed on the AW-F701 board. By using the battery, all memory in CMOS can be retained when the system power switch is turned off. The system BIOS also supports easy way to reload the CMOS data when you replace the battery of the battery power lose.

3.1 Quick Setup

In most cases, you can quickly configure the system by choosing the following main menu options:

1. Choose "Load Optimized Defaults" from the main menu. This loads the setup default values from the BIOS Features Setup and Chipset Features Setup screens.
2. Choose "Standard COS Features" from the main menu. This option lets you configure the date and time, hard disk type, floppy disk drive type, primary display and more.
3. In the main menu, press F10 ("Save & Exit Setup") to save your changes and reboot the system.

3.2 Entering the CMOS Setup Program

Use the CMOS Setup program to modify the system parameters to reflect the options installed in your system and to customized your system. For example, you should run the Setup program after you:

- Received an error code at startup
- Install another disk drive
- Use your system after not having used it for a long time
- Find the original setup missing
- Replace the battery
- Change to a different type of CPU
- Run the Phoenix-Award Flash program to update the system BIOS

Run the CMOS Setup program after you turn on the system. On-screen instructions explain how to use the program.

↓ Enter the CMOS Setup program's main menu as follows:

1. Turn on or reboot the system. After the BIOS performs a series of diagnostic checks, the following message appears:
"Press DEL to enter SETUP"
2. Press the key to enter CMOS Setup program. The main menu appears:

Phoenix - AwardBIOS CMOS Setup Utility

<ul style="list-style-type: none"> ▶ Standard CMOS Features ▶ Advanced BIOS Features ▶ Advanced Chipset Features ▶ Integrated Peripherals ▶ Power Management Setup ▶ PnP/PCI Configuration ▶ PC Health Status 	<ul style="list-style-type: none"> Frequency/Voltage Control Load Fail-Safe Defaults Load Optimized Defaults Set Supervisor Password Save User Password Exit Without Saving
↑↓→← : Select Item F10: Save & Exit Setup	
Time, Date, Hard Disk Type....	

3. Choose a setup option with the arrow keys and press <Enter>. See the following sections for a brief description of each setup option.

In the main menu, press F10 ("Save & Exit Setup) to save your changes and reboot the system. Choosing "EXIT WITHOUT SAVING" ignores your changes and exits the program. Pressing <ESC> anywhere in the program returns you to the main menu.

3.3 Menu Options

The main menu options of the CMOS Setup program are described in the following and the following sections of this chapter.

User's manual

STANDARD CMOS FEATURES:

Configure the date & time, hard disk drive type, floppy disk drive type, primary display type and more

ADVANCED BIOS FEATURES:

Configure advanced system options such as enabling/disabling cache memory and shadow RAM

ADVANCED CHIPSET FEATURES:

Configure advanced chipset register options such DRAM timing

INTEGRATED PERIPHERALS:

Configure onboard I/O functions

POWER MANAGEMENT SETUP:

Configure power management features such as timer selects

PNP/PCI CONFIGURATION:

Configure Plug & Play IRQ assignments and PCI slots

PC HEALTH STATUS:

Configure the CPU speed and, if the optional Winbond W83627HF system monitor IC is installed, view system information

FREQUENCY/VOLTAGE CONTROL

Change CPU Clock

LOAD FAIL-SAFE DEFAULT:

Loads BIOS default values. Use this option as diagnostic aid if your system behaves erratically

LOAD OPTIMIZED DEFAULTS:

Loads optimized BIOS settings

SET SUPERVISORS & USER PASSWORD:

Configure the system so that a password is required when the system boots or you attempt to enter the CMOS setup program. When you log in with this password, you

will be able to enter the COS Setup main menu, but you can not enter other menus in the CMOS Setup program.

SAVE & EXIT SETUP:

Save changes of values to CMOS and exit the CMOS setup program

EXIT WITHOUT SAVING:

Abandon all CMOS changes and exit the CMOS setup program

Standard CMOS Features Setup

↓ Use the Standard CMOS Setup option as follows:

1. Choose "Standard CMOS Features" from the main menu. The following screen appears:

Phoenix - Award BIOS CMOS Setup Utility		Item Help
Standard CMOS Features		
Date (mm:dd:yy)	Mon, Jan 21 2002	Menu Level ▶ Change the day, month, Year and Century
Time (hh:mm:ss)	10 : 40 : 23	
▶ IDE Primary Master	<NONE>	
▶ IDE Primary Slave	<NONE>	
▶ IDE Secondary Master	<NONE>	
▶ IDE Secondary Slave	<NONE>	
Drive A	<1.44M, 3.5 in.>	
Drive B	<None>	
Video	<EGA/VGA>	
Halt On	<All Errors>	
Base Memory	640K	
Extend Memory	261120K	
Total Memory	262144K	
↑↓→← Move Enter:Select +/-/PU/PD:Value F10:Save ESC:Exit F1:General Help F5:Previous Value F6:Fail-Safe Default F7:Optimized Defaults		

2. Use the arrow keys to move between fields. Modify the selected field using the PgUP/PgDN/+/- keys. Some fields let you enter numeric values directly.

Option	Description
Date (mm:dd:yy)	Type the current date
Time (hour:min:sec)	Type the current time (24-hour clock)
Hard Disks	Choose from "Auto", "User", or "None" If your drive is not one of the predefined types, choose "User" and enter the following drive specifications:

User's manual

	<p>Cylinders, heads, Wpcom, L-Zone, sectors, and mode</p> <p>Consult the documentation received with the drive for the values that will give you optimum performance.</p>
<p>Drive A</p> <p>Drive B</p>	<p>Choose: None</p> <p>360K, 5.25 in</p> <p>1.2M, 5.25 in</p> <p>720K, 3.5 in</p> <p>1.44M, 3.5"</p> <p>2.88M, 3.5"</p>
Video	<p>Choose: EGA/VGA</p> <p>CGA 40</p> <p>CGA 80</p> <p>Mono</p>
Halt On	<p>Controls whether the system stops in case of an error detected during power up.</p> <p>Choose: All Errors (Default)</p> <p>No Errors</p> <p>All, But Keyboard</p> <p>All, But Diskette</p> <p>All, But Disk/Key</p>

- After you have finished with the Standard CMOS Features program, press the <ESC> key to return to the main menu.

Advanced BIOS Features Setup

↓ Use the Advanced BIOS Features Setup option as follows:

1. Choose “Advanced BIOS Features Setup” from the main menu. The following screen appears:

Phoenix - Award BIOS CMOS Setup Utility
Advanced BIOS Features

Virus Warning <Disabled> First Boot Device <Floppy> Second Boot Device <HDD-0> Third Boot Device <LS120> Swap Floppy Device <Disabled> Boot up Floppy Seek <Enabled> Boot Up NumLock Status <On> Gate A20 Option <Fast> Typematic Rate Setting <Disabled> Typematic Rate (Chars/Sec) <6> Typematic Delay (Msec) <250> Security Option <Setup> OS Select For DRAM > 64MB <Non-OS2>	<table border="1" style="width: 100%; border-collapse: collapse;"> <tr> <th style="text-align: center;">Item Help</th> </tr> <tr> <td> Menu Level ▶ Allows you to choose the VIRUS warning feature for IDE Hard Disk boot sector protection. If this function is enabled and someone attempt to write data into this area, BIOS will show a waring message on screen and alarm beep </td> </tr> </table>	Item Help	Menu Level ▶ Allows you to choose the VIRUS warning feature for IDE Hard Disk boot sector protection. If this function is enabled and someone attempt to write data into this area, BIOS will show a waring message on screen and alarm beep
Item Help			
Menu Level ▶ Allows you to choose the VIRUS warning feature for IDE Hard Disk boot sector protection. If this function is enabled and someone attempt to write data into this area, BIOS will show a waring message on screen and alarm beep			
↑↓→← Move Enter:Select +/-/PU/PD:Value F10:Save ESC: Exit F1: General Help F5:Previous Value F6:Fail-Safe Default F7:Optimized Defaults			

2. Use the arrow keys to move between items and to select values. Modify the selected fields using the PgUP/PgDN keys. Press the <F1> “Help” key for information on the available options:

Option	Description
Virus Warning	When enabled, any attempt to write to the boot sector and partition table will halt the system and cause a warning message to appear. If this happens, you can use an anti-virus utility on a virus-free, bootable floppy disk to reboot and clean your system. The default setting is Disabled .
First/Second/Third Boot Device	The BIOS attempts to load the operating system from the devices in the sequence selected in these items. Choose: Floppy, LS-120, HDH-0, 1, 2, 3, SCSI, CDROM, ZIP100, USB-FDD, USB-ZIP, USB-CDROM, USB-HDD, LAN, Disabled
Boot Up NumLock Status	Choose On or Off. On puts the numeric keypad in

User's manual

	Num Lock mode at boot-up. Off puts the numeric keypad in arrow key mode at boot-up
Gate A20 Option	Choose Enabled or Disabled. Enable this option to allow RAM accesses faster than normal, and is useful in networking operating systems.
Typematic Rate Setting	Choose Enabled or Disabled. Enable this option to adjust the keystroke repeat rate. Adjust the rate via Typematic Rate Delay and Typematic Rate
Typematic Rate (Chars/Sec)	Choose the rate at which character keeps repeating
Typematic Delay (Msec)	Choose the delay between holding down a key and when the character begins repeating
Security Option	<p>Choose Setup or System. This lets you specify whether a password is required every time the system boots or only when an attempt is made to enter the CMOS Setup program.</p> <p>“Setup” – The password prompt only appears if you attempt to enter the CMOS setup program.</p> <p>“System” – The password prompt appears each time the system is booted.</p> <p><i>Note: The password function is disabled by default. For a description of enabling the password function, refer to the section: Supervisor Password & User Password later in this chapter.</i></p>
OS Select for DRAM > 64MB	Set to OS/2 if your system is using OS/2 and has a memory size of more than 64MB

Advanced Chipset Features Setup

↓ Use the Advanced Chipset Features Setup option as follows:

1. Choose “Advanced Chipset Features Setup” from the main menu. The following screen appears:

Phoenix - Award BIOS CMOS Setup Utility		Item Help
Advanced Chipset Features		Menu Level ▶
DRAM Timing Selectable	<By SPD>	
Memory Frequency For	<Auto>	
System BIOS Cacheable	<Enabled>	
Video BIOS Cacheable	<Enabled>	
Memory Hole At 15M-16M	<Disabled>	
Delayed Transaction	<Enabled>	
AGP Aperture Size (MB)	<64>	
** On-Chip VGA Setting **		
On-Chip VGA	<Enabled>	
On-Chip Frame Buffer Size	<8MB>	
↑↓→← Move Enter:Select +/-/PU/PD:Value F10:Save ESC: Exit F1: General Help F5:Previous Value F6:Fail-Safe Default F7:Optimized Defaults		

2. Move between items and select values by using the arrow keys. Modify the selected fields using the PnUP/PgDN keys. For information on the various options, press <F1> key.

Option	Description
DRAM Timing Selectable	This item lets you to select the values this field, depending on whether the board has paged DRAMs or EDO. Choose: SPD, Manual
Memory Frequency For	Auto: by hardware PC100/133: 100MHz/133MHz
System BIOS Cacheable	Choose Enabled or Disabled. When enabled, caching of the system BIOS at F0000h-FFFFFh, enhancing system performance. However, if any program writes to this memory area, a system error may result.
Video BIOS Cacheable	Choose Enabled/Disabled. When enable, caching of the video RAM at C0000h-F7FFFh is allowed,

User's manual

	enhancing system performance. However, if any program writes to this memory area, a system error may occur.
Memory Hole At 15M-16M	Choose Enabled or Disabled. You can reserve this area of system memory for ISA adapter ROM. When this area is reserved, it can not be cached. The user information of peripherals that need to use this area of system memory usually discusses their memory requirement.
Delayed Transaction	Choose Enabled/Disabled if you have an ISA card compatibility problem, when enabled, this option lets you control the Delay Transaction function of the chipset. This function is used to meet the latency of the PCI cycles to or from the ISA bus.
AGP Aperture Size (MB)	Select the size of AGP aperture. The aperture is a portion of the PCI memory address range dedicated for graphics memory address space. Host cycle that hit the aperture range are forwarded to the AGP without any translation. 64MB
On-Chip VGA Setting	On-Chip VGA: Enabled / Disabled On-Chip Frame Buffer Size: 8MB/4MB

Integrated Peripherals

↓ Use the Integrated Peripherals Setup option as follows:

1. Choose "Integrated Peripherals Setup" from the main menu. The following screen appears:

```
Phoenix - Award BIOS CMOS Setup Utility
Integrated Peripherals
```

<pre>On-Chip Primary PCI IDE <Enabled> IDE Primary Master PIO <Auto> IDE Primary Slave PIO <Auto> IDE Primary Master UDMA <Auto> IDE Primary Slave UDMA <Auto> On-Chip Secondary PCI IDE <Enabled> IDE Secondary Master PIO <Auto> IDE Secondary Slave PIO <Auto> IDE Secondary Master UDMA <Auto> USB Controller <Enabled> USB Keyboard Support <Disabled> AC97 Audio <Auto> Init Display First <Onboard/AGP> BIOS Lock Control <Enabled> IDE HDD Block Mode <Enabled> Onboard FDC Controller <Enabled> Onboard Serial Port 1 <3F8/IRQ4> Onboard Serial Port 2 <2F8/IRQ3> UART Mode Select <Normal> Onboard Parallel Port <378/IRQ7> Parallel Port Mode <SPP> PWRON After PWR-Fail <Off> Game Port Address <201> Midi Port Address <300> Midi Port IRQ <10> Watch Dog Timer Select <Disabled></pre>	<p style="text-align: center;">Item Help</p> <hr/> <p>Menu Level ▶</p>
<p>↑↓→← Move Enter:Select +/-/PU/PD:Value F10:Save ESC: Exit F1: General Help F5:Previous Value F6:Fail-Safe Default F7:Optimized Defaults</p>	

2. Move between items and select values by using the arrow keys. Modify the selected fields using the PgUP/PgDN keys. Please press the <F1> key for information on the various options.

Option	Description
On-Chip Primary/Secondary PCI IDE	Enables/Disables. Select Enabled to activate the primary IDE interface. Select Disabled to deactivate this interface
IDE Primary/Secondary Master/Slave PIO	Auto/Mode0/Mode1/Mode2/Mode3/Mode4 The four IDE PIO (Programmed Input/Output) fields let you set a PIO mode (0-4) for each of the four IDE

User's manual

	<p>devices that the onboard IDE interface supports. Modes 0 through 4 provide successively increased performance. In Auto mode, the system automatically determines the best mode for each device.</p>
IDE Primary/Secondary Master/Slave UDMA	<p>Auto, Mode0, Mode1, Mode2, Mode3, Mode4</p> <p>UltraDMA33/66/100 implementation is possible only if your IDE hard drive supports it and the operating environment includes a DMA driver. If your hard drive and your system software both support UltraDMA33/66/100, select Auto to enable BIOS support.</p>
USB Controller	<p>Enabled/Disable. This option should be enabled if your system has a USB installed on the system board and you want to use it.</p>
USB Keyboard Support	<p>Enabled/Disabled USB keyboard support</p>
Init Display First	<p>Default: Onboard/AGP</p> <p>This option lets you choose the priority of AGP & PCI VGA card</p>
AC-97 Audio	<p>Choose Auto/Disabled</p>
BIOS Lock Control	<p>Choose Lock/Unlock</p>
IDE HDD Block Mode	<p>Enabled/Disabled the IDE HDD Block Mode function.</p> <p><i>Note: Not all drives support this function</i></p>
Onboard FDC Controller	<p>Enabled/Disabled. Select enabled if your system has a floppy disk controller installed on the system board and you wish to use it. If the system has no floppy drive, select Disabled in this field.</p>
Onboard Serial Port1/2	<p>Choose: 3F8/IRQ4, 2F8/IRQ3</p> <p>Select an address and corresponding interrupt for the first and second serial ports.</p>
UART Mode Select	<p>Default Setting: Normal</p> <p>This option lets you to select which mode for the onboard Serial Port 2</p>
Onboard Parallel Port	<p>Choose: 378/IRQ7</p> <p>This option lets you to determine onboard parallel port controller I/O address setting.</p>
Parallel Port Mode	<p>Default Setting: SPP</p> <p>Select an operating mode for the onboard parallel port.</p>
PWRON After PWR-Fail	<p>This setting specifies whether your system will reboot</p>

	<p>after a power failure occurs. The available settings:</p> <p>OFF: Leaves the computer in the power off state and need to push the power button to turn on the power supply.</p> <p>ON: Reboots the computer</p> <p>Former-STS: Restores the system to the status before power failure occurs.</p>
Game Port Address	<p>Choose: 201</p> <p>This option lets you to determine onboard game port address setting</p>
Midi Port Address/IRQ	<p>Choose: 300/IRQ10</p> <p>This option lets you to determine onboard Midi port address and IRQ setting</p>
Watchdog Timer Select	<p>To select Watchdog Timer wait state time: 10/20/30/40 sec./1/2/4 min./Disabled</p>

User's manual

Power Management Setup

The Power Management Setup controls the board's "green" features. To save energy these features shut down the video display and hard disk drive.

↓ Use the Power Management Setup option as follows:

1. Choose "Power Management Setup" from the main menu. The following screen appears.

Phoenix - Award BIOS CMOS Setup Utility		Item Help
Power Management Setup		Menu Level ▶
ACPI Function	<Enabled>	
ACPI Suspend Type	<S1 (POS)>	
Power Management	<User Define>	
Video Off Method	<DPMS>	
Video Off In Suspend	<Yes>	
Suspend Type	<Stop Grant>	
MODEM Use IRQ	<NA>	
Suspend Mode	<Disabled>	
HDD Power Down	<Disabled>	
Soft-Off by PWR-BTW	<Instant-Off>	
CPU Thermal-Throttling	<50.0%>	
Power On By Ring	<Enabled>	
Wake Up On LAN	<Enabled>	
Resume by Alarm	<Disabled>	
**Reload Global Timer Events **		
Primary IDE 0	<Disabled>	
Primary IDE 1	<Disabled>	
Secondary IDE 0	<Disabled>	
Secondary IDE 1	<Disabled>	
FDD, COM, LPT Port	<Disabled>	
PCI PIRQ (A-D) #	<Disabled>	
↑↓→← Move Enter:Select +/-/PU/PD:Value F10:Save ESC: Exit F1: General Help F5:Previous Value F6:Fail-Safe Default F7:Optimized Defaults		

2. Move between items and select values by using the arrow keys. Modify the selected field the PgUP/PgDN keys. For information on the various options, press <F1> key.

Option	Description
ACPI Function	Enables/Disables the ACPI function
ACPI Suspend Type	Choose SI (POS) / S3 (STR) / S1 & S3
Power Management	Choose Disable, User Define, Min Saving or Max. Saving. "User Define" – Lets you specify when the HDD and system will shut down "Min Saving" - Predefine timer value of 4-12 min. "Max Saving" – Predefine timer value of 1 minute

Video Off Method	Choose V/H SYNC+Blank, DPMS, Blank Screen When power management blanks the screen and turns off vertical and horizontal scanning. The DPMS (Display Power Management System) setting allows the BIOS to control the video card if it has the DPMS features. If you don't have a Green monitor, use the Blank Screen option
Video Off In Suspend	Choose the video off condition: NA/Suspend/Doze
Suspend Type	Choose stop Grand / PwrOn Suspend
MODEM Use IRQ	Choose the IRQ used by the modem. Default: Disabled
Suspend Mode	Sets the time for Suspend mode or disables it
HDD Power Down	Sets the time for the HDD power down mode or disables it
Soft-Off by PWR-BTW	Default: Instant-Off Press the power button for more than 4 seconds forces the system to enter the Soft-Off state when the system has "hung"
CPU Thermal-Throttling	Choose 12.5%, 25%, 37.5%, 50%, 62.5%, 75%, 87.5%
Power On by Ring	Enabled/Disabled. When enabled, the system will power up automatically when modem ring.
Wake Up On LAN	Enabled/Disabled. Wake Up On LAN function
Resume by Alarm	Enables/Disables. When Enabled, you can set the date and time at which the RTC (real-time clock) alarm awakens the system from Suspend mode. The following is a list of IRQ's, interrupt ReQuests, which can be exempted much as the COM ports and LPT ports above can. When an I/O device wants to gain the attention of the operating system, it signals this by causing an IRQ to occur. When the operating system is ready to respond to the request, it interrupts itself and performs the service.
Reload Global Timer Events	Choose Enable or Disable Primary IDE 0 <Disabled> Primary IDE 1 <Disabled> Secondary IDE 0 <Disabled> Secondary IDE 1 <Disabled>

User's manual

	FDD, COM, LPT Port	<Disabled>
	PCI PIRQ <A-D>	<Disabled>

- After you have finished with the Power Management Setup, press the <ESC> key to return to the main menu.

PNP/PCI Configuration

This option is used to configure Plug and Play assignments and route PCI interrupts to designated ISA interrupts.

↓ Use the PNP/PCI Configuration Setup option as follows:

- Choose “PNP/PCI Configuration Setup” from the main menu, the following screen appears.

Phoenix - Award BIOS CMOS Setup Utility
PNP/PCI Configuration

Reset Configuration Data	<Disabled>	Item Help
Resources Controlled by	<Auto (ESCD) >	Menu Level ▶ Default is Disabled. Select Enabled to reset Extended System Configuration Data (ESCD) when you exit Setup if you have installed a new add-on and the system reconfiguration has caused such a serious conflict that the OS cannot boot
IRQ Resources	Press Enter	
DMA Resources	Press Enter	
PCI/VGA Palette Snoop	<Disabled>	
Assign IRQ For VGA	<Enabled>	
Assign IRQ for USB	<Enabled>	
↑↓→← Move Enter:Select +/-/PU/PD:Value F10:Save ESC:Exit F1:General Help F5:Previous Value F6:Fail-Safe Default F7:Optimized Defaults		

- Move between items and select values by using the arrow keys. Modify the selected fields using the PgUP/PgDN keys. For information on the various options, please press <F1> key.

Option	Description
Reset Configuration Data	Choose Enable or Disable “Enable” – PNP configuration data is reset in BIOS “Disable” – PNP configuration date is retained in BIOS
Resources Controlled By	Choose Auto or Manual. This option specifies

	whether resources are controlled by automatic or manual configuration
IRQ Resources	IRQ-3 Assigned to <PCI Device> IRQ-4 Assigned to <PCI Device> IRQ-5 Assigned to <PCI Device> IRQ-7 Assigned to <PCI Device> IRQ-9 Assigned to <PCI Device> IRQ-10 Assigned to <PCI Device> IRQ-11 Assigned to <PCI Device> IRQ-12 Assigned to <PCI Device> IRQ-14 Assigned to <PCI Device> IRQ-15 Assigned to <PCI Device>
PCI/VGA Palette Snoop	Enabling this item informs the PCI/VGA card to keep silent when palette register is updated
Assign IRQ for VGA	Choose Enabled/Disabled to specify whether the VGA uses on IRQ or not.
Assign IRQ for USB	Choose Enabled/Disabled to specify whether the USB uses an IRQ or not.

3. Please press the <ESC> key to return the main menu after finishing with the PNP/PCI Configuration Setup.

User's manual

PC Health Status Configuration Setup

Choose "PC Health Status Configuration Setup" from the main menu, the following screen appears:

Phoenix - Award BIOS CMOS Setup Utility		
PC Health Status		
CPU Warning Temperature	<Disabled>	Item Help Menu Level ▶
Current System Temp.	35° C/95° F	
Current CPU1 Temperature	21° C/69° F	
Current FAN1 Speed	5532 RPM	
Current FAN2 Speed	0 RPM	
VCORE	1.44 V	
3.3 V	3.36 V	
+ 5 V	4.73 V	
+12 V	11.97 V	
-12 V	-12.11 V	
VBAT (V)	3.29 V	
5VSB (V)	4.96 V	
Shutdown Temperature	<Disabled>	
↑↓→← Move Enter:Select +/-/PU/PD:Value F10:Save ESC:Exit F1:General Help F5:Previous Value F6:Fail-Safe Default F7:Optimized Defaults		

Frequency/Voltage Control Option

Choose the "Frequency/Voltage Control" from main menu, the following screen appears:

Phoenix - Award BIOS CMOS Setup Utility		
Frequency/Voltage Control		
Auto Detect DIMM/PCI Clk	<Enabled>	Item Help Menu Level ▶
Spread Spectrum	<Disabled>	
CPU Host/SDRAM Clock	<Default>	
↑↓→← Move Enter:Select +/-/PU/PD:Value F10:Save ESC:Exit F1:General Help F5:Previous Value F6:Fail-Safe Default F7:Optimized Defaults		

Load Fail-Safe Defaults

This option loads the troubleshooting default values permanently stored in the BIOS ROM. This is useful if you are having problems with the main board and need to debug or troubleshoot the system. The loaded default settings do not affect the Standard CMOS Setup screen.

Phoenix - AwardBIOS CMOS Setup Utilities

Standard CMOS Features	Frequency/Voltage Control
Advanced BIOS Features	Load Fail-Safe Default
Advanced Chipset Features	Load Optimized Defaults
Integrated Pheripherals	Set Password
Power Management	Setup
PnP/PCI Configura	Load Fail-Safe Defaults (Y/N)? Y
PC Health Status	Saving
Esc : Quit	↑↓→← : Select Item
F10 : Save & Exit Setup	
Time, Date, Hard Disk Type...	

To use this feature, highlight it on the main screen and press <Enter>. A line will appear on the screen asking if you want to load the BIOS default values. Pres the <Y> key and then press <Enter> if you want to load the BIOS default.

User's manual

Load Optimized Defaults

This option loads optimized settings stored in the BIOS ROM. The auto-configured settings do not affect the Standard CMOS Setup screen.

Phoenix - AwardBIOS CMOS Setup Utilities

Standard CMOS Features	Frequency/Voltage Control
Advanced BIOS Features	Load Fail-Safe Default
Advanced Chipset Features	Load Optimized Defaults
Integrated Pheripherals	Set Password
Power Management	Load Optimized Defaults (Y/N)? Y
PnP/PCI Configura	Setup
PC Health Status	Saving
Esc : Quit	↑↓→← : Select Item
F10 : Save & Exit Setup	
Time, Date, Hard Disk Type...	

To use this feature, highlight it on the main screen and press <Enter>. A line will appear on the screen asking if you want to load the Optimized Default Values. Press the <Y> key and then press <Enter> if you want to load the SETUP default.

Supervisor/User Password

The password options let you prevent unauthorized system boot-up or unauthorized use of CMOS setup. The Supervisor Password allows both system and CMOS Setup program access; the User Password allows access to the system and the CMOS Setup Utility main menu.

The password functions are disabled by default. You can use these options to enable a password function or, if a password function is already enabled, change the password.

To change a password, first choose a password option from the main menu and enter the current password. Then type your new password at the prompt. The password is case sensitive and you can use up to 8 alphanumeric characters. Press <Enter> after entering the password. At the Next Prompt, confirm the new password by typing it and pressing <Enter> again.

Phoenix - AwardBIOS CMOS Setup Utilities

Standard CMOS Features	Frequency/Voltage Control
Advanced BIOS Features	Load Fail-Safe Default
Advanced Chipset Features	Load Optimized Defaults
Integrated Pheripherals	Set Password
Power Management	Setup
PnP/PCI Configura	Saving
PC Health Status	
Enter Password:	
Esc : Quit	↑↓→← : Select Item
F10 : Save & Exit Setup	
Time, Date, Hard Disk Type...	

After you use this option to enable a password function, use the “Security Option” in “BIOS Feature Setup” to specify whether a password is required every time the system boots or only when an attempt is made to enter the CMOS Setup program.

Save and Exit Setup

This function automatically saves all CMOS values before exiting Setup.

Phoenix - AwardBIOS CMOS Setup Utilities

Standard CMOS Features	Frequency/Voltage Control
Advanced BIOS Features	Load Fail-Safe Default
Advanced Chipset Features	Load Optimized Defaults
Integrated Pheripherals	Set Password
Power Management	Setup
PnP/PCI Configura	Saving
PC Health Status	
Save CMOS and Exit (Y/N)? Y	
Esc : Quit	↑↓→← : Select Item
F10 : Save & Exit Setup	
Time, Date, Hard Disk Type...	

User's manual

Exit Without Saving

Use this function to exit Setup without saving the CMOS value.

Phoenix - AwardBIOS CMOS Setup Utilities

Standard CMOS Features	Frequency/Voltage Control
Advanced BIOS Features	Load Fail-Safe Default
Advanced Chipset Features	Load Optimized Defaults
Integrated Pheripherals	Set Password
Power Management	Setup
PnP/PCI Configura	Quit Without Saveing (Y/N)? Y
PC Health Status	Saving
Esc : Quit	↑↓→← : Select Item
F10 : Save & Exit Setup	
Time, Date, Hard Disk Type...	

Chapter 4. Driver Utility

The AW-F701 drivers and utilities CD-ROM contains the following folders.

- VGA: VGA drivers
- LAN: Ethernet drivers
- IDE RAID: IDE RAID drivers

The AW-F701 onboard with two Gigabit and two 100/10Mbps Ethernet onboard, it is also optional for four 100/10Mbps Ethernet.

The Intel® Chipset Software Installation Utility installs to the target system the Windows* INF files that outline to the operating system how the chipset components will be configured. This is needed for the proper functioning of the following features:

- Core PCI and ISAPNP Services
- AGP Support
- IDE/ATA33/ATA66 Storage Support
- USB Support
- Identification of Intel® Chipset Components in the Device Manager

Installing the Intel INF Driver for Windows98SE/ME/2000/XP

1. Insert the Drivers and Utilities CD into the CD ROM drive (example E:)
2. Double click the “845G\Chipset Software Installation Utility” folder in drive E: to open it and run “Setup” program by double click it.

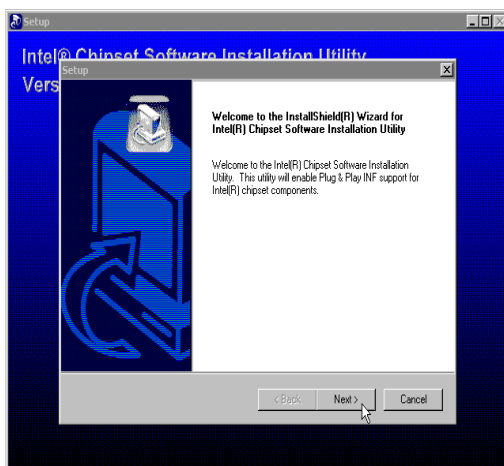

(1)Click “Next”

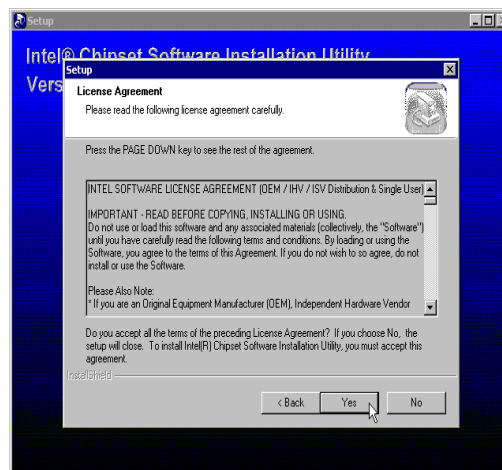

(2)Click “yes”

User's manual

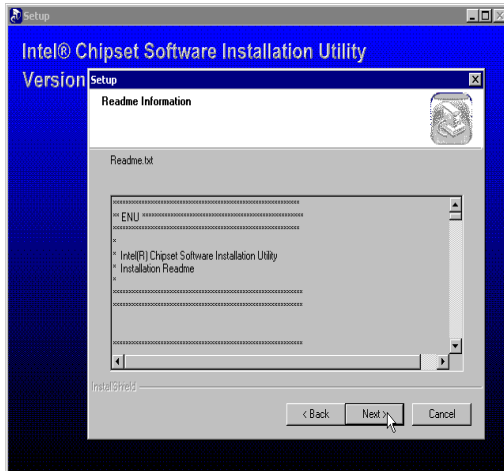

(3) Click “Next”

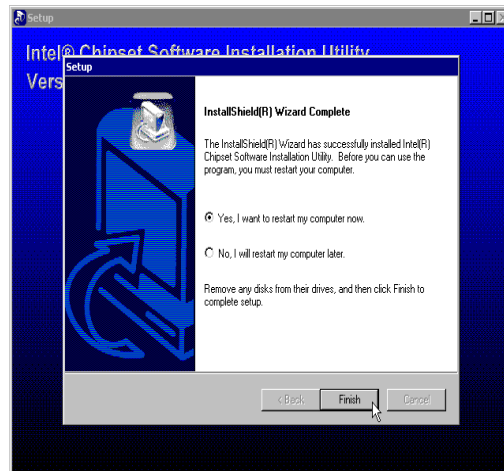

(4) Click “Finish” to restart your system

Intel Application Accelerator

The Intel(R) Application Accelerator is designed to improve performance of the storage sub-system and overall system performance. This software delivers improved performance through several ingredient technologies (components). Certain components will be available only on Pentium(R) 4 processor-based systems running Microsoft Windows 2000 and Windows XP. Software installation is flexible and fully automated for Microsoft Windows 98, Windows 98 Second Edition(SE), Windows Millennium Edition(Me), Windows NT 4.0, Windows 2000, and Windows XP operating systems.

1. Insert the Drivers and Utilities CD into the CD ROM drive (example E:)
2. Double click the “845G\Iaa” folder in drive E: to open it run “iaa***.exe”

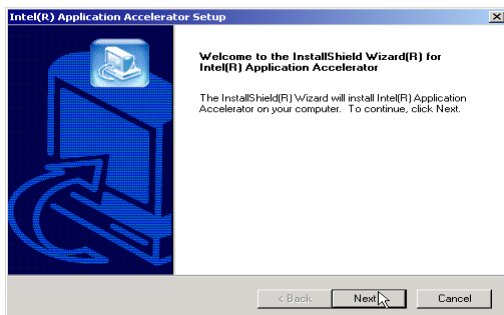

(1) Click “Next”

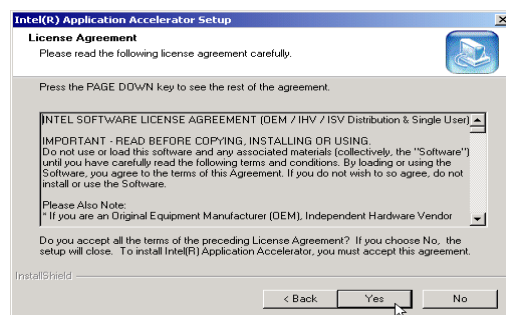

(2) Click “Yes”

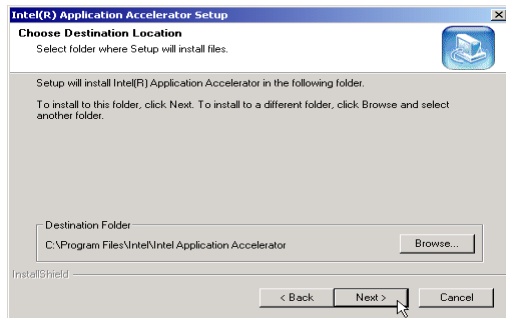

(3) Click “Next”

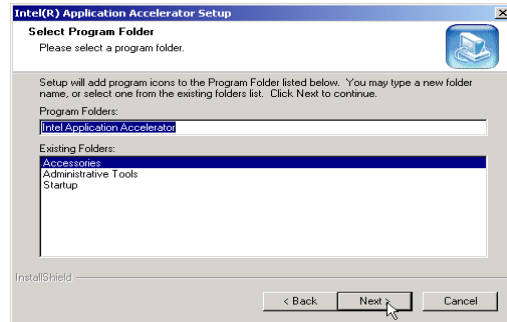

(4) Click “Next”

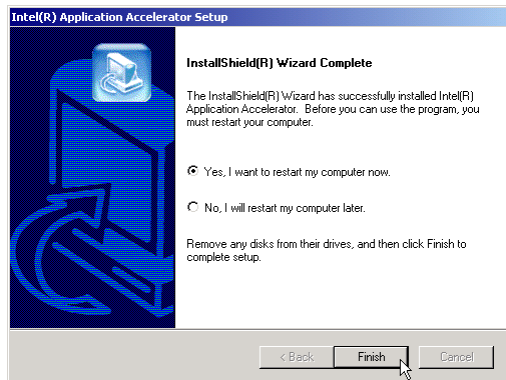

(5) Click “Finish” to restart your system

VGA Driver

The AW-F701 is a powerful, compact and full function single board computer that can be used in multitude of embedded applications. The board is designed with CRT display interface for those applications do not need the VGA/LCD controller to save on cost but for customers do need the VGA/LCD controller supports, there are two powerful VGA/LCD controllers through Micro AGP bus are available.

- Onboard CRT Display Controller
- AW-VGA1 SMI Lynx3DM chip
- AW-VGA2 ATI M6 chip

Install the drivers for VGA as follows:

It is strongly recommended that you exit all Windows programs before running this Setup program.

Warning: *This program is protected by copyright law and international treaties.*

Unauthorized reproduction or distribution of this program, or any portion of it, may result in severe civil and criminal penalties, and will be prosecuted to the maximum extent possible under law.

User's manual

Intel 845G Chipset VGA Graphics Driver

- 1 Insert the Drivers and Utilities CD into the CD ROM drive (example E:).
- 2 The installation is same as Windows 2000
- 3 Double click the “845G\Graphics\WinXP_2K” folder in drive E: to open it and run “Setup” program by double click it.

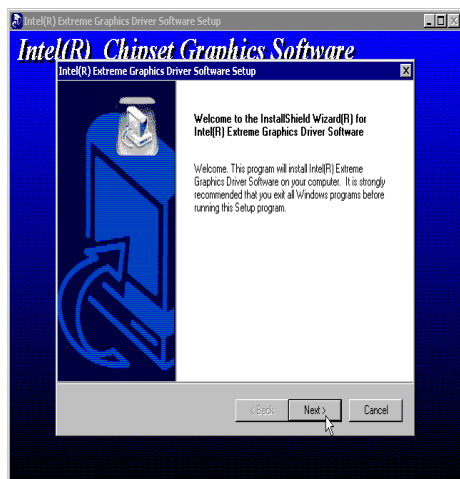

(1)Click “Next”

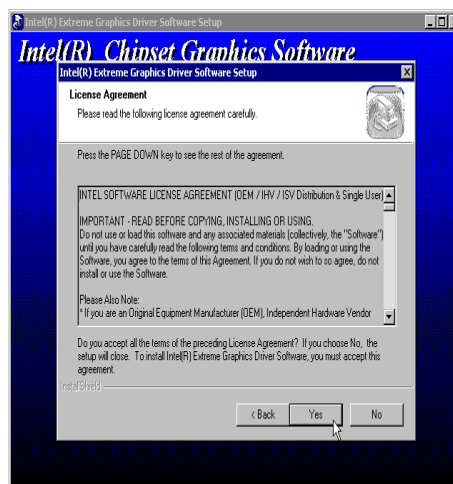

(2)Click “Yes”

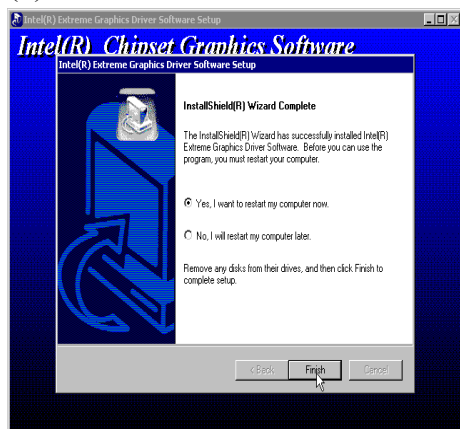

(3)Click “Finish” to resart your system

AW-VGA1 SMI Lynx3DM VGA Chipset Driver

Please insert the CD-ROM into your CD-ROM drive bay. Please click “**setup**” to start the VGA driver installation.



(1) Click “Next”



(2) Click “Finish” to restart your system

VGA Utilities: You can choose the different displays type from the screen

(1) LCD (2) CRT (3) TV-Out

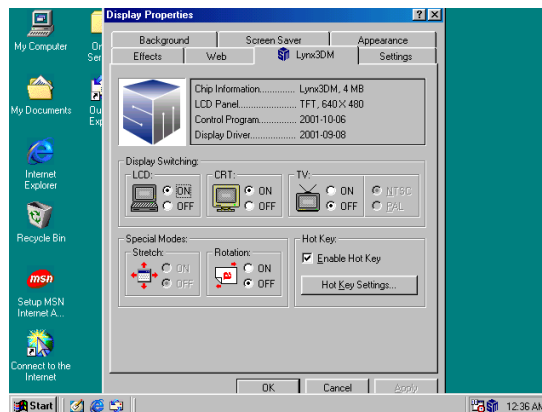

User's manual

AW-VGA2 ATI M6 Chipset VGA Graphics Driver

1. Insert the Drivers and Utilities CD into the CD ROM drive (example E:)
2. Double click the "AW-VGA2" folder in drive E: to open it and run "Setup" program by double click it.



(1)Click "Next"

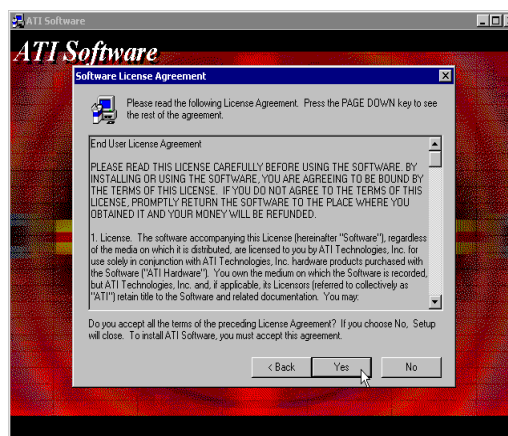

(2)Click "Yes"

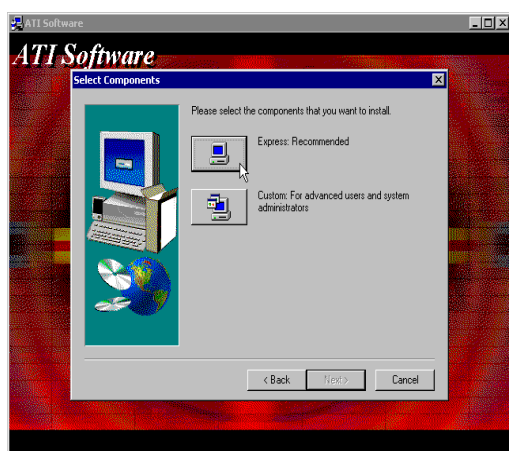

(3)Click "Express:Recommended"

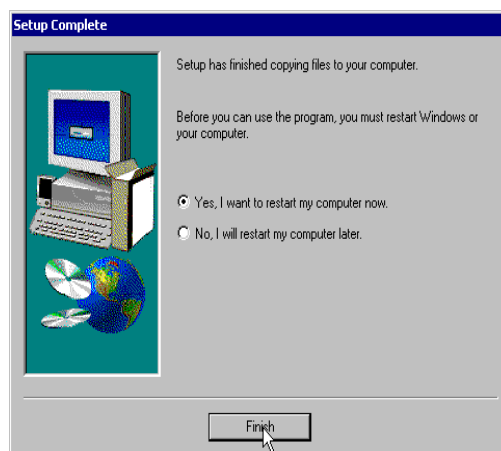

(4) Click "Finish" to resart your system

Intel Network Driver

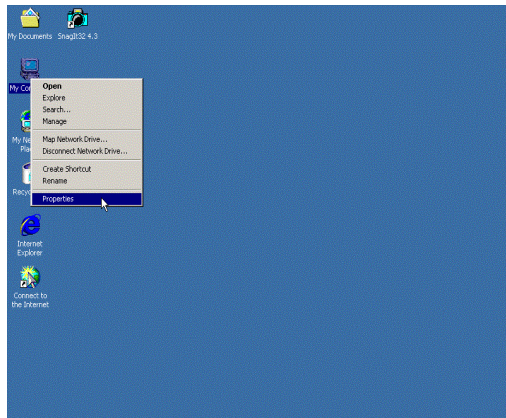

(1)Click “My Computer”→ Properties
Manager”

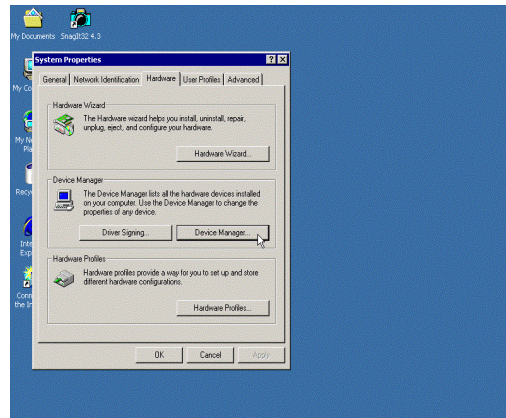

(2)Click “Hardware”→ “Device
Manager”

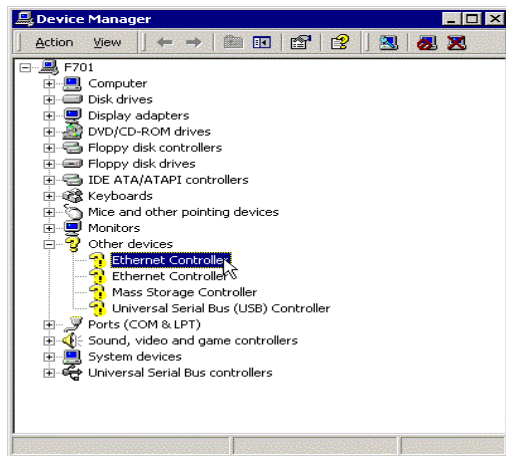

(3)Click “Other devices” →”Ethemet Controller”

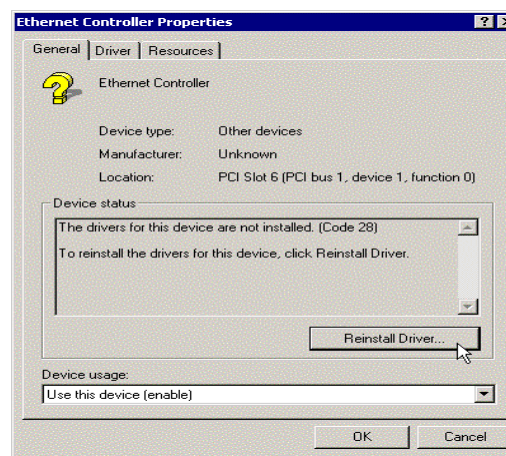

(4)Click “Reinstall Driver”



(5) Click “Next”

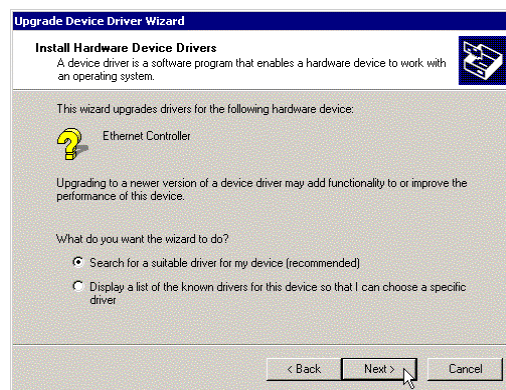

(6) Click “Next”

User's manual

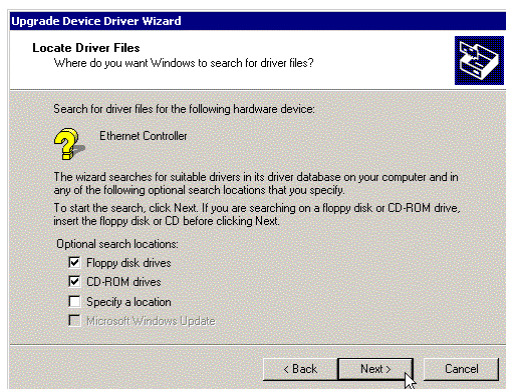

(7) Click "Next"

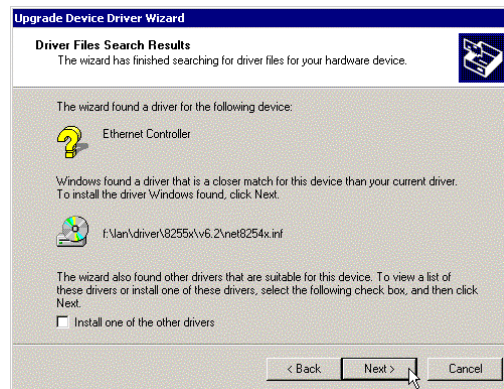

(8) Click "Next"



(9) Click "Finish" to restart computer

ADI AC'97 Audio Driver

1. Insert the Drivers and Utilities CD into the CD ROM drive (example E:)
2. Double click the “Sound” folder in drive E: to open it and run “Setup” program by double click it.

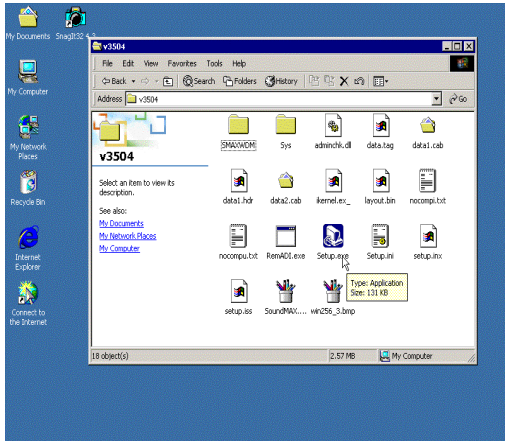

(1) Double click “setup.exe”

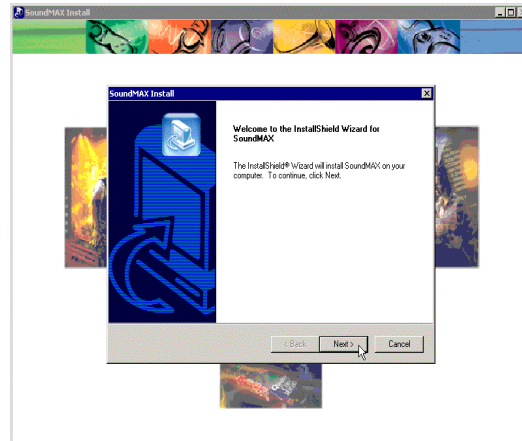

(2) Click “Next”

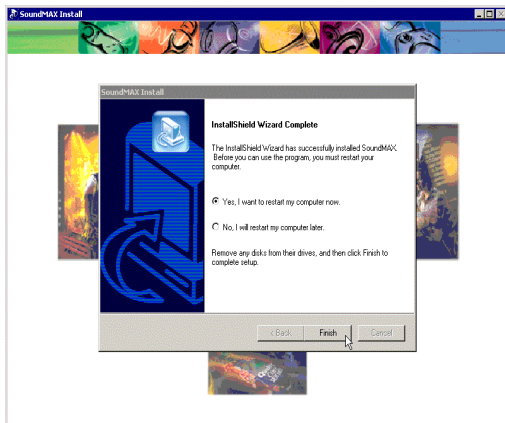

(3) Click “Finish” to resart your system

Promise Ultra ATA/133 Driver

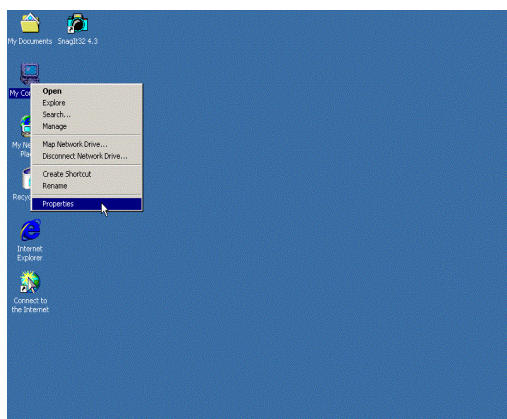

(1) Click "My Computer" → Properties
"Device Manager"

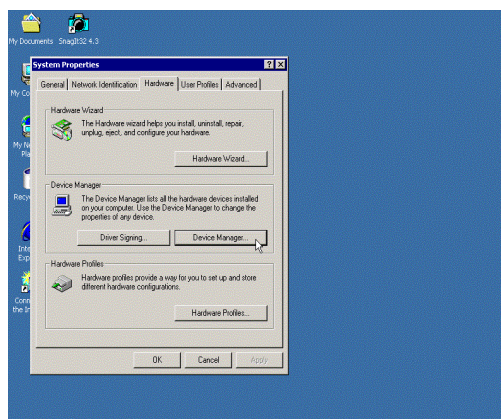

(2) Click "Hardware" → "Device

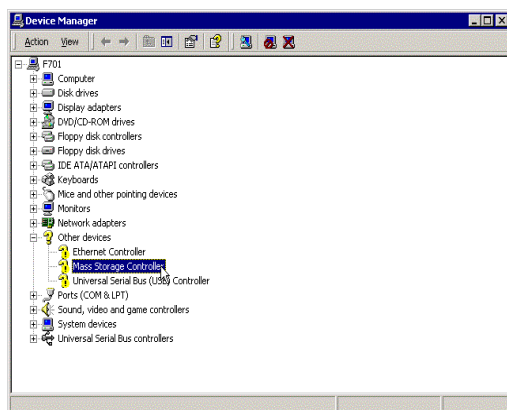

(3) Click "Other devices"
→ "Mass Storage Controller"

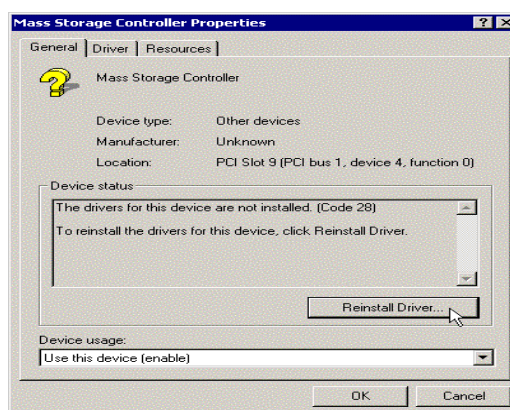

(4) Click "Reinstall Driver"



(5) Click "Next"

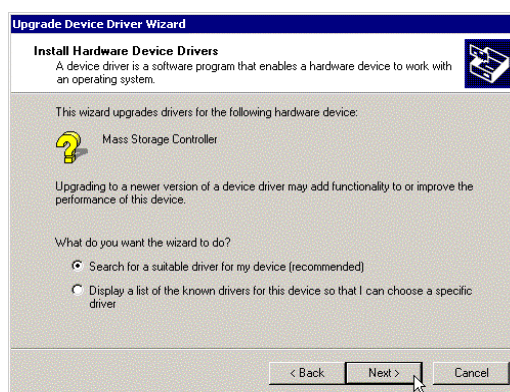

(6) Click "Next"

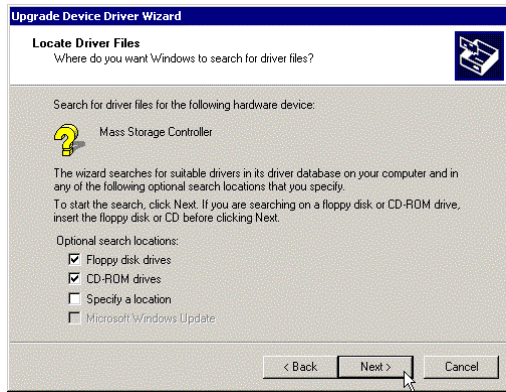

(7) Click "Next"

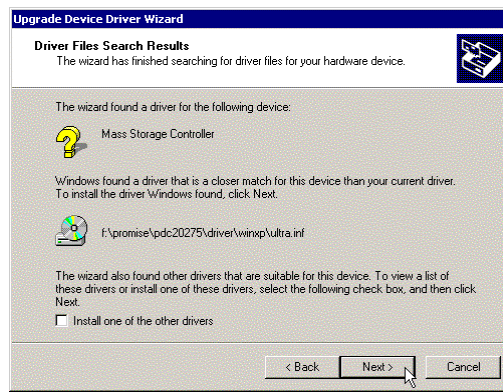

(8) Click "Next"



(9) Click "Finish" to restart computer

User's manual

Appendix A: Programming the Watchdog Timer

The AW-F701 provides a watchdog timer that resets the CPU or generates an interrupt if processing comes to a stop. This function ensures greater system reliability in industrial stand-alone and unmanned environments.

In order to enable the watchdog timer, you have to output the value of the watchdog timer interval to the controller. The value range is from 01H to FFH, and the related time watchdog timer interval is 1 sec to 255 sec.

Data	Timer interval
00	Disabled
01	1 sec
02	2 sec
*	*
*	*
FF	255 sec

If you want to disable the watchdog timer, just set the timer interval value to 00H.

After setting the timer interval value, the watchdog timer begins to count down. You have to refresh the watchdog timer, so that the watchdog timer will return to its initial value; otherwise, your system will reset after a time-out. The following program shows how to set the watchdog timer:

ASSEMBLY LANGUAGE

DOS DEBUG

Program 1: Initializing the watchdog controller

MOV DX,2EH	O 2E 87
MOV AL,87H	O 2E 87
OUT DX,AL	
OUT DX,AL	
MOV AL,07H	O 2E 07
OUT DX,AL	O 2F 08
MOV DX,2FH	
MOV AL,08H	
OUT DX,AL	

Program 2: Writing a watchdog timer interval value

MOV DX,2EH	O 2E F6
MOV AL,F6H	O 2F XX
OUT DX,AL	O 2E AA
MOV DX,2FH	
MOV AL,XXH ; Timer interval *** see note ***	
OUT DX,AL	
MOV DX,2EH	
MOV AL,AAH	
OUT DX,AL	

Note: This XX value range is from 01H to FFH, and the related watchdog timer interval is 1 sec. to 255 sec. (as in the previous description).

Using the Demo Program

Update the System BIOS as follows:

1. Run Program 1
2. Run Program 2 (load the timer interval of 1EH, 30 seconds)
3. Run your Application Program #1 (**Be sure your Application Program will finish within 30 seconds**)
4. Run Program 1
5. Run Program 2 (change the timer interval value to 3CH, 60 seconds)
6. Run your Application Program#2 (**Be sure your Application Program will be finished within 60 seconds**)
7. Run Program 1
8. Run Program 2 (reload the timer interval value of 3CH, 60 seconds)
9. Run Program 1
10. Run Program 3 (Load the timer interval of 00H, and disable the watchdog timer function)

User's manual

Appendix B: AC-97 Audio Kit

AC97 Board Layout

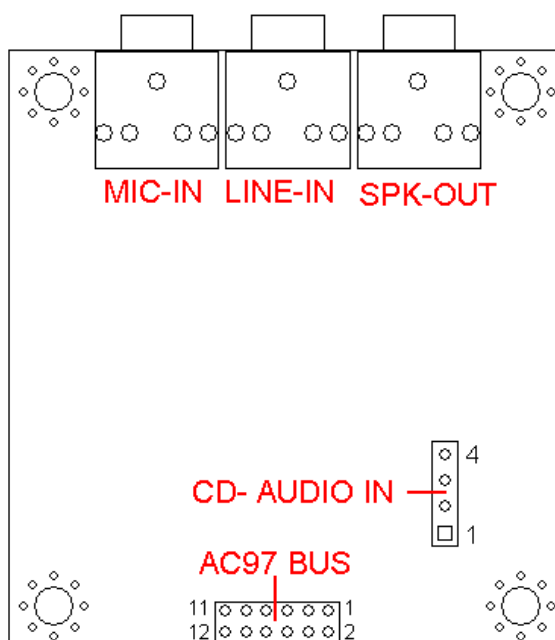

AC97 Board Dimension

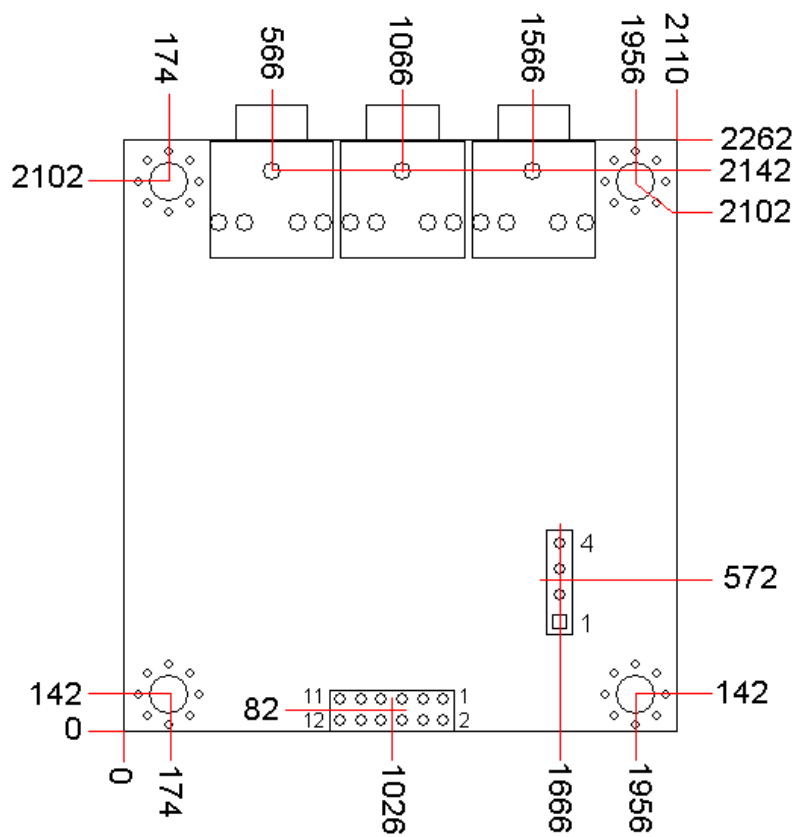

AC97 Location of Connector

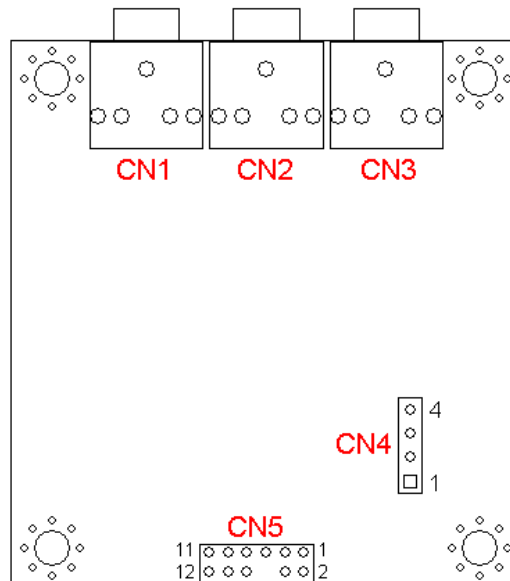

AC97 List of Connector

Connectors	Description
CN1	Micro-Phone Input
CN2	Line-In
CN3	Speaker-Out
CN4	CD Audio Input
CN5	AC97 Audio Input

CN1: This MIC-In jack connects to a microphone

CN2: This Line-In jack connects to a tape player or other audio sources.

CN3: This Speaker-Out jack connects to a headphone or a speaker.

User's manual

CN4: CD Audio Input Connector

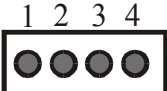
	Pin	Signal
	1	CD AIDIO-L
	2	GND
	3	GND
	4	CD AUDIO-R

CN5: AC-97 Audio Input Connector

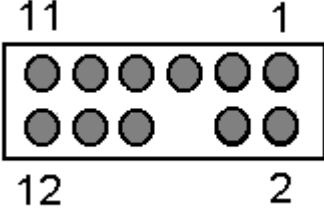
			
Pin	Signal	Pin	Signal
1	+12V	2	GND
3	GND	4	AC97-BTCLK
5	+3.3V	6	KEY PIN
7	AC97-SDIN0	8	AC97-SYNC
9	GND	10	AC97-RESET
11	AC97-SDOUT	12	PC-BEEP

Appendix C: System Resources

Interrupt Controller

The AW-F701 is a fully PC compatible control board, it consists of 16 ISA interrupt request lines and most of them already in used by other part of the board. Both of ISA and PCI expansion cards may need to use IRQs, please make sure that the IRQs do not conflict if you would like to use extra add-on cards.

System IRQs are available to cards installed in the ISA expansion Bus first. Any remaining IRQs then may be assigned to this PCI Bus. You are able to use the AMI Diagnostic utility to see their map.

IRQ	Assignment
IRQ0	System Timer Output
IRQ1	Keyboard
IRQ2	Interrupt rerouting from IRQ8 through IRQ15
IRQ3	Serial Port 2
IRQ4	Serial Port 1
IRQ5	Reserved
IRQ6	Floppy Disk Controller
IRQ7	Parallel Port
IRQ8	Real Time Clock
IRQ9	Reserved
IRQ10	Reserved
IRQ11	Reserved
IRQ12	PS/2 Mouse
IRQ13	Math Coprocessor
IRQ14	Primary IDE Controller
IRQ15	Secondary IDE Controller

User's manual

Appendix D: Order Information

Model	LAN Port	IDE1/2 ATA100	IDE3/4 ATA133	IDE RAID	Remark
AWF701I40	4*100/10Mbps	YES	YES	N/A	Promise 275
AWF701I22	2*Gigabit+2*100/10Mbps	YES	YES	N/A	Promise 275
AWF701I20	2*100/10Mbps	YES	N/A	N/A	No 275 onboard
AWF701I10	1*100/10Mbps	YES	N/A	N/A	No 275 onboard
AWF701I00	N/A	YES	N/A	N/A	No 275 onboard
AWF702I40	4*100/10Mbps	YES	YES	RAID-0 or RAID-1	Promise 276
AWF702I22	2*Gigabit+2*100/10Mbps	YES	YES	RAID-0 or RAID-1	Promise 276
AWF702I20	2*100/10Mbps	YES	YES	RAID-0 or RAID-1	Promise 276
AW702I10	1*100/10Mbps	YES	YES	RAID-0 or RAID-1	Promise 276
AW-VGA1	SMI721 Chip w/8MB VRAM Built-in				
AW-VGA2	ATI M6 Chip w/32MB DDR RAM Built-in				
AC97-1881	Audio Kit				
AW-UL1	6USB Ports + 2 LAN Jack Bracket with Cables				
AW-USB	6USB Ports Bracket with Cables				
AW-TVOUT	Come with AW-VGA1 or AW-VGA2 with Cables				

Appendix E: Optional Cables List

Part Number	Cable Description	AW-F701 Connector	Terminating Connector
46-ATA660-00	ATA-66 IDE Cable	CN3, CN7	ATA66 IDE Cable, 46cm
46-IFDC01-00	Floppy Cable	CN13	Floppy Cable 2.54 to 2.0mm, 50cm
46-I606KP-00	KB + PS/2 Mouse Cable	CN15	KB + PS/2 Mouse Cable, 15cm
46-IPM02B-00	LPT + COM Port Cable	CN9, CN10	LPT+COM Port Cable w/Bracket, 2mm, 30cm
46-ICOM2B-00	COM2 Cable	CN11	I/O Cable w/Bracket, 2mm, 20.50cm
46-IUSB02-00	USB Cable	CN16	USB Cable 20.50cm
46-ILAN02-00	LAN Cable	CN17	2*13(26pin) Cable, 2mm, 20.50cm
46-I0002x7-00	2*6 → 2*7 Cable	CN1	Audio Cable 2*6→2*7 Cable, 2mm, 16cm
46-IP2050-00	ATX Power Cable	CN5 (Ver.A1)	20pin to 20pin ATX Power Cable
46-I701X3-00	5VSB Cable	CN24 (Ver.A2)	3pin 5VSB Connector
46-ITV002-00	TV-Out Cable	AW-VGA1: CN3 AW-VGA2: CN4	TV-Out Cable, 2mm, 18cm