

AV45GT/AV45GTR

Pentium 4 Processor

Based DDR MAIN BOARD

User's Manual

Shuttle® Spacewalker™ AV45GT/AV45GTR

Pentium 4 , 478-pin processor based DDR Mainboard

Manual Version 1.0

Copyright

Copyright© 2001 by Shuttle® Inc. All Rights Reserved.

No part of this publication may be reproduced, transcribed, stored in a retrieval system, translated into any language, or transmitted in any form or by any means, electronic, mechanical, magnetic, optical, chemical, photocopying, manual, or otherwise, without prior written permission from Shuttle® Inc.

Disclaimer

Shuttle® Inc. shall not be liable for any incidental or consequential damages resulting from the performance or use of this product.

This company makes no representations or warranties regarding the contents of this manual. Information in this manual has been carefully checked for reliability; however, no guarantee is given as to the correctness of the contents. In the interest of continued product improvement, this company reserves the right to revise the manual or include changes in the specifications of the product described within it at any time without notice and without obligation to notify any person of such revision or changes. The information contained in this manual is provided for general use by the customers.

Trademarks

Spacewalker is a registered trademark of Shuttle Inc.

Intel, Pentium is a registered trademarks of Intel Corporation.

VIA is a registered trademark of VIA Corporation.

PS/2 is a registered trademark of IBM Corporation.

AWARD is a registered trademark of Award Software Inc.

Microsoft and Windows are registered trademarks of Microsoft Corporation.

General Notice: Other brand and product names used herein are for identification purposes only and may be trademarks of their respective owners.

TABLE OF CONTENTS

| | |
|--|-----------|
| WHAT'S IN THE MANUAL | 5 |
| Quick Reference | 5 |
| About This Manual | 5 |
| 1 INTRODUCTION | 6 |
| 1.1 TO DIFFERENT USERS | 6 |
| FIRST-TIME DIY SYSTEM BUILDER | 6 |
| EXPERIENCED DIY USER | 6 |
| SYSTEM INTEGRATOR | 6 |
| 1.2 ITEM CHECKLIST: | 7 |
| 2 FEATURES..... | 8 |
| 2.1 SPECIFICATIONS | 8 |
| 3 HARDWARE INSTALLATION | 11 |
| 3.1 STEP BY STEP INSTALLATION..... | 11 |
| Accessories of AV45GT/AV45GTR | 11 |
| STEP 1 Install the CPU | 12 |
| STEP 2 Set Jumpers | 14 |
| STEP 3 Install DDR SDRAM System Memory | 14 |
| STEP 4 Install Peripherals in System Case..... | 15 |
| STEP 5 Mount the Mainboard on the Computer Chassis | 16 |
| STEP 6 Connect Front Panel Switches/LEDs/Speaker/USB | 17 |
| STEP 7 Connect IDE, IDE RAID (AV45GTR only), and Floppy Disk Drives | 19 |
| STEP 8 Connect Other Internal Peripherals | 20 |
| STEP 9 Connect the Power Supply | 21 |
| STEP 10 Install Add-on Cards in Expansion Slots | 21 |
| STEP 11 Connect External Peripherals to Back-Panel..... | 22 |
| STEP 12 First Time System Boot Up | 24 |
| STEP 13 Install Drivers & Software Components | 25 |

| | |
|---|-----------|
| 3.2 JUMPER SETTINGS | 26 |
| JUMPERS & CONNECTORS GUIDE | 27 |
| <i>Jumpers</i> | |
| Clear CMOS Setting (JP1) | 30 |
| On board RAID Enable/Disable Setting (JP2) (AV45GTR only) | 30 |
| <i>Back-Panel Connectors</i> | |
| PS/2 Keyboard & PS/2 Mouse Connectors | 31 |
| USB1/USB2 Port Connectors | 31 |
| COM1/2 Port Connectors | 31 |
| Parallel Port Connector | 31 |
| Line-Out (Front-Out) Port Connector | 32 |
| Line-In (Rear-Out) Port Connector | 32 |
| Mic-In Port Connector | 32 |
| MIDI/GAME Port Connector | 32 |
| <i>Front-Panel Connectors</i> | |
| ATX Power On/Off Switch Connector (Power ON) | 33 |
| System Management Interface Connector (EPMI) | 33 |
| Green LED/Power LED Connector (Green LED/Power LED) | 34 |
| HDD LED Connector (HDD LED) | 34 |
| Power LED Connector (Power LED) | 35 |
| Hardware Reset Connector (Reset) | 35 |
| Speaker Connector (SPEAKER) | 35 |
| Extended USB Header (JUSB1/2) | 36 |

| | |
|---|-----------|
| <i>Internal Peripherals Connectors</i> | |
| Enhanced IDE, IDE RAID (AV45GTR only), and Floppy Connector | 37 |
| <i>Other Connectors</i> | |
| ATX Power Supply Connector (J9, J10, and J11) | 38 |
| Cooling Fan Connectors for CPU (FAN1), System (FAN2), Chipset (FAN3) | 39 |
| IR Header (J12) | 39 |
| Wake-on Lan Connector (WOL1) | 40 |
| Audio CD-IN Connector (J7) (Black) | 40 |
| Audio Auxiliary-IN Connector (J8) (White) | 40 |
| Audio Bass/Center-Out Header (J14) | 41 |
| 3.3 SYSTEM MEMORY CONFIGURATION | 42 |
| 1. INSTALL MEMORY | 42 |
| 2. UPGRADE MEMORY | 42 |
| 4 SOFTWARE UTILITY | 43 |
| 4.1 Mainboard CD Overview | 43 |
| 4.2 Install Mainboard Software | 44 |
| 4.2.A Install VIA 4-IN-1Driver | 45 |
| 4.2.B Install Audio Driver | 46 |
| 4.2.C Install RAID Driver and Utility (AV45GTR only) | 47 |
| 4.3 View the User's Manual | 48 |

| | |
|---------------------------------|-----------|
| 5 BIOS SETUP | 49 |
| 5.1 ENTER BIOS | 49 |
| 5.2 THE MAIN MENU | 50 |
| STANDARD CMOS FEATURES | 52 |
| ADVANCED BIOS FEATURES | 56 |
| ADVANCED CHIPSET FEATURES | 60 |
| INTEGRATED PERIPHERALS | 64 |
| POWER MANAGEMENT SETUP | 67 |
| PNP/PCI CONFIGURATION | 71 |
| PC HEALTH STATUS | 73 |
| FREQUENCY/VOLTAGE CONTROL | 74 |
| LOAD FAIL-SAFE DEFAULTS | 76 |
| LOAD OPTIMIZED DEFAULTS | 76 |
| SET SUPERVISOR PASSWORD | 77 |
| SET USER PASSWORD | 77 |
| SAVE & EXIT SETUP | 79 |
| EXIT WITHOUT SAVING | 79 |

WHAT'S IN THE MANUAL

Quick Reference

| | |
|--|---------|
| Hardware Installation >> Step-by-Step | Page 11 |
| Jumper Settings >> A Closer Look | Page 26 |
| Drivers/Software Utilities >> How to Install | Page 43 |
| BIOS Setup >> How to Configure | Page 49 |

About This Manual

| | |
|---|--------|
| For First-Time DIY System Builder | Page 6 |
| For Experienced DIY User | Page 6 |
| For System Integrator | Page 6 |

1 INTRODUCTION

1.1 To Different Users

First-Time DIY System Builder

Welcome to the DIY world! Building your own computer system is not as difficult as you may think. To make your first computer DIY experience successful, right from the start, we have designed the **3.1 Hardware Installation** section in a step-by-step fashion for all the first-time DIY system builders. Prior to installation, we also suggest you to read the whole manual carefully to gain a complete understanding of your new Shuttle AV45GT/AV45GTR mainboard.

Experienced DIY User

Congratulate on your purchase of the Shuttle AV45GT/AV45GTR mainboard. You will find that installing your new Shuttle AV45GT/AV45GTR mainboard is just easy. Bundled with an array of onboard functions, the highly-integrated AV45GT/AV45GTR mainboard provides you with a total solution to build the most stable and reliable system. Refer to sections **3.2 Jumper Settings** and **Chapter 4 Drivers/Software Utilities** to find out how to get the best out of your new mainboard. **Chapter 5 BIOS Setup** also contains the relevant information on how to tune up your system to achieve higher performance.

System Integrator

You have wisely chosen Shuttle AV45GT/AV45GTR to construct your system. Shuttle AV45GT/AV45GTR incorporates all the state-of-the-art technology of the P4X266A chipset from Intel. It integrates the most advanced functions you can find to date in a compact ATX board.

This manual adopted in AV45GT and AV45GTR mainboards at the same time. The difference between AV45GT and AV45GTR is that AV45GTR equips with onboard IDE RAID Controller. In the manual, if there are some standards, characters, equipment or software only appeared or adopted by AV45GTR; it will be mentioned (**AV45GTR only**)

1.2 Item Checklist:

Check all items with you AV45GT/AV45GTR mainboard to make sure nothing is missing. The complete package should include:

- * One piece of Shuttle AV45GT/AV45GTR Mainboard

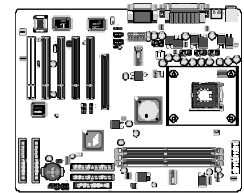

- * One piece of Audio Cable (Central/Bass Channel)

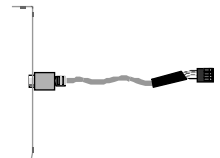

- * One piece of ATA **100/66/33** Ribbon Cable

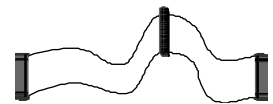

- * One piece of Floppy Ribbon Cable

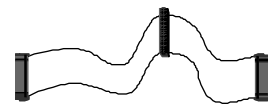

- * One piece of twin ports USB Cable (**optional**)

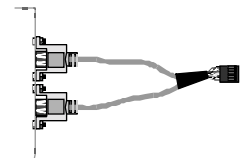

- * AV45GT/AV45GTR User's Manual

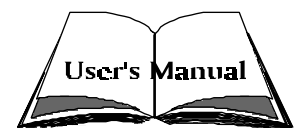

- * One piece of Bundled CD-ROM with containing:

- AV45GT/AV45GTR user's manual saved in PDF format
- IDE RAID user's manual saved in PDF format (**AV45GTR only**)
- VIA 4-IN-1 driver
- Hardware Audio driver
- IDE RAID driver and Utility (**AV45GTR only**)
- Award Flashing Utility



2 FEATURES

AV45GT/AV45GTR mainboard is carefully designed for the demanding PC user who wants high performance and maximum intelligent features in a compact package.

2.1 Specifications

* CPU Support

Intel Pentium 4, 478-pin processors with 100 MHz FSB.

* Chipset

Features VIA P4X266A N.B. and VIA VT8233 S.B..

* Jumperless CPU Configuration

Soft-configuration FSB (The FSB speed is software configurable from 100MHz to 160MHz *by 1MHz step* in the Frequency/Voltage Control of BIOS setup program.)

* On Board Multi-Channel Hardware Audio Controller

Support 5.1 speakers, C3DX positional audio in 6 CH speaker mode.
HRTF-3D positional audio, supporting Direct Sound 3D and A3D interface.
Legacy SBPRO compatible.

* On Board IDE RAID Controller (AV45GTR only)

Support RAID 0, RAID 1 function.

* Versatile Memory Support

Three **184-pin DIMM** slots to support up to 3GB of PC1600 or PC2100 compliant **DDR** SDRAM module.

* PCI Expansion Slots

Provides five 32-bit PCI slots.

* AGP Expansion Slots

Provides one 32-bit AGP slot which supports up to 4X AGP devices.

* 6 USB Interface Onboard

➤ 2 × USB connectors on back-panel and two sets of dual USB ports header on mid-board.

* I/O Interface

Provides a variety of I/O interfaces:

- 1 × Floppy interface for 3.5-inch FDD with 720KB, 1.44MB, or 2.88MB format or for 5.25-inch FDD with 360K or 1.2MB format.
- 1 × PS/2 mouse connector.
- 1 × PS/2 Keyboard connector.
- 2 × DB9 Serial connectors 16550 UART compatible.
- 1 × Infrared communication port.
(Serial port COM2 can also be redirected to an external IrDA Adapter for wireless connection.)
- 1 × DB25 Parallel port supports Standard Parallel Port and Bi-directional (SPP), Enhanced Parallel Port (EPP), and Extended Capabilities Port (ECP) data transmission schemes.
- 1 × Line-Out (Front-Out) port.
- 1 × Line-In port, shared with rear speaker output when multi-channel audio is enabled.
- 1 × Mic-In port.
- 1 × MIDI/GAME port.

* PCI Bus Master IDE Controller Onboard

Two Ultra DMA **100/66/33** Bus Master Dual-channel IDE ports provide support to a maximum of four IDE devices (one Master and one Slave per channel). The IDE Bus implements data transfer speeds of up to **100/66/33** MB/sec and also supports Enhanced PIO Modes.

80-pin Cable Backward Compatible Legacy ATAPI Devices, ATAPI IDE CD-ROM, CD-R, CD-RW, and LS-120 Supports.

* ATX Power Supply Connector

ATX power supply unit can connected to the onboard 20-pin Pentium 4 standard ATX power connectors, supporting Suspend and Soft-On/Off by dual-function power button.

The Pentium 4 ATX power include three connectors.

* Advanced Configuration and Power Interface

Features four power saving modes: S1 (Snoop), S3 (Suspend to RAM), S4 (Suspend to DISK), and S5 (Soft-Off). ACPI provides more efficient Energy Saving Features controlled by your operating system that supports OS Direct Power Management (OSPM) functionality.

* **System BIOS**

Provides licensed Award BIOS V6.0 PG on Intel Firmware Hub 2Mb Flash core and supports Green PC, Desktop Management Interface (DMI).

* **ATX Form Factor**

System board conforms to ATX specification.

Board dimension: 305mm × 244mm.

* **Advanced Features**

- **Low EMI** - Built in spread spectrum and automatic clock shut-off of unused PCI/SDRAMS slots to reduce EMI.
- **Dual Function Power Button** - The system can be in one of two states, one is Suspend mode and the other is Soft-Off mode. Pushing the power button for less than 4 seconds places the system into Suspend mode. When the power button is pressed for longer than 4 seconds, the system enters Soft-Off mode.
- **CPU Clock Setting** - This item allows users to adjust CPU Host Clock in BIOS.
- **CPU Multiplier Setting** - This item allows users to adjust CPU Multiplier in BIOS.
- **CPU Vcore Setting** - This item allows users to select CPU Vcore in BIOS.
- **DDR Voltage Setting** - This item allows users to select DDR Voltage in BIOS.

* **Intelligent Features**

- **Voltage Monitoring** - Monitors various voltages of key elements, such as the CPU, and other critical system voltage levels to ensure stable current passing through mainboard components.
- **Fan Status Monitoring** - To prevent CPU from overheating, the CPU fan is monitored for RPM and failure. (CPU Cooling FAN with RPM sensor is required.)
- **Temperature Monitoring** - This item allows users to make sure whether the CPU or system runs in a suitable temperature.

Step 1

CPU Installation:

This mainboard supports Intel® Pentium® 4 Socket 478 series CPU. Please follow the step as below to finish CPU installation.

Be careful of CPU orientation when you plug it into CPU socket.

1. Pull up the CPU socket lever and up to 90-degree angle.

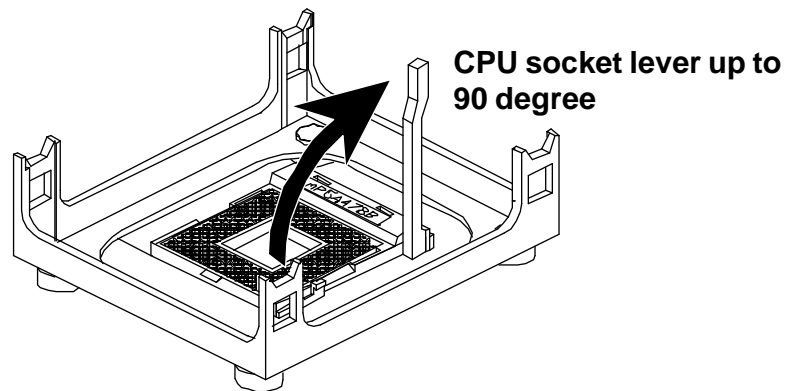

2. Locate Pin 1 in the socket and look for a black dot or cut edge on the CPU upper interface. Match Pin 1 and cut edge, then insert the CPU into the socket.

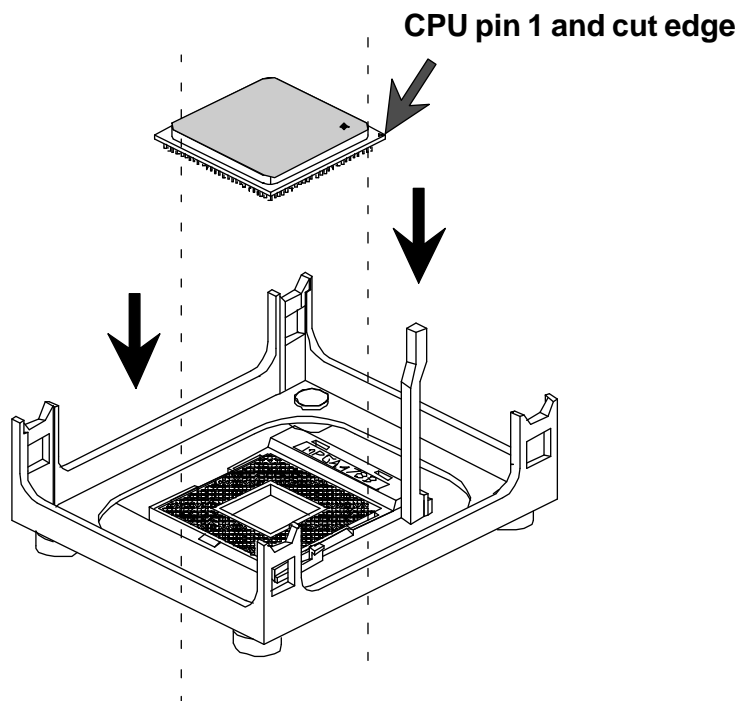

3. Press down the CPU socket lever and finish CPU installation.

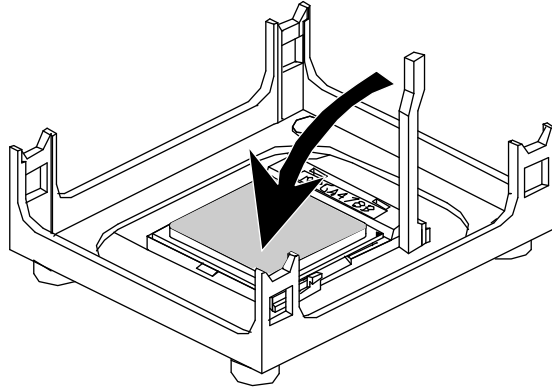

Note: If you do not match the CPU socket Pin 1 and CPU cut edge well, it may damage the CPU.

Step 2.

Set Jumpers

This mainboard is jumperless! The default jumper settings have been set for the common usage standard of this mainboard. Therefore, you do not need to reset the jumpers unless you require special adjustments as any of the following cases:

1. Clear CMOS

For first-time DIY system builders, we recommend that you do not change the default jumper settings if you are not totally familiar with the mainboard configuration procedures. The factory-set default settings are tuned for optimum system performance. For the advanced users who wish to customize their system, section **3.2 Jumper Settings** will provide detailed information on how to configure your mainboard manually.

Step 3

Install DDR SDRAM System Memory

To install memory, insert DDR SDRAM memory module(s) in any one or two or three DIMM banks. Note that DDR SDRAM modules are directional and will not go in the DIMM banks if they are not properly oriented. After the module is fully inserted into the DIMM bank, lift the clips of both sides of the DIMM bank to lock the module in place.

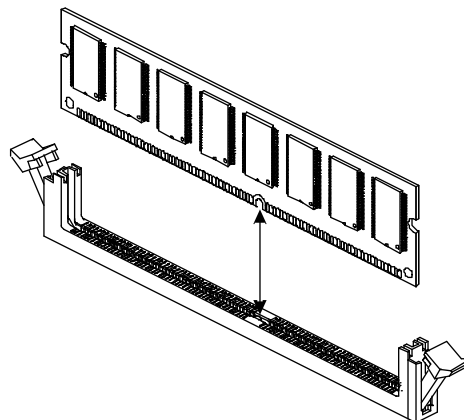

Step 4

Install Internal Peripherals in System Case

Before you install and connect the mainboard into your system case, we recommend that you first assemble all the internal peripheral devices into the computer housing, including but not limited to the hard disk drive (IDE/HDD), floppy disk drive (FDD), CD-ROM drive, and ATX power supply unit. This will greatly facilitate in making the connections to the mainboard described below.

To install IDE & FDD drives, follow this procedure:

1. Set the required jumpers on each device according to the instructions provided by the manufacturer. (IDE devices, HDD, and CD-ROM, have to set jumpers to Master or Slave mode depending on whether you install more than one device of each kind.)
2. Connect IDE cable and FDD cable on the back-panel of the internal peripheral devices to the corresponding headers on board. Note that the cable should be oriented with its colored stripe (usually red or magenta) connected to pin#1 both on the mainboard IDE or FDD connector and on the device as well.
3. Connect an available power cable from your system power supply unit to the back-panel of each peripheral device. Note that the power cable is directional and cannot fit in if not properly positioned.

Step 5

Mount the Mainboard on the Computer Chassis

1. You may find that there are a lot of different mounting hole positions both on your computer chassis and on the mainboard. To choose correct mounting holes, the key point is to keep the back-panel of the mainboard in a close fit with your system case, as shown below.

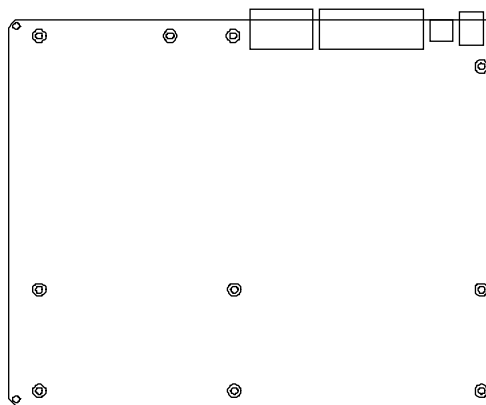

2. After deciding on the proper mounting holes, position the studs between the frame of the chassis and the mainboard. The studs are used to fix the mainboard and to keep a certain distance between the system chassis and the mainboard, in order to avoid any electrical shorts between the board and the metal frame of the chassis. (If your computer case is already equipped with mounting studs, you will need to tighten screws to attach the mainboard.)

Note: In most computer housings, you will be able to find 4 or more attachment points to install mounting studs and then fix the mainboard. If there aren't enough matching holes, then make sure to install at least 4 mounting studs to ensure proper attachment of the mainboard.

Step 6

Connect Front Panel Switches/LEDs/Speaker/USB

You can find there are several different cables already existing in the system case and originating from the computer's front-panel devices (HDD LED, Power LED, Reset Switch, PC Speaker, or USB devices etc.) These cables serve to connect the front-panel switches, LEDs, and USB connectors to the mainboard's front-panel connectors group (J5 and JUSB1/2), as shown below.

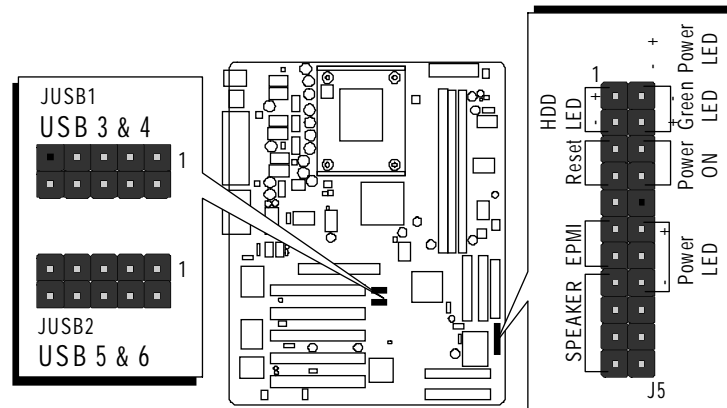

1. Hardware Reset Switch Button (Reset)

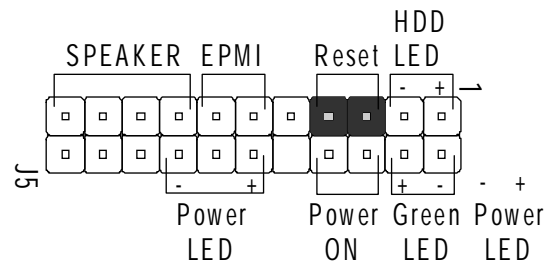

2. HDD-LED (HDD LED)

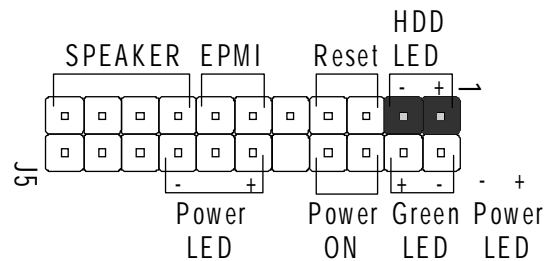

3. Green-LED/Power-LED (Green LED/Power LED)

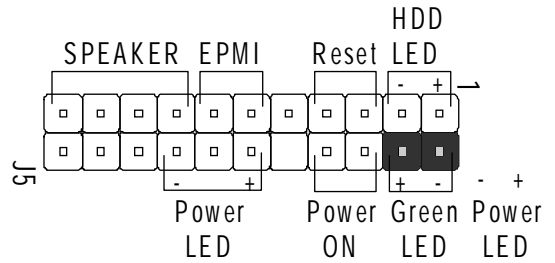

4. System Management Interface Button (EPMI)

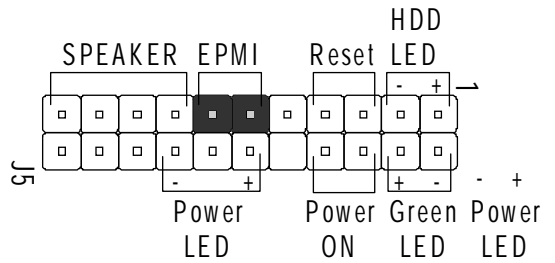

5. ATX Soft Power On/Off (Power ON)

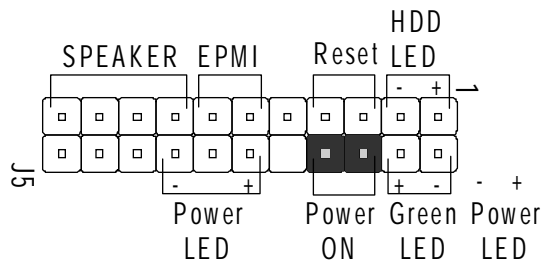

6. Power LED (Power LED)

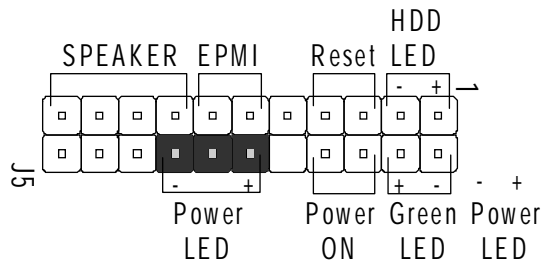

7. PC Speaker (SPEAKER)

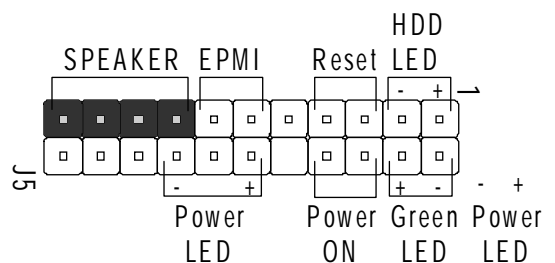

8. Extended USB Header

USB port 3 / 5

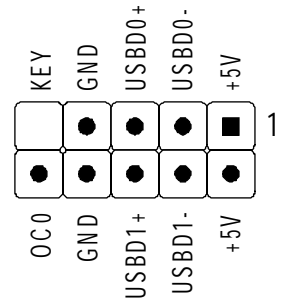

USB port 4 / 6

Step 7

Connect IDE, IDE RAID (AV45GTR only), and Floppy Disk Drives

- 1. IDE cable connector

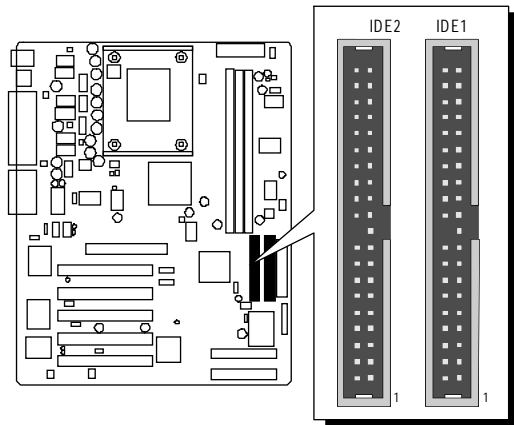

- 2. IDE RAID cable connector (AV45GTR only)

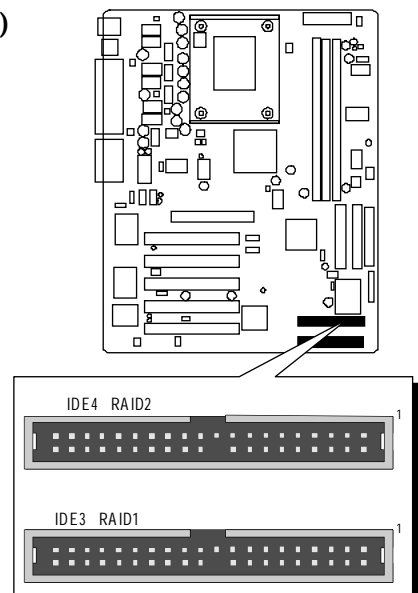

3. Floppy cable connector

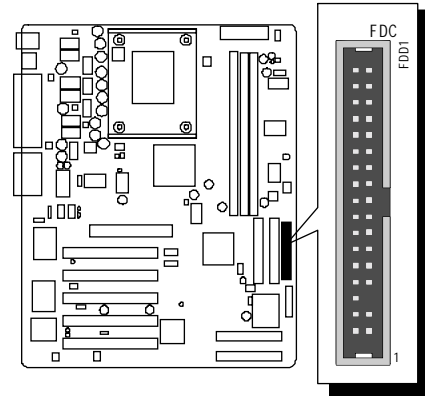

Step 8

Connect Other Internal Peripherals

1. CD-IN , Auxiliary-IN, Bass/Center-Out connectors

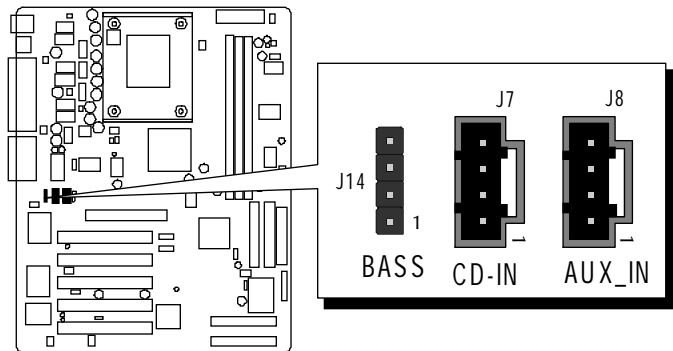

2. IR header

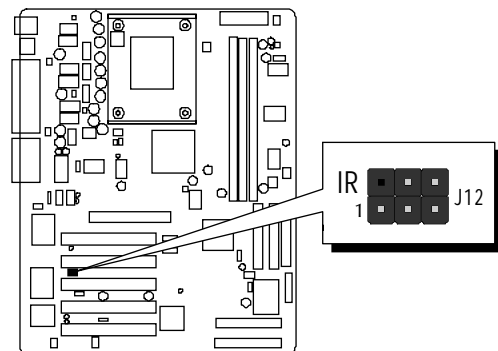

Step 9

Connect the Power Supply

1. System power connector

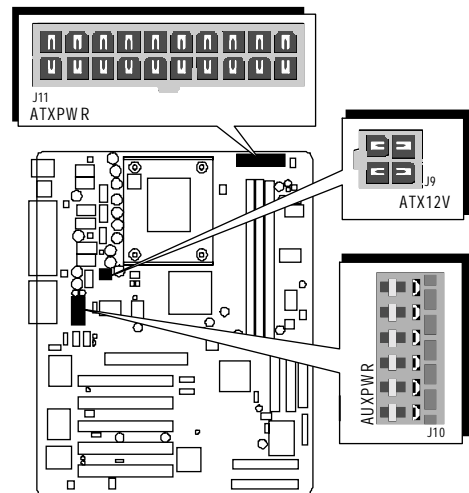

Step 10

Install Add-on Cards in Expansion Slots

1. Accelerated Graphics Port (AGP) Card

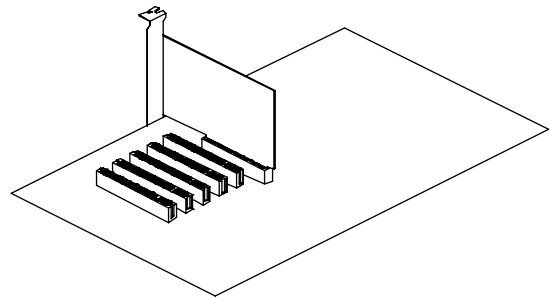

2. PCI Card

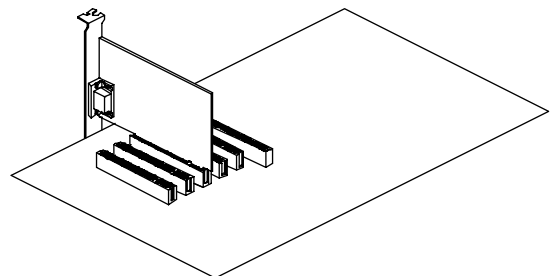

Step 11

Connect External Peripherals to Back-Panel

You are now ready to put the computer case back together and get on to the external peripherals connections to your system's back-panel.

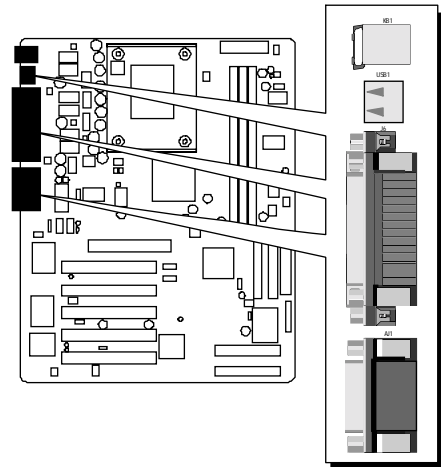

1. PS/2 Mouse and PS/2 Keyboard

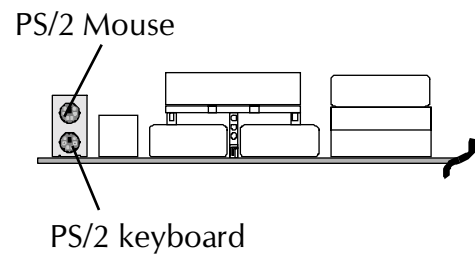

2. USB Ports

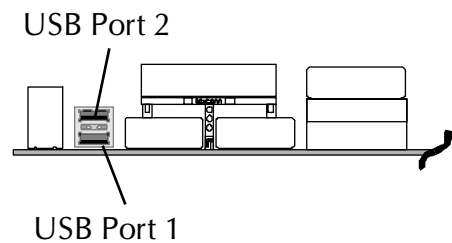

3. COM Ports

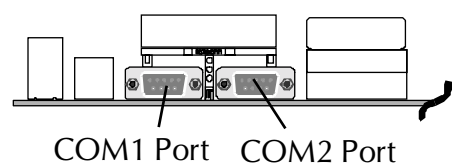

4. Parallel Port

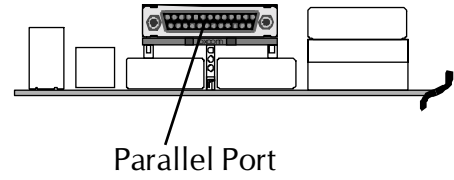

5. MIDI/GAME Port

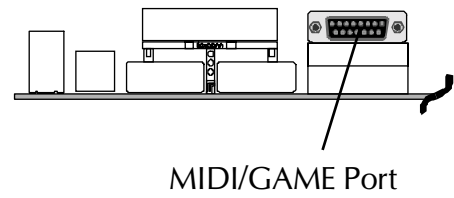

6. Audio Line-Out (Front-Out) /Line-In (Rear-Out) / Mic-In Ports

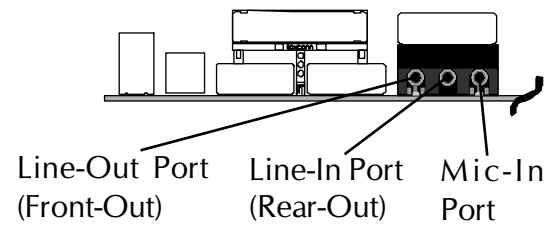

Step 12

First Time System Boot Up

To assure the completeness and correctness of your system installation, you may check the above installation steps once again before you boot up your system for the first time.

1. Insert a bootable system floppy disk (DOS 6.2x, Windows 95/98/NT, or others) which contains FDISK and FORMAT utilities into the FDD.
2. Turn on the system power.
3. First, you must use the FDISK utility to create a primary partition of the hard disk. You can also add an extended partition if your primary partition does not use all of the available hard disk space. If you choose to add an extended partition, you will have to create one or more logical partitions to occupy all the space available to the extended partition. The FDISK utility will assign a drive letter (i.e., C:, D:, E:,...) to each partition which will be shown in the FDISK program. After FDISK procedure, reboot your system by using the same system floppy disk.

Note: DOS 6.2x and Windows 95A can only support up to 2.1GB of HDD partition. If you use the FDISK utility with one of the operating systems mentioned above, you can only install your HDD into partitions no larger than 2.1GB each.

4. Now, use the FORMAT utility to format all the partitions you've created. When formatting the primary partition (C:), make sure to use the `FORMAT C: /S` command.

Note: `FORMAT C: /S` can transfer all the necessary system files into the primary partition of your hard disk. Then, your HDD will become a bootable drive.

5. Install all the necessary drivers for CD-ROM, Mouse, etc.
6. Setup the complete operating system according to your OS installation guide.

Step 13

Install Drivers & Software Components

Please note that all the system utilities and drivers are designed for Win 9x / 2000/ME/NT operating systems only. Make sure your operating system is already installed before running the drivers installation CD-ROM programs.

1. Insert the AV45GT/AV45GTR bundled CD-ROM into your CD-ROM drive. The auto-run program will display the drivers main installation window on screen.
2. Select the "Install Mainboard Software" bar to run into sub-menu.
3. Choose "Install VIA Driver" and complete it.
4. Choose "Install CMedia Driver" and complete it.
5. Choose "Install Highpoint RAID Driver" bar to run readme windows if you need install drivers. **(AV45GTR only)**
6. Choose "Install RAID Utility" bar to install RAID utility drivers. **(AV45GTR only)**
7. Return to the main installation window and exit from the auto-run drivers installation program.

Note: Please refer to IDE Raid Manual to install IDE RAID Controller driver when you purchase **AV45GTR** mainboard.

3.2 Jumper Settings

Several hardware settings are made through the use of mini jumpers to connect jumper pins on the mainboard. Pin #1 could be located at any corner of each jumper, you just find the location with a white right angle which stands for pin 1#. There are several types of pin 1# shown as below:

3-pin and multi (> 3) pin jumpers shown as following:

Pin #1 to the left:



Pin #1 on the top:





Pin #1 to the right:



Pin #1 on the bottom:



Jumpers with two pins are shown as  for Close [On] or  for Open [Off]. To Short jumper pins, simply place a plastic mini jumpers over the desired pair of pins.

Caution!

1. Do not remove the mainboard from its antistatic protective packaging until you are ready to install it.
2. Carefully hold the mainboard by its edges and avoid touching its components. When putting the mainboard down, place it on top of its original packaging film, on an even surface, and components side up.
3. Wear an antistatic wrist strap or take other suitable measures to prevent electrostatic discharge (ESD) whenever handling this equipment.

Jumpers & Connectors Guide

Use the mainboard layout on page 11 to locate CPU socket, memory banks, expansion slots, jumpers and connectors on the mainboard during the installation. The following list will help you to identify jumpers, slots, and connectors along with their assigned functions:

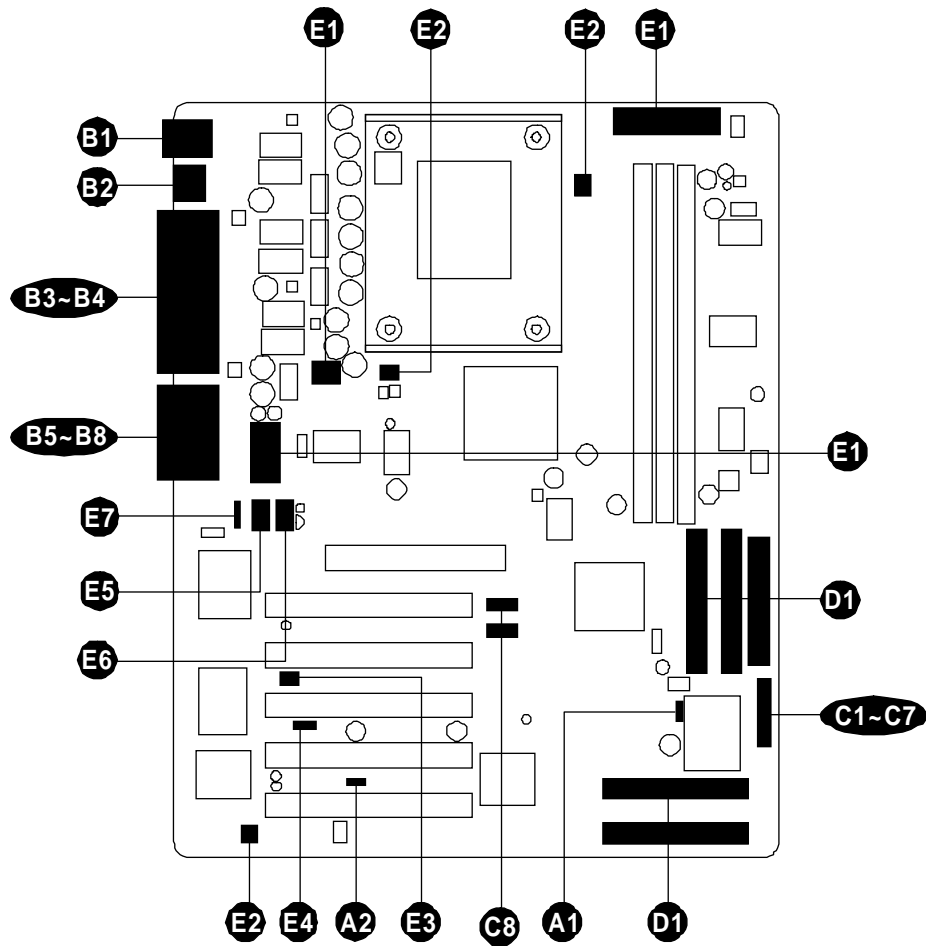

CPU/Memory/Expansion Slots

- | | |
|-----------|--|
| Socket478 | : CPU Socket for Pentium 4 processors |
| DIMM1/2/3 | : Three DIMM Slots for 64, 128, 256, 512 MB, and 1GB of 2.5V DDR SDRAM (The total installed memory does not exceed 3GB) |
| AGP | : One AGP (Accelerated Graphics Port) Slot |
| PCI | : Five 32-bit PCI Expansion Slots |

Jumpers

- A1** JP1 : Clear CMOS setting
- A2** JP2 : On board RAID Enable/Disable Setting (**AV45GTR only**)

Back Panel Connectors

- B1** KB : PS/2 keyboard port
- B1** MS : PS/2 mouse port
- B2** USB : 2 USB (Universal Serial Bus) ports
- B3** COM1/2 : Serial ports 1/2 (DB9 male)
- B4** PRINTER : Parallel port (DB25 female)
- B5** LINE_OUT : Line-Out (Front-Out) port
- B6** LINE_IN : Line-In (Rear-Out) port
- B7** MIC_IN : Mic-In port
- B8** GAME/MIDI : GAME/MIDI port

Front Panel Connectors

- C1** Power ON : ATX power on/off momentary type switch
- C2** EPMI : System Management Interface
- C3** Green LED/Power LED : Green LED (ON when system stays in power saving mode) / System Power LED
- C4** HDD LED : IDE drive active LED
- C5** Power LED : System power LED
- C6** Reset : Hardware reset switch
- C7** SPEAKER : Internal speaker in housing
- C8** JUSB1/2 : Extended USB header

Internal Peripherals Connectors

- D1** FDD1 : Floppy disk drive interface
- D1** IDE1 : IDE primary interface (Dual-channel)
- D1** IDE2 : IDE secondary interface (Dual-channel)
- D1** RAID1 : RAID primary interface (Dual-channel) (**AV45GTR only**)
- D1** RAID2 : RAID secondary interface (Dual-channel) (**AV45GTR only**)

Other Connectors

- E1** J9/J10/J11 : ATX power connector
- E2** FAN1 : CPU fan connector
- E2** FAN2 : System fan connector
- E2** FAN3 : Chipset fan connector
- E3** J12 : IR connector
- E4** WOL1 : Wake-On-LAN connector
- E5** J7 : CD_IN connector
- E6** J8 : Auxiliary_IN connector
- E7** J14 : Bass/Center_Out connector

👉 **Jumpers**

A1 Clear CMOS Setting (JP1)

JP1 is used to clear CMOS data. Clearing CMOS will result in the permanently erasing previous system configuration settings and the restoring original (factory-set) system settings.

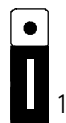

Pin 1-2 (Default)



Pin 2-3 (Clear CMOS)

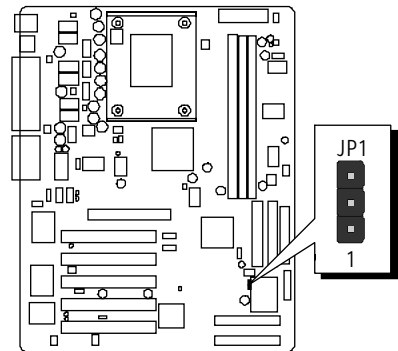

- Step 1.** Turn off the system power (PC-> Off).
- Step 2.** Remove ATX Power cable from ATX Power connector.
- Step 3.** Remove jumper cap from JP1 pins 1-2.
- Step 4.** Place the jumper cap on JP1 pin 2-3 for a few seconds.
- Step 5.** Return the jumper cap to pin 1-2.
- Step 6.** Plug ATX Power cable into ATX Power connector.
- Step 7.** Turn on the system power (PC-> On).

A2 On board RAID Enable/Disable Setting (JP2) (AV45GTR only)

JP2 is used to enable/disable IDE RAID controller.

You may choose to place jumper cap on pins 1-2 for enable IDE RAID controller function; inserting jumper cap on pins 2-3 for disable IDE RAID controller function.



Pin 2-3

To disable IDE RAID function



Pin 1-2

To enable IDE RAID function

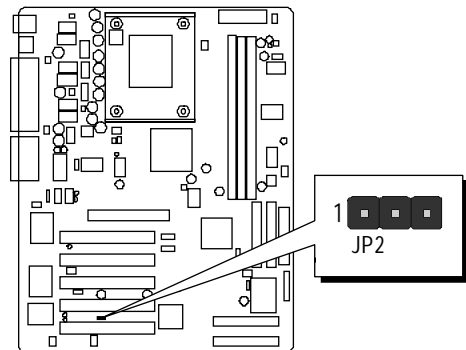

Note: Please refer to IDE Raid Manual to check information about IDE RAID Controller.

☞ **Back-Panel Connectors**

B1 PS/2 Keyboard & PS/2 Mouse Connectors

Two 6-pin female PS/2 keyboard & Mouse connectors are located at the rear panel of the mainboard. Depending on the computer housing you use (desktop or tower), the PS/2 Mouse connector is situated at the top of the PS/2 Keyboard connector when the mainboard is laid into a desktop, as opposed to a tower where the PS/2 Mouse connector is located at the right of the PS/2 Keyboard's. Plug the PS/2 keyboard and mouse jacks into their corresponding connectors.

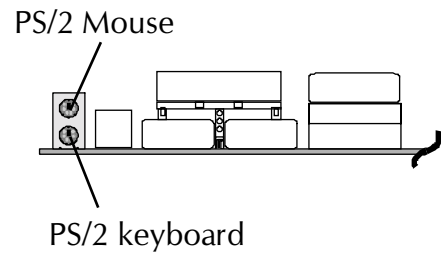

B2 USB1/USB2 Port Connectors

This mainboard offers 2 USB ports on back panel. Plug each USB device jack into an available USB1/USB2 connector.

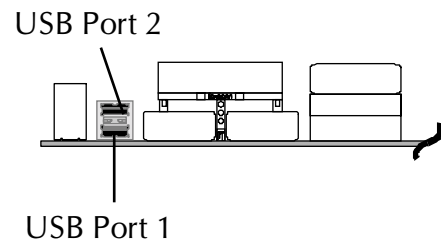

B3 COM1/2 Port Connectors

This mainboard can accommodate two serial device on COM1/2. Attach a serial device cable to the DB9 serial port COM1/2 at the back panel of your computer.

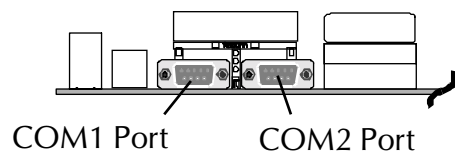

B4 Parallel Port Connector

One DB25 female parallel connector is located at the rear panel of the mainboard. Plug the connection cable from your parallel device (printer, scanner, etc.) into this connector.

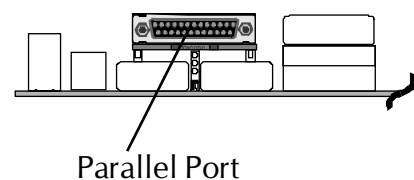

B5 Line-Out (Front-Out) Port Connector

Line-Out is a stereo output port through which the combined signal of all internal and external audio sources on the board is output. It can be connected to 1/8-inch TRS stereo headphones or to amplified speakers

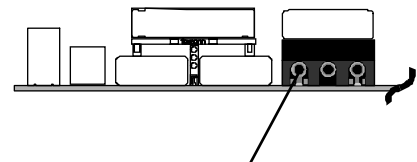

Line-Out (Front-Out) Port

B6 Line-In (Rear-Out) Port Connector

Line-In is a stereo line-level input port that accepts a 1/8-inch TRS stereo plug. It can be used as a source for digital sound recording, a source to be mixed with the output, or both.

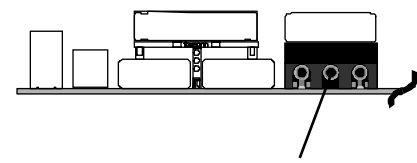

Line-In (Rear-Out) Port

B7 Mic-In Port Connector

Mic-In is a 1/8-inch jack that provides a mono input. It can use a dynamic mono or stereo microphone with a resistance of not more than 600 Ohms.

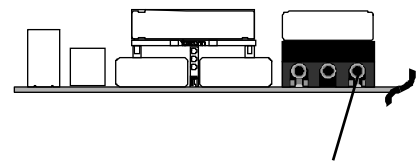

Mic-in Port

B8 MIDI/GAME Port Connector

The MIDI/GAME port is a 15-pin female connector. This port can be connected to any IBM PC compatible game with a 15-pin D-sub connector.

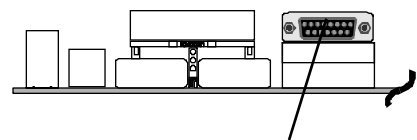

MIDI/GAME Port

MIDI Instrument Connection

You will need a MIDI adapter to connect a MIDI compatible instrument to the sound card. The MIDI adapter can in turn be connected to the Joystick/MIDI port. You will also need the MIDI sequencing software to run MIDI instruments with your computer etc. into this connector.

☞ **Front-Panel Connectors**

① ATX Power On/Off Switch Connector (Power ON)

The Power On/Off Switch is a momentary type switch used for turning on or off the system ATX power supply. Attach the connector cable from the Power Switch to the 2-pin (Power ON) header on the mainboard.

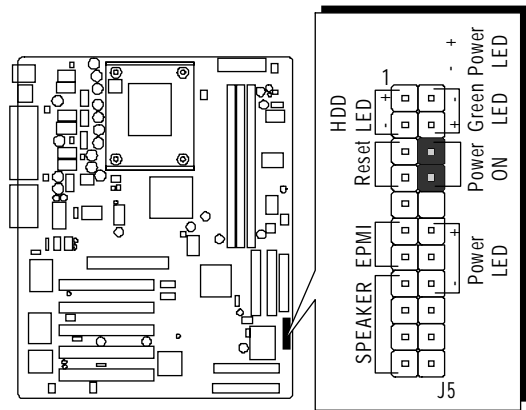

Note: Please notice all the LED connectors are directional. If your chassis's LED does not light up during running, please simply change to the opposite direction.

② EPMI Connector (EPMI)

Hardware System Management Interface (EPMI) header may attach to 2-pin momentary switch. Press the switch to force system into power saving mode; press it again to resume back the normal operation situation.

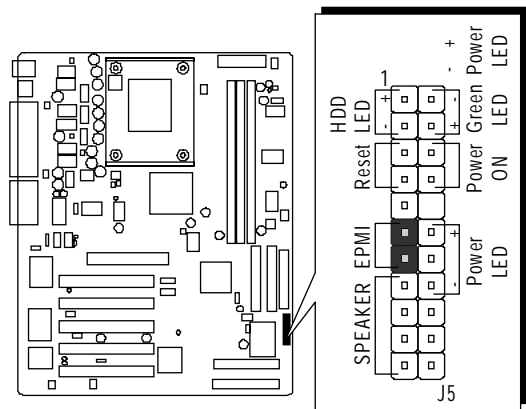

③ Green LED/Power LED Connector (Green LED/Power LED)

This header is dual color LED function.

Dual color LED function is defined by either Power LED or Green LED, the header can be in these states.

The Green LED indicates that the system is currently in one of the power saving mode (Doze/Standby/Suspend). When the system resumes to normal operation mode, the Green LED will go off, Power LED on.

This Power LED will go off during Power saving mode.

Attach a 2-pin Green LED/Power LED cable to (Green LED/Power LED) header.

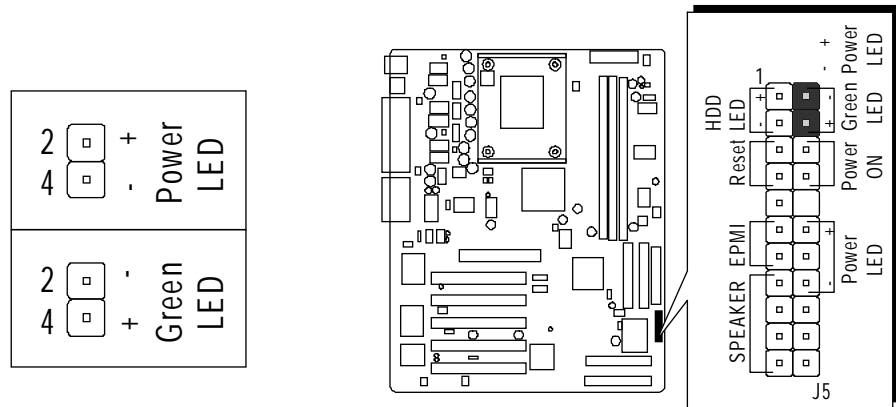

④ HDD LED Connector (HDD LED)

Attach the connector cable from the IDE device LED to the 2-pin (HDD LED) header. The HDD LED lights up whenever an IDE device is active.

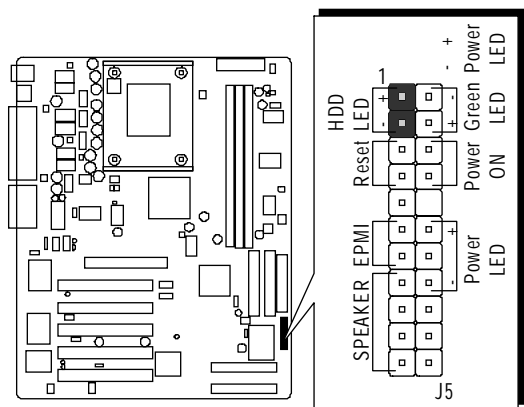

⑤ Power LED Connector (Power LED)

Attach the 3-pin Power LED connector cable from the housing front panel to the (Power LED) header on the mainboard. The power LED stays light while the system is on.

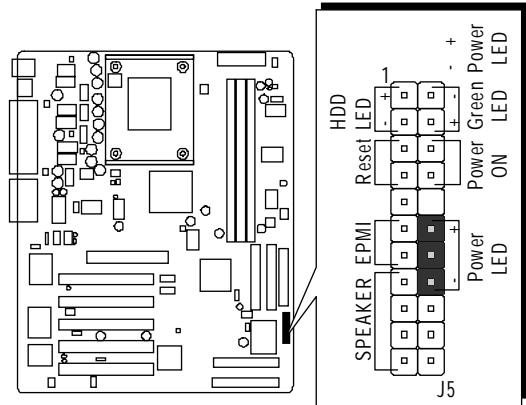

⑥ Hardware Reset Connector (Reset)

Attach the 2-pin hardware reset switch cable to the (Reset) header. Pressing the reset switch causes the system to restart.

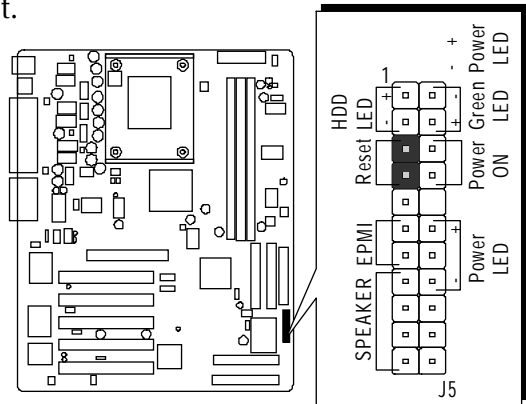

⑦ Speaker Connector (SPEAKER)

Attach the PC speaker cable from the case to the 4-pin speaker connector (SPEAKER).

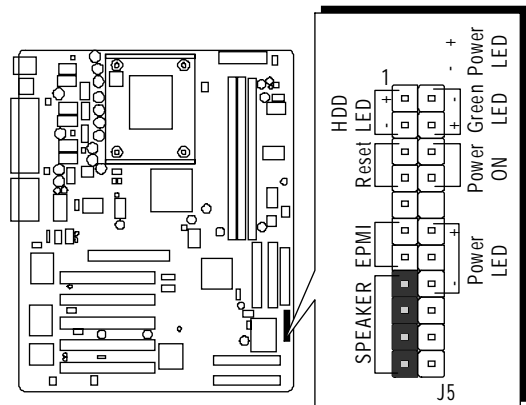

③ Extended USB Headers (JUSB1/2)

The headers are used to connect the cable attached to USB connectors which are mounted on front-panel or back-panel. But the USB cable is optional at the time of purchase.

USB port 3 / 5

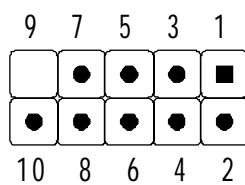

USB port 4 / 6

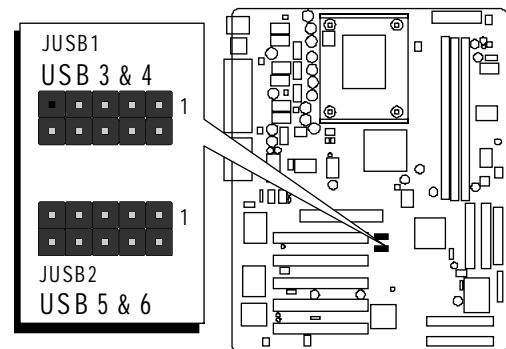

Pins Assignment:

1 = +5V

3 = USBD0-

5 = USBD0+

7 = GND

9 = KEY

2 = +5V

4 = USBD1-

6 = USBD1+

8 = GND

10 = OC0

☞ **Internal Peripherals Connectors**

① Enhanced IDE, IDE RAID (AV45GTR only), and Floppy Connectors

The mainboard features two 40-pin dual-channel IDE device connectors (IDE1/IDE2) providing support for up to four IDE devices, such as CD-ROM and Hard Disk Drives (H.D.D.) and features two 40-pin dual-channel IDE RAID device connectors (RAID1/RAID2) providing support for up to four IDE devices, such as Hard Disk Drives (H.D.D.).

This mainboard also includes one 34-pin floppy disk controller (FDD1) to accommodate the Floppy Disk Drive (FDD). Moreover, this mainboard comes with one 80-pin ATA **100/66/33** ribbon cable to connect to IDE (RAID) H.D.D. and one 34-pin ribbon cable for F.D.D. connection.

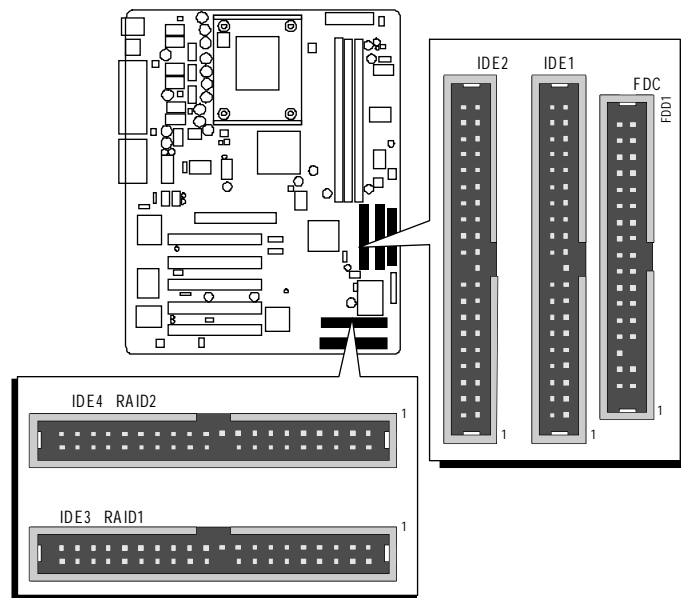

Note : If you used RAID1 connector, please refer to **IDE RAID Manual** to setup RAID BIOS program.

Important: Ribbon cables are directional, therefore, make sure to always connect with the red cable.

☞ **Other Connectors**

Ⓜ ATX Power Supply Connector (J9, J10, and J11)

This motherboard uses 20-pin Pentium 4 standard ATX power header, J11 and comes with another two headers.

One is J10 with 6-pin Aux VccNcc3 ATX power supply header.

Another is J9 with 2X2-pin + 12 VPC ATX power supply header.

Please make sure you plug in the right direction.

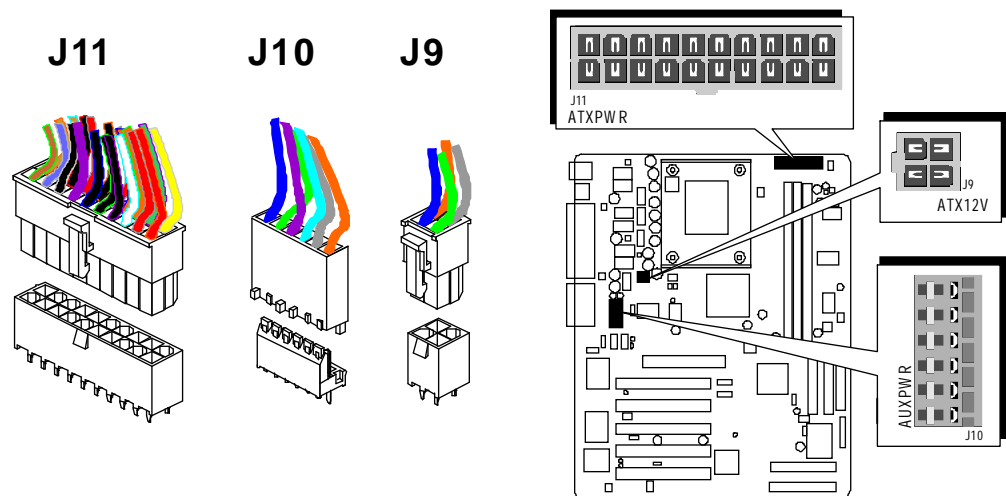

A traditional ATX system should remain at power off stage when AC power resumes from power failure. In such case, if there is no an UPS to keep power-on, the kind of design is inconvenient for a network server or workstation. However, this motherboard implements an AC Power Auto Recovery function to solve this problem. You may enable the function "PWRON After PWR-Fail" that is under sub-menu of "Power Mangement Setup" through BIOS setup program.

- Note 1:** The ATX power connector is directional and will not go in unless the guides match perfectly making sure that pin#1 is properly positioned.
- Note 2:** Make sure the latch of the ATX power connector clicks into place to ensure a solid attachment.
- Note 3:** Your ATX power supply must be supplied to ACPI +5V standby power and at least 720mA compatible.
- Note 4:** Make sure your power supply have enough power for higher speed processor installed.

② CPU, Chipset and Chassis Fan connectors - FAN1/2/3

The mainboard provides three onboard 12V cooling fan power connectors to support CPU (FAN1), System (FAN2) or Chipset (FAN3) cooling fans.

Note:

Both cable wiring and type of plug may vary, which depends on the fan maker. Keep in mind that the red wire should always be connected to the +12V header and the black wire to the ground (GND) header.

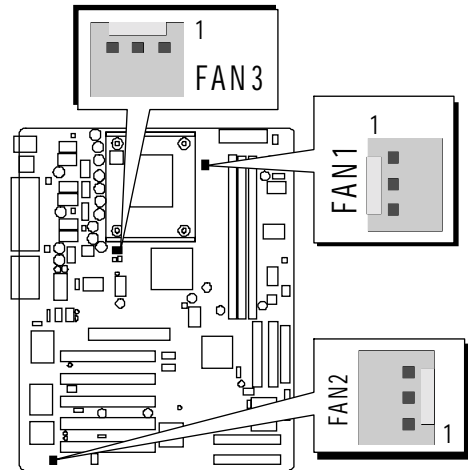
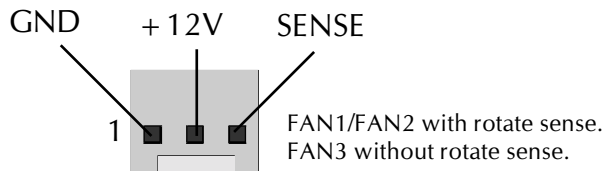

③ IR Header (J12)

If you have an Infrared device, this mainboard can implement IR transfer function. To enable the IR transfer function, follow these steps:

Pins Assignment:

1 = NC

2 = KEY

3 = +5V

4 = GND

5 = IRTX

6 = IRRX

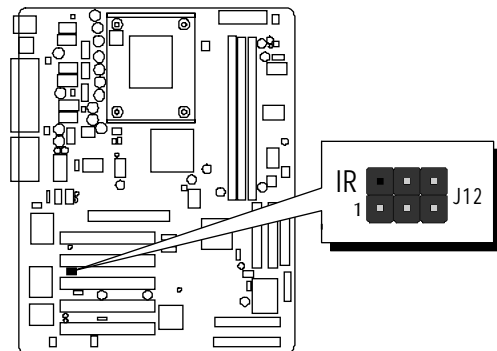
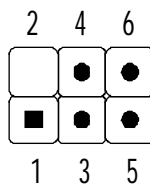

Note: Before connect your IR device, please be sure each IR on board pin allocation is matchable with the pin of the IR device. Otherwise, incorrect IR connection may do damage to your IR device.

Step 1. Attach the 6-pin infrared device cable to J12.
(Refer to the above diagram for IR pin assignment.)

Step 2. Configure the Infrared transfer mode in field "UART Mode Select" of "Super I/O Device" of "Integrated Peripherals" sub-menu in BIOS setup program. This mainboard supports IrDA and Normal transfer modes.

E4 Wake-On-LAN Connector (WOL1)

Attach a 3-pin connector through the LAN card which supports the Wake-On-LAN (WOL1) function. This function lets users wake up the connected system through the LAN card.

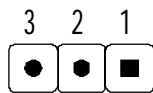

Pins Assignment:

1 = Power 2 = GND
3 = RING#

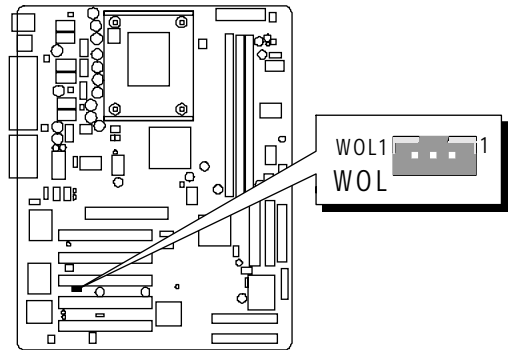

E5 Audio CD_IN Connector (J7) (Black)

Port J7 is used to attach an audio connector cable from the CD-ROM drive.

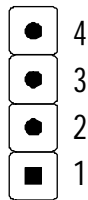

Pin Assignments:

1 = CD-L 2 = CD-GND
3 = CD-GND 4 = CD-R

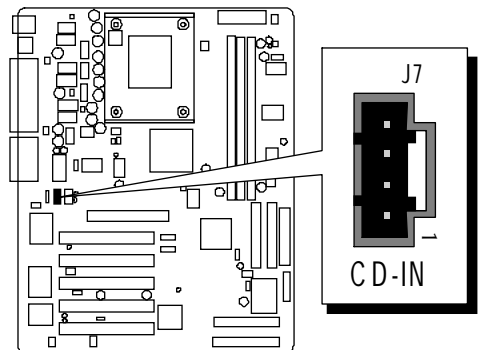

E6 Audio AUXILIARY_IN Connector (J8) (White)

Port J8 can be used to connect a stereo audio input from CD-ROM, TV-tuner or MPEG card.

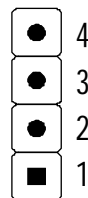

Pin Assignments:

1 = AUXL 2 = AGND
3 = AGND 4 = AUXR

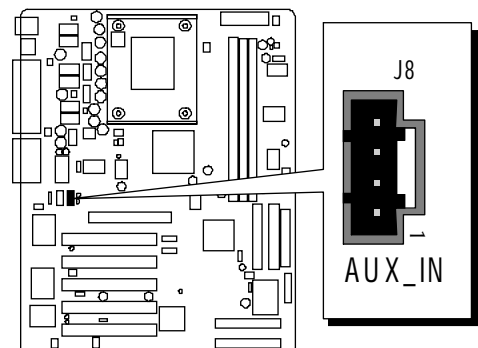

Audio Bass/Center_Out Header (J14)

J14 header can be used to connect the cable which attached to bass/center amplified speakers.

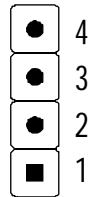

Pin Assignments:

1 = CENTER

2 = CD-GND

3 = CD-GND

4 = BASS

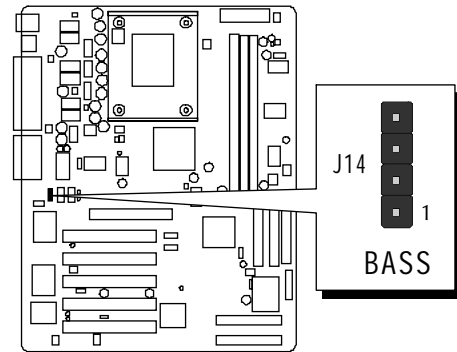

3.3 System Memory Configuration

The AV45GT/AV45GTR mainboard has three 184-pin DIMM banks that allow you to install from 64MB up to 3GB of system memory.

Each **184-pin** DIMM (Dual In-line Memory Module) bank can accommodate 64MB, 128MB, 256MB, 512MB, and 1GB of PC1600/PC2100 compliant 2.5V single or double side 64-bit wide data path DDR SDRAM modules. DIMM slots are arranged in three banks, each memory bank made of one bank and providing a 64-bit wide data path.

1. Install Memory:

Install memory in any or all of the banks. The combination shown as follows.

| DIMM Slot | Memory Modules | Module Quantity |
|-----------|---|-----------------|
| DIMM 1 | 64MB, 128MB, 256MB, 512M and 1GB, 184-pin 2.5V DDR SDRAM DIMM | x 1 |
| DIMM 2 | 64MB, 128MB, 256MB, 512M and 1GB, 184-pin 2.5V DDR SDRAM DIMM | x 1 |
| DIMM 3 | 64MB, 128MB, 256MB, 512M and 1GB, 184-pin 2.5V DDR SDRAM DIMM | x 1 |

Maximum installed memory is 3GB.

Note: You do not need to set any jumper to configure memory since the BIOS utility can detect the system memory automatically. You can check the total system memory value in the BIOS Standard CMOS Setup menu.

2. Upgrade Memory:

You can easily upgrade the system memory by inserting additional DDR SDRAM modules in available DIMM banks. The total system memory is calculated by simply adding up the memory in all DIMM banks. After upgrade, the new system memory value will automatically be computed and displayed in the field "Standard CMOS Setup" of BIOS setup program.

4 SOFTWARE UTILITY

4.1 Mainboard CD Overview

Note: The CD contents attached in AV45GT/AV45GTR mainboard are subject to change without notice.

To start your mainboard CD disc, just insert it into your CD-ROM drive and the CD AutoRun screen should appear. If the AutoRun screen does not appear, double click or run D:\Autorun.exe (assuming that your CD-ROM drive is drive D:)

Navigation Bar Description:

- ☞ **Install Mainboard AV45GT Software** - Installing VIA 4-IN-1 and Hardware Audio drivers.
- ☞ **Install Mainboard AV45GTR Software** - Installing VIA 4-IN-1, Hardware Audio drivers, IDE RAID driver installation Guide, and RAID Utility.
- ☞ **Manual** - AV45GT/AV45GTR Series mainboard and IDE RAID (AV45GTR only) user's manual in PDF format.
- ☞ **Link to Shuttle Homepage** - Link to shuttle website homepage.
- ☞ **Browse this CD** - Allows you to see contents of this CD.
- ☞ **Quit** - Close this CD.

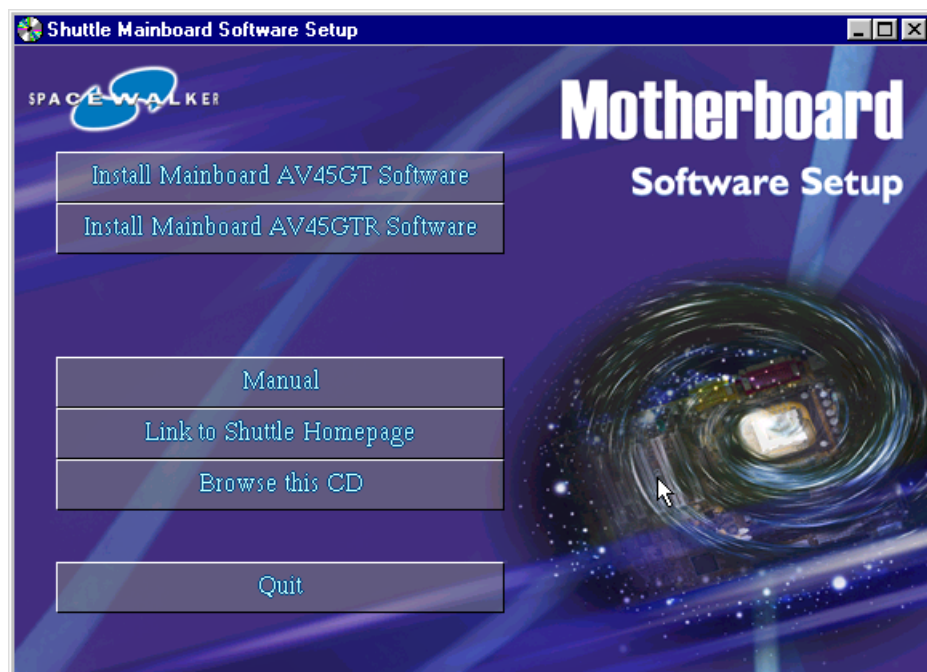

4.2 Install Mainboard Software

Insert the attached CD into your CD-ROM drive and the CD AutoRun screen should appear. If the AutoRun screen does not appear, double click on Autorun icon in **My Computer** to bring up **Shuttle Mainboard Software Setup** screen.

Select using your pointing device (e.g. mouse) on the “**Install Mainboard AV45GT Software**” or “**Install Mainboard AV45GTR Software**” bar to run into sub-menu.

The **Mainboard AV45GT Software** include:

- [4.2.A] Install VIA Driver
- [4.2.B] Install CMedia Driver



The **Mainboard AV45GTR Software** include:

- [4.2.A] Install VIA Driver
- [4.2.B] Install CMedia Driver
- [4.2.C] Install Highpoint RAID Driver
- Install RAID Utility



4.2.A Install VIA 4-in-1 Driver

Select using your pointing device (e.g. mouse) on the “Install VIA Driver” bar to install 4-in-1 driver.



AV45GT



AV45GTR

Once you made your selection, a Setup window run the installation automatically.

When the copying files is done, make sure you **reboot** the system to take the installation effect.

4.2.B Install Audio Driver

Select using your pointing device (e.g. mouse) on the “Install CMedia Driver” bar to install audio driver.

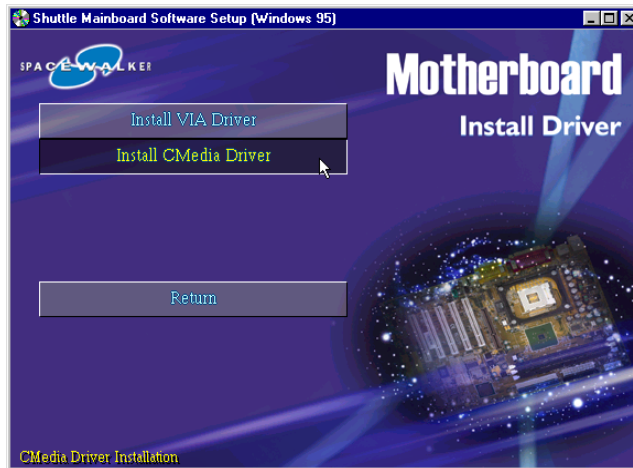

AV45GT



AV45GTR

Once you made your selection, a Setup window run the installation automatically.

When the copying files is done, make sure you **reboot** the system to take the installation effect.

4.2.C Install IDE RAID Driver and Utility (AV45GTR only)

Select using your pointing device (e.g. mouse) on the "Install Highpoint RAID Driver" bar.

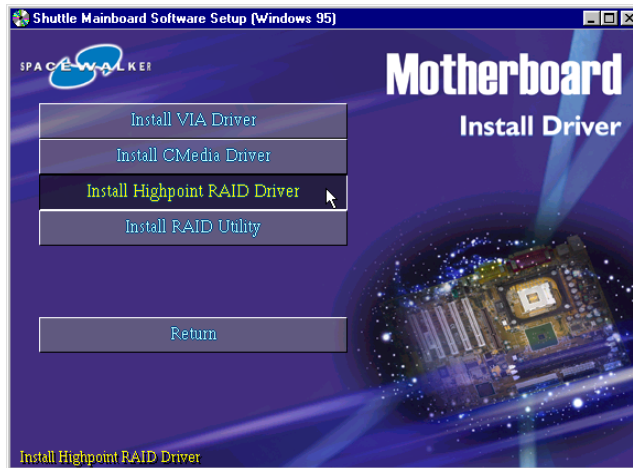

AV45GTR

Because the IDE RAID driver can't be setup automatically, please follow below instructions to complete the installation.

Then click on "Install RAID Utility" bar to install IDE RAID Utility.



AV45GTR

Once you made your selection, a Setup window runs the installation automatically.

When the copying files is done, make sure you **reboot** the system to take the installation effect.

4.3 View the User's Manual

Insert the attached CD into your CD-ROM drive and the CD AutoRun screen should appear. If the AutoRun screen does not appear, double click on AutoRun icon in **My Computer** to bring up **Shuttle Mainboard Software Setup** screen.

Select using your pointing device (e.g. mouse) on the "Manual" bar.



Then **Online Information** windows will appear on your screen. Click on the "Install Acrobat Reader" bar if you need to install acrobe reader.



Then click on "AV45GT/AV45GTR Manual" bar to view user's manual, and click on "IDE Raid Manual" bar to view IDE RAID user's manual. **(AV45GTR only)**

5 BIOS SETUP

AV45GT/AV45GTR BIOS ROM has a built-in Setup program that allows users to modify the basic system configuration. This information is stored in battery-backed RAM so that it retains the Setup information even if the system power is turned off.

The system BIOS is managing and executing a variety of hardware related functions in the system, including:

System date and time

Hardware execution sequence

Power management functions

Allocation of system resources

5.1 Enter the BIOS

To enter the BIOS (Basic Input / Output System) utility, follow these steps:

- Step 1.** Power on the computer, and the system will perform its POST (Power-On Self Test) routine checks.
- Step 2.** Press key immediately, or at the following message:
“Press DEL to enter SETUP”
,or simultaneously press <Ctrl>, <Alt>, <Esc> keys

Note 1. If you miss trains of words meationed in step2 (the message disappears before you can respond) and you still wish to enter BIOS Setup, restart the system and try again by turning the computer OFF and ON again or by pressing the <RESET> switch located at the computer’s front-panel. You may also reboot by simultaneously pressing the <Ctrl>, <Alt>, keys.

Note 2. If you do not press the keys in time and system does not boot, the screen will prompt an error message, and you will be given the following options:

“Press F1 to Continue, DEL to Enter Setup”

- Step 3.** As you enter the BIOS program, the CMOS Setup Utility will prompt you the Main Menu, as shown in the next section.

5.2 The Main Menu

Once you enter the AwardBIOS(tm) CMOS Setup Utility, the Main Menu will appear on the screen. The Main Menu allows you to select from several setup functions and two exit choices. Use the arrow keys to select among the items and press <Enter> to accept and enter the sub-menu.

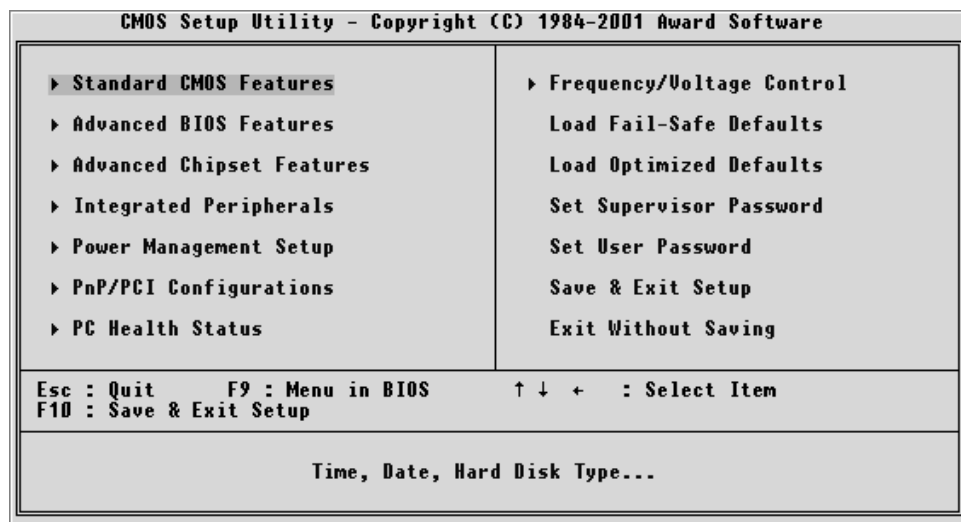

Note that a brief description of each highlighted selection appears at the bottom of the screen.

Setup Items

The main menu includes the following main setup categories. Recall that some systems may not include all entries.

Standard CMOS Features

Use this menu for basic system configuration.

Advanced BIOS Features

Use this menu to set the Advanced Features available on your system.

Advanced Chipset Features

Use this menu to change the values in the chipset registers and optimize your system's performance.

Integrated Peripherals

Use this menu to specify your settings for integrated peripherals.

Power Management Setup

Use this menu to specify your settings for power management.

PnP / PCI Configurations

This entry appears if your system supports PnP / PCI.

PC Health Status

This entry shows the current system temperature, Voltage, and FAN speed.

Frequency/Voltage Control

Use this menu to specify your settings for frequency/voltage control.

Load Fail-Safe Defaults

Use this menu to load the BIOS default values for the minimal/stable performance of your system to operate.

Load Optimized Defaults

Use this menu to load the BIOS default values that are factory-set for optimal performance system operation. While Award has designed the custom BIOS to maximize performance, the factory has the right to change these defaults to meet users' needs.

Supervisor / User Password

Use this menu to change, set, or disable supervisor/user password. It allows you to limit access to the system and Setup, or only to Setup.

Save & Exit Setup

Save CMOS value changes in CMOS and exit from setup.

Exit Without Saving

Abandon all CMOS value changes and exit from setup.



Standard CMOS Features

The items in Standard CMOS Setup Menu are divided into 10 categories. Each category includes no, one or more than one setup items. Use the arrow keys to highlight the item and then use the <PgUp> or <PgDn> keys to select the value you want in each item.

| CMOS Setup Utility - Copyright (C) 1984-2001 Award Software | | Item Help |
|---|------------------|---|
| Standard CMOS Features | | |
| Date (mm:dd:yy) | Mon, Oct 8 2001 | Menu Level ▶ Change the day, month, year and century |
| Time (hh:mm:ss) | 13 : 46 : 58 | |
| ▶ IDE Primary Master | | |
| ▶ IDE Primary Slave | | |
| ▶ IDE Secondary Master | | |
| ▶ IDE Secondary Slave | | |
| Drive A | [1.44M, 3.5 in.] | |
| Drive B | [None] | |
| Video | [EGA/VGA] | |
| Halt On | [All Errors] | |
| Base Memory | 640K | |
| Extended Memory | 65472K | |
| Total Memory | 1024K | |
| ↑↓:Move Enter:Select +/-/PU/PD:Value F10:Save ESC:Exit F1:General Help F5: Previous Values F6: Fail-Safe Defaults F7: Optimized Defaults | | |

Date

<Month> <DD> <YYYY>

Set the system date. Note that the 'Day' automatically changes when you set the date.

Time

<HH : MM : SS>

The time is converted based on the 24-hour military-time clock. For example, 5 p.m. is 17:00:00.

IDE Primary Master

Options are in its sub-menu.

Press <Enter> to enter the sub-menu of detailed options.

IDE Primary Slave

Options are in its sub-menu.

Press <Enter> to enter the sub-menu of detailed options.

IDE Secondary Master

Options are in its sub-menu.

Press <Enter> to enter the sub-menu of detailed options.

IDE Secondary Slave

Options are in its sub menu.

Press <Enter> to enter the sub-menu of detailed options.

Drive A/Drive B

Select the type of floppy disk drive installed in your system.

- The choice: None, 360K, 5.25 in, 1.2M, 5.25 in, 720K, 3.5 in, 1.44M, 3.5 in, or 2.88M, 3.5 in.

Video

Select the default video device.

- The choice: EGA/VGA, CGA 40, CGA 80, or MONO.

Halt On

Select the situation in which you want the BIOS to stop the POST process and notify you.

- The choice: All Errors, No Errors, All, But Keyboard, All, But Diskette, or All, But Disk/Key.

Base Memory

Displays the amount of conventional memory detected during boot up.

- The choice: N/A.

Extended Memory

Displays the amount of extended memory detected during boot up.

- The choice: N/A.

Total Memory

Displays the total memory available in the system.

- The choice: N/A.

IDE Adapters

The IDE adapters control the hard disk drive. Use a separate sub-menu to configure each hard disk drive.

IDE HDD Auto-Detection

Press <Enter> to auto-detect HDD on this channel. If detection is successful, it fills the remaining fields on this menu.

- Press Enter

IDE Primary Master

Selecting 'manual' lets you set the remaining fields on this screen and select the type of fixed disk. "User Type" will let you select the number of cylinders, heads, etc., Note: PRECOMP = 65535 means NONE!

- The choice: None, Auto, or Manual.

Access Mode

Choose the access mode for this hard disk.

- The choice: CHS, LBA, Large, or Auto.

Capacity

Disk drive capacity (Approximated). Note that this size is usually slightly greater than the size of a formatted disk given by a disk checking program.

- Auto-Display your disk drive size.

The following options are selectable only if the 'IDE Primary Master' item is set to 'Manual'

Cylinder

Set the number of cylinders for this hard disk.

- Min = 0, Max = 65535

Head

Set the number of read/write heads.

- Min = 0, Max = 255

Precomp

Warning: Setting a value of 65535 means no hard disk.

➤ Min = 0, Max = 65535

Landing zone

Set the Landing zone size.

➤ Min = 0, Max = 65535

Sector

Number of sector per track.

➤ Min = 0, Max = 255



Advanced BIOS Features

This section allows you to configure your system for basic operation. You have the opportunity to select the system's default speed, boot-up sequence, keyboard operation, shadowing, and security.

| CMOS Setup Utility - Copyright (C) 1984-2001 Award Software | | |
|---|-------------|--|
| Advanced BIOS Features | | |
| Virus Warning | [Disabled] | Item Help Menu Level ▶ Allows you to choose the VIRUS warning feature for IDE Hard Disk boot sector protection. If this function is enabled and someone attempt to write data into this area , BIOS will show a warning message on screen and alarm beep |
| CPU L1 & L2 Cache | [Enabled] | |
| CPU L2 Cache ECC Checking | [Enabled] | |
| Quick Power On Self Test | [Enabled] | |
| RAID & SCSI Boot Order | [RAID,SCSI] | |
| First Boot Device | [Floppy] | |
| Second Boot Device | [HDD-0] | |
| Third Boot Device | [LS120] | |
| Boot Other Device | [Enabled] | |
| Swap Floppy Drive | [Disabled] | |
| Boot Up Floppy Seek | [Enabled] | |
| Boot Up NumLock Status | [On] | |
| Typematic Rate Setting | [Enabled] | |
| Typematic Rate (Chars/Sec) | [6] | |
| Typematic Delay (Msec) | [250] | |
| Security Option | [Setup] | |
| OS Select For DRAM > 64MB | [Non-OS2] | |
| Video BIOS Shadow | [Enabled] | |
| Small Logo(EPA) Show | [Enabled] | |
| Onboard RAID Boot ROM | [Enabled] | |

↑↓:Move Enter:Select +/-/PU/PD:Value F10:Save ESC:Exit F1:General Help
F5: Previous Values F6: Fail-Safe Defaults F7: Optimized Defaults

Virus Warning

Allows you to choose the VIRUS Warning feature for IDE Hard Disk boot sector protection. If this function is enables and someone attempts to write data into this area, BIOS will show a warning message on screen, and an alarm beep.

Enabled Activates automatically when the system boots up, causing a warning message to appear when anything attempts to access the boot sector or hard disk partition table.

Disabled No warning message will appear when anything attempts to access the boot sector or hard disk partition table.

➤ The choice: Enabled or Disabled.

CPU L1 & L2 Cache

This item enables CPU L1 internal and L2 secondary cache to speed up memory access.

➤ The choice: Enabled or Disabled.

CPU L2 Cache ECC Checking

When you select Enabled, memory checking is enabled when the CPU internal L2 cache contains ECC SRAMs.

- The choice: Enabled or Disabled.

Quick Power On Self Test

This item speeds up Power-On Self Test (POST) after you power on the computer. If it is set to enabled, BIOS will shorten or skip some check items during POST.

- The choice: Enabled, or Disabled.

RAID & SCSI Boot Order

The item select RAID and SCSI boot order.

- The Choice: RAID, SCSI or SCSI, RAID.

First/Second/Third Boot Device

The BIOS attempts to load the operating system from the devices in the sequence selected in these items.

- The Choice: Floppy, LS120, HDD-0, SCSI, CDROM, , HDD-1, HDD-2, HDD-3, ZIP100, LAN, or Disabled.

Boot Other Device

Select Your Boot Device Priority.

- The choice: Enabled or Disabled.

Swap Floppy Drive

If the system has two floppy drives, you can swap the logical drive name assignment.

- The choice: Enabled or Disabled.

Boot Up Floppy Seek

Seeks disk drives during boot-up. Disabling speed boots up.

- The choice: Enabled or Disabled.

Boot Up NumLock Status

Selects power-on state for NumLock.

- The choice: Off or On.

Typematic Rate Setting

Keystrokes repeat at a rate determined by the keyboard controller. When this controller enabled, the typematic rate and typematic delay can be selected.

- The choice: Enabled or Disabled.

Typematic Rate (Chars/Sec)

This item sets how many times the keystroke will be repeated in a second when you hold the key down.

- The choice: 6, 8, 10, 12, 15, 20, 24, or 30.

Typematic Delay (Msec)

Sets the delay time after the key is held down before it begins to repeat the keystroke.

- The choice: 250, 500, 750, or 1000.

Security Option

Select whether the password is required every time the system boots or only when you enter setup.

System The system will not boot and access to Setup will be denied if the correct password is not entered promptly.

Setup The system will boot, but access to Setup will be denied if the correct password is not entered promptly.

- The choice: System or Setup.

Note: To disabled security, select PASSWORD SETTING at Main Menu, and then you will be asked to enter password. Do not type anything and just press <Enter> ; it will disable security. Once the security is disabled, the system will boot, and you can enter Setup freely.

OS Select For DRAM > 64MB

Selects the operating system that is running with greater than 64MB of RAM in the system.

- The choice: Non-OS2 or OS2.

Video BIOS Shadow

Determines whether video BIOS will be copied to RAM. However, it is optional depending on chipset design. Video Shadow will increase the video speed.

- The choice: Enabled or Disabled.

Small Logo(EPA) Show

This item allows you to enable/disable the EPA Logo.

- The choice: Enabled or Disabled.

Onboard RAID Boot ROM

This item allows you to enable/disable onboard RAID boot ROM.

- The choice: Enabled or Disabled.



Advanced Chipset Features

This section allows you to configure the system based on the specific features of the installed chipset. This chipset manages bus speeds and access to system memory resources, such as DRAM and the external cache. It also coordinates communications between the conventional ISA bus and the PCI bus. It states that these items should never need to be altered.

The default settings have been chosen because they provide the best operating conditions for your system. If you discovered that data was being lost while using your system, you might consider making any changes.

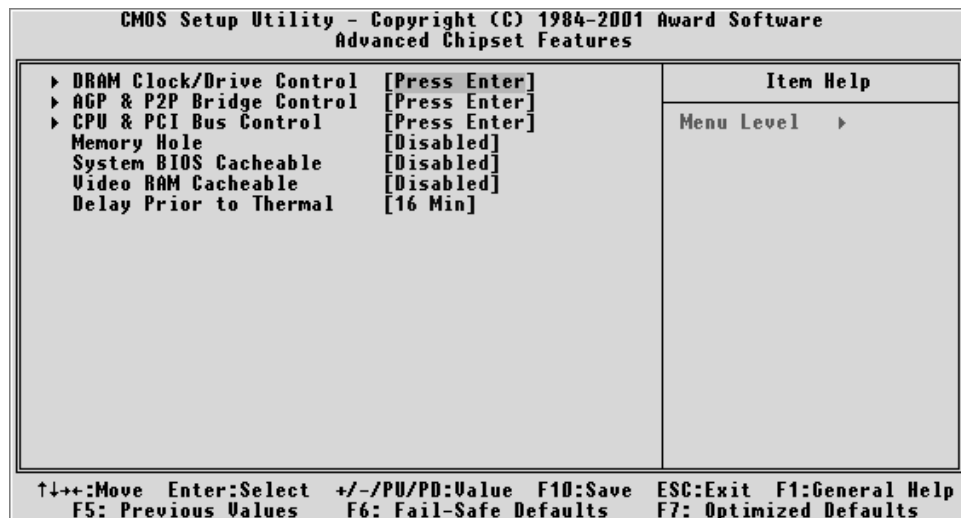

DRAM Clock/Drive Control

Options are in its sub-menu.

Press <Enter> to enter the sub-menu of detailed options.

Current FSB Frequency

This item show Current CPU Front Side Bus speed.

Current DRAM Frequency

This item show Current DRAM speed.

DRAM Clock

This item allows you to control the DRAM speed.

➤ The Choice: 100MHz, 133MHz, or By SPD.

DRAM Timing

This item allows you to select the value in this field, depending on whether the board using which kind of DDR DRAM.

- The Choice: Manual or By SPD.

SDRAM CAS Latency

When synchronous DRAM is installed, the number of clock cycles of CAS latency depends on the DRAM timing. Do not reset this field from the default value specified by the system designer.

- The Choice: 2.5 or 2

Bank Interleave

The interleave number of internal banks, can be set to 2 way, 4 way interleave or disabled. For VCM and 16Mb type dram chips, the bank interleave is fixed at 2 way interleave.

When the dram timing is selected by SPD, it will be set by the value on SPD of the RAM module(SDR).

- The Choice: Disabled, 2 Bank, or 4 Bank.

Precharge to Active (Trp)

This item allows you to Precharge Command to Active Command Period.

- The Choice: 2T or 3T.

Active to Precharge (Tras)

This item allows you to Active Command to Precharge Command Period.

- The Choice: 5T or 6T.

Active to CMD (Trcd)

This item allows you to Active to CMD.

- The Choice: 2T or 3T.

DRAM Command Rate

This item allows you to select the DRAM executed rate.

- The Choice: 2T Command or 1T Command.

DRAM Burst Len

This item allows you to select Dram Burst Length.

- The Choice: 4 or 8.

APG & P2P Bridge Control

Options are in its sub-menu.

Press <Enter> to enter the sub-menu of detailed options.

AGP Aperture Size (MB)

Select the size of Accelerated Graphics Port (AGP) aperture. The aperture is a portion of the PCI memory address range dedicated to graphics memory address space. Host cycles that hit the aperture range are forwarded to the AGP without any translation.

➤ The Choice: 4M, 8M, 16M, 32M, 64M, 128M, or 256M.

AGP Mode

This item allows you to select the AGP Mode.

➤ The Choice: 1x, 2x, or 4x.

AGP Fast Write

This item enables an end user to manually select the AGP output buffer drive strength.

➤ The Choice: Enabled or Disabled.

AGP Master 1 WS Write

When this item enabled, writing to the AGP(Accelerated Graphics Port) is executed with one wait state.

➤ The Choice: Enabled or Disabled.

AGP Master 1 WS Read

When this item enabled, reading from the AGP (Accelerated Graphics Port) is executed with one wait state.

➤ The Choice: Enabled or Disabled.

CPU & PCI Bus Control

Options are in its sub-menu.

Press <Enter> to enter the sub-menu of detailed options.

CPU to PCI Write Buffer

When this field is Enabled, the writing from CPU to PCI bus is buffered, to compensate for the speed differences between the CPU and the PCI bus. When Disabled, the writing is are not buffered and the CPU must wait until the write is complete before starting another write cycle.

➤ The Choice: Enabled or Disabled.

PCI Master 0 WS Write

When this item enabled, writing to the AGP bus is executed with zero wait state.

- The Choice: Enabled or Disabled.

PCI Delay Transaction

The chipset has an embedded 32-bit posted write buffer to support delay transactions cycles. Select Enabled to support compliance with PCI specification version 2.1.

- The Choice: Enabled or Disabled.

Memory Hole

In order to improve performance, some space in memory can be reserved for ISA cards.

- The Choice: Disabled or 15M-16M.

System BIOS Cacheable

Selecting Enabled allows caching of the system BIOS ROM at F0000h-FFFFFh, resulting in better system performance. However, if any program is written to this memory area, a system error may result.

- The choice: Enabled or Disabled.

Video RAM Cacheable

Selecting Enabled allows caching of the video RAM, resulting in better system performance. However, if any program is written to this memory area, a system error may result.

- The Choice: Enabled or Disabled.

Delay Prior to Thermal

This item select the Delay time before thermal controller activate from temperature too high.

- The Choice: 4 Min, 8 Min, 16 Min, or 32 Min.



Integrated Peripherals

| CMOS Setup Utility - Copyright (C) 1984-2001 Award Software | | |
|---|---------------|--------------|
| Integrated Peripherals | | |
| ▶ VIA OnChip IDE Device | [Press Enter] | Item Help |
| ▶ SuperIO Device | [Press Enter] | |
| Init Display First | [PCI Slot] | Menu Level ▶ |
| OnChip USB Controller | [All Enabled] | |
| USB Keyboard Support | [Disabled] | |
| Onboard Audio Device | [Enabled] | |
| Onboard RAID | [Enabled] | |
| IDE HDD Block Mode | [Enabled] | |

↑↓→←:Move Enter:Select +/-/PU/PD:Value F10:Save ESC:Exit F1:General Help
F5: Previous Values F6: Fail-Safe Defaults F7: Optimized Defaults

VIA OnChip IDE Device

Options are in its sub-menu.

Press <Enter> to enter the sub-menu of detailed options.

OnChip IDE Channel0

The chipset contains a PCI IDE interface with support to two IDE channels. Select Enabled to activate the primary IDE interface; select Disabled to deactivate this interface

➤ The choice: Enabled or Disabled.

OnChip IDE Channel1

The chipset contains a PCI IDE interface with support to two IDE channels. Select Enabled to activate the secondary IDE interface; select Disabled to deactivate this interface

➤ The choice: Enabled or Disabled.

IDE Prefetch Mode

The onboard IDE drive interfaces support IDE prefetching for faster drive access. If you install a primary and/or secondary add-on IDE interface, set this field to Disabled if the interface does not support prefetching.

➤ The choice: Enabled or Disabled.

Primary/Secondary Master/Slave PIO

The four IDE PIO (Programmed Input/Output) fields let you set a PIO mode (0-4) for each of the four IDE devices that the onboard IDE interface supports. Modes 0 through 4 provide successively increased performance. In Auto mode, the system automatically determines the best mode for each device.

- The choice: Auto, Mode 0, Mode 1, Mode 2, Mode 3, or Mode 4.

Primary/Secondary Master/Slave UDMA

Ultra DMA/100 implementation is possible only if your IDE hard drive supports it and the operating environment includes a DMA driver (Windows 95 OSR2 or a third-party IDE bus master driver). If both of your hard drive and your system software support Ultra DMA/100, select Auto to enable BIOS support.

- The choice: Auto or Disabled.

Super IO Device

Options are in its sub-menu.

Press <Enter> to enter the sub-menu of detailed options.

Onboard FDC Controller

Select Enabled if your system has a floppy disk controller (FDC) installed on the system board and you want to use it. If you install add-on FDC or the system has no floppy drive, select Disabled in this field.

- The choice: Enabled or Disabled.

Onboard Serial Port1/Port2

Select an address and corresponding interrupt for the first and second serial ports.

- The choice: 3E8/IRQ4, 2E8/IRQ3, 3F8/IRQ4, 2F8/IRQ3, Auto, or Disabled.

UART Mode Select

This item allows you to select which mode for the Onboard Serial Port 2.

- The choice: IrDA or Normal.

UR2 Duplex Mode

This item allows you to select the IR half/full duplex function.

- The choice: Full or Half.

Onboard Parallel Port

This item allows you to determine onboard parallel port controller I/O address setting.

- The choice:: 378/IRQ7, 278/IRQ5, 3BC/IRQ7, or Disabled.

Parallel Port Mode

Select an operating mode for the onboard parallel (printer) port. Select Normal, Compatible, or SPP unless you are certain your hardware and software both support one of the other available modes.

- The choice: SPP, EPP, ECP, or ECP + EPP.

ECP Mode Use DMA

Select a DMA channel for the parallel port for use during ECP mode.

- The choice: 1 or 3.

Init Display First

This item allows you to decide to activate PCI Slot or on-chip VGA first.

- The choice: PCI Slot or AGP.

OnChip USB Controller

This should be enabled if your system has a USB installed on the system board and you want to use it. Even when on chip USB so equipped, if you add a higher performance controller, you will need to disable this feature.

- The Choice: All Disabled, All Enabled, 1&2 USB Port, 2&3 USB Port, 1&3 USB Port, 1 USB Port, 2 USB Port, or 3 USB Port.

USB Keyboard Support

Select Enabled if your system contains a Universal Serial Bus (USB) controller and you have a USB keyboard.

- The Choice: Enabled or Disabled.

Onboard Audio Device

This item allows you to enable/disable on board audio device.

- The Choice: Enabled or Disabled.

Onboard RAID

This item allows you to enable/disable on board RAID device.

- The Choice: Enabled or Disabled.

IDE HDD Block Mode

Block mode is also called block transfer, multiple commands, or multiple sector read/write. If your IDE hard drive supports block mode (most new drives do), select Enabled for automatic detection of the optimal number of block read/write per sector the drive can support.

- The choice: Enabled or Disabled

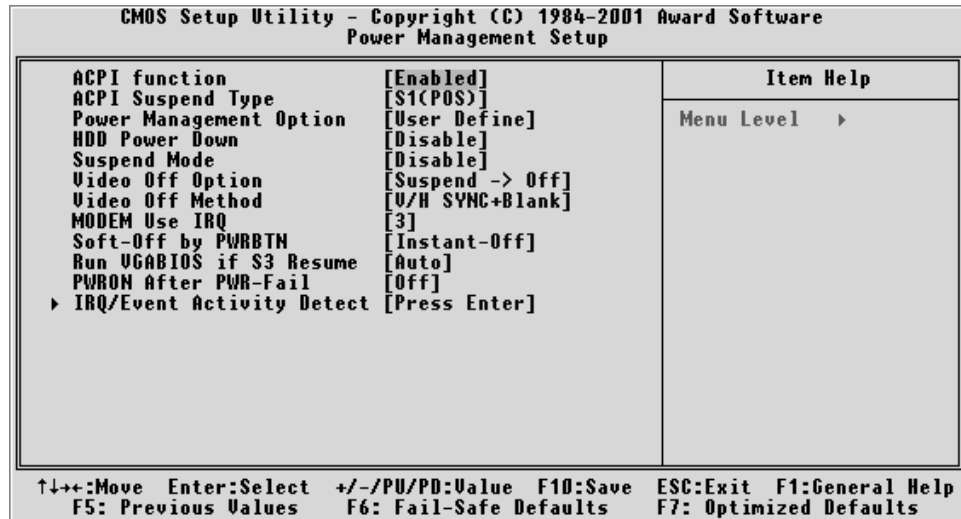
 **Power Management Setup**

The Power Management Setup allows you to configure your system to most effectively saving energy while operating in a manner consistent with your own style of computer use.

ACPI Function

This item allows you to enable/disable the Advanced Configuration and Power Management (ACPI)

- The choice: Enabled or Disabled.

ACPI Suspend Type

This item allows you to select sleep state when suspend.

- The choice: S1(POS), S3(STR), or S1 & S3.

Power Management Option

This category allows you to select the type (or degree) of power saving mode settings.

Min Saving Minimum power management.
HDD Power Down = Allows you to set each mode individually.

Suspend Mode = 1 hr.

Max Saving Maximum power management.
HDD Power Down = Allows you to set each mode individually.

Suspend Mode = 1 min.

-
- User Define** Allows you to set each mode individually.
HDD Power Down = Disabled or 1 min. ~ 15min.
Suspend Mode = Disabled or 1 min ~ 1 hr.
- The choice: User Define, Min Saving, or Max Saving.

HDD Power Down

- When this item enabled and after the set up time of system inactivity, the hard disk drive will be powered down while all other devices remain active.
- The choice: Disabled or 1 Min ~ 15 Min.

Suspend Mode

- When this item enabled and after the set up time of system inactivity, all devices except the CPU will be shut off.
- The choice: Disabled, 1 Min, 2 Min, 4 Min, 6 Min, 8 Min, 10 Min, 20 Min, 30 Min, 40 Min, or 1 Hour.

Video Off Option

When enabled, this feature allows the VGA adapter to operate in a power saving mode.

- Always On** Monitor will remain on during power saving mode.
- Suspend --> Off** Monitor is blanked when the system enters the Suspend mode.
- The choice: Always On , or Suspend -> off.

Video Off Method

This determines the manner in which the monitor is blanked.

- V/H SYNC + Blank** This selection will cause the system to turn off the vertical and horizontal synchronization ports and write blanks to the video buffer.
- Blank Screen** This option only writes blanks to the video buffer.
- DPMS Support** Initial display power management signaling.
- The choice: V/H SYNC + Blank, Blank Screen, or DPMS Support.

MODEM Use IRQ

- This determines the IRQ which the MODEM can use.
- The choice: 3, 4, 5, 7, 9, 10, 11, or N/A.

Soft-Off by PWRBTN

Pressing the power button for more than 4 seconds forces the system to enter the Soft-Off state when the system has "hung".

- The choice: Instant-Off or Delay 4 Sec.

Run VGABIOS if S3 Resume

This item Enable/Disable VGA BIOS execution when resume from S3. It's for some legacy AGP driver compatibility.

- The choice: Auto, Yes, or No.

PWRON After PWR- Fail

This allows you to set whether you want your system to reboot after power has been interrupted.

- The choice: Off, On, or Former-Sts.

IRQ/Event Activity Detect

Options are in its sub-menu.

Press <Enter> to enter the sub-menu of detailed options.

VGA

When this item enabled, you can set VGA to awaken the system.

- The choice: OFF or ON

LPT & COM

When LPT & COM stays On, any activity from one of the listed system peripheral devices or IRQs wakes up the system.

- The choice: NONE, LPT, COM, or LPT/COM

HDD & FDD

When HDD & FDD stays On, any activity from one of the listed system peripheral devices wakes up the system.

- The choice: OFF or ON

PCI Master

When PCI Master stays On, any activity from one of the listed system peripheral devices wakes up the system.

- The choice: OFF, or ON

PowerOn by PCI Card

This item enables/disables the power on function of PCI Card.

- The choice: Disabled or Enabled.

Wake Up On LAN/Ring

When this item enabled, any event occurring Modem Ring/activity of LAN will awaken a system which has been powered down.

- The choice: Disabled or Enabled.

RTC Alarm Resume

When this item enabled, you can set the date and time at which the RTC (real-time clock) alarm awakens the system from Suspend mode.

- The choice: Disabled or Enabled.

Data (of Month)

This item selects the alarm date.

- Key in a DEC number:Min = 0, Max = 31.

Resume Time (hh:mm:ss)

This item selects the alarm Time.

[hh]

- Key in a DEC number:Min = 0, Max = 23.

[mm/ss]

- Key in a DEC number:Min = 0, Max = 59.

IRQs Activity Monitoring

Primary INTR

Press Enter to on/off the wake up ability of a specified IRQ.

- The choice: OFF, or ON.

In the following is a list of IRQ's, Interrupt ReQuests, which can be exempted much as the COM ports and LPT ports above can. When an I/O device wants to gain the attention of the operating system, it signals this by causing an IRQ to occur. When the operating system is ready to respond to the request, it interrupts itself and performs the service.

When On mode exist, activity will neither prevent the system from going into a power management mode nor awaken it.

IRQ3 (COM 2)

IRQ4 (COM 1)

IRQ5 (LPT 2)

IRQ6 (Floppy Disk)

IRQ7 (LPT 1)

IRQ8 (RTC Alarm)

IRQ9 (IRQ2 Redir)

IRQ10 (Reserved)

IRQ11 (Reserved)

IRQ12 (PS / 2 Mouse)

IRQ13 (Coprocesor)

IRQ14 (Hard Disk)

IRQ15 (Reserved)

- The choice: Disabled or Enabled.

 **PnP/PCI Configurations**

| CMOS Setup Utility - Copyright (C) 1984-2001 Award Software | | PnP/PCI Configurations | |
|---|---------------|--|--|
| PNP OS Installed | [No] | Item Help Menu Level ▶ Select Yes if you are using a Plug and Play capable operating system. Select No if you need the BIOS to configure non-boot devices. | |
| Reset Configuration Data | [Disabled] | | |
| Resources Controlled By | [Manual] | | |
| ▶ IRQ Resources | [Press Enter] | | |
| PCI/VGA Palette Snoop | [Disabled] | | |
| Assign IRQ For VGA | [Enabled] | | |
| Assign IRQ For USB | [Enabled] | | |
| INT Pin 1 Assignment | [Auto] | | |
| INT Pin 2 Assignment | [Auto] | | |
| INT Pin 3 Assignment | [Auto] | | |
| INT Pin 4 Assignment | [Auto] | | |

↑↓+:-:Move Enter:Select +/-/PU/PD:Value F10:Save ESC:Exit F1:General Help
F5: Previous Values F6: Fail-Safe Defaults F7: Optimized Defaults

This section describes the configuration of PCI bus system. PCI or Personal Computer Interconnection is a system which allows I/O devices to operate at the speed CPU itself keeps when CPU communicating with its own special components.

This section covers some very technical items, and it is strongly recommended that only experienced users should make any changes to the default settings.

PNP OS Installed

This item allows you to determine PnP OS is installed or not.

- The choice: Yes or No.

Reset Configuration Data

Normally, you leave this field Disabled. Select Enabled to reset Extended System Configuration Data (ESCD) when you exit from Setup if you have installed a new device or software and the system reconfiguration has caused such a serious conflict that the operating system can not boot.

- The choice: Enabled or Disabled .

Resource controlled By

The Award Plug-and-Play BIOS has the capacity to automatically configure all of the boot and Plug-and-Play compatible devices. However, this capability means absolutely nothing unless you are using a Plug-and-Play operating system such as Windows 95.

If you set this field to "manual" , choose specific resources by going into each of the sub-menu that follows this field (a sub-menu is proceeded by a ">").

- The choice: Auto(ESCD) or Manual.

IRQ Resources

When resources are controlled manually, assign each system interrupt a type, depending on the type of device using the interrupt.

IRQ3/4/5/7/9/10/11/12/14/15 assigned

This item allows you to determine the IRQ assigned to the ISA bus and is not available to any PCI slot. Legacy ISA for devices is compliant with the original PC AT bus specification; PCI/ISA PnP for devices is compliant with the Plug-and-Play standard whether designed for PCI or ISA bus architecture.

- The choice: PCI Device or Reserved.

PCI/VGA Palette Snoop

It determines whether the MPEG ISA/VESA VGA Cards can work with PCI/VGA or not. If you have MPEG ISA/VESA VGA Cards and PCI/VGA Card worked, Enable this field. Otherwise, please Disable it.

- The choice: Enabled or Disabled.

Assign IRQ For VGA

This item allows the user to set VGA IRQ Routing table Enabled or Disabled.

- The choice: Enabled or Disabled.

Assign IRQ For USB

This item allows the user the option to assign an IRQ to on-board USB controller.

Since the on-board controller is always enabled, if no IRQ is assigned to it, there will be a question mark report on the sytem device under Windows95/98.

- The choice: Enabled or Disabled.

INT Pin1/2/3/4 Assignment

Names the interrupt request (IRQ) line assigned to PCI 1 throught PCI 4 on system. Activity of selected PCI slot awakens system.

- The Choice: Auto, 3, 4, 5, 7, 9, 10, 11, 12, 14, 15.

 **PC Health Status**

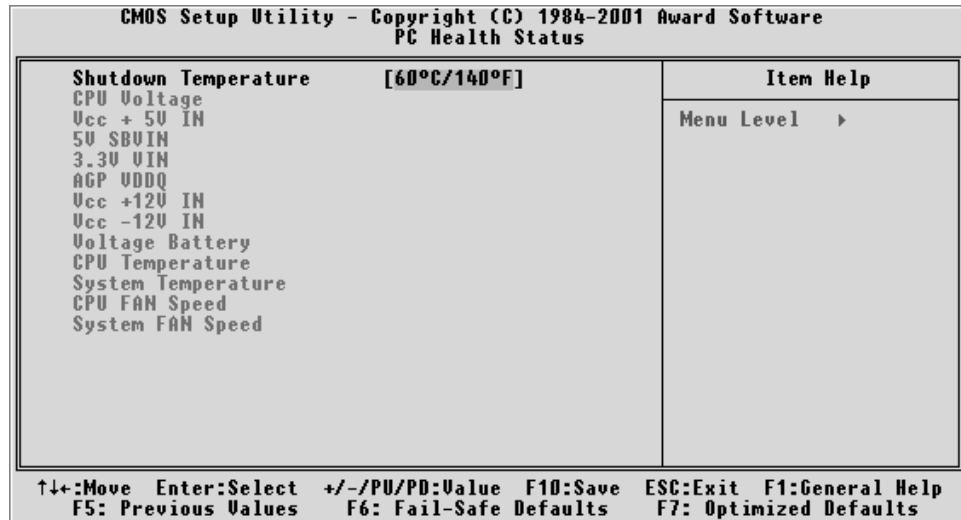

Shutdown Temperature

Enables you to set the maximum temperature the system can reach before powering down.

- The choice: Disabled, 60°C/140°F, 65°C/149°F, 70°C/158°F.

System Component Characteristics

These fields provide you with information about the systems current operating status. You cannot make changes to these fields.

The fields include

- CPU Voltage**
- Vcc + 5V IN**
- 5V SBVIN**
- 3.3V VIN**
- AGP VDDQ**
- Vcc + 12V IN**
- Vcc - 12V IN**
- Voltage Battery**
- CPU Temperature**
- System Temperature**
- CPU FAN Speed**
- System FAN Speed**

 **Frequency/Voltage Control**

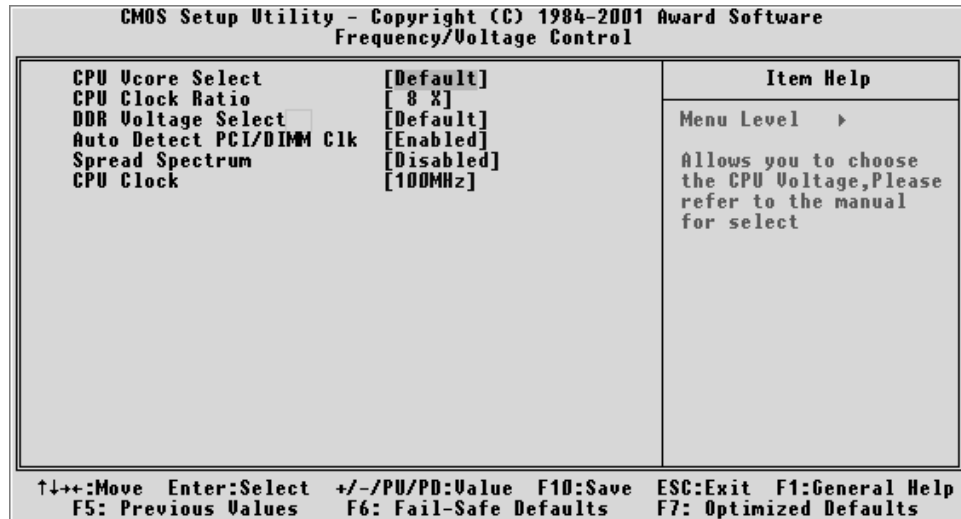

CPU Vcore Select

This item allows you to select CPU Vcore.

- The choice: Default, + 1.100V ~ + 1.850V.

CPU Clcok Ratio

This item allows the user to adjust CPU Ratio .

Min: 8

Max: 50

- Key in a DEC number: (Between Min and Max.)

DDR Voltage Select

This item allows you to select DDR Voltage.

- The choice: Default, 2.55V, 2.60V, or 2.7V.

Auto Detect PCI/DIMM Clk

This item allows you to enable/disable auto detection DIMM/PCI Clock.

- The choice: Enabled, or Disabled.

Spread Spectrum

This item allows you to enable/disable the spread spectrum modulation.

- The choice: Enabled, or Disabled.

CPU Clock

This item allows the user to adjust CPU Host Clock from 100 MHz to 160 MHz by 1 MHz step.

Min: 100 MHz

Max: 160 MHz

➤ Key in a DEC number: (Between Min and Max.)



Load Fail-Safe Defaults

When you press <Enter> on this item, you will get a confirmation dialog box with a message similar to:

Load Fail-Safe Defaults (Y/N) ? N

Pressing 'Y' loads the BIOS default values for the most stable, minimal performance system operations.



Load Optimized Defaults

When you press <Enter> on this item, you will get a confirmation dialog box with a message similar to:

Load Optimized Defaults (Y/N) ? N

Pressing 'Y' loads the default values that are factory-set for optimal performance system operation.

Supervisor/User Password Setting

You can set either supervisor or user password, or both of them. The differences between them are:

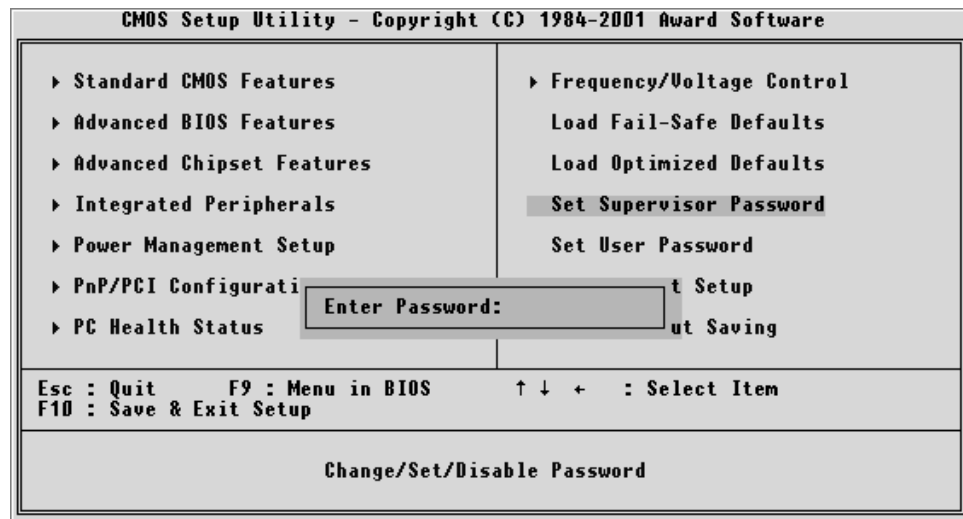

Supervisor Password and User Password

The options on the Password screen menu make it possible to restrict access to the Setup program by enabling you to set passwords for two different access modes: Supervisor mode and User mode.

In general, Supervisor mode has full access to the Setup options, whereas User mode has restricted access to the options. By setting separate Supervisor and User password, a system supervisor can limit who can change critical Setup values.

Enter Password

Type the password up to eight characters, and press <Enter>. The password typed now will clear any previously entered password from CMOS memory. You will be asked to confirm the password. Type the password again and press <Enter>. You may also press <Esc> to abort the selection and not enter a password.

To disable password, just press <Enter> when you are prompted to enter password. A message will confirm the password being disabled. Once the password is disabled, the system will boot and you can enter Setup freely.

Password Disable

If you select System at Security Option of BIOS Features Setup Menu, you will be prompted in entering the password whenever the system is rebooted or you try to enter Setup. If you select Setup at Security Option of BIOS Features Setup Menu, you will be prompted only when you try to enter Setup.

Warning: Retain a record of your password in a safe place. If you forget the password, the only way to access the system is to clear CMOS, please refer to "Clear CMOS" on page 30.

Save & Exit Setup

Pressing <Enter> on this item asks for confirmation:

Save to CMOS and EXIT (Y/N)? Y

Pressing "Y" stores the selections made in the menus of CMOS - a special section of memory that stays on after you turn your system off. The next time you boot your computer, the BIOS configures your system according to the Setup selections stored in CMOS. After saving the values the system is restarted again.

Exit Without Saving

Pressing <Enter> on this item asks for confirmation:

Quit without saving (Y/N)? Y

This allows you to exit from Setup without storing in CMOS any change. The previous selections remain in effect. This exits from the Setup utility and restarts your computer.