

# AT31

---

## MAINBOARD MANUAL

DOC No.: M01806

Rev. : A1

Date : 6, 2002

Part No. : 25-11650 -01

## Handling Precautions

### Warning:

1. Static electricity may cause damage to the integrated circuits on the motherboard. Before handling any motherboard outside of its protective packaging, ensure that there is no static electric charge in your body.
2. There is a danger of explosion if the battery is incorrectly replaced. Replace only with the same or an equivalent type recommended by the manufacturer.
3. Discard used batteries according to the manufacturer's instructions.
4. Never run the processor without the heatsink properly and firmly attached. **PERMANENT DAMAGE WILL RESULT!**

Observe the following basic precautions when handling the motherboard or other computer components:

- Wear a static wrist strap which fits around your wrist and is connected to a natural earth ground.
- Touch a grounded or anti-static surface or a metal fixture such as a water pipe.
- Avoid contacting the components on add-on cards, motherboards, and modules with the *golden fingers* connectors plugged into the expansion slot. It is best to handle system components by their mounting brackets.

The above methods prevent static build-up and cause it to be discharged properly.

## Trademark

*All trademarks mentioned in this manual are registered properly of the respective owners.*

## Handling Precautions

*This manual may not, in whole or in part, be photocopied, reproduced, transcribed, translated, or transmitted in whatever form without the written consent of the manufacturer, except for copies retained by the purchaser for personal archival purposes.*

---

<b>Quick Reference (German)</b>	<b>G-1</b>
<b>Quick Reference (French)</b>	<b>F-1</b>
<b>Quick Reference (Spanish)</b>	<b>S-1</b>
<b>Quick Reference (Japanese)</b>	<b>J-1</b>
<b>Quick Reference (Chinese)</b>	<b>C-1</b>
<b>Quick Reference (Simplified Chinese)</b>	<b>SC-1</b>

## **Chapter 1 Overview**

Package Checklist .....	1-2
The AT31 Mainboard .....	1-3
Main Features .....	1-4
FIC Unique Innovation for Users (NOVUS) - Enhanced Mainboard Features and System Support .....	1-6

## **Chapter 2 Installation Procedures**

Quick Reference (from Page 2-2 to 2-4) .....	2-2
Mainboard Layout .....	2-2
1). Clear CMOS, FSB Speed Select	
CPU/SDRAM/PCI/AGP Speed Select .....	2-3
2). Front Panel Block Cable Connection .....	2-4
3). CPU Fan Installation .....	2-4
1). Set System Jumpers/Switches .....	2-5
Clear CMOS: J3 .....	2-5
FSB and CPU/SDRAM/PCI/AGP Speed Select:	
J4, J5, and J7 .....	2-6
2). Install Memory Modules .....	2-7
3). Install the CPU .....	2-8
4). Install Expansion Cards .....	2-9
5). Connect Devices .....	2-10
Floppy Diskette Drive Connector .....	2-10
IDE Device Connectors .....	2-11
ATX Power Connectors .....	2-11
Fan Connectors .....	2-12
TV Out Connector .....	2-12
Wake-On-Ring Connector .....	2-13

Wake-On-Lan Connector .....	2-13
CD Audio-In Connectors .....	2-14
SPDIF Out Connector (optional) .....	2-14
Front Panel Block and IR Connector .....	2-15
PS/2 Keyboard and Mouse Connector .....	2-16
Game/MIDI Connector .....	2-16
Universal Serial Bus Connectors .....	2-17
Serial Port Connectors .....	2-17
Printer Connector .....	2-18
Audio I/O Jacks .....	2-18
LAN I/O Connector (optional) .....	2-19

### **Chapter 3 BIOS Setup**

CMOS Setup Utility .....	3-1
Standard CMOS Setup .....	3-2
Advanced BIOS Features .....	3-4
Advanced Chipset Features .....	3-8
Integrated Peripherals .....	3-9
Power Management Setup .....	3-14
PnP/PCI Configurations .....	3-18
PC Health Status .....	3-20
Frequency/Voltage Control .....	3-20
Load Fail-Safe Defaults .....	3-21
Load Optimized Defaults .....	3-21
Supervisor/User Password .....	3-21
Save and Exit Setup .....	3-22
Exit without Saving .....	3-22

## Overview

The new 1stMainboard® AT31 is a Micro ATX sized motherboard supporting the latest generation of AMD®processors at industry leading speeds. By utilizing DDR ( Double Data Rate ) transfer rate the 100/133 MHz system bus effectively reaches Front Side Bus speeds of 200/266 MHz. The board provides users with an ATA100 data transaction for hard drives and allows up to 2 GB memory totally by 2 PC1600/PC2100 (DDR200/266) DIMM sockets.

The AT31 is based around the high performance ATI IGP320 core chip as a North Bridge and VIA VT82686B as a South Bridge. The virtual AGP4x functions supported by ATI IGP320 that ideal for Windows 2000 provides you with a photo-realistic 3D experience suitable for the most 3D games and software environments. AC97 Codec that embedded in VIA 686B, ensures high quality sound effect.

The mainboard also comes equipped with the new NOVUS® range of innovative features that assist in the installation and maintenance. The features include *Easy Key*, which provides instant keyboard access to the BIOS for adjustments to Clock and Default settings and *LogoGenie*, which allows you to create your own customized logo to be displayed during system boot up. The *BIOS Guardian* is an Anti Virus utility that prevents viruses from damaging your system BIOS and rendering your system inoperative.

Expansion is provided by 1 AGP 4X and 3 PCI slots. In addition, the 1stMainboard is equipped standard I/O connections include 2 serial ports (1 by pinheader), 1 parallel port, 1 VGA port, 1 PS/2 mouse and keyboard connector, 4 USB ports (2 by pinheader), 1 IR port by pinheader, and 1 media connector (Line-In, Line-Out, Mic-In, 1 front audio, 1 game port).

## Package Checklist

If you discover any item below was damaged or lost, please contact your vendor.

- The mainboard       This user manual
- One FDD cable       CD software
- One ATA100 cable
- TV Out Paddle Card (Giftbox only)

### IMPORTANT: AMD CPU HEAT SINK INSTALLATION



*Be ware finish heat sink install. Before you boot system, please check the heat sink is complete contact with die of CPU.*

The poor contact will bring about over heat, it may damage your processor.

It is strongly recommended that at least a 250-watt ATX power pupply be used for this motherboard. Make sure that your ATX power supply can supply at least 20 amperes on teh +5-Volt lead and 10mA on the +5-Volt standby lead (+5VSB). Your system may become unstable / unreliable and may experience difficulty in powering up if your power supply is inadequate.



**NOTE: CD Pro** that contains patch files, onboard video/audio chip drivers, related online help and other useful information can be found in your mainboard package.

*Please install it right after your Windows operating system installation is done.* Place your CD Pro in the drive, an operating menu will appears in your monitor. Please select *Auto Installation*. It will automatically detect which software tools (patch files, drivers) that the mainboard needs. Press **OK** button to go through the whole installation procedure in a very straight forward and easy way. It also provides you with a custom way to select wanted patch files and software drivers that for onboard chips use. **The top menu of the CD Pro lists all the functions that allowed by this board.**

## The AT31 Mainboard

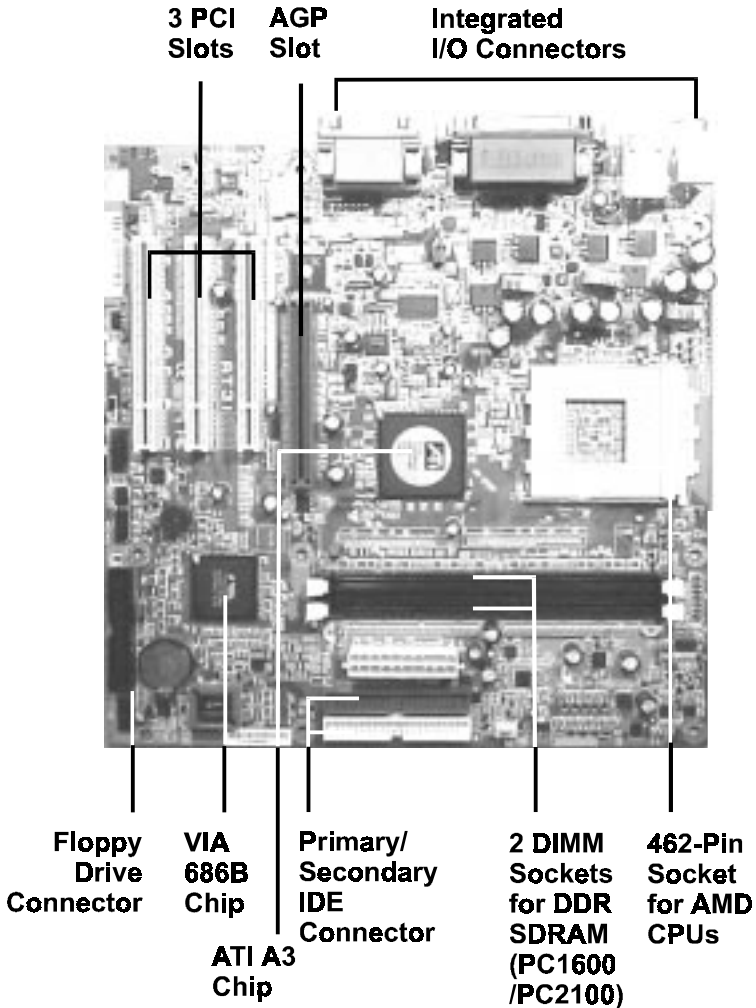

## Main Features

### ■ Easy Installation

BIOS with support for Plug and Play, auto detection of IDE hard drives, LS-120 drives, IDE ZIP drives. *The mainboard supports Windows 2000, Windows XP only.*

### ■ Leading Edge Chipset

ATI IGP320 is a North Bridge with integrated 2D/3D graphics accelerator. The chip is designed for offering a reliable, effective, and excellent performance. It contains internal AGP controller, concurrent PCI bus controller, advanced DRAM controller, and power management support.

### ■ Versatile Main Memory Support

Accepts up to total 2 GB DRAM using two DDR DIMMs from 256 MB to 2 GB with support for lightening-fast PC1600/PC2100 (DDR200/266) DDR SDRAM.

### ■ AMD Processors Support

Athlon: 900 MHz to 1.4 GHz and up\* at 200 MHz FSB/  
1.1 GHz to 1.4 GHz at 266 MHz FSB; *(1.2 GHz not included)*  
Athlon XP: 1500+ to 2100+ and up\* at 266 MHz FSB;  
Duron: 900 MHz to 1.3 GHz and up\* at 200 MHz FSB  
*(1.0, 1.2 GHz not included)*

(\*: not tested yet)

### ■ Enhanced PCI Bus Master IDE Controller with Ultra DMA 33/66/100 Support

Integrated Enhanced PCI Bus Master IDE controller features two dual-channel connectors that up to four Enhanced IDE devices, including CD-ROM and Tape Backup Drives, as well as Hard Disk Drives supporting the new Ultra DMA 100 protocol. Standard PIO Mode 3, PIO Mode 4, DMA Mode 2, DMA Mode 4, UltraDMA-100 Mode 5 devices are also supported.



---

- **AGP and PCI Expansion Slots**

One AGP and three PCI Bus expansion slots provided the room to install a full range of add-on cards.

*(For supported AGP cards, please refer to the approval sheet on FIC web site.)*

- **Integrated Audio Subsystem**

Embedded audio features in the VIA 686B provide hardware Sound BlasterPro for Windows DOS box and real mode DOS legacy compatibility, dual full-duplex Direct Sound channels between system memory and AC97 link.

- **Super Multi Input/Output (I/O) Support**

Integrated super I/O controller in the VIA 686B features two high-speed UART serial ports, one multi-mode (standard/ECP/EPP) parallel port, one IR port, and one FDD connector.

- **Convenient Rear Panel USB Connection Support**

Two USB ports integrated in the rear I/O panel with two extra USB pin-heads for either front or rear panel connections to the growing number of USB compliant peripheral devices on the market.

- **LAN Support (optional)**

One RJ45 LAN jack on the rear panel and onboard LAN controller allows you to connect with network system in a very easy way.

- **TV Out Support (optional)**

Support both NTSC and PAL TV with an optional TV out bracket and a cable.

## FIC Unique Innovation for Users (NOVUS) - Enhanced Mainboard Features and System Support

- LogoGenie

A user friendly GUI supporting Windows 95/98/98SE (not Windows 2000/NT/ME/XP), LogoGenie allows you to customize, create or select a Logo which will be displayed when the system is booting.



**NOTE:**

Please read Page 3-7 for detail information.

- BIOS Guardian

BIOS Guardian effectively acts as a fire-wall against viruses that can attack the BIOS while the system is running and by default is enabled.



**WARNING:**

BIOS Guardian must be disabled before reflash BIOS.



**NOTE:**

Please read Page 3-7 for detail information.

- Easy Key

Instead of completing the multi-layered BIOS setup process these 3 Easy Key functions provide direct access to Sub-Menu when completing BIOS settings adjustments.

Easy-Keys are as follows:

**Ctrl + c:** To enter clock settings menu.

**Ctrl + p:** To load Performance Default settings and restart.

**Ctrl + f:** To load Fail-Safe Default settings and restart.

# Installation Procedures

The mainboard has several user-adjustable jumpers on the board that allow you to configure your system to suit your requirements. This chapter contains information on the various jumper settings on your mainboard.

To set up your computer, you must complete the following steps:

- Step 1 - Set system jumpers
- Step 2 - Install memory modules
- Step 3 - Install the Central Processing Unit (CPU)
- Step 4 - Install expansion cards
- Step 5 - Connect ribbon cables, cabinet wires, and power supply
- Step 6 - Set up BIOS software
- Step 7 - Install supporting software tools



**WARNING:** Excessive torque may damage the mainboard. When using an electric screwdriver on the mainboard, make sure that the torque is set to the allowable range of 5.0 ~ 8.0kg/cm.

Mainboard components contain very delicate Integrated Circuit (IC) chips. To prevent static electricity from harming any of the sensitive components, you should follow the following precautions whenever working on the computer:

1. Unplug the computer when working on the inside.
2. Hold components by the edges and try not to touch the IC chips, leads, or circuitry.
3. Wear an anti-static wrist strap which fits around the wrist.
4. Place components on a grounded anti-static pad or on the bag that came with the component whenever the components are separated from the system.

# Quick Reference (from Page 2-2 to 2-4)

## Mainboard Layout

**Chapter 2**  
**Installation**  
**Procedures**

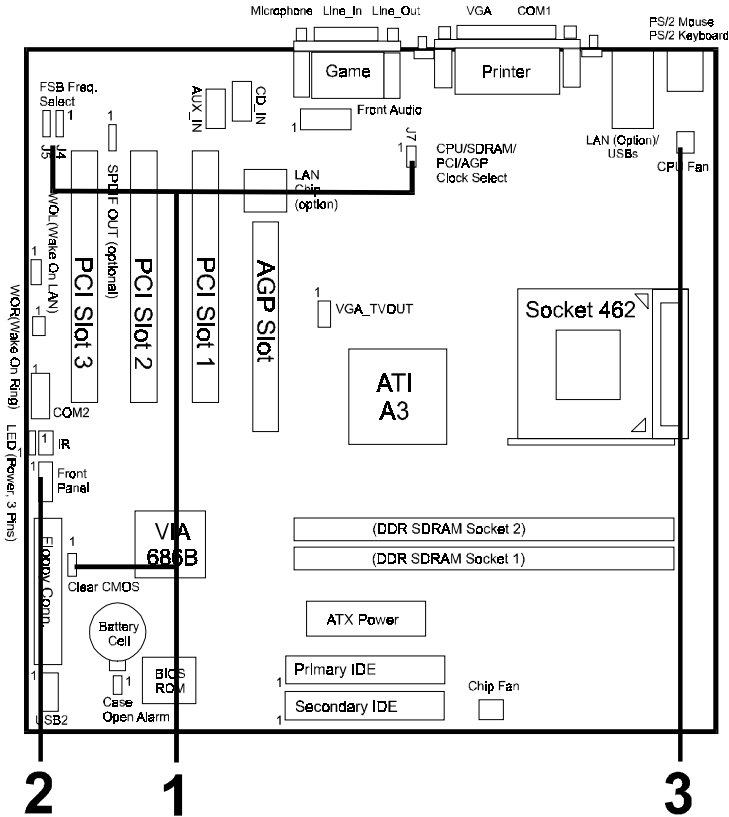

\* When link to Line\_Out jack, please use a speaker that with amplifier.

1). **Clear CMOS, FSB Speed Select, CPU/SDRAM/PCI/AGP Speed Select**

**J3**  
**(Clear CMOS)**



**Normal**  
**(Default)**



**Clear CMOS**

**FSB Speed Select**

Jumper \ FSB Speed	100MHz	133MHz
	<b>J4</b>	1-2
<b>J5</b>	2-3	2-3

**CPU/SDRAM/PCI/AGP Freq. Select**

(Default)

J7	CPU	SDRAM	PCI	AGP
OFF	100.00	100.00	33.33	66.67
ON	133.33	133.33	33.33	66.67

(unit: MHz)

## 2). Front Panel Block Cable Connection

**LED (Single Color)**  
**(Power LED, 2 or 3 Pins)**

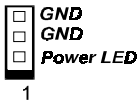

**IR**  
**(Intel spec.)**

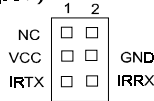

**F\_PNL**  
**(Intel spec.)**

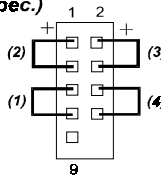

(4). **Power Button**      (1). **Reset Button**

(3). **Dual Power LED**      (2). **HDD LED**

*(If use dual power LED,  
green: Pin2, yellow: Pin4;  
otherwise, Pin2 is positive,  
Pin4 is negative.)*

## 3). CPU Fan Installation



**CAUTION:**

1. The heatsink and fan you installed must be approved by AMD.
2. The mainboard must be placed on a solid place to avoid shaking while install the heatsink and fan on the board.
3. The heatsink must be contact with the CPU top tightly.
4. Never run the processor without the heatsink properly and firmly attached. **PERMANENT DAMAGE WILL RESULT!**

Without sufficient air circulation, the CPU may overheat resulting in damage to both the CPU and the mainboard.

***Damage may occur to the mainboard and/or the CPU fan if these pins are used incorrectly. These are not jumpers, do not place jumper caps over these pins.***

## 1). Set System Jumpers/Switches

Jumpers are used to select the operation modes for your system. Some jumpers on the board have three metal pins with each pin representing a different function. A **1** is written besides pin 1 on jumpers with three pins. To **set** a jumper, a black cap containing metal contacts is placed over the jumper pin/s according to the required configuration. A jumper is said to be **shorted** when the black cap has been placed on one or two of its pins. The types of jumpers used in this manual are shown below:

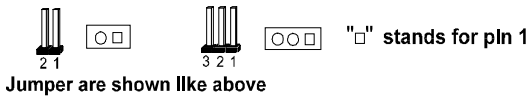
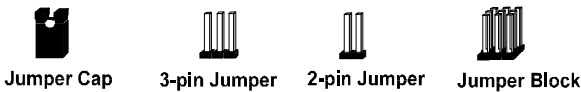

Jumpers in a Block



**NOTE:** Users are not encouraged to change the jumper settings not listed in this manual. Changing the jumper settings improperly may adversely affect system performance.

### Clear CMOS: J3

The CMOS RAM is powered by the onboard button cell battery. To clear the RTC data: (1) Turn off your computer (2) Place the jumper cap onto the pinpair 2-3 at least 6 seconds to clear CMOS (3) Place the jumper cap onto the pinpair 1-2 to Normal (4) Turn on your computer until CMOS checksum error appears (5) Hold down the **Delete** key when boots (6) Enter the BIOS Setup to re-enter user preferences.

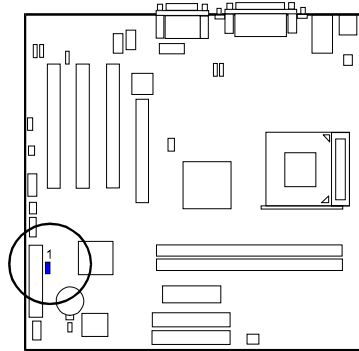
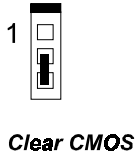
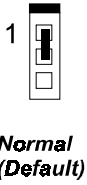

**FSB and CPU/SDRAM/PCI/AGP Clock Select: J4, J5, and J7**

The jumper J4 and J5 allow users to set FSB frequency. The J7 sets the combination of CPU/SDRAM/PCI/AGP clock.

Jumper \ FSB Speed	100MHz	133MHz
J4	1-2	2-3
J5	2-3	2-3

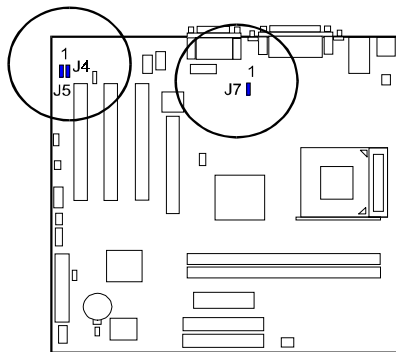



*(Default)*

<b>J7</b>	<b>CPU</b>	<b>SDRAM</b>	<b>PCI</b>	<b>AGP</b>
OFF	100.00	100.00	33.33	66.67
ON	133.33	133.33	33.33	66.67

*(unit: MHz)*

## 2). Install Memory Modules

1. Locate the DIMM slots on the mainboard.
2. Install the DIMM straight down into the DIMM slot using both hands.
3. The clip on both ends of the DIMM slot will close up to hold the DIMM in place when the DIMM reaches the slot bottom.

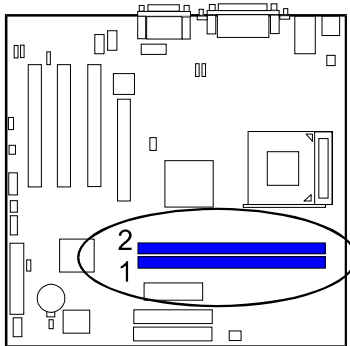

Press the clips with both hands to remove the DIMM.

### 3). Install the CPU

The AMD CPU module resides in the socket on the board. Please follow the steps introduced below to complete the CPU installation.

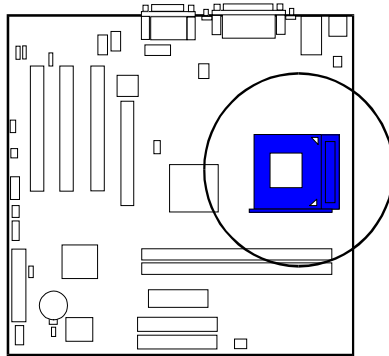

**CAUTION:**

1. The heat sink and fan you installed must be approved by AMD.
2. The mainboard must be placed on a solid place to avoid shaking while install the heat sink and fan on the board.
3. The heat sink must be contact with the CPU top tightly.
4. Never run the processor without the heat sink properly and firmly attached. PERMANENT DAMAGE WILL RESULT!

**To install the CPU, do the following:**

1. Lift the lever on the side of the CPU socket.
2. Handle the chip by its edges and try not to touch any of the pins.
3. Place the CPU in the socket. The chip has two notches to correctly locate the chip. Align two notches of the processor with the two triangular marks on the socket. Do not force the chip. The CPU should slide easily into the socket.
4. Swing the lever to the down position to lock the CPU in place.
5. Install the cooling fan with heat sink on top of the installed CPU.
6. Place the mainboard (with the CPU, its cooling fan, and heat sink) into the system chassis and affix it with screws.

## 4). Install Expansion Cards

This section describes how to connect an expansion card to one of your system expansion slots. Expansion cards are printed circuit boards that, when connected to the mainboard, increase the capabilities of your system. For example, expansion cards can provide video and sound capabilities. The mainboard features one AGP and three PCI bus expansion slots.

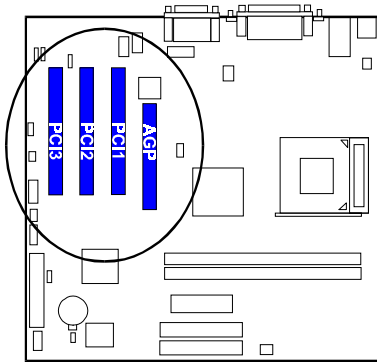

**CAUTION:** Make sure to unplug the power supply when adding or removing expansion cards or other system components. Failure to do so may cause severe damage to both the mainboard and expansion cards.

Always observe static electricity precautions.

Please read **Handling Precautions** at the start of this manual.

To install an expansion card, follow the steps below:

1. Remove the chassis cover and select an empty expansion slot.
2. Remove the corresponding slot cover from the computer chassis. Unscrew the mounting screw that secures the slot cover and pull the slot cover out from the computer chassis. Keep the slot cover mounting screw nearby.
3. Holding the edge of the peripheral card, carefully align the edge connector with the expansion slot.

4. Push the card firmly into the slot. Push down on one end of the expansion card, then the other. Use this rocking motion until the add-on card is firmly seated inside the expansion slot.
5. Secure the board with the mounting screw removed in Step 2. Make sure that the card has been placed evenly and completely into the expansion slot.
6. Replace the computer system cover.
7. Setup the BIOS if necessary.
8. Install the necessary software drivers for the expansion card.

## 5). Connect Devices

### *Floppy Diskette Drive Connector*

This connector provides the connection with your floppy disk drive. The red stripe of the ribbon cable must be the same side with the Pin 1.

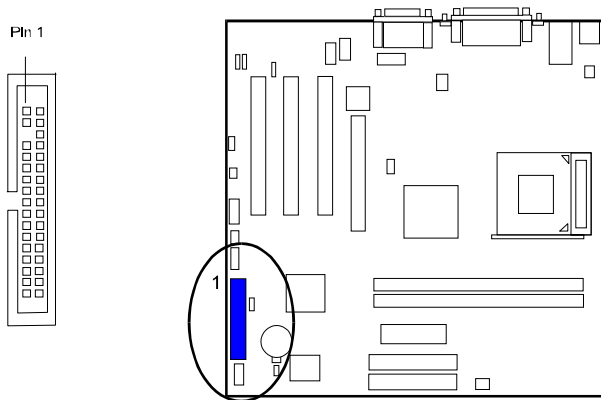

### IDE Device Connectors

The two connectors, PRIMARY and SECONDARY, are used for your IDE hard disk drives, CD drives, LS-120 drives, or IDE ZIP drives. The red stripe of the ribbon cable must be the same side with the Pin 1.

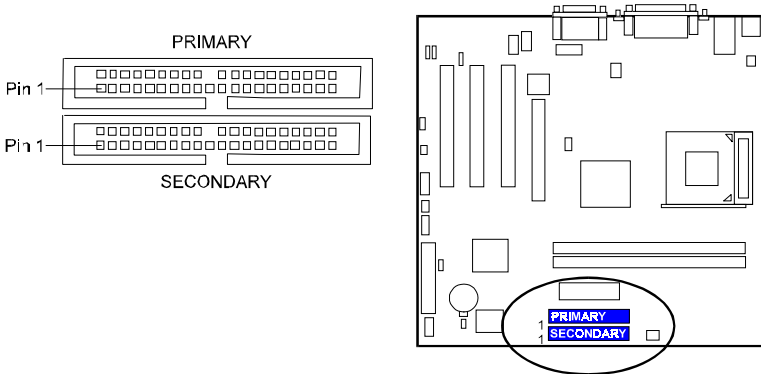

**Chapter 2  
Installation  
Procedures**

### ATX Power Connector

This 20-pin male block connector is connected to the ATX power supply. The plug from the power supply will only insert in one orientation because of the different hole sizes. Find the proper orientation and push down firmly making sure that the pins are aligned.

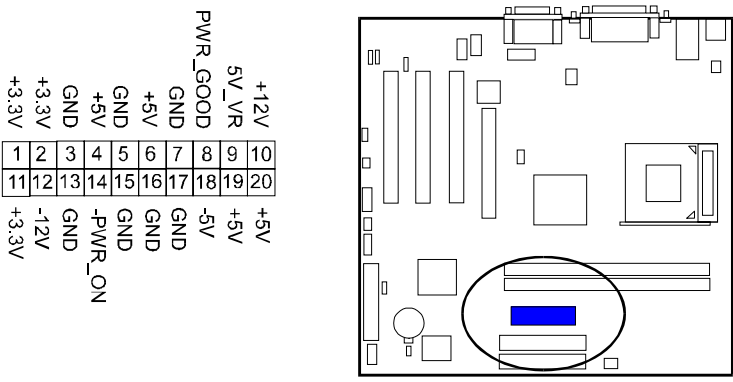

## Fan Connectors

The connector CPU\_FAN is linked to the CPU fan. CHIP\_FAN can be used either with the case fan or North Bridge chip fan. For preventing the system and chip from overheat damage, the fans on this board will keep running when the system in suspend mode.

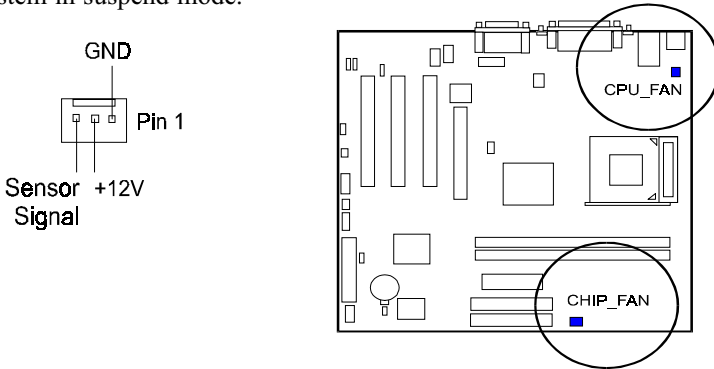

**CAUTION:**

Before installing the TV card on these two connectors, make sure your system power is off. Failure to do so may cause damage to the mainboard.

## TV Out Connector

The VGA\_TVOUT connector is provided for an optional TV-OUT cable with a bracket that being installed in the rear panel for connecting signals to TV set. It allows you use your TV as a monitor.

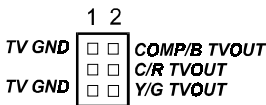

**CAUTION:**

The two jacks on the optional TV-OUT bracket can not be used at the same time.

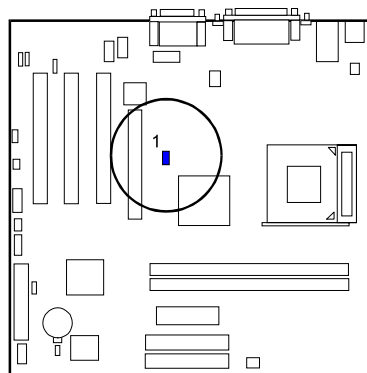

### *Wake-On-Ring Connector*

The 2-pin connector allows you to link with your modem card which outputs a WOR signal; the system can be turned on from the power-off status by a remote phone call via the modem card.

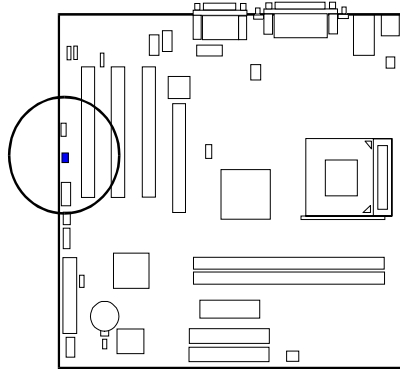
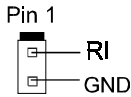

**Chapter 2**  
**Installation**  
**Procedures**

### *Wake-On-Lan Connector*

This 3-pin connector allows the remove servers to manage the system that installed this mainboard via your network adapter which also supports WOL.

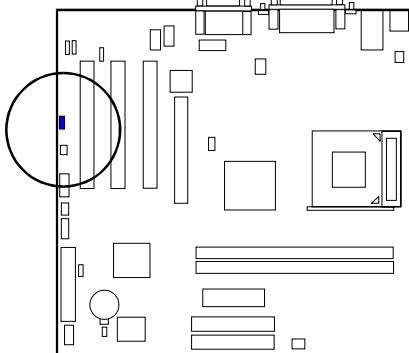
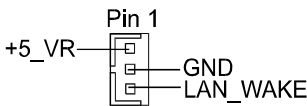

### CD Audio-In Connectors

The CD\_IN connector is used as a port for audio input from CD drive. The AUX\_IN provided users with one extra audio input port from CD drive.

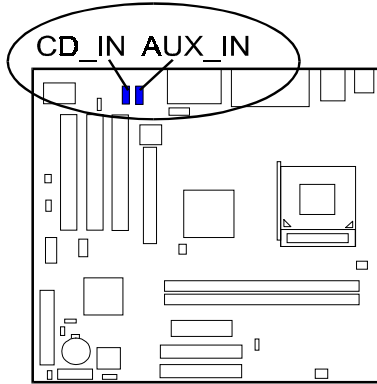
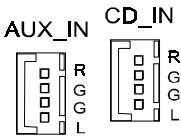

**CAUTION:** Improper orientation of SPDIF connection may cause damage of your device.

### SPDIF Out Connector (optional)

The mainboard equipped one 1x3 pinheader. It is used for SPDIF digital audio output.

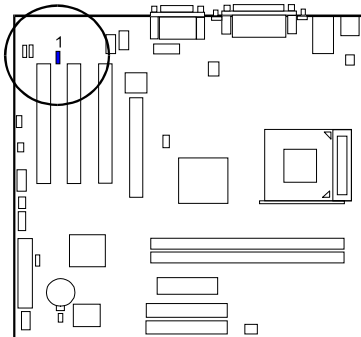
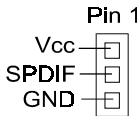



### Front Panel Block and IR Connector

This block connector includes the connectors for linking with Power LED (2 pins and 3 pins), HDD LED, power button, power/sleep/message waiting button, reset button on the front panel of the system case. Please identify polarities of plug wires for the case speaker and LEDs. Please ask vendor about this information when you buy them and install the system by yourself. The plug wires polarities of these buttons will not affect the function.

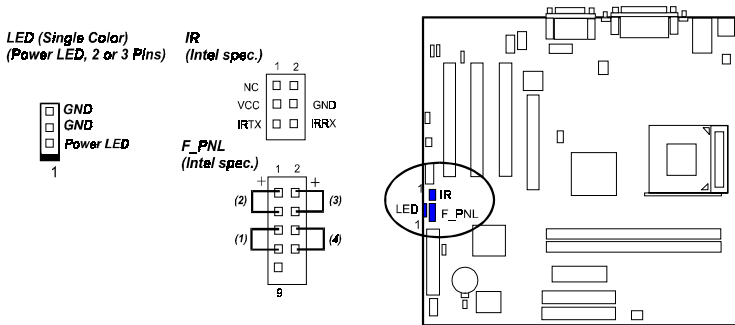

**(1) Reset Switch** is connected to the reset button. Push this switch to reboot the system instead of turning the power button off and on.

**(2) HDD LED** is connected to the IDE device indicator. This LED will blink when the hard disk drives are activated.

**(3) Power /Sleep LED (2-Pin/3-Pin)**

Please refer to the tables below for the representations of LED states.

**Single-Color (2, 3 Pins)**

LED	Meaning	State
Off	Off	S4/S5
On	Full On	S0
Flash	Sleep	S1/S3

**Dual-Color**

LED	Meaning	State
Off	Off	S4/S5
Green	Full On	S0
Yellow	Sleep	S1/S3

**(4) Power Button** is connected with power button. Push this switch allows the system to be turned on and off rather than using the power supply button.

**IR** is a pinheader that is used for linking with your ID device to allow transmission of data to another system that also supports the IR feature.

### *PS/2 Keyboard and Mouse Connector*

These two 6-pin female (PS/2 keyboard is purple color and PS/2 mouse is green color) connectors are used for your PS/2 keyboard and PS/2 mouse.

PS2 Mouse

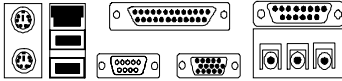

PS2 Keyboard

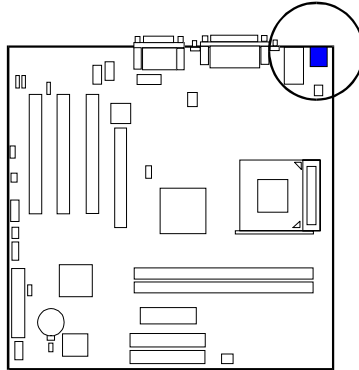
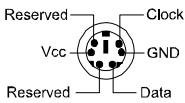

### *Game/MIDI Connector*

This 15-pin female gold-colored connector allows you to connect game joysticks or game pads. Connect MIDI devices for playing or editing audio.

Game

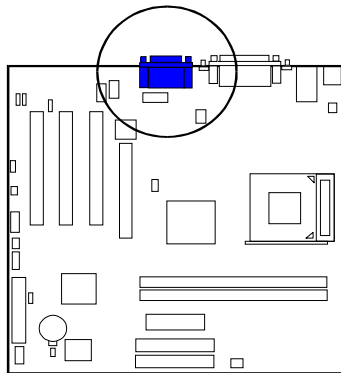
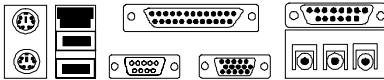

### Universal Serial Bus Connectors

These two black jacks are integrated on the rear edge of the board for linking with USB devices. This board has a pinheader, USB2, for two extra USB ports that either on front or rear panel.

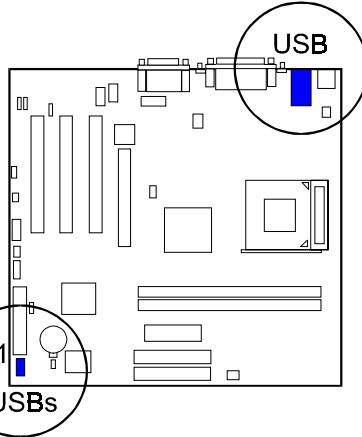
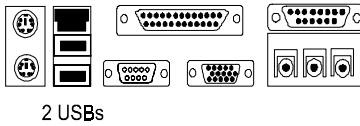

The figure below is the pin assignment of the USB2.

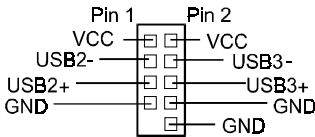

(Intel Spec.)

Chapter 2  
Installation  
Procedures

### Serial Port Connectors

COM1 (9-pin D-sub male connector with teal color) and COM2 (9-pin male connector) allow you to connect with your devices that use serial ports, such as a serial mouse or an external modem.

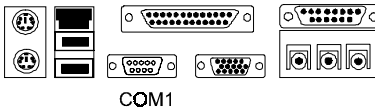

#### COM2 Port

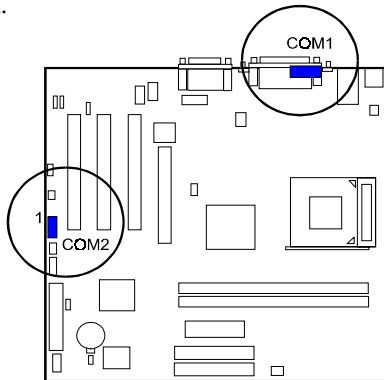
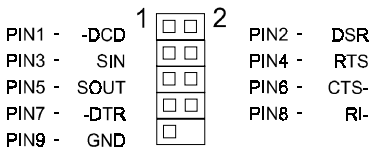

## Printer Connector

This 25-pin D-Sub female burgundy-colored connector is attached to your printer.

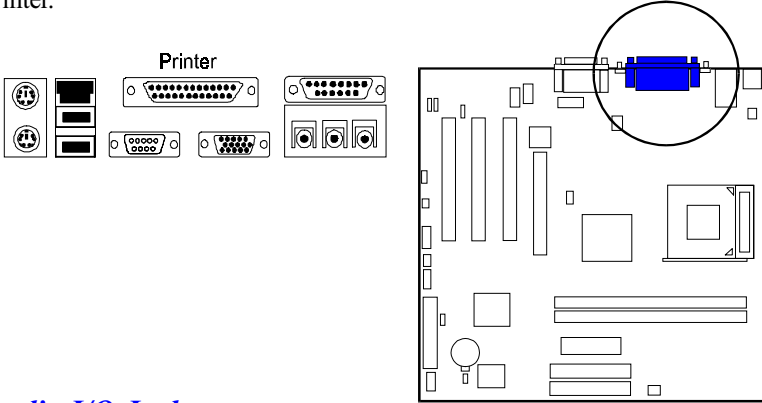

## Audio I/O Jacks

LINE\_OUT (lime) can be connected to headphones or preferably powered speakers. LINE\_IN (light blue) allows tape players or other audio sources to be recorded by your computer or played through the LINE\_OUT. MIC\_IN (pink) allows microphones to be connected for voice input. The mainboard also provides you with a front panel audio port connector, FNT\_AUDIO, when needed. Its pin definitions were presented below.

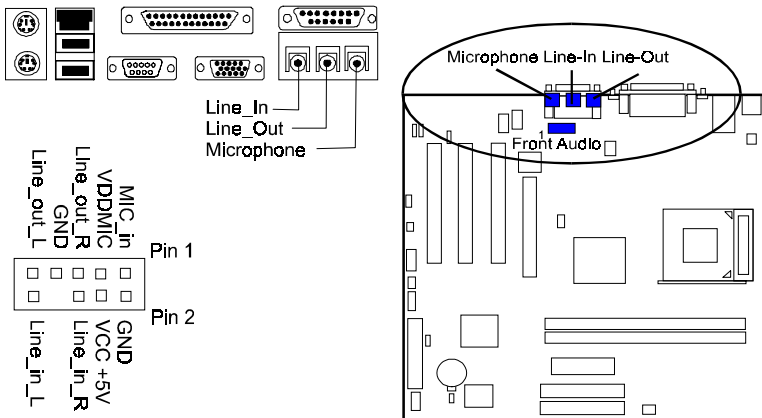

(Intel Spec.)

***LAN Connector (optional)***

The optional LAN jack is connected to the LAN cable.

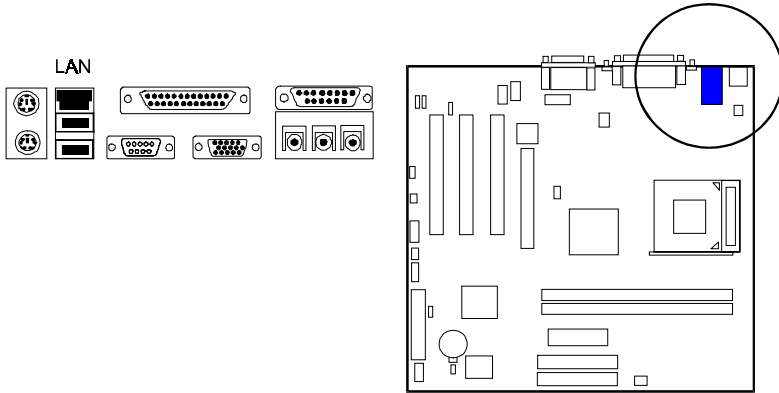

**This Page Left Blank for Note**

## BIOS Setup

The mainboard comes with the chip that Award BIOS that contains the ROM Setup information of your system. (This chip serves as an interface between the processor and the rest of the mainboard components.) This section explains the information contained in the Setup program and tells you how to modify the settings according to your system configuration.

### CMOS Setup Utility

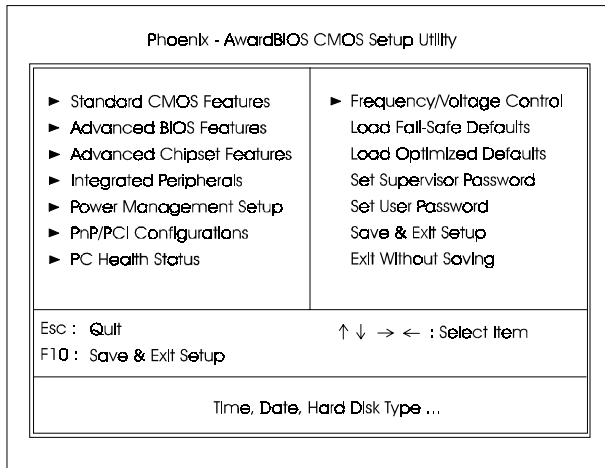

The Setup utility program allows updates to the mainboard configuration settings. The BIOS setup values will be saved in the CMOS. It is executed when the user changes system configuration; user changes system backup battery; or the system detects a configuration error and asks the user to run the Setup program. Use the arrow keys to select and press **Enter** to run the selected program.

## Standard CMOS Setup

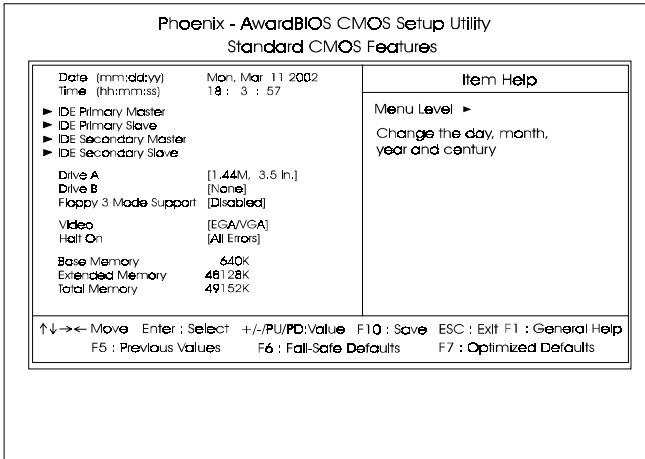

Chapter 3  
BIOS Setup

The Standard CMOS Setup screen is displayed above. Each item may have one or more option settings. The system BIOS automatically detects memory size, thus no changes are necessary. Use the arrow keys to highlight the item and then use **PgUp** or **PgDn** keys to select the value you want in each item.

### Date

To set the date, highlight the *Date* field and then press **Page Up/Page Down** or +/- keys to set the current date. Follow the month, day and year format.

### Time

To set the time, highlight the *Time* field and then press **Page Up/Page Down** or +/- keys to set the current time. Follow the hour, minute, and second format.



---

## Hard Disks

This field records the specifications for all non-SCSI hard drives installed in the system. The onboard PCI IDE connectors provide Primary and Secondary channels for connecting up to four IDE hard disks or other IDE devices. Each channel can support up to two hard disks, the first of which is the *Master* and the second is the *Slave*.

### Hard Disk Configurations

<b>Capacity:</b>	The hard disk size. The unit is Bytes.
<b>Cylinder:</b>	The cylinder number of the hard disk.
<b>Head:</b>	The read/write head number of hard disk.
<b>Precomp:</b>	The cylinder number at which the disk drive changes the write current.
<b>Landing Zone:</b>	The cylinder number that the disk drive heads (read/write) are seated when the disk drive is parked.
<b>Sector:</b>	The sector number of each track defined on the hard disk.

## Drive A / Drive B

This field records the types of floppy drives installed in the system. To enter the configuration value for a particular drive, highlight its corresponding field and then select the drive type using the **left-** or **right-arrow** key.

## Floppy 3 Mode Support

This is a Japanese standard floppy type drive. The standard stores 1.2MB in a 3.5 inch diskette.

## Video

Set this field to the type of video display card installed in the system.

## Halt On

This field determines which types of errors will cause the system to halt.

## Advanced BIOS Features

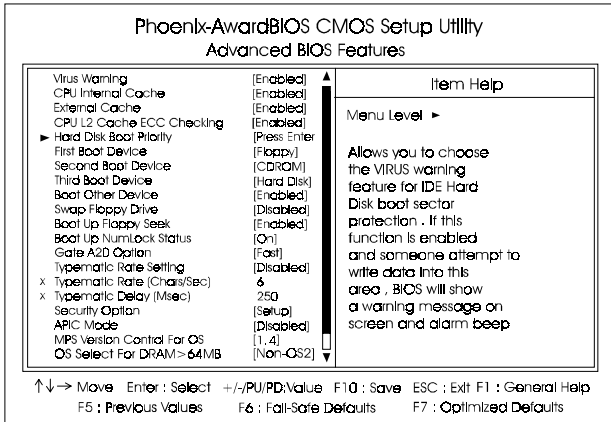

### Virus Warning

This feature allows users to enable the computer virus warning for IDE hard disk boot sector protection. If enabled, BIOS will show a warning message and alarm will beep whenever someone write data into this area. The options are: Enabled, Disabled.

### CPU Internal Cache

When enabled, improves the system performance. Disable this item when testing or trouble-shooting. The options are: Enabled, Disabled.

### External Cache

When enabled, supports CPU L2 cache. This feature allows you to disable the cache function when the system performance is unstable to run some software. The options are: Enabled, Disabled.

### Hard Disk Boot Priority

This feature will auto detect all hard disks of bootable device on the system. It also allows users to select hard disk device booting priority.

### First/Second/Third Boot Device

This feature allows user to select the boot device priority. The options are: Floppy, LS120, Hard Disk, CDROM, ZIP100, USB-FDD, USB-ZIP, USB-CDROM, USB-HDD, LAN, Disabled.

### Boot Other Device

This feature allows user to select the boot device priority.  
The options are: Enabled, Disabled.

### Swap Floppy Drive

Allows you to switch the order in which the operating system accesses the floppy drives during boot up.  
The options are: Enabled, Disabled.

### Boot Up Floppy Seek

When enabled, assigns the BIOS to perform floppy diskette drive tests by issuing the time-consuming seek commands.  
The options are: Enabled, Disabled.

### Boot Up Numlock Status

When set to On, allows the BIOS to automatically enable the Num Lock Function when the system boots up. The options are: On, Off.

### Gate A20 Option

When set at Fast, allows a faster access response under Protected mode.  
The options are: Fast, Normal.

### Typematic Rate Setting

The term typematic means that when a keyboard key is held down, the character is repeatedly entered until the key is released.  
The options are: Disabled, Enabled.

### Typematic Rate (Chars/Sec)

This feature is available only if the above item, Typematic Rate Setting, is set at Enabled. Sets the rate of a character repeat when the key is held down. The options are: 6, 8, 10, 12, 15, 20, 24, 30.

### Typematic Delay (Msec)

This feature is available only if the item, Typematic Rate Setting, is set at Enabled. Sets the delay time before a character is repeated.  
The options are: 250, 500, 750, 1000 millisecond.

### Security Option

Allows you to set the security level of the system.  
The options are: Setup, System.

### APIC Mode

Allows you to decide if the system enters the APIC (Advanced Programmable Interrupt Controller) mode or not for more IRQs can be released.  
The options are: Enabled, Disabled.

### MPS Version Control For OS

When two CPUs onboard (not this board) this feature allows you to select MPS (Multi-Processor Spec.) version control for OS when logo test executes. The options are: 1.1, 1.4.

### OS Select For DRAM > 64MB

If your operating system (OS) is OS/2, select the option OS2. Otherwise, stay with the default setting Non-OS2.  
The options are: Non-OS2, OS2.

### HDD S.M.A.R.T. Capability

S.M.A.R.T. stands for Self-Monitoring and Analysis Reporting Technology which allows your hard disk drive to report any read/write errors and issues a warning with LDCM installed.  
The options are: Disabled, Enabled.

### Video BIOS Shadow

Enabling this feature will copy the video BIOS to shadow RAM, it will improve the system performance.  
The options are: Enabled, Disabled.

### BIOS Guardian

It allows the system to prevent computer viruses. Users will need to disable it to update BIOS. The options are: Enabled, Disabled.



**NOTE:** Please disable this BIOS feature about BIOS Guardian before you start to reflash BIOS.

### **BIOS Guardian and Reflash BIOS**

BIOS Guardian by default is enabled, thus effectively acts as a fire-wall against viruses that can attack the BIOS while the system is running. It must be disabled before reflash BIOS.

The steps below show you how to off and on BIOS Guardian when reflash BIOS:

1. Press **Del** key while booting. Go to *CMOS Setup Utility* menu.
2. Go to *Advanced BIOS Features* submenu.
3. Set the feature *BIOS Guardian* at Disabled.
4. Save the setting and exit. The system restarts.
5. POST screen holds. A message about BIOS Guardian shows.
6. Press Space bar.
7. Reflash BIOS. Restart the system after complete it.
8. POST screen holds. A message about BIOS Guardian shows.
9. Press **G** key. The feature BIOS Guardian will be enabled again.

### **Full Screen LOGO Show**

It decides whether or not the full screen logo is shown during system booting up. The options are: Enabled, Disabled.



#### **NOTE:**

1. LogoGenie supports Award BIOS only.
2. If you create a Logo file (.bmp) by LogoGenie, the file size must be 640 x 464 x 256 colors.

To enable this utility, please proceed as follows:

1. Insert CD Pro. Select LogoGenie from the Menu and follow the installation instructions.
2. After LogoGenie has been installed, go to Windows Start Box. In Programs Menu, select LogoGenie, then select LogoGenie.
3. Press F1 to read Help file to understand how to use this software if it is new to you.

## Advanced Chipset Features

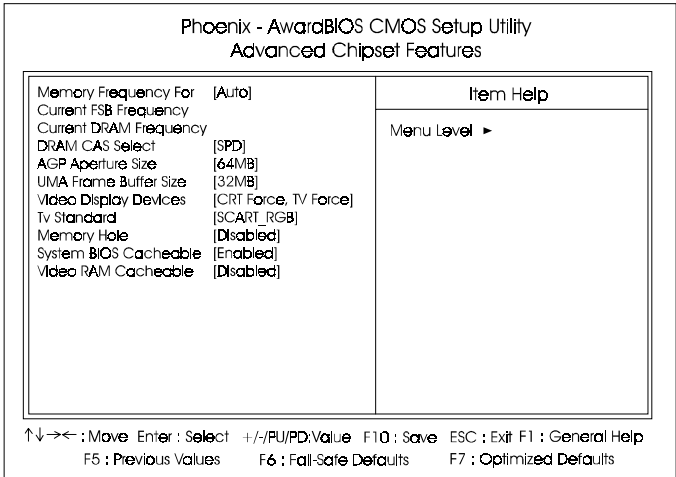

### Memory Frequency For

This feature allows users to set the memory frequency.  
The options are: Auto, DDR-200, DDR-266, SYNC.

### DRAM CAS Select

This feature allows user to select the CAS latency time for the installed DDR SDRAMs.  
The options are: SPD, 2, 2.5.

### AGP Aperture Size

It decides the mapped size in system memory for AGP graphics data.  
The options are: 32MB, 64MB, 128MB, 256MB.

### UMA Frame Buffer Size

It allows user to select the main memory frame size of AGP use.  
The options are: 8MB, 16MB, 32MB, 64MB, 128MB, 256MB.

### Video Display Devices

It allows user to select the video display device.  
The options are: Auto; CRT Only; TV Only; CRT Force, Other Auto; TV Force, Other Auto; CRT Force, TV Force.

### TV Standard

It allows user to select the TV output signal format.

The options are: NTSC, PAL, PAL-M, PAL-60, NTSC-JAP, PAL-CN, PAL-N, SCART-RGB.

### Memory Hole

When set at Enabled, the memory hole at 15MB address will be relocated to the 15M-16MB address range of the ISA or PCI cycle when the CPU accesses the 15M-16MB address area. When set at Disabled, the memory hole at 15MB address will be treated as a DRAM cycle when the CPU accesses the 15M-16MB address area. The options are: Disabled, Enabled.

### System BIOS Cacheable

Setting at Enabled will allow the caching of the BIOS ROM F0000H-FFFFFH, resulting in better system performance. It may cause system error when some program try to access the memory area.

The options are: Disabled, Enabled.

### Video RAM Cacheable

When enabled, allows the video RAM area to be cacheable.

The options are: Enabled, Disabled.

## Integrated Peripherals

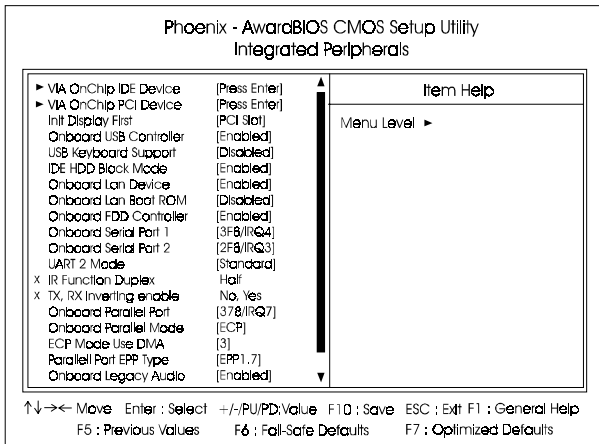

## **VIA OnChip IDE Device**

### **OnChip IDE Channel0**

When enabled, allows you to use the onboard primary PCI IDE. If a hard disk controller card is used, set at Disabled.

The options are: Enabled, Disabled.

### **OnChip IDE Channel1**

When enabled, allows you to use the onboard secondary PCI IDE. If a hard disk controller card is used, set at Disabled.

The options are: Enabled, Disabled.

### **IDE Prefetch Mode**

When set at Enabled, it allows data to be posted to and prefetched from the primary IDE data ports. Data prefetching is initiated when a data port read occurs. The read prefetch eliminates latency to the IDE data ports and allows them to be performed back to back for the highest possible PIO data transfer rates. The first data port read of a sector is called the demand read. Subsequent data port reads from the sector are called prefetch reads. The demand read and all prefetch reads must be of the same size (16 or 32 bits). The options are: Enabled, Disabled.

### **Primary Master PIO**

Allows an automatic or a manual configuration of the PCI primary IDE hard disk (master) mode. The options are: Auto, Mode 0, Mode 1, Mode 2, Mode 3, Mode 4.

### **Primary Slave PIO**

Allows an automatic or a manual configuration of the PCI primary IDE hard disk (slave) mode. The options are: Auto, Mode 0, Mode 1, Mode 2, Mode 3, Mode 4.

### **Secondary Master PIO**

Allows an automatic or a manual configuration of the PCI secondary IDE hard disk (master) mode. The options are: Auto, Mode 0, Mode 1, Mode 2, Mode 3, Mode 4.



---

### Secondary Slave PIO

Allows an automatic or a manual configuration of the PCI secondary IDE hard disk (slave) mode. The options are: Auto, Mode 0, Mode 1, Mode 2, Mode 3, Mode 4.

### Primary Master UDMA

Allows you to select the first PCI IDE channel of the first master hard disk mode or to detect it by the BIOS if the hard disk supports UDMA (Ultra DMA, faster than DMA). The options are: Auto, Disabled.

### Primary Slave UDMA

Allows you to select the first PCI IDE channel of the first slave hard disk mode or to detect it by the BIOS if the hard disk supports UDMA (Ultra DMA, faster than DMA). The options are: Auto, Disabled.

### Secondary Master UDMA

Allows you to select the second PCI IDE channel of the secondary master hard disk mode or to detect it by the BIOS if the hard disk supports UDMA (Ultra DMA, faster than DMA). The options are: Auto, Disabled.

### Secondary Slave UDMA

Allows you to select the second PCI IDE channel of the secondary slave hard disk mode or to detect it by the BIOS if the hard disk supports UDMA (Ultra DMA, faster than DMA). The options are: Auto, Disabled.

### VIA OnChip PCI Device

#### VIA-3058 AC97 Audio

It allows users to disable AC97 link in South Bridge.  
The options are: Auto, Disabled.

### Init Display First

When you install a PCI VGA card on the board, this feature allows you to select the first initiation of the monitor display from PCI or onboard AGP.  
The options are: PCI Slot, AGP.

### OnChip USB Controller

Disable this option if you are not using the onboard USB feature.  
The options are: Disabled, Enabled.

### USB Keyboard Support

When a USB keyboard is installed, please set at Enabled.  
The options are: Disabled, Enabled.

### IDE HDD Block Mode

When enabled, the system executes read/write requests to hard disk in block mode. The options are: Enabled, Disabled.

### Onboard Lan Device

This feature allows users to enable or disable the onboard Lan device.  
The options are: Enabled, Disabled.

### Onboard Lan Boot ROM

This feature allows users to enable or disable the onboard Lan boot ROM to boot system.  
The options are: Enabled, Disabled.

### Onboard FDD Controller

When enabled, the floppy diskette drive (FDD) controller is activated.  
The options are: Enabled, Disabled.

### Onboard Serial Port 1

If the serial port 1 uses the onboard I/O controller, you can modify your serial port parameters. The options are: 3F8/IRQ4, 3E8/IRQ4, 2F8/IRQ3, 2E8/IRQ3, Disabled, Auto.

### Onboard Serial Port 2

If the serial port 2 uses the onboard I/O controller, you can modify your serial port parameters. The options are: 2F8/IRQ3, 3E8/IRQ4, 2E8/IRQ3, 3F8/IRQ4, Disabled, Auto.

### UART 2 Mode

Select an operating mode for the second serial port. Set at Standard, if you use COM2 as the serial port as the serial port, instead as an IR port. The options are: Standard, ASKIR, HPSIR.

---

### IR Function Duplex

This feature is available only if the above item, UART2 Mode, is set at ASKIR or HPSIR. It allows you to select the infrared data transaction way. The options are: Half, Full.

### TX, RX Inverting Enable

This feature is available only if the above item, UART2 Mode, is set at ASKIR or HPSIR. It allows you to select the active signals of the reception end and the transmission end.

The options are: No, Yes; Yes, Yes; No, No; Yes, No.

### Onboard Parallel Port

Allows you to select from a given set of parameters if the parallel port uses the onboard I/O controller.

The options are: 378/IRQ7, 278/IRQ5, 3BC/IRQ7, Disabled.

### Onboard Parallel Port Mode

Allows you to connect with an advanced printer.

The options are: Normal, EPP, ECP, ECP/ECP.

### ECP Mode Use DMA

This feature allows you to select Direct Memory Access (DMA) channel if the ECP mode is selected. The options are: 3, 1.

### Parallel Port EPP Type

This feature allows you to select the EPP type for the parallel port.

The options are: EPP1.9, EPP1.7.

### Onboard Legacy Audio

Set Audio to be compatible with legacy mode.

The options are: Enabled, Disabled.

### SB I/O Base Address

This feature allows you to select the SB I/O base address, if the onboard Legacy audio is chosen. The options are: 220H, 240H, 260H, 280H.

### SB IRQ Select

This feature allows you to select the SB IRQ, if the onboard Legacy audio is chosen. The options are: IRQ 5, IRQ 7, IRQ 9, IRQ 10.

### SB DMA Select

This feature allows you to select the SB DMA channel, if the onboard Legacy audio chosen.

The options are: DMA 1, DMA 2, DMA 3, DMA0.

### MPU-401

This feature allows you to enable MPU-401, if the onboard Legacy audio chosen. The options are: Disabled, Enabled.

### MPU-401 I/O Address

This feature allows you to select the MPU-401 I/O address, if the onboard Legacy audio chosen.

The options are: 310-313H, 320-323H, 330-333H, 300-303H.

### Game Port (200-207H)

This feature allows you to select the game port (200-207H), if the onboard Legacy audio chosen.

The options are: Enabled, Disabled.

## Power Management Setup

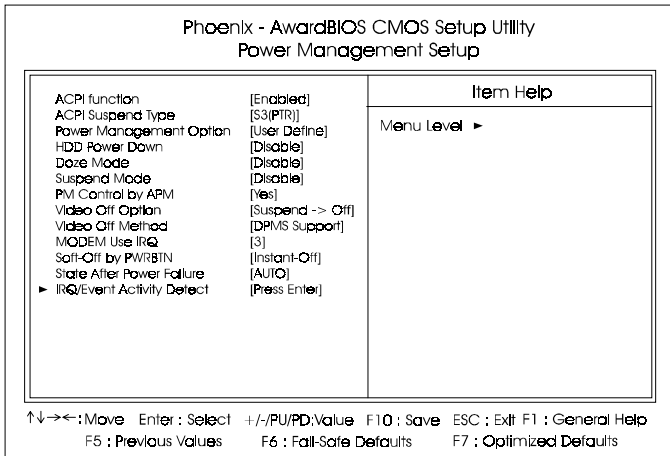

---

### ACPI Function

This item allows you to disable the ACPI function.  
The options are: Enabled, Disabled.

### ACPI Suspend Type

This item allows you to select suspend mode when the system in ACPI mode. The options are: S1 (POS), S3 (PTR), S1&S3.

### Power Management

This item allows you to adjust the power management features.  
Select User Define for configuring your own power management features.  
Min Saving initiates all predefined timers in their minimum values. Max Saving, on the other hand, initiates maximum values.  
The options are: User Define, Min Saving, Max Saving.

### HDD Power Down

The option lets the BIOS turn the HDD motor off when system is in Suspend mode. Selecting 1 Min..15 Min allows you define the HDD idle time before the HDD enters the Power Saving Mode.  
The options 1 Min..15 Min will not work concurrently. When HDD is in the Power Saving Mode, any access to the HDD will wake the HDD up.  
The options are: Disabled, 1 Min..15 Min.

### Doze Mode

When disabled, the system will not enter Doze mode. The specified time option defines the idle time the system takes before it enters Doze mode.  
The options are: Disable, 1, 2, 4, 6, 8, 10, 20, 30, 40 Min, 1 Hour.

### Suspend Mode

When disabled, the system will not enter Suspend mode. The specified time option defines the idle time the system takes before it enters Suspend mode. The options are: Disable, 1, 2, 4, 6, 8, 10, 20, 30, 40 Min, 1 Hour.

### PM Control by APM

The option No allows the APM (Advanced Power Management) specification be ignored. Selecting Yes will allow the BIOS wait for APM's prompt before it enters Doze mode, Standby mode, or Suspend mode. If the APM is installed, it will prompt the BIOS to set the system into power saving mode when all tasks are done. The options are: No, Yes.

### Video Off Option

This feature provides the selections of the video display power saving mode. The option Suspend - Off allows the video display to go blank if the system enters Suspend mode. The option All Modes - Off allows the video display to go blank if the system enters Doze mode or Suspend mode. The option Always On allows the video display to stay in Standby mode even when the system enters Doze or Suspend mode.

The options are: Suspend - Off, All Modes -> Off, Always On.

### MODEM Use IRQ

This feature allows you to select the IRQ# to meet your modem IRQ#.

The options are: NA, 3, 4, 5, 7, 9, 10, 11.

### Soft-Off by PWR-BTTN

The selection Delay 4 Sec. will allow the system shut down after 4 seconds after the power button is pressed. The selection Instant-Off will allow the system shut down immediately once the power button is pressed.

The settings are: Instant-Off, Delay 4 Sec.

### State After Power Failure

The item allows you to select the state that your personal computer returns to after a power failure. If set at Off, the system will not boot after a power failure. If set On, the system will restart after power failure.

The settings are: Auto, On, Off.

### *IRQ/Event Activity Detect*

### USB Resume From S3

When set at Enabled, it allows USB devices that linked with the system to activate the system from ACPI S3 power saving mode.

The options are Disabled, Enabled.

### VGA

When set at On, any VGA activity will awake the system.

The options are: OFF, ON.

### LPT & COM

When LPT/COM is selected, any access of LPT and COM ports will awake the system. Likewise, either LPT or COM is chosen, the system will be awoken by any activity of LPT or COM port.

The options are: LPT/COM, LPT, COM, NONE.

### HDD & FDD

When it is set at ON, any access happened at hard drives and floppy drives will awake the system.

The options are: OFF, ON.

### PCI Master

To set this feature at ON activates that Power Management feature (PM) wake-up event for the PCI bus master card.

The options are: OFF, ON.

### PowerOn by PCI Card

When set at Enabled, any PCI-PM event awakes the system from a PCI-PM controlled state.

The options are Disabled, Enabled.

### Modem Ring Resume

An input signal on the serial Ring Indicator (RI) line (in other words, an incoming call on the modem) awakes the system from a soft off state.

The options are: Enabled, Disabled.

### RTC Alarm Resume

*Enabled* allows you to set the time the system will be turned on from the system power-off status. The options are: Enabled, Disabled.

### Date (of Month)

This feature allows you to set the day of the alarm starts when the RTC Alarm Resume From Soft Off is set to be Enabled. The options are: 0, 1..31.

### Resume Time (hh:mm:ss)

If an ATX power supply is installed and when RTC Alarm Resume is Enabled, this feature allows you to set the time of the alarm starts when the RTC Alarm Resume From Soft Off is set to be Enabled.

The options are: 7: 0: 0. hh (*hour*) - 0, 1, 2,..., 23; mm (*minute*) - 0, 1, 2,...,59; ss (*second*) - 0, 1, 2,...,59.

### IRQs Activity Monitoring

After the time period which you set, the system advances from doze mode to suspend mode in which the CPU clock stops and the screen display is off. At this moment, if the IRQ activity occurs, the system goes back to full-on mode directly. If the IRQ activity which is defined as Non Primary takes place, the system remains off until the corresponding IRQ handler finishes. The options of IRQ 3, 4, 5, 6, 7, 8, 9, 10, 11, 12, 13, 14, 15 are: Enabled, Disabled.

## PnP/PCI Configurations

Chapter 3  
BIOS Setup

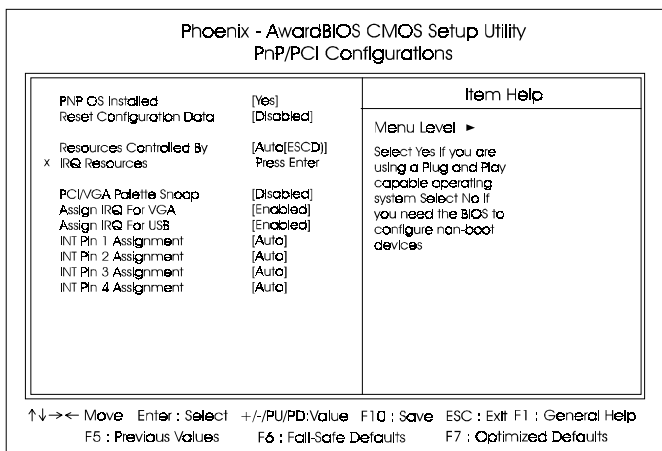

### PnP OS Installed

If your operating system is a Plug-and-Play one, such as Windows NT, Windows 95, select Yes. The options are: No, Yes.



---

### Reset Configuration Data

Enabling it to reset the system Extended System Configuration Data (ESCD) when you exit Setup if you have installed a new add-on card and the system reconfiguration has caused such a serious conflict that the operating system can not boot. The options are: Disabled, Enabled.

### Resources Controlled By

If set at Auto, the BIOS arranges all system resources. If there exists conflict, select Manual. The options are: Auto (ESCD), Manual.

The manual options of **IRQ- / DMA-** assigned to are: PCI/ISA PnP, Legacy ISA.

### PCI/VGA Palette Snoop

Set this feature to be enabled if any ISA adapter card installed in the system requires the VGA palette snoop function.

The options are: Disabled, Enabled.

### Assign IRQ For VGA

If your PCI VGA card devices do not need an IRQ, select Disabled; therefore, an IRQ can be released for the system use.

The options are: Enabled, Disabled.

### Assign IRQ For USB

If your USB devices do not need an IRQ, select Disabled; therefore, an IRQ can be released for the system use.

The options are: Enabled, Disabled.

### INT Pin 1/2/3/4 Assignment

This feature allows you to assign the PCI IRQ numbers for PCI slots. Selecting the default, Auto, allows the PCI controller to automatically allocate the IRQ numbers.

The options are: Auto, 3, 4, 5, 7, 9, 10, 11, 12, 14, 15.

## PC Health Status

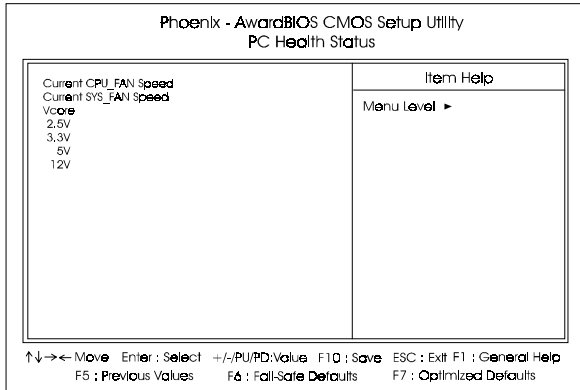

It allows you and technicians to monitor data provided by the BIOS on this mainboard. Some of them are not user-configurable.

**Current CPU\_FAN Speed / Current SYS\_FAN Speed / Vcore / 2.5V / 3.3V / 5V / 12V**

These items allow end users and technicians to monitor data such as CPU and case cooling fans rotating speed.

## Frequency/Voltage Control

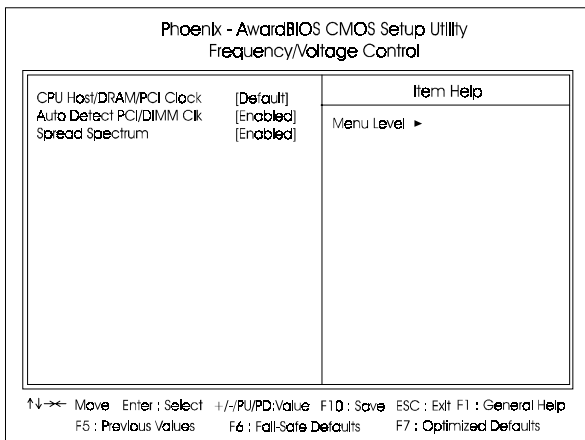

### CPU Host/DRAM/PCI Clock

This feature allows you to select the combinations of CPU frequency, inslot DRAM frequency, and PCI clock. The default setting, Default, will detect this combination automatically. If you set a unappropriate option which leads to a booting problem, keep pressing the Insert key until the display appears will solve it. The options lists all combinations that provided by the system BIOS.

### Auto Detect DIMM/PCI Clk

When enabled, BIOS will detect the PCI slot and DIMM slot. If no any device in, BIOS will auto disable its clock.

The options are: Enabled, Disabled.

### Spread Spectrum

This feature is used to disable the spread Spectrum function.

The options are: Enabled, Disabled.

## Load Fail-Safe Defaults

This submenu is selected to diagnose the problem after the computer boots, if the computer will not boot. These settings do not give optimal performance.

## Load Optimized Defaults

This submenu is selected for default settings which provide the best system performance.

## Supervisor/User Password

To enable the Supervisor/User passwords, select the item from the Standard CMOS Setup. You will be prompted to create your own password. Type your password up to eight characters and press Enter. You will be asked to confirm the password. Type the password again and press Enter. To disable password, press Enter twice when you are prompted to enter a password. A message appears, confirming the password is disabled.

Under the BIOS Feature Setup, if *Setup* is selected under the Security Option field and the Supervisor/User Password is enabled, you will be prompted password every time you try to enter the CMOS Setup Utility. If *System* is selected and the Supervisor/User Password is enabled, you will be requested to enter the Password every time when you reboot the system or enter the CMOS Setup utility.

## Save and Exit Setup

After you have made changes under Setup, press Esc to return to the main menu. Move cursor to Save and Exit Setup or press F10 and then press Y to change the CMOS Setup. If you did not change anything, press Esc again or move cursor to Exit Without Saving and press Y to retain the Setup settings. The following message will appear at the center of the screen to allow you to save data to CMOS and exit the setup utility: **SAVE to CMOS and EXIT (Y/N)?**

## Exit without Saving

If you select this feature, the following message will appear at the center of the screen to allow you to exit the setup utility without saving CMOS modifications: **Quit Without Saving (Y/N)?**

### The AT31 Mainboard Manual Updated

The mainboard manual were updated since it was printed.

#### 1). Page 1-4:

##### ■ Easy Installation

BIOS with support for Plug and Play, auto detection of IDE hard drives, LS-120 drives, IDE ZIP drives. *The mainboard supports Windows 2000, Windows XP only.*

#### 2). Page 2-12:

The TV-OUT bracket with cable is optional.

The two jacks on the optional TV-OUT bracket can not be used at the same time.



#### 3). Page 2-17:

If your mainboard version is **1.3**, a conversion cable is provided for Intel spec. USB pin assignments.

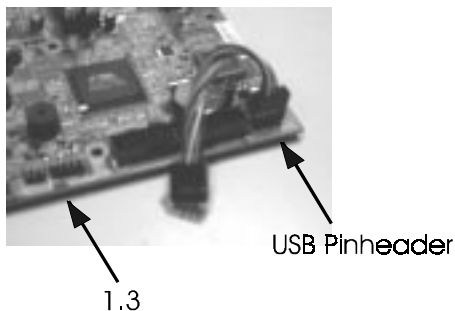

---

4). *Page 2-3, 2-7:*

The allowed settings of CPU/SDRAM/PCI/AGP freq. are listed below:

***CPU/SDRAM/PCI/AGP Freq. Select***

	<b>J7</b>	<b>CPU</b>	<b>SDRAM</b>	<b>PCI</b>	<b>AGP</b>
<i>(Default)</i>	OFF	100.00	100.00	33.33	66.67
	ON	133.33	133.33	33.33	66.67

*(unit: MHz)*

