

VL/I-486SV2G, VL/I-486SV2GX4

VL & ISA Bus, 486 Green PC Mainboard

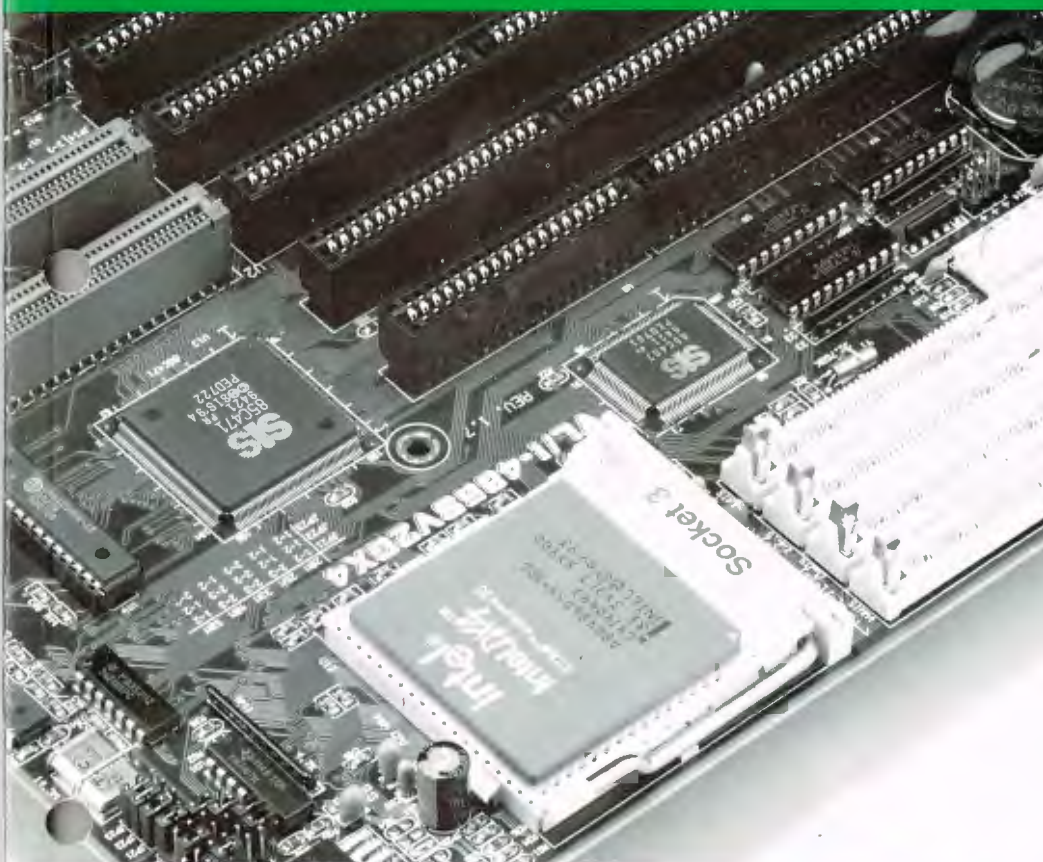

USER'S MANUAL

Chapter 1: Feature Guide	1-1
How The Manual Is Organized	1-1
Main Features	1-2
Static Electricity Precautions	1-4
Mainboard Layout	1-4
Using Your Mainboard	1-6
Hardware Settings	1-6
The System Configuration Record	1-8
Power Conservation	1-9
Expansion Slots	1-9
Enhanced IDE Features	1-10
Special Key Commands	1-12
CPU Speed	1-12
Chapter 2: Upgrade Guide	2-1
Installing Expansion Cards	2-2
Installation Procedure	2-2
Upgrading System Memory	2-4
Configuring System Memory	2-5
Installing SIMMs	2-8
Installing A CPU Upgrade	2-10
Chapter 3: Software Guide	3-1
Award BIOS	3-1
Standard CMOS Setup	3-3
BIOS Features Setup	3-8
Chipset Features Setup	3-12
Power Management Setup	3-13
Load BIOS Defaults	3-18
Load Setup Defaults	3-19
Setting Supervisor & User Passwords	3-20
IDE HDD Auto Detection	3-21
Save And Exit Setup	3-23
Exit Without Saving	3-23

Chapter 4: Technical Summary 4-1

- Jumper Setting Summary 4-1
- Battery Source Selection: JP1 4-1
- SMI Out Connector: JP2-4 4-2
- Hardware Trap Settings: JP5 &6 4-2
- On-board PS/2 Mouse Selection: JP7 4-3
- DMA Selection: JP8 4-3
- Video Display Type: JP9 4-3
- SMI Switch Control: JP10 4-4
- Cyrix/Intel CPU Selection: JP11 4-4
- Level 2 Cache Size: JP13, JP14 & JP27 4-5
- CPU Type Selection: JP16-22 4-9
- CPU External Clock Speed Selection: JP23 – JP25 4-12
- VESA Clock Delay: JP26 4-13
- Cache Size: JP27 4-13
- VL-Bus Clock & Wait State Selection: JP28 – JP29 4-14
- Intel DX4/Cyrix DX2-V Voltage Selection: JP32 4-14
- Memory Subsystem 4-15
- DRAM Specifications: 4-15
- Memory Configurations 4-15
- Level 2 Cache Options 4-15
- Connectors 4-15

Feature Guide

This manual explains how to use this system mainboard and install upgrades. It has an overview of the design and features of the board and provides useful information if you want to change the configuration of the board, or a system it is installed in.

How The Manual Is Organized

This manual is divided into four chapters:

- Feature Guide – an overview of the board features
- Upgrade Guide – upgrades for the board or system
- Software Guide – the Setup Utility and other software & firmware
- Technical Summary – technical reference

The manual assumes that your mainboard is already installed in a computer system, so we've organized the contents to reflect this. The first chapter introduces the mainboard's features and shows where things are on the board in case you want to install an upgrade.

Chapter 2 explains how to install upgrades.

Chapter 3 explains the Award BIOS Setup Utility.

Chapter 4 lists settings and specifications and has instructions for adding cache memory.

Since we are assuming that your mainboard is already installed in a system, it was most likely set up by your system dealer according to the design specifications of your computer. This could mean that your mainboard's current settings are not the same as the defaults shown in this manual. Your system manual may have additional information on how the mainboard should be set up.

If you want to change the existing configuration, consult all of your system documentation. Also be certain that opening up and working on the system yourself won't violate your system warranty. Most system vendors do allow you to open the system to install expansion cards or additional peripheral equipment.

This manual provides all the information you need to upgrade or change the setup of the board. If you don't feel confident of your ability to work on the computer yourself, ask your dealer or a qualified technician to do it for you.

Main Features

The VL/I-486SVGO has many performance and system features integrated onto the mainboard, including the following:

- Supports most 486-type CPUs, Pentium OverDrive CPUs and SL Enhanced 486 CPUs, both 5-volt and 3.3-volt, from Intel and other vendors. Uses a 'Socket 3' ZIF (Zero Insertion Force) socket for easy installation. The GX4 model also supports the Intel 486DX4 low voltage CPU.

Also supports some CPUs from AMD and Cyrix.

- Uses SL Enhanced CPU power management features with Power Management control built into the Setup Utility.
- Compatibility with EPA "Energy-Star" specifications and operating system power management utilities (e.g. Microsoft APM).
- Uses 72-pin DRAM SIMM modules in multiple configurations up to 64MB, for flexible and economical system memory upgrades.

- High-performance write-back "Level 2" external static RAM cache in four size options: 128KB, 256KB, 512KB, and 1MB, using 32K8, 64K8 or 128K8 SRAM chips.
- Double bus design with 5 ISA and 2 ISA/VL-Bus expansion slots, some with Bus Master capability.
- System BIOS support for Enhanced IDE including up to four IDE hard disks or other IDE devices and support for hard disks larger than 528MB and up to 8.4GB. When used with a separate IDE controller card that supports Enhanced IDE, support for four IDE devices in two channels, faster data transfer rates and direct support for IDE devices such as Tape Backup and CD-ROM drives.
- Auto detection of installed IDE hard disk drives with an auto-detection utility built into the system BIOS.
- Switch connector for a manual suspend button mounted on a system case.
- The power management scheme works with any monitor. If you are using a "non-green" monitor, you can still use the video shut-down feature by connecting it to your system power supply if it has "green" features. The power supply, in turn, connects to the JP2-4 connector and will shut down the monitor when power management scheme initiates.

Static Electricity Precautions

Under the right conditions, static electricity will build up. If you touch the mainboard or other sensitive components, the build-up will discharge into the components and circuitry. Computer components are sensitive to damage from static electric discharge. They can be damaged or destroyed if the discharge is powerful enough. Static build-up is most likely to occur in dryer and cooler conditions, but it is always important to be cautious.

To protect the mainboard and other components against damage from static electric discharge, you should follow some basic precautions whenever you handle them:

1. Use a grounding wrist strap. The strap will have an 'alligator' clip at the end of a shielded wire lead. Clip it to a grounded object. Any static electricity will then harmlessly discharge through the strap. Put on and connect the strap *before* you handle the components.
2. Use an anti-static pad. Put any components on the pad whenever you work on them outside the computer. If you don't have a pad, put the components on the anti-static bag they came in.

Both the wrist strap and pad are inexpensive and are generally available from computer supply companies.

Mainboard Layout

The diagram on the next page shows the location of important components on the mainboard. There are other small diagrams later in the manual that point out the location of the topic being explained.

VL/I-486SV2G/GX4 Layout

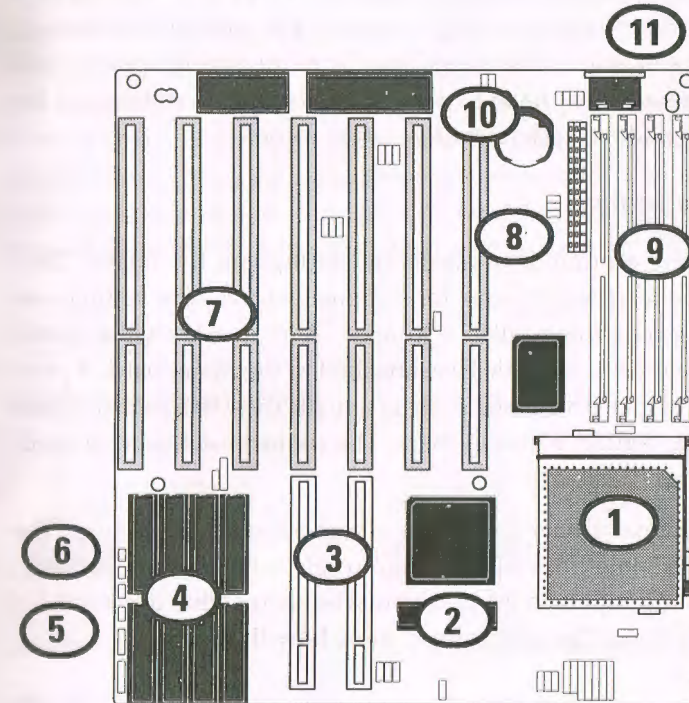

- | | |
|-------------------------------------|--|
| 1. ZIF Socket 3/PGA CPU | 7. ISA expansion slots |
| 2. Level 2 cache Tag SRAM chip | 8. Cable connector for 'green' power supply extra lead , JP2-4 |
| 3. VESA expansion slots | 9. SIMM module sockets |
| 4. Level 2 cache SRAM chips | 10. Replaceable On-board Lithium battery for CMOS support |
| 5. Case feature connectors | 11. Keyboard connector |
| 6. Suspend switch connector, SMI_SW | |

Using Your Mainboard

In addition to the operating instructions in your system manual, there are a few additional things specific to the mainboard you will need to know. These have to do with the hardware settings on the mainboard and the system configuration record.

Hardware Settings

There are a number of hardware settings on the board. They specify configuration options for various features. The settings are made using something called a 'jumper'. A jumper is a set of two or more metal pins in a plastic base attached to the mainboard. A plastic jumper 'cap' with a metal plate inside fits over two pins to create an electrical contact between them. The contact establishes a hardware setting.

Some jumpers have two pins, others have three or more. The jumpers are sometimes combined into sets called jumper 'blocks', where all the jumpers in the block must be set together to establish a hardware setting. The next figures show how this looks.

Jumpers and caps



Jumper cap

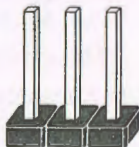

3-pin jumper



2-pin jumper

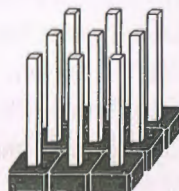

Jumper block

Setting options for most jumpers are printed on the board in a stylized bird's-eye view, with which pins to connect for each setting marked by a bar connecting two pins. For example, if a jumper has three pins, connecting, or 'shorting', the first and second pins creates one setting and shorting the second and third pins creates another. The same type of diagrams are used in this manual. The jumpers are always shown from the same point of view as shown in the whole-board diagram in this chapter. The next figures show what the manual diagrams look like and what they represent.

Jumper diagrams

Jumpers are shown like this

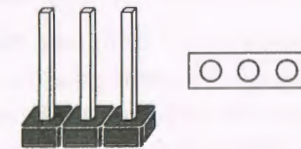
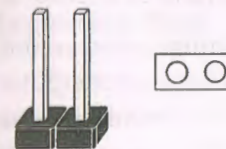

Jumper caps like this



Jumper settings like this

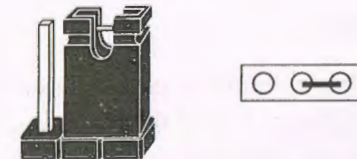

Jumpers in a 'block'



Some jumpers are oriented vertically; if the pin position needs to be shown, Pin 1 is marked.

The System Configuration Record

All personal computers use a BIOS (Basic Input Output System) as the basic software that tells the computer how to function. In order for the BIOS to function, there has to be a record of the computer's hardware and configuration settings for it to refer to. This record is created by using a software program that is permanently stored in the BIOS ROM chip on the mainboard. The program is called the CMOS Setup Utility.

The system configuration record the utility creates is also stored on the mainboard. Unlike the utility program, the record is not recorded permanently. The memory it gets stored in must be maintained by battery power when the computer is turned off. If battery support fails, the record will be lost and you will have to recreate it.

When you buy your computer, the system configuration record will already be set. The settings will be optimized for your computer hardware and may vary from the basic defaults. You should run the Setup Utility when you first use your computer. Write down the settings. There is an explanation of how to run the Setup Utility in Chapter 3.

Important:

In some circumstances it is possible the configuration record may be corrupted or lost. If this happens, your computer will not work properly the next time you turn it on. This is not a serious problem. To fix it, run the Setup Utility and re-enter your configuration from your written record. When you restart the computer, it will work normally.

Power Conservation

This mainboard incorporates the latest power conservation technology, and meets the USA Environmental Protection Agency's (EPA) "Energy Star" specifications. The BIOS Setup Utility controls the board's power management system. For more information see the section on Power Management Setup in Chapter 3. To take advantage of its energy saving capabilities, the mainboard must have an SL Enhanced or compatible CPU installed.

The power management system provides several power saving modes and includes a connector for a manual Suspend Mode switch that mounts on the system case. If your case has one of these, you can Suspend the system at anytime by pressing the button.

Expansion Slots

There two types of expansion slot on this mainboard. Five of the slots are industry-standard ISA slots in which you can use any ISA expansion card. There are two more ISA slots that are also the upper part of the two VL-Bus local bus slots. You can use either ISA or VL-Bus expansion cards in these two slots. The VL-Bus local bus slots can both function as Bus Masters.

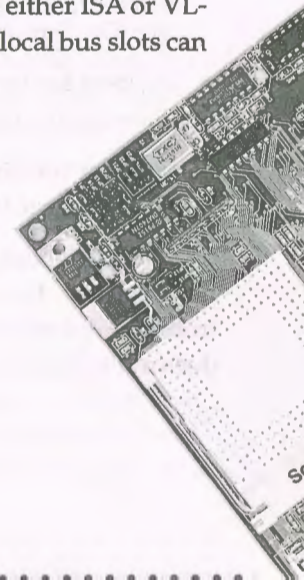

Enhanced IDE Features

This mainboard has several feature enhancements for IDE hard disk drives and support for other IDE devices.

The original IDE implementation was limited to two hard disk drives with relatively slower data transfer rates. While this solution is simple and reliable, it has some limitations that have become more significant as the performance level of other system components and overall system performance have increased dramatically with the advent of new microprocessor, expansion bus and operating system technologies.

In response to these demands, the IDE specification has been updated to increase its capabilities and provide improved performance. Together these are referred to as 'Enhanced IDE'. Enhanced IDE features comprise the following:

- Support for IDE hard disk drives larger than the former 528MB limit imposed by various technical factors.
- Support for IDE devices other than hard disk drives, including IDE Tape Backup and CD-ROM drives.
- Support for two IDE channels with two devices per channel, allowing the use of four IDE devices in one system.
- Support for faster data transfer rates, particularly with IDE controller cards that have a PCI local bus interface.

This mainboard either directly supports or allows the use of these new features. The features also depend on your having an IDE controller card that supports Enhanced IDE. If you use a controller that does not have this support these features will not be available.

Large IDE Hard Disks

For IDE hard disk drives, the BIOS provides three modes to support both normal IDE hard disks and also drives larger than 528MB:

Normal – for IDE drives smaller than 528MB

Large – for drives larger than 528MB that do not use LBA. These can only be used with the MS-DOS operating system.

LBA – for drives larger than 528MB and up to 8.4 GB (GigaBytes) that use Logic Block Addressing mode.

Other IDE Devices

Enhanced IDE allows the use of IDE devices other than hard disks. Two devices that previously required non-standard or adapted interfaces and are now available as standard IDE devices are Tape Backup and CD-ROM drives. These will now be able to take advantage of the ease of installation, lower cost and in some cases superior performance of Enhanced IDE, putting an end to the system configuration complications created by their earlier interfaces.

To use IDE devices other than hard disks with this mainboard you may need to install a device driver in your system software configuration. Refer to the documentation that comes with any device you will install for instructions about this and any other installation requirements.

Dual IDE Channel Support

If you have a controller card with the support and interface connectors for it, you can connect up to four IDE peripheral devices to your system. With the Enhanced IDE features you can select two devices to each connector. All devices are categorized the same way IDE hard disks have been, with one device set as the "Master" device and the second as the "Slave" device.

Faster Data Transfer

Enhanced IDE includes a scheme to support a significant increase in the rate of data transfer from the IDE device to the rest of the system compared to the previous standard. One aspect of this scheme is support for the Mode 3 timing scheme. If you use both a controller and hard disks that support Mode 3 operation with this mainboard you can increase the data transfer rate up to as much as 11MB per second.

Special Key Commands

This mainboard supports some keyboard commands that control the CPU speed and the internal and external caches.

CPU Speed

You can switch the CPU speed between full speed and slow speed with the following commands:

<Alt> + <Ctrl> + <- >

Slow speed

<Alt> + <Ctrl> + <+ >

Full speed

Normally you should use the full speed mode.

In the above commands, you should use the plus and minus keys on the numeric keypad.

Upgrade Guide

This section explains how to install options on your mainboard. It covers the most likely and technically accessible upgrades you might want to do, including adding expansion cards, increasing system memory, changing the CPU chip and adding IDE hard disks.

Installing upgrades will either improve the performance of your computer, or add some additional capabilities to it. You can install upgrades yourself, or have your dealer or a qualified computer technician do it for you.

It is also possible to increase the size of the Level 2 Cache, but since this is a much more technically demanding upgrade that you are both less likely to undertake, and in most cases would probably require at least partially disassembling your system, the technical reference information about it is in Chapter 4. It is probably best to have a qualified technician perform a Cache upgrade for you.



Installing Expansion Cards

There are many ISA and VL-Bus expansion cards you can install in your system to expand its capabilities. Any card you get will come with instructions on how to configure and install it. For your reference, we have included a brief description here of how to install a card in your system case.

Installation Procedure

Expansion cards often require pre-installation configuration and sometimes post-installation software setup. Check your card documentation for instructions on this. Once you have configured an expansion card you want to install, the installation procedure is fairly simple. Your system manual should have instructions for installing expansion cards specific to the design of your system case. The procedure here covers the basics for your reference.

Before you start, always make sure the computer is turned off. You should also make sure to observe standard static electricity discharge precautions. You can damage your expansion card, the mainboard, or both by not being careful about this.

The basic procedure for installing expansion cards is the same for both types. The components on ISA and VL-Bus cards will face to the right as you view the computer from the front.

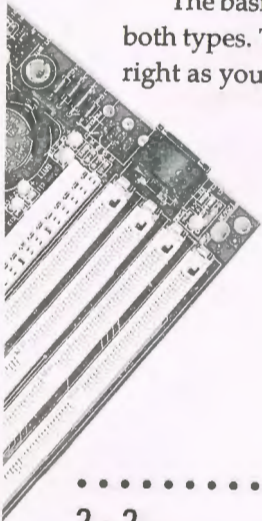

The basic procedure is as follows:

1. Open the system case to gain access to the expansion slots.
2. Remove the slot-cover corresponding to the slot you want plan to use. Put the slot-cover retaining screw aside and store the slot cover in case you need it later.
3. Remove the card from its protective packaging if you haven't already.
4. Align the card's slot connectors to the slot. Keep the card at a 90° angle to the mainboard. Insert the card into the slot by pressing it firmly downward. If there is a lot of resistance, make sure the slot connectors are lined up correctly.
5. Attach the card's mounting bracket to the case using the slot cover screw you put aside in Step 2.
6. Close the case, turn on the computer and check to see if the card is working properly, and do any software set up required.

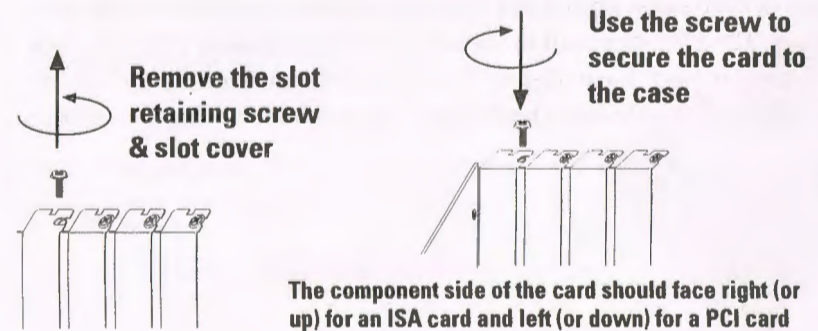

Upgrading System Memory

This section explains how to install more system memory. There are instructions on how to configure and install memory and an explanation of the technical specifications required.

System DRAM is the main source of data for the CPU. Data remains stored in DRAM as long as the system is turned on, and is lost when you turn it off. The Level 2 cache memory is Static RAM (SRAM), which is faster than DRAM memory. When the CPU looks for data, it first searches the cache. If the information is not there, the search continues in the DRAM. With this design, the CPU looks in the fastest source of data first, which lets it operate as fast as possible.

The DRAM subsystem uses memory chips permanently mounted on small circuit boards to form "SIMMs" (Single In-line Memory Modules). The memory chips have a speed rating that is measured in nanoseconds (ns). This mainboard requires fast page mode DRAM with a speed of at least 80ns.

This mainboard can use 72-pin SIMMs which can have chips on one or both sides. Both types of module come in a number of memory sizes. The SIMMs install in sockets on the mainboard. There are four 72-pin sockets. Each 72-pin SIMM socket functions as a memory 'bank', for a total of four banks. You add memory one bank at a time.

Configuring System Memory

If you want to add system memory, you must use the configuration options and specifications shown in this section.

Memory Combinations

You can configure the system memory in a variety of ways, using different combinations of SIMM modules.

The tables on the next two pages explain the configuration requirements and show possible combinations.

There are some requirements:

- **Sockets 0 & 2 can use either single or double-sided SIMMs of various sizes. Sockets 1 & 3 can use only single-sided SIMMs of various sizes. Module size options are:**
Single-sided – 1MB, 4MB, 16MB
Double-sided – 2MB, 8MB, 32MB

- **Memory Specifications:**

Module Size: 1MB, 2MB, 4MB, 8MB, 16MB, or 32MB

DRAM Mode: Fast Page Mode

DRAM Speed: 80ns (or faster)

RAS access time [Trac]: 60ns - 80ns

CAS access time [Tcac]: 10ns - 25ns

Parity: Either parity or non-parity

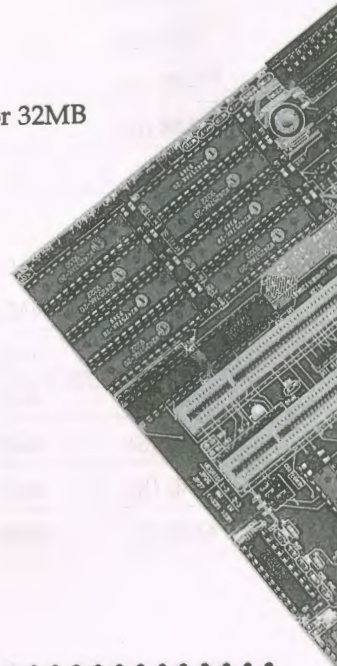

Possible Memory Configurations

SIMM Bank 0	SIMM Bank 1	SIMM Bank 2	SIMM Bank 3	Total
1MB (S)				1MB
1MB (S)	1MB (S)			2MB
1MB (S)	1MB (S)	4MB (S)		6MB
1MB (S)	1MB (S)	4MB (S)	4MB (S)	10MB
1MB (S)	1MB (S)	8MB (D)		10MB
1MB (S)	1MB (S)	16MB (S)		18MB
1MB (S)	4MB (S)			5MB
1MB (S)	16MB (S)			17MB
2MB (D)				2MB
2MB (D)		4MB (S)		6MB
2MB (D)		4MB (S)	4MB (S)	10MB
2MB (D)		8MB (D)		10MB
2MB (D)		16MB (S)		18MB
4MB (S)				4MB
4MB (S)	4MB (S)			8MB
4MB (S)	4MB (S)	4MB (S)		12MB
4MB (S)	4MB (S)	4MB (S)	4MB (S)	16MB
4MB (S)	4MB (S)	8MB (D)		16MB
4MB (S)	4MB (S)	16MB (S)		24MB
4MB (S)	4MB (S)	16MB (S)	16MB (S)	40MB
4MB (S)	4MB (S)	32MB (D)		40MB

SIMM Bank 0	SIMM Bank 1	SIMM Bank 2	SIMM Bank 3	Total
4MB (S)	16MB (S)			20MB
4MB (S)	16MB (S)	16MB (S)		36MB
8MB (D)				8MB
8MB (D)		8MB (D)		16MB
8MB (D)		4MB (S)		12MB
8MB (D)		4MB (S)	4MB (S)	16MB
8MB (D)		16MB (S)		24MB
8MB (D)		16MB (S)	16MB (S)	40MB
8MB (D)		32MB (D)		40MB
16MB (S)				16MB
16MB (S)	16MB (S)			32MB
16MB (S)	16MB (S)	16MB (S)		48MB
16MB (S)	16MB (S)	16MB (S)	16MB (S)	64MB
16MB (S)	16MB (S)	32MB (D)		64MB
32MB (D)				32MB
32MB (D)		32MB (D)		64MB

(S) = single-sided SIMM (D) = double-sided SIMM

Installing SIMMs

To install a SIMM follow these instructions:

1. Modules will only insert in a socket in one orientation. The sockets are designed to prevent you from inserting modules the wrong way. See the figures at right.
2. Press the module edge connector into the socket at a moderate angle to the board. See the figures below.
3. Press the module forward onto the positioning pins so that they go into the circular holes at each end of the module.
4. The module should click into place, as the retaining clips at each end of the socket snap over the edge of the module to secure it in place.
5. Repeat this procedure for each module you install.

Installing a Memory Module

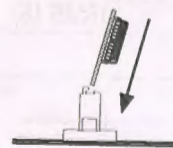

Insert the SIMM into the socket at an angle.



Press it forward onto the positioning pins.



The retaining clips should fit over the edge and hold the SIMM in place.

Module Sockets & Orientation

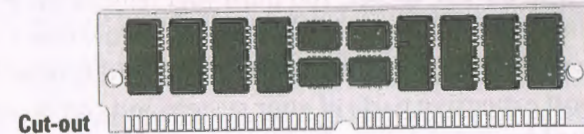

Cut-out

SIMMs have a cut-out at one end that matches an extension on one of the vertical posts of each socket.

Put orientation cut-out at this end.

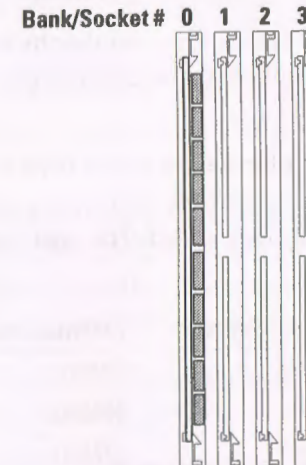

Installing A CPU Upgrade

If you want to improve your system performance, you can install an upgrade CPU in the ZIF socket. You must first remove the existing CPU, and then set the CPU selection jumpers for the new CPU. Be sure to follow static electricity precautions very carefully. The CPU is one of the most expensive parts of your system and can be damaged or destroyed by static electric discharge.

There are several jumpers you need to set when changing the CPU. The jumpers settings define these specifications:

CPU Type – the kind of CPU is installed

External Clock Speed – the external operation speed. This is also the speed the VL and PCI bus will operate at.

Intel DX4™ Internal Clock Speed – the number by which the external clock speed is multiplied, the result of which is the internal clock speed.

You must have all of this information ready before you can install a CPU upgrade. Remember that the chip speed will be listed according to the faster internal clock speed. The chart below shows some examples:

<i>CPU</i>	<i>Internal Speed</i>	<i>External Speed</i>
486DX-33 (or SX)	33MHz	33MHz
486DX2-50 (or SX2)	50MHz	25MHz
486DX2-66	66MHz	33MHz
486DX4-75	75MHz	25MHz
486DX4-100	100MHz	33MHz

To check what jumper settings are required to upgrade the CPU, refer to the Jumper Setting Summary in Chapter 4. Make sure to take full precautions against static electric discharge before you work on the board. To install an upgrade CPU first do as follows:

1. Identify the existing external clock speed setting on the board.

The external clock speed is set by jumpers JP23, JP24 and JP25, the options are 20, 25, 33, 40 or 50MHz.

2. Identify the external clock speed of the CPU you will install.

If the external clock speed is the same as the mainboard's existing setting, proceed. If it is different, change the jumper settings to the required speed.

3. Identify the CPU type and check what the required JP16-22 jumper settings are to set the CPU type.

4. Set JP5 & 6 for the CPU you are installing and set JP11 to the Cyrix setting if you are installing a Cyrix CPU. If you are installing an AMD CPU, you don't need to set JP11.

5. If you install a Cyrix DX2-V type CPU you MUST set jumper JP32 to the Cyrix DX2-V setting so that the voltage regulator is set correctly. The default setting is for Intel DX4, so you don't need to change the setting unless you install a Cyrix DX2-V.

6. If you install a CPU with a clock speed faster than 33MHz, change the JP28 and 29 to the 1W/>33MHz setting.

7. Once you have made any required jumper settings, you can install the CPU chip in the Socket 3 ZIF socket. Refer to the next page for instructions on this if you're not familiar with how to use the Zero Insertion Force socket.

Installing a CPU in the ZIF Socket

1. Make sure the ZIF socket lever is up. To raise the lever, pull it out to the side a little and raise it as far as it will go. Pin 1 is at the arm corner.

2. Align the CPU and socket Pin 1 corners. The pins on the bottom should align with the inner 3 rings of holes in the socket — unless you are installing Pentium technology.

3. Place the CPU in the socket. It should insert easily. If it doesn't, pull the lever up a little more.

4. Press the lever down. The plate will slide forward. You will feel some resistance as the pressure starts to secure the CPU in the socket. This is normal and won't damage the CPU.

When the CPU is installed, the lever should snap into place at the side of the socket.

Note: To remove a CPU, pull the lever out to the side a little and raise it as far as it will go. Lift out the CPU chip.

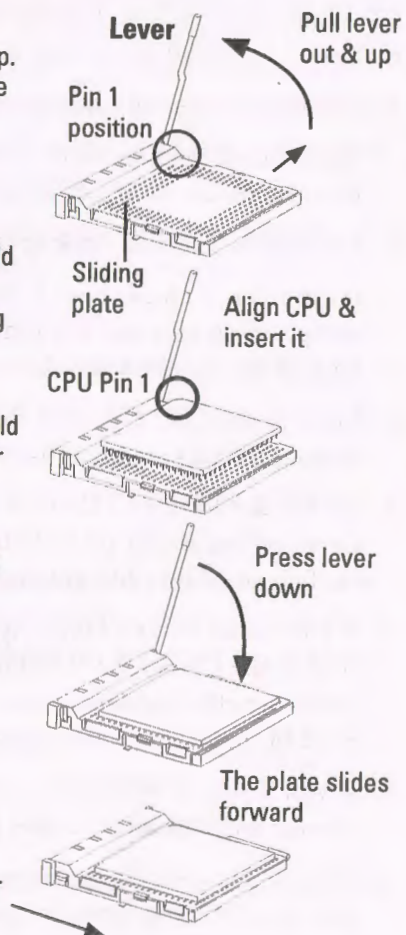

Software Guide

This chapter explains the Setup Utility for the Award BIOS, the SCSI BIOS and drivers, and the system BIOS flash memory update utility.

Award BIOS

All computer mainboards of this type have a 'Setup' utility program stored in the BIOS ROM that is used to create a record of the system configuration and settings. If you received your mainboard installed as part of a system, the proper entries have probably already been made. If so, you might want to call up the Setup Utility, as described later, to take a look at them, and perhaps record them for future reference, particularly the hard disk specifications.

If you are installing the board or reconfiguring your system, you'll need to enter new setup information. This section explains how to use the program and make the appropriate entries.

The Setup Utility is stored in the BIOS ROM. When you turn the computer on, a screen message appears to give you an opportunity to call up the Setup Utility. It displays during the POST (Power On Self Test). If you don't have a chance to respond, reset the system by simultaneously typing the <Ctrl>, <Alt> and <Delete> keys, or by pushing the 'Reset' button on the system cabinet. You can also restart by turning the system OFF then ON.

This message will then reappear:

TO ENTER SETUP BEFORE BOOT PRESS CTRL - ALT - ESC OR DEL KEY

"STANDARD CMOS SETUP" displays a screen with a list of entries. Follow the on-screen instructions to move around the screen. Instructions at the bottom of the screen list the controls for this screen. Use the arrow keys to move between fields, and the <Page Up> ('PU'), <Page Down> ('PD') or plus and minus keys to change the option shown in the selected field. Pressing <Shift>+<F2> changes the color scheme of the display, and <Esc> exits this level and returns to the main screen.

Modifiable fields appear in a different color. If you need information about what changes to make, press the <F1> key. The help menu will then give you information on the item highlighted. The display of available memory at the lower right-hand side of the screen functions automatically.

Date & Time

The first two lines on the screen are the date and time settings for the system clock.

Hard Drive Type

You must enter the specifications of certain types of hard disk drive if they are installed in your system. MFM, ESDI and IDE hard disks all need to have their specifications recorded here.

If you have one or more SCSI hard disks installed in your system, you do not need to enter their specifications here. SCSI drives operate using device drivers and are not supported directly by any current PC BIOS. If you have a SCSI controller installed, follow the instructions that came with it on how to install any required SCSI drivers.

The are four hard disks listed "Drive C:", "Drive D:" "Drive E:" and "Drive F:". Note that these letters refer to the physical drive (think of them as 'Drive 1' and 'Drive 2' etc.), not to any logical drives or partitions you might create under an operating system such as MS-DOS. You can install only two MFM or ESDI hard disks as Drive C: and D:. With an IDE controller that supports Enhanced IDE features for four drives, you can use all the drive letters.

To enter the specifications for an MFM or ESDI hard disk drive, you must first select a 'type'. You can select the "User" option and enter the specifications yourself manually or there are 46 pre-defined drive specifications which you can look through to see if the specifications for your drive are assigned a type number. Do this by using the <Page Up> or <Page Down> key to change the option listed after the drive letter.

For an IDE hard drive, you should use the auto-detection utility described later to enter the drive specifications automatically. If you want to do this, leave the drive set to "None". You can enter the specifications yourself manually by using the User option if you want to.

There are six categories of information you must enter: "Cyls." (number of cylinders), "Heads" (number of read/write heads), "Precomp" (write precompensation), "LandZone" (landing zone), "Sectors" (number of sectors) and "Mode". The size entry is automatically determined by the other entries. The hard disk vendor's or system manufacturer's documentation should provide you with the drive specifications. If you have an IDE drive, unless your drive is already formatted with specifications different from those detected by the auto-detection utility, the easiest thing to do is use auto-detection to enter the drive specifications.

Mode Setting For Hard Disk Drives Larger Than 528MB

The last of the specification entries, Mode, requires additional explanation. The Mode settings are for IDE hard disks only. You can ignore this item for MFM and ESDI drives. There are three entries you can select from in the Mode field, "Normal", "Large" and "LBA".

Set Mode to the Normal setting for IDE hard disk drives smaller than 528MB. Use the LBA setting for drives over 528MB that use Logical Block Addressing mode to allow larger IDE hard disks. The Large setting is for drives over 528MB that do not use the LBA mode. This type of drive can only be used with MS-DOS and is uncommon. The majority of IDE drives over 528MB use the LBA mode.

Note: Entering incorrect drive specifications will result in a hard disk drive functioning improperly or not at all.

Novell Netware 286 Users: You must shadow the system BIOS if you will use a user-defined hard disk type.

Floppy Disk Drives

The next two lines record the types of floppy disk drive present. The five options for drives A and B are:

360KB, 5.25 in.

1.2MB, 5.25 in.

720KB, 3.5 in.

1.44MB, 3.5 in.

2.88MB, 3.5 in.

None

Highlight the listing after each drive name and select the appropriate entry.

Video Display Types

"Video" refers to the type of video display card your system has. The five options are:

EGA/VGA

Mono (for Hercules or MDA)

CGA 40

CGA 80

You should select the setting that matches your video display card. If you have a VGA or any higher resolution card, choose the EGA/VGA setting.

Error Handling

The last line "Halt On" controls whether the system stops in case of an error. The options are:

All Errors

No Errors

All, But Keyboard

All, But Diskette

All, But Disk/Key

For most purposes, we suggest that you leave the setting on the default, "All Errors", unless you know why you want to use a different setting.

When you have made your selections, exit to the main program screen by pressing the <Esc> key.

BIOS Features Setup

"BIOS FEATURES SETUP" is a list of system configuration options. Some entries are defaults required by the mainboard's design. Others will improve your system's performance if enabled, or let you set up some system features according to your preference.

BIOS Features Setup Screen

ROM ISA BIOS(I486SV2G) BIOS FEATURES SETUP AWARD SOFTWARE, INC.			
Virus Warning	: Disabled	Video BIOS Shadow	: Enabled
CPU Internal Cache	: Enabled	C8000-CFFFF Shadow	: Disabled
External Cache	: Enabled	D0000-D7FFF Shadow	: Disabled
Quick Power On Self Test	: Enabled	D8000-DFFFF Shadow	: Disabled
Boot Sequence	: C,A		
Swap Floppy Drive	: Disabled		
Boot Up Floppy seek	: Disabled		
Boot Up NumLock Status	: On		
Boot Up System Speed	: High		
IDE HDD Block Mode	: Enabled		
Typeomatic Rate Setting	: Disabled		
Typeomatic Rate (Chars/Sec)	: 6		
Typeomatic Delay (Msec)	: 250		
Security Option	: System		
		ESC : Quit	↑↓←→ : Select Item
		F1 : Help	PU/PD/+/- : Modify
		F5 : Old Values (SHIFT)F2	: Color
		F6 : Load BIOS Defaults	
		F7 : Load Setup Defaults	

A section at the lower right of the screen explains how to navigate and make changes. The controls are the same as for the Standard CMOS Setup.

If you need information about what changes to make, highlight an entry and press the <F1> key. A pop-up help menu will display information about the highlighted item. Press the <F5> key to recall the last set of values saved for this page. Pressing the <F6> key loads the BIOS default values for this page and <F7> loads the Setup default values.

The following explains the options for each entry and indicates the default settings (Setup Defaults) for this screen.

Virus Protection

The "Virus Warning" default setting is "Disabled". This feature protects the boot sector and partition table of your hard disk. Any attempt to write to them will halt the system and cause a warning message to appear. If this happens, you can either allow the operation to continue or stop it and use an anti-virus utility on a virus-free bootable floppy disk to reboot and investigate your system.

Cache Controls

The "CPU Internal Cache" default setting is "Enabled". This setting enables the internal CPU cache. Turning the cache off will slow down the system. The BIOS default settings will disable it. Leave it enabled unless you are troubleshooting a problem.

The "External Cache" default setting is "Enabled". This setting enables the secondary cache. The BIOS default settings will disable it. Leave it enabled unless you are troubleshooting a problem.

Boot Up Features

The "Quick Power On Self Test" default setting is "Enabled". This speeds up the Power On Self Test (POST) by skipping some items that are normally checked during the full POST. If your system is functioning normally, you can use this feature to speed the boot up process.

The "Boot Sequence" default setting is "C; A;"; the other option is "A; C;". The setting determines where the computer looks first for an operating system, the hard disk or the floppy drive.

The "Swap Floppy Drive" default setting is "Disabled". If you enable this feature, the system will swap the floppy drive assignments so that Drive A will function as Drive B: and Drive B: will function as Drive A:.

The "Boot Up Floppy Seek" default setting is "Disabled". When enabled, the BIOS will check if there is a 360KB floppy disk drive installed. Don't change the default setting unless your system has a 360KB floppy disk drive.

"Boot Up NumLock Status" is a convenience feature. When the computer boots, this setting defines which function, the numeric values, or the cursor controls, will function on the numeric keypad of IBM-compatible keyboards. The extended keyboards supplied with most compatible systems have separate cursor control keys. It is therefore unnecessary to use the numeric keypad to control the cursor. The default setting is "On".

"Boot Up System Speed" sets the CPU speed at boot up. The default setting is "High".

IDE HDD Block Mode

The "IDE HDD Block Mode" default setting is "Enabled". This feature enhances hard disk performance by making multi-sector transfers instead of one sector per transfer. Most IDE drives, except very early designs, can use this feature.

Keyboard Interface

The "Typematic Rate Setting" default setting is "Disabled". If enabled, you can set the typematic controls that follow.

The "Typematic Rate (Char/Sec)" controls the speed at which the system registers repeated keystrokes. The choices range from 6 to 30 characters per second (default is 6).

The "Typematic Delay (Msec)" controls the time between the display of the first and second characters. There are four delay rate choices: 250ms, 500ms, 750ms and 1000ms (default is 250ms).

Password Control

The "Security Option" controls the Password Setting in the main screen. The default setting is "System", uses the User Password feature every time you boot up. The other setting is "Setup". This will allow the system to boot, and use the Supervisor Password *only* to protect the Setup Utility settings from being tampered with. You create a password by using the Supervisor or User Password command from the main screen as explained later in this section.

Shadow Controls

The System BIOS is automatically shadowed.

The default setting for the "Video BIOS Shadow" is "Enabled". This also copies the video display card BIOS into system DRAM to improve performance.

The next three lines, "C8000-CFFFF Shadow" to "D8000-DFFFF Shadow" are for shadowing other expansion card ROMs. The default setting for these addresses is "Disabled". If you have other expansion cards with ROMs on them, you will need to know which addresses the ROMs use to shadow them specifically. If you don't know and cannot find out, you can enable all of the ROM shadow settings. This ensures that any ROMs present will be shadowed. It will also reduce the memory available between 640KB and 1024KB.

After you have made your selections in the BIOS Features Setup press the <Esc> key to go back to the main screen. The next item is Chipset Features Setup.

Chipset Features Setup

This screen controls the settings for the board's chip set. The controls for this screen are the same as for the previous screen.

Chipset Features Screen

ROM ISA BIOS(I486SV2G) CHIPSET FEATURES SETUP AWARD SOFTWARE, INC.			
Auto Configuration	: Enabled	Fast Reset Emulation	: Enable
AT Bus Clock	: 1/4 CLKIN	Fast Reset Latency	: 2 us
DRAM Burst Speed	: Faster	Latch Local Bus	: T3
DRAM Write WS	: 1 WS	Local Bus Ready	: Synchronize
DRAM Write CAS	: 1T		
DRAM Write Burst	: Disable		
Slow Refresh	: Disable		
Hidden Refresh	: Enable		
L2 Cache Scheme	: Write Thru		
L1 Cache Scheme	: Write Thru		
Cache Burst Read	: 2T		
Cache Write Cycle	: 2T		
Video Shadow	: Non-Cacheable	ESC : Quit	↑↓←→ : Select Item
Memory Hole at 16MB	: Disabled	F1 : Help	PU/PD/+/- : Modify
		F5 : Old Values (Shift)F2	: Color
		F6 : Load BIOS Defaults	
		F7 : Load Setup Defaults	

The "Auto Configuration" default is "Enabled". This automatically enters, and locks, some of the optimum settings. "Disabled" unlocks those settings without changing them. All other entries on the screen, with the exception of the Memory Hole setting, are optimal settings for this mainboard and you should not change them.

Memory Hole Size

The "Memory Hole At 16MB" options are "64KB", "128KB", "256KB", "512KB", "1MB", "2MB", "4MB" and "Disabled", the default setting. This feature is not used by MS-DOS or compatible operating systems. Some other operating systems use this feature. Check your OS manuals for instructions on how to use it if required.

Power Management Setup

Power Management Setup controls the mainboard's "green" features. The features work with Intel SL Enhanced 486 CPUs. If you don't have an Intel SL Enhanced 486 CPU, the settings on this screen will have no effect, and you can ignore them. The video features work with "green" monitors. They also work with "non-green" monitors if your system has a "green" power supply and you connect its SMI lead to the "SM Out" connector, jumpers JP2-4.

The Power Management Setup Screen

ROM ISA BIOS(I486SV2G) POWER MANAGEMENT SETUP AWARD SOFTWARE, INC.			
Power Management	: Optimize	IRQ 15 (Reserved)	: Enable
Video Off Method	: V/H SYNC+Blank	IRQ 14 (Hard Disk)	: Enable
HDD Power Down	: Disable	IRQ 13 (Coprocessor)	: Enable
System Doze	: Disable	IRQ 12 (PS2 Mouse)	: Enable
System Standby	: Disable	IRQ 11 (Reserved)	: Enable
System Suspend	: Disable	IRQ 10 (Reserved)	: Enable
Local Master	: Enable	IRQ 9 (Reserved)	: Enable
Local Device	: Enable	IRQ 7 (LPT or LAN)	: Enable
Video Activities	: Enable	IRQ 6 (Floppy Disk)	: Enable
DMA Activities	: Enable	IRQ 5 (LPT or LAN)	: Enable
IRQ Activities	: Enable	IRQ 4 (COM1)	: Enable
IO Device Timer	: 30 Sec	IRQ 3 (COM2)	: Enable
IRQ1,3,4,12	: IRQs	IRQ 1 (Keyboard)	: Enable
COM/LPT Ports	: Both		
Break Switch	: RC Pin	ESC : Quit	↑↓←→ : Select Item
		F1 : Help	PU/PD/+/- : Modify
		F5 : Old Values (SHIFT)F2	: Color
		F6 : Load BIOS Defaults	
		F7 : Load Setup Defaults	

Power Management

"Power Management" is the master control for the power saving features, including HDD Power Down, Doze, Standby and Suspend Modes and the I/O Device Timer, that together form the hardware power conservation scheme. There are five options:

- | | |
|--------------|--|
| User Defined | Allows you to configure the power conservation features yourself. [Default Setting] |
| Disable | Turns off all power conservation features |
| Min Saving | Sets the power conservation options to maximize power saving by putting the system into a progression of power saving modes after a fairly long period of system inactivity. |
| Max Saving | Another set of power conservation assignments which activate after a brief period of system inactivity. |
| Optimize | A set of power conservation assignments which are likely to best suit average use. |

Note: To use an operating system's power management features, this feature must be enabled.

VGA Adaptor Type

The "Video Off Method" default is "V/H SYNC+Blank". If your video display adaptor supports "green" features you can use the default setting. If not, set this line to the "Blank Only" setting. When power management blanks the monitor screen, the default setting saves more power by turning off the CRT's vertical and horizontal scanning. With non-green monitors it blanks the screen but doesn't stop CRT scanning.

HDD Power Down

"HDD Power Down" causes an IDE hard disk to "spin down" if it is not accessed within a specified period. The disk returns to full speed the next time it is accessed. Settings range from "1 Min" to "20 Min", and include "Disable".

System Power Management Modes

The next three settings control the "System Power Management" scheme. Beginning with "System Doze", the scheme progresses to "System Standby" and then to "System Suspend". If one setting is disabled, the system follows the next setting in the progression.

"System Doze" causes the CPU clock to "hold" for 8 μ s (microseconds) every 12 μ s. Full power functions return when an IRQ event is detected. Settings range from "10 Sec" to "4 Hour", and include "Disable".

"System Standby" holds the CPU clock and suspends the video signal. This activates the power saving features on your monitor (if it has them). Full power functions return when an IRQ event is detected. Settings range from "10 Sec" to "4 Hour", and include "Disable".

"System Suspend" stops the CPU's internal clock, suspends the video signal, and controls pins JP2-4. Full power returns when an IRQ event is detected. Settings range from "10 Sec" to "4 Hour", and include "Disable". This feature conserves the most energy.

Parameter Settings

The next five items use monitor activity from several parts of the system. If there is no activity from any "enabled" item, the power conservation sequence starts. You should use the defaults unless you have a specific reason not to.

The "Local Master" default setting is "Enable". This tells the program to monitor for activity on a VESA Bus-master card.

The "Local Device" default setting is "Enable". This tells the program to monitor for activity on a VESA Bus-slave card.

The "Video Activities" default setting is "Disable". This allows control of your monitor.

The "DMA Activities" default setting is "Enable".

The "IRQ Activities" default setting is "Enable". This tells the program to monitor for activity from any IRQs you enable in the right-hand column of this screen.

I/O Settings

The three settings in this group control the secondary power saving scheme. They are independent of the HDD Power Down, System Doze, System Standby, and System Suspend settings.

The "I/O Device Timer" default setting is "Disable". When enabled, this initiates "power down" functions if no activity is detected from IRQs 1, 3, 4 or 12, from a serial (COM) port, or from a parallel (LPT) port. Full power functions, *except the video signal*, return when an activity is detected. Video functions resume when the BIOS detects activity on IRQ1 (keyboard) or IRQ12 (PS/2 mouse). Settings range from "10 Sec" to "30 Min", or "Disable".

The "IRQ 1, 3, 4, 12" required default setting is "IRQs".

The "COM/LPT Ports" default setting is "Both". This setting determines which of these will re-activate the video signal. The other settings are "COM", "LPT" and "None".

Break Switch

The "Break Switch" default setting is "Disable". This assigns where a hardware "forced suspend" can generate from. There are three options:

Disable	no hardware control. Only BIOS commands are implemented.
RC Pin	assigns the suspend option to a case-mounted Suspend switch connected to the Suspend SMI_SW connector on the mainboard.
DeTurbo Pin	assigns the suspend option to the Turbo Switch TB.SW connector on the mainboard.

IRQ Monitoring

The next twelve lines, "IRQ15 (Reserved)" through "IRQ1 (Keyboard)" determine which IRQs are monitored when you enable the "IRQ Activities" setting.

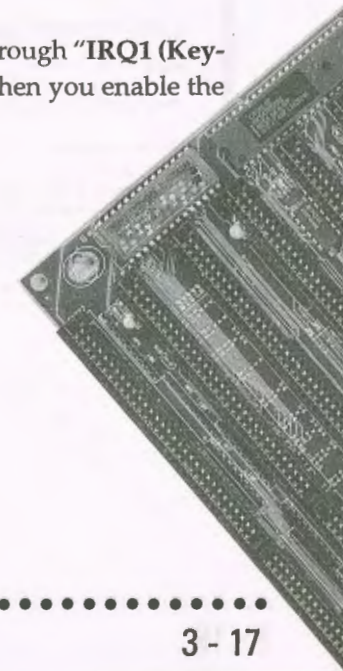

Setting Supervisor & User Passwords

The "SUPERVISOR PASSWORD" and "USER PASSWORD" options set passwords. The Supervisor Password is for system and Setup Utility access. The User Password is for the system only. The mainboard ships with no passwords. To create a password, highlight the type you want and press the <Enter> key. At the prompt, type your password. The password is case sensitive, and can be up to 8 alphanumeric characters. Press <Enter> after you have finished typing in the password. At the next prompt, confirm the new password by re-typing it and pressing <Enter> again. When you're done, the screen automatically reverts to the main screen. Remember, when you use this feature, the "Security Option" line in BIOS FEATURES SETUP will determine when entering the password will be required.

To disable either password, press the <Enter> key instead of entering a new password when the "Enter Password" dialog box appears. A message confirms the password has been disabled.

Password Setting

```

ROM ISA BIOS(I486SV2G)
CMOS SETUP UTILITY
AWARD SOFTWARE, INC.

STANDARD CMOS SETUP      SUPERVISOR PASSWORD
BIOS FEATURES SETUP      USER PASSWORD
CHIPSET FEATURES SETUP    IDE HDD AUTO DETECTION
POWER MANAGEMENT SETUP   SAVE & EXIT SETUP
LOAD BIOS DEFAULTS        Enter Password: *****
LOAD SETUP DEFAULTS

ESC : Quit                ↑↓← : Select Item
F10 : Save & Exit Setup   (SHIFT)F2 : Change Color

Change/Set/Disable Password
  
```

IDE HDD Auto Detection

If your system has an IDE hard drive, you can use this utility to detect its parameters and enter them into the Standard CMOS Setup automatically.

This utility will detect as many as four IDE drives if your system configuration supports that many. In sequence, a set of parameters for each drive will appear in the box. To accept the entries displayed press the Y key, to skip to the next drive, press the N key. If you accept the values, the parameters will appear listed beside the drive letter on the screen and the next letter, without parameters will appear and the program will attempt to detect parameters for the next drive. If you press the N key to skip rather than accept a set of parameters, zeros are entered after that drive letter.

IDE HDD Auto Detection Screen

```

ROM ISA BIOS(I486SV2G)
CMOS SETUP UTILITY
AWARD SOFTWARE, INC.

CYLS. HEADS PRECOMP LANDZONE SECTORS MODE
Drive C :      (  MB)

Select Drive C Option (N=Skip)? N

OPTIONS SIZE  CYLS. HEADS PRECOMP LANDZONE SECTORS  MODE
-----
1(Y)  307    790.   15   65535    790    57  NORMAL
  
```

Remember, if your IDE controller does not have Enhanced IDE support for four devices, you can only install two IDE hard disk drives. Your IDE controller must support Enhanced IDE features in order to use Drive E: and Drive F:.

When you are finished, any entries you accepted are automatically entered on the line for that drive in the Standard CMOS Setup. Any entries you skipped are ignored and nothing is entered for that drive in Standard CMOS Setup.

Note: If you are setting up a hard disk that supports LBA mode, three lines will appear in the parameter box. Choose the line that lists LBA for an LBA drive. Do not choose Large or Normal.

Important!: This utility will only detect one set of parameters for an IDE hard drive. Some IDE drives can use more than one set. This is not a problem if the drive is new and there is nothing on it. If the hard disk drive is already fully formatted when you install it, and different parameters than those detected here were used, you will have to enter them manually.

If the parameters listed don't match the ones used when the drive was formatted, the drive won't be readable. If the auto-detected parameters displayed do not match the ones that should be used for your drive, do not accept them. Press the <N> key to reject the values and enter the correct ones manually from the Standard CMOS Setup screen.

Save And Exit Setup

The next selection on the Utilities menu is "SAVE AND EXIT SETUP". If you select this and press the <Enter> key the values entered during the current session will be recorded in the CMOS memory on the mainboard. The system will check it every time you turn your system on and compare it to what it finds as it checks the system. This record is required for the system to operate.

Exit Without Saving

The last selection on the main screen is "EXIT WITHOUT SAVING". Selecting this option and pressing the <Enter> key lets you exit the Setup Utility without recording any new values or changing old ones. If you want to save a new configuration, do not use this option. If you use it, any new setting information will be lost.

You can now use your system without further reference to this utility unless you change the system hardware configuration. Remember, if the system configuration information stored in CMOS memory gets corrupted, you will have to reenter it.

Technical Summary

This section summarizes the mainboard's specifications. The first part is a summary of the jumper settings, followed by cache, connector and other general specifications.

Jumper Setting Summary

This section lists all the jumper settings on the mainboard. They are mainly listed in numerical order for convenience. There are no jumpers for numbers missing from the sequence. Where jumpers are associated with each other they are listed together. The small diagrams of the mainboard indicate the positions of jumpers on the board. The number pairs listed in the settings indicate which pins of the jumper to short to establish the setting.

Battery Source Selection: JP1

This jumper selects between Internal (On-board) and External (not on-board) battery support for the Setup Utility configuration record stored in CMOS memory on the board. The default setting is for the on-board Lithium battery. If you want to connect a battery to the External Battery connector, use the other setting.

	JP1
Internal (default)	1&2
External	2&3



**Internal
(default)**

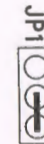

External

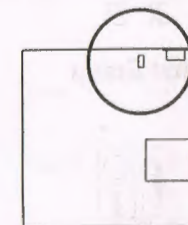

SMI Out Connector: JP2-4

These are a connector, not jumpers. They connect to a special lead from a "green" power supply. There are no caps for them because they are not jumper switches.

Hardware Trap Settings: JP5 & 6

These two jumpers set together indicate to the chipset the type of CPU installed.

CPU	JP5	JP6
486SX, DX, DX2	1&2	2&3
SL 486SX, DX, DX2, DX4		
Cyrix S(2), DX(2), DX2-V	2&3	1&2
AMD486D (S) XL/L2		
P24D, P24T, P24CT	1&2	1&2
AMD486D (S) X PLUS		

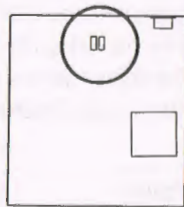
**First Group****Second Group****Third Group****On-board PS/2 Mouse Selection: JP7**

This jumper Enables/Disables the PS/2 mouse connector on the board for a lead to a case-mounted mouse port.

	JP7
Enable (default)	1&2
Disable	2&3

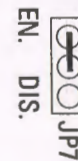
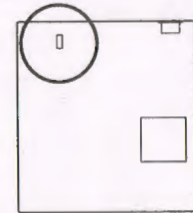
**Enable****Disable****DMA Selection: JP8**

This jumper is factory set, don't change it.

Video Display Type: JP9

The default setting is for all display systems (monitor & video card) except CGA.

	JP9
Mono/VGA (default)	1&2
CGA	2&3

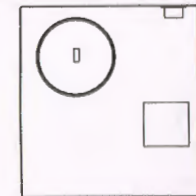
**Mono/VGA****CGA**

SMI Switch Control: JP10

This jumper Enables/Disables the JP30 SMI Suspend Switch connector on the board for a lead to a case-mounted Suspend switch.

	JP10
Enable (default)	2&3
Disable	1&2



Enable

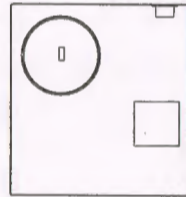

Disable

**Cyrilx/Intel CPU Selection: JP11**

This jumper selects between Intel and Cyrilx CPUs. It should be set for the manufacturer of the CPU installed on the board. If the CPU is from a third manufacturer, this setting doesn't matter.

	JP11
Cyrilx	1&2
Intel	2&3



Cyrilx

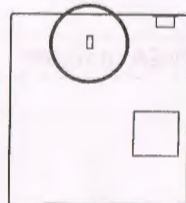

Intel

**Level 2 Cache Size: JP13, JP14 & JP27**

Set these based on the size of the installed cache and chip configuration used.

Cache Size (Chip Config)	JP13	JP14	JP27
128KB (32K8x4)	Open	2&3	1&2
256KB (32K8x8)	Open	1&2	1&2
256KB (64K8x4)	1&2	2&3	1&2
512KB (64K8x8)	4&5	1&2	2&3
512KB (128K8x4)	1&2	2&3	2&3
1MB (128K8x8)	2&3	1&2	2&3

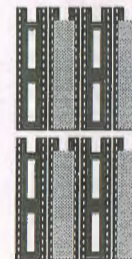
Level 2 Cache Configuration Options**128KB Cache**

Cache: Four 32K8, 20ns

Tag: One 8K8, 20ns

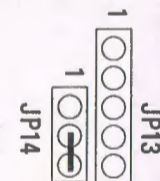

256KB Cache

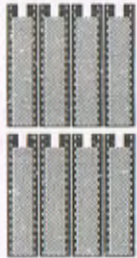

Cache: Eight 32K8, 20ns



Tag: One 32K8, 20ns

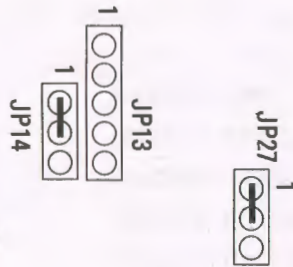

256KB Cache

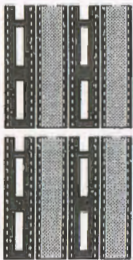

Cache: Four 64K8, 20ns



Tag: One 32K8, 20ns

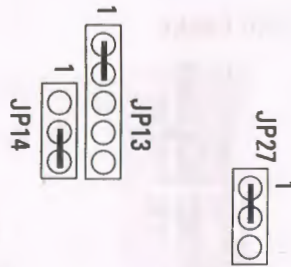

512KB Cache



Cache: Eight 64K8, 20ns



Tag: One 32K8, 20ns

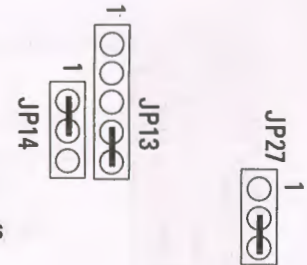

512KB Cache

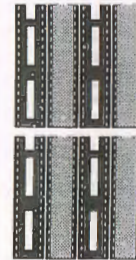

Cache: Four 128K8, 20ns



Tag: One 32K8, 20ns

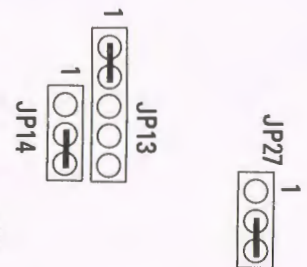

1MB Cache

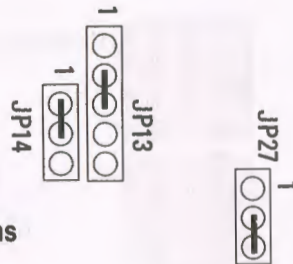
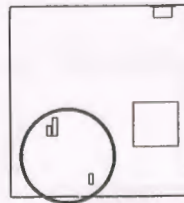

Cache: Eight 128K8, 20ns

Tag: One 64K8, 20ns
or
One 128K8, 20ns

CPU Type Selection: JP16-22

These jumpers set the CPU type.

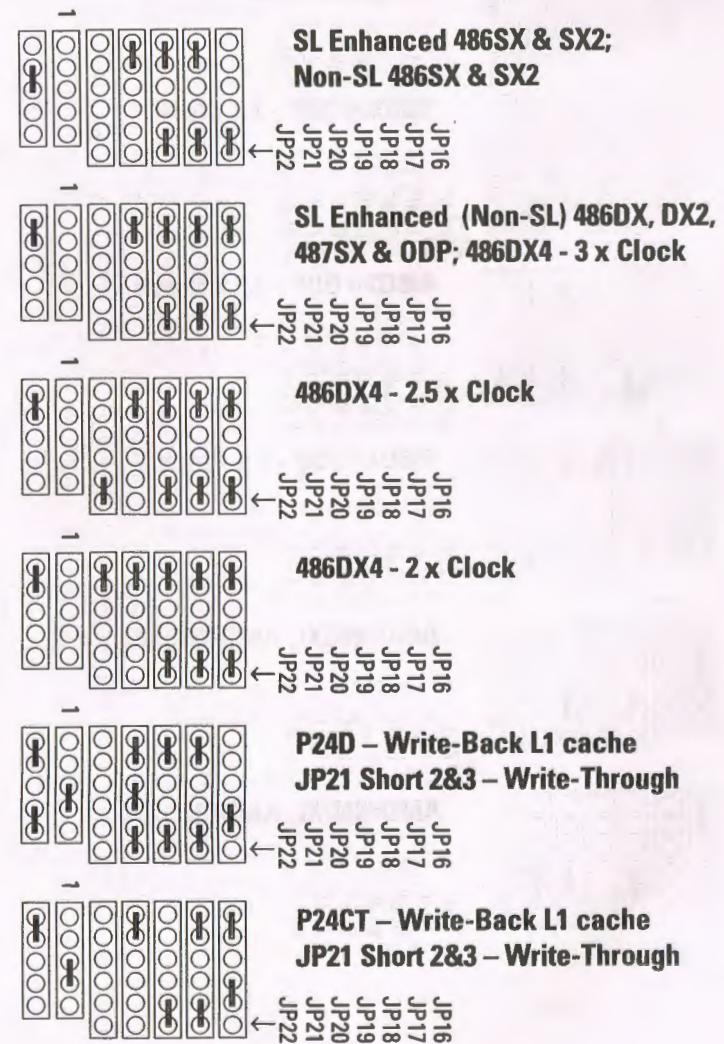

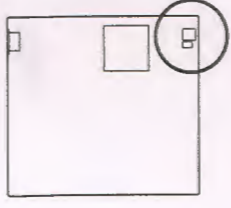
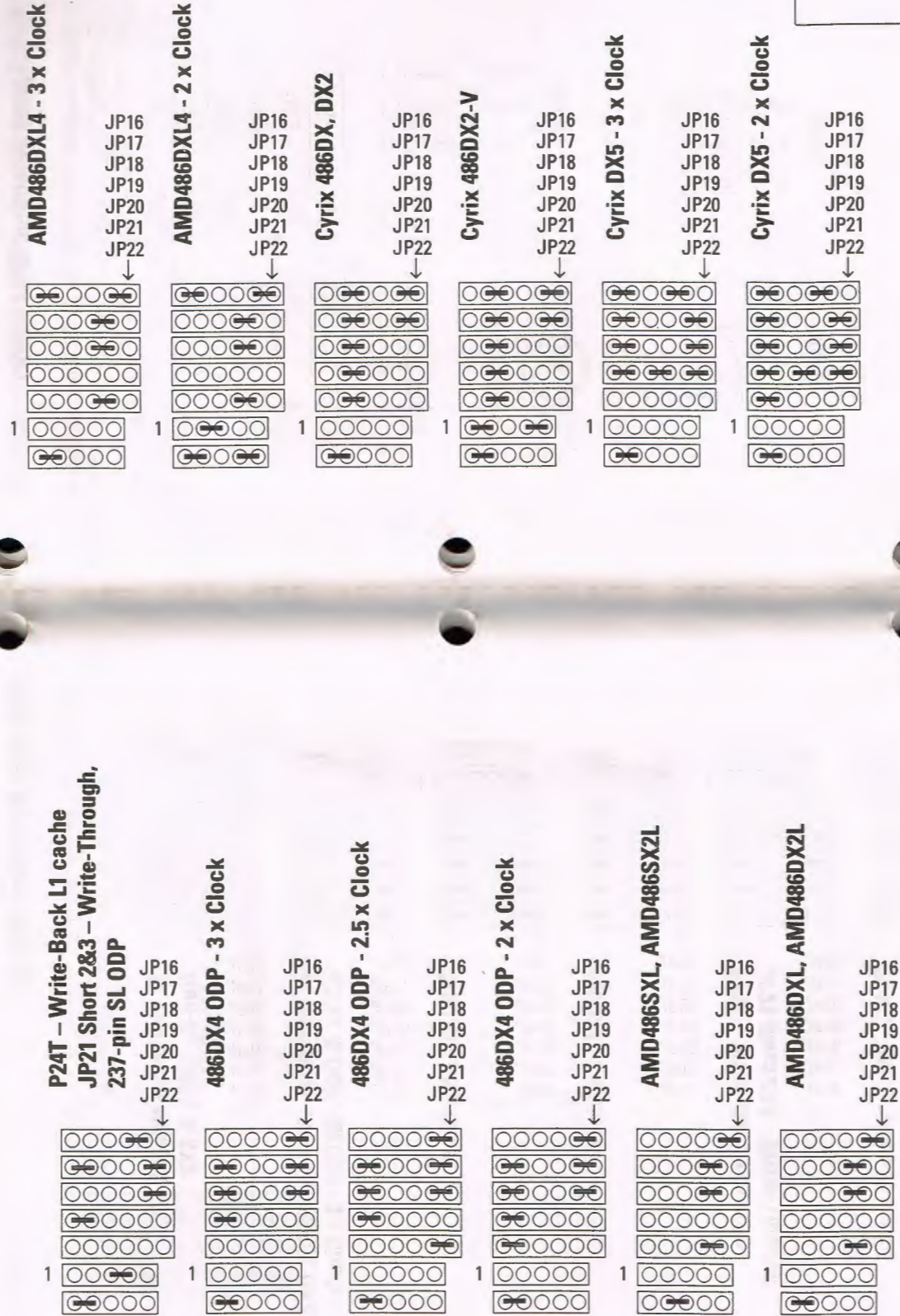

CPU External Clock Speed Selection: JP23 – JP25

These jumpers select the CPU external clock speed. For DX CPUs this is the same as the internal speed. For DX2 CPUs it is one-half the internal speed. For a DX4, it should be 25MHz for the 75MHz and 33MHz for the 100MHz CPU.

Clock Speed	JP23	JP24	JP25
20MHz	1&2	1&2	1&2
25MHz	2&3	1&2	1&2
33MHz	2&3	2&3	2&3
40MHz	2&3	2&3	1&2
50MHz	1&2	1&2	2&3



20MHz



25MHz



33MHz



40MHz

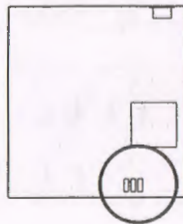

50MHz

**VESA Clock Delay: JP26**

The default setting sets the VESA clock to Delay.

	JP26
Delay (default)	1&2
No Delay	2&3

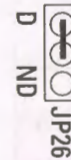

Delay

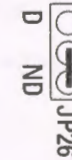

No Delay

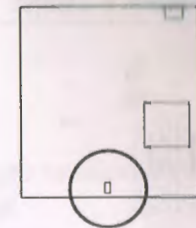
**Cache Size: JP27**

This jumper, along with JP13 and 14 set the cache size. Refer to the listing for JP13 and 14 for the settings.

VL-Bus Clock & Wait State Selection: JP28 – JP29

These jumpers set the VL-Bus clock and wait state.

Wait State/VL-Bus Clock	JP28	JP29
0 Wait State, ≤ 33MHz	1&2	1&2
1 Wait State, > 33MHz	2&3	2&3

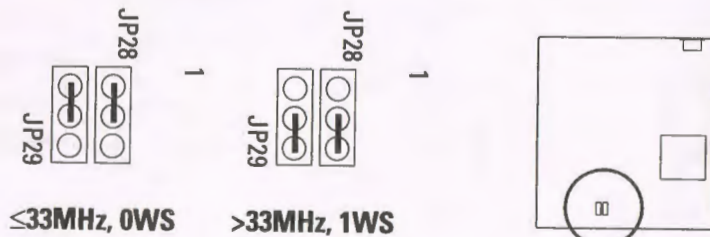

Intel DX4/Cyrix DX2-V Voltage Selection: JP32

This jumper selects the CPU voltage for these two CPUs. The Intel CPU uses 3.45 volts and the Cyrix CPU uses 3.6 volts, so you must make sure that these jumpers are set correctly. The default setting is for the Intel CPU, so you do not need to change the setting if you do not install a Cyrix DX2-V.

Clock Speed	JP32
Intel DX4 (default)	1&2
Cyrix DX2-V	2&3

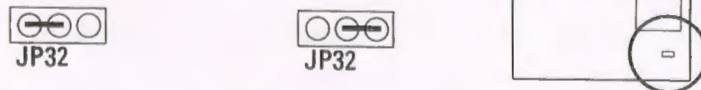

Intel DX4, 3.45-volt Cyrix DX2-V, 3.6-volt

Memory Subsystem

DRAM Specifications:

See pages 2-5

Memory Configurations

See pages 2-6 and 2-7 for chart.

Level 2 Cache Options

See jumper section for settings, chip speeds & size configurations.

Connectors

There are several connectors on the board for switches and indicator lights from the system case. The connectors are made of the same components as the jumper switches. There is also a double connector for the leads from a system power supply and the connector for the on-board IDE controller:

SMI Switch	Connector for the lead from a Case-mounted Suspend switch.
Turbo Switch	Shorted for maximum speed operation (default), or connector for the lead from a case-mounted Turbo Switch.
Turbo LED	Connector for the lead from a case-mounted Turbo Switch status indicator LED.
Reset Switch	Connector for the lead from a Reset switch mounted on the system case.
Speaker	Connector for the lead from a speaker mounted inside the system case.
KeyLock	Connector for both a case-mounted keyboard lock and a Power-On LED. Pin 1 is live, pins 3 & 5 are grounds.
PS/2 Mouse	Connector for a lead from a case-mounted PS/2 mouse port.
Ext.Batt	Connector for the lead from an external battery.
SMI Out	Connector for the extra lead from a green power supply.

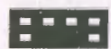
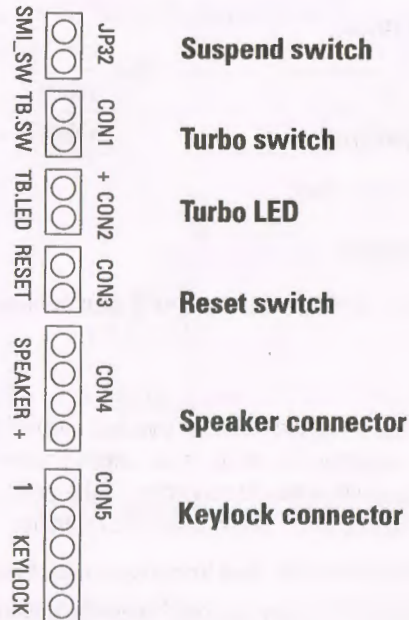
System Case Connectors & IDE/HD LED Connectors

PS/2 Mouse lead connector

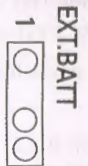

External Battery connector

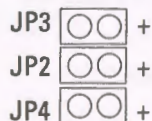

JP2-4 SMI Out connector

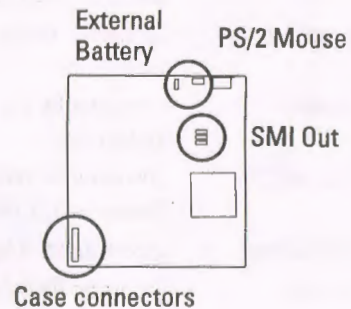
Connecting A Power Supply

To connect the leads from the power supply, first make sure the it is unplugged. Most power supplies have two leads. Each lead has six wires, two of which are black. Orient the connectors so the black wires are in the middle.

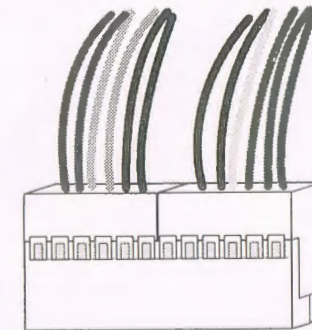
Power supply connectors

The black wires should be in the middle.

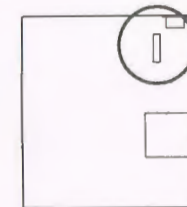

Power connector

VL/I-486SV2G, VL/I-486SV2GX4

VL & ISA Bus, 486 Green PC Mainboard

Copy Right 1994

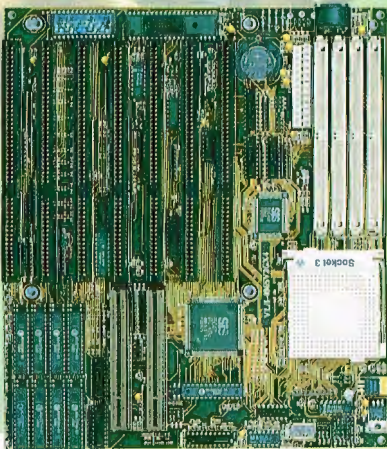

USER'S MANUAL



ASUSTeK Doc No. AS9407N