

P5N-T Deluxe

ASUS[®]

Motherboard

E3506

Second Edition V2

December 2007

Copyright © 2007 ASUSTeK COMPUTER INC. All Rights Reserved.

No part of this manual, including the products and software described in it, may be reproduced, transmitted, transcribed, stored in a retrieval system, or translated into any language in any form or by any means, except documentation kept by the purchaser for backup purposes, without the express written permission of ASUSTeK COMPUTER INC. ("ASUS").

Product warranty or service will not be extended if: (1) the product is repaired, modified or altered, unless such repair, modification or alteration is authorized in writing by ASUS; or (2) the serial number of the product is defaced or missing.

ASUS PROVIDES THIS MANUAL "AS IS" WITHOUT WARRANTY OF ANY KIND, EITHER EXPRESS OR IMPLIED, INCLUDING BUT NOT LIMITED TO THE IMPLIED WARRANTIES OR CONDITIONS OF MERCHANTABILITY OR FITNESS FOR A PARTICULAR PURPOSE. IN NO EVENT SHALL ASUS, ITS DIRECTORS, OFFICERS, EMPLOYEES OR AGENTS BE LIABLE FOR ANY INDIRECT, SPECIAL, INCIDENTAL, OR CONSEQUENTIAL DAMAGES (INCLUDING DAMAGES FOR LOSS OF PROFITS, LOSS OF BUSINESS, LOSS OF USE OR DATA, INTERRUPTION OF BUSINESS AND THE LIKE), EVEN IF ASUS HAS BEEN ADVISED OF THE POSSIBILITY OF SUCH DAMAGES ARISING FROM ANY DEFECT OR ERROR IN THIS MANUAL OR PRODUCT.

SPECIFICATIONS AND INFORMATION CONTAINED IN THIS MANUAL ARE FURNISHED FOR INFORMATIONAL USE ONLY, AND ARE SUBJECT TO CHANGE AT ANY TIME WITHOUT NOTICE, AND SHOULD NOT BE CONSTRUED AS A COMMITMENT BY ASUS. ASUS ASSUMES NO RESPONSIBILITY OR LIABILITY FOR ANY ERRORS OR INACCURACIES THAT MAY APPEAR IN THIS MANUAL, INCLUDING THE PRODUCTS AND SOFTWARE DESCRIBED IN IT.

Products and corporate names appearing in this manual may or may not be registered trademarks or copyrights of their respective companies, and are used only for identification or explanation and to the owners' benefit, without intent to infringe.

Contents

Notices.....	vii
Safety information	viii
About this guide	ix
P5N-T Deluxe specifications summary.....	xi

Chapter 1: Product introduction

1.1	Welcome!	1-1
1.2	Package contents.....	1-1
1.3	Special features.....	1-2
1.3.1	Product highlights	1-2
1.3.2	ASUS AI Lifestyle unique features	1-4
1.3.3	ASUS Intelligent Performance and Overclocking features	1-7

Chapter 2: Hardware information

2.1	Before you proceed	2-1
2.2	Motherboard overview.....	2-2
2.2.1	Placement direction	2-2
2.2.2	Screw holes	2-2
2.2.3	Motherboard layout.....	2-3
2.2.4	Layout contents.....	2-4
2.3	Central Processing Unit (CPU)	2-6
2.3.1	Installing the CPU	2-7
2.3.2	Installing the CPU heatsink and fan.....	2-9
2.3.3	Uninstalling the CPU heatsink and fan	2-11
2.4	System memory	2-13
2.4.1	Overview	2-13
2.4.2	Memory configurations.....	2-13
2.4.3	Installing a DIMM	2-15
2.4.4	Removing a DIMM	2-15
2.5	Expansion slots.....	2-18
2.5.1	Installing an expansion card	2-18
2.5.2	Configuring an expansion card	2-18
2.5.3	Interrupt assignments	2-19
2.5.4	PCI slot	2-20
2.5.5	PCI Express x1 slots.....	2-20
2.5.6	PCI Express 2.0 x16 slots.....	2-20

Contents

2.6	Jumper	2-22
2.7	Connectors	2-23
2.7.1	Rear panel connectors	2-23
2.7.2	Internal connectors	2-25
2.7.3	Installing the optional fans	2-36
 Chapter 3: Powering up		
3.1	Starting up for the first time.....	3-1
3.2	Turning off the computer.....	3-2
3.2.1	Using the OS shut down function.....	3-2
3.2.2	Using the dual function power switch.....	3-2
 Chapter 4: BIOS setup		
4.1	Managing and updating your BIOS	4-1
4.1.1	ASUS Update utility	4-1
4.1.2	Creating a bootable floppy disk.....	4-4
4.1.3	ASUS EZ Flash 2 utility.....	4-5
4.1.4	Updating the BIOS.....	4-6
4.1.5	Saving the current BIOS file.....	4-8
4.2	BIOS setup program	4-9
4.2.1	BIOS menu screen.....	4-10
4.2.2	Menu bar.....	4-10
4.2.3	Legend bar.....	4-11
4.2.4	Menu items	4-11
4.2.5	Sub-menu items.....	4-11
4.2.6	Configuration fields	4-11
4.2.7	Pop-up window	4-12
4.2.8	General help	4-12
4.3	Main menu	4-13
4.3.1	System Time	4-13
4.3.2	System Date	4-13
4.3.3	Language	4-13
4.3.4	Legacy Diskette A	4-13
4.3.5	Primary IDE Master/Slave.....	4-14
4.3.6	SATA1/2/3/4/5/6.....	4-16
4.3.7	HDD SMART Monitoring.....	4-17
4.3.8	Installed Memory.....	4-17

Contents

4.3.9	Usable Memory	4-17
4.4	Extreme Tweaker menu	4-18
4.4.1	AI Tuning	4-18
4.4.2	Overclocking	4-21
4.4.3	Over Voltage	4-23
4.4.4	NVIDIA GPU Ex	4-24
4.4.5	SLI-Ready Memory	4-24
4.4.6	SLI-Ready Memory CPUOC	4-24
4.5	Advanced menu	4-25
4.5.1	AI NET2	4-25
4.5.2	PCIPnP	4-26
4.5.3	Onboard Device Configuration	4-27
4.6	Power menu	4-30
4.6.1	ACPI Suspend Type	4-30
4.6.2	ACPI APIC Support	4-30
4.6.3	APM Configuration	4-31
4.6.4	Hardware Monitor	4-33
4.7	Boot menu	4-35
4.7.1	Boot Device Priority	4-35
4.7.2	Removable Drives	4-35
4.7.3	Hard Disk Drives	4-36
4.7.4	CDROM Drives	4-36
4.7.5	Boot Settings Configuration	4-37
4.7.6	Security	4-38
4.8	Tools menu	4-40
4.8.1	ASUS O.C. Profile	4-40
4.8.2	ASUS EZ Flash 2	4-42
4.9	Exit menu	4-43

Chapter 5: Software support

5.1	Installing an operating system	5-1
5.2	Support DVD information	5-1
5.2.1	Running the support DVD	5-1
5.2.2	Drivers menu	5-2
5.2.3	Utilities menu	5-3
5.2.4	Make disk menu	5-5
5.2.5	Manual menu	5-6

Contents

- 5.2.6 ASUS Contact information 5-6
- 5.2.7 Other information 5-7
- 5.3 Software information 5-9**
 - 5.3.1 ASUS MyLogo3™ 5-9
 - 5.3.2 AI NET2 5-11
 - 5.3.3 ASUS PC Probe II..... 5-12
 - 5.3.4 ASUS AI Suite..... 5-18
 - 5.3.5 ASUS EPU Utility -- AI Gear 3 5-20
 - 5.3.6 ASUS AI Nap 5-21
 - 5.3.7 ASUS Q-Fan 2 5-22
 - 5.3.8 ASUS AI Booster..... 5-23
 - 5.3.9 ASUS AI Direct Link..... 5-24
 - 5.3.10 AI Audio 2 (SoundMAX® High Definition Audio utility) ... 5-26
- 5.4 RAID configurations 5-35**
 - 5.4.1 RAID definitions 5-35
 - 5.4.2 NVIDIA® RAID configurations..... 5-36
- 5.5 Creating a RAID driver disk..... 5-43**
 - 5.5.1 Creating a RAID driver disk without entering the OS.... 5-43
 - 5.5.2 Creating a RAID/SATA driver disk in Windows®..... 5-43
- Chapter 6: NVIDIA® SLI™ technology support**
 - 6.1 Overview 6-1**
 - Requirements..... 6-1
 - 6.2 Graphics card setup 6-2**
 - 6.2.1 Installing three SLI-ready graphics cards..... 6-2
 - 6.2.2 Installing two SLI-ready graphics cards 6-5
 - 6.2.3 Installing the device drivers..... 6-6
 - 6.2.4 Enabling the NVIDIA® SLI™ technology in Windows® 6-6
- Appendix: CPU features**
 - A.1 Intel® EM64T..... A-1**
 - A.2 Enhanced Intel SpeedStep® Technology (EIST) A-1**
 - A.2.1 System requirements A-1
 - A.2.2 Using the EIST A-2
 - A.3 Intel® Hyper-Threading Technology A-3**

Notices

Federal Communications Commission Statement

This device complies with Part 15 of the FCC Rules. Operation is subject to the following two conditions:

- This device may not cause harmful interference, and
- This device must accept any interference received including interference that may cause undesired operation.

This equipment has been tested and found to comply with the limits for a Class B digital device, pursuant to Part 15 of the FCC Rules. These limits are designed to provide reasonable protection against harmful interference in a residential installation. This equipment generates, uses and can radiate radio frequency energy and, if not installed and used in accordance with manufacturer's instructions, may cause harmful interference to radio communications. However, there is no guarantee that interference will not occur in a particular installation. If this equipment does cause harmful interference to radio or television reception, which can be determined by turning the equipment off and on, the user is encouraged to try to correct the interference by one or more of the following measures:

- Reorient or relocate the receiving antenna.
- Increase the separation between the equipment and receiver.
- Connect the equipment to an outlet on a circuit different from that to which the receiver is connected.
- Consult the dealer or an experienced radio/TV technician for help.



The use of shielded cables for connection of the monitor to the graphics card is required to assure compliance with FCC regulations. Changes or modifications to this unit not expressly approved by the party responsible for compliance could void the user's authority to operate this equipment.

Canadian Department of Communications Statement

This digital apparatus does not exceed the Class B limits for radio noise emissions from digital apparatus set out in the Radio Interference Regulations of the Canadian Department of Communications.

This class B digital apparatus complies with Canadian ICES-003.

Safety information

Electrical safety

- To prevent electrical shock hazard, disconnect the power cable from the electrical outlet before relocating the system.
- When adding or removing devices to or from the system, ensure that the power cables for the devices are unplugged before the signal cables are connected. If possible, disconnect all power cables from the existing system before you add a device.
- Before connecting or removing signal cables from the motherboard, ensure that all power cables are unplugged.
- Seek professional assistance before using an adapter or extension cord. These devices could interrupt the grounding circuit.
- Make sure that your power supply is set to the correct voltage in your area. If you are not sure about the voltage of the electrical outlet you are using, contact your local power company.
- If the power supply is broken, do not try to fix it by yourself. Contact a qualified service technician or your retailer.

Operation safety

- Before installing the motherboard and adding devices on it, carefully read all the manuals that came with the package.
- Before using the product, make sure all cables are correctly connected and the power cables are not damaged. If you detect any damage, contact your dealer immediately.
- To avoid short circuits, keep paper clips, screws, and staples away from connectors, slots, sockets and circuitry.
- Avoid dust, humidity, and temperature extremes. Do not place the product in any area where it may become wet.
- Place the product on a stable surface.
- If you encounter technical problems with the product, contact a qualified service technician or your retailer.



This symbol of the crossed out wheeled bin indicates that the product (electrical, electronic equipment and mercury-containing button cell battery) should not be placed in municipal waste. Check local regulations for disposal of electronic products.

About this guide

This user guide contains the information you need when installing and configuring the motherboard.

How this guide is organized

This guide contains the following parts:

- **Chapter 1: Product introduction**
This chapter describes the features of the motherboard and the new technology it supports.
- **Chapter 2: Hardware information**
This chapter lists the hardware setup procedures that you have to perform when installing system components. It includes description of the jumpers and connectors on the motherboard.
- **Chapter 3: Powering up**
This chapter describes the power up sequence and ways of shutting down the system.
- **Chapter 4: BIOS setup**
This chapter tells how to change system settings through the BIOS Setup menus. Detailed descriptions of the BIOS parameters are also provided.
- **Chapter 5: Software support**
This chapter describes the contents of the support DVD that comes with the motherboard package and the software.
- **Chapter 6: NVIDIA SLI™ support**
This chapter describes the NVIDIA SLI™ feature and shows the graphics card installation procedures.
- **Appendix: CPU features**
The Appendix describes the CPU features and technologies that the motherboard supports.

Where to find more information

Refer to the following sources for additional information and for product and software updates.

1. **ASUS websites**
The ASUS website provides updated information on ASUS hardware and software products. Refer to the ASUS contact information.
2. **Optional documentation**
Your product package may include optional documentation, such as warranty flyers, that may have been added by your dealer. These documents are not part of the standard package.

Conventions used in this guide

To make sure that you perform certain tasks properly, take note of the following symbols used throughout this manual.



DANGER/WARNING: Information to prevent injury to yourself when trying to complete a task.



CAUTION: Information to prevent damage to the components when trying to complete a task.



IMPORTANT: Instructions that you **MUST** follow to complete a task.



NOTE: Tips and additional information to help you complete a task.

Typography

Bold text

Indicates a menu or an item to select.

Italics

Used to emphasize a word or a phrase.

<Key>

Keys enclosed in the less-than and greater-than sign means that you must press the enclosed key.

Example: <Enter> means that you must press the Enter or Return key.

<Key1+Key2+Key3>

If you must press two or more keys simultaneously, the key names are linked with a plus sign (+).

Example: <Ctrl+Alt+D>

Command

Means that you must type the command exactly as shown, then supply the required item or value enclosed in brackets.

Example: At the DOS prompt, type the command line:

format A: /S

P5N-T Deluxe specifications summary

CPU	LGA775 socket for Intel® Core™2 Quad / Core™2 Extreme / Core™2 Duo / Pentium® Extreme / Pentium® D / Pentium® 4 Processors Compatible with Intel® 05B/05A/06 processors Intel® 45nm Multi-Core CPU Note: Visit the ASUS website at www.asus.com for the Intel® CPU support list.
Chipset	NVIDIA® nForce 780i SLI
Front Side Bus	1333 / 1066 / 800 / 667 MHz
Memory	4 x DIMM, max. 8GB, DDR2 1066/800 MHz, non-ECC, un-buffered memory Dual channel memory architecture Note: Visit the ASUS website at www.asus.com for the latest Qualified Vendors List (QVL).
Expansion slots	3 x PCIe x16 (blue @ PCIe 2.0 x16 mode, black @ PCIe x16 mode) with SLI™ support 2 x PCIe x1 1 x PCI
Scalable Link Interface (SLI™)	Supports three identical NVIDIA® SLI™-Ready graphics cards (all at x16 mode)
Storage	Southbridge supports: - 1 x Ultra DMA 133/100/66 - 6 x Serial ATA 3 Gb/s - NVIDIA® MediaShield™ RAID supports RAID 0, 1, 10(0+1), 5 and JBOD configuration across Serial ATA drives Marvell SATA controller supports: - 1 x External SATA 3 Gb/s port
LAN	Marvell® 88E1116 PCIe Gigabit LAN PHY, featuring AI NET2
High Definition Audio	AD1® 1988B 8-channel High Definition Audio CODEC Supports Jack-Sensing, Enumeration, and Multi-streaming Coaxial / Optical S/PDIF out ports at back panel
IEEE 1394	VIA6308P controller supports: - 2 x IEEE 1394a connectors (one at mid-board; one at back panel)
USB	Supports up to 10 USB 2.0 ports (6 at mid-board, 4 at back panel)

(continued on the next page)

P5N-T Deluxe specifications summary

ASUS AI Lifestyle Unique features	ASUS Power Saving Solution: <ul style="list-style-type: none">- ASUS EPU (Energy Processing Unit)- ASUS 3rd Generation 8-phase Power Design- ASUS AI Nap ASUS AI Lifestyle Features: <ul style="list-style-type: none">- ASUS AI Direct Link ASUS Quiet Thermal Solution: <ul style="list-style-type: none">- ASUS Fanless Design: Heat-pipe solution- ASUS Fanless Design: StackCool 2- ASUS Q-Fan 2- ASUS Optional Fan for Water-cooling or Passive-Cooling only ASUS Crystal Sound: <ul style="list-style-type: none">- ASUS Audio 2- ASUS Noise Filter ASUS EZ DIY: <ul style="list-style-type: none">- ASUS Q-Shield- ASUS Q-Connector- ASUS O.C. Profile- ASUS EZ Flash 2
ASUS Stylish Features	ASUS MyLogo3™ Multi-language BIOS
ASUS Exclusive Overclocking features	Intelligent overclocking tools: <ul style="list-style-type: none">- ASUS AI Booster utility Precision Tweaker 2: <ul style="list-style-type: none">- vCore: Adjustable CPU voltage at 0.00625V increment- vDIMM: 64-step DRAM voltage control- vChipset (N.B.): 64-step Chipset voltage control- vFSB Termination: 3-step reference voltage control- vCPU PLL: 64-step CPU PLL voltage control SFS (Stepless Frequency Selection) <ul style="list-style-type: none">- FSB tuning from 133MHz up to 800MHz at 1MHz increment- Memory tuning from 400MHz up to 2600MHz- PCI Express frequency tuning from 100MHz up to 200MHz at 1MHz increment Overclocking Protection: <ul style="list-style-type: none">- ASUS C.P.R.(CPU Parameter Recall)

(continued on the next page)

P5N-T Deluxe specifications summary

Rear panel	2 x PS/2 Keyboard port (purple) 1 x Optical S/PDIF Output port 1 x Coaxial S/PDIF Output port 1 x External SATA 1 x LAN (RJ45) port 4 x USB 2.0/1.1 ports 1 x IEEE1394a port 8-channel Audio I/O
Internal connectors	1 x Floppy disk drive connector 1 x IDE connector 6 x Serial ATA connectors 3 x USB connectors support additional 6 USB ports 1 x COM connector 1 x IEEE 1394a port connector 1 x CPU / 1 x Power / 2 x Chassis Fan connectors Front panel audio connector 1 x S/PDIF Out Header Chassis Intrusion connector CD audio in 24-pin ATX Power connector 8-pin ATX 12V Power connector System Panel (Q-Connector)
BIOS features	8 Mb Award BIOS, PnP, DMI2.0, WfM2.0, SM BIOS 2.3, Multi-Language BIOS
Manageability	WOL by PME, WOR by PME, Chasis Intrusion, PXE
Support DVD contents	Drivers ASUS PC Probe II ASUS Update ASUS AI Suite Image-Editing Suite Multi-language MB installation guide Anti-virus software (OEM version)
Form factor	ATX form factor: 12 in x 9.6 in (30.5 cm x 24.5 cm)

*Specifications are subject to change without notice.

This chapter describes the motherboard features and the new technologies it supports.

1 Product introduction

Chapter summary

1

1.1	Welcome!	1-1
1.2	Package contents.....	1-1
1.3	Special features.....	1-2

1.1 Welcome!

Thank you for buying an ASUS® P5N-T Deluxe motherboard!

The motherboard delivers a host of new features and latest technologies, making it another standout in the long line of ASUS quality motherboards!

Before you start installing the motherboard, and hardware devices on it, check the items in your package with the list below.

1.2 Package contents

Check your motherboard package for the following items.

Motherboard	ASUS P5N-T Deluxe motherboard
I/O modules	1 x 1-port IEEE 1394a module 1 x 2-port USB 2.0 module
Cables	1 x Serial ATA power cable for 2 devices 6 x Serial ATA signal cables 1 x Ultra DMA 133/100/66 cable 1 x Floppy disk drive cable
Accessories	Q-Shield (I/O shield) 1 x ASUS Optional Fans for Water-Cooling or Passive-Cooling only 1 x 3-in-1 ASUS Q-Connector Kit (USB, IEEE 1394, system panel; Retail version only) 1 x ASUS 3-way SLI bridge connector 1 x ASUS SLI bridge
Application DVD	ASUS motherboard support DVD
Documentation	User guide



If any of the above items is damaged or missing, contact your retailer.

1.3 Special features

1.3.1 Product highlights

Intel® Core™2 Quad / Core™2 Duo / Core™2 Extreme CPU support



This motherboard supports the latest Intel® Quad-core/Core™2 processor in the LGA775 package and Intel's 45nm multi-core processors. With the new Intel® Core™ microarchitecture technology and 1333/1066/800/667 MHz FSB, the Intel® Core™2 is one of the most powerful and energy efficient CPUs in the world.

NVIDIA® nForce® 780i SLI chipset



The NVIDIA® nForce 780i SLI chipset supports the NVIDIA® Scalable Link Interface (SLI™) technology that allows three graphics processing units (GPUs) in a single system. It's designed for enthusiast, extreme overclocking capability, ultimate gaming performance with SLI technology support. It's definitely one of the fastest platform in the world. The NVIDIA® nForce 780i SLI chipset also supports six (6) Serial ATA 3 Gb/s devices, three PCI Express™ x16 slots with NVIDIA® SLI™ support at full x16, x16, x16 mode, and up to 10 USB 2.0 ports.

NVIDIA® Scalable Link Interface (SLI™)



NVIDIA SLI™ (Scalable Link Interface) takes advantage of the increased bandwidth of the PCI Express bus architecture and features intelligent hardware and software that allows two GPUs to efficiently work together to deliver earth-shattering, scalable performance.

NVIDIA® 3-Way SLI™ (Scalable Link Interface)



NVIDIA 3-Way SLI™ (Scalable Link Interface) takes advantage of the increased bandwidth of the PCI Express 2.0 bus architecture and features intelligent hardware and software that allows three graphics cards to efficiently work together to deliver earth-shattering, scalable performance. For some applications nearly triple performance!

PCIe 2.0



This motherboard supports the latest PCIe 2.0 device for twice the current speed and bandwidth. This enhances system performance while still providing backward compatibility to PCIe 1.0 devices. See page 2-20 for details.

DDR2 memory support



The motherboard supports DDR2 memory that features data transfer rates of 1066/800/667 MHz to meet the higher bandwidth requirements of the latest 3D graphics, multimedia, and Internet applications. The dual-channel DDR2 architecture doubles the bandwidth of your system memory to boost system performance, eliminating bottlenecks with peak bandwidths of up to 12.8 GB/s. See page 2-13 for details.

Serial ATA 3 Gb/s technology and SATA-On-The-Go



This motherboard supports the hard drives based on the Serial ATA (SATA) 3 Gb/s storage specification, delivering enhanced scalability and doubling the bus bandwidth for high-speed data retrieval and saves. The external SATA port located at the back I/O provides smart setup and hot-plug functions. Easily backup photos, videos and other entertainment contents to external devices. See page 2-24 for details.

The NVIDIA® MediaShield™ RAID controller integrated in the NVIDIA® nForce® 780i SLI™ chipset allows RAID 0, RAID 1, RAID 10(0+1), RAID 5, and JBOD configurations for six SATA 3 Gb/s connectors. See page 2-26 for details.

IEEE 1394a support



The IEEE 1394a interface provides high speed digital interface for audio/video appliances such as digital television, digital video camcorders, storage peripherals & other PC portable devices. See pages 2-23 and 2-28 for details.

S/PDIF digital sound ready



This motherboard provides convenient connectivity to external home theater audio systems via coaxial and optical S/PDIF-out (SONY/PHILIPS Digital Interface) jacks. It allows to transfer digital audio without converting to analog format and keeps the best signal quality. See pages 2-23 and 2-24 for details.

Gigabit LAN solution



The NVIDIA® native Gigabit LAN controller delivers transfer speeds up to ten times faster than conventional 10/100/1000 Ethernet connections. Gigabit LAN is the networking standard for the early future and is ideal for handling large amounts of data such as video, audio, and voice. See page 2-23 for details.

High Definition Audio



Enjoy high-end sound quality on your PC! The onboard 8-channel HD audio (High Definition Audio, previously codenamed Azalia) CODEC enables high-quality 192KHz/24-bit audio output that simultaneously sends different audio streams to different destinations. You can now talk to your partners on the headphone while playing multi-channel network games. See pages 2-23 and 2-24 for details.

Green ASUS



This motherboard and its packaging comply with the European Union's Restriction on the use of Hazardous Substances (RoHS). This is in line with the ASUS vision of creating environment-friendly and recyclable products/packaging to safeguard consumers' health while minimizing the impact on the environment.

1.3.2 ASUS AI Lifestyle unique features



ASUS Power Saving Solution

ASUS Power Saving solution intelligently and automatically provides balanced computing power and energy consumption.

ASUS EPU



The ASUS EPU utilizes innovative technology to digitally monitor and tune the CPU power supply with improved VR responses in heavy or light loadings. It automatically provides power for higher performance or improve efficiency by 7% when the PC is running low intensity applications. Working together with AI Gear 3, this can help you attain the best possible power efficiency and energy savings up to 58.6% to help save the environment. See page 5-20 for details.

AI Nap



With AI Nap, the system can continue running at minimum power and noise when you are temporarily away. To wake the system and return to the OS environment, simply click the mouse or press a key. See page 5-21 for details.

ASUS Quiet Thermal Solution

ASUS Quiet Thermal solution makes system more stable and enhances the overclocking capability.

ASUS 3rd Generation 8 Phase Power Design

Longer Life, & Higher Efficiency!

With power efficiency so important to operating temperatures, ASUS' 3rd generation 8-phase VRM design leads the industry with its 95% power efficiency. High quality power components such as low RDS (on) MOSFETs for minimum switching loss & lower temperatures, Ferrite core chokes with lower hysteresis loss, and high quality Japanese-made conductive polymer capacitors all add up to ensure longer component life and lower power loss - creating more energy efficiency.

Fanless Design - Stack Cool 2

ASUS Stack Cool 2 is a fan-less and zero-noise cooling solution that lowers the temperature of critical heat generating components. The motherboard uses a special design on the printed circuit board (PCB) to dissipate heat these critical components generate.

Fanless Design - Pure Copper Heat-pipe

The Heat Pipe design effectively directs the heat generated by the chipsets to the heatsink near the back IO ports, where it can be carried away by existing airflow from CPU fan or bundled optional fan. The purpose of the innovative heat pipe design on this motherboard is that the groundbreaking fanless design does not have lifetime problems as a chipset fan does. Furthermore, it provides options for users to install side-flow fan or passive cooler. The Heat Pipe design is the most reliable fanless thermal solution to date.



DO NOT uninstall the heat-pipe by yourself. Doing so may bend the tubing and affect the heat dissipation performance.

Optional Fan (for Water-Cooling or Passive-Cooling only)

The optional fan is specifically designed to provide sufficient airflow over the CPU power modules and chipset area when water-cooling or passive-cooling is utilized, ensuring effective heat dissipation for the entire system. See page 2-36 for details.

Q-Fan 2

ASUS Q-Fan2 technology intelligently adjusts both CPU fan and chassis fan speeds according to system loading to ensure quiet, cool and efficient operation. See page 5-22 for details.

ASUS Crystal Sound

This feature can enhance speech-centric applications like Skype, online game, video conference and recording.

AI Audio 2

AI Audio 2 creates a virtual center channel that expands the overall sound field without introducing a picket fencing effect. Preserving the dialogue or solo performances with downmixing from multichannels will allow you to experience true-to-life high quality audio. See pages 5-26 to 5-34 for details.

Noise Filter

This feature detects repetitive and stationary noises (non-voice signals) like computer fans, air conditioners, and other background noises then eliminates it in the incoming audio stream while recording.

ASUS EZ DIY

ASUS EZ DIY feature collection provides you easy ways to install computer components, update the BIOS or back up your favorite settings.

ASUS Q-Shield

The specially designed ASUS Q-Shield provides conductivity to best protect your motherboard against static electricity damage and shields it against Electronic Magnetic Interference (EMI). Without the usual "fingers" present, this new design is convenient and safe to install.

ASUS Q-Connector

ASUS Q-Connector allows you to easily connect or disconnect the chassis front panel cables to the motherboard. This unique module eliminates the trouble of connecting the system panel cables one at a time and avoiding wrong cable connections. See page 2-35 for details.

ASUS O.C. Profile



The motherboard features the ASUS O.C. Profile that allows users to conveniently store or load multiple BIOS settings. The BIOS settings can be stored in the CMOS or a separate file, giving users freedom to share and distribute their favorite settings. See page 4-40 for details.

ASUS EZ Flash 2



EZ Flash 2 is a user-friendly BIOS update utility. Simply press the predefined hotkey to launch the utility and update the BIOS without entering the OS. Update your BIOS easily without preparing a bootable diskette or using an OS-based flash utility. See pages 4-5 and 4-42 for details.

ASUS MyLogo3™



This feature allows you to convert your favorite photo into a 256-color boot logo for a more colorful and vivid image on your screen. See page 5-9 for details.

ASUS Multi-language BIOS



The multi-language BIOS allows you to select the language of your choice from the available options. The localized BIOS setup menu helps you configure your system easier and faster. See page 4-13 for details.

1.3.3 ASUS Intelligent Performance and Overclocking features

AI Booster

The ASUS AI Booster allows you to overclock the CPU speed in Windows environment without the hassle of booting the BIOS. See page 5-23 for details.

Precision Tweaker 2



Allows the user to adjust the NB Voltage, FSB termination Voltage, CPU PLL Voltage and the DRAM Voltage in 0.02v steps to finetune voltages to achieve the most precise setting for the ultimate customized overclocking configuration. See pages 4-18 to 4-24 for details.

C.P.R. (CPU Parameter Recall)

The C.P.R. feature of the motherboard BIOS allows automatic re-setting to the BIOS default settings in case the system hangs due to overclocking. When the system hangs due to overclocking, C.P.R. eliminates the need to open the system chassis and clear the RTC data. Simply shut down and reboot the system, and the BIOS automatically restores the CPU default setting for each parameter.

This chapter lists the hardware setup procedures that you have to perform when installing system components. It includes description of the jumpers and connectors on the motherboard.

Hardware information



2.1	Before you proceed	2-1
2.2	Motherboard overview.....	2-2
2.3	Central Processing Unit (CPU)	2-6
2.4	System memory	2-13
2.5	Expansion slots.....	2-18
2.6	Jumper	2-22
2.7	Connectors	2-23

2.1 Before you proceed

Take note of the following precautions before you install motherboard components or change any motherboard settings.



- Unplug the power cord from the wall socket before touching any component.
- Use a grounded wrist strap or touch a safely grounded object or a metal object, such as the power supply case, before handling components to avoid damaging them due to static electricity.
- Hold components by the edges to avoid touching the ICs on them.
- Whenever you uninstall any component, place it on a grounded antistatic pad or in the bag that came with the component.
- Before you install or remove any component, ensure that the ATX power supply is switched off or the power cord is detached from the power supply. Failure to do so may cause severe damage to the motherboard, peripherals, and/or components.

Onboard LED

The motherboard comes with a standby power LED. The green LED lights up to indicate that the system is ON, in sleep mode, or in soft-off mode. This is a reminder that you should shut down the system and unplug the power cable before removing or plugging in any motherboard component. The illustration below shows the location of the onboard LED.

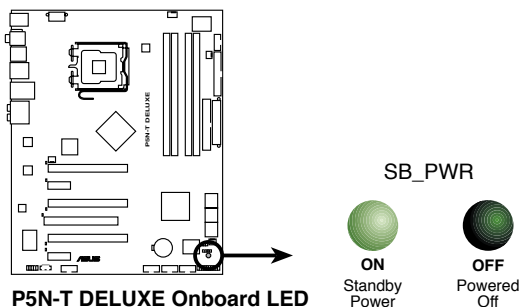

2.2 Motherboard overview

Before you install the motherboard, study the configuration of your chassis to ensure that the motherboard fits into it.



Make sure to unplug the power cord before installing or removing the motherboard. Failure to do so can cause you physical injury and damage motherboard components.

2.2.1 Placement direction

When installing the motherboard, make sure that you place it into the chassis in the correct orientation. The edge with external ports goes to the rear part of the chassis as indicated in the image below.

2.2.2 Screw holes

Place nine (9) screws into the holes indicated by circles to secure the motherboard to the chassis.



DO NOT overtighten the screws! Doing so can damage the motherboard.

Place this side towards the rear of the chassis

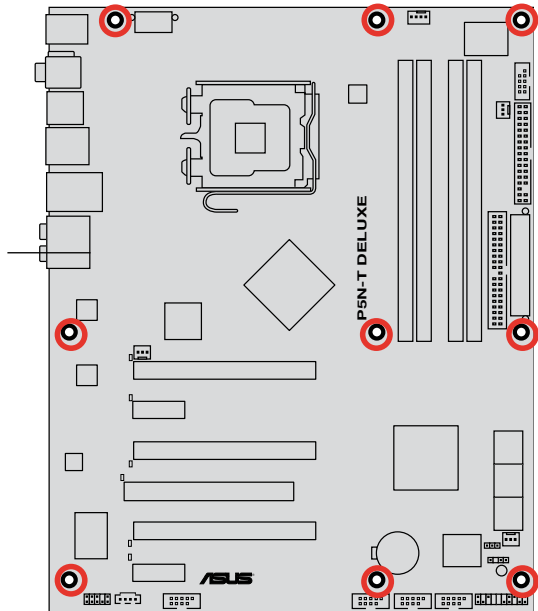

2.2.3 Motherboard layout

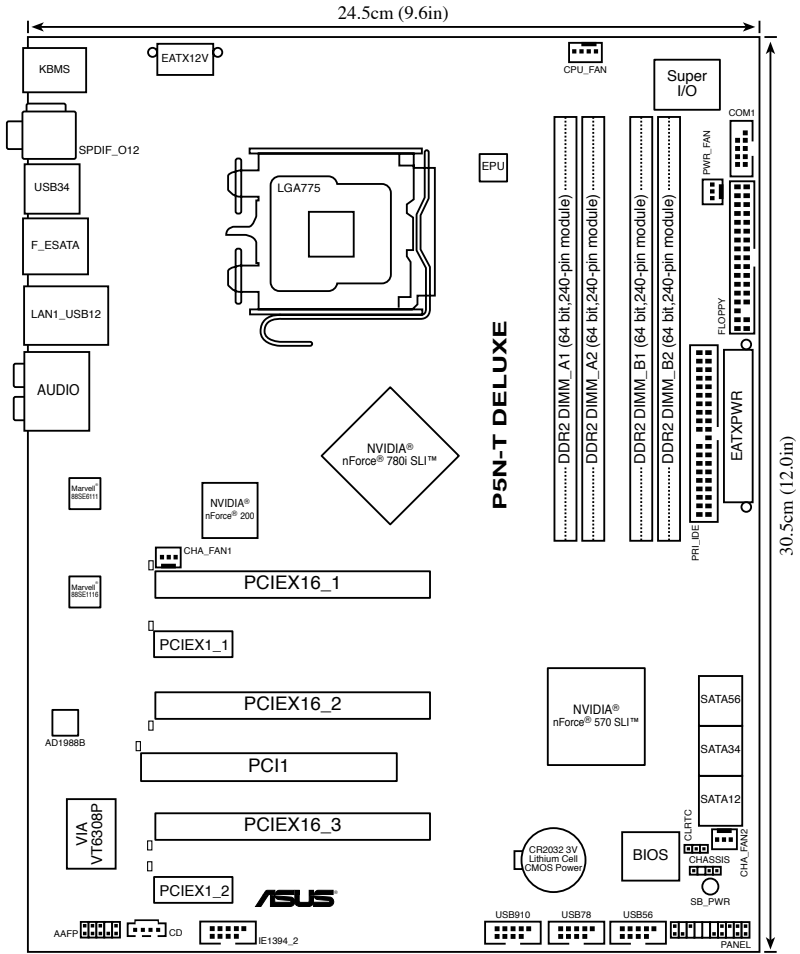

Refer to **2.7 Connectors** for more information about rear panel connectors and internal connectors.

2.2.4 Layout contents

Slots		Page
1.	DDR2 DIMM slots	2-13
2.	PCI slot	2-20
3.	PCI Express x 1 slots	2-20
4.	PCI Express 2.0 x16 slots	2-20

Jumper		Page
1.	Clear RTC RAM (3-pin CLRRTC)	2-22

Rear panel connectors		Page
1.	PS/2 mouse port (green)	2-23
2.	Coaxial S/PDIF Out port	2-23
3.	IEEE 1394a port	2-23
4.	LAN (RJ-45) port	2-23
5.	Center/Subwoofer port (orange)	2-23
6.	Rear Speaker Out port (black)	2-23
7.	Line In port (light blue)	2-23
8.	Line Out port (lime)	2-23
9.	Microphone port (pink)	2-24
10.	Side Speaker Out port (gray)	2-24
11.	USB 2.0 ports 1 and 2	2-24
12.	External SATA port	2-24
13.	USB 2.0 ports 3 and 4	2-24
14.	Optical S/PDIF Out port	2-24
15.	PS/2 keyboard port (purple)	2-24

Internal connectors		Page
1.	Floppy disk drive connector (34-1 pin FLOPPY)	2-25
2.	IDE connector (40-1 pin PRI_IDE))	2-25
3.	Serial ATA connectors (7-pin SATA1-6)	2-26
4.	USB connectors (10-1 pin USB56, USB78, USB910)	2-27
5.	IEEE 1394a port connector (10-1 pin IE1394_2)	2-28
6.	Serial port connector (10-1 pin COM1)	2-28
7.	CPU, chassis, power, and optional fan connectors (4-pin CPU_FAN, 3-pin CHA_FAN1-2, 3-pin PWR_FAN)	2-29
8.	Chassis intrusion connector (4-1 pin CHASSIS)	2-30
9.	ATX power connectors (24-pin EATXPWR, 2 x 4-pin EATX12V)	2-30
10.	Front panel audio connector (10-1 pin AAFP)	2-33
11.	Optical drive audio connector (4-pin CD)	2-33
12.	System panel connector (20-8 pin PANEL)	2-34
13.	ASUS Q-Connector (system panel)	2-35

2.3 Central Processing Unit (CPU)

The motherboard comes with a surface mount LGA775 socket designed for the Intel® Core™2 Quad / Core™2 Extreme / Core™2 Duo / Pentium® Extreme / Pentium® D/ Pentium® 4 processors.



-
- Make sure that all power cables are unplugged before installing the CPU.
 - If installing a dual-core CPU, connect the chassis fan cable to the CHA_FAN1 connector to ensure system stability.
 - Due to the chipset limitation, we recommend you use FSB 800MHz CPU or above.
-



- Upon purchase of the motherboard, make sure that the PnP cap is on the socket and the socket contacts are not bent. Contact your retailer immediately if the PnP cap is missing, or if you see any damage to the PnP cap/socket contacts/motherboard components. ASUS will shoulder the cost of repair only if the damage is shipment/transit-related.
 - Keep the cap after installing the motherboard. ASUS will process Return Merchandise Authorization (RMA) requests only if the motherboard comes with the cap on the LGA775 socket.
 - The product warranty does not cover damage to the socket contacts resulting from incorrect CPU installation/removal, or misplacement/loss/incorrect removal of the PnP cap.
-

2.3.1 Installing the CPU

To install a CPU:

1. Locate the CPU socket on the motherboard.

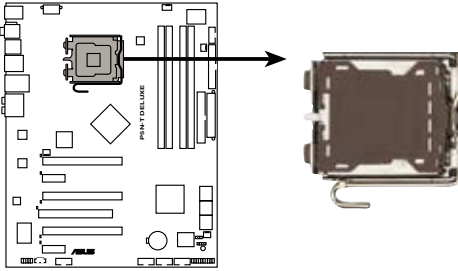

P5N-T DELUXE CPU Socket 775



Before installing the CPU, make sure that the socket box is facing towards you and the load lever is on your left.

2. Press the load lever with your thumb (A), then move it to the left (B) until it is released from the retention tab.

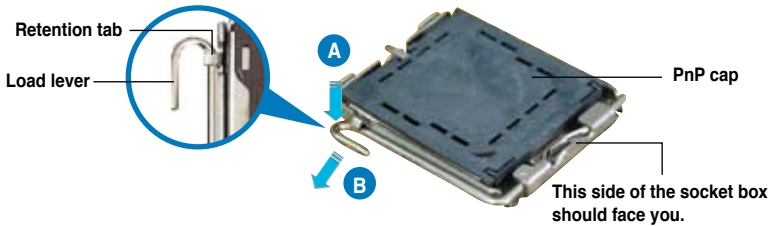

To prevent damage to the socket pins, do not remove the PnP cap unless you are installing a CPU.

3. Lift the load lever in the direction of the arrow to a 135° angle.

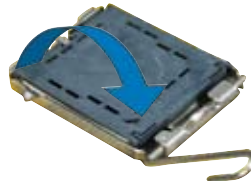

- Lift the load plate with your thumb and forefinger to a 100° angle (A), then push the PnP cap from the load plate window to remove (B).

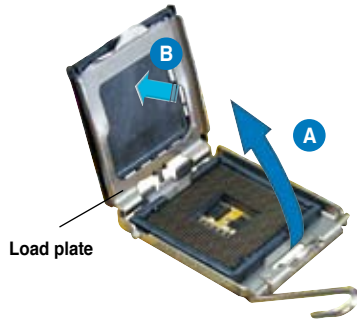

- Position the CPU over the socket, making sure that the gold triangle is on the bottom-left corner of the socket then fit the socket alignment key into the CPU notch.

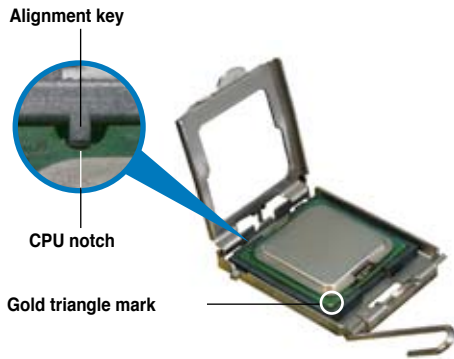

The CPU fits in only one correct orientation. DO NOT force the CPU into the socket to prevent bending the connectors on the socket and damaging the CPU!

- Close the load plate (A), then push the load lever (B) until it snaps into the retention tab.
- If installing a dual-core CPU, connect the chassis fan cable to the CHA_FAN1 connector to ensure system stability.

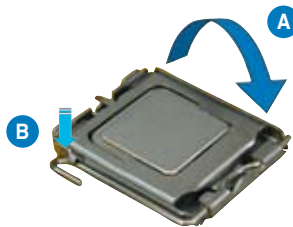

The motherboard supports Intel® LGA775 processors with the Intel® Enhanced Memory 64 Technology (EM64T), Enhanced Intel SpeedStep® Technology (EIST), and Hyper-Threading Technology. Refer to the Appendix for more information on these CPU features.

2.3.2 Installing the CPU heatsink and fan

The Intel® LGA775 processor requires a specially designed heatsink and fan assembly to ensure optimum thermal condition and performance.



- When you buy a boxed Intel® processor, the package includes the CPU fan and heatsink assembly. If you buy a CPU separately, make sure that you use only Intel®-certified multi-directional heatsink and fan.
- Your Intel® LGA775 heatsink and fan assembly comes in a push-pin design and requires no tool to install.
- If you purchased a separate CPU heatsink and fan assembly, make sure that you have properly applied Thermal Interface Material to the CPU heatsink or CPU before you install the heatsink and fan assembly.



Make sure that you have installed the motherboard to the chassis before you install the CPU fan and heatsink assembly.

To install the CPU heatsink and fan:

1. Place the heatsink on top of the installed CPU, making sure that the four fasteners match the holes on the motherboard.



Orient the heatsink and fan assembly such that the CPU fan cable is closest to the CPU fan connector.

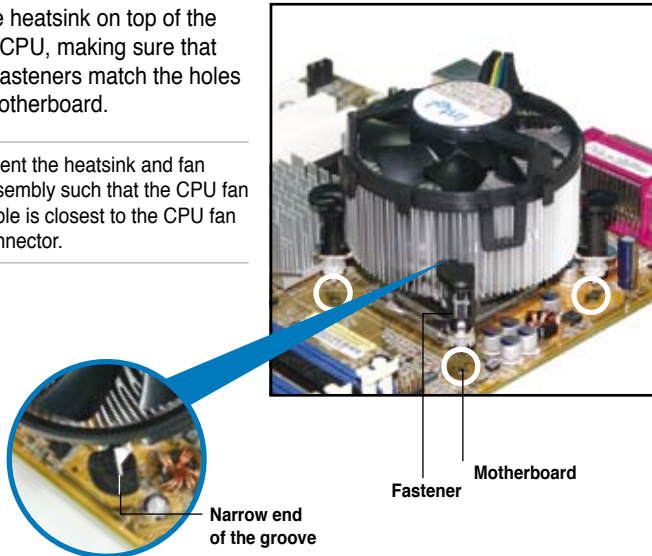

Make sure to orient each fastener with the narrow end of the groove pointing outward. (The photo shows the groove shaded for emphasis.)

2. Push down two fasteners at a time in a diagonal sequence to secure the heatsink and fan assembly in place.

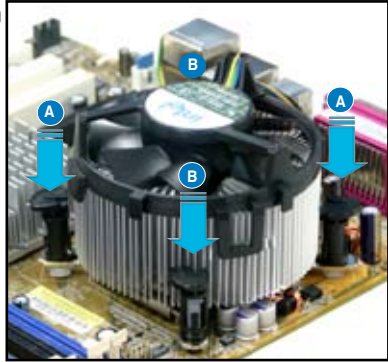
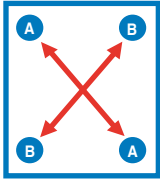

3. Connect the CPU fan cable to the connector on the motherboard labeled CPU_FAN.

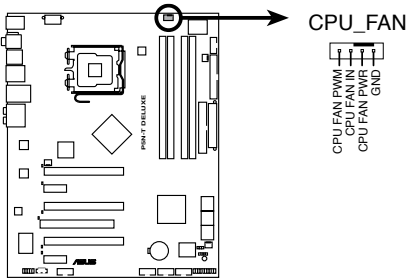

P5N-T DELUXE CPU fan connector



Do not forget to connect the CPU fan connector! Hardware monitoring errors can occur if you fail to plug this connector.

2.3.3 Uninstalling the CPU heatsink and fan

To uninstall the CPU heatsink and fan:

1. Disconnect the CPU fan cable from the connector on the motherboard.
2. Rotate each fastener counterclockwise.

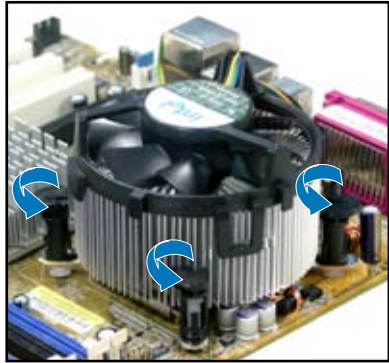

3. Pull up two fasteners at a time in a diagonal sequence to disengage the heatsink and fan assembly from the motherboard.

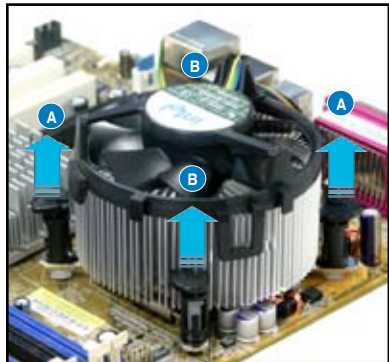
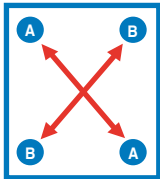

4. Carefully remove the heatsink and fan assembly from the motherboard.



5. Rotate each fastener clockwise to ensure correct orientation when reinstalling.

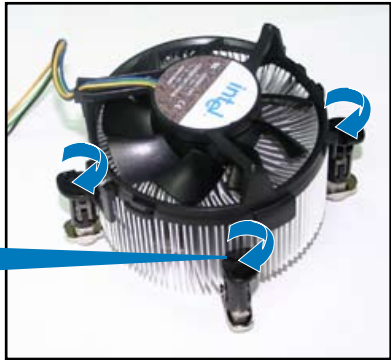

Narrow end of the groove



The narrow end of the groove should point outward after resetting. (The photo shows the groove shaded for emphasis.)



Refer to the documentation in the boxed or stand-alone CPU fan package for detailed information on CPU fan installation.

2.4 System memory

2.4.1 Overview

The motherboard comes with four Double Data Rate 2 (DDR2) Dual Inline Memory Modules (DIMM) sockets.

A DDR2 module has the same physical dimensions as a DDR DIMM but has a 240-pin footprint compared to the 184-pin DDR DIMM. DDR2 DIMMs are notched differently to prevent installation on a DDR DIMM socket.

The figure illustrates the location of the DDR2 DIMM sockets:

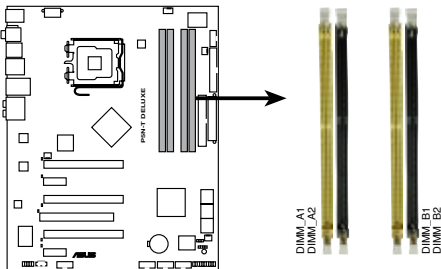

P5N-T DELUXE 240-pin DDR3 DIMM sockets

Channel	Sockets
Channel A	DIMM_A1 and DIMM_A2
Channel B	DIMM_B1 and DIMM_B2

2.4.2 Memory configurations

You may install 512 MB, 1 GB, and 2 GB unbuffered non-ECC DDR2 DIMMs into the DIMM sockets.

Mode	Sockets			
	DIMM_A1	DIMM_B1	DIMM_A2	DIMM_B2
Single-Channel	Populated	-	-	-
	-	Populated	-	-
Dual-channel (1)	Populated	Populated	-	-
Dual-channel (2)	Populated	Populated	Populated	Populated



-
- You may install varying memory sizes in Channel A and Channel B. The system maps the total size of the lower-sized channel for the dual-channel configuration. Any excess memory from the higher-sized channel is then mapped for single-channel operation.
 - Always install DIMMs with the same CAS latency. For optimum compatibility, it is recommended that you obtain memory modules from the same vendor.
 - Due to chipset resource allocation, the system may detect less than 8 GB system memory when you installed four 2 GB DDR2 memory modules.
-



-
- If you install four 1 GB memory modules, the system may detect less than 3 GB of total memory because of address space allocation for other critical functions. This limitation applies to Windows Vista 32-bit/Windows XP 32-bit version operating system since it does not support PAE (Physical Address Extension) mode.
 - If you install Windows Vista 32-bit/Windows XP 32-bit version operating system, we recommend that you install less than 3GB of total memory.

Notes on memory limitations

- Due to chipset limitation, this motherboard can only support up to 8 GB on the operating systems listed below. You may install a maximum of 2 GB DIMMs on each slot.

64-bit
Windows XP Professional x64 Edition
Windows Vista x64 Edition

2.4.3 Installing a DIMM



Unplug the power supply before adding or removing DIMMs or other system components. Failure to do so can cause severe damage to both the motherboard and the components.

To install a DIMM:

1. Unlock a DIMM socket by pressing the retaining clips outward.
2. Align a DIMM on the socket such that the notch on the DIMM matches the break on the socket.
3. Firmly insert the DIMM into the socket until the retaining clips snap back in place and the DIMM is properly seated.

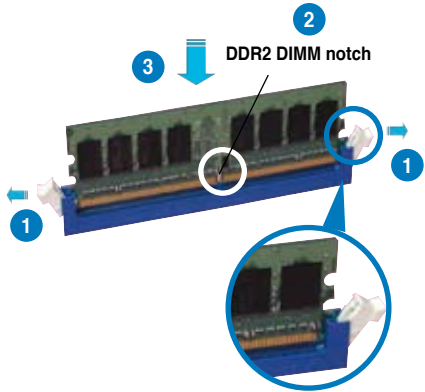

Unlocked retaining clip



- A DDR2 DIMM is keyed with a notch so that it fits in only one direction. Do not force a DIMM into a socket to avoid damaging the DIMM.
- The DDR2 DIMM sockets do not support DDR DIMMs. Do not install DDR DIMMs to the DDR2 DIMM sockets.

2.4.4 Removing a DIMM

To remove a DIMM:

1. Simultaneously press the retaining clips outward to unlock the DIMM.



Support the DIMM lightly with your fingers when pressing the retaining clips. The DIMM might get damaged when it flips out with extra force.

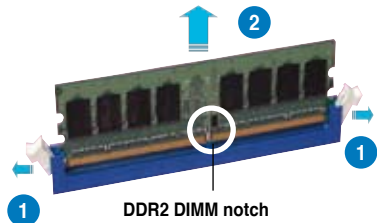

2. Remove the DIMM from the socket.

P5N-T Deluxe Motherboard Qualified Vendors Lists (QVL) DDR2-800MHz capability

Size	Vendor	Chip No.	CL	Chip Brand	SS/ DS	Part No.	DIMM support		
							A*	B*	C*
512MB	KINGSTON	K4T51083QC	5	SEC	SS	KVR800D2N5/512	•	•	•
1024MB	KINGSTON	Heat-Sink Package	4-4-4-12	N/A	DS	KHX6400D2LL/1G	•		
1024MB	KINGSTON	Heat-Sink Package	4-4-4-12	N/A	SS	KHX6400D2LLK2/1GN	•	•	•
1024MB	KINGSTON	V59C1512804QBF25	N/A	N/A	DS	KVR800D2N5/1G		•	
1024MB	KINGSTON	Heat-Sink Package	N/A	N/A	SS	KHX6400D2JLK2/1G	•	•	•
2048MB	KINGSTON	Heat-Sink Package	N/A	N/A	DS	KHX6400D2JLK2/2G	•	•	•
1024MB	Qimonda	HYB18T512800BF25F	5-5-5	N/A	DS	HYS64T128020HU-25F-B	•	•	•
1024MB	Hynix	HY5PS12821CFP-S5	5-5-5	Hynix	DS	HYMP512U64CP8-S5	•	•	•
1024MB	MICRON	D9GKX	N/A	N/A	DS	MT16HTF12864AY-80ED4	•	•	•
1024MB	CORSAIR	Heat-Sink Package	4	N/A	DS	CM2X1024-6400C4	•		•
512MB	Crucial	Heat-Sink Package	4	N/A	SS	BL6464AA804.8FD	•	•	•
1024MB	Crucial	Heat-Sink Package	4	N/A	DS	BL12864AA804.16FD	•		•
1024MB	Crucial	Heat-Sink Package	4	N/A	DS	BL12864AL804.16FD3	•	•	•
1024MB	Crucial	Heat-Sink Package	4	N/A	DS	BL12864AA804.16FD3	•	•	•
1024MB	Apacer	Heat-Sink Package	5	N/A	DS	AHU01GE800C5K1C	•		
512MB	A-DATA	AD29608A8A-25EG	N/A	N/A	SS	M2OAD6G3H3160G1E53			•
1024MB	A-DATA	AD26908A8A-25EG	N/A	N/A	DS	M2OAD6G3I41701H1E58	•	•	•
512MB	KINGMAX	KKA8FEIBF-HJK-25A	N/A	KINGMAX	SS	KLDC28F-ABK15	•	•	
1024MB	KINGMAX	KKA8FEIBF-HJK-25A	N/A	KINGMAX	DS	KLDD48F-ABK15		•	•
1024MB	Super Talent	Heat-Sink Package	N/A	N/A	DS	T800UB1GC4	•		
1024MB	NANYA	NT5TU64M8BE-25C	5	NANYA	DS	NT1GT64U8HBOBY-25C	•	•	•
1024MB	NANYA	NT5TU64M8CE-25D	N/A	NANYA	DS	NT1GT64U8HCOBY-25D	•	•	
512MB	PSC	A3R12E3HEF641B9A05	5	PSC	SS	AL6E8E63B8E1K	•	•	•
1024MB	PSC	A3R12E3HEF641B9A05	5	PSC	DS	AL7E8E63B-8E1K	•	•	•
256MB	TwinMOS	E2508AB-GE-E	5	ELPIDA	SS	8G-24IK2-EBT	•		
1024MB	Elixir	N2TU51280BE-25C	N/A	Elixir	DS	M2Y1G64TU8HB0B-25C	•	•	



SS - Single-sided / DS - Double-sided DIMM support:

- **A*:** Supports one module inserted in any slot as Single-channel memory configuration.
- **B*:** Supports one pair of modules inserted into either the yellow slots or the black slots as one pair of Dual-channel memory configuration.
- **C*:** Supports four modules inserted into both the yellow and black slots as two pairs of Dual-channel memory configuration.



Visit the ASUS website for the latest DDR2-800/667 MHz QVL.

P5N-T Deluxe Motherboard Qualified Vendors Lists (QVL)

DDR2-667MHz capability

Size	Vendor	Chip No.	CL	Chip Brand	SS/ DS	Part No.	DIMM support		
							A*	B*	C*
512MB	KINGSTON	D6408TEBGL3U	5	KINGSTON	SS	KVR667D2N5/512	•	•	
256MB	KINGSTON	HYB18T256800AF3S	5	N/A	SS	KVR667D2N5/256	•	•	
256MB	KINGSTON	6SBI2D9DCG	5	MICRON	SS	KVR667D2N5/256	•		
2048MB	KINGSTON	E1108AB-6E-E	N/A	ELPIDA	DS	KVR667D2N5/2G	•		
512MB	Qimonda	HYB18T512800BF3S	5	N/A	SS	HYS64T64000HU-3S-B	•	•	•
1024MB	Qimonda	HYB18T512800BF3S	5	N/A	DS	HYS64T128020HU-3S-B	•	•	•
512MB	SAMSUNG	K4T51163QE-ZCE6	5	SAMSUNG	DS	M378T3354EZ3-CE6	•	•	•
256MB	SAMSUNG	K4T51083QE	5	SAMSUNG	SS	M378T6553EZS-CE6	•	•	
1024MB	SAMSUNG	K4T51083QE	5	SAMSUNG	DS	M378T2953EZ3-CE6	•	•	
256MB	Hynix	HY5PS121621CFP-Y5	5	Hynix	SS	HYMP532U64CP6-Y5	•	•	•
1024MB	Hynix	HY5PS12821CFP-Y5	5	Hynix	DS	HYMP512U64CP8-Y5	•	•	•
512MB	CORSAIR	64M8CFEG	N/A	N/A	SS	VS512MB667D2	•	•	
1024MB	CORSAIR	64M8CFEG	N/A	N/A	DS	VS1GB667D2	•	•	•
256MB	ELPIDA	E2508AB-6E-E	5	ELPIDA	SS	EBE25UC8ABFA-6E-E	•		
512MB	ELPIDA	E5108AE-6E-E	5	ELPIDA	SS	EBE51UD8AEFA-6E-E	•	•	•
512MB	A-DATA	AD29608A8A-3EG	5	A-DATA	SS	M2OAD5G3H316611C52	•	•	
1024MB	A-DATA	AD29608A8A-3EG	5	A-DATA	DS	M2OAD5G3H417611C52	•	•	
512MB	crucial	Heat-Sink Package	3	N/A	SS	BL6464AA663.8FD	•		
1024MB	crucial	Heat-Sink Package	3	N/A	DS	BL12864AA663.16FD	•	•	•
1024MB	crucial	Heat-Sink Package	3	N/A	DS	BL12864AL664.16FD	•	•	•
1024MB	crucial	Heat-Sink Package	3	N/A	DS	BL12864AA663.16FD2	•		
512MB	Apacer	AM4B5708GQJS7E0628F	5	APACER	SS	AU512E667C5KBGC	•		
1024MB	Apacer	AM4B5708GQJS7E	5	APACER	DS	AU01GE667C5KBGC	•	•	•
256MB	Kingmax	N2TU51216AG-3C	5	NANYA	SS	KLCB68F-36KH5			•
512MB	Kingmax	KKEA88B4LAUG-29DX	5	KINGMAX	SS	KLCC28F-A8KB5	•	•	
1024MB	Kingmax	KKEA88B4LAUG-29DX	5	KINGMAX	DS	KLCD48F-A8KB5	•		
512MB	Super Talent	Heat-Sink Package	5	N/A	SS	T6UA512C5		•	
1024MB	Super Talent	Heat-Sink Package	5	N/A	DS	T6UB1GC5	•	•	
2048MB	NANYA	NT5TU128M8BJ-3C	5	NANYA	DS	NT2GT64U8HBOJY-3C	•	•	•
512MB	NANYA	NT5TU64M8BE-3C	5	NANYA	SS	NT512T64U88B0BY-3C	•	•	•
512MB	PSC	A3R12E3GEF637BLC5N	5	PSC	SS	AL6E8E63B-6E1K	•	•	•
1024MB	PSC	A3R12E3GEF637BLC5N	5	PSC	DS	AL7E8E63B-6E1K	•	•	•
512MB	TwinMOS	TMM6208G8M30C	5	TwinMOS	SS	8D-23JK5M2ETP	•	•	•

2.5 Expansion slots

In the future, you may need to install expansion cards. The following sub-sections describe the slots and the expansion cards that they support.



Make sure to unplug the power cord before adding or removing expansion cards. Failure to do so may cause you physical injury and damage motherboard components.

2.5.1 Installing an expansion card

To install an expansion card:

1. Before installing the expansion card, read the documentation that came with it and make the necessary hardware settings for the card.
2. Remove the system unit cover (if your motherboard is already installed in a chassis).
3. Remove the bracket opposite the slot that you intend to use. Keep the screw for later use.
4. Align the card connector with the slot and press firmly until the card is completely seated on the slot.
5. Secure the card to the chassis with the screw you removed earlier.
6. Replace the system cover.

2.5.2 Configuring an expansion card

After installing the expansion card, configure it by adjusting the software settings.

1. Turn on the system and change the necessary BIOS settings, if any. See Chapter 4 for information on BIOS setup.
2. Assign an IRQ to the card. Refer to the tables on the next page.
3. Install the software drivers for the expansion card.



When using PCI cards on shared slots, ensure that the drivers support “Share IRQ” or that the cards do not need IRQ assignments. Otherwise, conflicts will arise between the two PCI groups, making the system unstable and the card inoperable. Refer to the table on the next page for details.

2.5.3 Interrupt assignments

IRQ	Standard function
0	System timer
1	Standard 101/102-key or Microsoft Natural Keyboard
4	Communications Port (COM1)*
6	Standard floppy disk controller
8	System CMOS/real-time clock
9	Microsoft ACPI-compliant system
9	NVIDIA nForce networking controller #3
9	NVIDIA nForce networking controller #4
10	NVIDIA nForce PCI system management
11	Mass storage controller
12	PS/2 compatible mouse port
13	Numeric data processor
14	Primary IDE channel
16	NVIDIA GeForce 6600 GT
19	VIA OHCI compliant IEEE 1394 host controller
20	NVIDIA nForce 590/570/550 Serial ATA controller
20	NVIDIA network bus enumerator
21	NVIDIA network bus enumerator
22	Standard OpenHCD USB host controller
22	NVIDIA nForce 590/570/550 Serial ATA controller
23	Standard Enhanced PCI to USB host controller
23	NVIDIA nForce 590/570/550 Serial ATA controller

IRQ assignments for this motherboard

	A	B	C	D	E	F	G	H
PCIEx16_1	-	-	-	-	shared	-	-	-
PCIEx16_2	-	-	-	-	-	shared	-	-
PCIEx16_3	-	-	-	-	shared	-	-	-
PCI Slot	-	-	-	-	-	shared	-	-
PCIEx1_1	shared	-	-	-	-	-	-	-
PCIEx1_2	-	shared	-	-	-	-	-	-
USB 1.1	-	shared	-	-	-	-	-	-
USB 2.0	-	-	shared	-	-	-	-	-
LAN	-	shared	-	-	-	-	-	-
PATA	shared	-	-	-	-	-	-	-
SATA_1	-	shared	-	-	-	-	-	-
SATA_2	-	-	shared	-	-	-	-	-
SATA_3	-	-	-	used	-	-	-	-
SATA_RAID	-	shared	-	-	-	-	-	-
1394	-	shared	-	-	-	-	-	-
Audio	-	-	shared	-	-	-	-	-

2.5.4 PCI slot

The PCI slots support cards such as a LAN card, SCSI card, USB card, and other cards that comply with PCI specifications. Refer to the figure below for the location of the slot.

2.5.5 PCI Express x1 slots

This motherboard supports PCI Express x1 network cards, SCSI cards and other cards that comply with the PCI Express specifications. Refer to the figure below for the location of the slots.

2.5.6 PCI Express 2.0 x16 slots

This motherboard has three PCI Express x16 slots that support PCI Express x16 graphic cards complying with the PCI Express specifications. With three graphics cards installed, the motherboard can enable tri-display. Two (blue slots) of the three PCI Express x16 slots support PCIe 2.0 devices.

This motherboard supports 3 SLI-ready Express x16 graphics cards that comply with the PCI Express specifications.

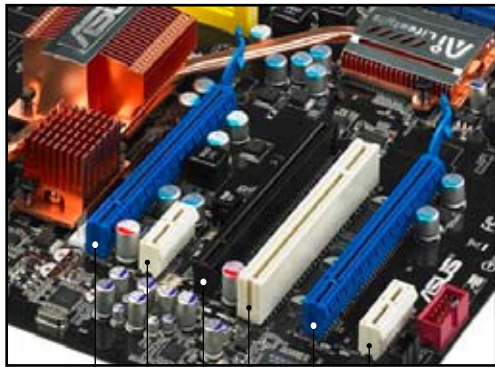

PCI Express x1_2 slot
PCIe 2.0 x16_3 slot (blue, @x16)
PCI slot
PCIe x16_2 slot (black, @x16)
PCI Express x1_1 slot
PCIe 2.0 x16_1 slot (blue, @x16)



-
- We recommend that you install a VGA card on the primary (blue) PCI Express slots, and install any other PCI Express device on the PCI Express slot (black).
 - Currently, only NVIDIA® SLI™-Ready **GeForce® 8800 Ultra** and **GeForce® 8800 GTX** graphics cards support 3-Way SLI™ mode.
 - Connect a rear chassis fan to the chassis (CHA_FAN1 or CHA_FAN2) connector when using two (or three) graphics cards for better thermal environment. See page 2-29 for details.
 - We recommend that you provide sufficient power when running NVIDIA® SLI™ mode. See page 2-30 for details.
 - In single card mode, we suggest that you use any of the PCIe 2.0 slots (blue) for a PCI Express x16 graphics card to get better performance.
 - In SLI™ mode, we recommend that you use the PCIe 2.0 slots (blue slots) for PCI Express x16 graphics cards to get better performance.
 - We recommend that you provide sufficient power when running NVIDIA® SLI™ mode. See page 2-30 for details.
-

2.6 Jumper

1. Clear RTC RAM (3-pin CLRRTC)

This jumper allows you to clear the Real Time Clock (RTC) RAM in CMOS. You can clear the CMOS memory of date, time, and system setup parameters by erasing the CMOS RTC RAM data. The onboard button cell battery powers the RAM data in CMOS, which include system setup information such as system passwords.

To erase the RTC RAM:

1. Turn OFF the computer and unplug the power cord.
2. Remove the onboard battery.
3. Move the jumper cap from pins 1-2 (default) to pins 2-3. Keep the cap on pins 2-3 for about 5~10 seconds, then move the cap back to pins 1-2.
4. Reinstall the battery.
5. Plug the power cord and turn ON the computer.
6. Hold down the key during the boot process and enter BIOS setup to re-enter data.

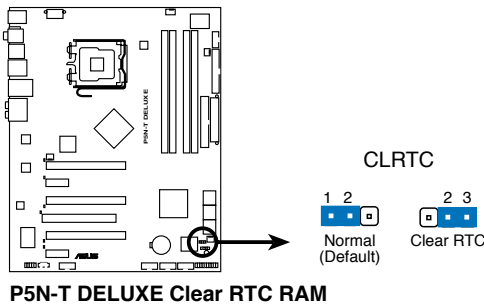

- Make sure to re-enter your previous BIOS settings after you clear the CMOS.
- You do not need to clear the RTC when the system hangs due to overclocking. For system failure due to overclocking, use the C.P.R. (CPU Parameter Recall) feature. Shut down and reboot the system so the BIOS can automatically reset parameter settings to default values.

2.7 Connectors

2.7.1 Rear panel connectors

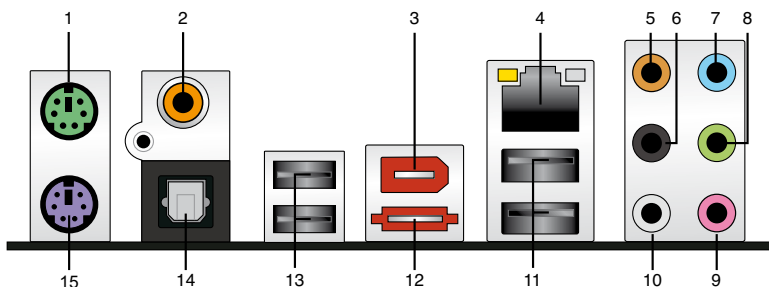

1. **PS/2 mouse port (green).** This port is for a PS/2 mouse.
2. **Coaxial S/PDIF Out port.** This port connects an external audio output device via a coaxial S/PDIF cable.
3. **IEEE 1394a port.** This 6-pin IEEE 1394a port provides high-speed connectivity for audio/video devices, storage peripherals, PCs, or portable devices.
4. **LAN (RJ-45) port.** This port allows Gigabit connection to a Local Area Network (LAN) through a network hub. Refer to the table below for the LAN port LED indications.

LAN port LED indications

Activity/Link Speed LED			
Status	Description	Status	Description
OFF	No link	OFF	10 Mbps connection
ORANGE	Linked	ORANGE	100 Mbps connection
BLINKING	Data activity	GREEN	1 Gbps connection

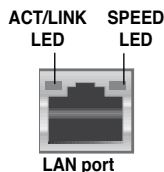

5. **Center/Subwoofer port (orange).** This port connects the center/subwoofer speakers.
6. **Rear Speaker Out port (black).** This port connects the rear speakers in a 4-channel, 6-channel, or 8-channel audio configuration..
7. **Line In port (light blue).** This port connects the tape, CD, DVD player, or other audio sources.
8. **Line Out port (lime).** This port connects a headphone or a speaker. In 4-channel, 6-channel, and 8-channel configuration, the function of this port becomes Front Speaker Out.

- 9. **Microphone port (pink).** This port connects a microphone.
- 10. **Side Speaker Out port (gray).** This port connects the side speakers in an 8-channel audio configuration.



Refer to the audio configuration table below for the function of the audio ports in 2, 4, 6, or 8-channel configuration.

Audio 2, 4, 6, or 8-channel configuration

Port	Headset 2-channel	4-channel	6-channel	8-channel
Light Blue	Line In	Line In	Line In	Line In
Lime	Line Out	Front Speaker Out	Front Speaker Out	Front Speaker Out
Pink	Mic In	Mic In	Mic In	Mic In
Orange	–	–	Center/Subwoofer	Center/Subwoofer
Black	–	Rear Speaker Out	Rear Speaker Out	Rear Speaker Out
Gray	–	–	–	Side Speaker Out

- 11. **USB 2.0 ports 1 and 2.** These 4-pin Universal Serial Bus (USB) ports are available for connecting USB 2.0 devices.
- 12. **External SATA port.** This port connects to an external a Serial ATA hard disk drive.



The external SATA port supports external Serial ATA 3 Gb/s devices. Longer cables support higher power requirements to deliver signal up to two meters away, and enables improved hot-swap function.



When using hot-plug and NCQ, set the J-Micron eSATA/PATA Controller Mode in the BIOS to [AHCI].



DO NOT insert a different connector to the external SATA port.

- 13. **USB 2.0 ports 3 and 4.** These 4-pin Universal Serial Bus (USB) ports are available for connecting USB 2.0 devices.
- 14. **Optical S/PDIF Out port.** This port connects an external audio output device via an optical S/PDIF cable.
- 15. **PS/2 keyboard port (purple).** This port is for a PS/2 keyboard.

2.7.2 Internal connectors

1. Floppy disk drive connector (34-pin FLOPPY)

This connector is for the provided floppy disk drive (FDD) signal cable. Insert one end of the cable to this connector, then connect the other end to the signal connector at the back of the floppy disk drive.



Pin 5 on the connector is removed to prevent incorrect cable connection when using a FDD cable with a covered Pin 5.

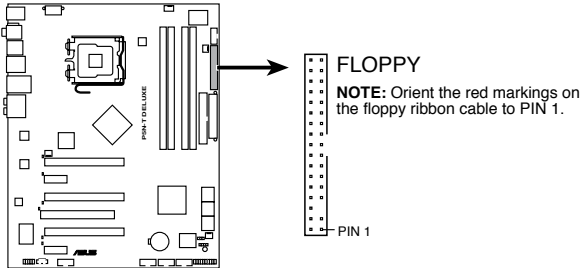

P5N-T DELUXE Floppy disk drive connector

2. IDE connector (40-pin PRI_IDE)

The onboard IDE connector is for the Ultra DMA 133/100/66 signal cable. There are three connectors on each Ultra DMA 133/100/66 signal cable: blue, black, and gray. Connect the blue connector to the motherboard's IDE connector, then select one of the following modes to configure your device.

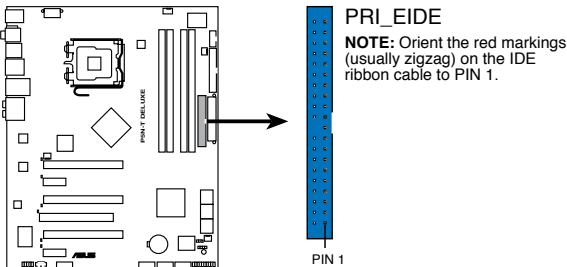

P5N-T DELUXE IDE connector

	Drive jumper setting	Mode of device(s)	Cable connector
Single device	Cable-Select or Master	-	Black
Two devices	Cable-Select	Master	Black
		Slave	Gray
	Master	Master	Black or gray
	Slave	Slave	



- Pin 20 on the IDE connector is removed to match the covered hole on the Ultra DMA cable connector. This prevents incorrect insertion when you connect the IDE cable.
- Use the 80-conductor IDE cable for Ultra DMA 133/100/66 IDE devices.



If any device jumper is set as “Cable-Select,” make sure all other device jumpers have the same setting.

3. Serial ATA connectors (7-pin SATA1-6)

These connectors are for the Serial ATA signal cables for Serial ATA hard disk drives.

If you installed Serial ATA hard disk drives, you can create a RAID 0, RAID 1, RAID 0+1, RAID 5, or JBOD configuration with the onboard NVIDIA® MediaShield™ RAID controller.

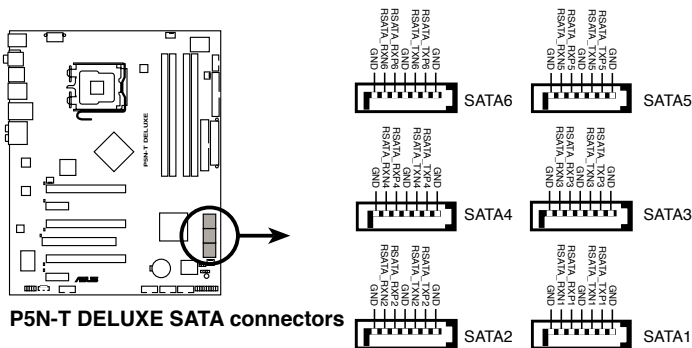

P5N-T DELUXE SATA connectors



The RAID function of these connectors is set to [Disabled] by default. If you intend to create a Serial ATA RAID set using these connectors, enable the **RAID Enabled** item under the **Serial ATA Configuration** sub-menu in the BIOS.



These connectors support Native Command Queuing (NCQ), Power Management (PM) Implementation Algorithm, Hot Swap and smart setup.



Connect the right-angle side of SATA signal cable to the SATA device, or connect the right-angle side of the SATA cable to the onboard SATA port to avoid mechanical conflict with huge graphics cards.

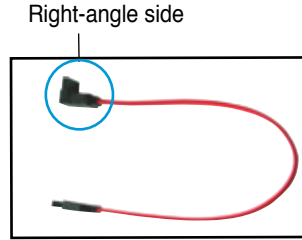

4. USB connectors (10-1 pin USB56, USB78, USB910)

These connectors are for USB 2.0 ports. Connect the USB module cable to any of these connectors, then install the module to a slot opening at the back of the system chassis. These USB connectors comply with USB 2.0 specification that supports up to 480 Mbps connection speed.

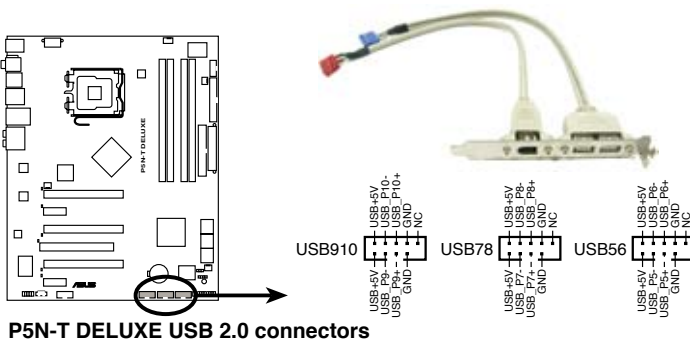

Never connect a 1394 cable to the USB connectors. Doing so will damage the motherboard!



You can connect the USB cable to ASUS Q-Connector (USB, blue) first, and then install the Q-Connector (USB) to the USB connector onboard.

5. IEEE 1394a port connector (10-1 pin IE1394_2)

This connector is for a IEEE 1394a port. Connect the IEEE 1394a module cable to this connector, then install the module to a slot opening at the back of the system chassis.

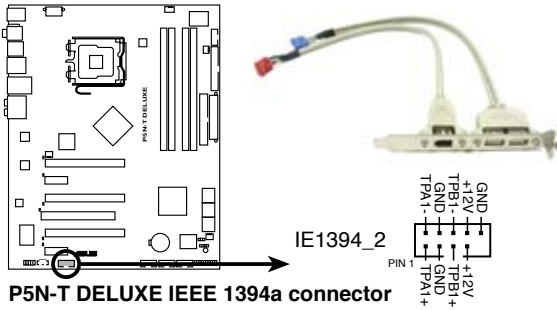

Never connect a USB cable to the IEEE 1394a connector. Doing so will damage the motherboard!



You can connect the 1394 cable to ASUS Q-Connector (1394, red) first, and then install the Q-Connector (1394) to the 1394 connector onboard.

6. Serial port connector (10-1 pin COM1)

This connector is for a serial (COM) port. Connect the serial port module cable to this connector, then install the module to a slot opening at the back of the system chassis.

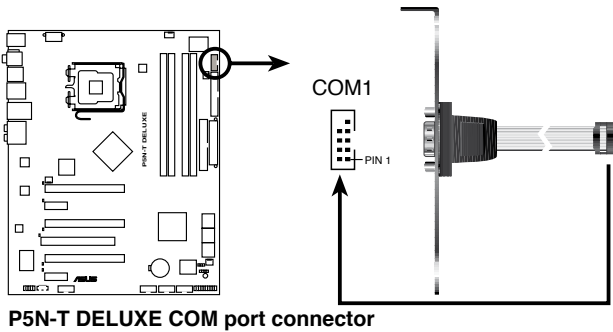

The serial port module is purchased separately.

7. CPU, chassis, power, and optional fan connectors (4-pin CPU_FAN, 3-pin CHA_FAN1-2, 3-pin PWR_FAN)

The fan connectors support cooling fans of 1A~2.2A (26.4 W max.) at +12V. Connect the fan cables to the fan connectors on the motherboard, making sure that the black wire of each cable matches the ground pin of the connector.

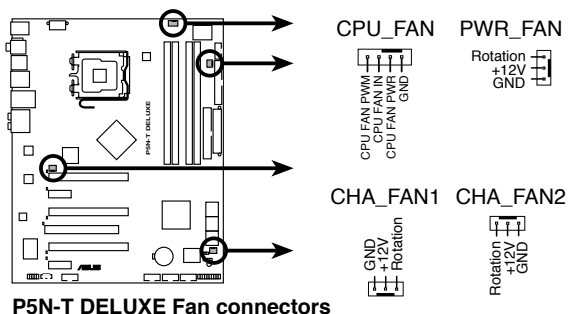

DO NOT forget to connect the fan cables to the fan connectors. Insufficient air flow inside the system may damage the motherboard components. These are not jumpers! DO NOT place jumper caps on the fan connectors!



- Only the CPU_FAN, CHA_FAN1 and CHA_FAN2 connectors support the ASUS Q-FAN 2 feature.
- If you install two VGA cards, we recommend that you plug the rear chassis fan cable to the motherboard connector labeled CHA_FAN1 or CHA_FAN2 for better thermal environment.

8. Chassis intrusion connector (4-1 pin CHASSIS)

This connector is for a chassis-mounted intrusion detection sensor or switch. Connect one end of the chassis intrusion sensor or switch cable to this connector. The chassis intrusion sensor or switch sends a high-level signal to this connector when a chassis component is removed or replaced. The signal is then generated as a chassis intrusion event.

By default, the pin labeled “Chassis Signal” and “Ground” are shorted with a jumper cap. Remove the jumper caps only when you intend to use the chassis intrusion detection feature.

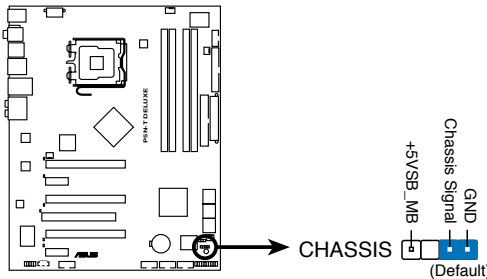

P5N-T DELUXE Chassis intrusion connector

9. ATX power connectors (24-pin EATXPWR, 2 x 4-pin EATX12V)

These connectors are for ATX power supply plugs. The power supply plugs are designed to fit these connectors in only one orientation. Find the proper orientation and push down firmly until the connectors completely fit.

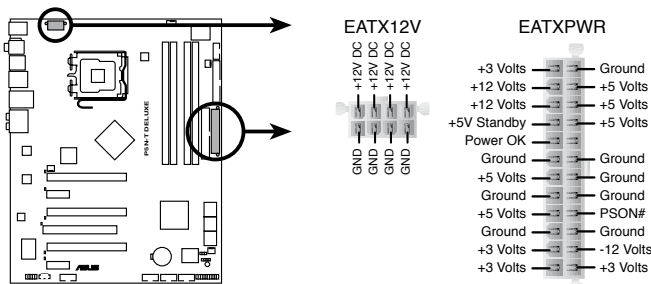

P5N-T DELUXE ATX power connectors



- Make sure to remove the cap on the ATX12V connector before connecting an 8-pin EPS +12V power plug.
- Use only either a 4-pin ATX12V or an 8-pin EPS +12V power plug for the EATX12V connector.



- For a fully configured system, we recommend that you use a power supply unit (PSU) that complies with ATX 12V Specification 2.0 (or later version) and provides a minimum power of 550 W.
- Do not forget to connect the 4-pin/8pin EATX12V power plug; otherwise, the system will not boot.
- If you are uncertain about the minimum power supply requirement for your system, refer to the **Recommended Power Supply Wattage Calculator** at <http://support.asus.com/PowerSupplyCalculator/PSCalculator.aspx?SLanguage=en-us> for details.
- Use of a PSU with a higher power output is recommended when configuring a system with more power-consuming devices. The system may become unstable or may not boot up if the power is inadequate.
- If you want to use two or more high-end PCI Express x16 cards, use a PSU with 1000 W power or above to ensure the system stability.

PSU suggested list

PSU suggested list
SilverStone ST1000
Seasonic SS-600HT
Thermaltake W0083RE
Thermaltake PUREPower-600AP
Silverstone SST-ST75ZF
EnerMAX EG701AX-VE (E)(24P)

- If you want to use 3-Way SLI™ configuration, visit the NVIDIA website (www.nvidia.com) for the qualified PSU vendor list.

Power supply requirements

Heavy Loading	
CPU	SMF 3.2XE
Memory	1 GB*4
VGA	8800 Ultra*3
SATA-HDD	6
eSATA-HDD	1
IDE-CDROM	1
IDE-HDD	1
USB	4

	+12V_8Pin	+12V_24pin	+5V_24pin	+3V_24pin	+12V_VGA1	+12V_VGA2	+12V_VGA3
Voltage (V)	12.14	12.21	5.22	3.456	12.2	12.2	12.2
Current (A)	11.32	13.71	6.41	6.98	6.51	6.59	6.6
Power (W)	137.425	167.399	33.460	24.123	79.422	80.398	80.52
	SATA-HDD	eSATA-HDD	IDE-CDROM	IDE-HDD	USB	Total PSU	
Voltage (V)	6	1	1	1	4	Po_max(w)	
Current (A)	10.45	10.45	10	12.68	2.5	708.577	
Power (W)	62.7	10.45	10	12.68	10		

(continued on the next page)

Normal Loading

CPU	KSF 3.0XE
Memory	1 GB*4
VGA	8800 Ultra*2
SATA-HDD	4
eSATA-HDD	1
IDE-CDROM	1
IDE-HDD	0
USB	4

	+12V_8Pin	+12V_24pin	+5V_24pin	+3V_24pin	+12V_VGA1	+12V_VGA2	+12V_VGA3
Voltage (V)	12.14	12.21	5.225	3.455	12.2	12.2	
Current (A)	6.74	8.92	6.22	6.87	6.52	6.82	
Power (W)	81.824	108.913	32.500	23.736	79.544	83.204	0
	SATA-HDD	eSATA-HDD	IDE-CDROM	IDE-HDD	USB	Total PSU	
Voltage (V)	4	1	1	0	4	Po_max(w)	
Current (A)	10.45	10.45	10	12.68	2.5		
Power (W)	41.8	10.45	10	0	10	481.970	

Light Loading

CPU	Conroe 3.0+EM64T
Memory	1 GB*2
VGA	8800 Ultra*1
SATA-HDD	2
eSATA-HDD	1
IDE-CDROM	1
IDE-HDD	0
USB	4

	+12V_8Pin	+12V_24pin	+5V_24pin	+3V_24pin	+12V_VGA1	+12V_VGA2	+12V_VGA3
Voltage (V)	12.19	12.21	5.22	3.456	12.16		
Current (A)	3.19	5.55	5.04	5.36	6.5		
Power (W)	38.886	67.766	26.309	18.524	79.04	0	0
	SATA-HDD	eSATA-HDD	IDE-CDROM	IDE-HDD	USB	Total PSU	
Voltage (V)	2	1	1	0	4	Po_max(w)	
Current (A)	10.45	10.45	10	12.68	2.5		
Power (W)	20.9	10.45	10	0	10	281.875	

10. Front panel audio connector (10-1 pin AAFP)

This connector is for a chassis-mounted front panel audio I/O module that supports either HD Audio or legacy AC'97 audio standard. Connect one end of the front panel audio I/O module cable to this connector.

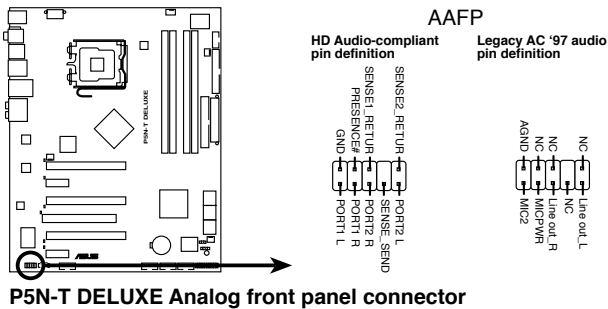

- We recommend that you connect a high-definition front panel audio module to this connector to avail of the motherboard's high-definition audio capability.
- If you want to connect a high-definition front panel audio module to this connector, set the **Front Panel Type** item in the BIOS setup to **[HD Audio]**; if you want to connect an AC'97 front panel audio module to this connector, set the item to **[AC'97]**. By default, this connector is set to **[HD Audio]**.

11. Optical drive audio connector (4-pin CD)

This connector allows you to receive stereo audio input from sound sources such as a CD-ROM, TV tuner, or MPEG card.

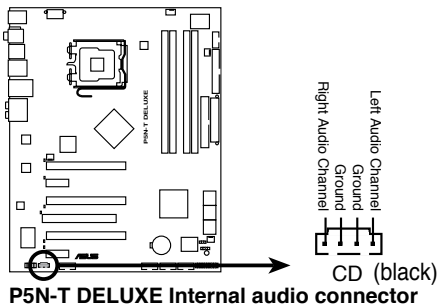

12. System panel connector (20-8 pin PANEL)

This connector supports several chassis-mounted functions.

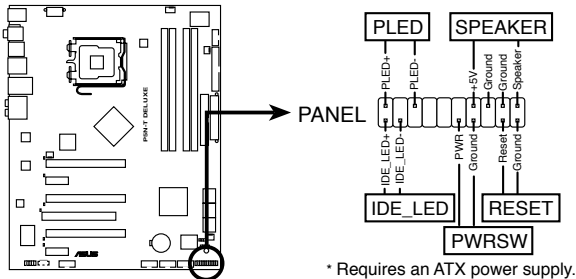

P5N-T DELUXE System panel connector

- **System power LED (2-pin PLED)**

This 2-pin connector is for the system power LED. Connect the chassis power LED cable to this connector. The system power LED lights up when you turn on the system power, and blinks when the system is in sleep mode.

- **Hard disk drive activity LED (2-pin IDE_LED)**

This 2-pin connector is for the HDD Activity LED. Connect the HDD Activity LED cable to this connector. The IDE LED lights up or flashes when data is read from or written to the HDD.

- **System warning speaker (4-pin SPEAKER)**

This 4-pin connector is for the chassis-mounted system warning speaker. The speaker allows you to hear system beeps and warnings.

- **ATX power button/soft-off button (2-pin PWR)**

This connector is for the system power button. Pressing the power button turns the system on or puts the system in sleep or soft-off mode depending on the BIOS settings. Pressing the power switch for more than four seconds while the system is ON turns the system OFF.

- **Reset button (2-pin RESET)**

This 2-pin connector is for the chassis-mounted reset button for system reboot without turning off the system power.

13. ASUS Q-Connector (system panel)

You can use the ASUS Q-Connector to connect/disconnect chassis front panel cables in a few steps. Refer to the instructions below to install the ASUS Q-Connector.

1. Connect the front panel cables to the ASUS Q-Connector.

Refer to the labels on the Q-Connector to know the detailed pin definitions, then match them to the respective front panel cable labels.

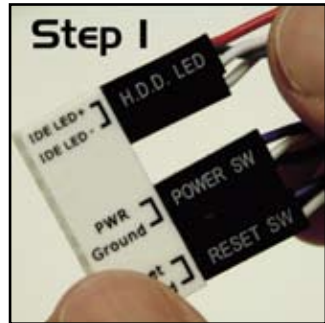

2. Install the ASUS Q-Connector to the system panel connector, making sure the orientation matches the labels on the motherboard.

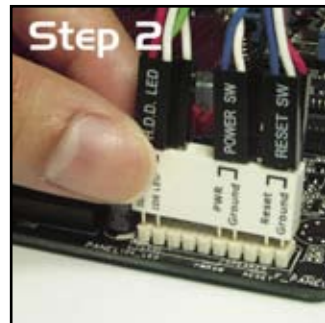

3. The front panel functions are now enabled. The figure shows the Q-Connector properly installed on the motherboard.

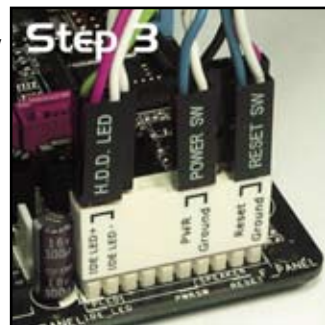

Due to space limitation, when using the PCIEX16_3 slot for a graphics card with a bulky case, do not install the Q-Connector.

2.7.3 Installing the optional fans



Install the optional fan only if you are using a passive cooler or a water cooler. Installing the optional fan with an active CPU cooler will interfere with the airflow and destabilize the system.

1. Position the fan above the pipe and heatsink assembly.
2. Fit the fan to the grooved edge of the heatsink.

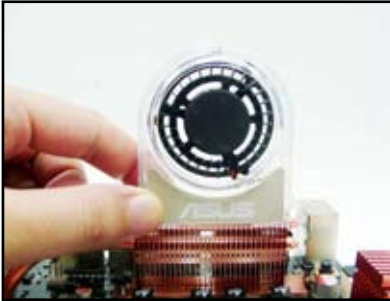

3. Carefully push down the fan until it snugly fits the heatsink, then connect the fan cable.
4. The photo shows the fan installed on the motherboard.

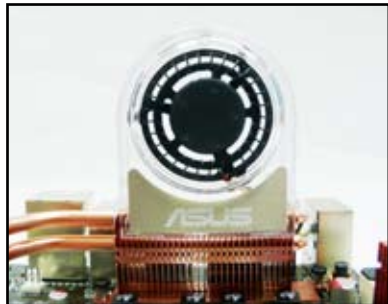

- Plug the optional fan cable to the CHA_FAN1, CHA_FAN2 or PWR_FAN connector on the motherboard.
- Make sure the optional fan is installed correctly to prevent damage to the fan and motherboard components.
- We strongly recommend that you install the optional fan when using a passive cooler or a water cooler.

This chapter describes the power up sequence, the vocal POST messages, and ways of shutting down the system.

Powering up **3**

Chapter summary

3

- 3.1 Starting up for the first time..... 3-1
- 3.2 Turning off the computer..... 3-2

3.1 Starting up for the first time

1. After making all the connections, replace the system case cover.
2. Be sure that all switches are off.
3. Connect the power cord to the power connector at the back of the system chassis.
4. Connect the power cord to a power outlet that is equipped with a surge protector.
5. Turn on the devices in the following order:
 - a. Monitor
 - b. External SCSI devices (starting with the last device on the chain)
 - c. System power
6. After applying power, the system power LED on the system front panel case lights up. For systems with ATX power supplies, the system LED lights up when you press the ATX power button. If your monitor complies with “green” standards or if it has a “power standby” feature, the monitor LED may light up or switch between orange and green after the system LED turns on.

The system then runs the power-on self tests or POST. While the tests are running, the BIOS beeps or additional messages appear on the screen. If you do not see anything within 30 seconds from the time you turned on the power, the system may have failed a power-on test. Check the jumper settings and connections or call your retailer for assistance.
7. At power on, hold down the <Delete> key to enter the BIOS Setup. Follow the instructions in Chapter 4.

3.2 Turning off the computer

3.2.1 Using the OS shut down function

If you are using Windows® XP:

1. Click the Start button then select Turn Off Computer.
2. Click the Turn Off button to shut down the computer.
3. The power supply should turn off after Windows® shuts down.

If you are using Windows® Vista:

1. Click the Start button then select ShutDown.
2. The power supply should turn off after Windows® shuts down.

3.2.2 Using the dual function power switch

While the system is ON, pressing the power switch for less than four seconds puts the system to sleep mode or to soft-off mode, depending on the BIOS setting. Pressing the power switch for more than four seconds lets the system enter the soft-off mode regardless of the BIOS setting. Refer to section **4.6 Power Menu** in Chapter 4 for details.

This chapter tells how to change the system settings through the BIOS Setup menus. Detailed descriptions of the BIOS parameters are also provided.

BIOS setup 4

4.1	Managing and updating your BIOS	4-1
4.2	BIOS setup program	4-9
4.3	Main menu	4-13
4.4	Extreme Tweaker menu	4-18
4.5	Advanced menu	4-25
4.6	Power menu	4-30
4.7	Boot menu	4-35
4.8	Tools menu	4-40
4.9	Exit menu	4-43

4.1 Managing and updating your BIOS

The following utilities allow you to manage and update the motherboard Basic Input/Output System (BIOS) setup.

1. **ASUS Update** (Updates the BIOS in Windows® environment.)
2. **ASUS EZ Flash 2** (Updates the BIOS in DOS using a floppy disk or a USB flash disk.)
3. **Award BIOS Flash Utility** (Updates the BIOS in DOS mode using a bootable floppy disk.)

Refer to the corresponding sections for details on these utilities.



Save a copy of the original motherboard BIOS file to a bootable floppy disk in case you need to restore the BIOS in the future. Copy the original motherboard BIOS using the ASUS Update or Award BIOS Flash utilities.

4.1.1 ASUS Update utility

The ASUS Update is a utility that allows you to manage, save, and update the motherboard BIOS in Windows® environment. The ASUS Update utility allows you to:

- Save the current BIOS file
- Download the latest BIOS file from the Internet
- Update the BIOS from an updated BIOS file
- Update the BIOS directly from the Internet, and
- View the BIOS version information.

This utility is available in the support DVD that comes with the motherboard package.



ASUS Update requires an Internet connection either through a network or an Internet Service Provider (ISP).

Installing ASUS Update

To install ASUS Update:

1. Place the support DVD in the optical drive. The Drivers menu appears.
2. Click the Utilities tab, then click Install ASUS Update VX.XX.XX. See page 5-3 for the Utilities screen menu.
3. The ASUS Update utility is copied to your system.



Quit all Windows® applications before you update the BIOS using this utility.

Updating the BIOS through the Internet

To update the BIOS through the Internet:

1. Launch the ASUS Update utility from the Windows® desktop by clicking **Start > Programs > ASUS > ASUSUpdate > ASUSUpdate**. The ASUS Update main window appears.

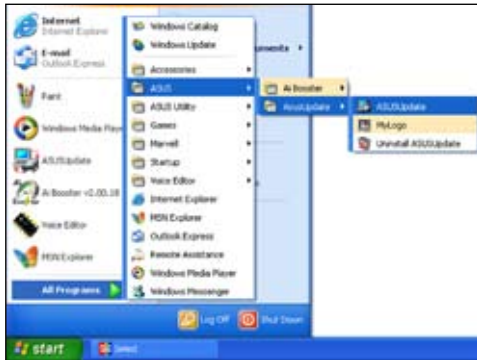

2. Select **Update BIOS** from the Internet option from the drop-down menu, then click **Next**.
3. Select the ASUS FTP site nearest you to avoid network traffic, or click **Auto Select**. Click **Next**.

- From the FTP site, select the BIOS version that you wish to download. Click **Next**.
- Follow the screen instructions to complete the update process.



The ASUS Update utility is capable of updating itself through the Internet. Always update the utility to avail all its features.



Updating the BIOS through a BIOS file

To update the BIOS through a BIOS file:

- Launch the ASUS Update utility from the Windows® desktop by clicking **Start > Programs > ASUS > ASUSUpdate > ASUSUpdate**. The ASUS Update main window appears.
- Select Update BIOS from a file option from the drop-down menu, then click **Next**.



- Locate the BIOS file from the Open window, then click **Open**.
- Follow the screen instructions to complete the update process.

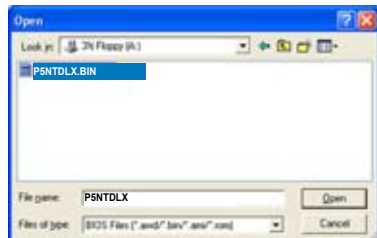

4.1.2 Creating a bootable floppy disk

1. Do either one of the following to create a bootable floppy disk.

DOS environment

- a. Insert a 1.44MB floppy disk into the drive.
- b. At the DOS prompt, type `format A: /s` then press <Enter>.

Windows® XP environment

- a. Insert a 1.44 MB floppy disk to the floppy disk drive.
- b. Click **Start** from the Windows® desktop, then select **My Computer**.
- c. Select the 3 1/2 Floppy Drive icon.
- d. Click File from the menu, then select **Format. A Format 3 1/2 Floppy Disk** window appears.
- e. Select **Create an MS-DOS startup disk** from the format options field, then click **Start**.

4.1.3 ASUS EZ Flash 2 utility

The ASUS EZ Flash 2 feature allows you to update the BIOS without having to go through the long process of booting from a floppy disk and using a DOS-based utility. The EZ Flash 2 utility is built-in the BIOS chip so it is accessible by pressing <Alt> + <F2> during the Power-On Self Tests (POST).

To update the BIOS using EZ Flash 2:

1. Visit the ASUS website (www.asus.com) to download the latest BIOS file for the motherboard.
2. Save the BIOS file to a floppy disk or a USB flash disk, then restart the system.
3. You can launch the EZ Flash 2 by two methods.
 - (1) Insert the floppy disk / USB flash disk that contains the BIOS file to the floppy disk drive or the USB port.

Press <Alt> + <F2> during POST to display the following.

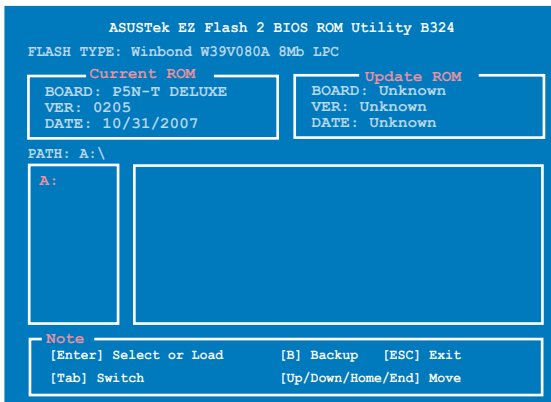

- (2) Enter BIOS setup program. Go to the **Tools** menu to select **EZ Flash 2** and press <Enter> to enable it.
You can switch between drives by pressing <Tab> before the correct file is found. Then press <Enter>.
4. When the correct BIOS file is found, EZ Flash 2 performs the BIOS update process and automatically reboots the system when done.



- This function can support devices such as USB flash disk, or floppy disk with **FAT 32/16** format and single partition only.
- DO NOT shut down or reset the system while updating the BIOS to prevent system boot failure!

4.1.4 Updating the BIOS

The Basic Input/Output System (BIOS) can be updated using the AwardBIOS Flash Utility. Follow these instructions to update the BIOS using this utility.

1. Visit the ASUS website (www.asus.com) and download the latest BIOS file for the motherboard. Save the BIOS file to a bootable floppy disk.



Write the BIOS filename on a piece of paper. You need to type the exact BIOS filename at the DOS prompt.

2. Copy the AwardBIOS Flash Utility (awdf flash.exe) from the Software folder of the support DVD to the floppy disk, DVD ROM or a USB flash disk with the latest BIOS file.
3. Boot the system in DOS mode using the bootable floppy disk, DVD ROM or a USB flash disk you created earlier.
4. Under the DOS mode, use <X:> (X stands for the name of the disk assignment) to switch to the folder of floppy disk, DVD ROM or USB flash disk you saved the BIOS file and AwardBIOS Flash Utility.
5. At the prompt, type awdf flash then press <Enter>. The Award BIOS Flash Utility screen appears.

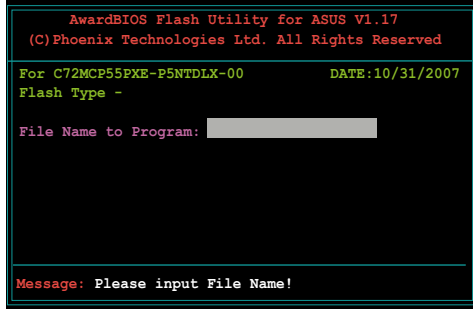

```
AwardBIOS Flash Utility for ASUS V1.17
(C)Phoenix Technologies Ltd. All Rights Reserved

For C72MCP55PXE-P5NTDLX-00          DATE:10/31/2007
Flash Type -

File Name to Program: 

Message: Please input File Name!
```

6. Type the BIOS file name in the File Name to Program field, then press <Enter>.

```
AwardBIOS Flash Utility for ASUS V1.17
(C)Phoenix Technologies Ltd. All Rights Reserved

For C72MCP55PXE-P5NTDLX-00          DATE:10/31/2007
Flash Type -

File Name to Program: P5NTDLX.bin

Message: Do You Want To Save Bios (Y/N)
```

7. Press <N> when the utility prompts you to save the current BIOS file. The following screen appears.
8. The utility verifies the BIOS file in the floppy disk, DVD ROM or a USB flash disk and starts flashing the BIOS file.

```
AwardBIOS Flash Utility for ASUS V1.17
(C)Phoenix Technologies Ltd. All Rights Reserved

For C72MCP55PXE-P5NTDLX-00          DATE:10/31/2007
Flash Type -

File Name to Program: P5NTDLX.bin

Programming Flash Memory - OFE00 OK

Write OK      No Update      Write Fail

Warning: Don't Turn Off Power Or Reset System!
```



Do not turn off or reset the system during the flashing process!

9. The utility displays a Flashing Complete message indicating that you have successfully flashed the BIOS file. Remove the disk then press <F1> to restart the system.

```
AwardBIOS Flash Utility for ASUS V1.17
(C)Phoenix Technologies Ltd. All Rights Reserved

For C72MCP55PXE-P5NTDLX-00          DATE:10/31/2007
Flash Type -

File Name to Program: P5NTDLX.bin
Flashing Complete
Press <F1> to Continue

Write OK      No Update      Write Fail

F1 Reset
```

4.1.5 Saving the current BIOS file

You can use the AwardBIOS Flash Utility to save the current BIOS file. You can load the current BIOS file when the BIOS file gets corrupted during the flashing process.



Make sure that the floppy disk, DVD ROM or a USB flash disk has enough disk space to save the file.

To save the current BIOS file using the AwardBIOS Flash Utility:

1. Follow steps 1 to 6 of the previous section.
2. Press <Y> when the utility prompts you to save the current BIOS file. The following screen appears.

```
AwardBIOS Flash Utility for ASUS V1.17
(C)Phoenix Technologies Ltd. All Rights Reserved

For C72MCP55PXE-P5NTDLX-00      DATE:10/31/2007
Flash Type -

File Name to Program: 0112.bin
Save current BIOS as:

Message:
```

3. Type a filename for the current BIOS file in the Save current BIOS as field, then press <Enter>.

```
AwardBIOS Flash Utility for ASUS V1.17
(C)Phoenix Technologies Ltd. All Rights Reserved

For C72MCP55PXE-P5NTDLX-00      DATE:10/31/2007
Flash Type -

File Name to Program: 0112.bin
Checksum: 810DH
Save current BIOS as: 0113.bin

Message: Please Wait!
```

4. The utility saves the current BIOS file to the floppy disk, then returns to the BIOS flashing process.

```
AwardBIOS Flash Utility for ASUS V1.17
(C)Phoenix Technologies Ltd. All Rights Reserved

For C72MCP55PXE-P5NTDLX-00      DATE:10/31/2007
Flash Type -

File Name to Program: 0113.bin
Now Backup System BIOS to
File!

Message: Please Wait!
```

4.2 BIOS setup program

This motherboard supports a programmable Low-Pin Count (LPC) chip that you can update using the provided utility described in section “4.1 Managing and updating your BIOS.”

Use the BIOS Setup program when you are installing a motherboard, reconfiguring your system, or prompted to “Run Setup.” This section explains how to configure your system using this utility.

Even if you are not prompted to use the Setup program, you can change the configuration of your computer in the future. For example, you can enable the security password feature or change the power management settings. This requires you to reconfigure your system using the BIOS Setup program so that the computer can recognize these changes and record them in the CMOS RAM of the LPC chip.

The LPC chip on the motherboard stores the Setup utility. When you start up the computer, the system provides you with the opportunity to run this program. Press during the Power-On Self-Test (POST) to enter the Setup utility; otherwise, POST continues with its test routines.

If you wish to enter Setup after POST, restart the system by pressing <Ctrl+Alt+Delete>, or by pressing the reset button on the system chassis. You can also restart by turning the system off and then back on. Do this last option only if the first two failed.

The Setup program is designed to make it as easy to use as possible. Being a menu-driven program, it lets you scroll through the various sub-menus and make your selections from the available options using the navigation keys.



-
- The default BIOS settings for this motherboard apply for most conditions to ensure optimum performance. If the system becomes unstable after changing any BIOS settings, load the default settings to ensure system compatibility and stability. Select the **Load Setup Default** item under the Exit Menu. See section **4.9 Exit Menu**.
 - The BIOS setup screens shown in this section are for reference purposes only, and may not exactly match what you see on your screen.
 - Visit the ASUS website (www.asus.com) to download the latest BIOS file for this motherboard.
-

4.2.1 BIOS menu screen

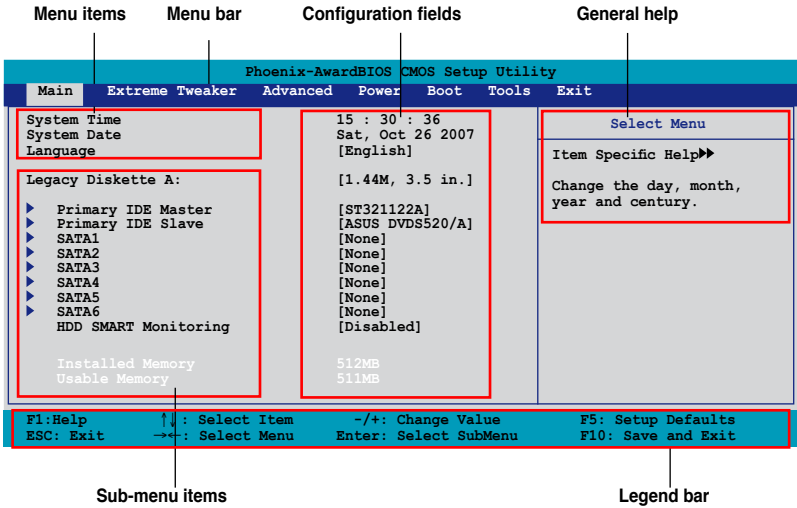

4.2.2 Menu bar

The menu bar on top of the screen has the following main items:

- Main** For changing the basic system configuration
- Extreme Tweaker** For changing the overclocking settings
- Advanced** For changing the advanced system settings
- Power** For changing the advanced power management (APM) configuration
- Boot** For changing the system boot configuration
- Tools** For configuring options for special functions
- Exit** For selecting the exit options and loading default settings

To select an item on the menu bar, press the right or left arrow key on the keyboard until the desired item is highlighted.



- The BIOS setup screens shown in this chapter are for reference purposes only, and may not exactly match what you see on your screen.
- Visit the ASUS website (www.asus.com) to download the latest BIOS information.

4.2.3 Legend bar

At the bottom of the Setup screen is a legend bar. The keys in the legend bar allow you to navigate through the various setup menus. The following table lists the keys found in the legend bar with their corresponding functions.

Navigation Key	Function
<F1>	Displays the General Help screen
<F5>	Loads setup default values
<Esc>	Exits the BIOS setup or returns to the main menu from a sub-menu
Left or Right arrow	Selects the menu item to the left or right
Up or Down arrow	Moves the highlight up or down between fields
Page Down or – (minus)	Scrolls backward through the values for the highlighted field
Page Up or + (plus)	Scrolls forward through the values for the highlighted field
<Enter>	Brings up a selection menu for the highlighted field
<F10>	Saves changes and exit

4.2.4 Menu items

The highlighted item on the menu bar displays the specific items for that menu. For example, selecting **Main** shows the Main menu items.

The other items (Advanced, Power, Boot, and Exit) on the menu bar have their respective menu items.

4.2.5 Sub-menu items

A solid triangle before each item on any menu screen means that the item has a sub-menu. To display the sub-menu, select the item and press <Enter>.

4.2.6 Configuration fields

These fields show the values for the menu items. If an item is user-configurable, you can change the value of the field opposite the item. You cannot select an item that is not user-configurable.

A configurable field is enclosed in brackets, and is highlighted when selected. To change the value of a field, select it then press <Enter> to display a list of options. Refer to “4.2.7 Pop-up window.”

4.2.7 Pop-up window

Select a menu item then press <Enter> to display a pop-up window with the configuration options for that item.

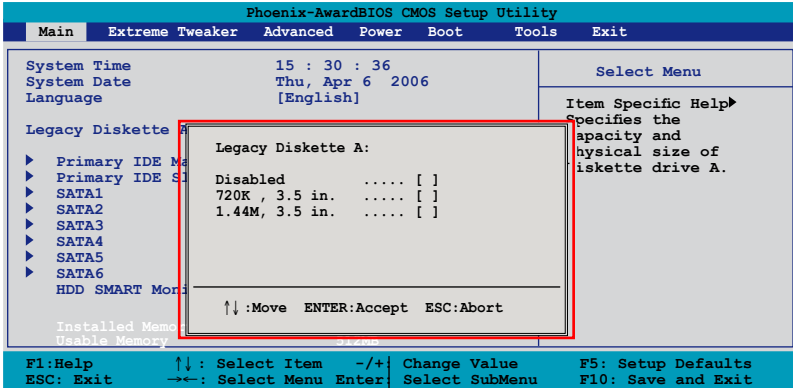

Pop-up menu

4.2.8 General help

At the top right corner of the menu screen is a brief description of the selected item.

4.3 Main menu

When you enter the BIOS Setup program, the Main menu screen appears, giving you an overview of the basic system information.



Refer to section “4.2.1 BIOS menu screen” for information on the menu screen items and how to navigate through them.

Phoenix-AwardBIOS CMOS Setup Utility			
Main	Extreme Tweaker	Advanced Power Boot Tools Exit	
System Time	15 : 30 : 36	Select Menu	
System Date	Sat, Oct 26 2007		
Language	[English]	Item Specific Help▶ Change the day, month, year and century.	
Legacy Diskette A:	[1.44M, 3.5 in.]		
▶ Primary IDE Master	[ST321122A]		
▶ Primary IDE Slave	[ASUS CDS520/A]		
▶ SATA1	[None]		
▶ SATA2	[None]		
▶ SATA3	[None]		
▶ SATA4	[None]		
▶ SATA5	[None]		
▶ SATA6	[None]		
HDD SMART Monitoring	[Disabled]		
Installed Memory	512MB		
Usable Memory	511MB		
F1: Help	↑↓ : Select Item	-/+ : Change Value	F5: Setup Defaults
ESC: Exit	→← : Select Menu	Enter: Select SubMenu	F10: Save and Exit

4.3.1 System Time [xx:xx:xx]

Allows you to set the system time.

4.3.2 System Date [Day xx/xx/xxxx]

Allows you to set the system date.

4.3.3 Language [English]

Allows you to choose the BIOS language version from the options. Configuration options: [English] [French] [Deutsch] [Chinese (Trad.)] [Chinese (Simp.)] [Japanese]

4.3.4 Legacy Diskette A [1.44M, 3.5 in.]

Sets the type of floppy drive installed.

Configuration options: [Disabled] [720K , 3.5 in.] [1.44M, 3.5 in.]

4.3.5 Primary IDE Master/Slave

While entering Setup, the BIOS automatically detects the presence of IDE devices. There is a separate sub-menu for each IDE device. Select a device item then press <Enter> to display the IDE device information.

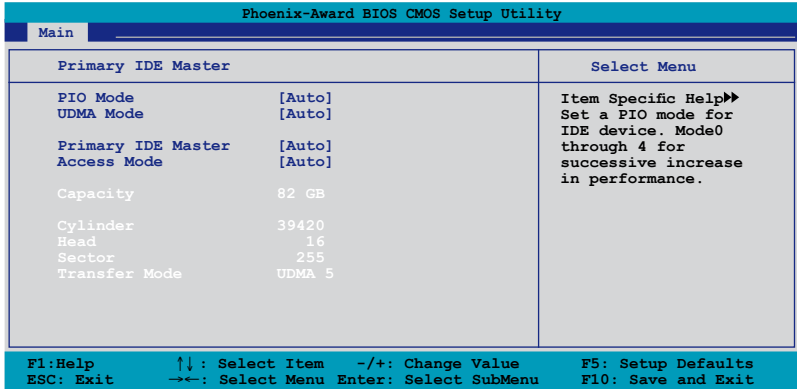

The BIOS automatically detects the values opposite the dimmed items (Capacity, Cylinder, Head, Sector and Transfer Mode). These values are not user-configurable. These items show N/A if no IDE device is installed in the system.

PIO Mode [Auto]

Sets the PIO mode for the IDE device.

Configuration options: [Auto] [Mode 0] [Mode 1] [Mode 2] [Mode 3] [Mode 4]

UDMA Mode [Auto]

Disables or sets the UDMA mode. Configuration options: [Disable] [Auto]

Primary IDE Master/Slave [Auto]

Select [Auto] to automatically detect an IDE hard disk drive. If automatic detection is successful, the BIOS automatically fills in the correct values for the remaining fields on this sub-menu. If the hard disk was already formatted on a previous system, the setup BIOS may detect incorrect parameters. Select [Manual] to manually enter the IDE hard disk drive parameters. If no drive is installed select [None]. Configuration options: [None] [Auto] [Manual]

Access Mode [Auto]

The default [Auto] allows automatic detection of an IDE hard disk drive. Select [CHS] for this item if you set the IDE Primary Master/Slave to [Manual]. Configuration options: [CHS] [LBA] [Large] [Auto]



Before attempting to configure a hard disk drive, make sure you have the correct configuration information supplied by the drive manufacturer. Incorrect settings may cause the system to fail to recognize the installed hard disk.

Capacity

Displays the auto-detected hard disk capacity. This item is not configurable.

Cylinder

Shows the number of the hard disk cylinders. This item is not configurable.

Head

Shows the number of the hard disk read/write heads. This item is not configurable.

Sector

Shows the number of sectors per track. This item is not configurable.

Transfer Mode

Shows the Transfer mode. This item is not configurable.



After entering the IDE hard disk drive information into BIOS, use a disk utility, such as FDISK, to partition and format new IDE hard disk drives. This is necessary so that you can write or read data from the hard disk. Make sure to set the partition of the Primary IDE hard disk drives to active.

4.3.6 SATA1/2/3/4/5/6

While entering Setup, the BIOS automatically detects the presence of Serial ATA devices. There is a separate sub-menu for each SATA device. Select a device item then press <Enter> to display the SATA device information.

Phoenix-Award BIOS CMOS Setup Utility		
Main		
SATA1		Select Menu
Extended IDE Drive	[Auto]	Item Specific Help▶▶ Selects the type of fixed disk connected to the system.
Access Mode	[Auto]	
Capacity	0 MB	
Cylinder	0	
Head	0	
Landing Zone	0	
Sector	0	
F1: Help ↑↓: Select Item -/+ : Change Value F5: Setup Defaults		
ESC: Exit ←→: Select Menu Enter: Select SubMenu F10: Save and Exit		

The BIOS automatically detects the values opposite the dimmed items (Capacity, Cylinder, Head, Landing Zone and Sector). These values are not user-configurable. These items show 0 if no SATA device is installed in the system.

Extended IDE Drive [Auto]

Selects the type of fixed disk connected to the system.

Configuration options: [None] [Auto]

Access Mode [Auto]

Sets the sector addressing mode. Configuration options: [Large] [Auto]



Before attempting to configure a hard disk drive, make sure you have the correct configuration information supplied by the drive manufacturer. Incorrect settings may cause the system to fail to recognize the installed hard disk.

Capacity

Displays the auto-detected hard disk capacity. This item is not configurable.

Cylinder

Shows the number of the hard disk cylinders. This item is not configurable.

Head

Shows the number of the hard disk read/write heads. This item is not configurable.

Landing Zone

Shows the number of landing zone per track. This item is not configurable.

Sector

Shows the number of sectors per track. This item is not configurable.



After entering the IDE hard disk drive information into BIOS, use a disk utility, such as FDISK, to partition and format new IDE hard disk drives. This is necessary so that you can write or read data from the hard disk. Make sure to set the partition of the Primary IDE hard disk drives to active.

4.3.7 HDD SMART Monitoring [Disabled]

Allows you to enable or disable the HDD Self-Monitoring Analysis and Reporting Technology (SMART) feature. Configuration options: [Disabled] [Enabled]

4.3.8 Installed Memory [xxx MB]

Shows the size of installed memory.

4.3.9 Usable Memory [XXX MB]

Shows the size of usable memory.

4.4 Extreme Tweaker menu

The Extreme menu items allow you to configure overclocking-related items.



Take caution when changing the settings of the Extreme menu items. Incorrect field values can cause the system to malfunction.

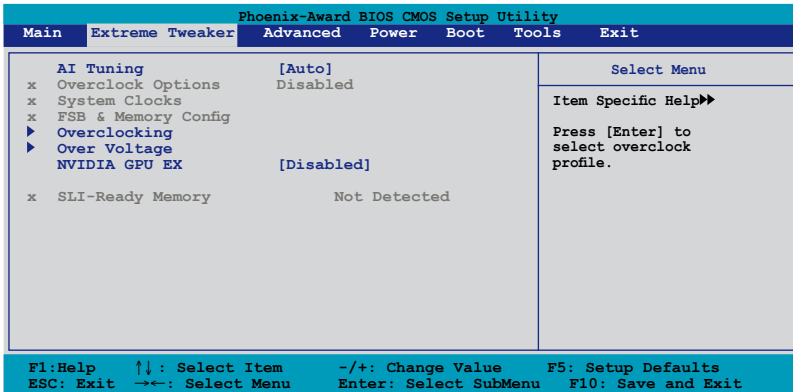

4.4.1 AI Tuning [Auto]

Allows selection of CPU overclocking options to achieve desired CPU internal frequency. Select either one of the preset overclocking configuration options:

Manual Allows you to individually set overclocking parameters.

Auto Loads the optimal settings for the system.

Standard Loads the standard settings for the system.

AI Overclock Loads overclocking profiles with optimal parameters for stability when overclocking.



The following item becomes user-configurable when you set **AI Tuning** to [AI Overclock].

Overclock Options [Disabled]

Allows you to set the overclocking options.

Configuration options: [Disabled] [Overclock 5%] [Overclock 10%] [Overclock 15%] [Overclock 20%]



The following items become user-configurable when you set **AI Tuning** to [Manual].

System Clocks

This sub-menu allows you to adjust the system frequency-related items. Select an item, then press <Enter> to edit.

Phoenix-Award BIOS CMOS Setup Utility	
Extreme Tweaker	
System Clocks	Select Menu
PCIEX16_1 Frequency (MHz) [100]	Item Specific Help▶▶▶
PCIEX16_2 Frequency (MHz) [100]	Set C55 PCIe Overclock
PCIEX16_3 Frequency (MHz) [100]	
SPP<->MCP Ref Clock, MHz [Auto]	

PCIEX16_1 Frequency (MHz) [100]

Allows you to set the PCIEX16_1 overclocking frequency. Key in the desired value using the numeric keypad and press the <Enter> key.

Configuration options: [100 MHz]~[200 MHz]

PCIEX16_2 Frequency (MHz) [100]

Allows you to set the PCIEX16_2 overclocking frequency. Key in the desired value using the numeric keypad and press the <Enter> key.

Configuration options: [100 MHz]~[200 MHz]

PCIEX16_3 Frequency (MHz) [100]

Allows you to set the PCIEX16_3 overclocking frequency. Key in the desired value using the numeric keypad and press the <Enter> key.

Configuration options: [100 MHz]~[200 MHz]

SPP <-> MCP Ref Clock, MHz [Auto]

Configuration options: [Auto] [200.0 MHz] [200.5 MHz] [201.0 MHz] [201.5 MHz]~[499.5MHz] [500.0 MHz]

FSB & Memory Config

This sub-menu allows you to adjust the system frequency-related items. Select an item, then press <Enter> to edit.

Phoenix-Award BIOS CMOS Setup Utility			
Main	Extreme Tweaker	Advanced	Power Boot Tools Exit
FSB - Memory Clock Mode [Linked] FSB - Memory Ratio [Auto] FSB (QDR), MHz [800] Actual FSB (QDR), MHz 800.0 x MEM (DDR), MHz Linked Actual MEM (DDR), MHz 667		Select Menu Item Specific Help▶▶ System clock mode [Auto] Set FSB and memory speed automatically. [Linked] Enter FSB speed manually. Memory Speed changes proportionally. [Unlinked] Enter FSB and memory speed manually.	
F1: Help ↑↓ : Select Item ESC: Exit ←→ : Select Menu		-/+ : Change Value F5: Setup Defaults Enter: Select SubMenu F10: Save and Exit	

FSB - Memory Clock Mode [Auto]

Allows you to set the system clock mode.

Configuration options: [Auto] [Linked] [Unlinked]



The following items become user-configurable when you set the **FSB-Memory Clock Mode** item to [Linked].

FSB - Memory Ratio [Auto]

Configuration options: [Auto] [1:1] [5:4] [3:2] [Sync Mode]

FSB (QDR), MHz [800]

Allows you to set the CPU FSB frequency. Adjust the value using <+> / <-> or the numeric keypad and press <Enter> .

Configuration options: [533 MHz]~[3000 MHz]

Actual FSB (QDR), MHz 800.0

The Actual FSB (QDR) reflects the actual CPU frequency that will take effect on a reboot.



The following item becomes user-configurable when you set the **FSB-Memory Clock Mode** item to [Unlinked].

MEM (DDR), MHz [667]

Allows you to set the Memory frequency. Adjust the value using <+> / <-> or the numeric keypad and press <Enter>.

Configuration options: [400 MHz]~[2600 MHz]

Actual MEM (DDR), MHz 666.7

The Actual MEM (DDR) reflects the actual memory frequency that will take effect on a reboot.

4.4.2 Overclocking

This sub-menu allows you to adjust the system frequency-related items. Select an item, then press <Enter> to edit.

Phoenix-Award BIOS CMOS Setup Utility		
Extreme Tweaker		
Overclocking	Select Menu	
CPU Type	Genuine Intel (R) CPU	Item Specific Help▶▶▶
CPU Speed	2.80GHz	
Cache RAM	1024K x2	
▶ Memory Timing Setting		
▶ Spread Spectrum Control		
Intel SpeedStep	[Disabled]	
CPU Internal Thermal Control	[Disabled]	
Limit CPUID MaxVal	[Disabled]	
EnhancedC1 (C1E)	[Disabled]	
Execute Disable Bit	[Enabled]	
Enhanced Intel SpeedStep(tm) Tech.	[Disabled]	
Hyper-Threading Technology	[Enabled]	
LDT Frequency	[5x]	
F1: Help ↑↓: Select Item -/+ : Change Value F5: Setup Defaults ESC: Exit →←: Select Menu Enter: Select Sub-menu F10: Save and Exit		

Memory Timing Setting

Phoenix-Award BIOS CMOS Setup Utility			
Extreme Tweaker			
Memory Timing Setting	Select Menu		
tCL (CAS Latency)	[Auto]	Item Specific Help▶▶▶ CAS# latency (CAS# to read data valid) Set Memory timings to [Optimal] to use the value recommended by the DIM's manufacturer.	
tRCD	[Auto]		
tRP	[Auto]		
tRAS	[Auto]		
Command Per Clock (CMD)	[Auto]		
** Advanced Memory Settings **			
tRRD	[Auto]		
tRC	[Auto]		
tWR	[Auto]		
tWTR	[Auto]		
tREF	[Auto]		
tRD	[Auto]		
tRFC	[Auto]		
Async Latency	[Auto]		

tCL (CAS Latency) [Auto]

Configuration options: [Auto] [1] [2] [3] [4] [5] [6] [7]

tRCD [Auto]

Configuration options: [Auto] [1] [2] [3] [4] [5] [6] [7]

tRP [Auto]

Configuration options: [Auto] [1] [2] [3] [4] [5] [6] [7]

tRAS [Auto]

Configuration options: [Auto] [1] [2] [3] [4] [5] [6] [7]...[31]

Command Per Clock (CMD) [Auto]

Configuration options: [Auto] [1 clock] [2 clock]

****Advanced Memory Settings****

tRRD [Auto]

Configuration options: [Auto] [1] [2] [3] [4] [5] [6] [7]...[15]

tRC [Auto]

Configuration options: [Auto] [1] [2] [3] [4] [5] [6] [7]...[31]

tWR [Auto]

Configuration options: [Auto] [1] [2] [3] [4] [5] [6] [7]

tWTR [Auto]

Configuration options: [Auto] [1] [2] [3] [4] [5] [6] [7]...[15]

tREF [Auto]

Configuration options: [Auto] [1] [2]

tRD [Auto]

Configuration options: [Auto] [1] [2] [3] [4] [5] [6] [7]...[15]

tRFC [Auto]

Configuration options: [Auto] [1] [2] [3] [4] [5] [6] [7]...[127]

Async Latency [Auto]

Select [Auto] to auto detect the smallest latency to use for the asynchronous logic on memory read.

Configuration options: [Auto] [1.00nS] [1.25nS] [1.50nS] [1.75nS] [2.00nS] [2.25nS] [2.50nS]

Spread Spectrum Control

Phoenix-Award BIOS CMOS Setup Utility		
Extreme Tweaker		
Spread Spectrum Control		Select Menu
CPU Spread Spectrum	[Auto]	Item Specific Help▶▶▶
SATA Spread Spectrum	[Disabled]	
LDT Spread Spectrum	[Auto]	

CPU Spread Spectrum [Auto]

Configuration options: [Disabled] [Auto]

SATA Spread Spectrum [Disabled]

Configuration options: [Disabled] [Auto]

LDT Spread Spectrum [Auto]

Configuration options: [Auto] [Disabled]

CPU Internal Thermal Control [Disabled]

Configuration options: [Auto] [Disabled]

Limit CPUID MaxVal [Disabled]

Configuration options: [Disabled] [Enabled]

Execute Disable Bit [Enabled]

Configuration options: [Disabled] [Enabled]

LDT Frequency [5x]

Configuration options: [1x] [2x] [3x] [4x] [5x] [6x] [7x] [8x]

4.4.3 Over Voltage

This sub-menu allows you to adjust the system voltage-related items. Select an item, then press <Enter> to edit.

Phoenix-Award BIOS CMOS Setup Utility		
Extreme Tweaker		
Over Voltage		Select Menu
VCore Voltage	[Auto]	Item Specific Help▶▶▶ Set CPU VID to desired voltage, but it will cause other CPU power management feature such as C1E, EIST, and TM2) fail to control CPU VID. Select [Auto] to let CPU VID keep original value.
CPU VTT Voltage	[Auto]	
Memory Voltage	[Auto]	
NB BR04 CHIP Voltage	[Auto]	
1.2V HT Voltage	[Auto]	
NB CHIP Voltage	[Auto]	
SB CHIP Voltage	[Auto]	

VCore Voltage [Auto]

Configuration options: [Auto] [1.90000V] [1.89375V] [1.88750V] [1.88125V] [1.87500V]...[0.83750V] [0.83125V]

CPU VTT Voltage [Auto]

Configuration options: [Auto] [1.20V] [1.25V] [1.30V] [1.35V] [1.40V] [1.45V] [1.50V]

Memory Voltage [Auto]

Configuration options: [Auto] [1.850V] [1.870V] [1.890V]...[3.090V] [3.110V]

NB BR04 CHIP Voltage [Auto]

Configuration options: [Auto] [1.20V] [1.25V] [1.30V] [1.35V]

1.2V HT Voltage [Auto]

Configuration options: [Auto] [1.20V] [1.22V] [1.24V]...[1.98V] [2.00V]

NB CHIP Voltage [Auto]

Configuration options: [Auto] [1.20V] [1.22V] [1.24V]...[2.44V] [2.46V]

SB CHIP Voltage [Auto]

Configuration options: [Auto] [1.55V] [1.57V] [1.59V]...[1.83V] [1.85V]

4.4.4 NVIDIA GPU Ex [Disabled]

Enables or disables with the optimized NVIDIA Ex graphics driver.

Configuration options: [Enabled] [Disabled]

4.4.5 SLI-Ready Memory [Disabled]

Allows you to select the SPD profile for SLI-Ready memory modules. The configuration options may vary depending on the type of module you installed.

Configuration options: [Disabled] [Optimal] [High Performance] [High Frequency]



The following item becomes user-configurable when SLI-Ready Memory is set to [Enabled].

4.4.6 SLI-Ready Memory CPUOC [CPUOC 0%]

Configuration options: [CPUOC 0%] [CPUOC 1%]~[CPUOC 14%] [CPUOC MAX]

4.5 Advanced menu

The Advanced menu items allow you to change the settings for system devices.



Take caution when changing the settings of the Advanced menu items. Incorrect field values can cause the system to malfunction.

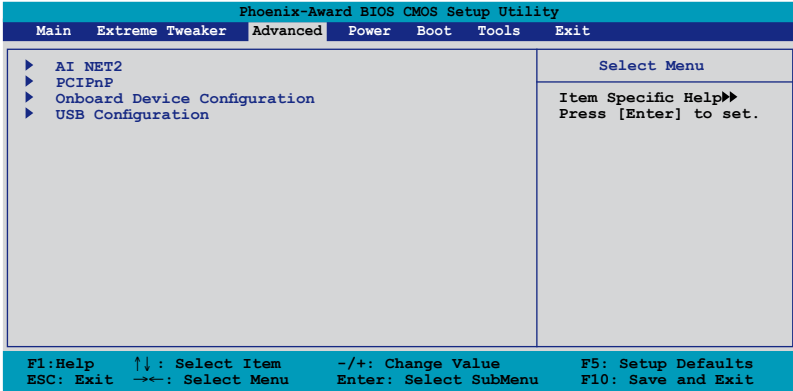

4.5.1 AI NET2

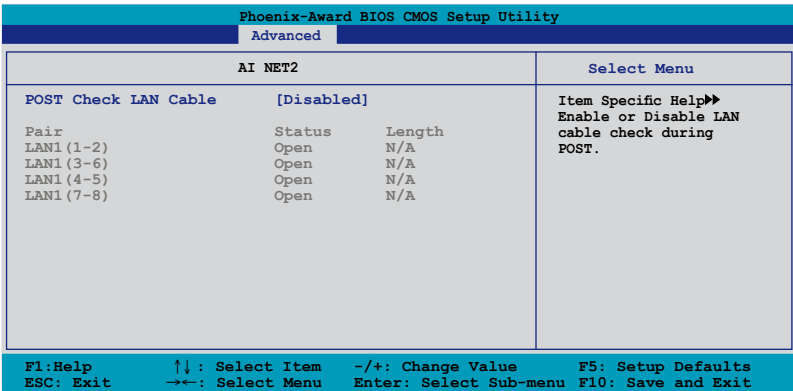

POST Check LAN Cable [Disabled]

Enables or disables checking of the LAN cable during the Power-On Self-Test (POST). Configuration options: [Disabled] [Enabled]

4.5.2 PCIPnP

Phoenix-Award BIOS CMOS Setup Utility	
Advanced	
PCIPnP	Select Menu
Plug & Play O/S [No] Primary Display Adapter [PCI]	Item Specific Help▶▶ Select Yes if you are using a Plug and Play capable operating system. Select No if you need the BIOS to configure non-boot devices.

Plug & Play O/S [No]

When set to [No], the BIOS configures all the devices in the system. When set to [Yes] and if you install a Plug and Play operating system, the operating system configures the Plug and Play devices not required for boot.

Configuration options: [No] [Yes]

Primary Display Adapter [PCI]

Allows you to select the graphics controller to use as the primary boot device.

Configuration options: [PCI] [PCI-E]

4.5.3 Onboard Device Configuration

Phoenix-Award BIOS CMOS Setup Utility	
Advanced	
Onboard Device Configuration	Select Menu
<ul style="list-style-type: none"> ▶ IDE Function Setup ▶ Serial-ATA Configuration HD Audio [Auto] Front Panel Support Type [HD Audio] Onboard nVidia LAN [Enabled] Marvell SATAII Controller [Enabled] Onboard LAN Boot ROM [Disabled] Power Up By PS/2 Mouse [Disabled] Serial Port1 Address [3F8/IRQ4] Onboard 1394 [Enabled] 	Item Specific Help▶▶
F1:Help ↑↓ : Select Item -/+ : Change Value F5: Setup Defaults ESC: Exit →← : Select Menu Enter: Select SubMenu F10: Save and Exit	

IDE Function Setup

This sub-menu contains IDE function-related items. Select an item then press <Enter> to edit.

Phoenix-Award BIOS CMOS Setup Utility	
Advanced	
IDE Function Setup	Select Menu
OnChip IDE Channel0 [Enabled] IDE DMA transfer access [Enabled] IDE Prefetch Mode [Enabled]	Item Specific Help▶▶

OnChip IDE Channel0 [Enabled]

Allows you to enable or disable the onchip IDE channel 0 controller .
 Configuration options: [Disabled] [Enabled]

IDE DMA transfer access [Enabled]

Allows you to enable or disable the IDE DMA transfer access.
 Configuration options: [Disabled] [Enabled]

IDE Prefetch Mode [Enabled]

Allows you to enable or disable the IDE PIO read prefetch mode.
 Configuration options: [Disabled] [Enabled]

Serial-ATA Configuration

This sub-menu allows you to change Serial ATA settings. Select an item then press <Enter> to edit.

Phoenix-Award BIOS CMOS Setup Utility			
Advanced			
Serial-ATA Configuration			Select Menu
Serial-ATA Controller	[Enabled]		Item Specific Help▶▶▶
RAID Enabled	[Disabled]		
x SATA1	RAID	Disabled	
x SATA2	RAID	Disabled	
x SATA3	RAID	Disabled	
x SATA4	RAID	Disabled	
x SATA5	RAID	Disabled	
x SATA6	RAID	Disabled	

Serial-ATA Controller [Enabled]

Allows you to enable or disable the onboard Serial ATA controller.

Configuration options: [Disabled] [Enabled]

RAID Enabled [Disabled]

Enables or disables the onboard RAID controller. When set to [Enabled], the succeeding items become user-configurable.

Configuration options: [Disabled] [Enabled]

SATA1/2/3/4/5/6 RAID [Disabled]

Enables or disables the RAID function of the first to sixth SATA master drive.

Configuration options: [Disabled] [Enabled]

HD Audio [Auto]

Allows you to disable or set the High-Definition audio function.

Configuration options: [Auto] [Disabled]

Front Panel Support Type [HD Audio]

Allows you to set the front panel audio connector (AAFP) mode to legacy AC'97 or high-definition audio depending on the audio standard that the front panel audio module supports. Configuration options: [AC97] [HD Audio]

Onboard nVidia LAN [Enabled]

Enables or disables the onboard NVIDIA® LAN controller.

Configuration options: [Disabled] [Enabled]

Marvell SATAII Controller [Enabled]

Allows you to enable or disable the extended SATAII controller.

Configuration options: [Enabled] [Disabled]

Onboard LAN Boot ROM [Disabled]

Allows you to enable or disable the onboard LAN boot ROM.

Configuration options: [Enabled] [Disabled]

Power Up By PS/2 Mouse [Disabled]

When set to [Enabled], this parameter allows you to use the PS/2 mouse to turn on the system. This feature requires an ATX power supply that provides at least 1A on the +5VSB lead. Configuration options: [Disabled] [Enabled]

Serial Port1 Address [3F8/IRQ4]

Allows you to select the Serial Port1 base address.

Configuration options: [Disabled] [3F8/IRQ4] [2F8/IRQ3] [3E8/IRQ4] [2E8/IRQ3] [Auto]

Onboard 1394 [Enabled]

Allows you to enable or disable the onboard 1394 device support.

Configuration options: [Disabled] [Enabled]

USB Configuration

The items in this menu allows you to change the USB-related features. Select an item then press <Enter> to display the configuration options.

Phoenix-Award BIOS CMOS Setup Utility	
Advanced	
USB Configuration	Select Menu
USB Controller [Enabled]	Item Specific Help▶▶▶
USB Legacy support [Enabled]	Enable or Disable
USB2.0 Controller [Enabled]	USB 1.1 and 2.0 Controller

USB Controller [Enabled]

Allows you to enable or disable the onchip USB controller.

Configuration options: [Disabled] [Enabled]

USB Legacy Support [Enabled]

Allows you to enable or disable support for USB devices on legacy operating systems (OS). Configuration options: [Disabled] [Enabled]

USB 2.0 Controller [Enabled]

Allows you to enable or disable the USB 2.0 controller.

Configuration options: [Disabled] [Enabled]

4.6 Power menu

The Power menu items allow you to change the settings for the Advanced Configuration and Power Interface (ACPI) and the Advanced Power Management (APM). Select an item then press <Enter> to display the configuration options.

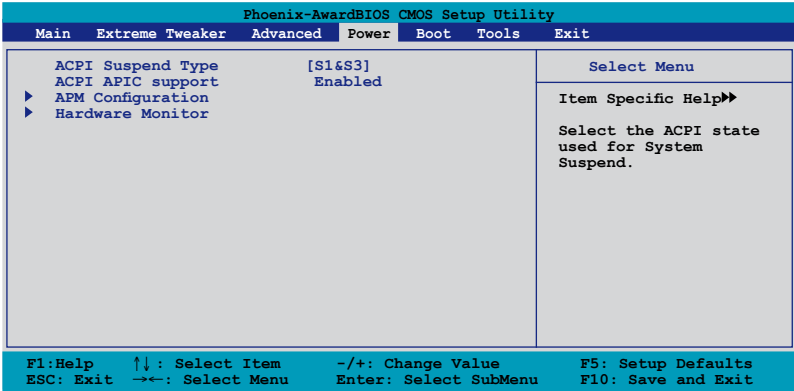

4.6.1 ACPI Suspend Type [S1&S3]

Allows you to select the Advanced Configuration and Power Interface (ACPI) state to be used for system suspend.

Configuration options: [S1 (POS)] [S3(STR)] [S1&S3]

4.6.2 ACPI APIC Support [Enabled]

Allows you to enable or disable the Advanced Configuration and Power Interface (ACPI) support in the Application-Specific Integrated Circuit (ASIC). When set to Enabled, the ACPI APIC table pointer is included in the RSDT pointer list.

Configuration options: [Disabled] [Enabled]

4.6.3 APM Configuration

Phoenix-Award BIOS CMOS Setup Utility		
Power		
APM Configuration		Select Menu
Restore on AC Power Loss	[Power-Off]	Item Specific Help▶▶ Press [Enter] to select whether or not to restart the system after AC power loss
PWR Button < 4 secs	[Instant-Off]	
Power Up On PCI/PCIE Devices	[Disabled]	
Power On By External Modems	[Disabled]	
USB Resume from S5	[Disabled]	
Power On by RTC Alarm	[Disabled]	
x Date (of Month) Alarm	0	
x Alarm Time (hh:mm)	0 : 40 : 0	
HPET Support	[Enabled]	
Power Up By PS/2 Keyboard	[Disabled]	
F1: Help ↑↓ : Select Item -/+ : Change Value F5: Setup Defaults		
ESC: Exit →← : Select Menu Enter: Select SubMenu F10: Save and Exit		

Restore on AC Power Loss [Power-Off]

Allows you to enable or disable the Restore on AC Power Loss function.

Configuration options: [Power-Off] [Power-On] [Last State]

PWR Button < 4 secs [Instant-Off]

When set to [Instant-Off], the system goes into Soft-off mode after you press the power button for less than 4 seconds. When set to [Suspend], the system goes into Suspend mode after you press the power button for less than 4 seconds.

Configuration options: [Suspend] [Instant-Off]

Power Up On PCI/PCIE Devices [Disabled]

Allows you to enable or disable the PME to wake up from S5 by PCI/PCIE devices and the NVIDIA® onboard LAN. Configuration options: [Disabled] [Enabled]

Power On By External Modem [Disabled]

This allows either settings of [Enabled] or [Disabled] for powering up the computer when the external modem receives a call while the computer is in Soft-off mode.

Configuration options: [Disabled] [Enabled]



The computer cannot receive or transmit data until the computer and applications are fully running. Thus, connection cannot be made on the first try. Turning an external modem off and then back on while the computer is off causes an initialization string that turns the system power on.

USB Resume from S5 [Disabled]

Allows you to enable or disable the support of USB keyboard or mouse resumption from S5. Configuration options: [Disabled] [Enabled]

Power On By RTC Alarm [Disabled]

Allows you to enable or disable RTC to generate a wake event. When this item is set to [Enabled], the items **Date (of Month) Alarm** and **Alarm Time (hh:mm)** become user-configurable with set values.

Configuration options: [Disabled] [Enabled]

Date (of Month) Alarm [XX]

To set the date of alarm, highlight this item and press <Enter> to display the Date (of Month) Alarm pop-up menu. Key-in a value within the specified range then press <Enter>. Value '0' means everyday. Configuration options: [Min=0] [Max=31]

Alarm Time (hh:mm) [XX: XX: XX]

To set the time of alarm, highlight this item and press <Enter> to display the Alarm Time pop-up menu. Key-in a value within the specified range then press <Enter>.

Configuration options: [Min=0] [Max=23]---hour

[Min=0] [Max=59]---minute

[Min=0] [Max=59]---second

HPET Support [Enabled]

The hardware high precision efficient timer (HPET) is to increase the performance of the Vista Multimedia player and can meet Vista's requirement. Disable this feature if your system is running under XP environment.

Configuration options: [Disabled] [Enabled]

Power Up By PS/2 Keyboard [Disabled]

Allows you to disable the Power On by PS/2 keyboard function or set specific keys on the PS/2 keyboard to turn on the system. This feature requires an ATX power supply that provides at least 1A on the +5VSB lead.

Configuration options: [Disabled] [Space Bar] [Ctrl-ESC] [Power Key]

4.6.4 Hardware Monitor

The items in this sub-menu displays the hardware monitor values automatically detected by the BIOS. It also allows you to change CPU Q-Fan feature-related parameters. Select an item then press <Enter> to display the configuration options.

Phoenix-Award BIOS CMOS Setup Utility		
Power		
Hardware Monitor		Select Menu
x CPU Q-Fan Control	[Disabled]	Item Specific Help▶ Press [Enter] to enable or disable
x CPU Q-Fan Profile	[Silent]	
x Chassis Q-Fan Control	[Disabled]	
x Chassis Q-Fan Profile	Performance	
Vcore Voltage	[1.34V]	
3.3V Voltage	[3.20V]	
5V Voltage	[4.83V]	
12V Voltage	[11.52V]	
CPU Temperature	48°C	
M/B Temperature	36°C	
CPU Fan Speed	2667 RPM	
CHA_FAN1 Speed	0 RPM	
CHA_FAN2 Speed	0 RPM	
PWR_FAN Speed	0 RPM	
CPU Fan Speed Warning	[600 RPM]	
F1: Help	↑↓: Select Item	-/+ : Change Value
ESC: Exit	→←: Select Menu	Enter: Select SubMenu
		F5: Setup Defaults
		F10: Save and Exit

CPU Q-Fan Control [Enabled]

Allows you to enable or disable the CPU Q-Fan controller.

Configuration options: [Disabled] [Enabled]

The **CPU Fan Profile** item becomes user-configurable when you enable the CPU Q-Fan Control feature.

CPU Q-Fan Profile [Optimal]

Allows you to set the appropriate performance level of the CPU Q-Fan. When set to [Optimal], the CPU fan automatically adjusts depending on the CPU temperature. Set this item to [Silent Mode] to minimize fan speed for quiet CPU fan operation, or [Performance Mode] to achieve maximum CPU fan speed.

Configuration options: [Performance] [Optimal] [Silent]

Chassis Q-Fan Control [Enabled]

Allows you to enable or disable the Chassis Q-fan.

Configuration options: [Disabled] [Enabled]

The **Chassis Q-Fan Profile** item becomes user-configurable when you enable the Chassis Q-Fan Control feature.

Chassis Q-Fan Profile [Auto]

Allows you to set the appropriate performance level of the Chassis Q-Fan.

Configuration options: [Performance] [Optimal] [Silent]

Vcore Voltage, 3.3V Voltage, 5V Voltage, 12V Voltage

The onboard hardware monitor automatically detects the voltage output through the onboard voltage regulators. Select [Ignored] if you do not want to detect this item.

CPU Temperature [xxx°C/xxx°F]

M/B Temperature [xxx°C/xxx°F]

The onboard hardware monitor automatically detects and displays the motherboard and CPU temperatures. Select [Ignored] if you do not wish to display the detected temperatures.

CPU Fan Speed [xxxxRPM]

CHA_FAN 1/2 Speed [xxxxRPM]

PWR_FAN Speed [xxxxRPM]

The onboard hardware monitor automatically detects and displays the CPU/ Chassis/Power fan speed in rotations per minute (RPM). If the fan is not connected to the motherboard, the field shows 0 RPM.

CPU Fan Speed warning [600 RPM]

Allows you to set the CPU fan warning speed function, which gives off a warning when the CPU fan speed is too low. If you set this item to [Disabled], the system will not warn you even if no fan is installed or if the fan is not functioning properly. Configuration options: [Disabled] [600 RPM] [1200 RPM] [1600 RPM]

4.7 Boot menu

The Boot menu items allow you to change the system boot options. Select an item then press <Enter> to display the sub-menu.

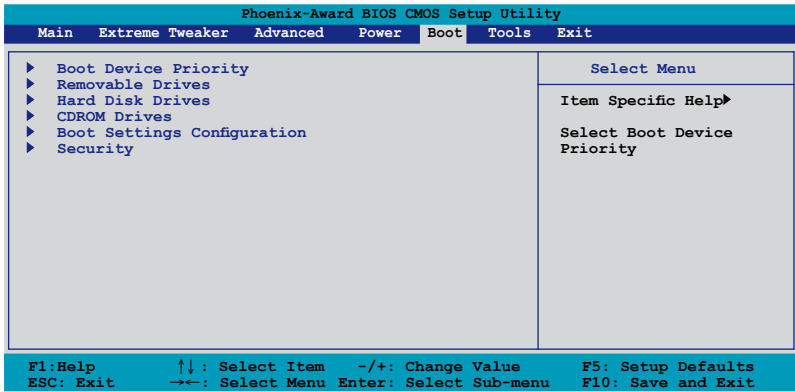

4.7.1 Boot Device Priority

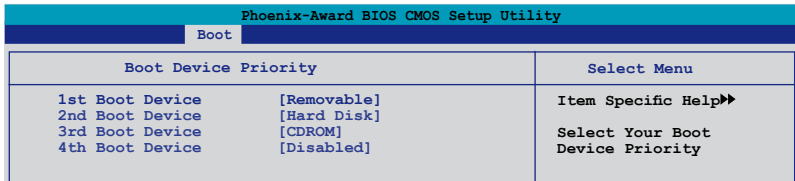

1st ~ 4th Boot Device [Removable]

These items specify the boot device priority sequence from the available devices. The number of device items that appears on the screen depends on the number of devices installed in the system.

Configuration options: [Removable] [Hard Disk] [CDROM] [Disabled]

4.7.2 Removable Drives

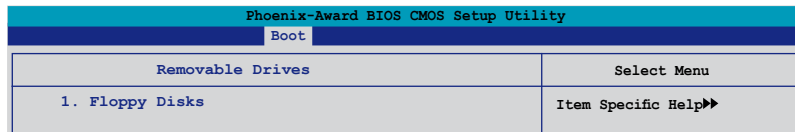

1. Floppy Disks

Allows you to assign a removable drive attached to the system.

4.7.3 Hard Disk Drives

Phoenix-Award BIOS CMOS Setup Utility	
Boot	
Hard Disk Drives	Select Menu
1. SATA X: XXXXXXXXXX	Item Specific Help▶▶

1. SATA X: XXXXXXXXXX

Allows you to assign hard disk drives attached to the system.

4.7.4 CDROM Drives

Phoenix-Award BIOS CMOS Setup Utility	
Boot	
CDROM Drives	Select Menu
1. 1st Slave: XXXXXXXXXX	Item Specific Help▶▶

1. 1st Slave: XXXXXXXXXX

Allows you to assign optical drives attached to the system.

4.7.5 Boot Settings Configuration

Phoenix-AwardBIOS CMOS Setup Utility	
Boot	
Boot Settings Configuration	Select Menu
Case Open Warning [Enabled]	Item Specific Help▶▶
Quick Boot [Enabled]	Press [Enter] to enable or disable.
Boot Up Floppy Seek [Disabled]	
Bootup Num-Lock [On]	
Typematic Rate Setting [Disabled]	
x Typematic Rate (Chars/Sec) 6	
x Typematic Delay (Msec) 250	
OS Select For DRAM > 64MB [Non-OS2]	
Full Screen LOGO [Enabled]	
Halt On [All Errors]	

F1: Help ↑↓: Select Item -/+ : Change Value F5: Setup Defaults
ESC: Exit →←: Select Menu Enter: Select Sub-menu F10: Save and Exit

Case Open Warning [Enabled]

Enables or disables the chassis open status feature. Setting to Enabled, clears the chassis open status. Refer to section “2.7.2 Internal connectors” for setting details. Configuration options: [Disabled] [Enabled]

Quick Boot [Enabled]

Allows you to enable or disable the system quick boot feature. When Enabled, the system skips certain tests while booting. Configuration options: [Disabled] [Enabled]

Boot Up Floppy Seek [Disabled]

Enables or disables the chassis open status feature. Setting to Enabled, clears the chassis open status. Configuration options: [Disabled] [Enabled]

Bootup Num-Lock [On]

Allows you to select the power-on state for the NumLock. Configuration options: [Off] [On]

Typematic Rate Setting [Disabled]

Allows you to set the keystroke rate. Enable this item to configure the Typematic Rate (Chars/Sec) and the Typematic Delay (Msec). Configuration options: [Disabled] [Enabled]



The items **Typematic Rate (Chars/Sec)** and **Typematic Delay (Msec)** become user-configurable only when the item **Typematic Rate Setting** is enabled.

Typematic Rate (Chars/Sec) [6]

Allows you to select the rate at which a character repeats when you hold a key. Configuration options: [6] [8] [10] [12] [15] [20] [24] [30]

Typematic Delay (Msec) [250]

Allows you to set the delay before keystrokes begin to repeat.
Configuration options: [250] [500] [750] [1000]

OS Select for DRAM > 64MB [Non-OS2]

Set this item to OS2 only when you are running on an OS/2 operating system with an installed RAM of greater than 64 MB. Configuration options: [Non-OS2] [OS2]

Full Screen LOGO [Enabled]

Allows you to enable or disable the full screen logo display feature.
Configuration options: [Disabled] [Enabled]



Make sure that the above item is set to [Enabled] if you want to use the ASUS MyLogo3™ feature.

Halt On [All Errors]

Allows you to set the error report type.
Configuration options: [All Errors] [No Errors] [All, But Keyboard] [All, But Diskette] [All, But Disk/Key]

4.7.6 Security

Phoenix-Award BIOS CMOS Setup Utility		
Boot		
Security		Select Menu
Supervisor Password	Clear	Item Specific Help▶▶
User Password	Clear	
Password Check	[Setup]	

Supervisor Password

User Password

These fields allow you to set passwords:

To set a password:

1. Select an item then press <Enter>.
2. Type in a password using a combination of a maximum of eight (8) alpha-numeric characters, then press <Enter>.
3. When prompted, confirm the password by typing the exact characters again, then press <Enter>. The password field setting is changed to Set.

To clear the password:

1. Select the password field and press <Enter> twice. The following message appears:



2. Press any key to continue. The password field setting is changed to Clear.

A note about passwords

The Supervisor password is required to enter the BIOS Setup program preventing unauthorized access. The User password is required to boot the system preventing unauthorized use.

Forgot your password?

If you forget your password, you can clear it by erasing the CMOS Real Time Clock (RTC) RAM. The RAM data containing the password information is powered by the onboard button cell battery. If you need to erase the CMOS RAM, refer to section "2.6 Jumper" for instructions.

Password Check

This field requires you to enter the password before entering the BIOS setup or the system. Select [Setup] to require the password before entering the BIOS Setup. Select [System] to require the password before entering the system.
Configuration options: [Setup] [System]

4.8 Tools menu

The Tools menu items allow you to configure options for special functions. Select an item then press <Enter> to display the sub-menu.

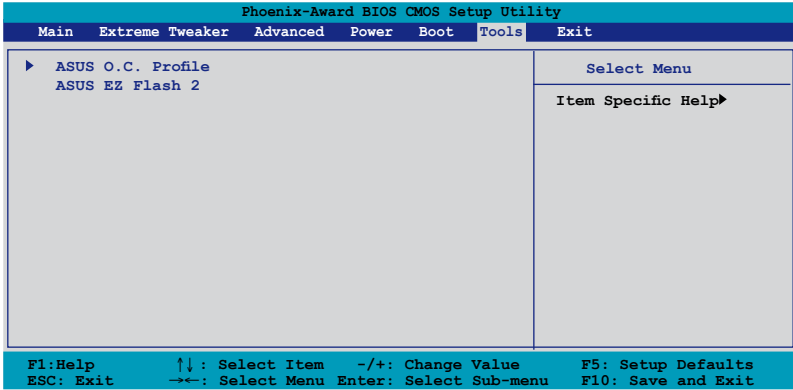

4.8.1 ASUS O.C. Profile

This item allows you to store or load multiple BIOS settings.

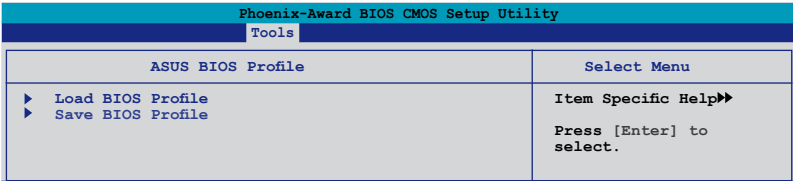

Load BIOS Profile

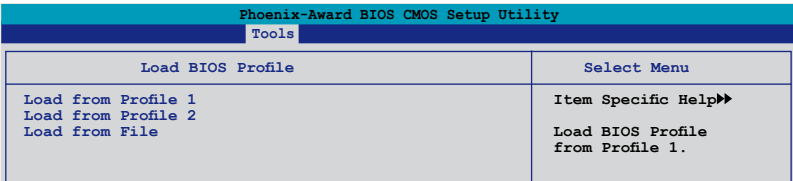

Load from Profile 1/2

Allows you to load the previous BIOS settings saved in the BIOS Flash. Press <Enter> to load the file.

Load from File

Allows you to load the previous BIOS file saved in the hard disk/floppy disk/USB flash disk with the FAT32/16/12 format. Follow the instructions below to load the BIOS file.

1. Insert the storage devices that contains the “xxx.CMO” file.
2. Turn on the system.
3. Enter BIOS setup program. Go to the “Tools” menu to select **ASUS O.C. Profile > Load from File**. Press <Enter> then the setup screen will appear.
4. Press <Tab> to switch between drives before the correct “xxx.CMO” file is found. Then press <Enter> to load the file.
5. A pop-up message will inform you when the loading process finishes.



- Suggest only to update the BIOS file coming from the same memory/CPU configuration and BIOS version.
- Only the “xxx.CMO” file can be loaded.

Save BIOS Profile

Phoenix-Award BIOS CMOS Setup Utility	
Tools	
Save BIOS Profile	Select Menu
Save to Profile 1 Save to Profile 2 Save to File	Item Specific Help▶▶ Save current BIOS Profile to Profile 1.

Save to Profile 1/2

Allows you to save the current BIOS file to the BIOS Flash. Press <Enter> to save the file.

Save to File

Allows you to save the current BIOS file to the hard disk/floppy disk/USB flash disk with FAT32/16/12 format. Follow the instructions below to save the BIOS file.

1. Insert the storage devices with enough space.
2. Turn on the system.
3. Enter the BIOS setup program. Go to the “Tools” menu to select “Save to File.” Press <Enter> then the setup screen will appear.
4. Press <Tab> to switch between the drives. Press hot-key <S> to save the file.
5. Key in the file name. Then press <Enter>.
6. A pop-up message will inform you when the saving process finishes.

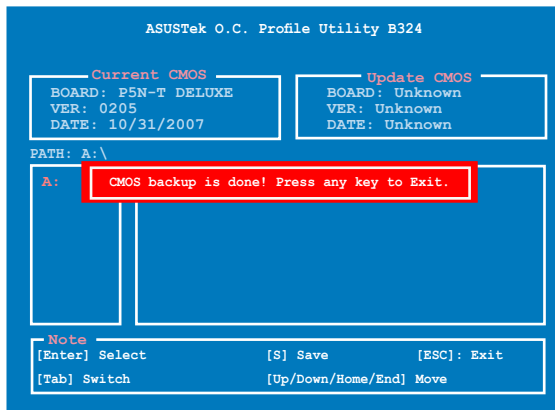

The BIOS file will be saved as "xxx.CMO".

4.8.2 ASUS EZ Flash 2

Allows you to run ASUS EZ Flash 2. When you press <Enter>, a confirmation message appears. Use the left/right arrow key to select between [Yes] or [No], then press <Enter> to confirm your choice.

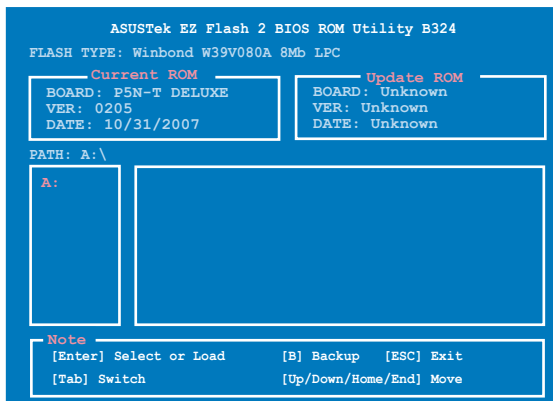

4.9 Exit menu

The Exit menu items allow you to load the optimal or failsafe default values for the BIOS items, and save or discard your changes to the BIOS items.

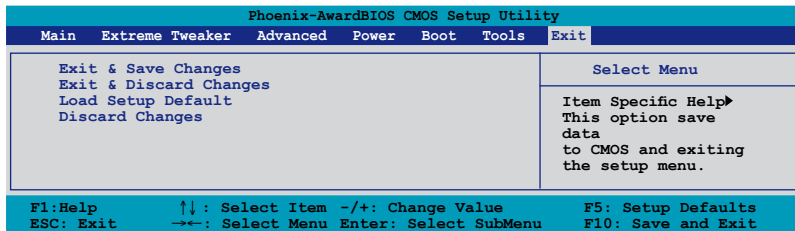

Pressing <Esc> does not immediately exit this menu. Select one of the options from this menu or <F10> from the legend bar to exit.

Exit & Save Changes

Once you are finished making your selections, choose this option from the Exit menu to ensure the values you selected are saved to the CMOS RAM. An onboard backup battery sustains the CMOS RAM so it stays on even when the PC is turned off. When you select this option, a confirmation window appears. Select YES to save changes and exit.



If you attempt to exit the Setup program without saving your changes, the program prompts you with a message asking if you want to save your changes before exiting. Press <Enter> to save the changes while exiting.

Exit & Discard Changes

Select this option only if you do not want to save the changes that you made to the Setup program. If you made changes to fields other than System Date, System Time, and Password, the BIOS asks for a confirmation before exiting.

Load Setup Default

This option allows you to load the default values for each of the parameters on the Setup menus. When you select this option or if you press <F5>, a confirmation window appears. Select YES to load default values. Select Exit & Save Changes or make other changes before saving the values to the non-volatile RAM.

Discard Changes

This option allows you to discard the selections you made and restore the previously saved values. After selecting this option, a confirmation appears. Select YES to discard any changes and load the previously saved values.

This chapter describes the contents of the support DVD that comes with the motherboard package and the softwares.

5 Software support

5.1	Installing an operating system	5-1
5.2	Support DVD information	5-1
5.3	Software information	5-9
5.4	RAID configurations	5-35
5.5	Creating a RAID driver disk.....	5-43

5.1 Installing an operating system

This motherboard supports Windows® XP/ Vista operating systems (OS). Always install the latest OS version and corresponding updates to maximize the features of your hardware.



- Motherboard settings and hardware options vary. Use the setup procedures presented in this chapter for reference only. Refer to your OS documentation for detailed information.
- Make sure that you install the Windows® XP Service Pack 2 or later versions before installing the drivers for better compatibility and system stability.

5.2 Support DVD information

The support DVD that came with the motherboard package contains the drivers, software applications, and utilities that you can install to avail all motherboard features.



The contents of the support DVD are subject to change at any time without notice. Visit the ASUS website(www.asus.com) for updates.

5.2.1 Running the support DVD

Place the support DVD to the optical drive. The DVD automatically displays the Drivers menu if Autorun is enabled in your computer.



Click an icon to display support DVD/ motherboard information

Click an item to install



If Autorun is NOT enabled in your computer, browse the contents of the support DVD to locate the file ASSETUP.EXE from the BIN folder. Double-click the ASSETUP.EXE to run the DVD.

5.2.2 Drivers menu

The Drivers menu shows the available device drivers if the system detects installed devices. Install the necessary drivers to activate the devices.



ASUS InstAll-Drivers Installation Wizard

Installs all of the drivers through the Installation Wizard.

NVIDIA Chipset Driver Program

Installs the NVIDIA® chipset driver program.

SoundMAX ADI Audio Driver

Installs the SoundMAX® ADI1988B audio driver and application.

Marvell61xx SATA RAID Controller

Installs the Marvell SATA RAID driver.

USB 2.0 Driver

Installs the USB 2.0 driver.

5.2.3 Utilities menu

The Utilities menu shows the applications and other software that the motherboard supports.



Click to display the next page



Click to return to the previous page

ASUS InstAll-Installation Wizard for Utilities

Installs all of the utilities through the Installation Wizard.

ASUS PC Probe II

This smart utility monitors the fan speed, CPU temperature, and system voltages, and alerts you of any detected problems. This utility helps you keep your computer in healthy operating condition.

ASUS Update

The ASUS Update utility allows you to update the motherboard BIOS in Windows® environment. This utility requires an Internet connection either through a network or an Internet Service Provider (ISP).

ASUS AI Suite

Installs the ASUS AI Suite.

ASUS AI Direct Link

Installs the ASUS AI Direct Link application

Adobe Acrobat Reader V7.0

Installs the Adobe® Acrobat® Reader that allows you to open, view, and print documents in Portable Document Format (PDF).

Microsoft DirectX 9.0c

Installs the Microsoft® DirectX 9.0c driver. The Microsoft DirectX® 9.0c is a multimedia technology that enhances computer graphics and sound. DirectX® improves the multimedia features of your computer so you can enjoy watching TV and movies, capturing videos, or playing games in your computer. Visit the Microsoft website (www.microsoft.com) for updates.

Anti-Virus Utility

The anti-virus application scans, identifies, and removes computer viruses. View the online help for detailed information.

InterVideo MediaOne Gallery

Installs the media library and all-in-one software.

WinDVD Copy5 Trial

Installs the WinDVD Copy5 trial version.

Ulead PhotoImpact 12 SE

Installs the PhotoImpact image editing software.

CyberLink PowerBackup

Installs CyberLink PowerBackup to back up and restore your data easily.

Corel Snapfire Plus SE

Installs Corel Snapfire Plus SE.

5.2.4 Make disk menu

The Make disk menu contains items to create the NVIDIA® or Marvell® SATA/RAID driver disk.



Marvell61xx 32/64bit Driver

Allows you to create a Marvell61xx 32/64bit driver disk.

NVIDIA 32/64bit XP SATA RAID Driver

Allows you to create a NVIDIA® Windows® XP 32/64bit RAID driver.

NVIDIA 32/64bit Vista SATA RAID Driver

Allows you to create a NVIDIA® Windows® Vista 32/64bit RAID driver.

5.2.5 Manual menu

The Manual menu contains a list of supplementary user manuals. Click an item to open the folder of the user manual.



Most user manual files are in Portable Document Format (PDF). Install the Adobe® Acrobat® Reader from the Utilities menu before opening a user manual file.



5.2.6 ASUS Contact information

Click the Contact tab to display the ASUS contact information. You can also find this information on the inside front cover of this user guide.

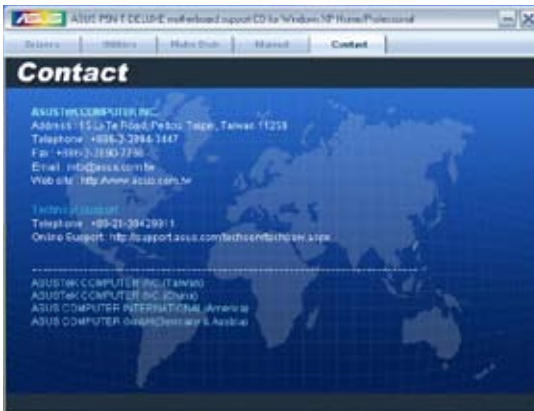

5.2.7 Other information

The icons on the top right corner of the screen give additional information on the motherboard and the contents of the support DVD. Click an icon to display the specified information.

Motherboard Info

Displays the general specifications of the motherboard.



Browse this DVD

Displays the support DVD contents in graphical format.

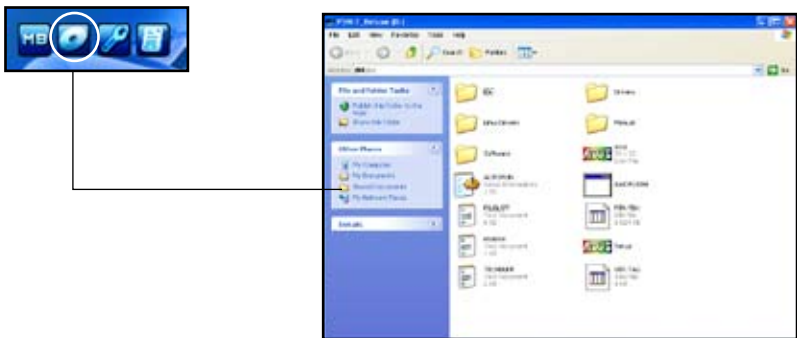

Technical support Form

Displays the ASUS Technical Support Request Form that you have to fill out when requesting technical support.



Filelist

Displays the contents of the support DVD in text format.



5.3 Software information

Most of the applications in the support DVD have wizards that will conveniently guide you through the installation. View the online help or readme file that came with the software application for more information.

5.3.1 ASUS MyLogo3™

The ASUS MyLogo3™ utility lets you customize the boot logo. The boot logo is the image that appears on screen during the Power-On-Self-Tests (POST). The ASUS MyLogo3™ is automatically installed when you install the ASUS Update utility from the support DVD. See section 5.2.3 **Utilities menu** for details.



- Before using the ASUS MyLogo3™, use the Award BIOS Flash utility to make a copy of your original BIOS file, or obtain the latest BIOS version from the ASUS website. See section 4.1.4 **Updating the BIOS**.
- Make sure that the BIOS item Full Screen Logo is set to [Enabled] if you wish to use ASUS MyLogo3. See section 4.7.5 **Boot Settings Configuration**.
- You can create your own boot logo image in GIF, JPG, or BMP file formats.

To launch the ASUS MyLogo3™:

1. Launch the ASUS Update utility. Refer to section 4.1.1 **ASUS Update utility** for details.
2. Select **Options** from the drop down menu, then click **Next**.
3. Check the option **Launch MyLogo** to replace system boot logo before flashing BIOS, then click **Next**.
4. Select **Update BIOS from a file** from the drop down menu, then click **Next**.
5. When prompted, locate the new BIOS file, then click **Next**. The ASUS MyLogo3 window appears.
6. From the left window pane, select the folder that contains the image you intend to use as your boot logo.



- 7. When the logo images appear on the right window pane, select an image to enlarge by clicking on it.

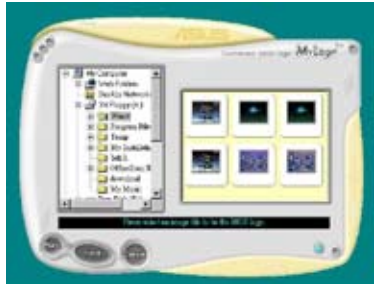

- 8. Adjust the boot image to your desired size by selecting a value on the Ratio box.



- 9. When the screen returns to the ASUS Update utility, flash the original BIOS to load the new boot logo.
- 10. After flashing the BIOS, restart the computer to display the new boot logo during POST.

5.3.2 AI NET2

The AI NET2 features the Marvell® Virtual Cable Tester™ (VCT). VCT is a cable diagnostic utility that reports LAN cable faults and shorts using the Time Domain Reflectometry (TDR) technology. The VCT detects and reports open and shorted cables, impedance mismatches, pair swaps, pair polarity problems, and pair skew problems of up to 64 ns at one meter accuracy.

The VCT feature reduces networking and support costs through a highly manageable and controlled network system. This utility can be incorporated in the network systems software for ideal field support as well as development diagnostics.

Using the Virtual Cable Tester™

To use the the Marvell® Virtual Cable Tester™ utility:

1. Launch the VCT utility from the Windows® desktop by clicking **Start > All Programs > Marvell > Virtual Cable Tester**.
2. Click **Virtual Cable Tester** from the menu to display the screen below.

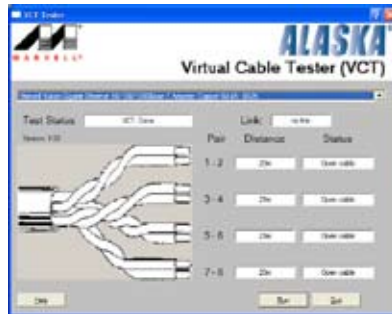

3. Click the **Run** button to perform a cable test.



- The VCT utility only tests Ethernet cables connected to Gigabit LAN port(s).
- The Run button on the Virtual Cable Tester™ main window is disabled if no problem is detected on the LAN cable(s) connected to the LAN port(s).
- If you want the system to check the status of the LAN cable before entering the OS, enable the item Post Check LAN Cable in the BIOS Setup.

5.3.3 ASUS PC Probe II

PC Probe II is a utility that monitors the computer's vital components, and detects and alerts you of any problem with these components. PC Probe II senses fan rotations, CPU temperature, and system voltages, among others. Because PC Probe II is software-based, you can start monitoring your computer the moment you turn it on. With this utility, you are assured that your computer is always at a healthy operating condition.

Installing PC Probe II

To install PC Probe II on your computer:

1. Place the support DVD to the optical drive. The Drivers installation tab appears if your computer has an enabled Autorun feature.



If Autorun is not enabled in your computer, browse the contents of the support DVD to locate the setup.exe file from the ASUS PC Probe II folder. Double-click the setup.exe file to start installation.

2. Click the Utilities tab, then click ASUS PC Probe II.
3. Follow the screen instructions to complete installation.

Launching PC Probe II

You can launch the PC Probe II right after installation or anytime from the Windows® desktop.

To launch the PC Probe II from the Windows® desktop, click **Start > All Programs > ASUS > PC Probe II > PC Probe II v1.xx.xx**. The PC Probe II main window appears.

After launching the application, the PC Probe II icon appears in the Windows® taskbar. Click this icon to close or restore the application.









Using PC Probe II

Main window

The PC Probe II main window allows you to view the current status of your system and change the utility configuration. By default, the main window displays the Preference section. You can close or restore the Preference section by clicking on the triangle on the main window right handle.



Click to close the Preference panel

Button	Function
	Opens the Configuration window
	Opens the Report window
	Opens the Desktop Management Interface window
	Opens the Peripheral Component Interconnect window
	Opens the Windows Management Instrumentation window
	Opens the hard disk drive, memory, CPU usage window
	Shows/Hides the Preference section
	Minimizes the application
	Closes the application

Sensor alert

When a system sensor detects a problem, the main window right handle turns red, as the illustrations below show.



When displayed, the monitor panel for that sensor also turns red. Refer to the Monitor panels section for details.

Preferences

You can customize the application using the Preference section in the main window. Click the box before each preference to activate or deactivate.

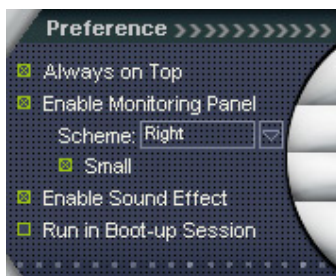

Hardware monitor panels

The hardware monitor panels display the current value of a system sensor such as fan rotation, CPU temperature, and voltages.

The hardware monitor panels come in two display modes: hexagonal (large) and rectangular (small). When you check the Enable Monitoring Panel option from the Preference section, the monitor panels appear on your computer's desktop.



Large display



Small display

Changing the monitor panels position

To change the position of the monitor panels in the desktop, click the arrow down button of the Scheme options, then select another position from the list box. Click OK when finished.



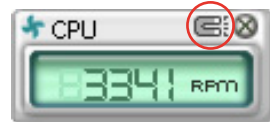

Moving the monitor panels

All monitor panels move together using a magnetic effect. If you want to detach a monitor panel from the group, click the horseshoe magnet icon. You can now move or reposition the panel independently.



Adjusting the sensor threshold value

You can adjust the sensor threshold value in the monitor panel by clicking the  or  buttons. You can also adjust the threshold values using the Config window.

You cannot adjust the sensor threshold values in a small monitoring panel.

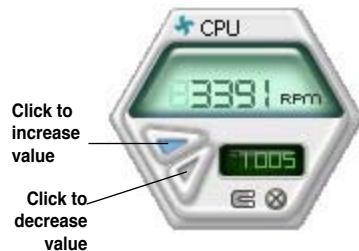

Monitoring sensor alert

The monitor panel turns red when a component value exceeds or is lower than the threshold value. Refer to the illustrations below.



Large display



Small display

WMI browser

Click **WMI** to display the WMI (Windows Management Instrumentation) browser. This browser displays various Windows® management information. Click an item from the left panel to display on the right panel. Click the plus sign (+) before WMI Information to display the available information.



You can enlarge or reduce the browser size by dragging the bottom right corner of the browser.

DMI browser

Click **DMI** to display the DMI (Desktop Management Interface) browser. This browser displays various desktop and system information. Click the plus sign (+) before DMI Information to display the available information.



PCI browser

Click **PCI** to display the PCI (Peripheral Component Interconnect) browser. This browser provides information on the PCI devices installed on your system. Click the plus sign (+) before the PCI Information item to display available information.

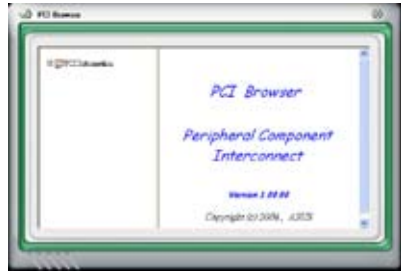

Usage

The Usage browser displays real-time information on the CPU, hard disk drive space, and memory usage. Click **USAGE** to display the Usage browser.

CPU usage

The CPU tab displays real-time CPU usage in line graph representation. If the CPU has an enabled Hyper-Threading, two separate line graphs display the operation of the two logical processors.



Hard disk drive space usage

The Hard Disk tab displays the used and available hard disk drive space. The left panel of the tab lists all logical drives. Click a hard disk drive to display the information on the right panel. The pie chart at the bottom of the window represents the used (blue) and the available HDD space.



Memory usage

The Memory tab shows both used and available physical memory. The pie chart at the bottom of the window represents the used (blue) and the available physical memory.



Configuring PC Probe II

Click **CONFIG** to view and adjust the sensor threshold values.

The Config window has two tabs: Sensor/Threshold and Preference. The Sensor/Threshold tab enables you to activate the sensors or to adjust the sensor threshold values. The Preference tab allows you to customize sensor alerts, or change the temperature scale.

The screenshot shows the 'Config' window with the 'Sensor/Threshold' tab selected. It features a table for sensor settings and a set of control buttons at the bottom.

Enabled	Sensor Name	Nominal Value	Current Value	Threshold
<input checked="" type="checkbox"/>	CPU		43	80 °C
<input checked="" type="checkbox"/>	MB		34	45 °C

Buttons at the bottom: Default, Apply, Cancel, Save As, Load.

Annotations:

- Default: Loads the default threshold values for each sensor
- Apply: Applies your changes
- Cancel: Cancels or ignores your changes
- Save As: Saves your configuration
- Load: Loads your saved configuration

5.3.4 ASUS AI Suite

ASUS AI Suite allows you to launch AI Gear 3, AI N.O.S., AI Booster, AI Nap, and Q-Fan 2 utilities easily.



Install the **ASUS EPU + AI Gear 3 Driver** before the ASUS AI Suite utility. Otherwise, the ASUS AI Suite will not function properly.

Installing AI Suite

To install AI Suite on your computer:

1. Place the support DVD to the optical drive. The Drivers installation tab appears if your computer has an enabled Autorun feature.
2. Click the Utilities tab, then click **AI Suite**.
3. Follow the screen instructions to complete installation.

Launching AI Suite

You can launch AI Suite right after installation or anytime from the Windows® desktop.

To launch AI Suite from the Windows® desktop, click **Start > All Programs > ASUS > AI Suite > AI Suite v1.xx.xx**. The AI Suite main window appears.

After launching the application, the AI Suite icon appears in the Windows® taskbar. Click this icon to close or restore the application.

Using AI Suite

Click the AI Gear 3, AI Nap, AI Booster, or Q-Fan 2 icon to launch the utility, or click the Normal icon to restore the system to normal state.

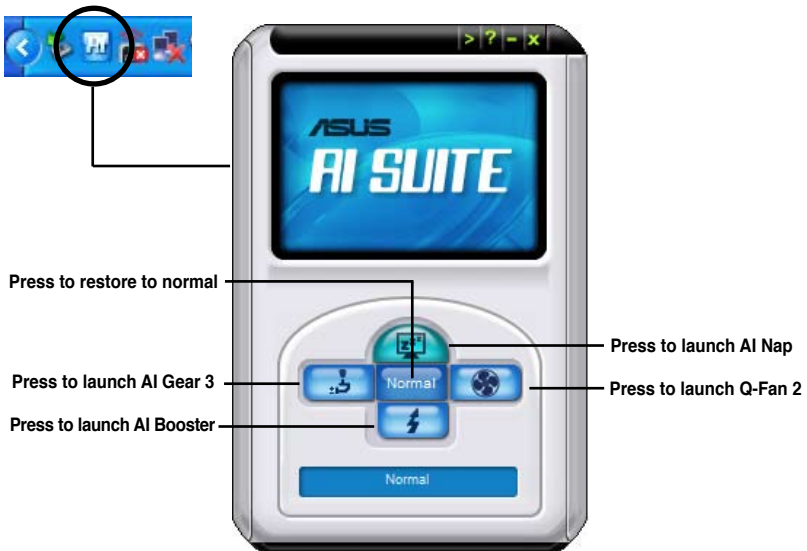

Other feature buttons

Click  on right corner of the main window to open the monitor window.

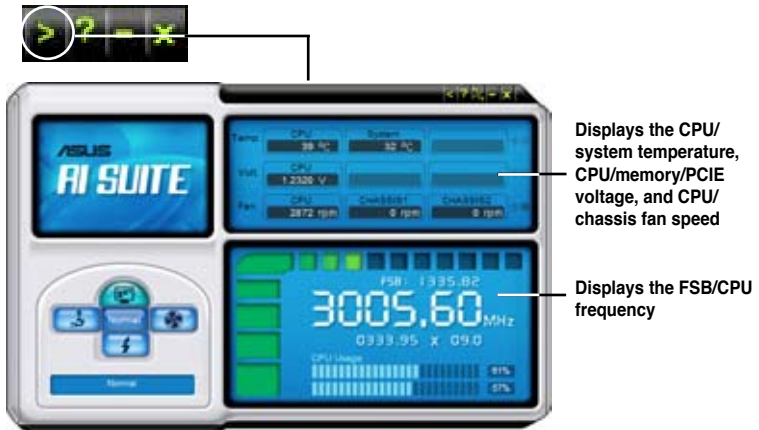

Click  on right corner of the expanded window to switch the temperature from degrees Centigrade to degrees Fahrenheit.



5.3.5 ASUS EPU Utility -- AI Gear 3

ASUS AI Gear 3 is a utility designed to configure and support all ASUS EPU (Energy Processing Unit) features. This easy-to-use utility provides four system performance profiles that adjust the processor frequency and vCore voltage for different computing needs.

After installing ASUS AI Suite from the bundled support DVD, you can launch ASUS AI Gear 3 by double-clicking the AI Suite icon on your Windows OS taskbar and then click the AI Gear 3 button on the AI Suite main window.

Here are some simple ways to use AI Gear 3:

- Click the four gear mode buttons below, including **Turbo**, **High Performance**, **Medium Power Saving**, and **Max. Power Saving**, or shift the gear to the performance setting that you like.
- Click **Calibration** first, and switch to **Auto** mode to have AI Gear 3 automatically adjust the system performance according to the CPU loading.
- Under **Auto** mode, Click **Settings** to set the time for the system to enter AI Nap mode.

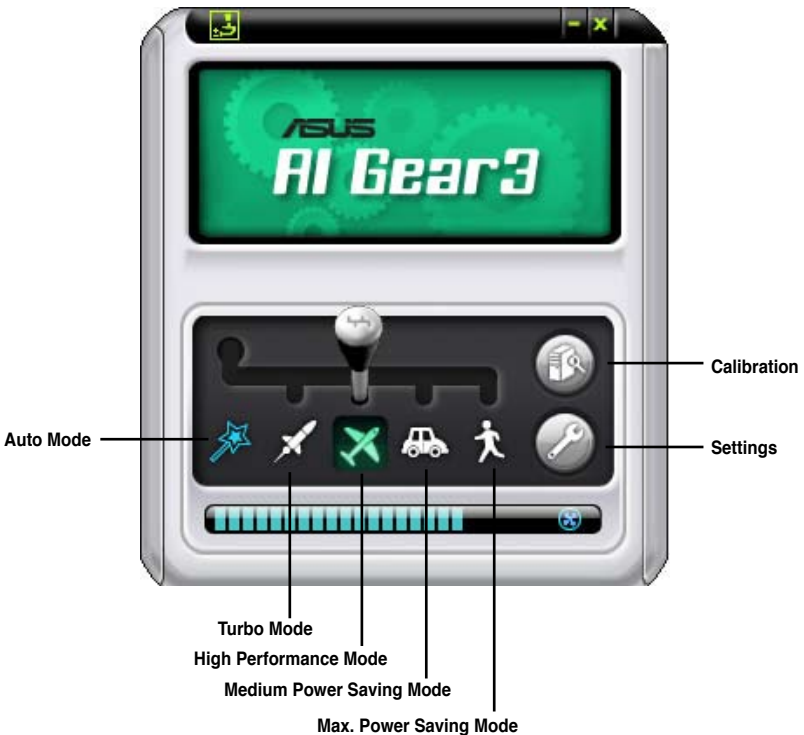

5.3.6 ASUS AI Nap

This feature allows you to minimize the power consumption of your computer whenever you are away. Enable this feature for minimum power consumption and a more quiet system operation.

After installing AI Suite from the bundled support DVD, you can launch the utility by double-clicking the AI Suite icon on the Windows OS taskbar and click the AI Nap button on the AI Suite main window.

Click **Yes** on the confirmation screen.

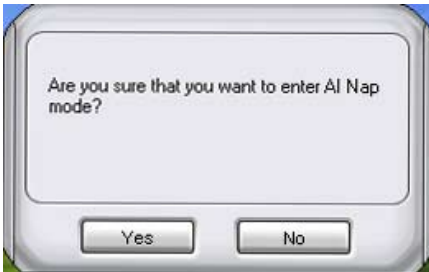

To exit AI Nap mode, press the system power or mouse button then click **Yes** on the confirmation screen.



To switch the power button functions from AI Nap to shutting down, just right click the **AI Suite** icon on the OS taskbar, select **AI Nap** and click **Use power button**. Unclick the the item to switch the function back.

5.3.7 ASUS Q-Fan 2

This ASUS Q-Fan 2 Control feature allows you to set the appropriate performance level of the CPU Q-Fan 2 or the Chassis Q-Fan 2 for more efficient system operation. After enabling the Q-Fan 2 function, the fans can be set to automatically adjust depending on the temperature, to decrease fan speed, or to achieve the maximum fan speed.

After installing AI Suite from the bundled support DVD, you can launch the utility by double-clicking the AI Suite icon on the Windows® OS taskbar and click the Q-Fan 2 button on the AI Suite main window.

Click the drop-down menu button and display the fan names. Select **CPU Q-Fan 2** or **CHASSIS Q-Fan 2**. Click the box of **Enabled** to activate this function.

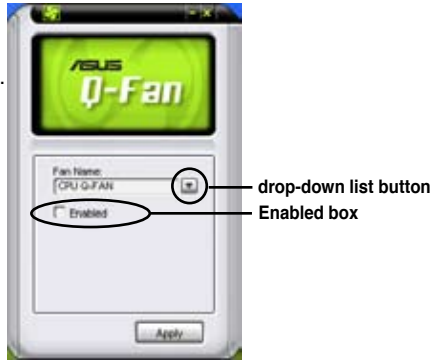

Profile list appears after clicking the **Enabled** box. Click the drop-down list button and select a profile. **Optimal** mode makes the fans adjust speed with the temperature; **Silent** mode minimizes fan speed for quiet fan operation; **Performance** mode boosts the fan to achieve maximal fan speed for the best cooling effect.



Click **Apply** at the bottom to save the setup.

5.3.8 ASUS AI Booster

The ASUS AI Booster application allows you to overclock the CPU speed in Windows® environment without the hassle of booting the BIOS.

After installing AI Suite from the bundled support DVD, you can launch the utility by double-clicking the AI Suite icon on the Windows® OS taskbar and click the AI Booster button on the AI Suite main window.

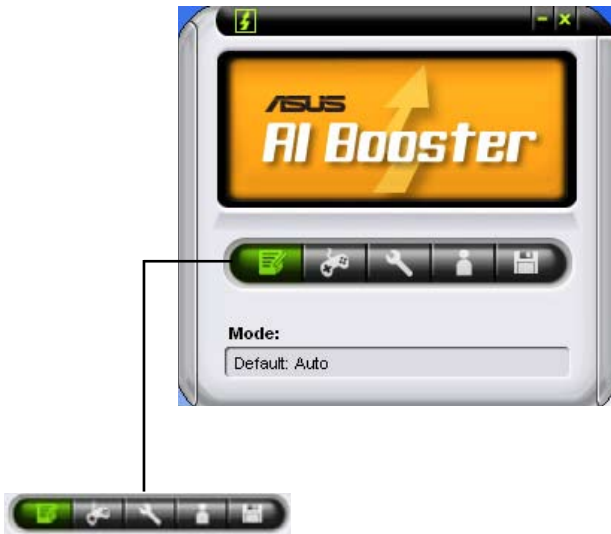

The options on the taskbar allow you to use the default settings, adjust CPU/ Memory/PCI-E frequency manually, or create and apply your personal overclocking configurations.

5.3.9 ASUS AI Direct Link

ASUS AI Direct Link allows you to form a computer-to-computer network via a network cable to share files with high transfer rate. You must first connect two computers (at least one of them is ASUS product) using a network cable, and then install the utility to both computers to avail the AI Direct Link feature.



- Turn off your firewall software other than Windows Firewall before launching AI Direct Link.
- The transfer rate is limited if you use a 10/100 LAN card.

Using AI Direct Link

To enable the incoming folder:

1. From the Windows® taskbar, right click on the AI Direct Link icon  and select **Incoming folder > Enable incoming folder**.



For Windows XP Home edition users, click **Steps of enabling file sharing** on this pop-up message and follow the instructions to enable the incoming folder.



2. If you want to verify the incoming user, select **Use my account** and set your username and password. Otherwise, select **Use public account**.



For security's sake, it is recommended that you set a username and password.

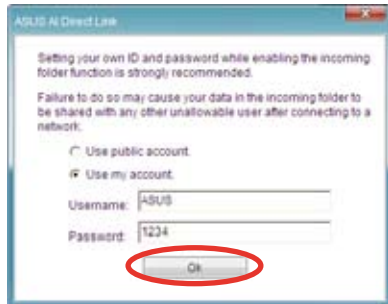

3. Click **OK** and the “Ready for incoming” message appears.



To disable the incoming folder, select **Incoming folder > Disable incoming folder**.

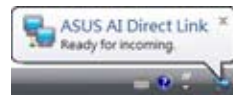

- Right click on the AI Direct Link icon and select **Incoming folder > Open incoming folder**. The **AIDirectLinkIncoming** folder opens. Put the files you want to share into this folder. The authorized user has full access to this folder.

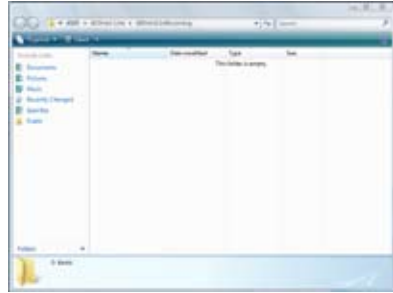

The default path of the AIDirectLinkIncoming folder is C:\Program Files\ASUS\AI Direct Link. To change its location, disable the incoming folder first. Then, select **Incoming folder > Change incoming folder** to open the system directories, and move the AIDirectLinkIncoming folder under another directory.

To connect to another computer:



This function is valid for ASUS products only.

- From the Windows® taskbar, right click on the AI Direct Link icon and select **Connect**. The following screen displays.
- Click **Refresh**. The software starts searching for the connected computer.

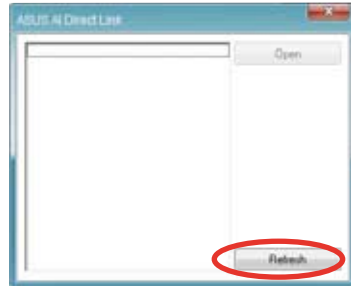

- The name of the computer found is listed. Click **Open** to open its shared folder.

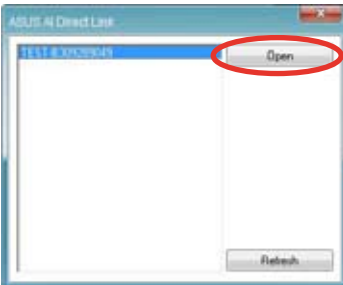

- If necessary, enter the authorized username and password. Click **OK** to log in and have full access to this shared folder.

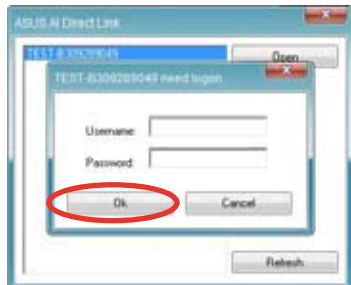

5.3.10 AI Audio 2 (SoundMAX® High Definition Audio utility)

The ADI AD1988B High Definition Audio CODEC provides 8-channel audio capability through the SoundMAX® audio utility with AudioESP™ software to deliver the ultimate audio experience on your PC. The software implements high quality audio synthesis/rendering, 3D sound positioning, and advanced voice-input technologies.

Follow the installation wizard to install the ADI AD1988B Audio Driver from the support DVD that came with the motherboard package to activate the SoundMAX® audio utility.



You must use 4-channel, 6-channel or 8-channel speakers for this setup.

If the SoundMAX® audio utility is correctly installed, you will find the SoundMAX® / SoundMAX® BlackHawk icon on the taskbar.



A. SoundMAX BlackHawk (AI Audio 2)

If you are using Windows® Vista operation system, from the taskbar, double-click the SoundMAX® BlackHawk icon to display the SoundMAX® control panel.



Enabling AI Audio 2

Click the power button  to activate digital signal processing.

AI Audio 2, with the new SoundMAX BlackHawk by Sonic Focus, brings you more multi-media enjoyment.

Fidelity Compensation

After you click the power button, the utility would compensate for the fidelity lost in the compression process and make the audio output quasi-original when reverting the compressed audio streams back to the uncompressed condition.

Sound Field Expansion

AI Audio 2 also expands the stereophonic sound field to a multi-channel one with realistic front and rear environment.

Surround Virtualization

Activating this function virtualizes surround sound with the vocal clarity added for use with stereo speakers or headphones.



SoundMAX BlackHawk (AI Audio 2) is only available under the Windows® Vista™ operating system.

Playback Settings

To configure the playback settings, click the **Playback** button on the control panel. You can adjust the volume of the **Speakers** and **SPDIF Interface** or mute the audio.

Preset settings

Click and expand the drop-down menu to select your preferred Digital Signal Processing (DSP) preset. Move the sliders to customize the values of **Voice Clarity**, **Dynamics**, **Brilliance**, and **Deep Bass** of each preset. Click **Save** to save the changes to the current preset. Or, click **Reset** to discard the changes and restore the preset to the factory defaults.



Surround settings

Allows you to change the settings of the stereo speakers. Move the sliders to change the listener position or adjust the center channel volume. Press the **Test Speakers** button to perform speaker test.



Port settings

Click this port settings tab to display the rear panel ports configuration for the speakers or rear panel digital port configuration for the SPDIF interface.



Recording Settings

To change the recording settings, click the **Recording** button on the control panel. You can adjust the speaker delay of **Microphone** or **Line In** by moving the slider rightward or leftward.

Record testing

Click the tab to perform test recording and play the test sample through the speakers or the SPDIF interface.

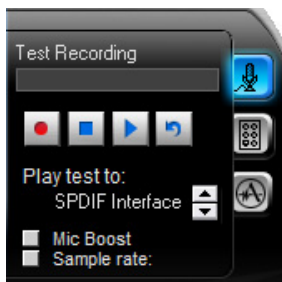

Port settings

Click the tab to display the rear panel ports for Microphone or Line In.



ANDREA settings

Allows you to select an enhanced microphone input features, including **No Filtering**, **Speakerphone**, **Voice Recording**, and **Directional Beam**.

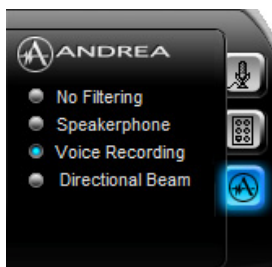

More Settings

Click  for the further configurations.

Equalizer

Allows you to configure and customize all the DSP presets through frequencies.



Speakers

Allows you to adjust the **Speaker Trim** and **Speaker Delay**.



Bass

Allows you to do the Bass management.



Preferences

Displays the preference options for this utility, version information, AudioESP, etc.



B. SoundMAX

If you are using Windows® XP operating system, from the taskbar, double-click on the SoundMAX® icon to display the SoundMAX® Control Panel.



Audio Setup Wizard

By clicking the  icon from the SoundMAX® control panel, you can easily configure your audio settings. Simply follow succeeding screen instructions and begin enjoying High Definition Audio.



Jack configuration

This screen helps you configure your computer's audio ports, depending on the audio devices you have installed.



Adjust speaker volume

This screen helps you adjust speaker volume. Click the **Test** button to hear the changes you have made.



Adjust microphone volume

This screen helps you adjust microphone volume. You will be asked to read pre-written text to allow the AudioWizard to adjust the volume as you speak.



Audio preferences

Click the  icon to go to the Preferences page. This page allows you to change various audio settings.

General options

Click the General tab to choose your playback and recording devices, enable/disable the AudioESP™ feature, and enable/disable digital output.



Listening Environment options

Click the Listening Environment tab to set up your speaker, acoustic environment, and enable/disable the Virtual Theater Surround function.

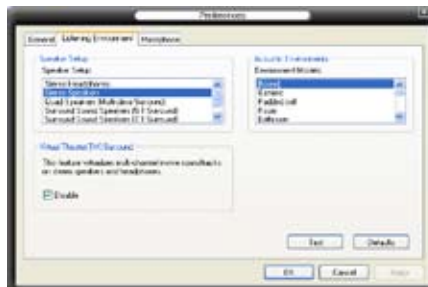

Microphone options

Click the Microphone tab to optimize your microphone input settings.



Enhanced Microphone Features

Voice recording

Enables Noise Filter function. Detects repetitive and stationary noises like computer fans, air conditioners, and other background noises then eliminates it in the incoming audio stream while recording. You can enable it for a better recording quality.

Directional Array

Receives only the sound coming from the reception cone and eliminates interferences including neighboring speakers and reverberations. You can enable it to transmit clearer sound during on-line games, MSN, or Skype.

Speaker Phone

Advanced de-reverberation techniques can help to reduce echo and minimize its effect on the speech engine. You can enable it when you have a conference call to reduce echoes on the other side.



- The Directional Array and Speaker Phone function only when working with the ASUS Array Mic.
- The ASUS Array Mic is purchased separately.
- If you are using Windows Vista, you have to manually enable the directional Array and Speaker Phone function. Go to **Control panel > Sound**. Click the **Recording** tab on the top and select **Microphone**. Click the **Microphone Enhancement** tab and check **Array Mic**.



5.4 RAID configurations

The motherboard comes with one RAID controllers that allow you to configure Serial ATA hard disk drives as RAID sets.

- The **NVIDIA® nForce™ 780i SLI Southbridge** includes a high performance SATA RAID controller that supports RAID 0, RAID 1, RAID 0+1, RAID 5 and JBOD for six independent Serial ATA channels.

5.4.1 RAID definitions

RAID 0 (Data striping) optimizes two identical hard disk drives to read and write data in parallel, interleaved stacks. Two hard disks perform the same work as a single drive but at a sustained data transfer rate, double that of a single disk alone, thus improving data access and storage. Use of two new identical hard disk drives is required for this setup.

RAID 1 (Data mirroring) copies and maintains an identical image of data from one drive to a second drive. If one drive fails, the disk array management software directs all applications to the surviving drive as it contains a complete copy of the data in the other drive. This RAID configuration provides data protection and increases fault tolerance to the entire system. Use two new drives or use an existing drive and a new drive for this setup. The new drive must be of the same size or larger than the existing drive.

RAID 5 stripes both data and parity information across three or more hard disk drives. Among the advantages of RAID 5 configuration include better HDD performance, fault tolerance, and higher storage capacity. The RAID 5 configuration is best suited for transaction processing, relational database applications, enterprise resource planning, and other business systems. Use a minimum of three identical hard disk drives for this setup.

RAID 10 is data striping and data mirroring combined without parity (redundancy data) having to be calculated and written. With the RAID 10* configuration you get all the benefits of both RAID 0 and RAID 1 configurations. Use four new hard disk drives or use an existing drive and three new drives for this setup.

JBOD (Spanning) stands for Just a Bunch of Disks and refers to hard disk drives that are not yet configured as a RAID set. This configuration stores the same data redundantly on multiple disks that appear as a single disk on the operating system. Spanning does not deliver any advantage over using separate disks independently and does not provide fault tolerance or other RAID performance benefits.



If you want to boot the system from a hard disk drive included in a RAID set, first copy the RAID driver from the Support DVD to a floppy disk before you install an operating system to a selected hard disk drive. Refer to section “5.5 Creating a RAID driver disk” for details.

5.4.2 NVIDIA® RAID configurations

The motherboard includes a high performance SATA RAID controller integrated in the NVIDIA® nForce™ 680i SLI southbridge chipset. It supports RAID 0, RAID 1, RAID 0+1, RAID 5 and JBOD for six independent Serial ATA channels.

Installing Serial ATA (SATA) hard disks

The motherboard supports Ultra DMA 133/100/66 and Serial ATA hard disk drives. For optimal performance, install identical drives of the same model and capacity when creating a disk array.

To install the SATA hard disks for a RAID configuration:

1. Install the SATA hard disks into the drive bays.
2. Connect the SATA signal cables.
3. Connect a SATA power cable to the power connector on each drive.



Refer to the RAID controllers user manual in the motherboard support DVD for detailed information on RAID configurations. See section “5.2.5 Manuals menu.”

Setting the BIOS RAID items

After installing the hard disk drives, make sure to set the necessary RAID items in the BIOS before setting your RAID configuration.

To set the BIOS RAID items:

1. Boot the system and press during the Power-On Self-Test (POST) to enter the BIOS Setup Utility.
2. Enable the **RAID Enabled** item in the BIOS. See section “**4.5.3 Onboard Device Configuration > Serial-ATA Configuration**” for details.
3. Select and enable the SATA drive(s) that you want to configure as RAID. See section “**4.5.3 Onboard Device Configuration > Serial-ATA Configuration**” for details.
4. Save your changes and Exit Setup.



Make sure to re-enter your NVRAID settings after the CMOS is cleared; otherwise, the system will not recognize your RAID setup.



- For detailed descriptions on the NVIDIA® RAID configuration, refer to the “NVIDIA® RAID User Guide” found in your motherboard Support DVD.
- When using Windows® XP operating system, make sure to install the Windows® XP Service Pack 2 or later versions.

Entering the NVIDIA® RAID utility

To enter the NVIDIA® RAID utility:

1. Boot up your computer.
2. During POST, press <F10> to display the main menu of the utility.



The RAID BIOS setup screens shown in this section are for reference only, and may not exactly match the items on your screen.

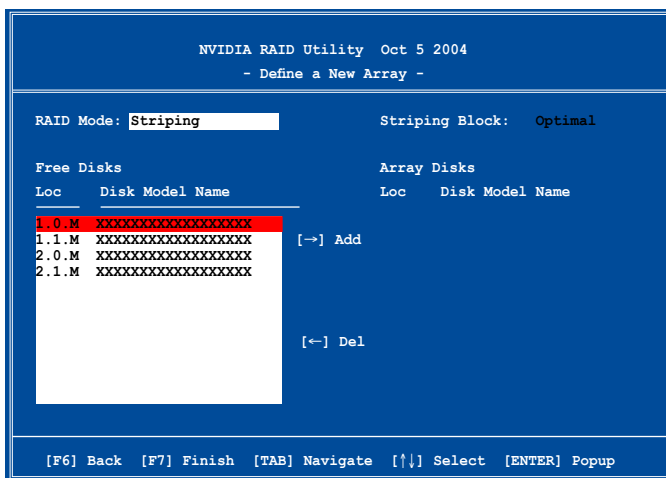

At the bottom of the screen are the navigation keys. These keys allow you to move through and select menu options.

Creating a RAID Volume

To create a RAID volume:

1. From the NVIDIA® RAID utility Define a New Array menu, select RAID Mode then press <Enter>. The following submenu appears.

Use the up or down arrow keys to select a RAID mode then press <Enter>.

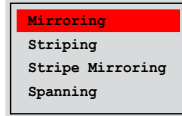

2. Press <TAB> select the Striping Block then press <Enter>. The following submenu appears:

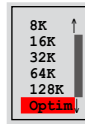

If you selected Striping or Stripe Mirroring, use the up or down arrow keys to select the stripe size for your RAID 0 array then press <Enter>. The available values range from 8 KB to 128 KB. The default selection is 128 KB. The strip value should be chosen based on the planned drive usage.

- 8 /16 KB - low disk usage
- 64 KB - typical disk usage
- 128 KB - performance disk usage



TIP: For server systems, we recommend using a lower array block size. For multimedia computer systems used mainly for audio and video editing, we recommend a higher array block size for optimum performance.

3. Press <TAB> to select the Free Disks area. Use the left or right arrow keys to assign the array disks.
4. Press <F7> to create RAID set. The following message box appears.

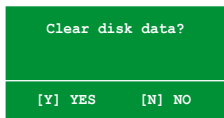

5. Press <Y> to clear the selected disks or <N> to proceed without clearing the disks. The following screen appears.



Take caution in using this option. All data on the RAID drives will be lost!

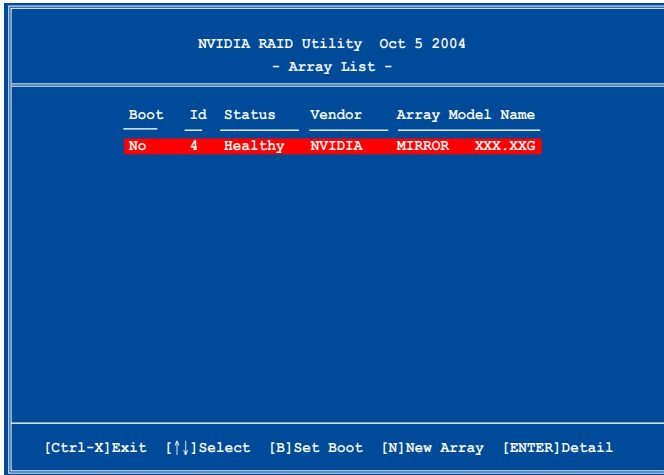

A new set of navigation keys is displayed on the bottom of the screen.

6. Press <Ctrl+X> to save settings and exit.

Rebuilding a RAID array

To rebuild a RAID array:

1. From the Array List menu, use the up or down arrow keys to select a RAID array then press <Enter>. The RAID Array details appear.

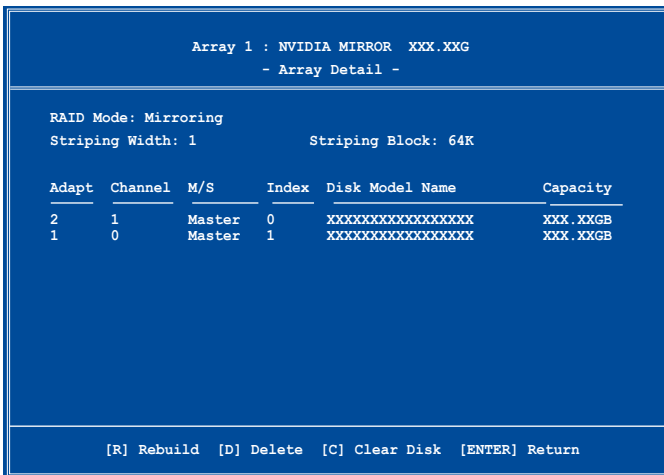

- A new set of navigation keys is displayed on the bottom of the screen.
2. Press <R> to rebuild a RAID array. The following screen appears.

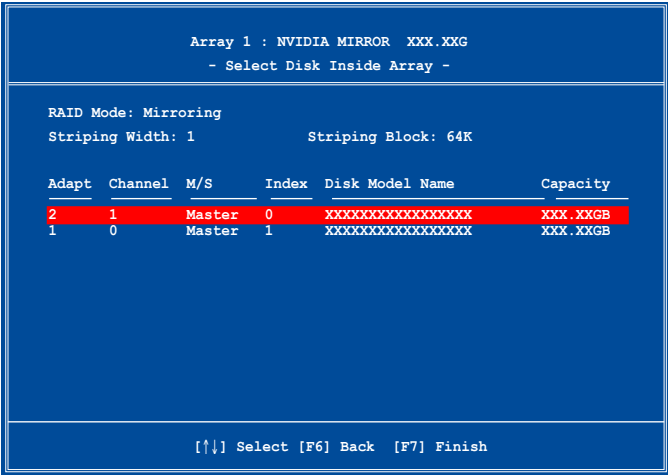

3. Use the up or down arrow keys to select a RAID array to rebuild, then press <F7>. The following confirmation message appears.

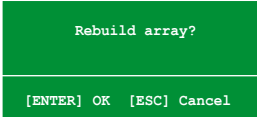

4. Press <Enter> to start rebuilding array or press <Esc> to cancel.
5. After the rebuild process, the Array list menu appears.



You will need to enter Window® XP and run the NVIDIA utility in order to complete the rebuilt process.

Deleting a RAID array

To delete a RAID array:

1. From the Array List menu, use the up or down arrow keys to select a RAID array then press <Enter>. The RAID Array details appear.

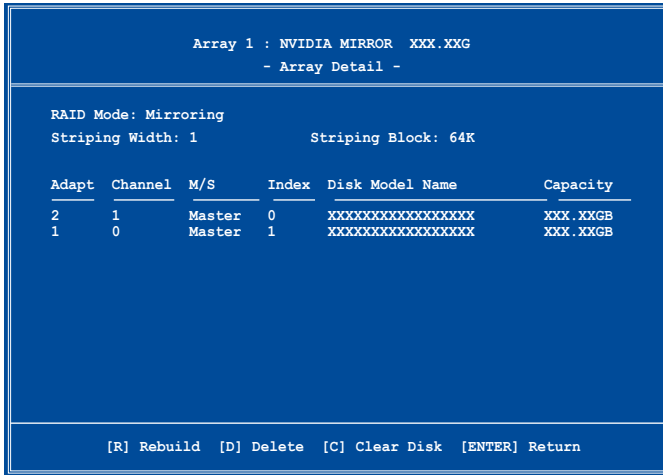

A new set of navigation keys is displayed on the bottom of the screen.

2. Press <D> to delete a RAID array. The following confirmation message appears.

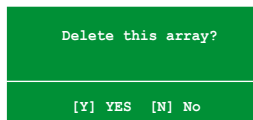

3. Press <Y> to delete array or press <N> to cancel.



Take caution in using this option. All data on the RAID drives will be lost!

4. If you selected Yes, the Define a New Array menu appears.

Clearing a disk data

To clear disk data:

1. From the Array List menu, use the up or down arrow keys to select a RAID array then press <Enter>. The RAID Array details appear.

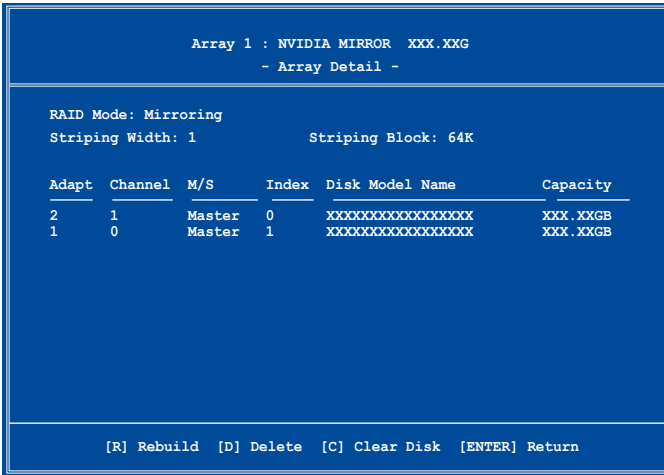

A new set of navigation keys is displayed on the bottom of the screen.

2. Press <C> to clear disk. The following confirmation message appears.

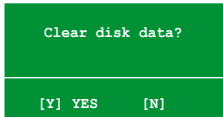

3. Press <Y> to clear the disk data or press <N> to cancel.



Take caution in using this option. All data on the RAID drives will be lost!

5.5 Creating a RAID driver disk

A floppy disk with the RAID driver is required when installing Windows® XP operating system on a hard disk drive that is included in a RAID set. For Windows® Vista™ operating system, use either a floppy disk or a USB device with the RAID driver.

5.5.1 Creating a RAID driver disk without entering the OS

To create a RAID/SATA driver disk without entering the OS:

1. Boot your computer.
2. Press during POST to enter the BIOS setup utility.
3. Set the optical drive as the primary boot device.
4. Insert the support CD into the optical drive.
5. Save changes and exit BIOS.
6. Press any key when the system prompts "Press any key to boot from the optical drive."
7. When the menu appears, press <1> to create a RAID driver disk.
8. Insert a formatted floppy disk into the floppy drive then press <Enter>.
9. Follow succeeding screen instructions to complete the process.

5.5.2 Creating a RAID/SATA driver disk in Windows®

To create a RAID driver disk in Windows®:

1. Start Windows®.
2. Place the motherboard support DVD into the optical drive.
3. Go to the Make Disk menu, then click **NVIDIA 32/64 bit XP/Vista SATA RAID Driver** to create a NVIDIA® 32/64 bit XP/Vista™ SATA RAID driver disk.
4. Insert a floppy disk/USB device into the floppy disk drive/USB port.
5. Follow succeeding screen instructions to complete the process.



Write-protect the floppy disk to avoid computer virus infection.

To install the RAID driver in Windows® XP:

1. During the OS installation, the system prompts you to press the F6 key to install third-party SCSI or RAID driver.
2. Press <F6> then insert the floppy disk with RAID driver into the floppy disk drive.
3. Follow the succeeding screen instructions to complete the installation.

To install the RAID driver in Windows® Vista™:

1. Insert the floppy disk/USB device with RAID driver into the floppy disk drive/USB port.
2. Follow the succeeding screen instructions to complete the installation.



Due to chipset limitation, the Serial ATA ports supported by the NVIDIA chipset doesn't support Serial Optical Disk Drives (Serial ODD) under DOS.

This chapter tells how to install SLI-ready
PCI Express graphics cards.

NVIDIA[®] SLI[™] **technology support**

Chapter summary

- 6.1 Overview 6-1
- 6.2 Graphics card setup 6-2

6.1 Overview

The motherboard supports the NVIDIA® SLI™ (Scalable Link Interface) technology that allows you to install up to three identical PCI Express™ x16 graphics cards. Follow the installation procedures in this section.

Requirements

- In Dual SLI mode, you should have two identical SLI-ready graphics cards that are NVIDIA® certified.
- In 3-way SLI mode, you should have two identical SLI-ready graphics cards that are NVIDIA® certified.
- Make sure that your graphics card driver supports the NVIDIA SLI technology. Download the latest driver from the NVIDIA website (www.nvidia.com).
- Make sure that your power supply unit (PSU) can provide at least the minimum power required by your system. See page 2-30 for details.



-
- The NVIDIA 3-way SLI technology supports Windows® Vista operating system only.
 - Visit the NVIDIA zone website (<http://www.nzone.com>) for the latest certified graphics card and supported 3D application list.
-

6.2 Graphics card setup

6.2.1 Installing three SLI-ready graphics cards



Install only identical SLI-ready graphics cards that are NVIDIA®-certified. Different types of graphics cards will not work together properly.

To install the graphics cards:

1. Prepare three graphics cards. Each graphics card should have goldfingers for the 3-way SLI bridge connector.

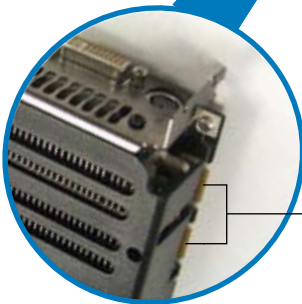
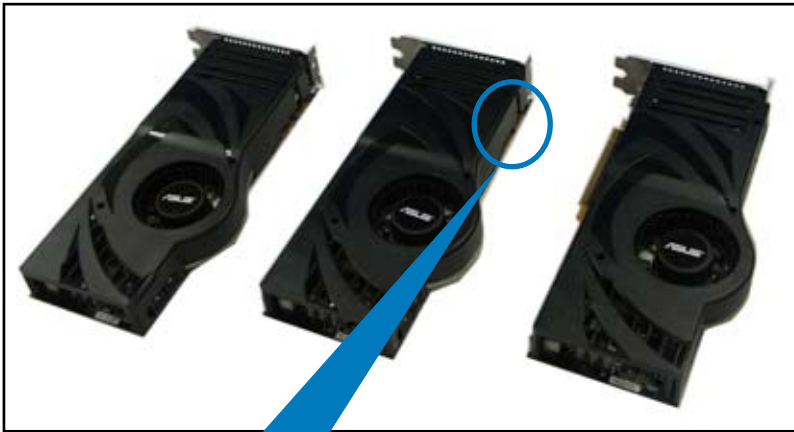

Goldfingers

2. Insert the first graphics card into the PCIEX16_1 slot (blue), the second into the PCIEX16_2 slot (black), and the third into the PCIEX16_3 slot (blue). Make sure that the cards are properly seated on the slots.

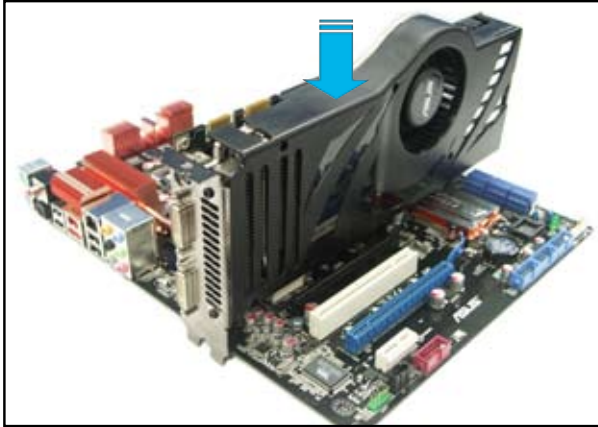

3. Align and firmly insert the 3-way SLI bridge connector to the goldfingers on each graphics card. Make sure that the connector is firmly in place.

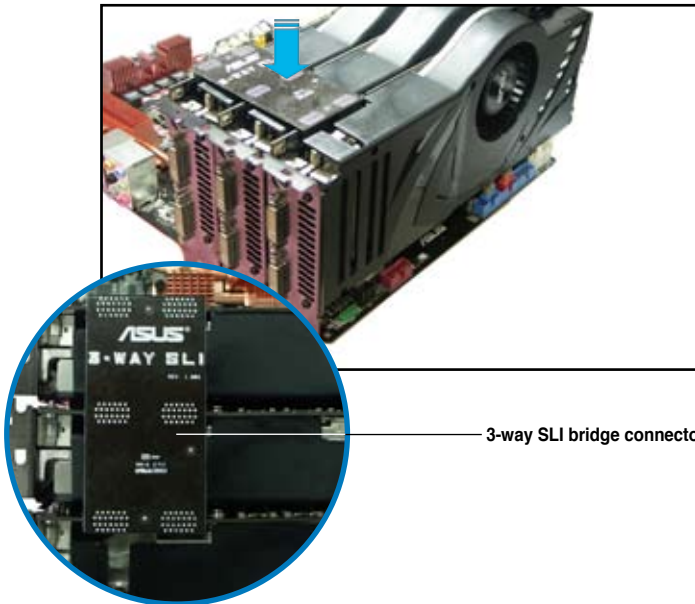

4. Connect auxiliary power source from the power supply to the three graphics cards separately.

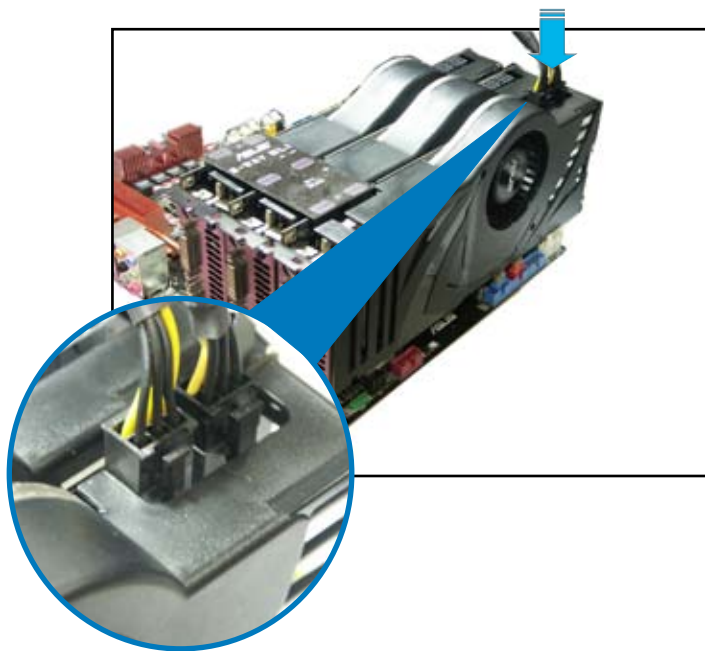

5. Connect a VGA or a DVI-I cable to the graphics card/s.



We recommend that you install an additional chassis fan for better thermal environment.

6.2.2 Installing two SLI-ready graphics cards

1. Insert one graphics card into the PCIEX16_1 slot (blue) and the other into the PCIEX16_3 slot (blue). Make sure that the cards are properly seated on the slots.
2. Align and insert the SLI connector to the goldfingers on each graphics card. Make sure that the connector is firmly in place.
3. Connect auxiliary power source from the power supply to the two graphics cards separately.
4. Connect a VGA or a DVI-I cable to the graphics card/s.



We recommend that you install an additional chassis fan for better thermal environment.

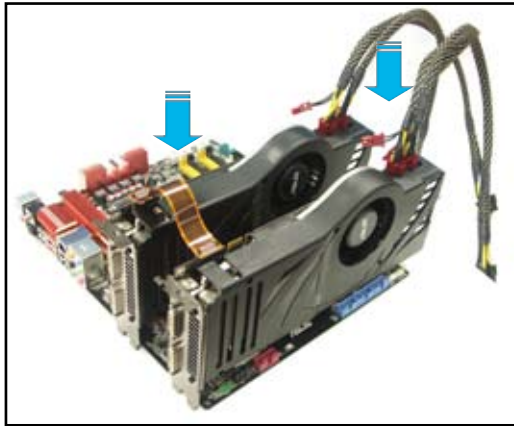

6.2.3 Installing the device drivers

Refer to the documentation that came with your graphics card package to install the device drivers.



- Make sure that your PCI Express graphics card driver supports the NVIDIA® SLI™ technology. Download the latest driver from the NVIDIA website (www.nvidia.com).
- If you are using a 3-way SLI system, make sure to install the 3-way SLI driver under Windows® Vista OS. The NVIDIA 3-way SLI technology supports Windows® Vista OS only.

6.2.4 Enabling the NVIDIA® SLI™ technology in Windows®

After installing your graphics cards and the device drivers, enable the SLI feature in NVIDIA® Control Panel under the Windows® Vista operating system.

Launching the NVIDIA Control Panel

You can launch the NVIDIA Control Panel by two methods.

- (a) Right click on the empty space of Windows® desktop and select **NVIDIA Control Panel**.

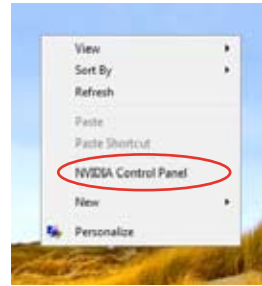

- (b) If you cannot see the NVIDIA Control Panel item in step (a), select **Personalize**.

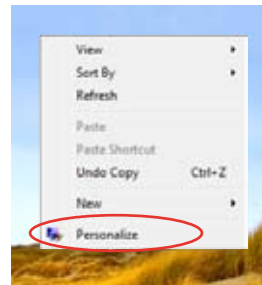

From the **Personalization** window, select **Display Settings**.

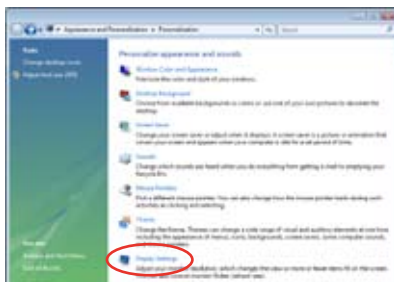

From the Display Settings dialog box, click **Advanced Settings**.



Select the NVIDIA GeForce tab, then click **Start the NVIDIA Control Panel**.



The Appendix describes the CPU features and technologies that the motherboard supports.

CPU features



Chapter summary



A.1	Intel® EM64T.....	A-1
A.2	Enhanced Intel SpeedStep® Technology (EIST).....	A-1
A.3	Intel® Hyper-Threading Technology	A-3

A.1 Intel® EM64T



- The motherboard is fully compatible with Intel® LGA775 processors running on 32-bit operating systems.
- The motherboard comes with a BIOS file that supports EM64T. You can download the latest BIOS file from the ASUS website (www.asus.com/support/download/) if you need to update the BIOS file. See Chapter 4 for details.
- Visit www.intel.com for more information on the EM64T feature.
- Visit www.microsoft.com for more information on Windows® 64-bit OS.

Using the Intel® EM64T feature

To use the Intel® EM64T feature:

1. Install an Intel® CPU that supports the Intel® EM64T.
2. Install a 64-bit operating system (Windows® Vista 64-bit Edition or Windows® XP Professional x64 Edition).
3. Install the 64-bit drivers for the motherboard components and devices from the support CD.
4. Install the 64-bit drivers for expansion cards or add-on devices, if any.



Refer to the expansion card or add-on device(s) documentation, or visit the related website, to verify if the card/device supports a 64-bit system.

A.2 Enhanced Intel SpeedStep® Technology (EIST)



- The motherboard comes with a BIOS file that supports EIST. You can download the latest BIOS file from the ASUS website (www.asus.com/support/download/) if you need to update the BIOS. See Chapter 4 for details.
- Visit www.intel.com for more information on the EIST feature.

A.2.1 System requirements

Before using EIST, check your system if it meets the following requirements:

- Intel® processor with EIST support
- BIOS file with EIST support
- Operating system with EIST support (Windows® Vista, Windows® XP SP2/ Linux 2.6 kernel or later versions).

A.2.2 Using the EIST

To use the EIST feature:

1. Turn on the computer, then enter the BIOS Setup.
2. Go to the Advanced Menu, highlight CPU Configuration, then press <Enter>.
3. Set the Intel(R) SpeedStep (TM) Tech. item to [Automatic], then press <Enter>.
4. Press <F10> to save your changes and exit the BIOS setup.
5. After the computer restarts, right click on a blank space on the desktop, then select Properties from the pop-up menu.
6. When the Display Properties window appears, click the Screen Saver tab.
7. Click the Power button on the Monitor power section to open the Power Options Properties window.

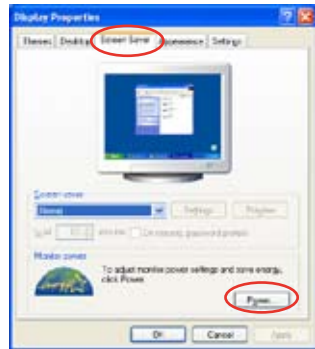

8. On the Power schemes section, click , then select any option except Home/Office Desktop or Always On.
9. Click Apply, then click OK.
10. Close the Display Properties window.

After you adjust the power scheme, the CPU internal frequency slightly decreases when the CPU loading is low.

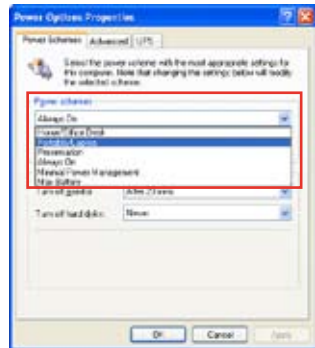

The screen displays and procedures may vary depending on the operating system.

A.3 Intel® Hyper-Threading Technology



- The motherboard supports Intel® Pentium® 4 LGA775 processors with Hyper-Threading Technology.
 - Hyper-Threading Technology is supported under Windows® Vista/XP and Linux 2.4.x (kernel) and later versions only. Under Linux, use the Hyper-Threading compiler to compile the code. If you are using any other operating systems, disable the Hyper-Threading Technology item in the BIOS to ensure system stability and performance.
 - Installing Windows® XP Service Pack 1 or later version is recommended.
 - Make sure to enable the Hyper-Threading Technology item in BIOS before installing a supported operating system.
 - For more information on Hyper-Threading Technology, visit www.intel.com/info/hyperthreading.
-

Using the Hyper-Threading Technology

To use the Hyper-Threading Technology:

1. Install an Intel® Pentium® 4 CPU that supports Hyper-Threading Technology.
2. Power up the system and enter the BIOS Setup. Under the Advanced Menu, make sure that the item **Hyper-Threading Technology** is set to [Enabled].
The BIOS item appears only if you installed a CPU that supports Hyper-Threading Technology.
3. Restart the computer.

