

DSBF-DE ***Series***

DSBF-DE

DSBF-DE/SAS

ASUS[®]

Motherboard

E2880

First Edition V1
November 2006

Copyright © 2006 ASUSTeK COMPUTER INC. All Rights Reserved.

No part of this manual, including the products and software described in it, may be reproduced, transmitted, transcribed, stored in a retrieval system, or translated into any language in any form or by any means, except documentation kept by the purchaser for backup purposes, without the express written permission of ASUSTeK COMPUTER INC. ("ASUS").

Product warranty or service will not be extended if: (1) the product is repaired, modified or altered, unless such repair, modification or alteration is authorized in writing by ASUS; or (2) the serial number of the product is defaced or missing.

ASUS PROVIDES THIS MANUAL "AS IS" WITHOUT WARRANTY OF ANY KIND, EITHER EXPRESS OR IMPLIED, INCLUDING BUT NOT LIMITED TO THE IMPLIED WARRANTIES OR CONDITIONS OF MERCHANTABILITY OR FITNESS FOR A PARTICULAR PURPOSE. IN NO EVENT SHALL ASUS, ITS DIRECTORS, OFFICERS, EMPLOYEES OR AGENTS BE LIABLE FOR ANY INDIRECT, SPECIAL, INCIDENTAL, OR CONSEQUENTIAL DAMAGES (INCLUDING DAMAGES FOR LOSS OF PROFITS, LOSS OF BUSINESS, LOSS OF USE OR DATA, INTERRUPTION OF BUSINESS AND THE LIKE), EVEN IF ASUS HAS BEEN ADVISED OF THE POSSIBILITY OF SUCH DAMAGES ARISING FROM ANY DEFECT OR ERROR IN THIS MANUAL OR PRODUCT.

SPECIFICATIONS AND INFORMATION CONTAINED IN THIS MANUAL ARE FURNISHED FOR INFORMATIONAL USE ONLY, AND ARE SUBJECT TO CHANGE AT ANY TIME WITHOUT NOTICE, AND SHOULD NOT BE CONSTRUED AS A COMMITMENT BY ASUS. ASUS ASSUMES NO RESPONSIBILITY OR LIABILITY FOR ANY ERRORS OR INACCURACIES THAT MAY APPEAR IN THIS MANUAL, INCLUDING THE PRODUCTS AND SOFTWARE DESCRIBED IN IT.

Products and corporate names appearing in this manual may or may not be registered trademarks or copyrights of their respective companies, and are used only for identification or explanation and to the owners' benefit, without intent to infringe.

Contents

Notices.....	vii
Safety information	viii
About this guide	ix
Typography	x
DSBF-DE Series specifications summary	xi
Chapter 1: Product introduction	
1.1 Welcome!	1-1
1.2 Package contents.....	1-1
1.3 Special features.....	1-2
1.3.1 Product highlights	1-2
1.3.2 Innovative ASUS features	1-4
Chapter 2: Hardware information	
2.1 Before you proceed	2-1
2.2 Motherboard overview.....	2-2
2.2.1 Placement direction	2-2
2.2.2 Screw holes	2-2
2.2.3 Support kits for the motherboard	2-3
2.2.4 Motherboard layouts	2-6
2.2.5 Layout contents.....	2-8
2.3 Central Processing Unit (CPU)	2-10
2.3.1 Installing the CPU	2-10
2.3.2 Installing the CPU heatsink and fan.....	2-13
2.4 System memory	2-15
2.4.1 Overview	2-15
2.4.2 Memory configurations.....	2-15
2.4.3 Memory mirroring and sparing technology.....	2-17
2.4.4 Installing a DIMM	2-20
2.4.5 Removing a DIMM	2-20
2.4.6 Installing the MemCool FB-DIMM fan (optional)	2-21
2.4.7 Uninstalling the optional MemCool FB-DIMM fan	2-23
2.5 Expansion slots.....	2-24
2.5.1 Installing an expansion card	2-24
2.5.2 Configuring an expansion card	2-24
2.5.3 Interrupt assignments	2-25
2.5.4 PCI/PCI-X slots	2-26
2.5.5 DDR2 SO-DIMM socket	2-26
2.5.6 PCI Express x16 slot (x8 link)	2-27
2.5.7 PCI Express x8 slot (x8 link; x4 link).....	2-27

Contents

2.6	Jumpers	2-28
2.7	Switch	2-33
2.8	Connectors	2-34
2.8.1	Rear panel connectors	2-34
2.8.2	Internal connectors	2-35
Chapter 3: Powering up		
3.1	Starting up for the first time	3-1
3.2	Turning off the computer	3-2
3.2.1	Using the OS shut down function.....	3-2
3.2.2	Using the dual function power switch.....	3-2
Chapter 4: BIOS setup		
4.1	Managing and updating your BIOS	4-1
4.1.1	Creating a bootable floppy disk.....	4-1
4.1.2	Updating the BIOS using the Phoenix Phlash16 Utility...	4-2
4.1.3	ASUS CrashFree BIOS 2 utility	4-3
4.1.4	ASUS Update utility	4-5
4.2	BIOS setup program	4-8
4.2.1	BIOS menu screen.....	4-9
4.2.2	Menu bar.....	4-9
4.2.3	Legend bar.....	4-10
4.2.4	Menu items	4-10
4.2.5	Sub-menu items.....	4-10
4.2.6	Configuration fields	4-10
4.2.7	Pop-up window	4-11
4.2.8	General help	4-11
4.3	Main menu	4-12
4.3.1	System Date	4-12
4.3.2	System Time	4-12
4.3.3	Floppy A.....	4-12
4.3.4	IDE Configuration.....	4-13
4.3.5	IDE Primary Master/Slave; SATA Port 1/2/3/4.....	4-15
4.3.6	System Information	4-16
4.4	Advanced menu	4-18
4.4.1	Advanced Processor Options	4-18
4.4.2	Chipset Configuration	4-22
4.4.3	PCI Configuration.....	4-25
4.4.4	ICH USB Control Sub-Menu	4-26

Contents

4.4.5	Peripheral Devices Configuration	4-27
4.4.6	ACPI Configuration	4-29
4.4.7	Power On Configuration.....	4-30
4.4.8	Hardware Monitor	4-31
4.5	Server menu	4-34
4.5.1	Console Redirection.....	4-34
4.5.2	DMI Event Logging	4-36
4.6	Security menu	4-37
4.7	Boot menu	4-39
4.7.1	Boot Device Priority	4-39
4.7.2	Boot Features	4-40
4.8	Exit menu.....	4-41
Chapter 5: RAID configuration		
5.1	Setting up RAID.....	5-1
5.1.1	RAID definitions	5-1
5.1.2	Installing hard disk drives.....	5-2
5.1.3	Setting the RAID item in BIOS	5-2
5.1.4	RAID configuration utilities.....	5-2
5.2	LSI Logic Embedded SATA RAID Setup Utility.....	5-3
5.2.1	Creating a RAID 0 or RAID 1 set	5-4
5.2.2	Creating a RAID 10 set.....	5-10
5.2.3	Adding or viewing a RAID configuration	5-14
5.2.4	Initializing the logical drives	5-17
5.2.5	Rebuilding failed drives.....	5-22
5.2.6	Checking the drives for data consistency	5-24
5.2.7	Deleting a RAID configuration.....	5-27
5.2.8	Selecting the boot drive from a RAID set.....	5-28
5.2.9	Enabling the WriteCache	5-29
5.3	Intel® Matrix Storage Manager Option ROM Utility	5-30
5.3.1	Creating a RAID 0 set (Stripe)	5-31
5.3.2	Creating a RAID 1 set (Mirror)	5-33
5.3.3	Creating a RAID 10 set (Stripe + Mirror).....	5-34
5.3.4	Creating a RAID 5 set (Parity)	5-35
5.3.5	Deleting a RAID set	5-36
5.3.6	Resetting disks to Non-RAID	5-37
5.3.7	Exiting the Intel® Matrix Storage Manager	5-37
5.4	Global Array Manager.....	5-38

Contents

- 5.5 LSI Logic MPT Setup Utility (*DSBF-DE/SAS model only*)..... 5-39
 - 5.5.1 Integrated Mirroring..... 5-39
 - 5.5.2 Integrated Mirroring Enhanced 5-43
 - 5.5.3 Integrated Striping (IS) volume 5-45
 - 5.5.4 Managing Arrays 5-48
 - 5.5.5 Viewing SAS topology..... 5-53
 - 5.5.6 Global Properties 5-55

Chapter 6: Driver installation

- 6.1 RAID driver installation 6-1
 - 6.1.1 Creating a RAID driver disk 6-1
 - 6.1.2 Installing the RAID controller driver 6-3
- 6.2 Intel® chipset software installation..... 6-12
- 6.3 LAN driver installation..... 6-15
 - 6.3.1 Windows® 2000/Server 2003 6-15
 - 6.3.2 Red Hat/SuSE Linux 6-20
- 6.4 VGA driver installation..... 6-21
 - 6.4.1 Windows® 2000/Server 2003 6-21
- 6.5 Management applications and utilities installation 6-24
 - 6.5.1 Running the support CD 6-24
 - 6.5.2 Drivers menu..... 6-24
 - 6.5.3 Management Software menu 6-25
 - 6.5.4 Utilities menu 6-25
 - 6.5.5 Contact information..... 6-25

Appendix: Reference information

- A.1 DSBF-DE/SAS model block diagram.....A-1
- A.2 DSBF-DE model block diagramA-2
- A.3 PHLASH16.EXE and memory managers.....A-3

Notices

Federal Communications Commission Statement

This device complies with Part 15 of the FCC Rules. Operation is subject to the following two conditions:

- This device may not cause harmful interference, and
- This device must accept any interference received including interference that may cause undesired operation.

This equipment has been tested and found to comply with the limits for a Class B digital device, pursuant to Part 15 of the FCC Rules. These limits are designed to provide reasonable protection against harmful interference in a residential installation. This equipment generates, uses and can radiate radio frequency energy and, if not installed and used in accordance with manufacturer's instructions, may cause harmful interference to radio communications. However, there is no guarantee that interference will not occur in a particular installation. If this equipment does cause harmful interference to radio or television reception, which can be determined by turning the equipment off and on, the user is encouraged to try to correct the interference by one or more of the following measures:

- Reorient or relocate the receiving antenna.
- Increase the separation between the equipment and receiver.
- Connect the equipment to an outlet on a circuit different from that to which the receiver is connected.
- Consult the dealer or an experienced radio/TV technician for help.



The use of shielded cables for connection of the monitor to the graphics card is required to assure compliance with FCC regulations. Changes or modifications to this unit not expressly approved by the party responsible for compliance could void the user's authority to operate this equipment.

Canadian Department of Communications Statement

This digital apparatus does not exceed the Class B limits for radio noise emissions from digital apparatus set out in the Radio Interference Regulations of the Canadian Department of Communications.

This class B digital apparatus complies with Canadian ICES-003.

Safety information

Electrical safety

- To prevent electrical shock hazard, disconnect the power cable from the electrical outlet before relocating the system.
- When adding or removing devices to or from the system, ensure that the power cables for the devices are unplugged before the signal cables are connected. If possible, disconnect all power cables from the existing system before you add a device.
- Before connecting or removing signal cables from the motherboard, ensure that all power cables are unplugged.
- Seek professional assistance before using an adapter or extension cord. These devices could interrupt the grounding circuit.
- Make sure that your power supply is set to the correct voltage in your area. If you are not sure about the voltage of the electrical outlet you are using, contact your local power company.
- If the power supply is broken, do not try to fix it by yourself. Contact a qualified service technician or your retailer.

Operation safety

- Before installing the motherboard and adding devices on it, carefully read all the manuals that came with the package.
- Before using the product, make sure all cables are correctly connected and the power cables are not damaged. If you detect any damage, contact your dealer immediately.
- To avoid short circuits, keep paper clips, screws, and staples away from connectors, slots, sockets and circuitry.
- Avoid dust, humidity, and temperature extremes. Do not place the product in any area where it may become wet.
- Place the product on a stable surface.
- If you encounter technical problems with the product, contact a qualified service technician or your retailer.

About this guide

This user guide contains the information you need when installing and configuring the motherboard.

How this guide is organized

This user guide contains the following parts:

- **Chapter 1: Product introduction**
This chapter describes the features of the motherboard and the new technologies it supports.
- **Chapter 2: Hardware information**
This chapter lists the hardware setup procedures that you have to perform when installing system components. It includes description of the switches, jumpers, and connectors on the motherboard.
- **Chapter 3: Powering up**
This chapter describes the power up sequence and ways of shutting down the system.
- **Chapter 4: BIOS setup**
This chapter tells how to change system settings through the BIOS Setup menu. Detailed descriptions of the BIOS parameters are also provided.
- **Chapter 5: RAID configuration**
This chapter provides instructions for setting up, creating, and configuring RAID sets using the available utilities.
- **Chapter 6: Driver installation**
This chapter provides instructions for installing the necessary drivers for different system components.
- **Appendix: Reference information**
This appendix includes additional information that you may refer to when configuring the motherboard.

Where to find more information

Refer to the following sources for additional information and for product and software updates.

1. **ASUS websites**
The ASUS website provides updated information on ASUS hardware and software products. Refer to the ASUS contact information.
2. **Optional documentation**
Your product package may include optional documentation, such as warranty flyers, that may have been added by your dealer. These documents are not part of the standard package.

Conventions used in this guide

To make sure that you perform certain tasks properly, take note of the following symbols used throughout this manual.



DANGER/WARNING: Information to prevent injury to yourself when trying to complete a task.



CAUTION: Information to prevent damage to the components when trying to complete a task.



IMPORTANT: Instructions that you **MUST** follow to complete a task.



NOTE: Tips and additional information to help you complete a task.

Typography

Bold text

Indicates a menu or an item to select.

Italics

Used to emphasize a word or a phrase.

<Key>

Keys enclosed in the less-than and greater-than sign means that you must press the enclosed key.

Example: <Enter> means that you must press the Enter or Return key.

<Key1+Key2+Key3>

If you must press two or more keys simultaneously, the key names are linked with a plus sign (+).

Example: <Ctrl+Alt+D>

Command

Means that you must type the command exactly as shown, then supply the required item or value enclosed in brackets.

Example: At the DOS prompt, type the command line: **format A:/S**

DSBF-DE Series specifications summary

CPU	<p>Dual LGA771 sockets for Intel® Xeon™ Dual Core processors 5000/5100/5300 Series</p> <p>Supports Intel® Extended Memory 64Technology (EM64T)</p> <p>Supports Intel® Hyper-Threading Technology (5000 series support H.T.; 5100/5300 series DO NOT support H.T.)</p>
Chipset	<p>MCH : Intel® 5000P</p> <p>ICH : Intel® 6321ESB</p>
Front Side Bus	1333/1066/667 MHz
Memory	<p>Quadri-channel memory architecture</p> <p>8 x 240-pin FB-DIMM sockets support registered ECC fully buffered DDR2-533/DDR2-667 memory modules with Advanced Memory Buffer (AMB chip)</p> <p>Supports 256 MB up to 32 GB system memory.</p> <p>Supports memory mirroring and sparing technology.</p>
Expansion slots	<p>DSBF-DE:</p> <p>1 x PCI Express™ x16 slot (x8 link)</p> <p>2 x PCI Express™ x8 slot (x8 link) (PCIe2/3)</p> <p>1 x PCI Express™ x8 slot (x4 link) (PCIe4)</p> <p>2 x PCI-X 133/100 MHz</p> <p>1 x DDR2 SO-DIMM socket for ASUS server management board 3 series (ASMB3)</p> <p>DSBF-DE/SAS:</p> <p>1 x PCI Express™ x16 slot (x8 link)</p> <p>2 x PCI Express™ x8 slot (x8 link) (PCIe2/3)</p> <p>1 x PCI Express™ x8 slot (x4 link) (PCIe4)</p> <p>1 x PCI-X 133/100 MHz</p> <p>1 x PCI-X 133/100 MHz for optional Zero Channel RAID (ZCR) card (color green)</p> <p>1 x DDR2 SO-DIMM socket for ASUS server management board 3 series (ASMB3)</p>
Storage	<p>Intel® 6321ESB supports:</p> <ul style="list-style-type: none"> - 2 x Ultra DMA 100/66/33 devices - 6 x SATA II HDDs (300 MB/s) - Intel® Matrix Storage with RAID 0, RAID 1, RAID 0+1, and RAID 5 configuration - LSI MegaRAID controller with RAID 0, RAID 1, and RAID 0+1 configuration <p><i>(DSBF-DE/SAS model only)</i></p> <p>LSI1068 PCI-X SAS controller supports:</p> <ul style="list-style-type: none"> - 2 x Serial Attached SCSI (SAS) channels (each channel supports 4 HDDs) with RAID0, RAID1, and RAID 1E configuration - Zero-Channel RAID card<i>(optional)</i>
LAN	Intel® ESB2E plus Gilgal Dual Port Gigabit Ethernet

(continued on the next page)

DSBF-DE Series specifications summary

USB	Intel® 6321 ESB supports: - 4 USB 2.0/1.1 ports (2 on the rear panel, 2 on the front panel)
Special features	ASUS Smart Fan Control ASUS Smart Fan2 Control ASUS CrashFree BIOS 2
BIOS features	PHOENIX BIOS, 8 Mb FWH, Green, PnP, DMI, WfM2.0, ACPI 2.0a, SMBIOS 2.3
Rear panel	1 x PS/2 keyboard port (purple) 1 x PS/2 mouse port (green) 2 x USB 2.0 ports 1 x VGA port 1 x Serial port 2 x LAN (RJ-45) ports
Internal connectors	1 x Floppy disk drive connector 1 x IDE connector 6 x Serial ATA connectors 1 x Hard disk activity LED connector (4-pin HDLED1) 1 x TPM connector (20-1 pin TPM1) 1 x Serial port connectors (10-1 pin COM2) 1 x Print port connector (26-1 pin LPT1) 1 x Power supply SMBus connector (5-pin PSUMB1) 1 x Backplane SMBus connector (6-1 pin BPSMB1) 1 x LPC connector for LPC debug card (14-pin LPC1) 1 x Serial General Purpose Input/Output connector for LSI MegaRAID SATA LED (6-1 pin SGPIO1) 1 x System panel connector (20 pin PANEL1) 1 x Auxiliary panel connector (20 pin AUX-PANEL1) SSI power connectors (24-pin, 8-pin, and 4-pin) CPU (x2), rear (x2), front (x4), and FB-DIMM (x1) fan connectors <i>(DSBF-DE/SAS model only)</i> 2 x Mini-SAS connectors support a total of 8 devices 1 x SAS LSI1068 port LED connector (18-1 pin SASLED1)
Power requirement	SSI power supply (with 24-pin/4-pin/8-pin 12V plugs) for LGA771-socket Intel® Xeon Dual Core processors (Glidewell platform)
Form factor	SSI EEB form factor: 12 in x 13 in (30.5 cm x 33 cm)
Support CD contents	Device drivers ASUS Update Utility ASUS Server Web-based Management (ASWM) ADOBE Acrobat Reader ASUS Screen Saver ASUS Flash utility under DOS

*Specifications are subject to change without notice.

This chapter describes the motherboard features and the new technologies it supports.

1 Product introduction

Chapter summary

1

1.1	Welcome!	1-1
1.2	Package contents.....	1-1
1.3	Special features.....	1-2

1.1 Welcome!

Thank you for buying an ASUS® DSBF-DE series motherboard!

The motherboard delivers a host of new features and latest technologies, making it another standout in the long line of ASUS quality motherboards!

Before you start installing the motherboard, and hardware devices on it, check the items in your package with the list below.

1.2 Package contents

Check your motherboard package for the following items.

		DSBF-DE series Retail Pack	DSBF-DE series Bulk Pack
Cables	SATA signal cable	6	--
	SATA power cable	3	--
	SAS cable (DSBF-DE/SAS only)	2	--
	3-in-1 cable set	1	--
Accessories	IO shield	1	1
Application CDs	Support CD	1	1
Documentation	User Guide	1	1
Packing Qty.		3pcs per carton	10pcs per carton



If any of the above items is damaged or missing, contact your retailer.

1.3 Special features

1.3.1 Product highlights

Latest processor technology



The motherboard comes with two LGA-771 sockets that support Dual-Core Intel® Xeon™ processors with 1333/1066/667 MHz Front Side Bus (FSB). Dual-core processors contain two physical CPU cores to meet demands for more powerful processing. Intel® Xeon™ processors incorporate the Intel® Hyper-Threading Technology and Extended Memory 64-bit Technology (EM64T). The EM64T enables the support for 64-bit operation system, such as 64-bit Windows® and Linux. See page 2-10 for details.

Intel® 5000P and Intel® 6321ESB chipset

The Intel® 5000P Memory Controller Hub (MCH) and the Intel® 6321ESB provide the vital interfaces for the motherboard.

The MCH provides the processor, quadri-channel FB-DIMM memory support, and PCI Express interfaces. The Intel® 6321ESB is a new generation server class I/O controller hub that provides the interface for PCI 2.3, PCI Express, and PCIX.

Intel® EM64T



The motherboard supports Intel® processors with the Intel® EM64T (Extended Memory 64 Technology). The Intel® EM64T feature allows your computer to run on 64-bit operating systems and access larger amounts of system memory for faster and more efficient computing.

Enhanced Intel SpeedStep® Technology (EIST)

The Enhanced Intel SpeedStep® Technology (EIST) intelligently manages the CPU resources by automatically adjusting the CPU voltage and core frequency depending on the CPU loading and system speed or power requirement.

FB-DIMM memory support

This motherboard supports fully buffered DIMMs (FB-DIMMs), the latest memory solution that extends memory capacity and provide high-speed, high-density system memory performance. FB-DIMMs use Advanced Memory Buffer (AMB) chips that transmit signals between the memory modules and controllers with improved signal integrity and reduced errors. See page 2-15 for details.

PCI Express™ interface

The motherboard fully supports PCI Express, the latest I/O interconnect technology that speeds up the PCI bus. PCI Express features point-to-point serial interconnections between devices and allows higher clockspeeds by carrying data in packets. This high speed interface is software compatible with existing PCI or PCI-X specifications. See page 2-27 for details.

Serial Attached SCSI (SAS) technology support (DSBF-DE/SAS model only)

SAS is the latest storage interface for enterprise-class storage devices. Building on and improving the parallel SCSI foundation, SAS is the new industry standard that includes Serial ATA interoperability, and is projected to be the successor of the Ultra320 SCSI technology. See page 2-38 for the location of the SAS connectors.

Zero-Channel RAID (ZCR) solution (DSBF-DE/SAS model only)

The motherboard comes with a ZCR socket for an optional Zero-Channel RAID card, allowing RAID 0 (striping), RAID 1 (mirroring), RAID 0+1, and RAID 5 configurations. The ZCR capability provides a cost-effective high-performance and added reliability.

82563 LAN solution

The motherboard comes with a dual-port 82563EB network connection to provide a total solution for your networking needs. See page 2-29 for the location of the LAN ports. See section “2.6 Jumpers” for details on Gigabit LAN settings.

Serial ATA II technology

The motherboard supports the Serial ATA II 3 Gb/s technology through 6321ESB Serial ATA interfaces. The Serial ATA II specification provides twice the bandwidth of the current Serial ATA products with a host of new features, including Native Command Queuing (NCQ), Power Management (PM) Implementation Algorithm, and Hot Swap. Serial ATA allows thinner, more flexible cables with lower pin count and reduced voltage requirements. See page 2-37 for details.

USB 2.0 technology

The motherboard implements the Universal Serial Bus (USB) 2.0 specification, dramatically increasing the connection speed from the 12 Mbps bandwidth on USB 1.1 to a fast 480 Mbps on USB 2.0. USB 2.0 is backward compatible with USB 1.1. See pages 2-24 for details.

Temperature, fan, and voltage monitoring

The CPU temperature is monitored by the W83793G chip to prevent overheating and damage. The system fan rotations per minute (RPM) is monitored for timely failure detection. The chip monitors the voltage levels to ensure stable supply of current for critical components. See page 4-29 for details.

Intel® IOAT

Intel® I/O Acceleration Technology (IOAT) is an integrated server platform I/O solution that addresses all segments of the server I/O bottleneck problem using TCP/IP without requiring any modification of existing or future applications.

Intel® IOAT is a system-wide solution that increases CPU efficiency and delivers data to/from applications faster than current server platforms.

1.3.2 Innovative ASUS features

CrashFree BIOS 2

This feature allows you to restore the original BIOS data from the support CD in case when the BIOS codes and data are corrupted. This protection eliminates the need to buy a replacement ROM chip. See page 4-3 for details.

ASUS Smart Fan technology

The ASUS Smart Fan technology smartly adjusts the fan speeds according to the system loading to ensure quiet, cool, and efficient operation. See page 4-31 for details.

ASUS MemCool FB-DIMM Fan Kit (optional)

With this optional fan kit, the platform gets optimal performance and the best possible FB-DIMM thermal environment.

This chapter lists the hardware setup procedures that you have to perform when installing system components. It includes description of the jumpers and connectors on the motherboard.

Hardware information



2.1	Before you proceed	2-1
2.2	Motherboard overview.....	2-2
2.3	Central Processing Unit (CPU)	2-10
2.4	System memory	2-15
2.5	Expansion slots.....	2-24
2.6	Jumpers	2-28
2.7	Switch.....	2-33
2.8	Connectors	2-34

2.1 Before you proceed

Take note of the following precautions before you install motherboard components or change any motherboard settings.



- Unplug the power cord from the wall socket before touching any component.
- Use a grounded wrist strap or touch a safely grounded object or a metal object, such as the power supply case, before handling components to avoid damaging them due to static electricity.
- Hold components by the edges to avoid touching the ICs on them.
- Whenever you uninstall any component, place it on a grounded antistatic pad or in the bag that came with the component.
- Before you install or remove any component, ensure that the power supply is switched off or the power cord is detached from the power supply. Failure to do so may cause severe damage to the motherboard, peripherals, and/or components.

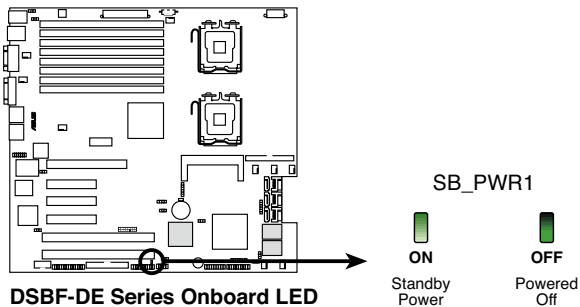

If the ATX12V2 connector is not connected, the REAR_FAN1/2, FRNT_FAN1/2/3/4, and FBD_FAN1 will not work.

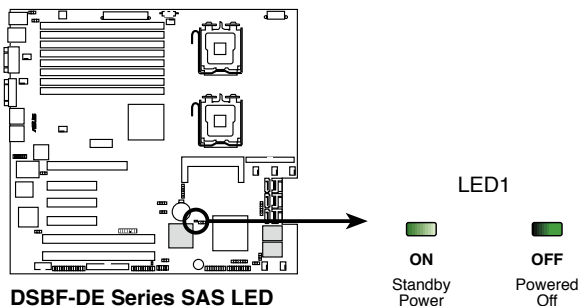

This LED is for DSBF-DE/SAS model only, indicating that if the LSI SAS1068 chipset is working normally.

2.2 Motherboard overview

Before you install the motherboard, study the configuration of your chassis to ensure that the motherboard fits into it.

To optimize the motherboard features, we highly recommend that you install it in an SSI EEB 3.61 compliant chassis.



Make sure to unplug the chassis power cord before installing or removing the motherboard. Failure to do so can cause you physical injury and damage motherboard components!

2.2.1 Placement direction

When installing the motherboard, make sure that you place it into the chassis in the correct orientation. The edge with external ports goes to the rear part of the chassis as indicated in the image below.

2.2.2 Screw holes

Place nine (9) screws into the holes indicated by circles to secure the motherboard to the chassis.



Do not overtighten the screws! Doing so can damage the motherboard.

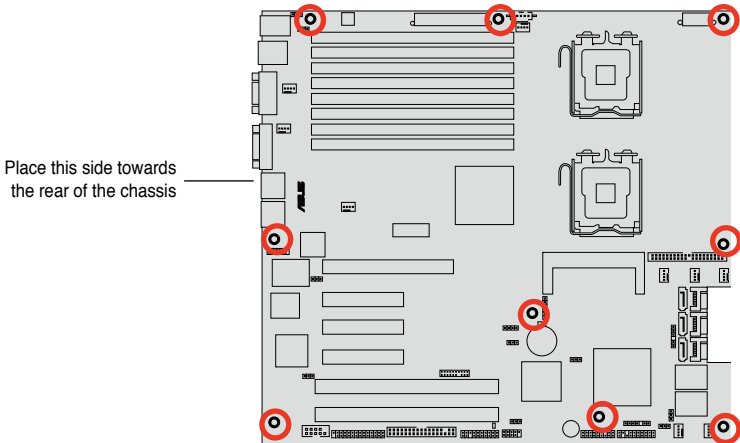

2.2.3 Support kits for the motherboard

For additional protection from motherboard breakage due to the weight of the CPU heatsinks, your motherboard package comes with CEK springs that you can use as weight support. Install the CEK springs before installing the motherboard.



If your chassis is SSI EEB 3.61 compliant, we recommend that you use the CEK springs; otherwise, use the support plates kit.

Each CEK spring has four hooks to match the designated holes around the CPU area.

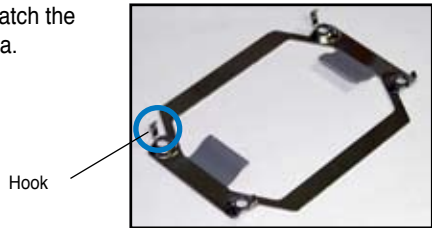

To install the CEK spring:

1. Locate the CPU heatsink holes on the motherboard.

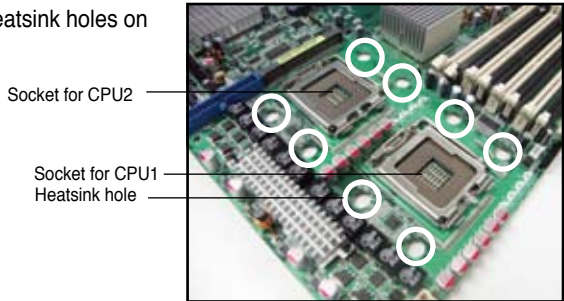

2. Position the CEK spring underneath the motherboard, then match the CEK spring hooks to the CPU1 heatsink holes.



3. Press the upper spring hooks inward, then insert to the upper CPU heatsink holes until they snap in place.



4. Press the lower spring clips inward, then insert to the lower CPU heatsink holes until they snap in place.

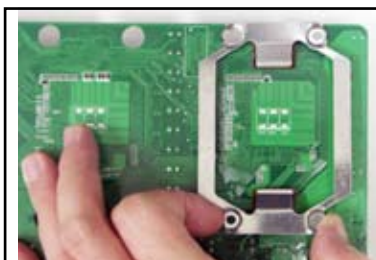

5. If you installed a second CPU, repeat steps 2 to 4 to install the CEK spring to the CPU2 heatsink holes. The CEK springs appear as shown when installed.

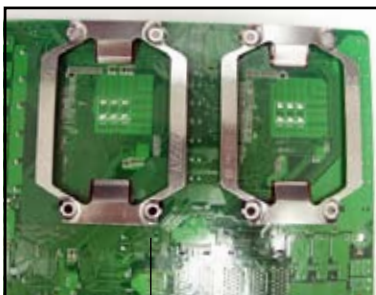

CEK spring screw hole

6. Before installing the motherboard into the chassis, locate the standoffs that should match the eight (8) CEK spring screw holes.

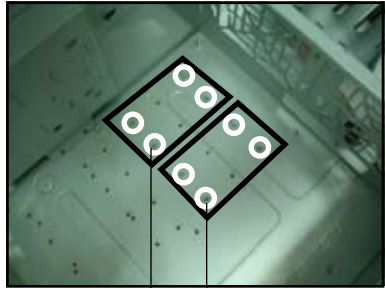

Standoffs for CPU1

Standoffs for CPU2

7. Install the motherboard with the external I/O ports toward the chassis rear panel. The CPU sockets should be right on top of their respective standoffs.

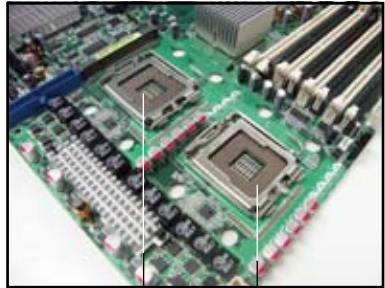

Socket for CPU2

Socket for CPU1



Make sure that the standoffs perfectly match the CEK spring screw holes; otherwise, you can not install the CPU heatsinks properly.

8. Secure the motherboard with nine (9) screws. Refer to section “2.2.2 Screw holes” for illustration.

2.2.4 Motherboard layouts

DSBF-DE/SAS model

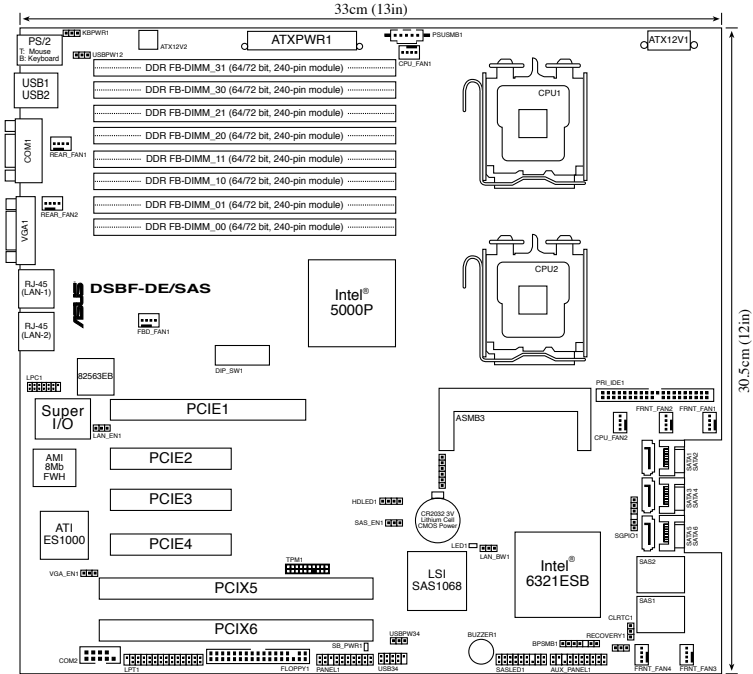

DSBF-DE model

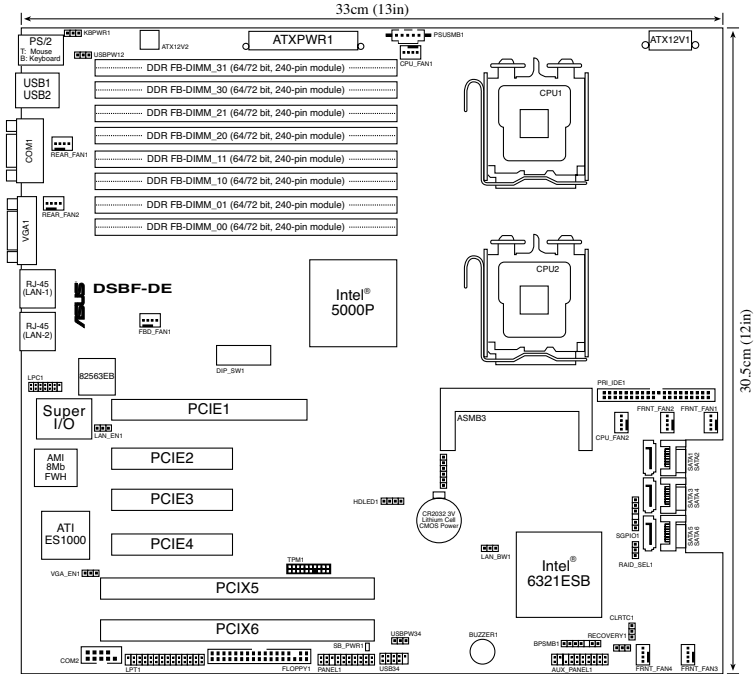

2.2.5 Layout contents

Slots/Socket	Page
1. CPU sockets	2-10
2. FB-DIMM sockets	2-15
3. PCI/PCI-X slots	2-26
4. DDR2 SODIMM socket	2-26
5. PCI Express x16 slot	2-27
6. PCI Express x 8 slot	2-27

Jumpers	Page
1. Clear RTC RAM (CLRTC)	2-28
2. LAN controller setting (3-pin LAN1_EN1)	2-29
3. USB device wake-up (3-pin USBPW12, USBPW34)	2-29
4. Keyboard power (3-pin KBPWR1)	2-30
5. Intel® 6321ESB SATA port S/W RAID setting (3-pin RAID_SEL1) (<i>DSBF-DE model only</i>)	2-30
6. Onboard storage setting (3-pin SAS_EN1) (<i>For DSBF-DE/SAS model only</i>)	2-31
7. LAN bandwidth setting (3-pin LAN_BW1)	2-31
8. VGA controller setting (3-pin VGA_EN1)	2-32
9. Force BIOS recovery setting (3-pin RECOVERY1)	2-32

Switch	Page
1. DIP switches (DIP_SW1)	2-33

Rear panel connectors	Page
1. PS/2 mouse port (green)	2-34
2. PS/2 keyboard port (purple)	2-34
3. USB 2.0 ports 1/2	2-34
4. Serial port	2-34
5. Video Graphics Adapter (VGA) port	2-34
6. LAN (RJ-45) ports	2-34

Internal connectors		Page
1.	Floppy disk drive connector (34-1 pin FLOPPY1)	2-35
2.	IDE connector (40-1 pin PRI_IDE1)	2-35
3.	Serial ATA connectors (7-pin SATA1, SATA2, SATA3, SATA4, SATA5, SATA6)	2-36
4.	Hard disk activity LED connector (4-pin HDLED1)	2-36
5.	Mini-SAS connectors (<i>DSBF-DE/SAS model only</i>)	2-37
6.	SAS LSI1068 port LED connector (18-1 pin SASLED1) (<i>DSBF-DE/SAS model only</i>)	2-38
7.	Serial General Purpose Input/Output connector (6-1 pin SGPIO1)	2-38
8.	Backplane SMBus connector (7-1 pin BPSMB1)	2-39
9.	Serial port connectors (10-1 pin COM2)	2-39
10.	CPU and system fan connectors (4-pin CPU_FAN1/2, REAR_FAN1/2, FRNT_FAN1/2/3/4, FBD_FAN1)	2-40
11.	Power supply SMBus connector (5-pin PSUSMB1)	2-40
12.	SSI power connectors (24-pin ATXPWR1, 8-pin ATX12V1, 4-pin ATX12V2)	2-41
13.	Parallel port connector (26-1 pin LPT1)	2-42
14.	TPM connector (20-1 pin TPM)	2-42
15.	LPC debug card connector (14-1 pin LPC1)	2-43
16.	Auxiliary panel connector (20-pin AUX_PANEL1)	2-43
17.	System panel connector (20-1 pin PANEL1)	2-44

2.3 Central Processing Unit (CPU)

The motherboard comes with a surface mount LGA771 socket designed for the Intel® Xeon® Dual Core processor.



- Your boxed Intel® Xeon® LGA771 processor package should come with installation instructions for the CPU and heatsink. If the instructions in this section do not match the CPU documentation, follow the latter.
- Upon purchase of the motherboard, make sure that the PnP cap is on the socket and the socket contacts are not bent. Contact your retailer immediately if the PnP cap is missing, or if you see any damage to the PnP cap/socket contacts/motherboard components. ASUS will shoulder the cost of repair only if the damage is shipment/transit-related.
- Keep the cap after installing the motherboard. ASUS will process Return Merchandise Authorization (RMA) requests only if the motherboard comes with the cap on the LGA771 socket.
- The product warranty does not cover damage to the socket contacts resulting from incorrect CPU installation/removal, or misplacement/loss/incorrect removal of the PnP cap.

2.3.1 Installing the CPU

To install a CPU:

1. Locate the CPU socket on the motherboard.

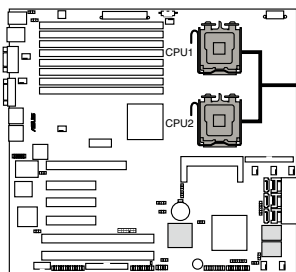

DSBF-DE Series CPU LGA771



Before installing the CPU, make sure that the socket box is facing towards you and the load lever is on your left.

2. Press the load lever with your thumb (A), then move it to the left (B) until it is released from the retention tab.

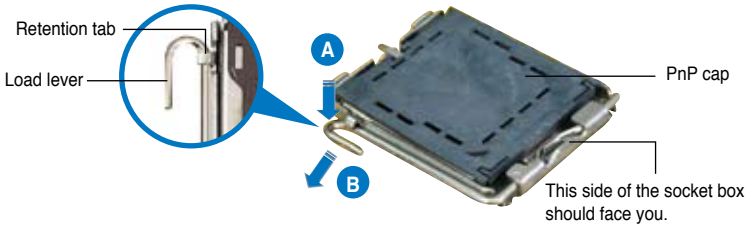

To prevent damage to the socket pins, do not remove the PnP cap unless you are installing a CPU.

3. Lift the load lever in the direction of the arrow to a 135° angle.

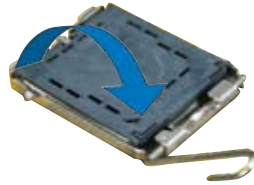

4. Lift the load plate with your thumb and forefinger to a 100° angle (A), then push the PnP cap from the load plate window to remove (B).

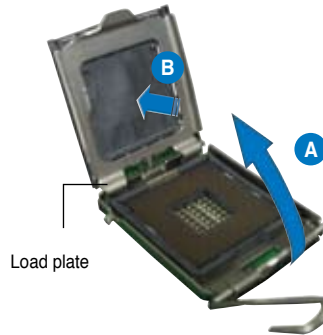

5. Position the CPU over the socket, making sure that the gold triangle is on the bottom-left corner of the socket. The socket alignment key should fit into the CPU notch.

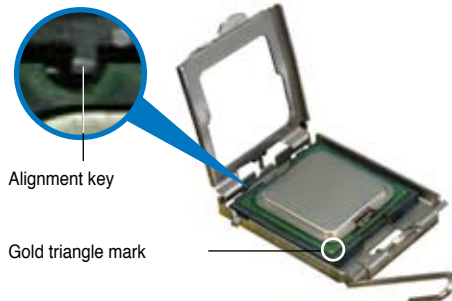

6. Close the load plate (A), then push the load lever (B) until it snaps into the retention tab.

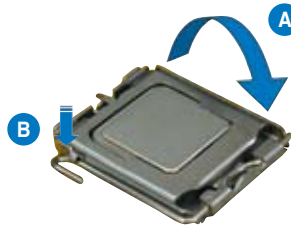

The CPU fits in only one correct orientation. DO NOT force the CPU into the socket to prevent bending the connectors on the socket and damaging the CPU!

Notes on Intel® Hyper-Threading Technology



- This motherboard supports Intel® Xeon™ CPUs in the 771-land package with Hyper-Threading Technology.
- Hyper-Threading Technology is supported by Intel® 5000 series CPU only. 5100 series DO NOT support Hyper-Threading.
- Hyper-Threading Technology is supported under Windows® XP/2003 Server and Linux 2.4.x (kernel) and later versions only. Under Linux, use the Hyper-Threading compiler to compile the code. If you are using any other operating systems, disable the Hyper-Threading Technology item in the BIOS to ensure system stability and performance.
- Installing Windows® 2003 Server or later version is recommended.
- Make sure to enable the Hyper-Threading Technology item in BIOS before installing a supported operating system.
- For more information on Hyper-Threading Technology, visit www.intel.com/info/hyperthreading.

To use the Hyper-Threading Technology on this motherboard:

1. Install an Intel® Xeon™ CPU that supports Hyper-Threading Technology.
2. Power up the system and enter the BIOS Setup (see Chapter 4: BIOS setup). Under the Advanced Menu, make sure that the item Hyper-Threading Technology is set to Enabled. The item appears only if you installed a CPU that supports Hyper-Threading Technology.
3. Reboot the computer.

2.3.2 Installing the CPU heatsink and fan

The Intel® Xeon™ processors require an Intel certified heatsink and fan assembly to ensure optimum thermal condition and performance.

When you buy a boxed Intel CPU, the package includes the heatsink, fan, retention brackets, screws, thermal grease, installation manual, and other items that are necessary for CPU installation.



- Make sure that you have applied the thermal grease to the top of the CPU before installing the heatsink and fan.
- Refer to the installation manual that came with the CPU package for details on heatsink/fan assembly and installation.

CPU heatsink (top view)



CPU heatsink (bottom view)

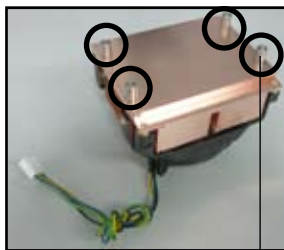

Heatsink screw



Before installing the CPU heatsinks, ensure that the jumpers DIP_SW1 are set correctly depending on the pin definition of your CPU fan cables. Refer to page 2-19 for information on these jumpers.

To install the CPU heatsink and fan:

1. Place the heatsink on top of the installed CPU, making sure that the four screws on the heatsink align with the nuts on the support plate.



2. Use a Phillips screwdriver to tighten the four heatsink screws in a diagonal sequence.

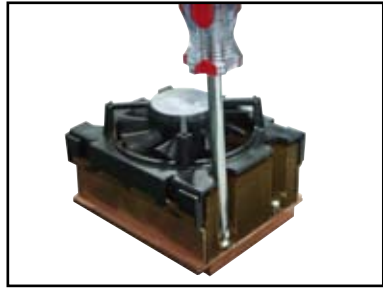

3. Connect the fan cable to the 4-pin connector labeled CPU_FAN1.



Do not forget to connect the CPU fan cable! Hardware monitoring errors may occur if you fail to plug this connector.

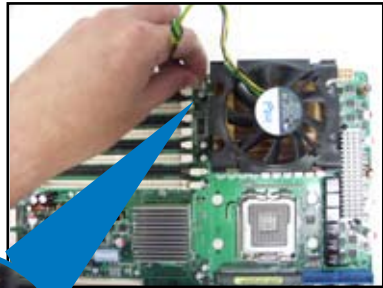

CPU_FAN1
connector

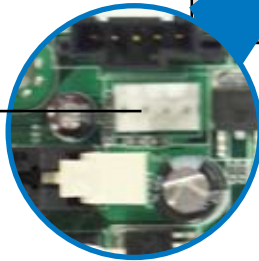

4. Repeat steps 1 to 3 to install the other heatsink if you have installed a second CPU, then connect the fan cable to the 4-pin connector labeled CPU_FAN2.

2.4 System memory

2.4.1 Overview

The motherboard comes with eight fully-buffered DIMM (FB-DIMM) sockets to support 240-pin FB-DIMM modules. An FB-DIMM module has a different pin-out from DDR2 DIMMs so you cannot install DDR2 DIMMs on an FB-DIMM socket. Note that an FB-DIMM socket has an Advanced Memory Buffer (AMB) chip that allows memory-to-CPU connection at gigabit speed.

The figure illustrates the location of the FB-DIMM sockets:

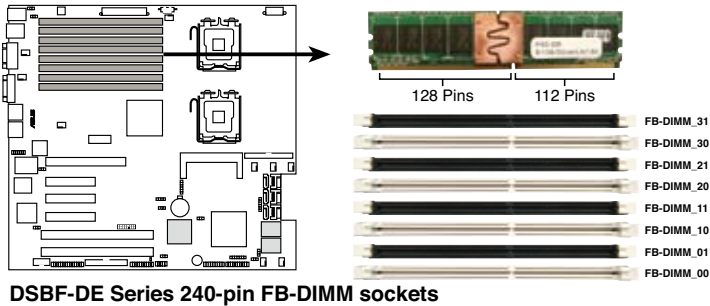

2.4.2 Memory configurations

You may install 256 MB, 512 MB, 1 GB, 2 GB, and 4 GB registered ECC FB-DIMMs into the DIMM sockets.



- For optimum compatibility, we recommend that you obtain memory modules from the same vendor. Refer to the Qualified Vendors List on the ASUS web site.
- This motherboard does not support memory modules made up of 128 Mb chips x16 memory modules.
- If you are installing only one memory module, install into the white socket labeled DIMM_00. Installing into any other socket will not work.

Rank population

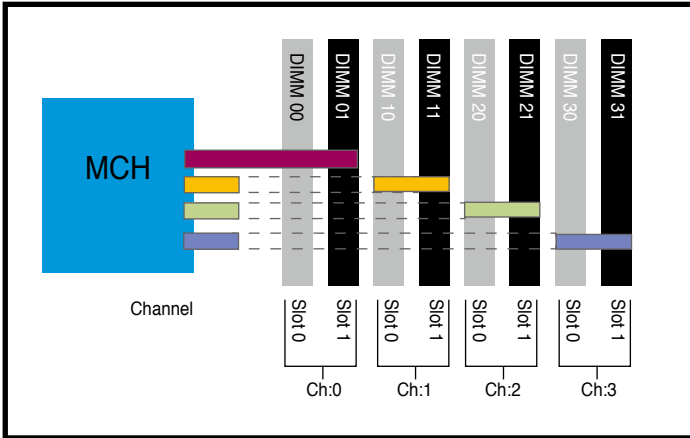

DIMM installation reference table

No.. of DIMMs	Slot(s) to use
1	DIMM_00
2	DIMM_00, DIMM_10
4	DIMM_00, DIMM_10, DIMM_20, DIMM_30
6	DIMM_00, DIMM_10, DIMM_20, DIMM_30 DIMM_01, DIMM_11
8	DIMM_00, DIMM_10, DIMM_20, DIMM_30 DIMM_01, DIMM_11, DIMM_21, DIMM_31



DIMMs in pair means two DIMMs with the same configuration.

2.4.3 Memory mirroring and sparing technology

The Intel® 5000P chipset supports the memory mirroring and sparing technology. Refer to the below sections:

Memory Mirroring:

When enabling memory mirroring function in the BIOS setting (please refer the section 4.4.2 Chipset Configuration and configure the option “Memory Branch Mode” as Mirror), Branch 1 contains a replicate copy of the data in Branch 0. The DIMMs must cover the same slot position on both branches. DIMMs that cover a slot position must be identical with respect to size, speed, and organization. DIMMs within a slot position must match each other, but aren’t required to match adjacent slot positions.

And the total memories size will be the half of all installed memories.

The below two memory configurations were required to operate in mirrored mode.

1. Configuration 1 (Mirroring): **Four memories population**

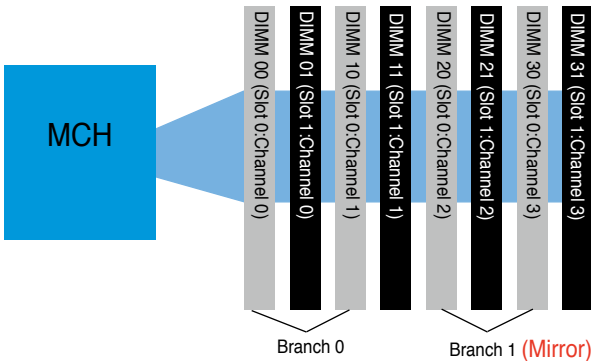

2. Configuration 2 (Mirroring) : **Eight memories population**

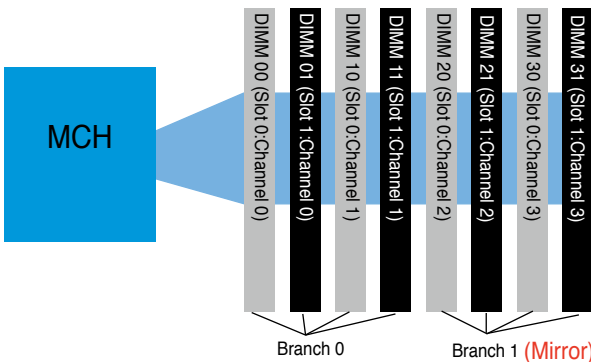

Memory Sparing :

At configuration time, a DIMM rank is set aside to replace a defective DIMM rank. When the error rate for a failing DIMM rank reaches a pre-determined threshold, the memory sparing function will issue an interrupt and initiate a spare copy. At the completion of the copy, the failing DIMM rank is disabled and the “spared” DIMM rank will be used in its place. Refer to **4.4.2 Chipset Configuration and configure the options of “Branch 0 Rank Sparing”** to enable the memory sparing functions. And the default BIOS setting is disabled.



- Each branch contains its own sparing engine and can be enabled or disabled separately.
- This motherboard does not support rank sparing across branches.
- This motherboard does not support rank sparing when in mirror mode.
- The DIMM rank with the largest size will be assigned as spare rank. Data can only be copied from a smaller sized rank to a larger sized one.
- A DIMM can contain only one or two ranks. To support sparing function, a DIMM channel should contain at least two ranks.
- When sparing function is enabled, the usable memory size will reduce then size of the spare ranks.

The following tables show memory configurations with Memory Sparing function in Branch 0.

One DIMM per channel (Dual ranks)

Branch0	Channel 0		Channel 1	
	DIMM_00 (2048MB/2 Ranks)		DIMM_10 (2048MB/2 Ranks)	
	Rank 0 (1024 MB)	Rank 1 (1024 MB)	Rank 0 (1024 MB)	Rank 1 (1024 MB)
Sparing		V		V
Memory space	1024 MB		1024 MB	
Total Memory	2048 MB			

Two DIMM per channel (Dual ranks)

		Channel 0		Channel 1		
		DIMM_00 (1024MB/2 Ranks)		DIMM_10 (1024MB/2 Ranks)		
Branch0		Rank 0 (512 MB)	Rank 1 (512 MB)	Rank 0 (512 MB)	Rank 1 (512 MB)	
	Sparing					
	Memory space	512 MB	512 MB	512 MB	512 MB	
			DIMM_01 (2048MB/2 Ranks)		DIMM_11 (2048MB/2 Ranks)	
			Rank 0 (1024 MB)	Rank 1 (1024 MB)	Rank 0 (1024 MB)	Rank 1 (1024 MB)
	Sparing			V		V
	Memory space	1024 MB			1024 MB	
	Total Memory	4096 MB				

Two DIMM per channel (Single rank)

		Channel 0		Channel 1		
		DIMM_00 (512MB/1 Ranks)		DIMM_10 (512MB/1 Ranks)		
Branch0		Rank 0 (512 MB)		Rank 0 (512 MB)		
	Sparing					
	Memory space	512 MB		512 MB		
			DIMM_01 (1024MB/1 Ranks)		DIMM_11 (1024MB/1 Ranks)	
		Rank 0 (1024 MB)		Rank 0 (1024 MB)		
	Sparing	V		V		
	Memory space					
	Total Memory	1024 MB				

2.4.4 Installing a DIMM



Make sure to unplug the power supply before adding or removing DIMMs or other system components. Failure to do so may cause severe damage to both the motherboard and the components.

To install a DIMM:

1. Unlock a DIMM socket by pressing the retaining clips outward.
2. Align a DIMM on the socket such that the notch on the DIMM matches the break on the socket.
3. Firmly insert the DIMM into the socket until the retaining clips snap back in place and the DIMM is properly seated.

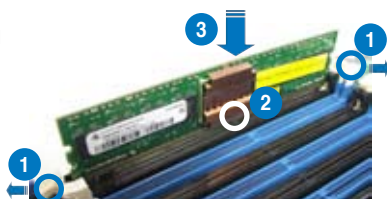

FB-DIMM notch



- A FB-DIMM is keyed with a notch so that it fits in only one direction. Do not force a DIMM into a socket to avoid damaging the DIMM.
- The sockets do not support DDR/DDR2 DIMMs. DO NOT install DDR/DDR2 DIMMs to the FB-DIMM sockets.

2.4.5 Removing a DIMM

To remove a DIMM:

1. Simultaneously press the retaining clips outward to unlock the DIMM.



Support the DIMM lightly with your fingers when pressing the retaining clips. The DIMM might get damaged when it flips out with extra force.

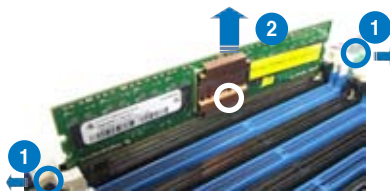

2. Remove the DIMM from the socket.

2.4.6 Installing the MemCool FB-DIMM fan (optional)

The FB-DIMMs generate heat during continued operation. To ensure optimum thermal condition and performance, install the optional MemCool FB-DIMM fan.

To install the optional FB-DIMM fan:

1. Locate the three FB-DIMM fan holes on the motherboard.

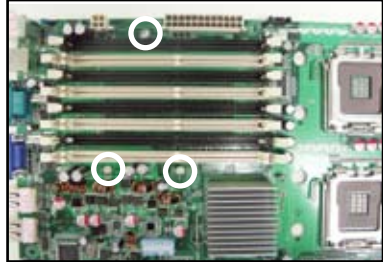

2. Disengage the fan top cover from the fan base. You can do this by firmly gripping the top cover by the clamps to release the hooks, then pull up the top cover carefully until it separates from the fan base.



Do not remove the fan from the fan base.

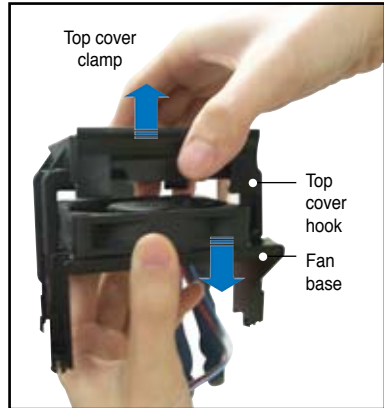

3. Position the fan base over the DIMMs, and insert the fan base legs into the FB-DIMM holes until the legs are securely in place.

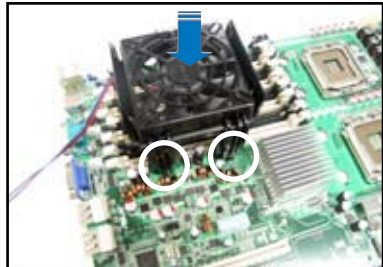

- For instructional purposes only, no FB-DIMM is installed on any of the slots.
- For 2U or above models, we suggest you to install MemCool FB-DIMM fan for better cooling effect and system performance.

4. Position top cover over the fan base. Insert the top cover legs into the slot on the fan base legs. Push down carefully until the legs are securely in place and the top cover hooks snap in place.

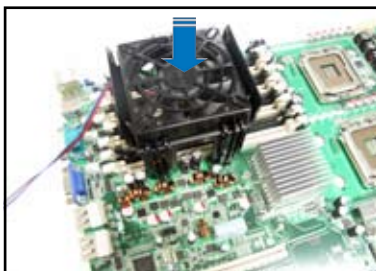

Make sure the cables pass through the notch on the fan base as shown.

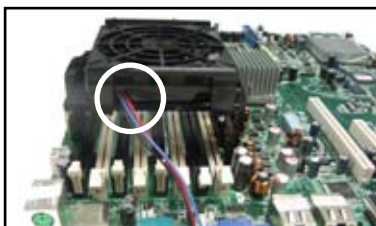

5. Connect the fan cable to the black 4-pin connector labeled FBD_FAN1.

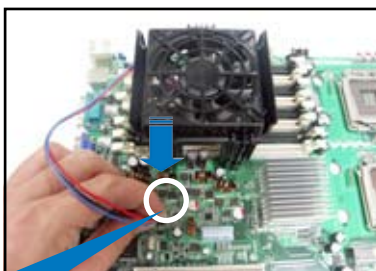

2.4.7 Uninstalling the optional MemCool FB-DIMM fan

1. Unplug the fan cable.

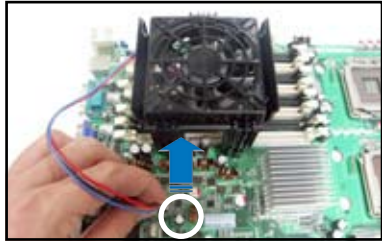

2. Grip the top cover clamps until the top cover hooks are released, then carefully lift the top cover while supporting the fan base with your free hand.

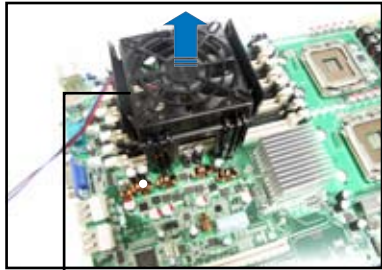

Top cover
clamp

3. Carefully lift the fan base.

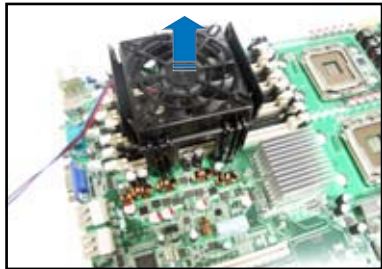

2.5 Expansion slots

In the future, you may need to install expansion cards. The following sub-sections describe the slots and the expansion cards that they support.



Make sure to unplug the power cord before adding or removing expansion cards. Failure to do so may cause you physical injury and damage motherboard components.

2.5.1 Installing an expansion card

To install an expansion card:

1. Before installing the expansion card, read the documentation that came with it and make the necessary hardware settings for the card.
2. Remove the system unit cover (if your motherboard is already installed in a chassis).
3. Remove the bracket opposite the slot that you intend to use. Keep the screw for later use.
4. Align the card connector with the slot and press firmly until the card is completely seated on the slot.
5. Secure the card to the chassis with the screw you removed earlier.
6. Replace the system cover.

2.5.2 Configuring an expansion card

After installing the expansion card, configure the it by adjusting the software settings.

1. Turn on the system and change the necessary BIOS settings, if any. See Chapter 4 for information on BIOS setup.
2. Assign an IRQ to the card. Refer to the tables on the next page.
3. Install the software drivers for the expansion card.



When using PCI cards on shared slots, ensure that the drivers support “Share IRQ” or that the cards do not need IRQ assignments. Otherwise, conflicts will arise between the two PCI groups, making the system unstable and the card inoperable.

2.5.3 Interrupt assignments

Standard interrupt assignments

IRQ	Priority	Standard Function
0	1	System Timer
1	2	Keyboard Controller
2	—	Re-direct to IRQ#9
3	11	Communications Port (COM2)*
4	12	Communications Port (COM1)*
5	13	IRQ holder for PCI steering*
6	14	Floppy Disk Controller
7	15	Printer Port (LPT1)*
8	3	System CMOS/Real Time Clock
9	4	IRQ holder for PCI steering*
10	5	IRQ holder for PCI steering*
11	6	IRQ holder for PCI steering*
12	7	PS/2 Compatible Mouse Port*
13	8	Numeric Data Processor
14	9	Primary IDE Channel
15	10	Secondary IDE Channel

* These IRQs are usually available for ISA or PCI devices.

2.5.4 PCI/PCI-X slots

The PCI/PCI-X slots support cards such as a LAN card, SCSI card, USB card, and other cards that comply with PCI 2.3 and PCI-X 1.0 specifications. The figure shows a LAN card installed on a PCI slot.

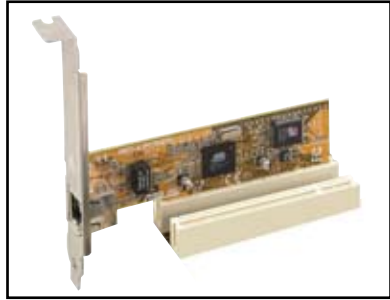

32-bit PCI slot

The figure shows a RAID card installed on a PCI-X slot.



64-bit PCI-X slot



When installing an optional ZCR card, install the card on PCIX6 slot (colored green on DSBF-DE/SAS model)

2.5.5 DDR2 SODIMM socket

The DDR2 SODIMM socket on the motherboard supports an ASUS® Server Management Board 3 Series (ASMB3).

DDR2 SO-DIMM socket



2.5.6 PCI Express x16 slot (x8 link)

This motherboard supports PCI Express cards that comply with the PCI Express specifications.

PCI Express x16 slot (x8link)



2.5.7 PCI Express x8 slots (x8 link; x4 link)

The onboard PCI Express x8 slots provide x8 link and x4 link from the 6321ESB. This slot is designed for various server class high performance add-on cards like SCSI RAID card, fiber-channel card, etc.

PCI Express x8 slot (x8 link)

PCI Express x8 slot (x4 link)



2.6 Jumpers

1. Clear RTC RAM (CLRTC1)

This jumper allows you to clear the Real Time Clock (RTC) RAM in CMOS. You can clear the CMOS memory of date, time, and system setup parameters by erasing the CMOS RTC RAM data. The onboard button cell battery powers the RAM data in CMOS, which include system setup information such as system passwords.

To erase the RTC RAM:

1. Turn OFF the computer and unplug the power cord.
2. Remove the onboard battery.
3. Move the jumper cap from pins 1-2 (default) to pins 2-3. Keep the cap on pins 2-3 for about 5~10 seconds, then move the cap back to pins 1-2.
4. Reinstall the battery.
5. Plug the power cord and turn ON the computer.
6. Hold down the key during the boot process and enter BIOS setup to re-enter data.



Except when clearing the RTC RAM, never remove the cap on CLRTC jumper default position. Removing the cap will cause system boot failure!

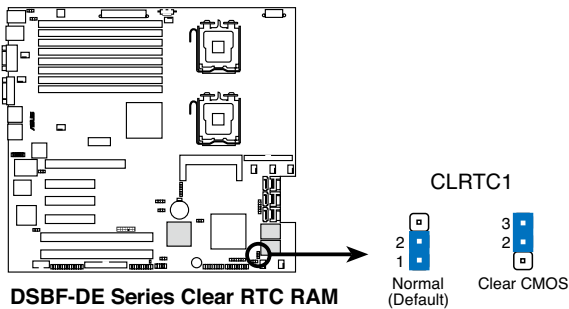

2. LAN controller setting (3-pin LAN_EN1)

This jumper allows you to enable or disable the onboard Intel® 6321 Gigabit LAN controller. Set to pins 1-2 to activate the Gigabit LAN feature.

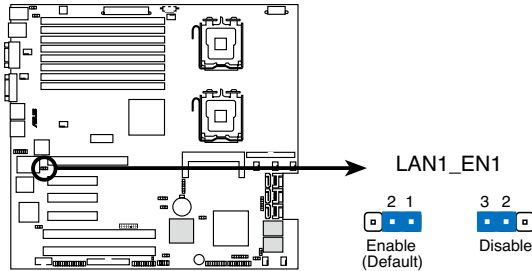

DSBF-DE Series LAN1_EN setting

3. USB device wake-up (3-pin USBPW12, USBPW34)

Set these jumpers to +5V to wake up the computer from S1 sleep mode (CPU stopped, DRAM refreshed, system running in low power mode) using the connected USB devices. Set to +5VSB to wake up from S4 sleep mode (no power to CPU, DRAM, power supply in reduced power mode).

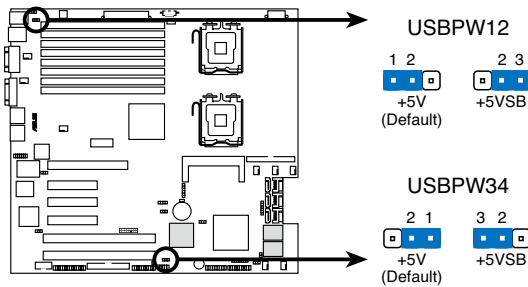

DSBF-DE Series USB device wake up



- The USB device wake-up feature requires a power supply that can provide 500mA on the +5VSB lead for each USB port; otherwise, the system will not power up.
- If you are using Windows® 2000, you need to install Service Pack 4 to wake up the system from S4 sleep mode.
- The total current consumed must NOT exceed the power supply capability (+5VSB) whether under normal condition or in sleep mode.

4. Keyboard power (3-pin KBPWR1)

This jumper allows you to enable or disable the keyboard wake-up feature. Set this jumper to pins 2-3 (+5VSB) to wake up the computer when you press a key on the keyboard (the default is the Spacebar). This feature requires an ATX power supply that can supply at least 1A on the +5VSB lead, and a corresponding setting in the BIOS.

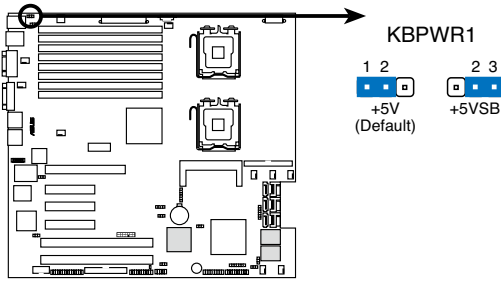

DSBF-DE Series Keyboard power setting

5. Intel® 6321ESB SATA port S/W RAID setting (3-pin RAID_SEL1) (DSBF-DE model only)

This jumper allows you to select the Serial ATA RAID configuration utility to use when you create disk arrays. Both utilities are supported by the Intel® 6321ESB. Place the jumper caps on pins 1-2 if you want to use the LSI MegaRAID Serial ATA RAID utility (default); otherwise, place the jumper caps on pins 2-3 to use the Intel® Matrix Storage Manager (MSM).

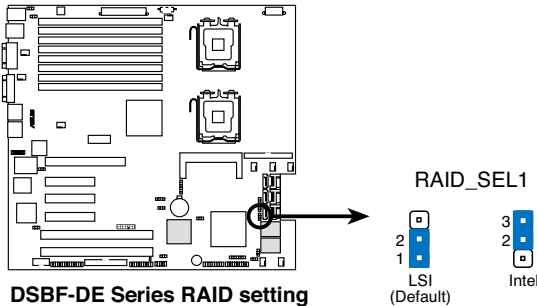

DSBF-DE Series RAID setting

6. Onboard storage setting (3-pin SAS_EN1)

(for DSBF-DE/SAS model only)

This jumper allows you to select the onboard storage to use. Place the jumper caps on pins 1-2 if you want to use the Intel® 6321ESB-supported Ultra DMA/Serial ATA II devices (default); otherwise, place the jumper caps on pins 2-3 to use Serial Attached SCSI (SAS) storage device supported by the LSI1068 PCI-X SAS controller.

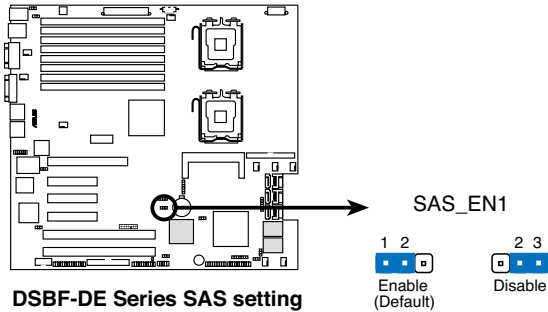

7. LAN bandwidth setting (3-pin LAN_BW1)

This jumper allows you to set the LAN bandwidth setting for more efficient IP load distribution.

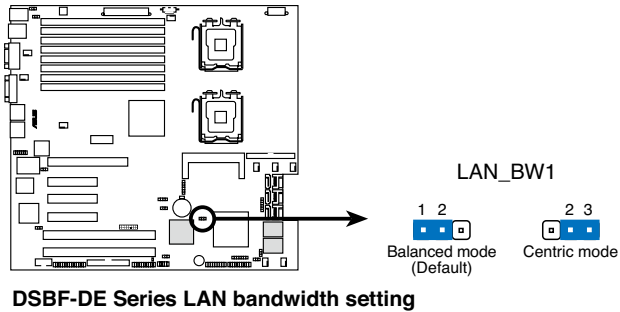

Balance Mode: It's 1 x 8 link between MCH and ESB2;
LAN Central Mode: It's 2 x 4 link between MCH and ESB2.

8. VGA controller setting (3-pin VGA_EN1)

These jumpers allow you to enable or disable the onboard VGA controller. Set to pins 1-2 to activate the VGA feature.

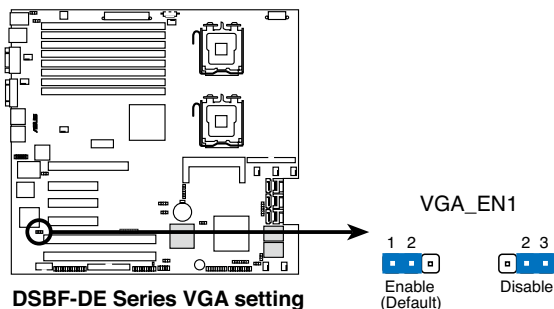

9. Force BIOS recovery setting (3-pin RECOVERY1)

This jumper allows you to quickly update or recover the BIOS settings when it becomes corrupted.

To update the BIOS:

1. Prepare a floppy disk that contains the latest BIOS for the motherboard and the Phoenix Phlash16 utility. Make sure you download the correct BIOS for your motherboard model.
2. Set the jumper to pins 2-3.
3. Insert the floppy disk then turn on the system to update the BIOS.
4. Shut down the system.
5. Set the jumper back to pins 1-2.
6. Turn on the system.

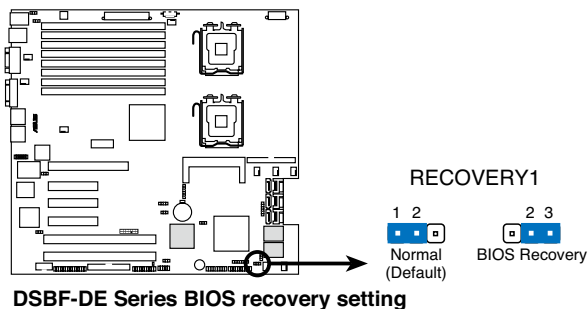

Refer to section "4.1.3 ASUS Crashfree BIOS 2 utility" for more information.

2.7 Switch

1. DIP switches (DIP_SW1)

This jumper allows you to set up the fan connections. Set the switch to ON if you are using a 4-pin fan (PWM mode) cable plug, or to OFF if you are using a 3-pin (PC mode) plug.

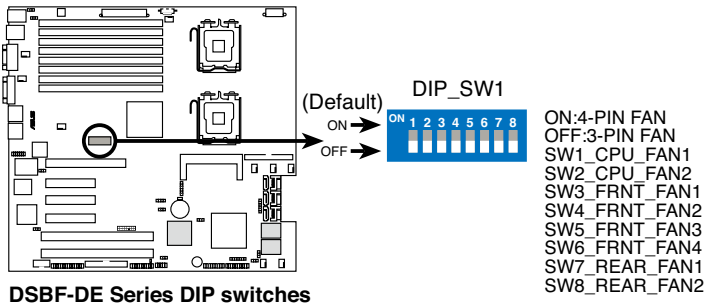

The following table shows the corresponding switch for each fan connector.

Switch	Fan connector
1	CPU_FAN1
2	CPU_FAN2
3	FRNT_FAN1
4	FRNT_FAN2
5	FRNT_FAN3
6	FRNT_FAN4
7	REAR_FAN1
8	REAR_FAN2



- If you use a 4-pin fan but set the DIP switch for a 3-pin fan, the fan you installed may not work.
- If you use a 3-pin fan but set the DIP switch for a 4-pin fan, the fan control will not work and the fan you installed will always run at full speed.

2.8 Connectors

2.8.1 Rear panel connectors

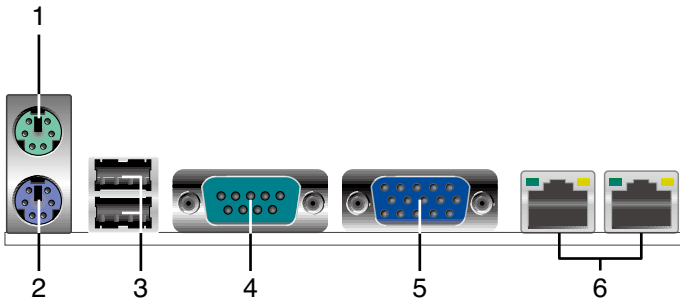

1. **PS/2 mouse port (green).** This port is for a PS/2 mouse.
2. **PS/2 keyboard port (purple).** This port is for a PS/2 keyboard.
3. **USB 2.0 ports 1 and 2.** These 4-pin Universal Serial Bus (USB) ports are available for connecting USB 2.0 devices.
4. **Serial port.** This 9-pin COM1 port is for pointing devices and other serial devices.
5. **Video Graphics Adapter (VGA) port.** This 15-pin port is for a VGA monitor or other VGA-compatible devices.
6. **LAN (RJ-45) ports.** These ports allow Gigabit connection to a Local Area Network (LAN) through a network hub. Refer to the table below for the LAN port LED indications.

LAN port LED indications

ACT/LINK LED		SPEED LED	
Status	Description	Status	Description
OFF	No link	OFF	10 Mbps connection
GREEN	Linked	ORANGE	100 Mbps connection
BLINKING	Data activity	GREEN	1000 Mbps connection

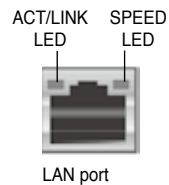

2.8.2 Internal connectors

1. Floppy disk drive connector (34-1 pin FLOPPY1)

This connector is for the provided floppy disk drive (FDD) signal cable. Insert one end of the cable to this connector, then connect the other end to the signal connector at the back of the floppy disk drive.



Pin 5 on the connector is removed to prevent incorrect cable connection when using a FDD cable with a covered Pin 5.

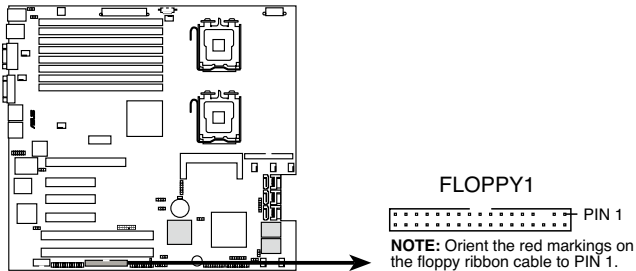

DSBF-DE Series Floppy disk drive connector

2. IDE connector (40-1 pin PRI_IDE1)

This connector is for an Ultra DMA 100/66 signal cable. The Ultra DMA 100/66 signal cable has three connectors: a blue connector for the primary IDE connector on the motherboard, a black connector for an Ultra DMA 100/66 IDE slave device (optical drive/hard disk drive), and a gray connector for an Ultra DMA 100/66 IDE master device (hard disk drive). If you install two hard disk drives, you must configure the second drive as a slave device by setting its jumper accordingly. Refer to the hard disk documentation for the jumper settings.



- Pin 20 on the IDE connector is removed to match the covered hole on the Ultra DMA cable connector. This prevents incorrect insertion when you connect the IDE cable.
- Use the 80-conductor IDE cable for Ultra DMA 100/66 IDE devices.

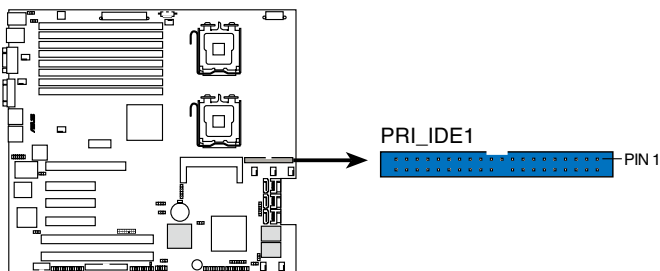

DSBF-DE Series IDE connector

3. Serial ATA connectors (7-pin SATA1-6)

These connectors are for the Serial ATA signal cables for Serial ATA hard disk drives.

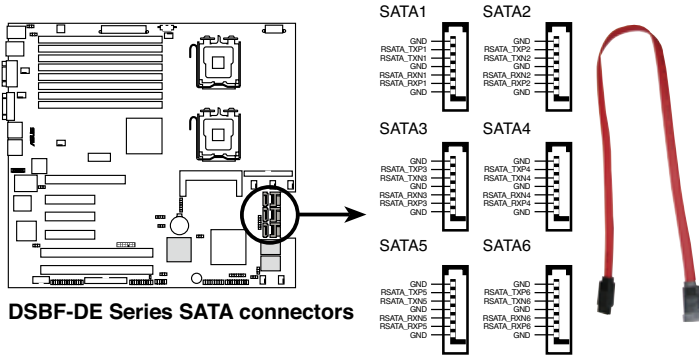

4. Hard disk activity LED connector (4-pin HDLED1)

This connector is used to connect to a hard disk drive active LED connector on the SCSI or RAID card.

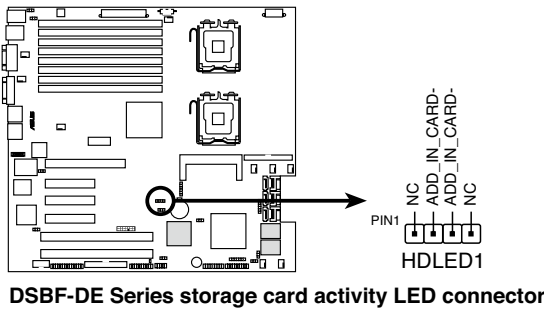

5. Mini-SAS connectors (DSBF-DE/SAS model only)

This motherboard comes with two Serial Attached SCSI (SAS) connectors, the next-generation storage technology that supports both SCSI and Serial ATA. Each connector supports up to four (4) devices.

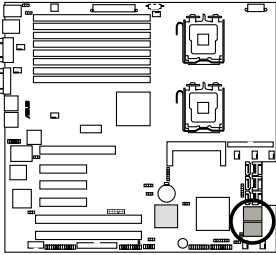

DSBF-DE Series MINI SAS connectors

To connect the mini-SAS cable:

Plug in the mini-SAS cable to the mini-SAS connector until the cable lock snaps in place.

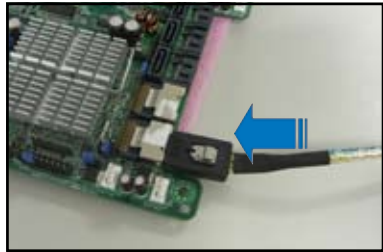

To disconnect the mini-SAS cable:

1. With your thumb, push down the cable lock to release.
2. While still keeping your thumb's grip on the cable lock, carefully pull away the cable from the connector

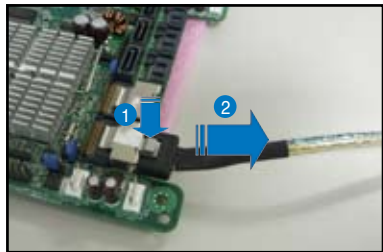

6. SAS LSI1068 ports LED connector (18-1 pin SASLED1)
(DSBF-DE/SAS model only)

This connector is for the front panel LED port indicator that shows the SAS HDD status.

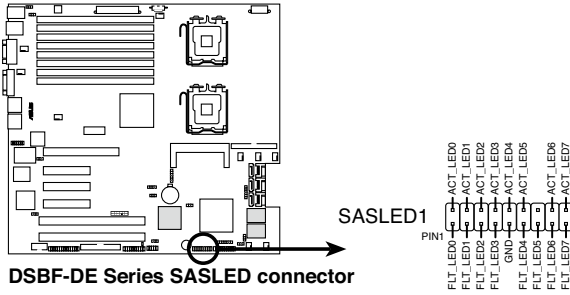

7. Serial General Purpose Input/Output connector (6-1 pin SGPIO1)

This connector is used for the SGPIO peripherals for the LSI MegaRAID SATA LED.

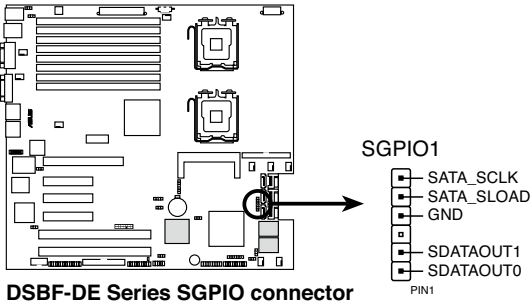

8. Backplane SMBus connector (7-1 pin BPSMB1)

This connector allows you to connect SMBus (System Management Bus) devices. Devices communicate with an SMBus host and/or other SMBus devices using the SMBus interface.

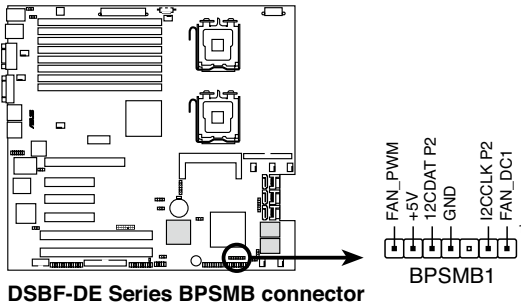

9. Serial port connector (10-1 pin COM2)

This connector is for a serial (COM) port. Connect the serial port module cable to this connector, then install the module to a slot opening at the back of the system chassis.

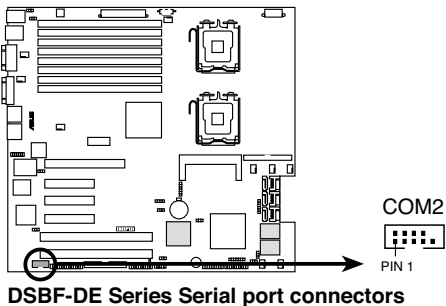

The serial port module is purchased separately.

10. CPU and system fan connectors (4-pin CPU_FAN1/2, REAR_FAN1/2, FRNT_FAN1/2/3/4, FBD_FAN1)

The fan connectors support cooling fans of 350 mA ~ 740 mA (8.88 W max.) or a total of 2.1 A ~ 4.44 A (53.28 W max.) at +12V. Connect the fan cables to the fan connectors on the motherboard, making sure that the black wire of each cable matches the ground pin of the connector.



DO NOT forget to connect the fan cables to the fan connectors. Insufficient air flow inside the system may damage the motherboard components. These are not jumpers! DO NOT place jumper caps on the fan connectors!

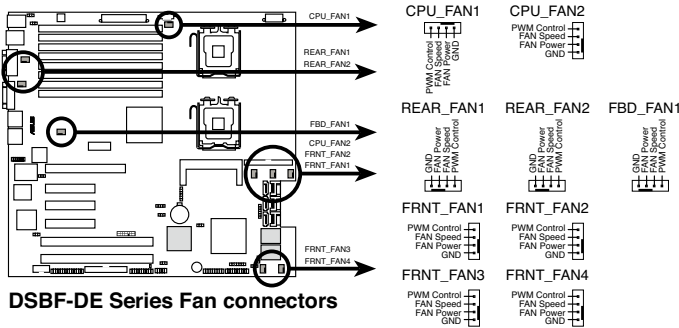

DSBF-DE Series Fan connectors

11. Power supply SMBus connector (5-pin PSUSMB1)

This connector is for the power supply SMB cable, if your power supply supports the SMBus function.

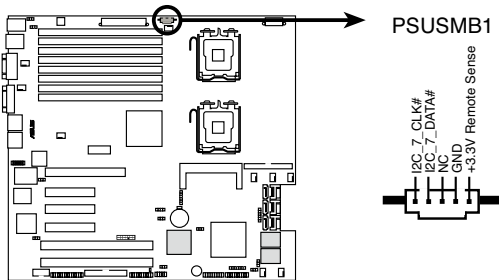

DSBF-DE Series Power supply SMBus connector

12. SSI power connectors (24-pin ATXPWR1, 8-pin ATX12V1, 4-pin ATX12V2)

These connectors are for SSI power supply plugs. The power supply plugs are designed to fit these connectors in only one orientation. Find the proper orientation and push down firmly until the connectors completely fit.



- For a fully configured system, we recommend that you use an SSI 12 V-compliant power supply unit (PSU) for LGA771-socket Intel® Xeon Dual Core processors (Bensley platform).
- DO NOT forget to connect the 24+8+4-pin power plugs; otherwise, the system will not boot up.
- Use of a PSU with a higher power output is recommended when configuring a system with more power consuming devices. The system may become unstable or may not boot up if the power is inadequate.
- You must install a PSU with a higher power rating if you intend to install additional devices.

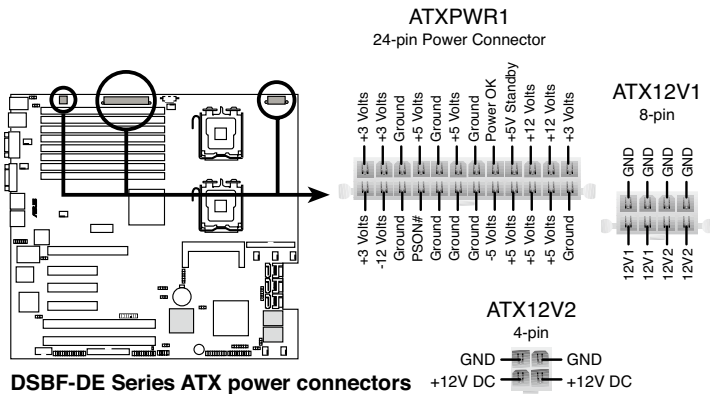

13. Parallel port connector (26-1 pin LPT1)

This connector is for a parallel port. Connect the parallel port module cable to this connector, then install the module to a slot opening at the back of the system chassis.

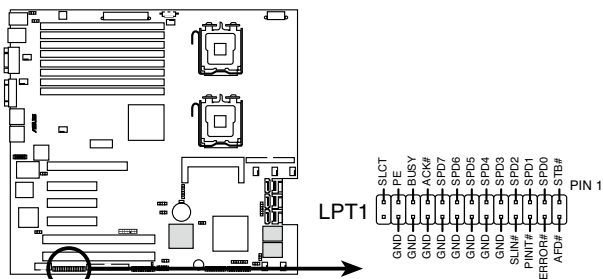

DSBF-DE Series Parallel port connector

14. TPM connector (20-1 pin TPM)

This connector supports a Trusted Platform Module (TPM) system, which can securely store keys, digital certificates, passwords, and data. A TPM system also helps enhance network security, protects digital identities, and ensures platform integrity.

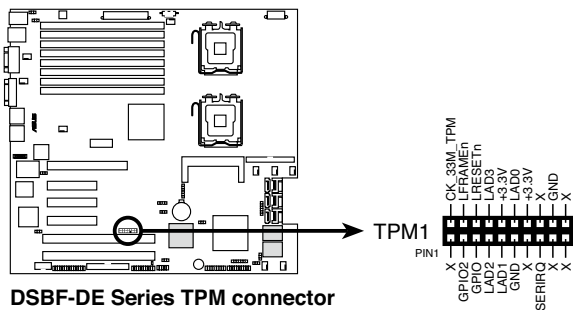

DSBF-DE Series TPM connector

15. LPC debug card connector (14-1 pin LPC1)

This is a low pin count interface used to plug in the LPC debug card.

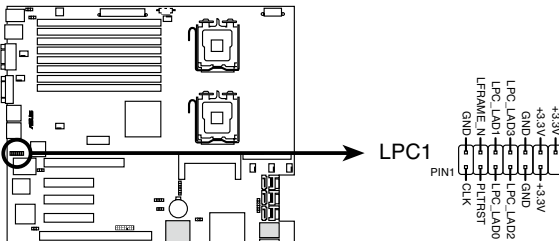

DSBF-DE Series LPC debug card connector

16. Auxiliary panel connector (20-pin AUX_PANEL1)

This connector is for additional front panel features including front panel SMB, locator LED and switch, chassis intrusion, and LAN LEDs.

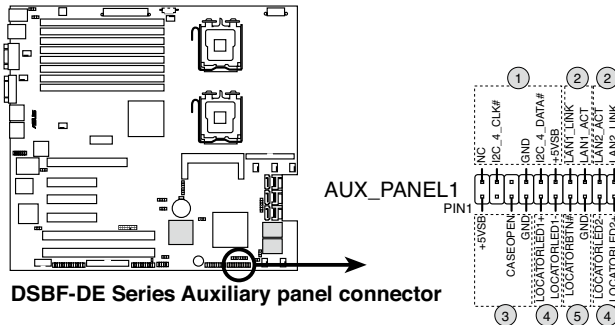

DSBF-DE Series Auxiliary panel connector

- 1. Front panel SMB (6-1 pin FPSMB)**
These leads connect the front panel SMBus cable.
- 2. LAN activity LED (2-pin LAN1_LED, LAN2_LED)**
These leads are for Gigabit LAN activity LEDs on the front panel.
- 3 Chassis intrusion (4-1 pin CHASSIS)**
These leads are for the intrusion detection feature for chassis with intrusion sensor or microswitch. When you remove any chassis component, the sensor triggers and sends a high-level signal to these leads to record a chassis intrusion event.
- 4. Locator LED (6-pin LOCATOR)**
These leads are for the locator switch and LED on the front panel.

17. System panel connector (20-1 pin PANEL1)

This connector supports several chassis-mounted functions.



The system panel connector is color-coded for easy connection.

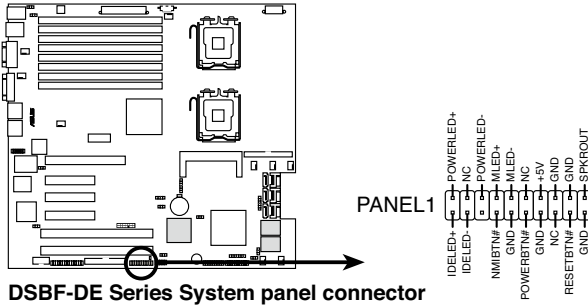

- **System power LED (Green 3-pin PLED)**
This 3-pin connector is for the system power LED. Connect the chassis power LED cable to this connector. The system power LED lights up when you turn on the system power, and blinks when the system is in sleep mode.
- **Hard disk drive activity LED (Red 2-pin IDE_LED)**
This 2-pin connector is for the HDD Activity LED. Connect the HDD Activity LED cable to this connector. The IDE LED lights up or flashes when data is read from or written to the HDD.
- **System warning speaker (Orange 4-pin SPEAKER)**
This 4-pin connector is for the chassis-mounted system warning speaker. The speaker allows you to hear system beeps and warnings.
- **ATX power button/soft-off button (Yellow 2-pin PWRSW)**
This connector is for the system power button. Pressing the power button turns the system on or puts the system in sleep or soft-off mode depending on the BIOS settings. Pressing the power switch for more than four seconds while the system is ON turns the system OFF.
- **Reset button (Blue 2-pin RESET)**
This 2-pin connector is for the chassis-mounted reset button for system reboot without turning off the system power.

This chapter describes the power up sequence, and ways of shutting down the system.

Powering up **3**

3.1	Starting up for the first time.....	3-1
3.2	Turning off the computer.....	3-2

3.1 Starting up for the first time

1. After making all the connections, replace the system case cover.
2. Be sure that all switches are off.
3. Connect the power cord to the power connector at the back of the system chassis.
4. Connect the power cord to a power outlet that is equipped with a surge protector.
5. Turn on the devices in the following order:
 - a. Monitor
 - b. System power
6. After applying power, the system power LED on the system front panel case lights up. For systems with ATX power supplies, the system LED lights up when you press the ATX power button. If your monitor complies with “green” standards or if it has a “power standby” feature, the monitor LED may light up or switch between orange and green after the system LED turns on.

The system then runs the power-on self tests or POST. While the tests are running, the BIOS beeps (see BIOS beep codes table below) or additional messages appear on the screen. If you do not see anything within 30 seconds from the time you turned on the power, the system may have failed a power-on test. Check the jumper settings and connections or call your retailer for assistance.

Phoenix BIOS beep codes

Beep Description	Error
Endless beep	Memory module missing
One continuous beep followed by short beeps	VGA controller failure
Two short beeps	PCI resource assignment error

7. At power on, hold down the <Delete> key to enter the BIOS Setup. Follow the instructions in Chapter 4.

3.2 Turning off the computer

3.2.1 Using the OS shut down function

If you are using Windows® 2000/2003:

1. Click the **Start** button then click **Shut Down**...
2. Make sure that the **Shut Down** option button is selected, then click the **OK** button to shut down the computer.
3. The power supply should turn off after Windows® shuts down.

If you are using Windows® XP:

1. Click the **Start** button then select **Turn Off Computer**.
2. Click the **Turn Off** button to shut down the computer.
3. The power supply should turn off after Windows® shuts down.

3.2.2 Using the dual function power switch

While the system is ON, pressing the power switch for less than four seconds puts the system to sleep mode or to soft-off mode, depending on the BIOS setting.

Pressing the power switch for more than four seconds lets the system enter the soft-off mode regardless of the BIOS setting.

This chapter tells how to change the system settings through the BIOS Setup menus. Detailed descriptions of the BIOS parameters are also provided.

BIOS setup **4**

4.1	Managing and updating your BIOS	4-1
4.2	BIOS setup program	4-8
4.3	Main menu	4-12
4.4	Advanced menu	4-18
4.5	Server menu	4-34
4.6	Security menu	4-37
4.7	Boot menu	4-40
4.8	Exit menu	4-41

4.1 Managing and updating your BIOS

The following utilities allow you to manage and update the motherboard Basic Input/Output System (BIOS) setup:

1. **Phoenix Phlash16 BIOS Flash Utility** (Updates the BIOS in DOS mode using a bootable floppy disk.)
2. **ASUS CrashFree BIOS 2** (To recover the BIOS using a bootable floppy disk when the BIOS file fails or gets corrupted.)
3. **ASUS Update** (Updates the BIOS in Windows® environment.)

Refer to the corresponding sections for details on these utilities.



Save a copy of the original motherboard BIOS file to a bootable floppy disk in case you need to restore the BIOS in the future. Copy the original motherboard BIOS using the ASUS Update or Phoenix Phlash16 BIOS utilities. Refer to page 4-3 for details.

4.1.1 Creating a bootable floppy disk

1. Do either one of the following to create a bootable floppy disk.

DOS environment

- a. Insert a 1.44MB floppy disk into the drive.
- b. At the DOS prompt, type `format A: /S` then press <Enter>.

Windows® XP environment

- a. Insert a 1.44 MB floppy disk to the floppy disk drive.
- b. Click **Start** from the Windows® desktop, then select **My Computer**.
- c. Select the **3 ½ Floppy Drive** icon.
- d. Right click **File** from the menu, then select **Format. A Format 3½ Floppy Disk** window appears.
- e. Select **Create an MS-DOS startup disk** from the format options field, then click **Start**.

- c. Click **Start**, then select **Run**.
 - d. From the Open field, type
`D:\bootdisk\makeboot a:`
assuming that D: is your optical drive.
 - e. Press <Enter>, then follow screen instructions to continue.
2. Copy the original or the latest motherboard BIOS file to the bootable floppy disk.

4.1.2 Updating the BIOS using the Phoenix Phlash16 Utility

The Basic Input/Output System (BIOS) can be updated using the Phoenix Phlash16 Utility. Follow these instructions to update the BIOS using this utility.

1. Download the latest BIOS file from the ASUS web site. Rename the file to **BIOS.WPH**. Save the file to a floppy disk.



Make sure you copy the correct BIOS file for the specific model of your motherboard. Save only the updated BIOS file in the floppy disk to avoid loading the wrong BIOS file.

2. Copy the **Phoenix Phlash16** (phlash16.exe) utility from the Software folder of the support CD to the floppy disk with the latest BIOS file.
3. Boot the system in DOS mode using the bootable floppy disk you created earlier.
4. When the **A:>** appears, replace the bootable floppy disk with the floppy disk containing the new BIOS file and the Phoenix Phlash16 Utility.
5. At the prompt, type the following command string:
phlash16 /mode=3BIOS.WPH.
6. The Phoenix Phlash16 Utility automatically updates the BIOS.



DO NOT turn off or reset the system during the flashing process!

7. Restart the system after the utility completes the updating process. Make sure you remove the floppy disk from the drive

4.1.3 ASUS CrashFree BIOS 2 utility

The ASUS CrashFree BIOS 2 is an auto recovery tool that allows you to restore the BIOS file when it fails or gets corrupted during the updating process. You can update a corrupted BIOS file using a floppy disk.



Prepare a blank floppy disk before using this utility.

Recovering the BIOS from a floppy disk

A. Prepare the recovery diskette:

1. Insert the motherboard floppy disk to a PC, then boot from the support CD; the screen will show several optional items.
2. Select the item "Create the emergent BIOS Recovery diskette".

```
A) FreeDOS command prompt
B) Create INTEL 6321 MATRIX STORAGE MANAGER for Windows 32 bit Driver Disk.
(Also support AHCI.)
C) Create INTEL 6321 MATRIX STORAGE MANAGER for Windows 64 bit Driver Disk.
(Also support AHCI.)
D) Create LSI 1068 SAS for Win2k / Win2k3 32 bit Driver Disk
E) Create LSI 1068 SAS for RHEL3 UP6 32 bit Driver Disk
F) Create LSI 1068 SAS for RHEL3 UP6 64 bit Driver Disk
G) Create LSI 1068 SAS for RHEL4 UP2 32 bit Driver Disk
H) Create LSI 1068 SAS for RHEL4 UP2 64 bit Driver Disk
I) Create INTEL 6321 LSI MegaRAID for Windows 32 bit Driver Disk
J) Create INTEL 6321 LSI MegaRAID for Windows 64 bit Driver Disk
K) Create INTEL 6321 LSI MegaRAID for RHEL4 UP2 32/64 bit Driver Disk
L) Create INTEL 6321 LSI MegaRAID for RHEL3 UP6 32/64 bit Driver Disk
M) Create the DSBF-DE emergent BIOS Recovery diskette
N) Flash Phoenix BIOS for DSBF-DE MB
O) Create the DSBF-DE/SAS emergent BIOS Recovery diskette
P) Flash Phoenix BIOS for DSBF-DE/SAS MB
Q) ESB2 ASF Firmware update

Please choose A TO Q:
```

B. To recover the BIOS from a floppy disk:

1. When BIOS corrupted, put this disk in the floppy disk drive, then turn on the machine to boot from the floppy disk.
2. The utility displays the following message and automatically checks the floppy for the recovery information.

```
RM50 DDR1 A21 BIOS
```

3. When found, the utility reads the BIOS file and starts flashing the corrupted BIOS file.



Before you recover the BIOS setting, refer to "2.6 Jumpers, Force BIOS recovery setting" for more information.

7. Press the power button for more than four seconds to turn off the system.



The recovered BIOS may not be the latest BIOS version for this motherboard. Visit the ASUS website (www.asus.com) to download the latest BIOS file.

4.1.4 ASUS Update utility

The ASUS Update is a utility that allows you to manage, save, and update the motherboard BIOS in Windows® environment. The ASUS Update utility allows you to:

- Save the current BIOS file
- Download the latest BIOS file from the Internet
- Update the BIOS from an updated BIOS file
- Update the BIOS directly from the Internet, and
- View the BIOS version information.

This utility is available in the support CD that comes with the motherboard package.



ASUS Update requires an Internet connection either through a network or an Internet Service Provider (ISP).

Installing ASUS Update

To install ASUS Update:

1. Place the support CD in the optical drive. The **Drivers** menu appears.
2. Click the **Utilities** tab, then click **Install ASUS Update VX.XX.XX**.
3. The **ASUS Update** utility is copied to your system.



Quit all Windows® applications before you update the BIOS using this utility.

Updating the BIOS through the Internet

To update the BIOS through the Internet:

1. Launch the ASUS Update utility from the Windows® desktop by clicking **Start > Programs > ASUS > ASUSUpdate > ASUSUpdate**. The **ASUS Update** main window appears.



2. Select **Update BIOS** from the Internet option from the drop-down menu, then click **Next**.
3. Select the ASUS FTP site nearest you to avoid network traffic, or click **Auto Select**. Click **Next**.

- From the FTP site, select the BIOS version that you wish to download. Click **Next**.
- Follow the screen instructions to complete the update process.



The ASUS Update utility is capable of updating itself through the Internet. Always update the utility to avail all its features.



Updating the BIOS through a BIOS file

To update the BIOS through a BIOS file:

- Launch the ASUS Update utility from the Windows® desktop by clicking **Start > Programs > ASUS > ASUSUpdate > ASUSUpdate**. The **ASUS Update** main window appears.
- Select **Update BIOS** from a file option from the drop-down menu, then click **Next**.



- Locate the BIOS file from the **Open** window, then click **Save**.
- Follow the screen instructions to complete the update process.

4.2 BIOS setup program

This motherboard supports a programmable Low-Pin Count (LPC) chip that you can update using the provided utility described in section “4.1 Managing and updating your BIOS.”

Use the BIOS Setup program when you are installing a motherboard, reconfiguring your system, or prompted to “Run Setup.” This section explains how to configure your system using this utility.

Even if you are not prompted to use the Setup program, you can change the configuration of your computer in the future. For example, you can enable the security password feature or change the power management settings. This requires you to reconfigure your system using the BIOS Setup program so that the computer can recognize these changes and record them in the CMOS RAM of the LPC chip.

The LPC chip on the motherboard stores the Setup utility. When you start up the computer, the system provides you with the opportunity to run this program. Press during the Power-On Self-Test (POST) to enter the Setup utility; otherwise, POST continues with its test routines.

If you wish to enter Setup after POST, restart the system by pressing <Ctrl+Alt+Delete>, or by pressing the reset button on the system chassis. You can also restart by turning the system off and then back on. Do this last option only if the first two failed.

The Setup program is designed to make it as easy to use as possible. Being a menu-driven program, it lets you scroll through the various sub-menus and make your selections from the available options using the navigation keys.



-
- The default BIOS settings for this motherboard apply for most conditions to ensure optimum performance. If the system becomes unstable after changing any BIOS settings, load the default settings to ensure system compatibility and stability. Select the **Load Default Settings** item under the Exit Menu. See section “4.8 Exit Menu.”
 - The BIOS setup screens shown in this section are for reference purposes only, and may not exactly match what you see on your screen.
 - Visit the ASUS website (www.asus.com) to download the latest BIOS file for this motherboard.
-

4.2.1 BIOS menu screen

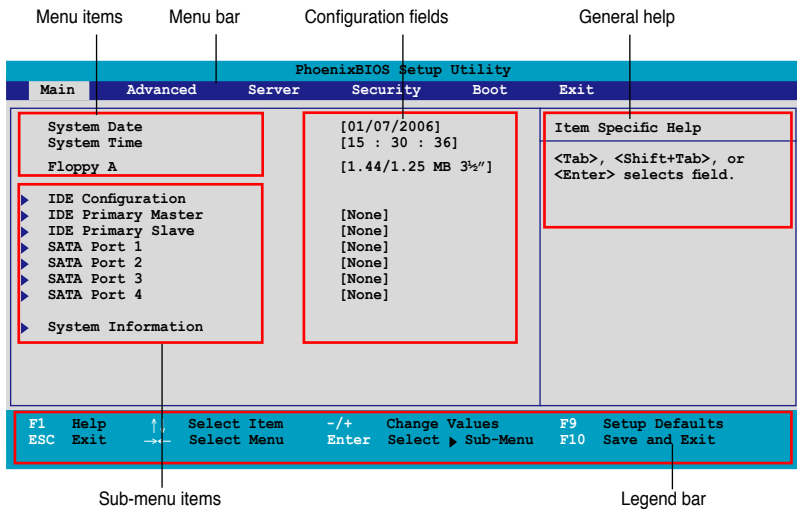

4.2.2 Menu bar

The menu bar on top of the screen has the following main items:

- Main** For changing the basic system configuration
- Advanced** For changing the advanced system settings
- Server** For changing the advanced server settings
- Security** For changing the security settings
- Boot** For changing the system boot configuration
- Exit** For selecting the exit options and loading default settings

To select an item on the menu bar, press the right or left arrow key on the keyboard until the desired item is highlighted.

4.2.3 Legend bar

At the bottom of the Setup screen is a legend bar. The keys in the legend bar allow you to navigate through the various setup menus. The following table lists the keys found in the legend bar with their corresponding functions.

Navigation Key	Function
<F1>	Displays the General Help screen
<F9>	Loads setup default values
<Esc>	Exits the BIOS setup or returns to the main menu from a sub-menu
Left or Right arrow	Selects the menu item to the left or right
Up or Down arrow	Moves the highlight up or down between fields
Page Down or – (minus)	Scrolls backward through the values for the highlighted field
Page Up or + (plus)	Scrolls forward through the values for the highlighted field
<Enter>	Brings up a selection menu for the highlighted field
<F10>	Saves changes and exit

4.2.4 Menu items

The highlighted item on the menu bar displays the specific items for that menu. For example, selecting Main shows the Main menu items.

The other items (Advanced, Power, Boot, and Exit) on the menu bar have their respective menu items.

4.2.5 Sub-menu items

A solid triangle before each item on any menu screen means that the item has a sub-menu. To display the sub-menu, select the item and press <Enter>.

4.2.6 Configuration fields

These fields show the values for the menu items. If an item is user-configurable, you can change the value of the field opposite the item. You cannot select an item that is not user-configurable.

A configurable field is enclosed in brackets, and is highlighted when selected. To change the value of a field, select it then press <Enter> to display a list of options. Refer to “4.2.7 Pop-up window.”

4.2.7 Pop-up window

Select a menu item then press <Enter> to display a pop-up window with the configuration options for that item.

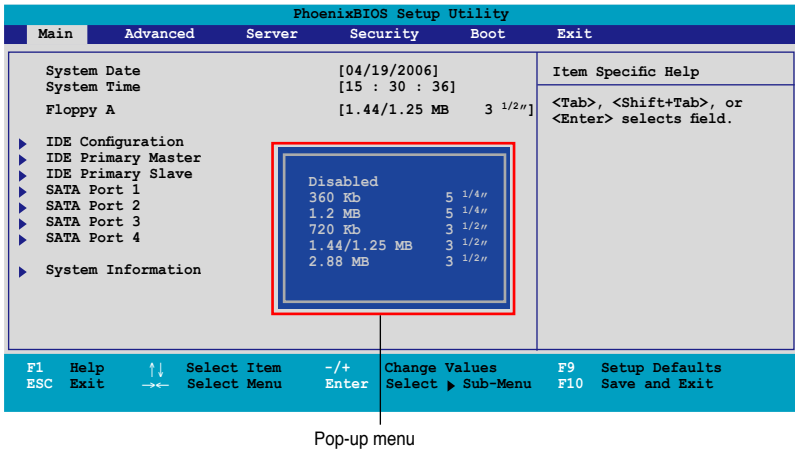

4.2.8 General help

At the top right corner of the menu screen is a brief description of the selected item.

4.3 Main menu

When you enter the BIOS Setup program, the Main menu screen appears, giving you an overview of the basic system information.



Refer to section “4.2.1 BIOS menu screen” for information on the menu screen items and how to navigate through them.

PhoenixBIOS Setup Utility					
Main	Advanced	Server	Security	Boot	Exit
System Date	[07/11/2006]				Item Specific Help
System Time	[15 : 30 : 36]				<Tab>, <Shift-Tab>, or <Enter> selects field.
Floppy A	[1.44/1.25 MB 3 1/2"]				
▶ IDE Configuration					
▶ IDE Primary Master	[None]				
▶ IDE Primary Slave	[None]				
▶ SATA Port 1	[None]				
▶ SATA Port 2	[None]				
▶ SATA Port 3	[None]				
▶ SATA Port 4	[None]				
▶ System Information					
F1 Help	↑↓ Select Item	~/+ Change Values	F9 Setup Defaults		
ESC Exit	→← Select Menu	Enter Select ▶ Sub-Menu	F10 Save and Exit		

4.3.1 System Date [Day xx/xx/xxxx]

Allows you to set the system date.

4.3.2 System Time [xx:xx:xx]

Allows you to set the system time.

4.3.3 Floppy A [1.44M, 3.5 in.]

Sets the type of floppy drive installed.

Configuration options: [Disabled] [360 Kb 5 1/4"] [1.2 MB 5 1/4"] [720 Kb 3 1/2"] [1.44/1.25 MB 3 1/2"] [2.88 MB 3 1/2"]

4.3.4 IDE Configuration

PhoenixBIOS Setup Utility							
Main							
IDE Configuration				Item Specific Help			
Fixed disk boot sector: [Normal]				Write protects boot sector on hard disk to protect against viruses.			
▶ S-ATA Configuration							
F1	Help	↑↓	Select Item	-/+	Change Values	F9	Setup Defaults
ESC	Exit	→←	Select Menu	Enter	Select ▶ Sub-Menu	F10	Save and Exit

Fixed disk boot sector [Normal]

Setting this item to [Write Protect] prevents write access to the boot sector on the hard disk to protect against viruses. The default setting [Normal] allows write access. Configuration options: [Normal] [Write Protect]

S-ATA Configuration

PhoenixBIOS Setup Utility							
Main							
S-ATA Configuration				Item Specific Help			
Parallel ATA:				Enable the PATA			
Serial ATA							
SATA Controller Mode Option:							
SATA RAID Enable							
SATA AHCI Enable							
F1	Help	↑↓	Select Item	-/+	Change Values	F9	Setup Defaults
ESC	Exit	→←	Select Menu	Enter	Select ▶ Sub-Menu	F10	Save and Exit

Parallel ATA [Enabled]

Allows you to enable or disable the parallel ATA function. Configuration options: [Disabled] [Enabled]

Native Mode Operation [Auto]

Allows you to choose the native mode for ATA.

Configuration options: [Auto] [Serial ATA]



The above item appears only when the **SATA Controller Mode Option** is set to [Compatible]

Serial ATA [Enabled]

Allows you to enable or disable the Serial ATA function.

Configuration options: [Disabled] [Enabled]

SATA Controller Mode Option [Enhanced]

Allows selection of the Serial ATA operation mode depending on the operating system (OS) that you installed. When you set this item to Enhanced Mode, Serial ATA and Parallel ATA devices are auto-detected and placed in native IDE mode. Set to Enhanced Mode if you are using native OS, such as Windows® 2000/XP. When you set this item to Compatible Mode, Serial ATA and Parallel ATA devices are auto-detected and placed in legacy mode. Set this item to [Compatible] if you are using legacy OS, e.g. Windows ME/98/NT, MS-DOS. Configuration options: [Compatible] [Enhanced]



The following items appear only if you set the **SATA Controller Mode Option** item to [Enhanced].

SATA RAID Enable [Disabled]

Allows you to enable or disable the Serial ATA RAID function.

Configuration options: [Disabled] [Enabled]

SATA AHCI Enable [Disabled]

Allows you to enable or disable the Serial ATA AHCI function.

Configuration options: [Disabled] [Enabled]



-
- **SATA AHCI Enable** item appears only when **SATA RAID Enable** is set to [Disabled]
 - AHCI mode item supports only under Windows environment.
 - Due to the driver limitation, you will not find any SATA driver if you install Fedora core 4.
-

4.3.5 IDE Primary Master/Slave; SATA Port 1/2/3/4

PhoenixBIOS Setup Utility			
Main		IDE Primary Master	
		Item Specific Help	
Type:	[Auto]	Auto = Autotyping. None = Disabling drive. ATAPI Removable = ATAPI media (e.g., LS120, USB Floppy, USB Zip). CD-ROM = CD-ROM drive. IDE Removable = IDE removable media (e.g., IDE Zip drive). Other ATAPI = Other ATAPI media. User = You simply the hard disk drive type.	
Multi-Sector Transfers:	[Disabled]		
LBA Mode Control:	[Disabled]		
32-Bit I/O:	[Disabled]		
Transfer Mode:	[Standard]		
Ultra DMA Mode:	[Disabled]		
F1 Help	↑↓ Select Item	-/+ Change Values	F9 Setup Defaults
ESC Exit	←→ Select Menu	Enter Select	F10 Save and Exit
▶ Sub-Menu			

Type [Auto]

Selects the type of IDE drive. Setting to Auto allows automatic selection of the appropriate IDE device type. Select [CD-ROM] if you are specifically configuring a CD-ROM drive. Select [ATAPI Removable] if your device is either a ZIP, LS-120, or MO drive. Select [User] to manually enter the parameters of the device. Configuration options: [Auto] [User] [Other ATAPI] [IDE Removable] [CD-ROM] [ATAPI Removable] [None]



- Except for 32-Bit I/O item, the following items become user-configurable when the **Type** item is not set to [Auto].
- Suggest you to keep the default setting of this item [Auto].
- For items that have no sub-menu, you have to use -/+ for values changing.

Multi-Sector Transfers [Disabled]

Enables or disables data multi-sectors transfers. When set to 2~16 Sectors, the data transfer from and to the device occurs multiple sectors at a time if the device supports multi-sector transfer feature. When set to [Disabled], the data transfer from and to the device occurs one sector at a time. Configuration options: [Disabled] [2 Sectors] [4 Sectors] [8 Sectors] [16 Sectors]

LBA Mode Control [Disabled]

Enables or disables the LBA mode. Setting to Enabled enables the LBA mode if the device supports this mode, and if the device was not previously formatted with LBA mode disabled. Configuration options: [Disabled] [Enabled]

32-Bit I/O [Disabled]

Enables or disables 32-bit data transfer. Configuration options: [Disabled] [Enabled]

Transfer Mode [Standard]

Allows you to select the method for the data transferring if the hard disk supports this feature.

Configuration options: [Standard] [Fast PIO 1] [Fast PIO 2] [Fast PIO 3] [Fast PIO 4] [FPIO 3 / DMA 1] [FPIO 4 / DMA2]

Ultra DMA Mode [Disabled]

When this item is set to [Mode 0-5], the UDMA capability allows improved transfer speeds and data integrity for supported IDE devices.

Configuration options: [Disabled] [Mode 0] [Mode 1] [Mode 2] [Mode 3] [Mode 4] [Mode 5]

4.3.6 System Information

This menu gives you an overview of the general system specifications. The BIOS automatically detects the items in this menu.

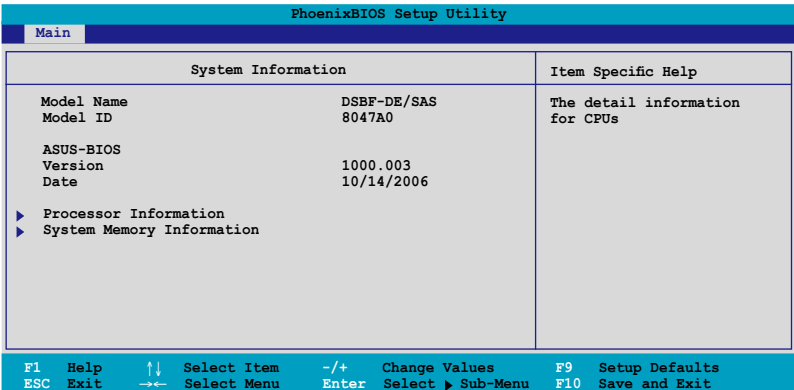

The screenshot shows the PhoenixBIOS Setup Utility interface. At the top, a blue bar contains the title "PhoenixBIOS Setup Utility" and a "Main" button. Below this is a table with two columns: "System Information" and "Item Specific Help". The "System Information" column lists: Model Name (DSBF-DE/SAS), Model ID (8047A0), ASUS-BIOS Version (1000.003), Date (10/14/2006), Processor Information, and System Memory Information. The "Item Specific Help" column contains the text "The detail information for CPUs". At the bottom of the screen, a blue bar contains keyboard shortcuts: F1 Help, ESC Exit, arrow keys for Select Item and Select Menu, +/- for Change Values, Enter for Select, F9 Setup Defaults, and F10 Save and Exit.

System Information		Item Specific Help
Model Name	DSBF-DE/SAS	The detail information for CPUs
Model ID	8047A0	
ASUS-BIOS Version	1000.003	
Date	10/14/2006	
▶ Processor Information		
▶ System Memory Information		



The items in this menu are non-user configurable.

Model Name/Model ID

Displays the ASUS internal model information.

ASUS BIOS

Displays the BIOS revision and build date.

Processor Information

Displays the auto-detected CPU specification.

PhoenixBIOS Setup Utility					
Main					
Processor Information				Item Specific Help	
<pre> *** CPU1 : Brand Intel(R) Xeon(TM) CPU 2.83GHz Speed 2.800GHz Ratio Actual 17 Max 17 Cache L1/32 KB L2/4096 KB ID/uCode 0F64h/02h </pre>				<p>All items on this menu cannot be modified in user mode. If any items require changes, please consult your system Supervisor.</p>	
F1	Help	↑↓	Select Item	-/+	Change Values
ESC	Exit	→←	Select Menu	Enter	Select ► Sub-Menu
F9	Setup Defaults			F10	Save and Exit

System Memory Information

Displays the auto-detected system memory information.

PhoenixBIOS Setup Utility					
Main					
System Memory Information				Item Specific Help	
<pre> Speed : DDR2 533 Total Memory: 1024MB DIMM_00-- 512MB, AMB Temperature: 98 DIMM_01-- 512MB, AMB Temperature: 70 DIMM_10-- None DIMM_11-- None DIMM_20-- None DIMM_21-- None DIMM_30-- None DIMM_31-- None </pre>				<p>All items on this menu cannot be modified in user mode. If any items require changes, please consult your system Supervisor.</p>	
F1	Help	↑↓	Select Item	-/+	Change Values
ESC	Exit	→←	Select Menu	Enter	Select ► Sub-Menu
F9	Setup Defaults			F10	Save and Exit

4.4 Advanced menu

The Advanced menu items allow you to change the settings for the CPU and other system devices.



Take caution when changing the settings of the Advanced menu items. Incorrect field values can cause the system to malfunction.

PhoenixBIOS Setup Utility					
Main	Advanced	Server	Security	Boot	Exit
WARNING: Setting wrong value in below sections may cause system to malfunction.				Item Specific Help	
<ul style="list-style-type: none"> ▶ Advanced Processor Options ▶ Chipset Configuration ▶ PCI Configuration ▶ ICH USB Control Sub-Menu ▶ Peripheral Devices Configuration ▶ ACPI Configuration ▶ Power On Configuration ▶ Hardware Monitor 				Options for CPU	
F1	Help	↑↓	Select Item	-/+	Change Values
ESC	Exit	→←	Select Menu	Enter	Select ▶ Sub-Menu
F9	Setup Defaults				
F10	Save and Exit				

4.4.1 Advanced Processor Options

If you install a 5000 series CPU, the BIOS appears as screen below.

PhoenixBIOS Setup Utility					
Advanced					
Advanced Processor Options				Item Specific Help	
Multiprocessor Specification		[1.4]	Configures the MP Specification revision level. Some operating systems will require 1.1 for compatibility reasons.		
Frequency Ratio		[Default]			
Hyperthreading:		[Enabled]			
Intel(R) Virtualization Technology		[Enabled]			
Machine Checking		[Enabled]			
Fast String operations		[Enabled]			
Compatible FPU Code		[Disabled]			
Split Lock operations		[Enabled]			
C1 Enhanced Mode		[Enabled]			
No Execute Mode Mem Protection		[Enabled]			
Adjacent Cache Line Prefetch		[Enabled]			
Set Max Ext CPUID = 3		[Disabled]			
Echo TPR		[Disabled]			
F1	Help	↑↓	Select Item	-/+	Change Values
ESC	Exit	→←	Select Menu	Enter	Select ▶ Sub-Menu
F9	Setup Defaults				
F10	Save and Exit				

Scroll down to display the following items:

Advanced Processor Options				Item Specific Help	
Discrete MTRR Allocation		[Disabled]			
Intel EIST support:		[Disabled]			
F1:Help	↑↓	: Select Item	-/+:	Change Value	F5: Setup Defaults
ESC: Exit	→←	: Select Menu	Enter:	Select SubMenu	F10: Save and Exit

Multiprocessor Specification [1.4]

Allows you to configure the MP Specification revision level.

Configuration options: [1.1] [1.4]

Frequency Ratio [Default]

Allows you to select the processor frequency ratio.

Configuration options: [Default] [X 12] [X 13] [X 14] [X 15] [X 16] [X 17]



The configuration options of **Frequency Ratio** may vary according to your CPU.

Hyperthreading [Enabled]

Allows you to enable or disable the Intel® Hyper-Threading Technology feature.

Configuration options: [Disabled] [Enabled]

Intel(R) Virtualization Technology [Enabled]

Configuration options: [Disabled] [Enabled]

***Machine Checking [Enabled]**

Configuration options: [Disabled] [Enabled]

***Fast String Operations [Enabled]**

Configuration options: [Disabled] [Enabled]

***Compatible FPU Code [Disabled]**

Configuration options: [Disabled] [Enabled]

C1 Enhanced Mode [Enabled]

Allows you to enable or disable C1E mode. In C1E mode, the CPU power consumption is lower when idle. Configuration options: [Disabled] [Enabled]

No Execute Mode Mem Protection [Enabled]

Configuration options: [Disabled] [Enabled]

Adjacent Cache Line Prefetch [Enabled]

Configuration options: [Disabled] [Enabled]

Set Max Ext CPUID = 3 [Disabled]

Enable this item to boot legacy operating systems that cannot support CPUs with extended CPUID functions. Configuration options: [Disabled] [Enabled]

Echo TPR [Disabled]

Configuration options: [Disabled] [Enabled]

Discrete MTRR Allocation [Disabled]

Configuration options: [Disabled] [Enabled]

Intel EIST support [Disabled]

Enables or disables EIST support. When enabled, this item allows the CPU P state to dynamically change based on system loading.

Configuration options: [Disabled] [Enabled]



- The appearance of the **Intel EIST support** item depends on the CPU SKU.
- Items above with * mark are for technical personnel to debug only.

If you install a 5100/5300 series CPU, the BIOS screen appears as the following.

PhoenixBIOS Setup Utility			
Advanced			
Advanced Processor Options		Item Specific Help	
Multiprocessor Specification	[1.4]	Configures the MP Specification revision level. Some operating systems will require 1.1 for compatibility reasons.	
Numbers of Stop Grant	[Per Core]		
Intel (R) Virtualization Technology	[Enabled]		
Machine Checking	[Enabled]		
Fast String Operations	[Enabled]		
Compatible FPU Code	[Disabled]		
Split Lock operations	[Enabled]		
Thermal Management 2	[Enabled]		
C1 Enhanced Mode	[Enabled]		
No Execute Mode Mem Protection	[Enabled]		
Adjacent Cache Line Prefetch	[Enabled]		
Set Max Ext CPUID = 3	[Disabled]		
Echo TPR	[Disabled]		
F1: Help ↑↓ : Select Item -/+ : Change Value F5: Setup Defaults ESC: Exit →← : Select Menu Enter: Select SubMenu F10: Save and Exit			

Scroll down to display the following items:

Advanced Processor Options		Item Specific Help
Discrete MTRR Allocation	[Disabled]	
Intel EIST support:	[Disabled]	
F1: Help ↑↓ : Select Item -/+ : Change Value F5: Setup Defaults ESC: Exit →← : Select Menu Enter: Select SubMenu F10: Save and Exit		

Multiprocessor Specification [1.4]

Allows you to configure the MP Specification revision level.

Configuration options: [1.1] [1.4]

Numbers of Stop Grant [Per Core]

Configuration options: [Per Core] [Single]

Intel(R) Virtualization Technology [Enabled]

Configuration options: [Disabled] [Enabled]

***Machine Checking [Enabled]**

Configuration options: [Disabled] [Enabled]

***Fast String Operations [Enabled]**

Configuration options: [Disabled] [Enabled]

***Compatible FPU Code [Disabled]**

Configuration options: [Disabled] [Enabled]

***Split Lock operations [Enabled]**

Configuration options: [Disabled] [Enabled]

Thermal Management 2 [Enabled]

Configuration options: [Disabled] [Enabled]

C1 Enhanced Mode [Enabled]

Allows you to enable or disable C1E mode. In C1E mode, the CPU power consumption is lower when idle. Configuration options: [Disabled] [Enabled]

No Execute Mode Mem Protection [Enabled]

Configuration options: [Disabled] [Enabled]

Adjacent Cache Line Prefetch [Enabled]

Configuration options: [Disabled] [Enabled]

Set Max Ext CPUID = 3 [Disabled]

Enable this item to boot legacy operating systems that cannot support CPUs with extended CPUID functions. Configuration options: [Disabled] [Enabled]

Echo TPR [Disabled]

Configuration options: [Disabled] [Enabled]

Discrete MTRR Allocation [Disabled]

Enable this item for better graphics performance when used with Linux and 4 GB or more memory. Configuration options: [Disabled] [Enabled]

Intel EIST support [Disabled]

Enables or disables EIST support. When enabled, this item allows the CPU P state to dynamically change based on system loading.

Configuration options: [Disabled] [Enabled]



- The appearance of the **Intel EIST support** item depends on the CPU SKU.
- Items above with * mark are for technical personnel to debug only.

4.4.2 Chipset Configuration

This menu shows the chipset configuration settings. Select an item then press <Enter> to display a pop-up menu with the configuration options.

PhoenixBIOS Setup Utility		
Advanced		
Chipset Configuration		Item Specific Help
Crystal Beach Configure Enable	[Enabled]	Enable Configuration/ Memory mapped accesses to the Crystal Beach Configuration space located in Device 8, Fn 0, and Fn 1.
SERR Signal Condition	[None]	
Demand Scrub Enable	[Enabled]	
Patrol Scrub Enable	[Enabled]	
4GB PCI Hole Granularity	[256 MB]	
Memory Branch Mode	[Interleave]	
Branch 0 Rank Interleave	[4:1]	
Branch 0 Rank Sparing	[Disabled]	
Branch 1 Rank Interleave	[4:1]	
Branch 1 Rank Sparing	[Disabled]	
Enhanced x8 Detection	[Enabled]	
Force ITK Config Clocking	[Disabled]	
FBDIMM(s) Thermal Throttling	[Open Loop]	

F1 Help	↑↓ Select Item	-/+ Change Values	F9 Setup Defaults
ESC Exit	→← Select Menu	Enter Select ▶ Sub-Menu	F10 Save and Exit

Scroll down to display the following item:

Open Loop Type	[Best Performan]	
Environment Temperature	[025 °C]	
Temperature Rise	[025 °C]	
FBDIMM(s) Air Flow	[2.0]	

F1 Help	↑↓ Select Item	-/+ Change Values	F9 Setup Defaults
ESC Exit	→← Select Menu	Enter Select ▶ Sub-Menu	F10 Save and Exit

Crystal Beach Configure Enable [Enabled]

Allows you to enable or disable the Configuration/Memory mapped accesses to the Crystal Beach Configuration space located in Device 8, Fn 0, and Fn 1. Configuration options: [Disabled] [Enabled]

SERR Signal Condition [Single Bit]

Allows you to select the ECC error that the SERR# asserts. Configuration options: [None] [Single Bit] [Multiple Bit] [Both]

Demand Scrub Enable [Enabled]

Enables or disables the Demand Scrubbing. Configuration options: [Disabled] [Enabled]

Patrol Scrub Enable [Enabled]

Enables or disables the Patrol Scrubbing. Configuration options: [Disabled] [Enabled]

4GB PCI Hole Granularity [256 MB]

Allows you to select the granularity of the PCI hole for PCI resource.

Configuration options: [256 MB] [512 MB] [1.0 GB] [2.0 GB]

Memory Branch Mode [Interleave]

Allows you to select the memory branch mode.

Configuration options: [Sequential] [Interleave] [Mirror] [Single channel 0]

Branch 0 Rank Interleave [4:1]

Allows you to select the Branch 0 Rank Interleave.

Configuration options: [1:1] [2:1] [4:1]

Branch 0 Rank Sparing [Disabled]

Allows you to enable or disable the Branch 0 rank/DIMM Sparing feature. This item does not appear when the **Memory Branch Mode** is set to [Mirror].

Configuration options: [Disabled] [Enabled]

Branch 1 Rank Interleave [4:1]

Allows you to select the Branch 0 Rank Interleave.

Configuration options: [1:1] [2:1] [4:1]

Branch 1 Rank Sparing [Disabled]

Allows you to enable or disable the Branch 0 rank/DIMM Sparing feature. This item does not appear when the **Memory Branch Mode** is set to [Mirror].

Configuration options: [Disabled] [Enabled]

Enhanced x8 Detection [Enabled]

Allows you to enable or disable the enhanced x8 DRAM UC error detection.

Configuration options: [Disabled] [Enabled]

Force ITK Config Clocking [Disabled]

Allows you to enable or disable the FBD configuration for ITK test suite.

Configuration options: [Disabled] [Enabled]

FBDIMM(s) Thermal Throttling [Open Loop]

Allows you to disable or set the thermal throttling control.

Configuration options: [Open Loop] [Close Loop] [ASUS MemCool Fan] [Disabled]



Set this item to [ASUS MemCool Fan] for a better fan management.

Open Loop Type [Best Performance]

Allows you to select the Open Loop Type.

Configuration options: [Best Performance] [Best Acoustic] [User Define]



The following items appear when you set the **Open Loop Type** to [User Define].

Environment Temperature [025 °C]

Allows you to select the Environment Temperature value.

Configuration options: [020 °C]~[040 °C]

Temperature Rise [025 °C]

Allows you to select the Temperature Rise value.

Configuration options: [010 °C]~[030 °C]

FBDIMM(s) Air Flow [2.0]

Allows you to select the Air Flow value.

Configuration options: [1.0] [1.5]~[4.5] [5.0]

4.4.3 PCI Configuration

This menu shows the PCI configuration settings. Select an item then press <Enter> to display the configuration options.

PhoenixBIOS Setup Utility		
Advanced		
PCI Configuration		Item Specific Help
Reset Configuration Data	[No]	Select 'Yes' if you want to clear the Extended System Configuration Data (ESCD) area.
Plug & Play OS	[No]	
Palette Snooping	[Disabled]	
▶ PCI1 Slot		
▶ PCI2 Slot		
▶ PCI3 Slot		
▶ PCI4 Slot		
▶ PCI5 Slot		
▶ PCI6 Slot		

F1 Help	↑↓ Select Item	-/+ Change Values	F9 Setup Defaults
ESC Exit	→← Select Menu	Enter Select ▶ Sub-Menu	F10 Save and Exit

Reset Configuration Data [No]

This item allows you to clear the Extended System Configuration Data (ESCD) area. Configuration options: [No] [Yes]

Plug & Play O/S [No]

When set to [No], BIOS configures all the devices in the system. When set to [Yes] and if you install a Plug and Play operating system, the operating system configures the Plug and Play devices not required for boot.

Configuration options: [No] [Yes]

Palette Snooping [Disabled]

When set to [Enabled], the palette snooping feature informs the PCI devices that an ISA graphics device is installed in the system so that the latter can function correctly. Configuration options: [Disabled] [Enabled]

PCI1~4 Slot; PCI5~6 Slot

Allows you to configure the specific PCI devices.

PhoenixBIOS Setup Utility		
Advanced		
PCI1 Slot		Item Specific Help
Optional ROM Scan:	[Enabled]	Initialize device expansion ROM

Optional ROM Scan [Enabled]

Allows you to enable or disable the device expansion ROM.

Configuration options: [Enabled] [Disabled]

4.4.4 ICH USB Control Sub-Menu

The items in this menu allow you to display the USB configuration settings. Select an item then press <Enter> to display the configuration options.

PhoenixBIOS Setup Utility			
Advanced			
ICH USB Control Sub-Menu		Item Specific Help	
USB Function	[Enabled]	Enable USB host controller.	
USB 2.0 Controller	[Enabled]		
Legacy USB Support:	[Enabled]		

F1 Help ↑↓ Select Item ~/+ Change Values F9 Setup Defaults
ESC Exit ←→ Select Menu Enter Select ► Sub-Menu F10 Save and Exit

USB Function [Enabled]

Allows you to enable the USB host controller.

Configuration options: [Disabled] [Enabled]



The following items appear only if you enable the **USB Function** item.

USB 2.0 Controller [Enabled]

Allows you to enable or disable the USB 2.0 controller. Setting this item to [Enabled] allows the built-in high speed USB support in the BIOS to turn on automatically when you install high speed USB devices.

Configuration options: [Disabled] [Enabled]

Legacy USB Support [Enabled]

Allows you to enable or disable support for USB devices on legacy operating systems (OS). Setting to [Enabled] allows the system to detect the presence of USB devices at startup. If detected, the USB controller legacy mode is enabled. If no USB device is detected, the legacy USB support is disabled.

Configuration options: [Disabled] [Enabled]

4.4.5 Peripheral Devices Configuration

This menu shows the peripheral devices configuration settings. Select an item then press <Enter> to display the configuration options.

PhoenixBIOS Setup Utility		
Advanced		
Peripheral Devices Configuration		Item Specific Help
COM1 port:	[Enabled]	Configure COM1 port using options:
Base I/O address:	[3F8]	
Interrupt:	[IRQ 4]	[Disabled]
COM2 port:	[Enabled]	No configuration
Mode:	[Normal]	
Base I/O address:	[2F8]	[Enabled]
Interrupt:	[IRQ 3]	User configuration
Parallel port:	[Enabled]	
Base I/O address:	[378]	[Auto]
Interrupt:	[IRQ 7]	BIOS or OS chooses configuration
Mode:	[ECP]	
DMA channel	[DMA 3]	(OS Controlled)
Floppy disk controller	[Enabled]	Displayed when controlled bt OS

F1	Help	↑↓	Select Item	-/+	Change Values	F9	Setup Defaults
ESC	Exit	→←	Select Menu	Enter	Select ▶ Sub-Menu	F10	Save and Exit

COM1 port [Enabled]

Allows you to configure COM1 port.

Configuration options: [Disabled] [Enabled] [Auto]

Base I/O address [3F8]

Allows you to select the base I/O address for COM1 port.

Configuration options: [3F8] [2F8] [3E8] [2E8]

Interrupt [IRQ 4]

Allows you to set the interrupt for COM1 port.

Configuration options: [IRQ 3] [IRQ 4]

COM2 port [Enabled]

Allows you to configure COM2 port.

Configuration options: [Disabled] [Enabled] [Auto]

Mode [Normal]

Allows you to set the mode for COM2 port.

Configuration options: [Normal] [IR] [ASK-IR]

Base I/O address [2F8]

Allows you to select the base I/O address for COM2 port.

Configuration options: [3F8] [2F8] [3E8] [2E8]

Interrupt [IRQ 3]

Allows you to set the interrupt for COM2 port.

Configuration options: [IRQ 3] [IRQ 4]

Parallel port [Enabled]

Allows you to configure the parallel port.

Configuration options: [Disabled] [Enabled] [Auto]

Base I/O address [378]

Allows you to select the base I/O address for the parallel port.

Configuration options: [378] [278] [3BC]

Interrupt [IRQ 7]

Allows you to set the interrupt for the parallel port.

Configuration options: [IRQ 5] [IRQ 7]

Mode [ECP]

Allows you to set the mode for the parallel port.

Configuration options: [Output only] [Bi-directional] [EPP] [ECP]

DMA channel [DMA 3]

Allows you to set the DMA channel for the parallel port.

Configuration options: [DMA 1] [DMA 3]

Floppy disk controller [Enabled]

Allows you to configure the floppy disk controller.

Configuration options: [Disabled] [Enabled] [Auto]

4.4.6 ACPI Configuration

This menu shows the Advanced Configuration and Power Interface (ACPI) configuration settings. Select an item then press <Enter> to display the configuration options.

PhoenixBIOS Setup Utility		
Advanced		
ACPI Configuration		Item Specific Help
ACPI Version Features	[ACPI v1.0]	Enable RSDP pointers to 64-bit Fixed System Description Tables.
Headless Mode	[Disabled]	
ACPI EMS Support	[Disabled]	

F1 Help ↑↓ Select Item -/+ Change Values F9 Setup Defaults
ESC Exit →← Select Menu Enter Select ► Sub-Menu F10 Save and Exit

ACPI Version Features [ACPI v1.0]

Allows you to enable RSDP pointers to 64-bit fixed system description tables.
Configuration options: [ACPI v1.0] [ACPI v2.0] [ACPI v3.0]

Headless Mode [Disabled]

Allows you to enable or disable the headless operation mode through ACPI.
Configuration options: [Disabled] [Enabled]

ACPI EMS Support [Disabled]

Allows you to enable or disable the ACPI EMS support.
Configuration options: [Disabled] [Enabled]

4.4.7 Power On Configuration

This menu shows the power configuration settings. Select an item then press <Enter> to display the configuration options.

PhoenixBIOS Setup Utility		
Advanced		
Power On Configuration		Item Specific Help
Restore on AC Power Loss	[Last State]	Configures the system state after recovering from power failure.
Power On By PS/2 Keyboard	[Disabled]	
Power On By PS/2 Mouse	[Disabled]	
Power On By PME#	[Disabled]	
Power-On By RTC Alarm	[Disabled]	

F1 Help ↑↓ Select Item -/+ Change Values F9 Setup Defaults
ESC Exit →← Select Menu Enter Select ▶ Sub-Menu F10 Save and Exit

Restore on AC Power Loss [Last State]

When set to [Power Off], the system goes into “off state” after an AC power interruption. When set to [Power On], the system turns on automatically after a power interruption. When set to [Last State], the system goes into whatever was the system state (on or off) before the power interruption.

Configuration options: [Power Off] [Power On] [Last State]

Power On By PS/2 Keyboard [Disabled]

Allows you to use specific keys on the PS/2 keyboard to turn on the system. This feature requires an ATX power supply that provides at least 1A on the +5VSB lead.

Configuration options: [Enabled] [Disabled]

Power On By PS/2 Mouse [Disabled]

When set to [Enabled], this parameter allows you to use the PS/2 mouse to turn on the system. This feature requires an ATX power supply that provides at least 1A on the +5VSB lead. Configuration options: [Enabled] [Disabled]

Power On By PME# [Disabled]

Allows you to enable or disable the PME and onboard LAN to generate a wake-up event. Configuration options: [Disabled] [Enabled]

Power On By RTC Alarm [Disabled]

Allows you to enable or disable RTC to generate a wake-up event.

Configuration options: [Disabled] [Enabled]



The following items appear only if you enable the **Power On By RTC Alarm** item.

RTC Alarm Date [0]

To set the date of alarm, highlight this item and press <Enter> to display a date chart. Press <+> or <-> to change scroll through the options, then press <Enter> when done. The default setting [0] is equivalent to everyday alarm.

Configuration options: [0] [1] ~ [31]

RTC Alarm Date [00 : 00 : 00]

To set the time of alarm:

1. Press <+> or <-> to set the desired value.
2. Use the left/right arrow key or press <Tab> to move to the next field.
3. Press <Enter> when done.

4.4.8 Hardware Monitor

This menu shows the hardware monitor configuration settings. Select an item then press <Enter> to display the configuration options.



The following screens appear when you install Intel® 5000 series CPU.

PhoenixBIOS Setup Utility			
Advanced			
Hardware Monitor		Item Specific Help	
CPU1 Domain 0 Temperature	39°C/102°F	To select the fan speed control model.	
CPU1 Domain 1 Temperature	29°C/84°F		
CPU2 Domain 0 Temperature	0°C/32°F		
CPU2 Domain 1 Temperature	0°C/32°F		
SYSTEM1 Temperature	39°C/102°F		
SYSTEM2 Temperature	29°C/84°F		
CPU_FAN1 Speed	2925 RPM		
CPU_FAN2 Speed	N/A		
FRN_FAN1 Speed	N/A		
FRN_FAN2 Speed	N/A		
FRN_FAN3 Speed	N/A		
FRN_FAN4 Speed	N/A		
REAR_FAN1 Speed	N/A		
REAR_FAN2 Speed	N/A		
Smart Fan Control	[Smart Fan II]		

F1	Help	↑↓	Select Item	-/+	Change Values	F9	Setup Defaults
ESC	Exit	→←	Select Menu	Enter	Select ▶ Sub-Menu	F10	Save and Exit

Scroll down to display more items:

PhoenixBIOS Setup Utility			
Advanced			
Hardware Monitor			Item Specific Help
CPU1 Domain 0 Target Temperature	[075]		Full fan speed will be started when the temperature reaches the selected target value.
CPU1 Domain 1 Target Temperature	[075]		
CPU2 Domain 0 Target Temperature	[075]		
CPU2 Domain 1 Target Temperature	[075]		
SYSTEM1 Target Temperature	[060°C]		
SYSTEM2 Target Temperature	[060°C]		
FBD_FAN1 Speed	N/A		
VCORE0 Voltage	1.25 V		
VCORE1 Voltage	1.25 V		
VTT	1.21 V		
+1.5V	1.56 V		
+1.8V	1.79 V		
+3V	3.28 V		
+12V	11.91 V		
+5V	4.87 V		
+5VSB	4.96 V		
VBAT	3.10 V		
F1 Help	↑↓ Select Item	-/+ Change Values	F9 Setup Defaults
ESC Exit	→← Select Menu	Enter Select ▶ Sub-Menu	F10 Save and Exit



The following screens appear when you install Intel® 5100 and 5300 series CPU.

PhoenixBIOS Setup Utility			
Advanced			
Hardware Monitor			Item Specific Help
CPU1 Temperature	39°C/102°F		To select the fan speed control model.
CPU2 Temperature	29°C/84°F		
SYSTEM1 Temperature	39°C/102°F		
SYSTEM2 Temperature	29°C/84°F		
CPU_FAN1 Speed	2925 RPM		
CPU_FAN2 Speed	N/A		
FRN_FAN1 Speed	N/A		
FRN_FAN2 Speed	N/A		
FRN_FAN3 Speed	N/A		
FRN_FAN4 Speed	N/A		
REAR_FAN1 Speed	N/A		
REAR_FAN2 Speed	N/A		
Smart Fan Control	[Smart Fan II]		
CPU1 Target Temperature	[66 °C]		
CPU2 Target Temperature	[66 °C]		
F1 Help	↑↓ Select Item	-/+ Change Values	F9 Setup Defaults
ESC Exit	→← Select Menu	Enter Select ▶ Sub-Menu	F10 Save and Exit

Scroll down to display more items:

PhoenixBIOS Setup Utility			
Advanced			Item Specific Help
Hardware Monitor			Item Specific Help
SYSTEM1 Target Temperature	[60 °C]		Full fan speed will be started when the temperature reaches the selected target value.
SYSTEM2 Target Temperature	[60 °C]		
FBD_FAN1 Speed	N/A		
VCORE0 Voltage	1.25 V		
VCORE1 Voltage	1.25 V		
VTT	1.21 V		
+1.5V	1.56 V		
+1.8V	1.79 V		
+3V	3.28 V		
+12V	11.91 V		
+5V	4.87 V		
+5VSB	4.96 V		
VBAT	3.10 V		
F1 Help	↑↓ Select Item	~/+ Change Values	
ESC Exit	→← Select Menu	Enter Select ▶ Sub-Menu	F10 Save and Exit

CPU1/2 Domain 0/1 Temperature (CPU1/2 Target Temperature), SYSTEM1/2 Temperature, CPU_FAN1/2 Speed, FRN_FAN1/2/3/4 Speed, REAR_FAN1/2 Speed

These fields show the auto-detected values and are not user-configurable. If no fan is installed, the field shows 0 RPM.

Smart Fan Control [Smart Fan II]

Allows you to disable or configure the Smart Fan feature.

Configuration options: [Disabled] [Smart Fan] [Smart Fan II]

CPU1/2 Domain 0/1 Target Temperature (CPU1/2 Target Temperature)

Allows you to set the target CPU temperature at which the CPU fan will start running if the fan is not yet turned on. Configuration options: [54]~[76]

SYSTEM1/2 Target Temperature

Allows you to set the target system temperature at which the system fan will start running if the fan is not yet turned on.

Configuration options: [39]~[60]

FBD_FAN1 Speed, VCORE0/1 Voltage, VTT, +1.5V, +1.8V, +3V, +12V, +5V, +5VSB, VBAT

These fields show the auto-detected values and are not user-configurable.

4.5 Server menu

This Server menu items allow you to customize the server features.

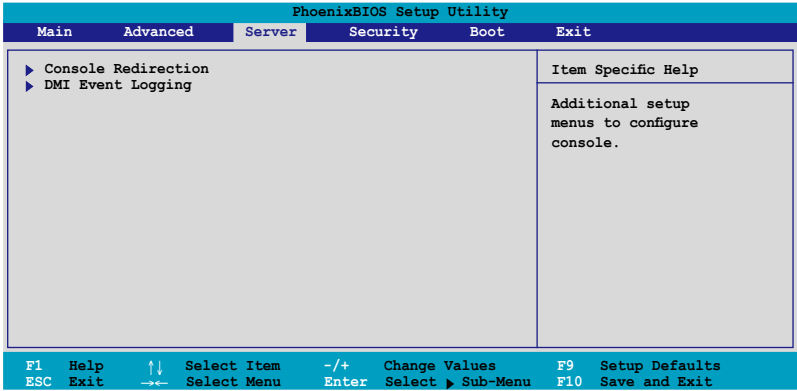

4.5.1 Console Redirection

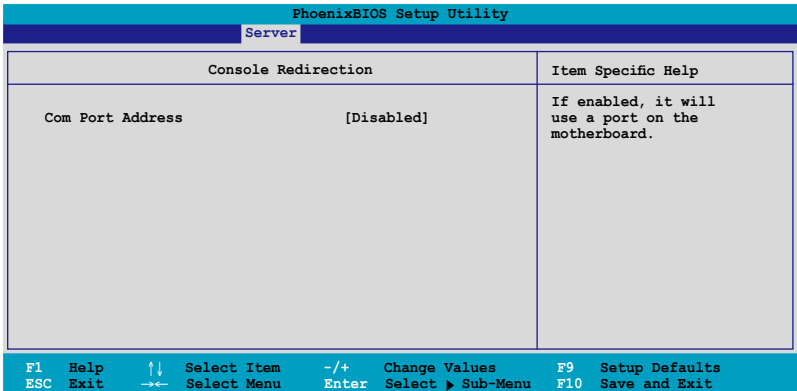

Com Port Address [Disabled]

Allows you to disable or select the COM port to use.

Configuration options: [Disabled] [On-board COM1 port] [On-board COM2 port]



The following items appear only if you set the **Com Port Address** item to [On-board COM1 port] or [On-board COM2 port].

Baud Rate [57.6K]

Allows you to enable the specified baud rate.

Configuration options: [300] [1200] [2400] [9600] [19.2K] [38.4K] [57.6K] [115.2K]

Console Type [VT-UTF8]

Allows you to enable the specified console type.

Configuration options: [VT100] [VT100, 8bit] [PC-ANSI, 7bit] [PC ANSI] [VT100+] [VT-UTF8] [ASCII]

Flow Control [None]

Allows you to select the flow control for console redirection.

Configuration options: [None] [XON/XOFF] [CTS/RTS]

Console connection [Direct]

Allows you to select the console connection. [Direct] indicates that the console is connected directly to the system. [Via modem] indicates that a modem is used to connect. Configuration options: [Direct] [Via modem]

Continue C.R. after POST [Off]

Set this item to [On] if you want console redirection to continue after the operating system has loaded. Configuration options: [Off] [On]

of video pages to support [1]

Allows you to set the number of video pages to allocate for console redirection when the video hardware is not available. Press <-> or <+> to set the value, or enter the value using the numeric keypad. Configuration options: [1] ~ [8]

4.5.2 DMI Event Logging

PhoenixBIOS Setup Utility			
Server			
DMI Event Logging		Item Specific Help	
Event log validity	V11alid	View the contents of the DMI event log.	
Event log capacity	Space Available		
View DMI event log	[Enter]		
Event Logging	[Enabled]		
ECC Event Logging	[Enabled]		
Mark DMI events as read	[Enter]		
Clear all DMI event logs	[No]		
F1 Help	↑↓ Select Item	-/+ Change Values	F9 Setup Defaults
ESC Exit	←→ Select Menu	Enter Select ▶ Sub-Menu	F10 Save and Exit

Event log validity, Event log capacity

Displays the auto-detected system information.

View DMI event log [Enter]

Press <Enter> to view the contents of the DMI event log.

Event Logging [Enabled]

Enables or disables to allow logging of DMI events.

Configuration options: [Disabled] [Enabled]

ECC Event Logging [Enabled]

Enables or disables to allow logging of ECC events.

Configuration options: [Disabled] [Enabled]

Mark DMI events as read [Enter]

Press <Enter> to mark all DMI events in the event log as read.

Clear all DMI event logs [No]

Allows you to keep or clear the DMI event log after rebooting.

Configuration options: [No] [Yes]

4.6 Security menu

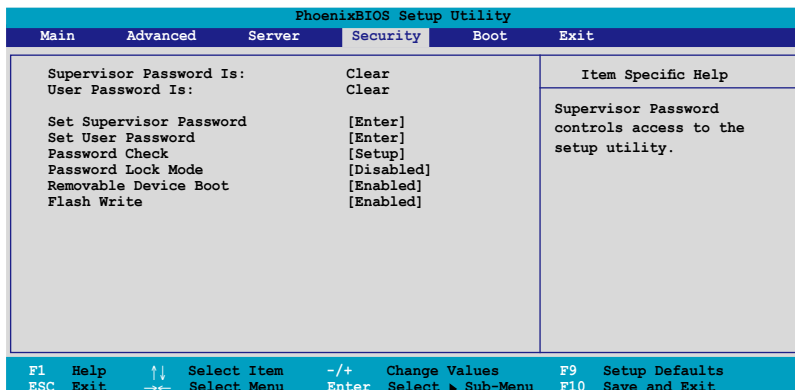

Supervisor Password Is [Clear]

User Password Is [Clear]

These fields allow you to set passwords:

To set a password:

1. Select an item then press <Enter>.
2. When prompted, type in a password using a combination of a maximum of eight (8) alpha-numeric characters, then press <Enter>.
3. Confirm the password by typing the exact characters again, then press <Enter>. The password field setting is changed to **Set**.

To clear the password:

1. Select the item **Set Supervisor Password** or **Set User Password**, depending on which password you want to clear. Press <Enter>.

The following message appears:

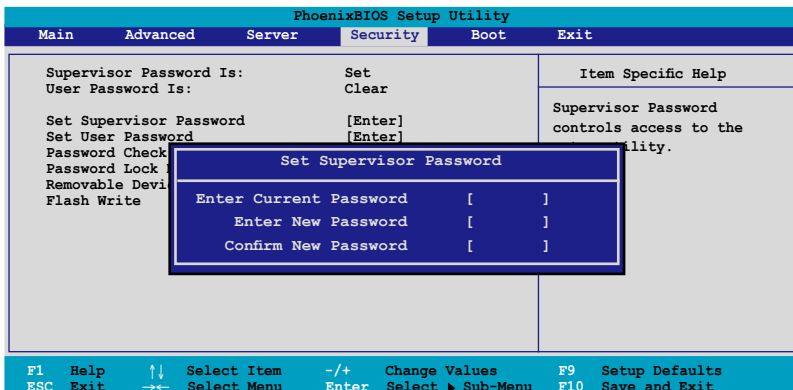

2. In the **Enter Current Password** field, type in your current password. Press <Enter>.
3. The cursor moves to the next field, **Enter New Password**. Press <Enter>. Do not type anything in this field.
4. The cursor moves to the next field, **Confirm New Password**. Press <Enter>. Do not type anything in this field.
5. When the confirmation message “Password has been changed” appears, press <Enter>.

The display returns to the Security menu. Note that the password field on top is changed to **Clear**.

A note about passwords

The Supervisor password is required to enter the BIOS Setup program preventing unauthorized access. The User password is required to boot the system preventing unauthorized use.

Forgot your password?

If you forget your password, you can clear it by erasing the CMOS Real Time Clock (RTC) RAM. The RAM data containing the password information is powered by the onboard button cell battery. If you need to erase the CMOS RAM, refer to section “2.6 Jumpers” for instructions.

Password Check [Setup]

This field requires you to enter the password before entering the BIOS setup or the system. Select [Setup] to require the password before entering the BIOS Setup. Select [System] to require the password before entering the system.
Configuration options: [Setup] [Always]

Password Lock Mode [Enabled]

When set to [Enabled], the keyboard is locked and the user has no privilege to launch the BIOS setup utility when installing adapter cards during option ROM initialization. Configuration options: [Disabled] [Enabled]

Removable Device Boot [Enabled]

Allows you to enable or disable booting from a legacy floppy, USB floppy, or IDE optical drive. Configuration options: [Disabled] [Enabled]

Flash Write [Enabled]

Set this item to [Disabled] to write-protect the BIOS flash memory.
Configuration options: [Disabled] [Enabled]

4.7 Boot menu

PhoenixBIOS Setup Utility					
Main	Advanced	Server	Security	Boot	Exit
▶ Boot Device Priority ▶ Boot Features				Item Specific Help Specify the boot priority sequence of all boot devices.	
F1	Help	↑↓	Select Item	-/+	Change Values
ESC	Exit	→←	Select Menu	Enter	Select ▶ Sub-Menu
F9	Setup Defaults				F10 Save and Exit

4.7.1 Boot Device Priority

PhoenixBIOS Setup Utility					
					Boot
Boot Device Priority				Item Specific Help	
Boot priority order: 1: Legacy Floppy Drives 2: PCI BEV: IBA GE Slot 0400 v 1236 3: PCI BEV: IBA GE Slot 0401 v 1236 4: 5: 6: 7: 8: Excluded from boot order:				Keys used to view or configure devices: Up and Down arrows select a device. <+> and <-> moves the device up or down. <f> and <r> specifies the device as fixed or removable. <x> excludes or includes the device to boot. <Shift + 1> enables or disables a device. <1 - 4> Loads default boot sequence.	
F1	Help	↑↓	Select Item	-/+	Change Values
ESC	Exit	→←	Select Menu	Enter	Select ▶ Sub-Menu
F9	Setup Defaults				F10 Save and Exit

Refer to the following table for keys assigned to configure devices.

Key/s	Use this key to...
<Up arrow> / <Down arrow>	select a device.
<+> / <->	move the device up or down.
<f> / <r>	specify the device as fixed or removable.
<x>	exclude or include the device to boot.
<Shift + 1>	enable or disable the device.
<1 - 4>	load default boot sequence.

4.7.2 Boot Features

PhoenixBIOS Setup Utility		
		Boot
Boot Features		Item Specific Help
Quick Boot	[Enabled]	Allows the BIOS to skip certain tests while booting. This will decrease the time needed to boot the system.
Full Logo Display	[Enabled]	
Bootup Num-Lock	[On]	
PS/2 Mouse	[Auto Detect]	
Summary screen:	[Enabled]	
POST Errors	[Enabled]	
SETUP prompt	[Enabled]	
Interrupt 19 Capture	[Enabled]	

F1 Help	↑↓ Select Item	~/+ Change Values	F9 Setup Defaults
ESC Exit	→← Select Menu	Enter Select ▶ Sub-Menu	F10 Save and Exit

Quick Boot [Enabled]

Enabling this item allows the BIOS to skip some power on self tests (POST) while booting to decrease the time needed to boot the system. When set to [Disabled], BIOS performs all the POST items.

Configuration options: [Disabled] [Enabled]

Full Logo Display [Enabled]

Allows you to enable or disable the full screen logo display feature.

Configuration options: [Disabled] [Enabled]

Bootup Num-Lock [On]

Allows you to select the power-on state for the NumLock.

Configuration options: [Auto] [On] [Off]

PS/2 Mouse [Auto Detect]

Allows you to enable or disable support for PS/2 mouse.

Configuration options: [Disabled] [Enabled] [Auto Detect]

Summary screen: [Enabled]

When this item is enabled, the system configuration is displayed during POST.

Configuration options: [Disabled] [Enabled]

POST Errors [Enabled]

When set to [Enabled], the system waits for the <F1> key to be pressed when error occurs. Configuration options: [Disabled] [Enabled]

SETUP prompt [Enabled]

When this item is set to [Enabled], the system displays the message “Press DEL to run Setup” during POST. Configuration options: [Disabled] [Enabled]

Interrupt 19 Capture [Enabled]

When set to [Enabled], this function allows the option ROMs to trap Interrupt 19. Configuration options: [Disabled] [Enabled]

4.8 Exit menu

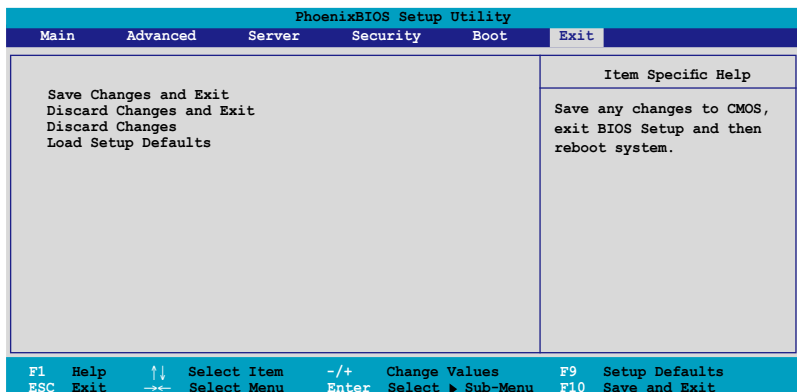

Save Changes and Exit

Select this option then press <Enter>, or simply press <F10>, to save your changes to CMOS before exiting the Setup utility.

When a confirmation window appears:

- select [Yes], then press <Enter> to save and exit.
- select [No], then press <Enter>, or simply press <Esc>, to cancel the command and return to the Exit menu.

Discard Changes and Exit

Select this option then press <Enter> if you wish to exit the Setup utility without saving your changes.

When a confirmation window appears:

- select [Yes], then press <Enter> to discard your changes and exit.
- select [No], then press <Enter>, or simply press <Esc>, to cancel the command and return to the Exit menu.

Discard Changes

Select this option to discard the changes that you made, and restore the previously saved values.

When a confirmation window appears:

- select [Yes], then press <Enter> to discard any changes and load the previously saved values.
- select [No], then press <Enter>, or simply press <Esc>, to cancel the command and return to the Exit menu.

Load Setup Defaults

Select this option then press <Enter>, or simply press <F9>, to load the optimized values for each of the Setup menu items.

When a confirmation window appears:

- select [Yes], then press <Enter> to load the default values.
- select [No], then press <Enter>, or simply press <Esc>, to cancel the command and return to the Exit menu.

This chapter provides instructions for setting up, creating, and configuring RAID sets using the available utilities.

5 RAID configuration

5.1	Setting up RAID.....	5-1
5.2	LSI Logic Embedded SATA RAID Setup Utility.....	5-3
5.3	Intel® Matrix Storage Manager Option ROM Utility	5-30
5.4	Global Array Manager.....	5-38
5.5	LSI Logic MPT Setup Utility (<i>DSBF-DE/SAS model only</i>).....	5-39

5.1 Setting up RAID

The motherboard comes with the following RAID solutions:

DSBF-DE series model

- LSI Logic Embedded SATA RAID and the Intel Matrix Storage Manager embedded in the Intel 6321ESB Southbridge supports Serial ATA hard disk drives and RAID0, RAID1 and RAID0+1 configurations. The Intel Matrix Storage Manager also supports RAID5 configuration.

DSBF-DE/SAS model only

- LSI1068 PCI-X SAS controller supports SAS disk drives and RAID0, RAID1, and RAID1E configuration.

5.1.1 RAID definitions

RAID 0 (*Data striping*) optimizes two identical hard disk drives to read and write data in parallel, interleaved stacks. Two hard disks perform the same work as a single drive but at a sustained data transfer rate, double that of a single disk alone, thus improving data access and storage. Use of two new identical hard disk drives is required for this setup.

RAID 1 (*Data mirroring*) copies and maintains an identical image of data from one drive to a second drive. If one drive fails, the disk array management software directs all applications to the surviving drive as it contains a complete copy of the data in the other drive. This RAID configuration provides data protection and increases fault tolerance to the entire system. Use two new drives or use an existing drive and a new drive for this setup. The new drive must be of the same size or larger than the existing drive.

RAID 1-E (*Enhanced RAID 1*) has a striped layout with each stripe unit having a secondary (or alternate) copy stored on a different disk. You can use three or more hard disk drives for this configuration.

RAID 0+1 is data striping and data mirroring combined without parity (redundancy data) having to be calculated and written. With the RAID 0+1 configuration you get all the benefits of both RAID 0 and RAID 1 configurations. Use four new hard disk drives or use an existing drive and three new drives for this setup.

RAID 5 stripes both data and parity information across three or more hard disk drives. Among the advantages of RAID 5 configuration include better HDD performance, fault tolerance, and higher storage capacity. The RAID 5 configuration is best suited for transaction processing, relational database applications, enterprise resource planning, and other business systems. Use a minimum of three identical hard disk drives for this setup.



If you want to boot the system from a hard disk drive included in a created RAID set, copy first the RAID driver from the support CD to a floppy disk before you install an operating system to the selected hard disk drive.

5.1.2 Installing hard disk drives

The motherboard supports Serial ATA for RAID set configuration. For optimal performance, install identical drives of the same model and capacity when creating a disk array.

To install the SATA hard disks for RAID configuration:

1. Install the SATA hard disks into the drive bays following the instructions in the system user guide.
2. Connect a SATA signal cable to the signal connector at the back of each drive and to the SATA connector on the motherboard.
3. Connect a SATA power cable to the power connector on each drive.

5.1.3 Setting the RAID item in BIOS

You must set the RAID item in the BIOS Setup before you can create a RAID set from SATA hard disk drives attached to the SATA connectors supported by the Intel® 6321ESB Southbridge chip. To do this:

1. Enter the BIOS Setup during POST.
2. Go to the **Main Menu > IDE Configuration > S-ATA Configuration**, then press <Enter>.
3. Set the **SATA Controller Mode Option** item to [Enhanced], then press <Enter>.
4. Set the **SATA RAID Enable** item to [Enabled].
5. Save your changes, then exit the BIOS Setup.



Refer to Chapter 4 for details on entering and navigating through the BIOS Setup.

5.1.4 RAID configuration utilities

Depending on the RAID connectors that you use, you can create a RAID set using the utilities embedded in each RAID controller. For example, use the **LSI Logic Embedded SATA RAID Setup Utility** or the **Intel® Matrix Storage Manager** if you installed Serial ATA hard disk drives on the Serial ATA connectors supported by the Intel® 6321ESB Southbridge.

For DSBF-DE/SAS model, you may use the **LSI1068 SAS Configuration Utility** if you installed SAS hard disk drives to the mini-SAS connector(s) supported by the LSI1068 PCI-X SAS controller.

Refer to the succeeding sections for details on how to use each RAID configuration utility.

5.2 LSI Logic Embedded SATA RAID Setup Utility

The LSI Logic Embedded SATA RAID Setup Utility allows you to create RAID 0, RAID 1, or RAID 10 set(s) from SATA hard disk drives connected to the SATA connectors supported by the motherboard Southbridge chip.

To enter the LSI Logic Embedded SATA RAID Setup Utility:

1. Turn on the system after installing all the SATA hard disk drives.
2. During POST, the LSI Logic Embedded SATA RAID Setup Utility automatically detects the installed SATA hard disk drives and displays any existing RAID set(s). Press <Ctrl> + <M> to enter the utility.

```
LSI Logic Embedded SATA RAID BIOS Version 5.4.05091647R
(c)2004 Copyright LSI Logic Corporation. All Rights Reserved.

LSI Logic Embedded SATA RAID Found at PCI Bus No: 00 Dev No: 1F
Scanning for Port 0 ... Responding: HD5722512/A SATA0 117800MB UDMA 5
Scanning for Port 1 ... Responding: HD5722512/A SATA0 117800MB UDMA 5

01 Logical drive(s) Configured.
Array# Mode Stripe Size No. Of Stripes DriveSize Status
00 Reliability 64KB(128 Sectors) 02 114376MB Online

Press Ctrl-M to run LSI Logic Embedded SATA RAID Setup Utility.
```



The LSI Logic Embedded SATA RAID auto configures to RAID 1 when the SATA to RAID Mode is enabled.

3. The utility main window appears. Use the arrow keys to select an option from the Management Menu, then press <Enter>. Refer to the Management Menu descriptions on the next page.

At the bottom of the screen is the legend box. The keys on the legend box allow you to navigate through the setup menu options or execute commands. The keys on the legend box vary according to the menu level.



Menu	Description
Configure	Allows you to create RAID 0 or RAID 1 set using the Easy Configuration or the New Configuration command. This menu also allows you to view, add, or clear RAID configurations or select the boot drive
Initialize	Allows you to initialize the logical drives of a created RAID set
Objects	Allows you to initialize logical drives or change the logical drive parameters
Rebuild	Allows you to rebuild failed drives
Check Consistency	Allows you to check the data consistency of the logical drives of a created RAID set

5.2.1 Creating a RAID 0 or RAID 1 set

The LSI Logic Embedded SATA RAID Setup Utility allows you to create a RAID 0 or RAID 1 set using two types of configurations: **Easy** and **New**.

In Easy Configuration, the logical drive parameters are set automatically including the size and stripe size (RAID 1 only).

In New Configuration, you manually set the logical drive parameters and assign the set size and stripe size (RAID 1 only).

Using Easy Configuration

To create a RAID set using the Easy Configuration option:

1. From the utility main menu, highlight **Configure**, then press <Enter>.
2. Use the arrow keys to select **Easy Configuration**, then press <Enter>.



- The **ARRAY SELECTION MENU** displays the available drives connected to the SATA ports. Select the drives you want to include in the RAID set, then press <SpaceBar>. When selected, the drive indicator changes from **READY** to **ONLIN A[X]-[Y]**, where X is the array number, and Y is the drive number.

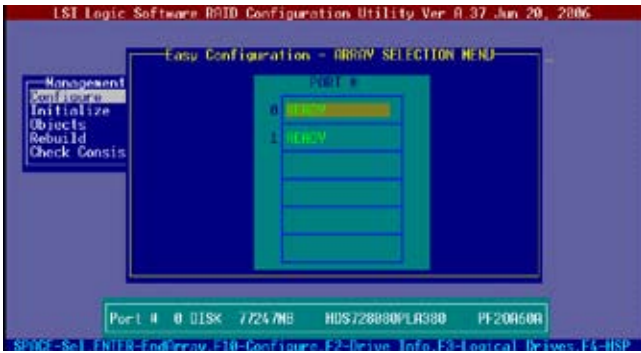

The information of the selected hard disk drive displays at the bottom of the screen.

- Select all the drives required for the RAID set, then press <Enter>. The configurable array appears on screen.



- Press <F10>, select the configurable array, then press <SpaceBar>.

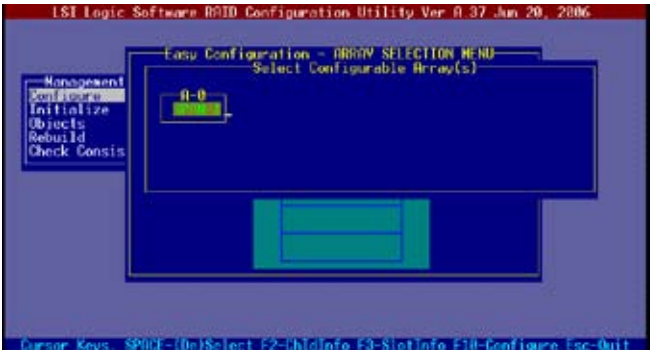

Press <F10> again, the logical drive information appears including a **Logical Drive** menu that allows you to change the logical drive parameters.

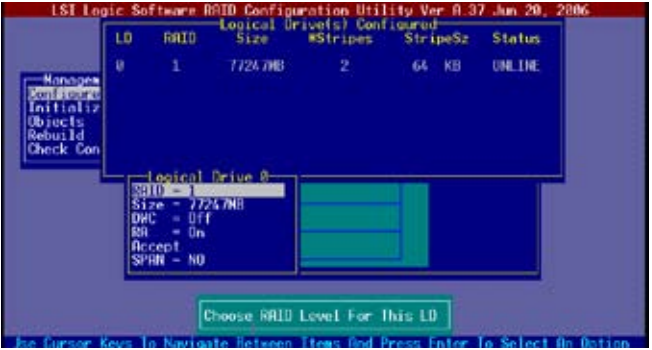

6. Select **RAID** from the **Logical Drive** menu, then press <Enter>.
7. Select the **RAID** level from the menu, then press <Enter>.



You need at least two identical hard disk drives when creating a RAID 1 set.

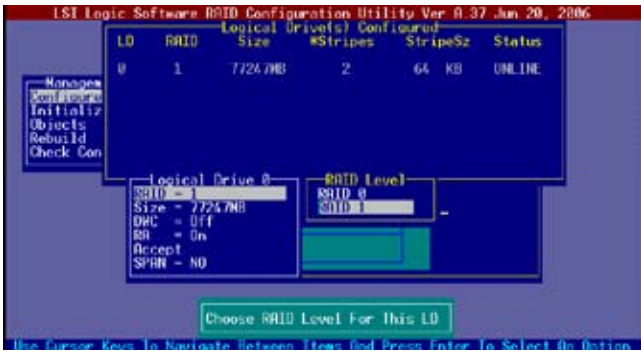

8. When creating a **RAID 1** set, select **DWC** from the **Logical Drive** menu, then press <Enter>.
When creating a **RAID 0** set, proceed to step 10.
9. Select **On** to enable the **Disk Write Cache** setting, then press <Enter>.

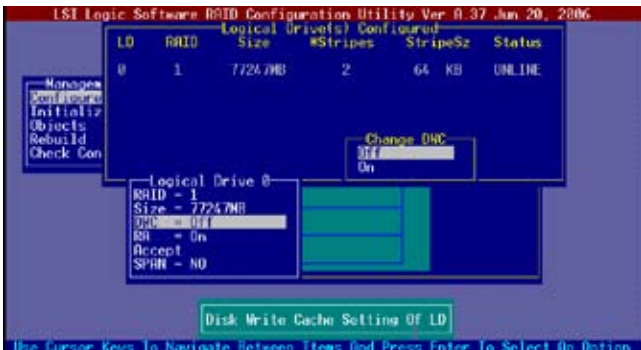

Enabling DWC can improve the performance, but with the risk of data loss.

- When finished setting the selected logical drive configuration, select **Accept** from the menu, then press <Enter>.

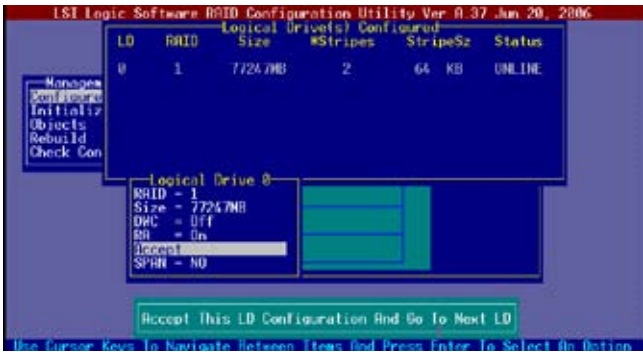

- When finished setting the selected logical drive configuration, select **Accept** from the menu, then press <Enter>.
- Follow steps 5 to 10 to configure additional logical drives.
- When prompted, save the configuration, then press <Esc> to return to the **Management Menu**.



Using New Configuration



When a RAID set is already existing, using the **New Configuration** command erases the existing RAID configuration data. If you do not want to delete the existing RAID set, use the **View/Add Configuration** command to view or create another RAID configuration.

To create a RAID set using the New Configuration option:

1. From the utility main menu, highlight **Configure**, then press <Enter>.
2. Use the arrow keys to select **New Configuration**, then press <Enter>.



3. Follow steps 3 to 7 of the previous section.
4. Select **Size** from the **Logical Drive** menu, then press <Enter>.
5. Key-in the desired logical drive size, then press <Enter>.

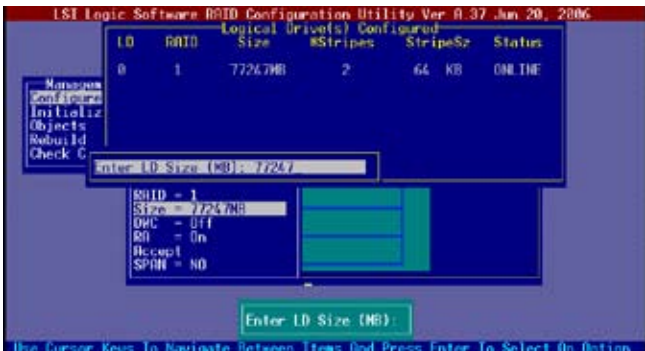

6. Follow steps 8 to 13 of the previous section to create the RAID set.

5.2.2 Creating a RAID 10 set

You can create a RAID 10 set using four identical hard disk drives.

To create a RAID 10 set using the Easy Configuration option:

1. From the utility main menu, highlight **Configure**, then press <Enter>.
2. Use the arrow keys to select **Easy Configuration**, then press <Enter>.



3. The **ARRAY SELECTION MENU** displays the available drives connected to the SATA ports. Select the drive(s) you want to include in the RAID set, then press <SpaceBar>. When selected, the drive indicator changes from **READY** to **ONLIN A[X]-[Y]**, where X is the array number, and Y is the drive number.

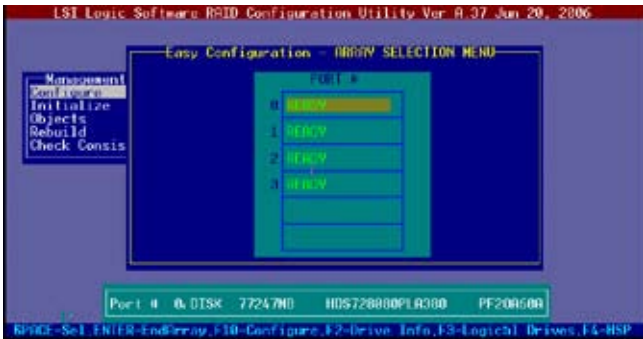

The information of the selected hard disk drive displays at the bottom of the screen.

4. Select all the drives required for the RAID 10 set, then press <Enter>. The configurable array appears on screen.



5. Press <F10>, select the configurable array, then press <SpaceBar>.



Press <F10> again, the logical drive information appears including a **Logical Drive** menu that allows you to change the logical drive parameters.

6. Select **RAID** from the **Logical Drive** menu, then press <Enter>.
7. Select **RAID 10** from the menu, then press <Enter>.



You need at least four identical hard disk drives when creating a RAID 10 set.



8. Select **DWC** from the **Logical Drive** menu, then press <Enter>.
9. Select **On** to enable the **Disk Write Cache** setting, then press <Enter>.



10. When finished setting the selected logical drive configuration, select **Accept** from the menu, then press <Enter>.

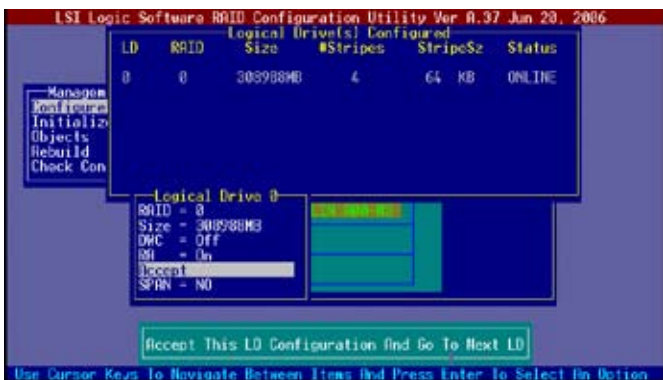

11. When prompted, save the configuration, then press <Esc> to return to the **Management Menu**.



5.2.3 Adding or viewing a RAID configuration

You can add a new RAID configuration or view an existing configuration using the **View/Add Configuration** command.

Adding a new RAID configuration

To add a new RAID configuration:

1. From the **Management Menu**, highlight **Configure**, then press <Enter>.
2. Use the arrow keys to select **View/Add Configuration**, then press <Enter>.



3. The **ARRAY SELECTION MENU** displays the available drives connected to the SATA ports. Select the drive(s) you want to include in the RAID set, then press <SpaceBar>. When selected, the drive indicator changes from **READY** to **ONLIN A[X]-[Y]**, where X is the array number, and Y is the drive number.

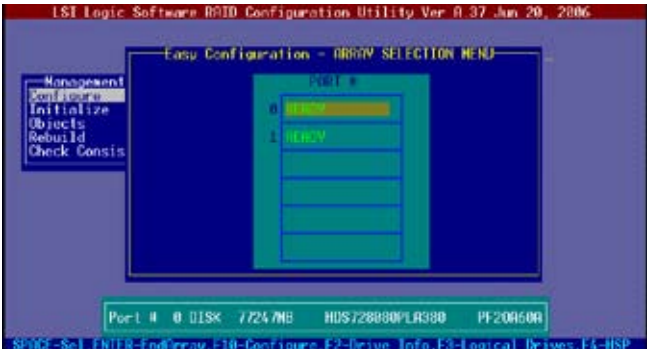

The information of the selected hard disk drive displays at the bottom of the screen.

4. Select all the drives required for the RAID set, then press <Enter>. The configurable array appears on screen.

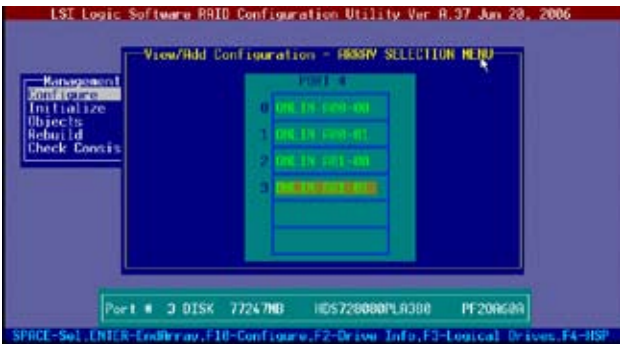

5. Press <F10>, select the configurable array, then press <SpaceBar>.

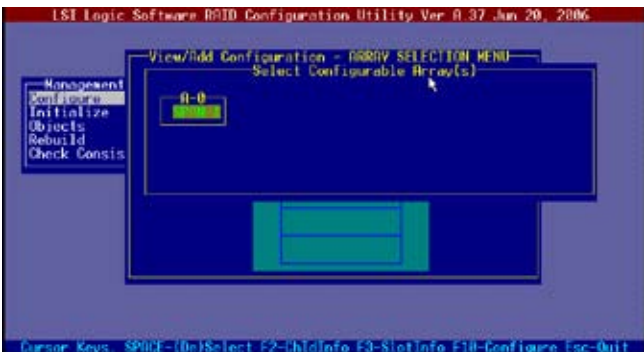

6. Press <F10> again, and select **RAID** from the **Logical Drive** menu, then press <Enter>.
7. Select the RAID level from the menu, then press <Enter>.

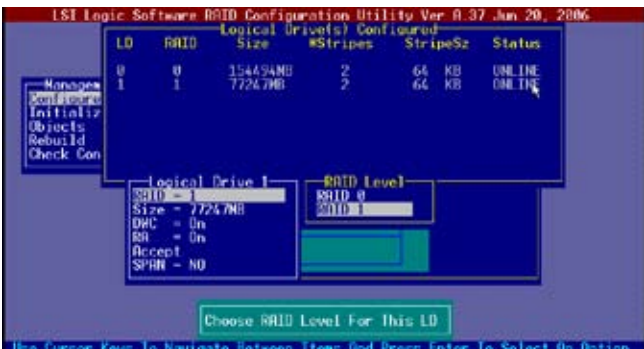

8. Follow steps 8 to 12 of the **Creating a RAID set: Using Easy Configuration** section.
9. When prompted, save the configuration, then press <Esc> to return to the **Management Menu**.



10. Follow steps 8 to 13 of the **Creating a RAID set: Using Easy Configuration** section to add the new RAID configuration.

5.2.4 Initializing the logical drives

After creating the RAID set(s), you must initialize the logical drives. You may initialize the logical drives of a RAID set(s) using the **Initialize** or **Objects** command on the **Management Menu**.

Using the Initialize command

To initialize the logical drive using the Initialize command:

1. From the **Management Menu**, highlight **Initialize**, then press <Enter>.



2. The screen displays the available RAID set(s) and prompts you to select the logical drive to initialize. Use the arrow keys to select the logical drive from the **Logical Drive** selection, then press <Enter>.

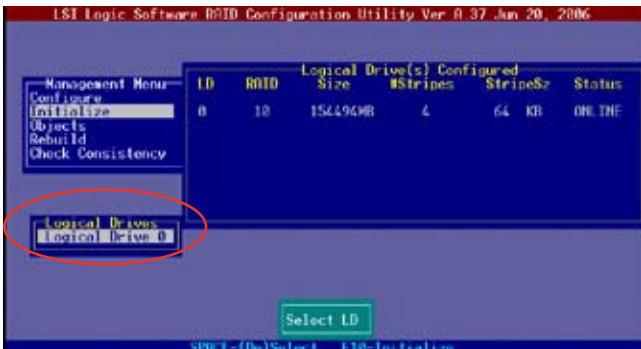

- When prompted, press the <SpaceBar> to select **Yes** from the **Initialize?** dialog box, then press <Enter>. You may also press <F10> to initialize the drive without confirmation.

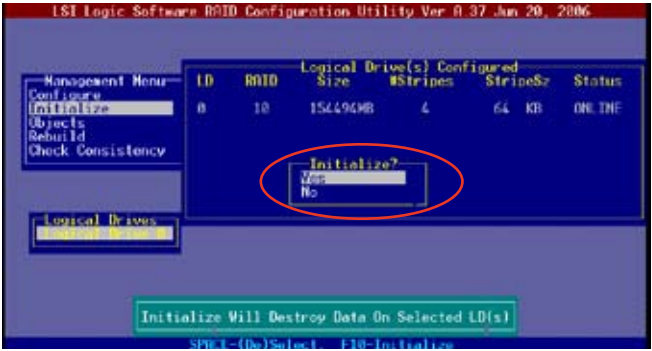

Initializing a logical drive(s) erases all data on the drive.

- A progress bar appears on screen. If desired, press <Esc> to abort initialization.



- When initialization is completed, press <Esc>.



Using the Objects command

To initialize the logical drives using the **Objects** command:

- From the **Management Menu**, highlight **Objects**, then press <Enter>.



2. Select **Logical Drive** from the **Objects** sub-menu, then press <Enter>.

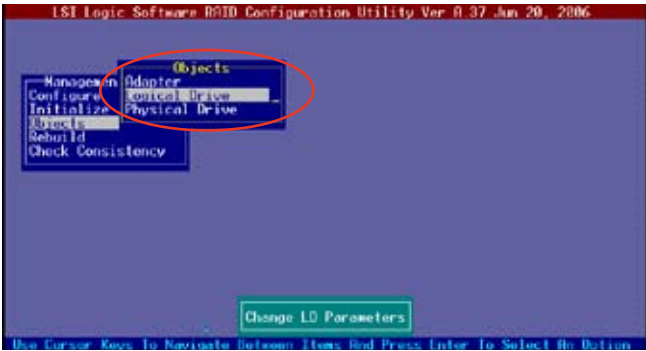

3. Select the logical drive to initialize from the **Logical Drives** sub-menu, then press <Enter>.

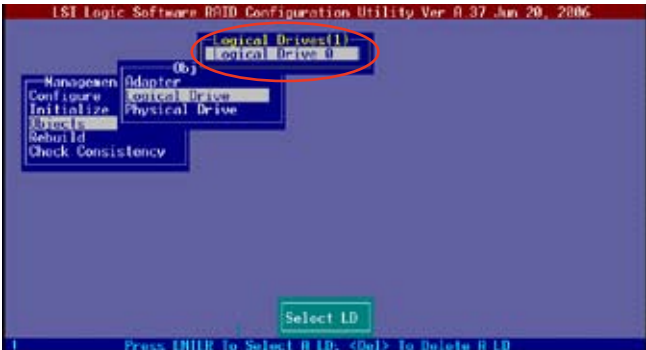

4. Select **Initialize** from the pop-up menu, then press <Enter> to start initialization.

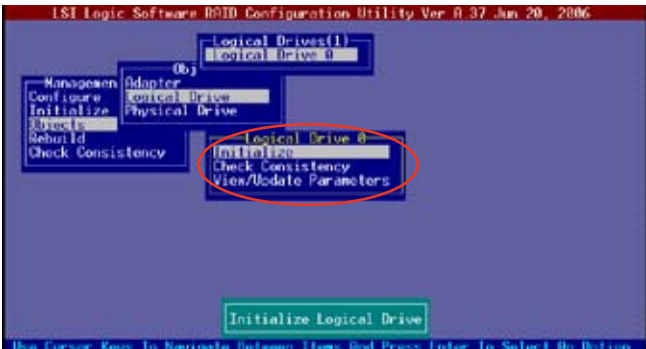

5. When prompted, press the <SpaceBar> to select **Yes** from the **Initialize? dialog** box, then press <Enter>.

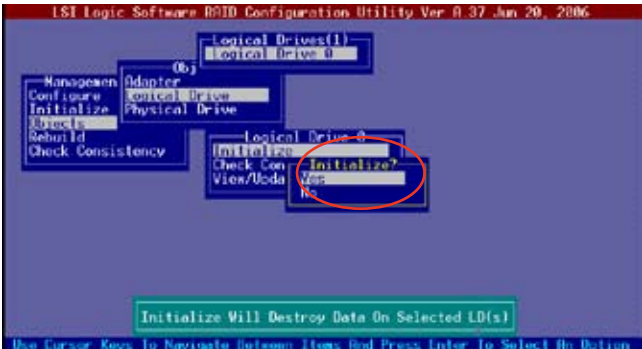

6. A progress bar appears on screen. If desired, press <Esc> to abort initialization.



7. When initialization is completed, press <Esc>.



5.2.5 Rebuilding failed drives

You can manually rebuild failed hard disk drives using the **Rebuild** command in the Management Menu.

To rebuild a failed hard disk drive:

1. From the **Management Menu**, highlight **Rebuild**, then press <Enter>.



2. The **PHYSICAL DRIVES SELECTION MENU** displays the available drives connected to the SATA ports. Select the drive you want to rebuild, then press <SpaceBar>.



- After selecting the drive to rebuild, press <F10>. The indicator for the selected drive now shows **RBLD**.

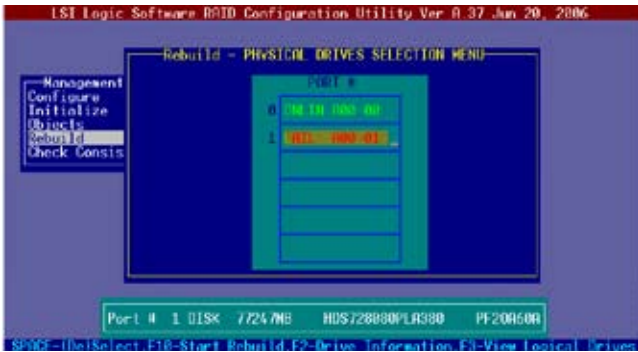

- When prompted, press <Y> to to rebuild the drive.



- When rebuild is complete, press any key to continue.

5.2.6 Checking the drives for data consistency

You can check and verify the accuracy of data redundancy in the selected logical drive. The utility can automatically detect and/or detect and correct any differences in data redundancy depending on the selected option in the **Objects > Adapter** menu.



The **Check Consistency** command is available only for logical drives included in a RAID 1 set.

Using the Check Consistency

To check data consistency using the **Check Consistency** command:

1. From the **Management Menu**, select **Check Consistency**, then press <Enter>.



2. The screen displays the available RAID set(s) and prompts you to select the logical drive to check. Press the <Spacebar> to select the logical drive from the **Logical Drive** selection, then press <F10>.



- When prompted, use the arrow keys to select **Yes** from the **Consistency Check** dialog box, then press <Enter>. You may also press <F10> to check the drive consistency.

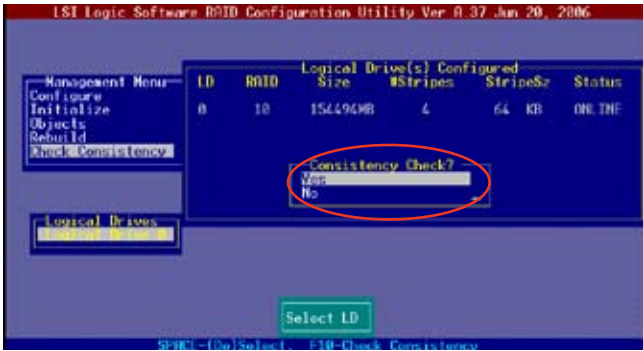

A progress bar appears on screen.



- While checking the disk consistency, press <Esc> to display the following options.
 - Stop** - Stops the consistency check. The utility stores the percentage of disk checked, When you restart checking, it continues from the last percentage completed rather than from zero percent.
 - Continue** - Continues the consistency check.
 - Abort** - Aborts the consistency check. When you restart checking, it continues from zero percent.
- When checking is complete, press any key to continue.

Using the Objects command

To check data consistency using the **Objects** command:

1. From the **Management Menu**, select **Objects**, then select **Logical Drive** from the menu.
2. Use the arrow keys to select the logical drive you want to check, then press <Enter>.
3. Select **Check Consistency** from the pop-up menu, then press <Enter>.
4. When prompted, use the arrow keys to select **Yes** from the dialog box to check the drive.
5. When checking is complete, press any key to continue.

5.2.7 Deleting a RAID configuration

To delete a RAID configuration:

1. From the **Management Menu**, select **Configure > Clear Configuration**, then press <Enter>.



2. When prompted, use the arrow keys to select **Yes** from the **Clear Configuration?** dialog box, then press <Enter>.



The utility clears the current array.

3. Press any key to continue.

5.2.8 Selecting the boot drive from a RAID set

You must have created a new RAID configuration before you can select the boot drive from a RAID set. Refer to the **Creating a RAID set: Using New Configuration** section for details.

To select the boot drive from a RAID set:

1. From the **Management Menu**, select **Configure > Select Boot Drive**, then press <Enter>.



2. When prompted, use the arrow keys to select the bootable logical drive from the list, then press <Enter>.



3. The logical drive is selected as boot drive. Press any key to continue.

5.2.9 Enabling the WriteCache

You may enable the RAID controller's WriteCache option to improve the data transmission performance.



When you enable **WriteCache**, you may lose data when a power interruption occurs while transmitting or exchanging data among the drives.

To enable WriteCache:

1. From the **Management Menu**, select **Objects > Adapter**, then press <Enter> to display the adapter properties.
2. Select **WriteCache**, then press <Enter> to turn the option **On** (enabled).



3. When finished, press any key to continue.

5.3 Intel® Matrix Storage Manager Option ROM Utility

The Intel® Matrix Storage Manager Option ROM utility allows you to create RAID 0, RAID 1, RAID 0+1, and RAID 5 set(s) from Serial ATA hard disk drives.

To enter the Intel® Matrix Storage Manager Option ROM Utility:

1. Turn on the system after installing all Serial ATA hard disk drives.
2. During POST, press <Ctrl+I> to display the utility main menu.

```
Intel(R) Matrix Storage Manager Option ROM v5.0.0.1032 ESB2 wRAID5
Copyright(C) 2003-05 Intel Corporation. All Rights Reserved.

[ MAIN MENU ]
1. Create RAID Volume
2. Delete RAID Volume
3. Reset Disks to Non-RAID
4. Exit

[ DISK/VOLUME INFORMATION ]
RAID Volumes:
None defined.

Physical Disks:
Port   Drive Model   Serial #   Size   Type/Status (Vol ID)
0      XXXXXXXXXXXX  XXXXXXXX  XX.XXGB Non-RAID Disk
1      XXXXXXXXXXXX  XXXXXXXX  XX.XXGB Non-RAID Disk
2      XXXXXXXXXXXX  XXXXXXXX  XX.XXGB Non-RAID Disk
3      XXXXXXXXXXXX  XXXXXXXX  XX.XXGB Non-RAID Disk

[↑↓]-Select  [ESC]-Exit  [ENTER]-Select Menu
```

The navigation keys at the bottom of the screen allow you to move through the menus and select the menu options.



The RAID BIOS setup screens shown in this section are for reference only and may not exactly match the items on your screen.



The utility supports maximum four hard disk drives for RAID configuration.

5.3.1 Creating a RAID 0 set (Stripe)

To create a RAID 0 set:

1. From the utility main menu, select **1. Create RAID Volume**, then press <Enter>. This screen appears.

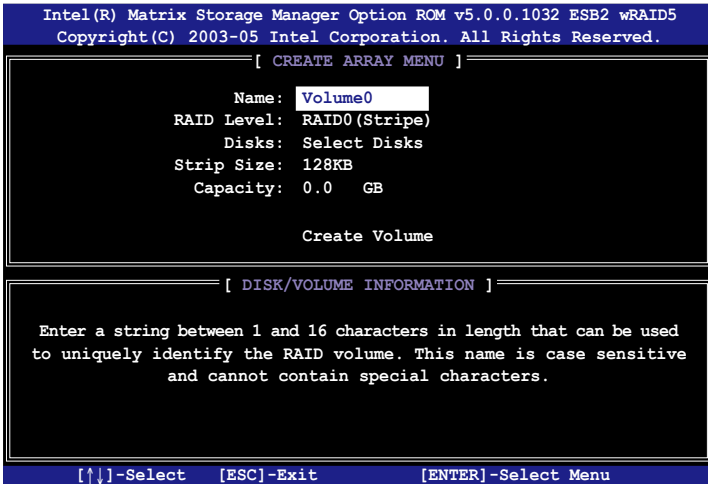

2. Enter a name for the RAID 0 set, then press <Enter>.
3. Highlight **RAID Level**, press the up/down arrow key to select **RAID 0 (Stripe)**, then press <Enter>.
4. Highlight the **Disks** item, then press <Enter> to select the hard disk drives you want to include in the RAID set. The **SELECT DISKS** screen appears.

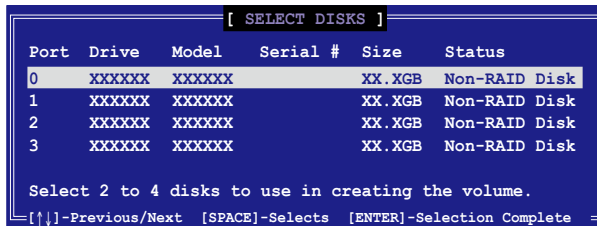

5. Use the up/down arrow key to highlight a drive, then press <Spacebar> to select. A small triangle marks the selected drive. Press <Enter> after completing your selection.

6. Use the up/down arrow key to select the stripe size for the RAID 0 array, then press <Enter>. The available stripe size values range from 4 KB to 128 KB. The default stripe size is 128 KB.



A lower stripe size is recommended for server systems. A higher stripe size is recommended for multimedia computer systems used mainly for audio and video editing.

7. Highlight the **Capacity** item, enter the desired RAID volume capacity, then press <Enter>. The default value indicates the maximum allowed capacity.
8. When the **Create Volume** item is highlighted, press <Enter>. A warning message appears.

```
WARNING: ALL DATA ON SELECTED DISKS WILL BE LOST.  
Are you sure you want to create this volume? (Y/N):
```

9. Press <Y> to create the RAID volume and return to the main menu, or <N> to go back to the **Create Array** menu.

5.3.2 Creating a RAID 1 set (Mirror)

To create a RAID 1 set:

1. From the utility main menu, select **1. Create RAID Volume**, then press <Enter>. This screen appears.

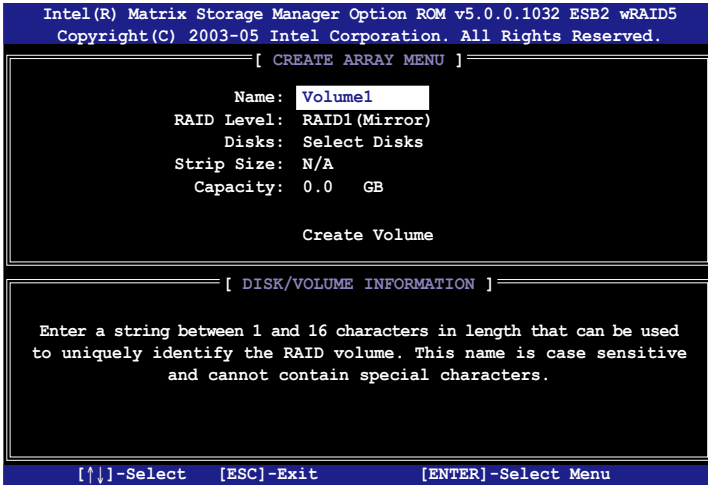

2. Enter a name for the RAID 1 set, then press <Enter>.
3. Highlight **RAID Level**, press the up/down arrow key to select **RAID 1 (Mirror)**, then press <Enter>.
4. Follow steps 4 to 5 and 7 to 9 of the previous section to create the RAID 1 set.

5.3.3 Creating a RAID 10 set (Stripe + Mirror)

To create a RAID 10 set:

1. From the utility main menu, select **1. Create RAID Volume**, then press <Enter>. This screen appears.

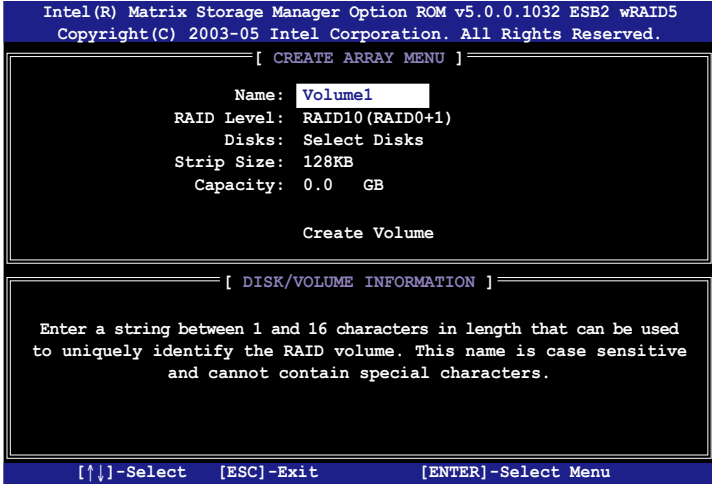

2. Enter a name for the RAID 10 set, then press <Enter>.
3. Highlight **RAID Level**, press the up/down arrow key to select **RAID 10 (RAID0+1)**, then press <Enter>.
4. Follow steps 4 to 9 of section “5.3.1 Creating a RAID 0 set (striped)” to create the RAID 10 set.

5.3.4 Creating a RAID 5 set (Parity)

To create a RAID 5 set:

1. From the utility main menu, select **1. Create RAID Volume**, then press <Enter>. This screen appears.

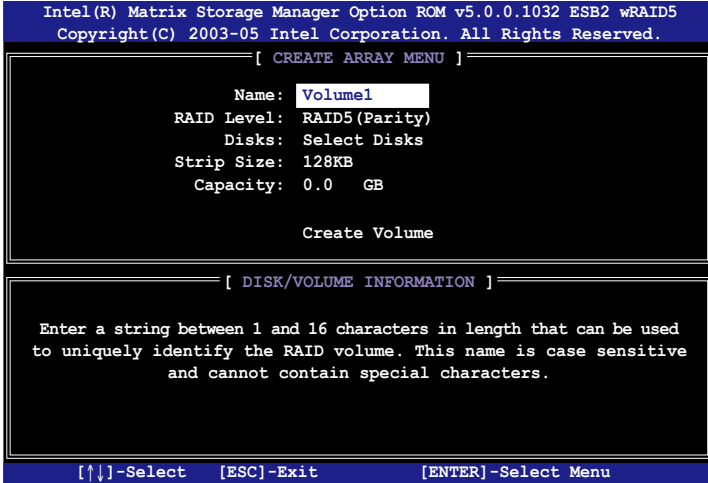

2. Enter a name for the RAID 10 set, then press <Enter>.
3. Highlight **RAID Level**, press the up/down arrow key to select **RAID5**, then press <Enter>.
4. Follow steps 4 to 9 of section “5.3.1 Creating a RAID 0 set (striped)” to create the RAID 5 set.

5.3.5 Deleting a RAID set



Take caution when deleting a RAID set. You will lose all data on the hard disk drives when you delete a RAID set.

To delete a RAID set:

1. From the utility main menu, select **2. Delete RAID Volume**, then press <Enter> to display this screen.

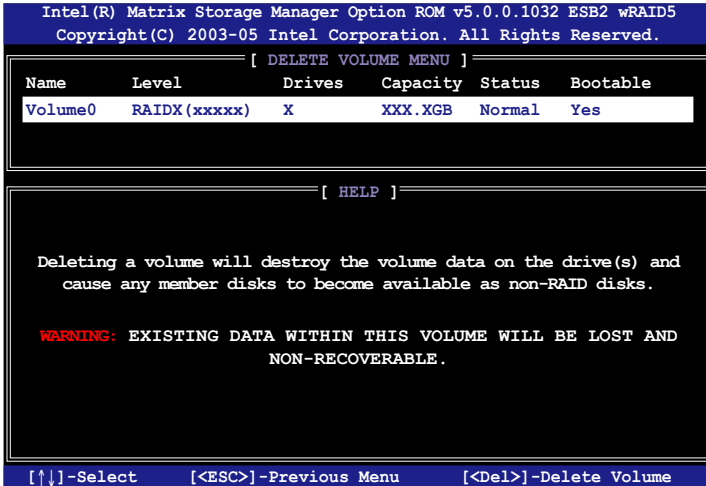

2. Use the up/down arrow key to select the RAID set you want to delete, then press . This window appears.



3. Press <Y> to delete the RAID set and return to the utility main menu; otherwise, press <N> to return to the **Delete Volume** menu.

5.3.6 Resetting disks to Non-RAID



Take caution before you reset a RAID volume hard disk drive to non-RAID. Resetting a RAID volume hard disk drive deletes all internal RAID structure on the drive.

To reset a RAID set hard disk drive:

1. From the utility main menu, select **3. Reset Disks to Non-RAID**, then press <Enter> to display this screen.

```
[ RESET RAID DATA ]

Resetting RAID data will remove internal RAID structures
from the selected RAID disks. By removing these structures,
the drive will revert back to a non-RAID disk.

WARNING: Resetting a disk causes all data on the disk to
be lost.

Port  Drive Model      Serial #      Size  Status
---  -
0     XXXXXXXXXXXX      XXXXXXXX     XX.XGB Member Disk
1     XXXXXXXXXXXX      XXXXXXXX     XX.XGB Member Disk

Select the disks that should be reset.

[↑↓]-Previous/Next [SPACE]-Selects [ENTER]-Selection Complete
```

2. Use the up/down arrow key to highlight the RAID set drive you want to reset, then press <Spacebar> to select.
3. Press <Enter> to reset the RAID set drive. A confirmation message appears.
4. Press <Y> to reset the drive or press <N> to return to the utility main menu.
5. Follow steps 2 to 4 to select and reset other RAID set drives.

5.3.7 Exiting the Intel® Matrix Storage Manager

To exit the utility:

1. From the utility main menu, select **4. Exit**, then press <Enter>. This window appears.

```
[ CONFIRM EXIT ]

Are you sure you want to exit? (Y/N):
```

2. Press <Y> to exit or press <N> to return to the utility main menu.

5.4 Global Array Manager

You may also create a RAID set(s) in Windows® operating environment using the Global Array Manager (GAM) application. The GAM application is available from the motherboard support CD.



Refer to the GAM user guide in the motherboard support CD for details.

5.5 LSI Logic MPT Setup Utility (DSBF-DE/SAS model only)

The LSI Logic MPT Setup Utility is an integrated RAID solution that allows you to allow you to create the following RAID set(s) from SAS hard disk drives supported by the LSI1068 PCI-X SAS controller:

- RAID 1 (Integrated Mirroring)
- RAID 1E (Integrated Mirroring Enhanced)
- RAID 0 (Integrated Striping)

5.5.1 Integrated Mirroring

Overview

The Integrated Mirroring (IM) feature supports simultaneous mirrored volumes with two disks (IM). Integrated Mirroring Enhanced (IME) supports three to eight disks, or seven mirrored disks plus a hot spare disk.

The IM feature supports hot swap capability, so when a disk in an IM volume fails, you can easily restore the volume, and the swapped disk is automatically re-mirrored.

Creating Integrated Mirroring volumes



- You may use disks of different sized in IM and IME volumes; however, the size of the smallest disk determines the “logical” size of each member disk.
- Do not combine Serial ATA and SAS disks in one volume.
- The RAID BIOS setup screens shown in this section are for reference only and may not exactly match the items on your screen.

To create an IM volume:

1. Turn on the system after installing all SAS hard disk drives.
2. During POST, press <Ctrl+C> to enter the SAS configuration utility.

```
LSI Logic Corp. MPT SAS BIOS
MPTBIOS-6.08.05.00 (2006.08.02)
Copyright 2000-2006 LSI Logic Corp.

Adapter(s) disabled by user
Press Ctrl-C to start LSI Logic Configuration Utility...
```

- The following screen appears. Select a channel and press <Enter> to enter the setup.

```

LSI Logic Config Utility          v6.08.05.00 (2006.08.02)
Adapter List Global Properties
Adapter  PCI      PCI      PCI      PCI      FW Revision      Status      Boot
          Bus     Dev     Func    Slot
SAS1066  05     03     00     00     1.15.00.00-IR   Disabled    0
  
```

Esc = Exit Menu F1/Shift+1 = Help
 Alt+N = Global Properties -/+ = Alter Boot Order Ins/Del = Alter Boot List



The numbers of the channel depend on the controller.

- The **Adapter Properties** screen appears. Use the arrow keys to select **RAID Properties**, then press <Enter>.

```

LSI Logic Config Utility          v6.08.05.00 (2006.08.02)
Adapter Properties -- SAS1066
Adapter      SAS1066
PCI Slot     00
PCI Address(Bus/Dev/Func) 05.03.00
MPT Firmware Revision 1.15.00.00_IR
SAS Address  500E0180:60831008
NVIDIA Version 25.02
Status      Disabled
Boot Order  0
Boot Support (Enabled OS only)
RAID Properties
SAS Topology
Advanced Adapter Properties
  
```

Esc = Exit Menu F1/Shift+1 = Help
 Enter = Select Item -/+ = Change Item

- The **Select New Array Type** screen appears. Use the arrow keys to select **Create IM Volume**, then press <Enter>.

```

LSI Logic Config Utility          v6.08.05.00 (2006.08.02)
Select New Array Type -- SAS1066
Create IM Volume      Create Integrated Mirror Array of 2
                      disks plus an optional hot spare. Data
                      on the primary disk may be migrated.
Create IME Volume     Create Integrated Mirrored Enhanced
                      Array of 3 to 8 disks including an
                      optional hot spare.
                      ALL DATA on array disks will be DELETED!
Create IS Volume      Create Integrated Striping array of
                      2 to 8 disks.
                      ALL DATA on array disks will be DELETED!
  
```

Esc = Exit Menu F1/Shift+1 = Help
 Enter = Choose array type to create

6. The Create New Array screen shows the disks you can add to make up the IM volume. Use the arrow key to select a disk, then move the cursor to the RAID Disk column. To include this disk in the array, press <+>, <->, or <Space>.

You may also specify the Hot Spare disk here. Select the disk, then move the cursor to the Hot Spr column, then press <+>, <->, or <Space>.

```
LSI Logic Config Utility          v6.08.05.00 (2006.08.02)
Create New Array -- SAS1068

Array Type:                        IM
Array Size (MB):                    -----

Slot  Device Identifier            RAID  Hot  Drive  Pred  Size
Num   Device Identifier            Disk  Spr  Status Fail  (MB)
-----
0     SEAGATE ST373454SS            0003  [NO] [NO]  -----  ---  70007
1     SEAGATE ST373454SS            0003  [NO] [NO]  -----  ---  70007
2     SEAGATE ST373454SS            0003  [NO] [NO]  -----  ---  35003
3     SEAGATE ST373454SS            0003  [NO] [NO]  -----  ---  35003

Esc = Exit Menu  F1/Shift+1 = Help
SPACE/+/- = Select disk for array or hot spare  C = Create array
```



By default, the RAID Disk field shows No before array creation. This field is grayed out under the following conditions:

- The disk does not meet the minimum requirements for use in a RAID array.
- The disk is not large enough to mirror existing data on the primary drive.
- The disk has been selected as the Hot Spare for the RAID array.
- The disk is already part of another array.

7. A confirmation screen appears.
 Press <M> to keep existing data on the first disk. If you choose this option, data on the first disk will be mirrored on the second disk that you will add to the volume later. Make sure the data you want to mirror is on the first disk.
 Press <D> to overwrite any data and create the new IM array.

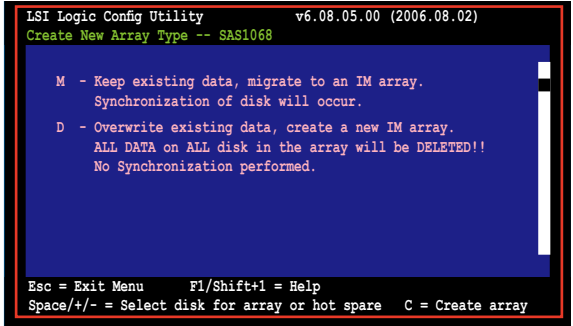

8. Repeat steps 5 and 6 to add the second disk to the volume.
9. When done, press <C> to create the array, then select Save changes then exit this menu then exit this menu.

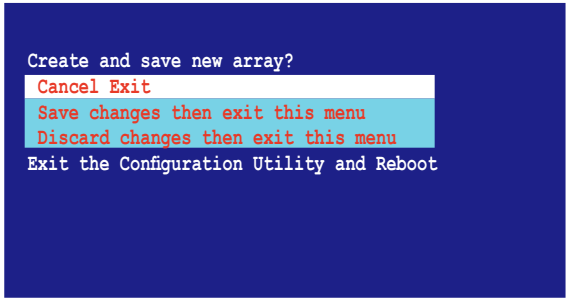

10. The utility creates the array.

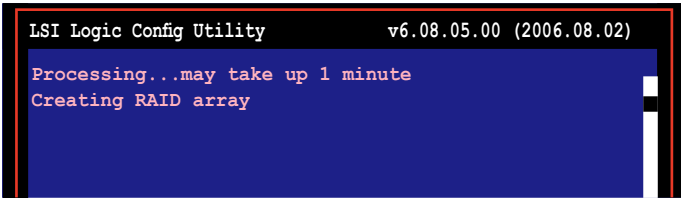

5.5.2 Integrated Mirroring Enhanced

To create an IME volume:

1. The **Adapter Properties** screen appears.
Use the arrow keys to select **RAID Properties**, then press <Enter>.

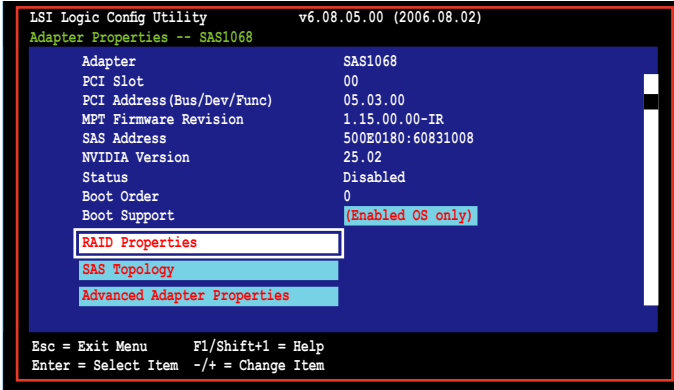

2. The **Select New Array Type** screen appears.
Use the arrow keys to select **Create IME Volume**, then press <Enter>.

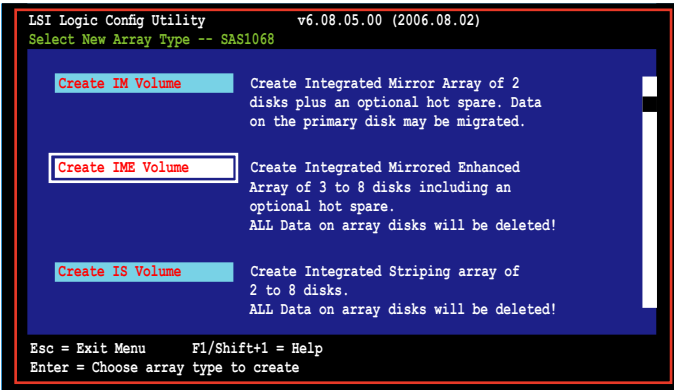

- The **Create New Array** screen shows the disks you can add to make up the IME volume.

Integrated Mirroring Enhanced (IME) supports three to eight disks, or seven mirrored disks plus a hot spare disk. Use the arrow key to select a disk, then move the cursor to the RAID Disk column. To include this disk in the array, press <+>, <->, or <Space>.

You may also specify the Hot Spare disk here. Select the disk, then move the cursor to the Hot Spr column, then press <+>, <->, or <Space>.

```

LSI Logic Config Utility          v6.08.05.00 (2006.08.02)
Create New Array -- SAS1068

Array Type:                       IME
Array Size (MB):                   51498

Slot  Device Identifier            RAID  Hot  Drive  Pred  Size
Num   ID                          Disk  Spr  Status Fail  (MB)
-----
0     SEAGATE ST373454SS           [Yes] [NO]  -----  ---  70007
1     SEAGATE ST373454SS           [NO]  [NO]  -----  ---  70007
2     SEAGATE ST373454SS           [Yes] [NO]  -----  ---  35003
3     SEAGATE ST373454SS           [Yes] [NO]  -----  ---  35003

Esc = Exit Menu    F1/Shift+l = Help
SPACE/+/- = Select disk for array or hot spare  C = Create array
  
```



By default, the RAID Disk field shows No before array creation. This field is grayed out under the following conditions:

- The disk does not meet the minimum requirements for use in a RAID array.
- The disk is not large enough to mirror existing data on the primary drive.
- The disk has been selected as the Hot Spare for the RAID array.
- The disk is already part of another array.

- Repeat step 5 to add the other disks to the volume.
- When done, press <C> to create the array, then select Save changes then exit this menu then exit this menu.

```

Create and save new array?
Cancel Exit
Save changes then exit this menu
Discard changes then exit this menu
Exit the Configuration Utility and Reboot
  
```

- The utility creates the array.

```

LSI Logic Config Utility          v6.08.05.00 (2006.08.02)

Processing...may take up 1 minute
Creating RAID array
  
```

5.5.3 Integrated Striping (IS) volume

Overview

The Integrated Striping (IS) feature provides RAID 0 functionality, supporting volumes with two to eight disks. You may combine an IS volume with an IM or IME volume.

Creating Integrated Striping volumes



Do not combine Serial ATA and SAS disks in one volume.

To create an IS volume:

1. Turn on the system after installing all SAS hard disk drives.
2. During POST, press <Ctrl+C> to enter the SAS configuration utility.

```
LSI Logic Corp. MPT SAS BIOS
MPTBIOS-6.08.05.00 (2006.08.02)
Copyright 2000-2006 LSI Logic Corp.

Adapter(s) disabled by user
Press Ctrl-C to start LSI Logic Configuration Utility...
```

3. The **Adapter Properties** screen appears. Use the arrow keys to select **RAID Properties**, then press <Enter>.

```
LSI Logic Config Utility          v6.08.05.00 (2006.08.02)
Adapter Properties -- SAS1068

Adapter          SAS1068
PCI Slot         00
PCI Address(Bus/Dev/Func)  05.03.00
MPT Firmware Revision  1.15.00.00-IR
SAS Address      500E0180:60831008
NVIDIA Version    25.02
Status           Disabled
Boot Order       0
Boot Support     (Enabled OS only)
RAID Properties
SAS Topology
Advanced Adapter Properties

Esc = Exit Menu      F1/Shift+1 = Help
Enter = Select Item  -/+ = Change Item
```

- The **Select New Array Type** screen appears. Use the arrow keys to select **Create IS Volume**, then press <Enter>.

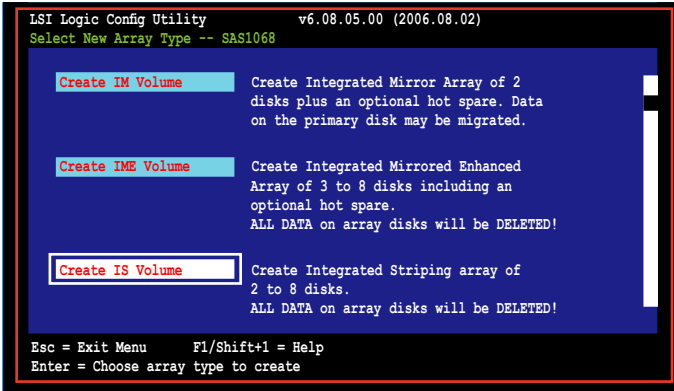

- The **Create New Array** screen shows the disks you can add to make up the IS volume. Use the arrow key to select a disk, then move the cursor to the RAID Disk column. To include this disk in the array, press <+>, <->, or <Space>.

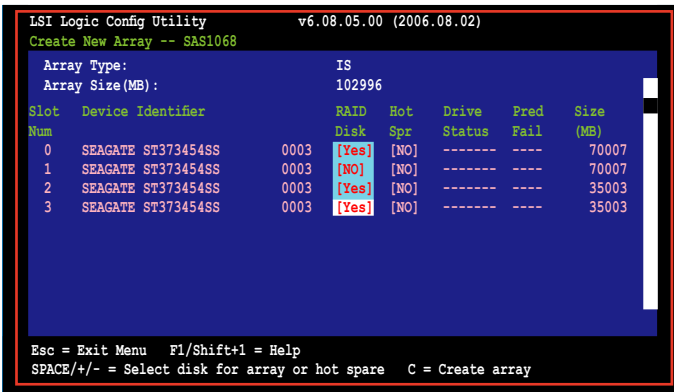



By default, the RAID Disk field shows No before array creation. This field is grayed out under the following conditions:

- The disk does not meet the minimum requirements for use in a RAID array.
- The disk is not large enough to mirror existing data on the primary drive.
- The disk has been selected as the Hot Spare for the RAID array.
- The disk is already part of another array.

6. Repeat step 5 to add the other disks to the volume.
7. When done, press <C> to create the array, then select Save changes then exit this menu then exit this menu.

```
Create and save new array?  
Cancel Exit  
Save changes then exit this menu  
Discard changes then exit this menu  
Exit the Configuration Utility and Reboot
```

9. The utility creates the array.

```
LSI Logic Config Utility          v6.08.05.00 (2006.08.02)  
Processing...may take up 1 minute  
Creating RAID array
```

5.5.4 Managing Arrays

The LSI Logic MPT Setup Utility allows you to perform other tasks related to configuring and maintaining IM and IME volumes.

Refer to this section to view volume properties, manage the hot spare disk, synchronize the array, activate the array, and delete the array.

Viewing volume properties

To view volume properties:

1. On the main menu, select **RAID Properties**.

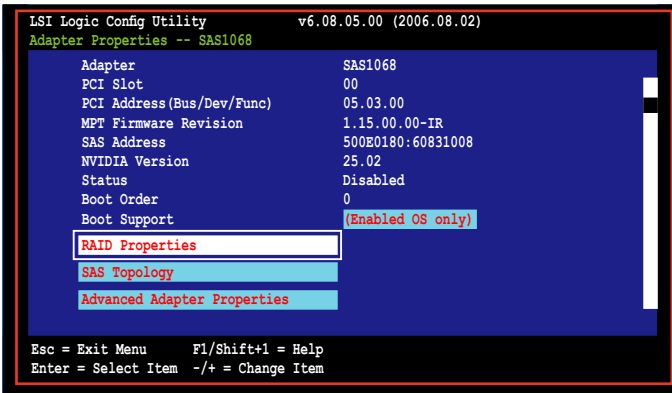

```
LSI Logic Config Utility          v6.08.05.00 (2006.08.02)
Adapter Properties -- SAS1068

Adapter          SAS1068
PCI Slot         00
PCI Address(Bus/Dev/Func) 05.03.00
MPT Firmware Revision 1.15.00.00-IR
SAS Address      500E0180:60831008
NVIDIA Version   25.02
Status          Disabled
Boot Order      0
Boot Support     (Enabled OS only)

RAID Properties
SAS Topology
Advanced Adapter Properties

Esc = Exit Menu      F1/Shift+1 = Help
Enter = Select Item  -/+ = Change Item
```

2. On the next screen that appears, select **View Existing Array**.

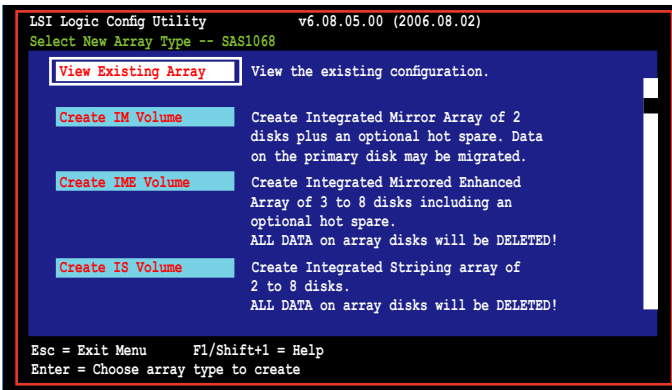

```
LSI Logic Config Utility          v6.08.05.00 (2006.08.02)
Select New Array Type -- SAS1068

View Existing Array  View the existing configuration.

Create IM Volume     Create Integrated Mirror Array of 2
                    disks plus an optional hot spare. Data
                    on the primary disk may be migrated.

Create IME Volume     Create Integrated Mirrored Enhanced
                    Array of 3 to 8 disks including an
                    optional hot spare.
                    ALL DATA on array disks will be DELETED!

Create IS Volume     Create Integrated Striping array of
                    2 to 8 disks.
                    ALL DATA on array disks will be DELETED!

Esc = Exit Menu      F1/Shift+1 = Help
Enter = Choose array type to create
```

- The **View Existing Array** screen appears. Here you can view properties of the RAID array(s) created. If you have configured a hot spare, it will also be listed. If you created more than one array, you may view the next array by pressing <Alt+N>.

```

LSI Logic Config Utility          v6.08.05.00 (2006.08.02)
View Array -- SAS1068
  Array                          1 of 1
  Identifier                      LSILOGICLogical Volume 3000
  Type                            IME
  Scan Order                      0
  Size (MB)                       51498
  Status                          Optimal

  Manage Array

Slot  Device Identifier          RAID  Hot  Drive  Pred  Size
Num   SEAGATE ST373454SS        Disk Spr Status Fail (MB)
0     SEAGATE ST373454SS        0003 Yes NO  Ok   No   34331
2     SEAGATE ST373454SS        0003 Yes NO  Ok   No   34331
3     SEAGATE ST373454SS        0003 Yes NO  Ok   No   34331

Esc = Exit Menu          F1/Shift+1 = Help
Enter=Select Item      Alt+N=Next Array  C = Create an array
  
```

Managing hot spares

You may configure one disk as a global hot spare to protect critical data on the IM/IME volume(s). You may create the hot spare disk at the same time you create the IM/IME volume. Refer to this section when adding a hot spare disk on an existing volume.



If a disk on an IM/IME volume fails, the utility automatically rebuilds the failed disk data on the hot spare. When the failed disk is replaced, the utility assigns the replacement as the new hot spare.

To create a hot spare:

1. Follow steps 1 ~ 3 of the section “Viewing volume properties.”
2. From the **View Array** screen, select **Manage Array**, then press <Enter>.

```
LSI Logic Config Utility                v6.08.05.00 (2006.08.02)
View Array -- SAS1068
Array 1 of 1
Identifier LSILOGICLogical Volume 3000
Type IME
Scan Order 0
Size(MB) 51498
Status Optimal

Manage Array

Slot RAID Hot Drive Pred Size
Num Disk Spr Status Fail (MB)
0 0003 Yes NO Ok No 34331
2 SEAGATE ST373454SS 0003 Yes NO Ok No 34331
3 SEAGATE ST373454SS 0003 Yes NO Ok No 34331

Esc = Exit Menu      F1/Shift+1 = Help
Enter=Select Item  Alt+N=Next Array  C = Create an array
```

3. From the **Manage Array** screen select **Manage Hot Spare**, then press <Enter>.

```
LSI Logic Config Utility                v6.08.05.00 (2006.08.02)
Manage Array -- SAS1068
Identifier LSILOGICLogical Volume 3000
Type IME
Scan Order 0
Size(MB) 51498
Status Optimal

Manage Hot Spare
Synchronize Array
Activate Array
Delete Array

Esc = Exit Menu      F1/Shift+1 = Help
Enter = Select Item
```

- Use the arrow key to select the disk you would like to configure as hot spare, then move the cursor to the Hot Spr column. Press <+>, <->, or <Space>. The Drive Status column field now shows Hot Spare.

Press <C> to commit the changes.

```

LSI Logic Config Utility                v6.08.05.00 (2006.08.02)
Manage Hot Spare -- SAS1068
Identifier                               LSILOGICLogical Volume 3000
Type                                     IME
Scan Order                               0
Size (MB)                                51498
Status                                    Optimal

Slot  Device Identifier                    Hot  Drive  Pred  Size
Num   Num                               Spr  Status Fail  (MB)
0     SEAGATE ST373454SS                   0003 [NO]  Ok    No   34331
1     SEAGATE ST373454SS                   0003 [NO]  Ok    No   34331
2     SEAGATE ST373454SS                   0003 [NO]  Ok    No   34331
3     SEAGATE ST373454SS                   0003 [Yes] Hot Spare No   35003
      [----] ----- --      -----

Esc = Exit Menu    F1/Shift+1 = Help
SPACE/+/- = Change Item    C = Commit Changes
  
```

Synchronizing the array

Synchronizing the array allows the utility to resynchronize data on the mirrored disk in the array. This procedure is seldom required because data synchronization is automatically done during normal operation.

To synchronize the array:

- Follow steps 1 ~ 3 of the section “Viewing volume properties” and step 2 of the section “Managing hot spares.”
- From the **Manage Array** screen select **Synncynchronize Array**, then press <Enter>.

```

LSI Logic Config Utility                v6.08.05.00 (2006.08.02)
Manage Array -- SAS1068
Identifier                               LSILOGICLogical Volume 3000
Type                                     IME
Scan Order                               0
Size (MB)                                51498
Status                                    Optimal

Manage Hot Spare
Synncynchronize Array
Activate Array
Delete Array

Esc = Exit Menu    F1/Shift+1 = Help
Enter = Select Item
  
```

- Press <Y> to begin the synchronization, or <N> to cancel.

Activating an array

If an array is removed from one controller/computer or moved to another, the array is considered inactive. When you add the array back to the system, you may reactivate the array.

To activate the array:

1. From the **Manage Array** screen, select **Activate Array**, then press <Enter>.

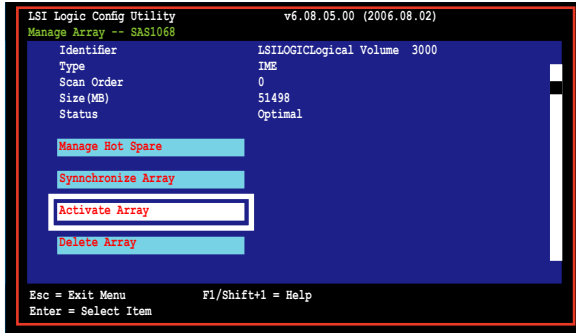

2. Press <Y> to activate, or <N> to cancel.

Deleting an array



- You cannot recover lost data if you delete an array. Make sure you back up important data before deleting an array.
- If you delete an IM (RAID 1) volume, the data is preserved on the primary disk.

To delete an array:

1. From the **Manage Array** screen, select **Delete Array**, then press <Enter>.

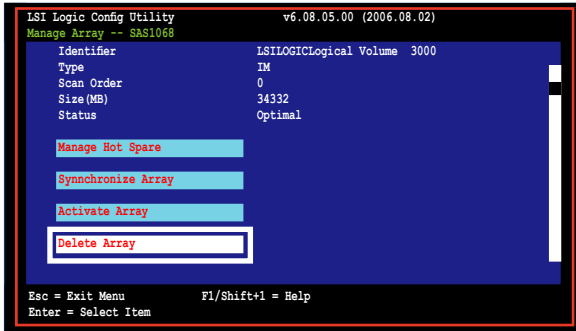

2. Press <Y> to delete, or <N> to cancel.

5.5.5 Viewing SAS topology

1. From the **Adapter Properties** screen, select **SAS Topology**.

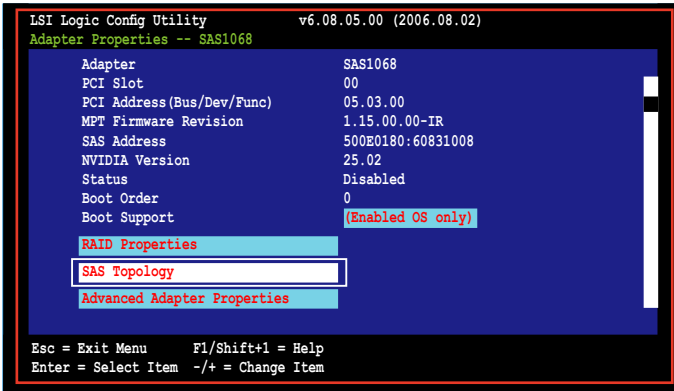

```
LSI Logic Config Utility          v6.08.05.00 (2006.08.02)
Adapter Properties -- SAS1068

Adapter          SAS1068
PCI Slot         00
PCI Address(Bus/Dev/Func) 05.03.00
MPT Firmware Revision 1.15.00.00-IR
SAS Address      500E0180:60831008
NVIDIA Version   25.02
Status           Disabled
Boot Order       0
Boot Support     (Enabled OS only)

RAID Properties
SAS Topology
Advanced Adapter Properties

Esc = Exit Menu      F1/Shift+1 = Help
Enter = Select Item  -/+ = Change Item
```

Press <Alt+D> to display device properties, or <Alt+M> to display more keys.

More keys for the SAS Topology display:

C = Clear Device Mappings for Non-Present Devices

R = Refresh SAS Topology

Enter = On a SAS Enclosure or Expander - Expand or Collapse Item

Enter = On a Disk Drive - Turn on the Locate LED (next key press turns off)

2. Information about the volume and its member-disks are then displayed.

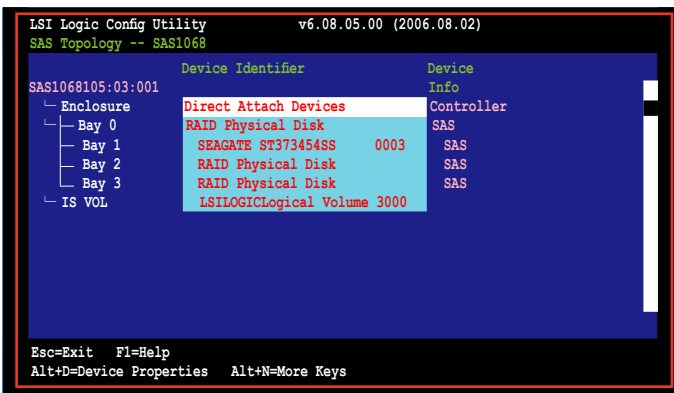

```
LSI Logic Config Utility          v6.08.05.00 (2006.08.02)
SAS Topology -- SAS1068

SAS1068105:03:001
├─ Enclosure
│   └─ Bay 0
│       └─ Bay 1
│           └─ Bay 2
│               └─ Bay 3
└─ IS VOL

Device Identifier      Device
Info
Direct Attach Devices  Controller
RAID Physical Disk    SAS
SEAGATE ST373454SS    0003  SAS
RAID Physical Disk    SAS
RAID Physical Disk    SAS
LSILOGICLogical Volume 3000
```

Selecting a boot disk

You can select a boot disk in the **SAS Topology** screen. This disk is then moved to scan ID 0 on the next boot, and remains at this position. This makes it easier to set BIOS boot device options and to keep the boot device constant during device additions and removals. There can be only one boot disk.

Follow these steps to select a boot disk:

1. In the **SAS BIOS CU**, select an adapter from the **Adapter List**.
2. Select the **SAS Topology** option.
The current topology is displayed. If the selection of a boot device is supported, the bottom of the screen lists the **Alt+B** option. This is the key for toggling the boot device. If a device is currently configured as the boot device, the **Device Info** column on the **SAS Topology** screen will show the word "Boot."
3. To select a boot disk, move the cursor to the disk and press **Alt+B**.
4. To remove the boot designator, move the cursor to the disk and press **Alt+B**. This controller will no longer have a disk designated as boot.
5. To change the boot disk, move the cursor to the new boot disk and press **Alt+B**. The boot designator will move to this disk.



The firmware must be configured correctly in order for the **Alt+B** feature to work.

```
LSI Logic Config Utility          v6.08.05.00 (2006.08.02)
Adapter List  Global Properties
Adapter      PCI   PCI   PCI   PCI   FW Revision      Status  Boot
              BUS   Dev   Fnc   Slot
SAS1068     05   03   00   00   1.15.00.00-IR   Disabled  0

Esc = Exit Menu  F1/Shift+1 = Help
Allt+N = Global Properties  -/+ = Alter Boot Order  Ins/Del = Alter Boot List
```

5.5.6 Global Properties

From the **Setup Utility** screen, press <Ctrl+C> to enter **LSI Logic Configuration**, then select **Global Properties**. The **Global Properties** menu allows you to change related settings.

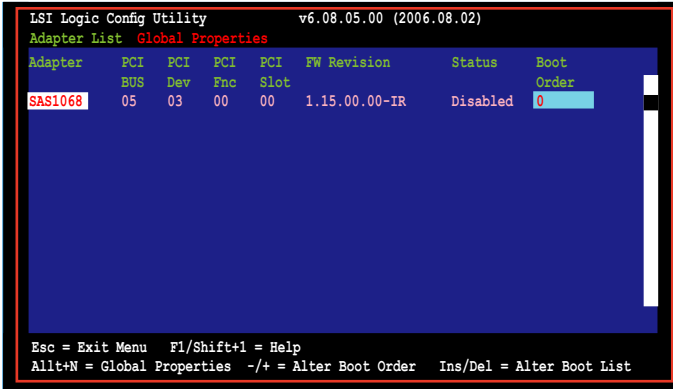

Pause When Boot Alert Displayed

Sets whether to pause or not when the boot alert displays.

Configuration options: [Yes] [No]

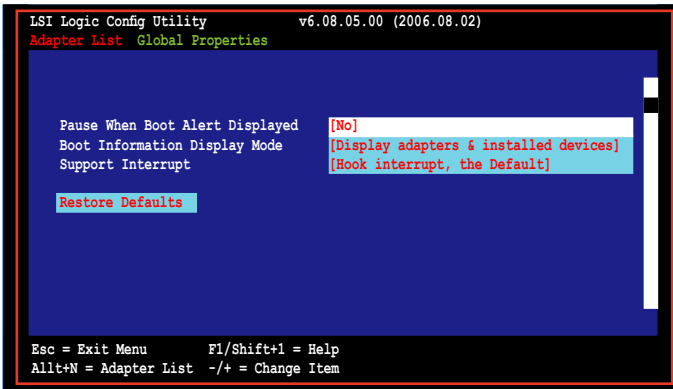

Boot Information Display Mode

Sets the disk information display mode.

Configuration options: [Display adapters & installed devices]
[Display minimal information] [Display adapters and all devices]
[Display adapters only]

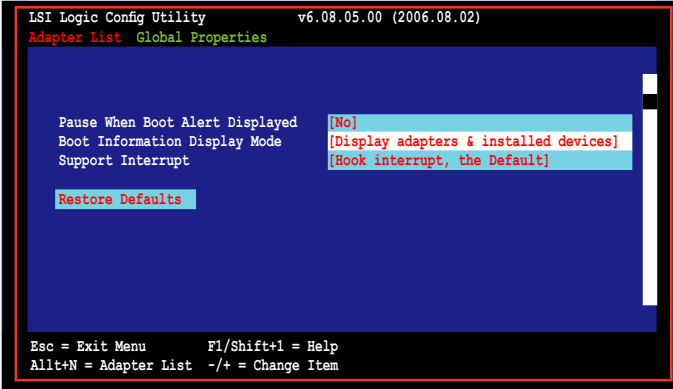

Support Interrupt

Configuration options: [Hook interrupt, the Default] [Bypass interrupt hook]

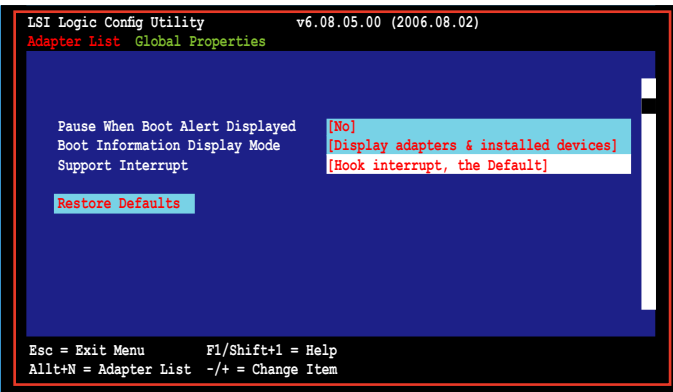

Restore Defaults

This option allows you to discard the selections you made and restore the system defaults.

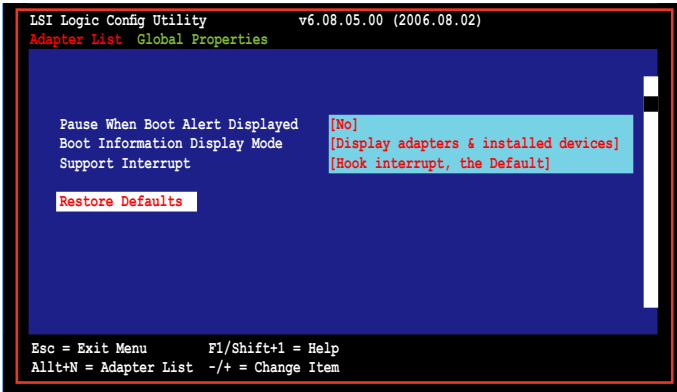

This chapter provides instructions for installing the necessary drivers for different system components.

6 Driver installation

6.1	RAID driver installation	6-1
6.2	Intel chipset software installation	6-12
6.3	LAN driver installation.....	6-15
6.4	VGA driver installation.....	6-21
6.5	Management applications and utilities installation	6-24

6.1 RAID driver installation

After creating the RAID sets for your server system, you are now ready to install an operating system to the independent hard disk drive or bootable array. This part provides instructions on how to install the RAID controller drivers during OS installation.

6.1.1 Creating a RAID driver disk



You may have to use another system to create the RAID driver disk from the system/motherboard support CD or from the Internet.

A floppy disk with the RAID driver is required when installing Windows® 2000/XP or Red Hat® Enterprise ver. 3.0/SuSE operating system on a hard disk drive that is included in a RAID set. You can create a RAID driver disk in DOS (using the Makedisk application in the support CD).

To create a RAID driver disk in DOS environment:

1. Place the motherboard support CD in the optical drive.
2. Restart the computer, then enter the BIOS Setup.
3. Select the optical drive as the first boot priority to boot from the support CD. Save your changes, then exit the BIOS Setup.
4. Restart the computer.
5. Press any key when prompted to boot from CD.

```
Loading FreeDOS FAT KERNEL GO!  
Press any key to boot from CDROM...
```

The Makedisk menu appears.

```
A) FreeDOS command prompt  
B) Create INTEL 6321 MATRIX STORAGE MANAGER for Windows 32 bit Driver Disk.  
(Also support AHCI.)  
C) Create INTEL 6321 MATRIX STORAGE MANAGER for Windows 64 bit Driver Disk.  
(Also support AHCI.)  
D) Create LSI 1068 SAS for Win2k / Win2k3 32 bit Driver Disk  
E) Create LSI 1068 SAS for RHEL3 UP6 32 bit Driver Disk  
F) Create LSI 1068 SAS for RHEL3 UP6 64 bit Driver Disk  
G) Create LSI 1068 SAS for RHEL4 UP2 32 bit Driver Disk  
H) Create LSI 1068 SAS for RHEL4 UP2 64 bit Driver Disk  
I) Create INTEL 6321 LSI MegaRAID for Windows 32 bit Driver Disk  
J) Create INTEL 6321 LSI MegaRAID for Windows 64 bit Driver Disk  
K) Create INTEL 6321 LSI MegaRAID for RHEL4 UP2 32/64 bit Driver Disk  
L) Create INTEL 6321 LSI MegaRAID for RHEL3 UP6 32/64 bit Driver Disk  
M) Create the DSBF-DE emergent BIOS Recovery diskette  
N) Flash Phoenix BIOS for DSBF-DE MB  
O) Create the DSBF-DE/SAS emergent BIOS Recovery diskette  
P) Flash Phoenix BIOS for DSBF-DE/SAS MB  
Q) ESB2 ASF Firmware update  
Please choose A TO Q:
```

6. Place a blank, high-density floppy disk to the floppy disk drive, then select the type of RAID driver disk you want to create by typing the number before the option

7. Press <Enter>.
8. Follow screen instructions to create the driver disk.



For systems with Red Hat® Enterprise versions that are not listed in the Makedisk menu, explore the support CD and copy the RAID driver disk from the following path:

For Intel® 6321 LSI MegaRAID: \Drivers\6321 LSI MegaRAID\Driver\Linux\

For LSI 1068 SAS: \Drivers\LSI 1068\Driver\Linux\

The paths above may differ based on variant models.

Create LSI 1068 SAS for Windows® 2000/2003 driver disk

To create this RAID driver disk:

1. Place the motherboard support CD in the optical drive of **ANOTHER PC**.
2. Manually locate the executable file in the makedisk folder in the support CD.
DSBF-DE > Drivers > LSI1068 > Drivers > makedisk > xp

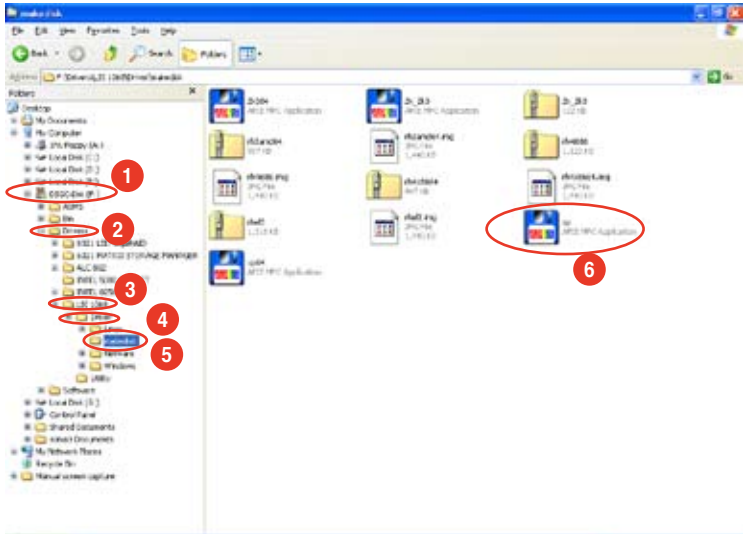

3. Place a blank, high-density floppy disk to the floppy disk drive and save the executable file to the floppy disk.
4. Eject the floppy disk and insert it into the **ORIGINAL PC**.
5. Key in the name of the executable file and press <Enter>.
6. Follow screen instructions to create the driver disk

6.1.2 Installing the RAID controller driver

Windows® 2000/2003 Server OS



When installing the LSI 1068 driver to your OS, make sure the driver you are installing supports your current installed OS. We **STRONGLY RECOMMEND** that you use the LSI 1068 SAS utility bundled in the support CD to create a driver disk. Refer to page 6-1 for more information.

During Windows® 2000/2003 Server OS installation

To install the RAID controller driver when installing Windows® 2000/2003 Server OS:

1. Boot the computer using the Windows® 2000/2003 Server installation CD. The Windows® 2000/2003 Setup starts.

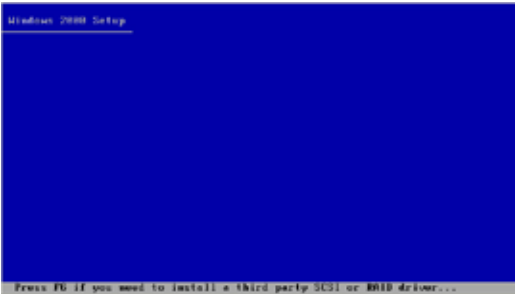

2. Press <F6> when the message “Press F6 if you need to install a third party SCSI or RAID driver...” appears at the bottom of the screen.
3. When prompted, press <S> to specify an additional device.

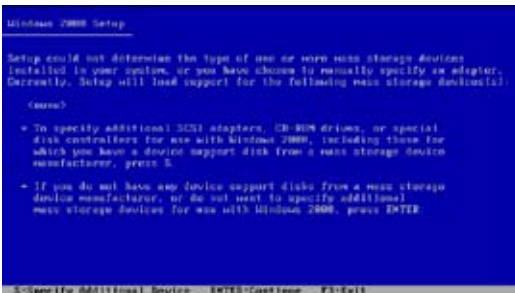

4. Insert the RAID driver disk you created earlier to the floppy disk drive, then press <Enter>.

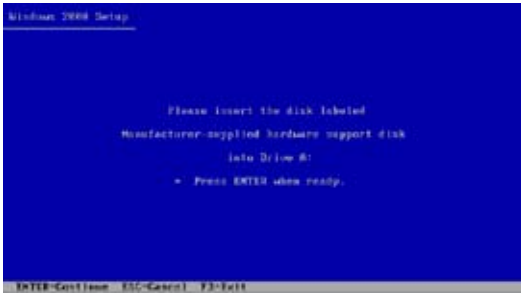

5. Select the RAID controller driver from the list, then press <Enter>.

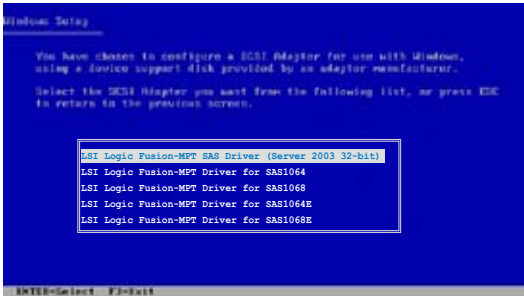

- **Intel® 6321ESB Intel® MATRIX STORAGE driver:**
 - If SATA RAID mode is to be enabled, select **Intel ESB2 SATA RAID Controller (Server ESB2)**.
 - If SATA AHCI mode is enabled, select **Intel ESB2 SATA AHCI Controller (Server ESB2)**.

- **Intel® 6321ESB LSI Logic Embedded SATA RAID driver (DSBF-DE model only):**
 - For Windows 2000 OS, select **LSI MegaRAID Software RAID (Windows 2000 SP4)**.
 - For Windows XP/2003 OS, select **LSI MegaRAID Software RAID (Windows XP/2003)**.
 - **LSI1068 PCI-X SAS controller driver (DSBF-DE/ SAS model only):**
 - For Windows 2000, select **LSI Logic Fusion-MPT Drivers for SAS1068**.
 - For 32bit Windows Server 2003, select **LSI Logic Fusion-MPT SAS Driver (Server 2003 32-bit)**.
6. The Windows® 2000/2003 Setup loads the RAID controller drivers from the RAID driver disk. When prompted, press <Enter> to continue installation.
 7. Setup then proceeds with the OS installation. Follow screen instructions to continue.

To an existing Windows® 2000/2003 Server OS

To install the RAID controller driver on an existing Windows® 2000/2003 Server OS:

1. Restart the computer, then log in with **Administrator** privileges.
2. Windows® automatically detects the RAID controller and displays a **New Hardware Found** window. Click **Cancel**.
3. Right-click the **My Computer** icon on the Windows® desktop, then select **Properties** from the menu.
4. Click the **Hardware** tab, then click the **Device Manager** button to display the list of devices installed in the system.

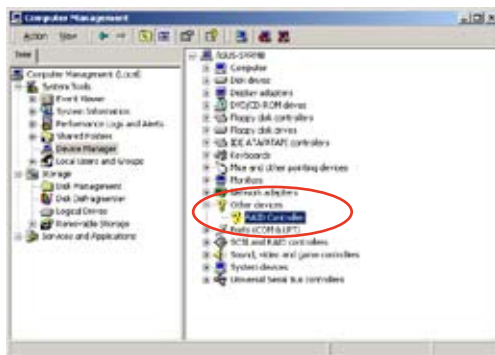

5. Right-click the **RAID controller** item, then select **Properties**.
6. Click the **Driver** tab, then click the **Update Driver** button.
7. The **Upgrade Device Driver Wizard** window appears. Click **Next**.
8. Insert the RAID driver disk you created earlier to the floppy disk drive.
9. Select the option **Search for a suitable driver for my device (recommended)**, then click **Next**.
10. The wizard searches the RAID controller drivers. When found, click **Next** to install the drivers.
11. Click **Finish** after the driver installation is done.



To verify the RAID controller driver installation:

1. Right-click the **My Computer** icon on the Windows® desktop , then select **Properties** from the menu.
2. Click the **Hardware** tab, then click the **Device Manager** button.
3. Click the “+” sign before the item **SCSI and RAID controllers**, then the LSI Adapter, SAS 3000 series, 8-port with 1068-StorPort item should appear.

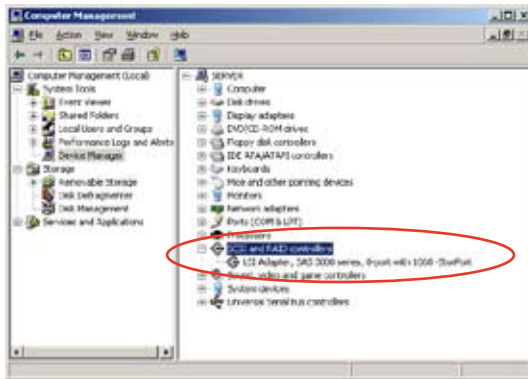

The screen differs based on the controller.

4. Right-click the **RAID controller** driver item, then select **Properties** from the menu.
5. Click the **Driver** tab, then click the **Driver Details** button to display the RAID controller drivers.
6. Click **OK** when finished.

Red Hat® Enterprise

To install the Intel® 6321ESB LSI Logic Embedded SATA RAID controller driver when installing Red Hat® Enterprise OS:

1. Boot the system from the Red Hat® Installation CD.



2. At the `boot:`, type `linux dd`, then press <Enter>.



When installing a Red Hat 2.4 kernel with a Driver Update Disk (DUD) to a disk drive attached to a LSI HBA, use the command below at the install prompt:
linux dd updates.

3. Select **Yes** using the <Tab> key when asked if you have the driver disk. Press <Enter>

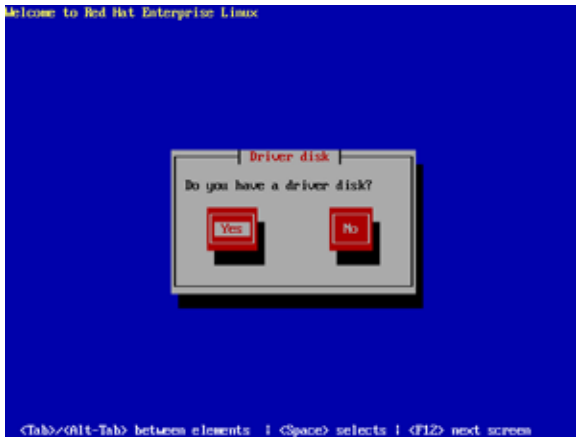

4. Select **fd0** using the <Tab> key when asked to select the driver disk source. Press <Tab> to move the cursor to **OK**, then press <Enter>.

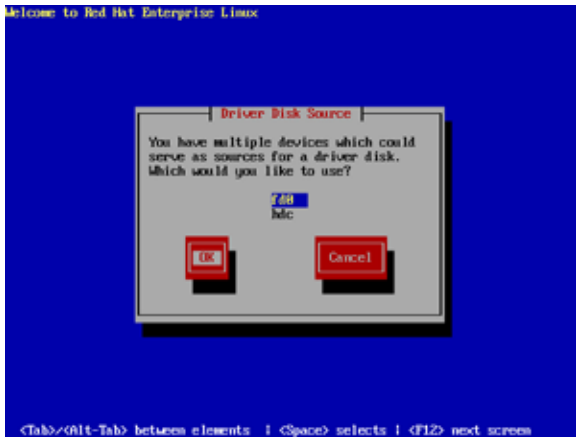

- When prompted, insert the Red Hat® Enterprise RAID driver disk to the floppy disk drive, select **OK**, then press <Enter>.

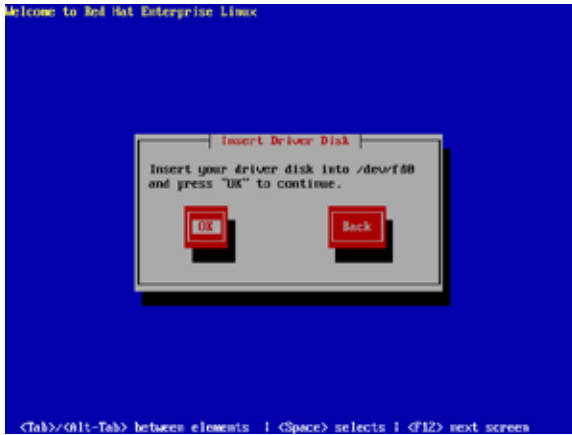

The drivers for the RAID controller are installed to the system.

- Follow screen instructions to continue the OS installation.

SuSE Linux

To install the RAID controller driver when installing SuSE Linux OS:

1. Boot the system from the SuSE Installation CD.
2. Select Installation from the **Boot Options** menu, then press <Enter>.

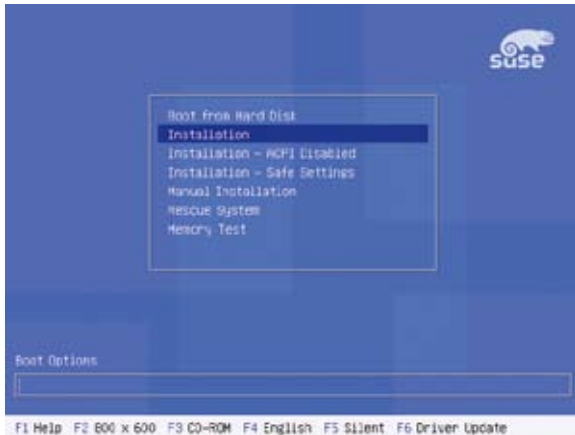

3. A message instructs you to prepare the RAID driver disk. Press <F6>.

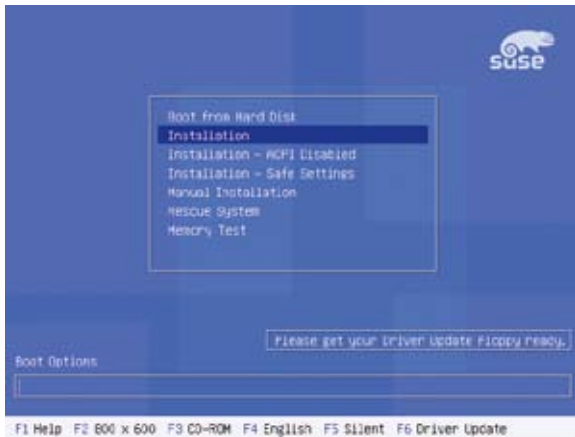

- When prompted, insert the RAID driver disk to the floppy disk drive, then press <Enter>.



- When prompted, select the floppy disk drive (fd0) as the driver update medium, select **OK**, then press <Enter>.

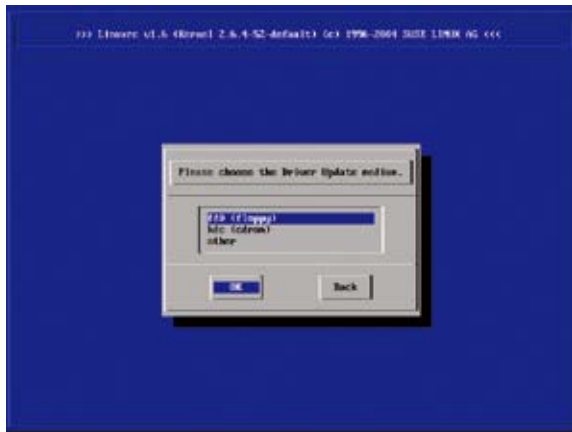

The drivers for the RAID controller are installed to the system.

6.2 Intel® chipset software installation

This section provides instructions on how to install the Plug and Play components for the Intel® chipset on the system.

You need to manually install the Intel® chipset software on a Windows 2000 / Server 2003 operating system. To install the Intel® chipset software:

1. Restart the computer, then log on with **Administrator** privileges.
2. Insert the motherboard/system support CD to the optical drive. The support CD automatically displays the **Drivers** menu if Autorun is enabled in your computer.
3. Click the item **Intel(R) Chipset Software Installation Utility** from the menu.



4. The **Intel(R) Chipset Software Installation Utility** window appears. Follow the screen instructions to complete installation.

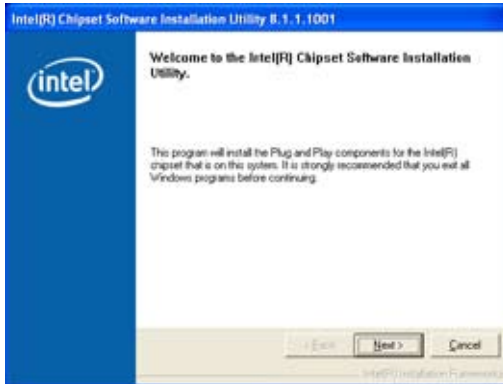

5. Select **Yes** to accept the terms of the **License Agreement** and continue the process.



6. Read the **Readme File Information** and press **Next** to activate the installation.

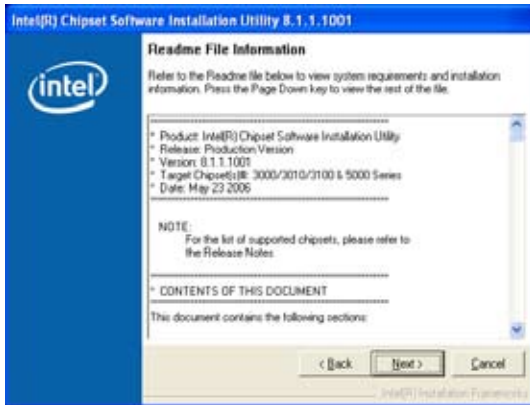

7. After completing the installation, click **Finish** to restart the computer.



6.3 LAN driver installation

This section provides the instructions on how to install Intel® Gigabit LAN controller drivers.

6.3.1 Windows® 2000/Server 2003

To install the Intel® Gigabit LAN controller driver on a Windows® 2000/ Server 2003 OS:

1. Restart the computer, and then log on with **Administrator** privileges.
2. Insert the motherboard/system support CD to the optical drive. The CD automatically displays the **Drivers** menu if Autorun is enabled in your computer.
 - Windows® automatically detects the LAN controllers and displays window. Click **Cancel** to close this window.
 - If **Autorun** is NOT enabled in your computer, browse the contents of the support CD to locate the file **AUTORUN.EXE** from the **\Drivers\Intel 82563EB** folder. Double-click the **AUTORUN.EXE** and follow step 4 to run the installation.
3. Click the **Intel® PRO/1000 EB Network Connection** option.

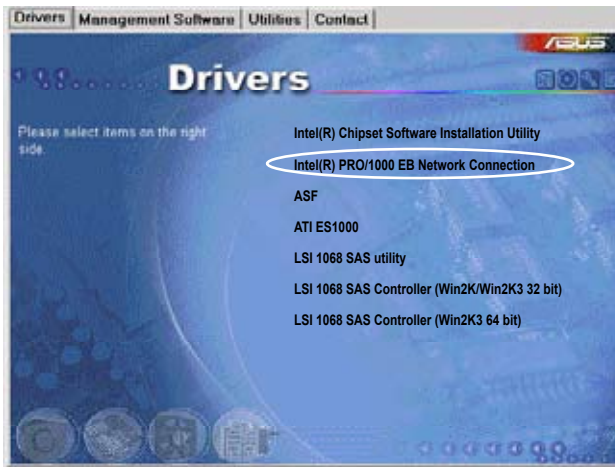

4. Click the **Install Drivers** option to begin installation.



5. Click **Next** button when the **Intel® PRO Network Connections – InstallShield Wizard** window appears.



6. Select the “**I accept the terms in the license agreement**” and then click the **Next** button.

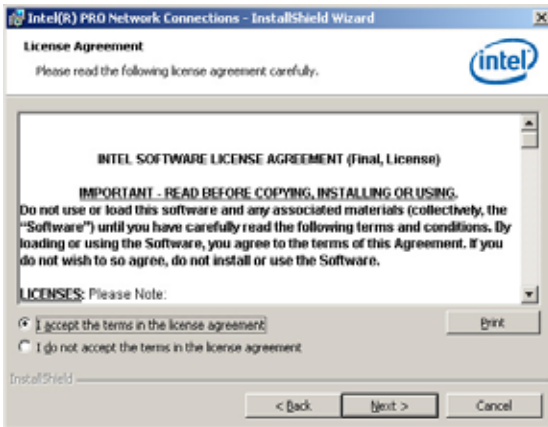

7. Press the **Complete** and click **Next** button to fully install the driver, Intel® PROSet for Windows Device Manager and Advanced Networking Services.



8. Follow the screen instructions to complete installation.

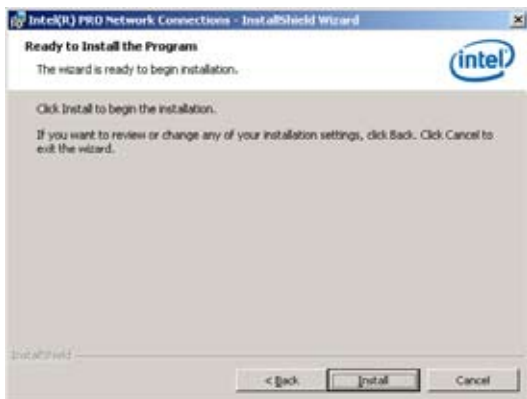

9. When finished, press **Finish** to continue.



To verify the LAN controller driver installation:

1. Right-click the My Computer icon on the Windows® desktop , then select Properties from the menu.
2. Click the Hardware tab, then click the Device Manager button.
3. Click the “+” sign before the item Network adapters, then Intel(R) PRO/1000 EB Network Connection with I/O Acceleration item should appear.

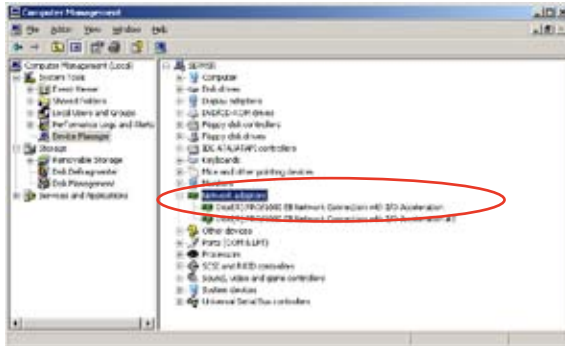

6.3.2 Red Hat/SuSE Linux

Follow these instructions when installing the Intel® LAN controller base driver for the in Red Hat® and SuSE Linux operating system.

Before installing the LAN driver:

Before installing the LAN driver, you must install the kernel development application. To install the kernel development:

1. Insert the Linux OS installation CD Disk 1 to the optical drive.
2. Double click “**Application**” > “**System setting**” > “**Add / Remove application**”.
3. Select “**Kernel Development**” from the **Development Tools**.
4. Follow the later steps and add different CDs according to the instructions displayed.

Building the driver from the TAR file:

1. Insert the motherboard/system support CD to the optical drive and mount the optional drive in the Linux platform.
2. Copy the base driver tar file from the motherboard/system support CD to the directory of your local hard disk. The name format of driver file is “**e1000-<Version>.tar.gz**”.

For example: the file name of driver version 7.0.38 is “**e1000-7.0.38.tar.gz**”.

- The Intel® LAN driver for Linux OS is located in:

\\Drivers\INTEL 82563EB\PRO1000\LINUX

3. Untar or unzip the archive.
tar xzf e1000-x.x.x.tar.gz
4. Change to the driver src directory.
cd e1000-x.x.x/src/
5. Use the command “makeinstall” to compile the driver module.
makeinstall
6. After reboot the system, please refer to Linux distribution documentation to configure the network protocol and IP address.

6.4 VGA driver installation

This section provides instructions on how to install the ATI® ES1000 Video Graphics Adapter (VGA) driver.

6.4.1 Windows® 2000/Server 2003

You need to manually install the ATI® ES1000 VGA driver on a Windows® 2000 / Server 2003 operating system. To install the ATI® ES1000 VGA driver:

1. Restart the computer, then log on with Administrator privileges.
2. Insert the motherboard/system support CD to the optical drive. The support CD automatically displays the Drivers menu if Autorun is enabled in your computer.

The **Drivers** menu if Autorun is enabled in your computer.

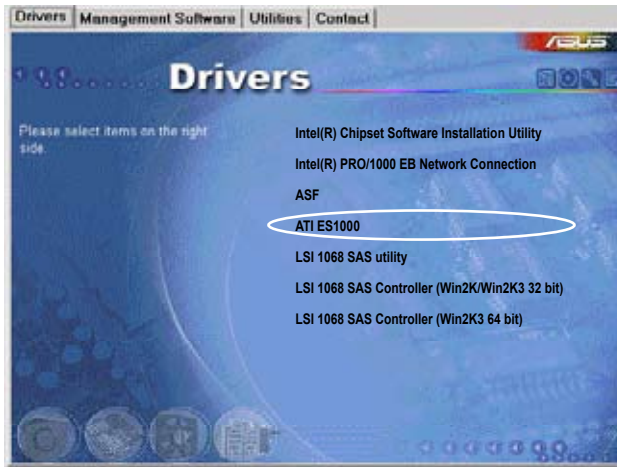

3. Click the item **ATI ES1000** from the menu.

4. The **ATI Software** window appears. Follow the screen instructions to complete installation.



5. Select **Yes** to accept the terms of the **License Agreement** and continue the process.



6. Press the  button to select **Express** installation to activate quick installation.



7. After completing the installation, restart the computer.



6.5 Management applications and utilities installation

The support CD that came with the motherboard package contains the drivers, management applications, and utilities that you can install to avail all motherboard features.



The contents of the support CD are subject to change at any time without notice. Visit the ASUS website (www.asus.com) for updates.

6.5.1 Running the support CD

Place the support CD to the optical drive. The CD automatically displays the Drivers menu if Autorun is enabled in your computer.



If Autorun is NOT enabled in your computer, browse the contents of the support CD to locate the file ASSETUP.EXE from the BIN folder. Double-click the ASSETUP.EXE to run the CD.

6.5.2 Drivers menu

The Drivers menu shows the available device drivers if the system detects installed devices. Install the necessary drivers to activate the devices.



The screen display and driver options vary under different operating system versions.



6.5.3 Management Software menu

The Management Software menu displays the available network and server monitoring applications. Click an item to install.

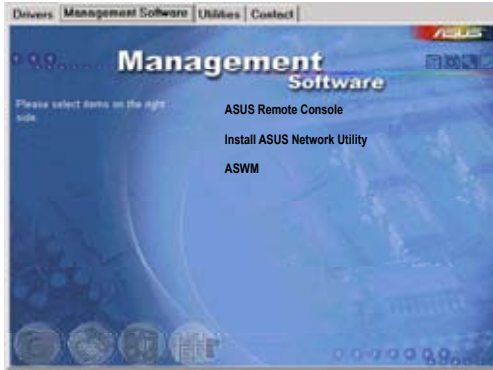

6.5.4 Utilities menu

The Utilities menu displays the software applications and utilities that the motherboard supports. Click an item to install.

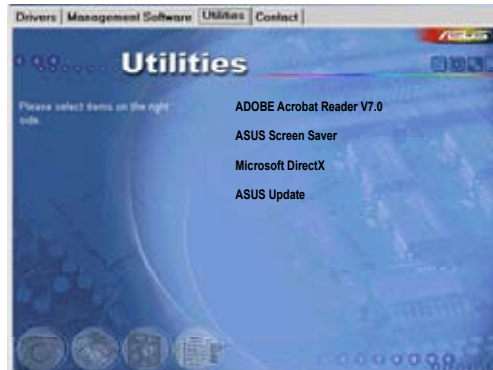

6.5.5 Contact information

Click the Contact tab to display the ASUS contact information. You can also find this information on the inside front cover of this user guide.



This appendix includes additional information that you may refer to when configuring the motherboard.

Reference information



Appendix summary



A.1	DSBF-DE/SAS model block diagram.....	A-1
A.2	DSBF-DE model block diagram	A-2
A.3	PHLASH16.EXE and memory managers.....	A-3

A.1 DSBF-DE/SAS model block diagram

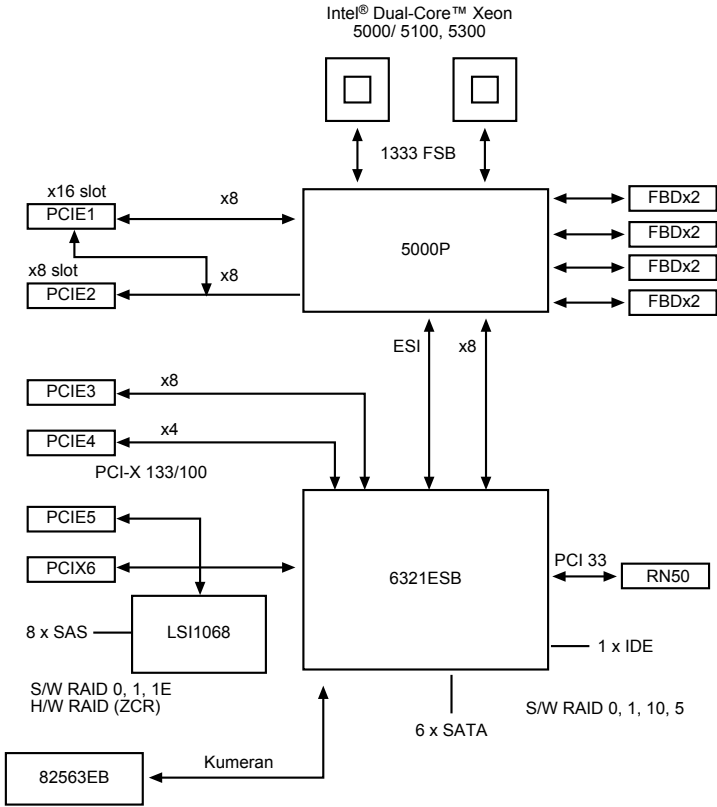

A.2 DSBF-DE model block diagram

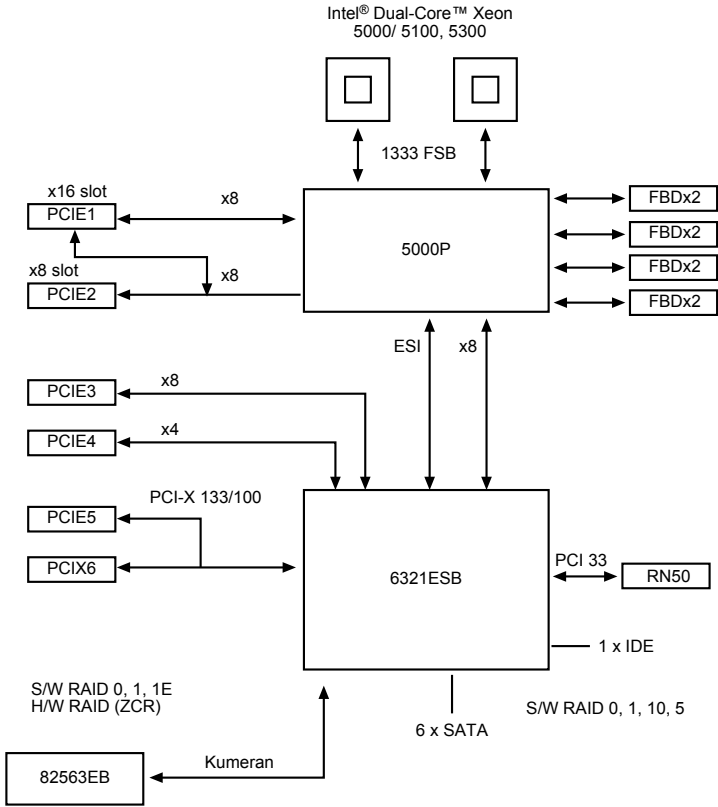

A.3 PHLASH16.EXE and memory managers

Phlash16 may fail if your system is using memory managers, in which case the utility will display the following message:

Memory manager error message

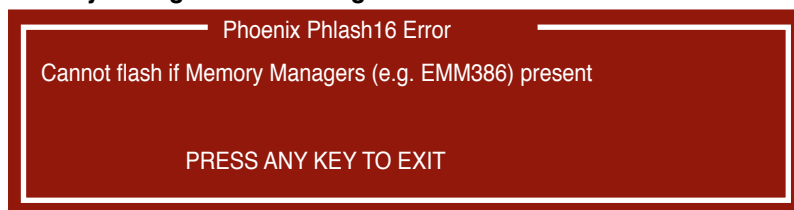

If you see this message after you execute Phlash16, you must disable the memory manager on your system. Follow the instructions in the Disabling memory managers section in this chapter.

Because Phlash16.EXE may require the use of extended memory, it will not run if it detects the presence of an extended-memory manager such as HIMEM.SYS, EMM386, or QEMM. To avoid conflict with disk caching programs, the program checks for VCPI, DPML and XMS.



The program does not check for VDISK because MS-DOS 5 and later versions do not support that server.

If the program detects any of these utilities, the program reports a failure and terminates.

Disabling memory managers

To avoid failure when flashing, you must disable the memory managers that load from CONFIG.SYS and AUTOEXEC.BAT.

To disable the memory managers:

1. Boot from a bootable floppy disk created from MS-DOS 6.22.
2. During the boot process, when the message "Press any key to continue" is displayed, press <F5>.
3. The message "MS-DOS is bypassing CONFIG.SYS and AUTOEXEC.BAT file" appears. The memory managers will then be disabled. Do not interrupt the process.
4. When done, flash the BIOS according to instructions in section "4.1.2 Updating the Phoenix Phlash16 Utility.

