

AcerPower

8600

Quick Guide

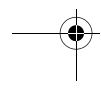

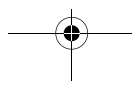
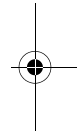
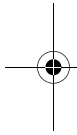

Copyright 1999 Acer Incorporated
All Rights Reserved. Printed in Taiwan
AcerPower 8600 Quick Guide
Part No.: 49.30C02.001
Version: September, 1999

Changes may be made periodically to the information in this publication without obligation to notify any person of such revision or changes. Such changes will be incorporated in new editions of this manual or supplementary documents and publications. This company makes no representations or warranties, either expressed or implied, with respect to the contents hereof and specifically disclaims the implied warranties of merchantability or fitness for a particular purpose.

Record the model number, serial number, purchase date, and place of purchase information in the space provided below. The serial number and model number are recorded on the label affixed to your computer. All correspondence concerning your unit should include the serial number, model number, and purchase information.

No part of this publication may be reproduced, stored in a retrieval system, or transmitted, in any form or by any means, electronic, mechanical, photocopy, recording, or otherwise, without the prior written permission of Acer Incorporated.

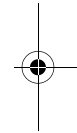
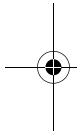

AcerPower 8600 Quick Guide

Model Number : _____

Serial Number : _____

Purchase Date : _____

Place of Purchase : _____

All trademarks, registered trademarks and/or service marks are the properties of their respective owners.

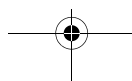
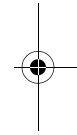
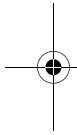
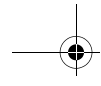



Table of Contents

Notices	v
Overview	1
Preinstallation	2
Selecting a Site	2
Unpacking Components	2
Features	3
Front Panel	3
Rear Panel	4
Connecting System Components	6
Connecting the Keyboard	6
Connecting the Monitor	7
Connecting the Mouse	7
Connecting the Printer (optional)	8
Connecting Multimedia Components	9
Turning On Your Computer	10
Turning Off Your Computer	12
Installation Precautions	13
ESD Precautions	13
Preinstallation Instructions	13
Post-installation Instructions	14
Opening the System	15
Removing the Housing Cover	15
Replacing the Housing Cover	16
Replacing the Hard Disk	17
Installing and Removing a PCI Card	19
Installing a PCI Card	19
Removing a PCI Card	20
Installing and Removing a AGP Card	21
Installing a AGP Card	21
Removing a AGP Card	22
Board Layout	23
Jumpers and Connectors	25
Installing Additional Memory	28
Installing a RIMM	30
Removing a RIMM	31
Installing a C-RIMM	32
Removing a C-RIMM	33
Reconfiguring the System	33
Upgrading the CPU	34
Removing the CPU	34





iv Table of Contents



Installing the Upgrade CPU 36

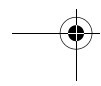
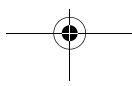
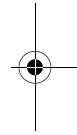
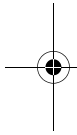

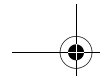

v

Notices

FCC Notice

This device has been tested and found to comply with the limits for a Class B digital device pursuant to Part 15 of the FCC Rules. These limits are designed to provide reasonable protection against harmful interference in a residential installation. This device generates, uses, and can radiate radio frequency energy and, if not installed and used in accordance with the instructions, may cause harmful interference to radio communications.

However, there is no guarantee that interference will not occur in a particular installation. If this device does cause harmful interference to radio or television reception, which can be determined by turning the device off and on, the user is encouraged to try to correct the interference by one or more of the following measures:

- Reorient or relocate the receiving antenna
- Increase the separation between the device and receiver
- Connect the device into an outlet on a circuit different from that to which the receiver is connected
- Consult the dealer or an experienced radio/television technician for help

Notice: Shield Cables

All connections to other computing devices must be made using shielded cables to maintain compliance with FCC regulations.

Notice: Peripheral Devices

Only peripherals (input/output devices, terminals, printers, etc.) certified to comply with the Class B limits may be attached to this equipment. Operation with non certified peripherals is likely to result in interference to radio and TV reception.

Caution

Changes or modifications not expressly approved by the manufacturer could void the user's authority, which is granted by the Federal Communications Commission, to operate this computer.

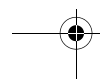
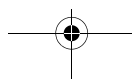
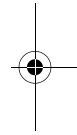
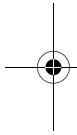



Use Conditions

This part complies with Part 15 of the FCC Rules. Operation is subject to the following two conditions: (1) this device may not cause harmful interference, and (2) this device must accept any interference received, including interference that may cause undesired operation.

Notice: Canadian Users

This Class B digital apparatus meets all requirements of the Canadian Interference-Causing Equipment Regulations.

Remarque à l'intention des utilisateurs canadiens

Cet appareil numérique de la classe B respecte toutes les exigences du Règlement sur le matériel brouilleur du Canada.

Important Safety Instructions

Read these instructions carefully. Save these instructions for future reference.

1. Follow all warnings and instructions marked on the product.
2. Unplug this product from the wall outlet before cleaning. Do not use liquid cleaners or aerosol cleaners. Use a damp cloth for cleaning.
3. Do not use this product near water.
4. Do not place this product on an unstable cart, stand, or table. The product may fall, causing serious damage to the product.
5. Slots and openings in the cabinet and the back or bottom are provided for ventilation; to ensure reliable operation of the product and to protect it from overheating, these openings must not be blocked or covered. The openings should never be blocked by placing the product on a bed, sofa, rug, or other similar surface. This product should never be placed near or over a radiator or heat register, or in a built-in installation unless proper ventilation is provided.
6. This product should be operated from the type of power indicated on the marking label. If you are not sure of the type of power available, consult your dealer or local power company.
7. Do not allow anything to rest on the power cord. Do not locate this product where persons will walk on the cord.
8. If an extension cord is used with this product, make sure that the total ampere rating of the equipment plugged into the extension

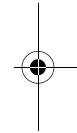
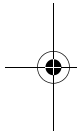



cord does not exceed the extension cord ampere rating. Also, make sure that the total rating of all products plugged into the wall outlet does not exceed the fuse rating.

- 9.** Never push objects of any kind into this product through cabinet slots as they may touch dangerous voltage points or short out parts that could result in a fire or electric shock. Never spill liquid of any kind on the product.
- 10.** Do not attempt to service this product yourself, as opening or removing covers may expose you to dangerous voltage points or other risks. Refer all servicing to qualified service personnel.
- 11.** Unplug this product from the wall outlet and refer servicing to qualified service personnel under the following conditions:
 - a.** When the power cord or plug is damaged or frayed
 - b.** If liquid has been spilled into the product
 - c.** If the product has been exposed to rain or water
 - d.** If the product does not operate normally when the operating instructions are followed. Adjust only those controls that are covered by the operating instructions since improper adjustment of other controls may result in damage and will often require extensive work by a qualified technician to restore the product to normal condition.
 - e.** If the product has been dropped or the cabinet has been damaged
 - f.** If the product exhibits a distinct change in performance, indicating a need for service.
- 12.** Replace the battery with the same type as the product's battery we recommend. Use of another battery may present a risk of fire or explosion. Refer battery replacement to a qualified serviceman.
- 13.** Warning! Batteries may explode if not handled properly. Do not disassemble or dispose of them in fire. Keep them away from children and dispose of used batteries promptly.
- 14.** Use only the proper type of power supply cord set (provided in your accessories box) for this unit. It should be a detachable type: UL listed/CSA certified, type SPT-2, rated 7A 125V minimum, VDE approved or its equivalent. Maximum length is 15 feet (4.6 meters).

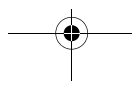
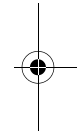
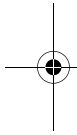



Year 2000 Compliance Statement

The AcerPower 8600 carries the "Hardware NSTL Tested Year 2000 Compliant" logo, which certifies that this model has been tested by NSTL using the YMark2000 test, and has been found to meet NSTL's standards for Year 2000 hardware compliance.



For more details, check the Acer Year 2000 Resource Center at <http://www.acer.com.tw/service/y2k/>

Laser Compliance Statement

The CD-ROM drive in this computer is a laser product. The CD-ROM drive's classification label (shown below) is located on the drive.

CLASS 1 LASER PRODUCT

CAUTION: INVISIBLE LASER RADIATION WHEN OPEN.
AVOID EXPOSURE TO BEAM.

APPAREIL A LASER DE CLASSE 1 PRODUIT

LASERATTENTION: RADIATION DU FAISCEAU LASER
INVISIBLE EN CAS D'OUVERTURE. EVITER TOUTE
EXPOSITION AUX RAYONS.

LUOKAN 1 LASERLAITE LASER KLASSE 1

VORSICHT: UNSICHTBARE LASERSTRAHLUNG, WENN
ABDECKUNG GEÖFFNET NICHT DEM STRAHL AUSSETZEN

PRODUCTO LÁSER DE LA CLASE I

ADVERTENCIA: RADIACIÓN LÁSER INVISIBLE AL SER
ABIERTO. EVITE EXPONERSE A LOS RAYOS.

ADVARSEL: LASERSTRÅLING VEDÅBNING SE IKKE IND I
STRÅLEN.

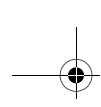

VARO! LAVATTAESSA OLET ALTTINA LASERSÄTEILYLLE.

WARNING: LASERSTRÅLNING NÄR DENNA DEL ÄR ÖPPNAD
ÅLÅ TUIJOTA SÄTEESEENSTIRRA EJ IN I STRÅLEN

WARNING: LASERSTRÅLNING NÄR DENNA DEL ÄR
ÖPPNADSTIRRA EJ IN I STRÅLEN

ADVARSEL: LASERSTRÅLING NÄR DEKSEL ÅPNESSTIRR IKKE
INN I STRÅLEN

Lithium Battery Statement

CAUTION

Danger of explosion if battery is incorrectly replaced. Replace only with the same or equivalent type recommended by the manufacturer. Discard used batteries according to the manufacturer's instructions.

ADVARSEL!

Lithiumbatteri - Eksplosjonsfare ved feilagtig håndtering. Utskiftning må kun ske med batteri af samme fabrikat og type. Léver det brugte batteri tilbage til leverandøren.

ADVARSEL

Eksplosjonsfare ved feilaktig skifte av batteri. Benytt samme batteritype eller en tilsvarende type anbefalt av apparatfabrikanten. Brukte batterier kasseres i henhold til fabrikantens instruksjoner.

WARNING

Explosionsfara vid felaktigt batteribyte. Använd samma batterityp eller en ekvivalent typ som rekommenderas av apparattillverkaren. Kassera använt batteri enligt fabrikantens instruktion.

VAROITUS

Päristo voi räjähtää, jos se on virheellisesti asennettu. Vaihda paristo ainoastaan laitevalmistajan suosittelemaan tyyppiin. Hävitä käytetty paristo valmistajan ohjeiden mukaisesti.

VORSICHT!

Explosionsgefahr bei unsachgemäßen Austausch der Batterie Ersatz nur durch denselben oder einem vom Hersteller empfohlenem ähnlichen Typ. Entsorgung gebrauchter Batterien nach Angaben des Herstellers.

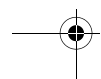
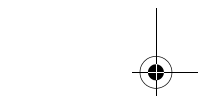
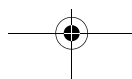
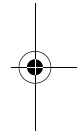
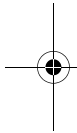

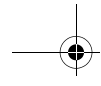

x Notices

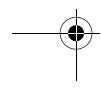
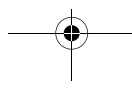
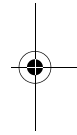
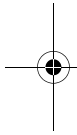

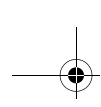

Overview

The AcerPower 8600 is an all-in-one, high-performance system that supports the Intel Pentium III CPU. It utilizes the PCI (Peripheral Component Interface) and the AGP (Accelerated Graphics Port) bus designs. Both designs improve system performance, enabling the system to support various multimedia functions and applications.

Aside from the standard I/O (Input/Output) interfaces such as two serial ports, one parallel port, and PS/2 keyboard and mouse ports, the system also comes with two USB (Universal Serial Bus) ports, one mono Microphone-in port, one stereo Line-in port, one Line-out port, and one Game/MIDI (Musical Instrument Digital Interface) port. These additional ports are included to enable the system to accommodate additional peripherals.

The system may also come with an onboard AGP video controller, an interface for LCD, a TV out port, an onboard audio controller, an external fax/modem card and/or a network card. These additional features offer special functions that will enable you to take full advantage of the system. Special features such as hardware monitoring, USB, power management, video and audio functions are discussed in this manual.

Furthermore, this system is fully compatible with MS-DOS v6.X, OS/2, SCO UNIX, Windows 95/98 and Windows NT operating systems.

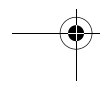
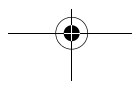
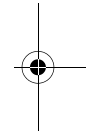
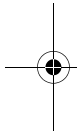

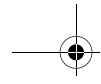

Preinstallation

The preinstallation process involves the following activities:

- Selecting a site
- Unpacking components

Selecting a Site

Consider the following when selecting a site for your computer:

- Determine the best site for your system. Cable paths should not run near equipment that might cause electromagnetic or radio frequency interference such as radio transmitters, televisions, copy machines, or heating and air-conditioning equipment.
- Route cables away from personnel and equipment traffic.
- Avoid dusty areas and extremes of temperature and humidity.

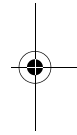
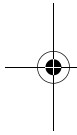

Unpacking Components

Unpack the contents of each box carefully. Save all packing materials in case you need to move or ship the system in the future.

Check that all items are present and in good condition. Contact your dealer immediately if anything is missing or damaged.

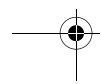
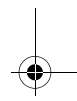
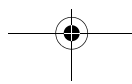
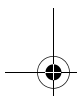

Features

The basic configuration consists of a system unit, a keyboard, a CD-ROM drive, a diskette drive, a fixed disk drive and a mouse.

Front Panel

The figure below shows the system unit front panel.

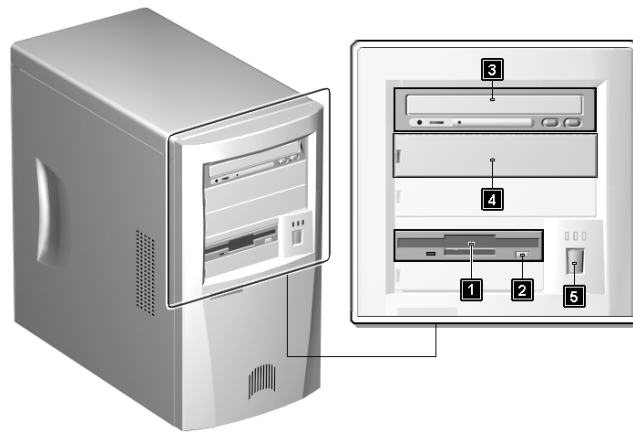

No.	Component
1	Floppy disk drive
2	Floppy disk drive eject button
3	CD-ROM drive
4	Drive bay cover for additional 5.25-inch storage Device
5	Power button

Rear Panel

The figure below shows the system unit rear panel.

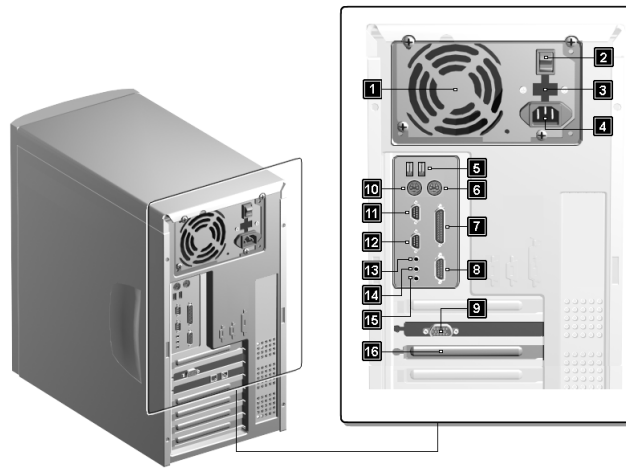

No.	Component
1	Fan
2	System main power switch
3	Voltage selector
4	System power socket
5	USB ports
6	PS/2 mouse port
7	Parallel port
8	Game/MIDI port

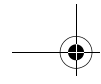

No.	Component
9	VGA/Monitor port
10	PS/2 keyboard port
11	Serial port 1
12	Serial port 2
13	Speaker-out/Line-out port
14	Line-in port
15	Microphone-in port
16	Add-on card brackets

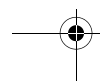
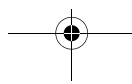
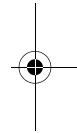
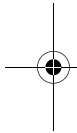

Connecting System Components



Caution: Do not turn on the system main power switch on the rear panel of the system or plug the system in until you finish connecting all system components.

The following sections show how to connect each component to the system:

Connecting the Keyboard

Plug the keyboard cable into the keyboard socket on the rear panel.

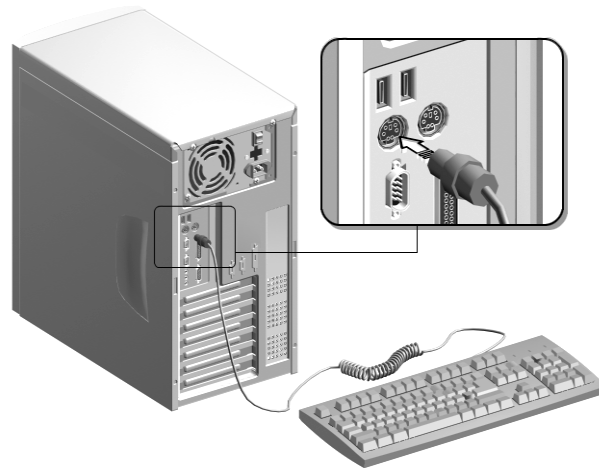



Connecting the Monitor

Plug the monitor signal cable into the VGA connector on the rear panel.

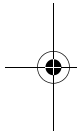
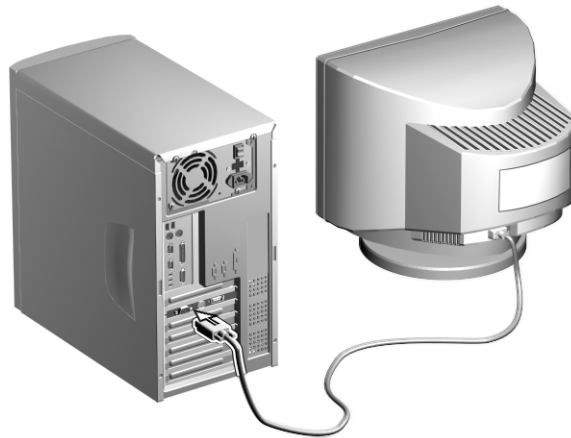

Connecting the Mouse

Plug the mouse cable into the mouse connector on the rear panel.

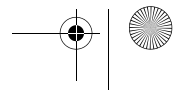
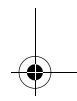
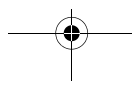
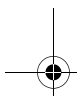
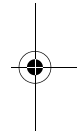

Connecting the Printer (optional)

Check your printer before you connect it to your system. If you have a parallel printer, connect it to the parallel port on the rear panel.

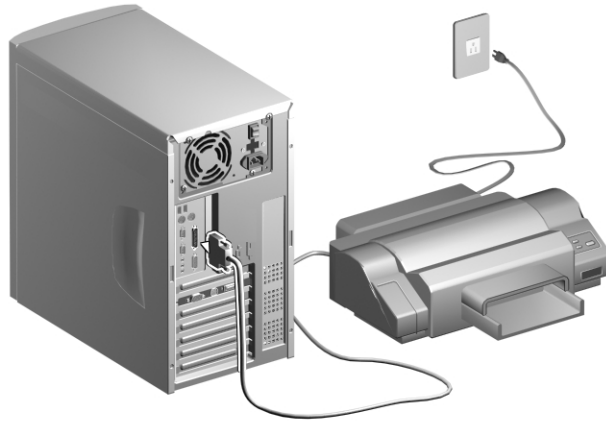

If you have a serial printer or other serial peripheral, connect it to the serial port (COM2). See "Rear Panel" on page 4 for the location of the serial ports.



Connecting Multimedia Components

Your system also supports optional multimedia features. Connect the multimedia components as shown below:

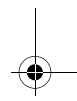
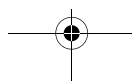
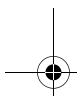
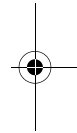
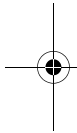
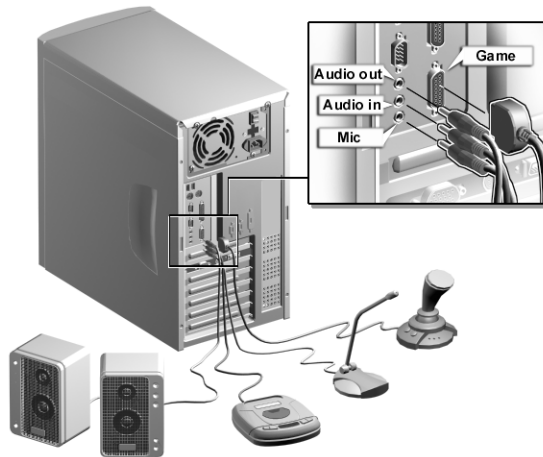



Turning On Your Computer

After you have connected all peripherals and cables, follow these steps to turn on your computer:

1. Turn on all peripherals connected to the system such as the monitor, printer, fax, speakers, etc.
2. Locate the system main power switch on the back of the system and turn it on.

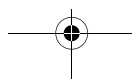
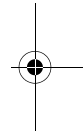
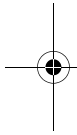
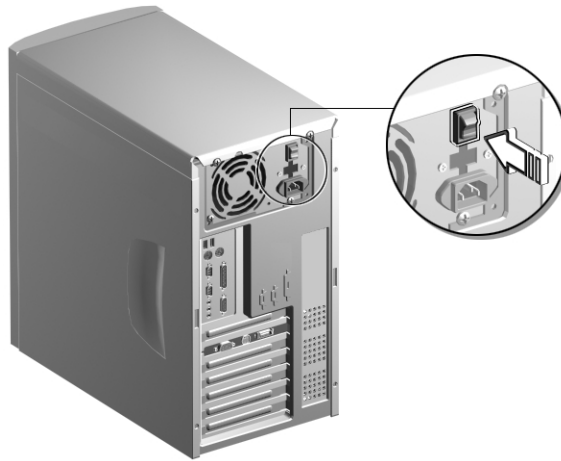

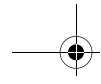

3. Press the power button located on the front of the system unit..

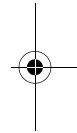
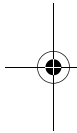
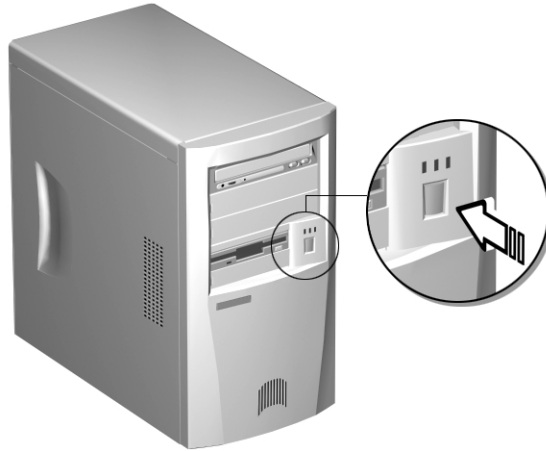

When the system finishes booting, the computer is now ready for use.

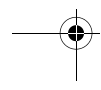
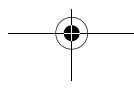

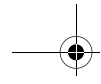

Turning Off Your Computer

1. Turn off all peripherals connected to the system such as the monitor, printer, fax, speakers, etc.
2. Press the power button located on the front of the system unit for at least four seconds. Quickly pressing the button puts the system in Suspend mode only.



Note: You do not need to turn off the system main power switch on the rear panel every time you turn off your computer.

Turn off the system main power switch only:

- if you will not use your system for a long period of time.
- if you need to open your system for any purpose, such as troubleshooting or upgrading.

If the system main power switch is not available, you must unplug the system.

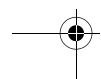
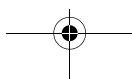
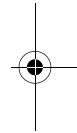
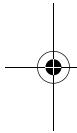



Installation Precautions

Before you install any system component, we recommend that you read the following sections. These sections contain important ESD precautions, pre- and post-installation instructions.

ESD Precautions

Electrostatic discharge (ESD) can damage your processor, disk drives, expansion boards, and other components. Always observe the following precautions before you install a system component.

1. Do not remove a component from its protective packaging until you are ready to install it.
2. Wear a wrist grounding strap and attach it to a metal part of the system unit before handling components. If a wrist strap is not available, maintain contact with the system unit throughout any procedure requiring ESD protection.

Preinstallation Instructions

Always observe the following before you install a system component:

1. Turn off the system power and all the peripherals connected to the unit before opening it.
2. Open the system according to the instructions on page 15.
3. Follow the ESD precautions on page 13 before handling a system component.
4. Remove any expansion boards or peripherals that block access to the RIMM sockets or CPU connector.
5. See the following sections for specific instructions on the component you wish to install.

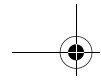

Warning! Not turning off the system properly before you start installing the components may damage your system.

Do not attempt the procedures described in the following sections unless you are a qualified service technician.

Post-installation Instructions

Observe the following after installing a system component:

1. See to it that the components are installed according to the step-by-step instructions in their respective sections.
2. Make sure you have set all the required jumpers. See “Jumpers and Connectors” on page 31 for the correct jumper settings.
3. Replace any expansion boards or peripherals that you removed earlier.
4. Replace the system cover.
5. Connect the necessary cables and turn on the system.

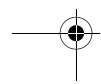
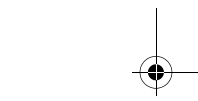
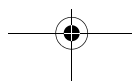
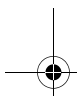
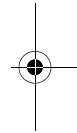
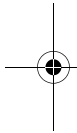



Opening the System



Caution: Before you proceed, make sure that you have turned off the system and all peripherals connected to it. Read the preinstallation instructions on page 13.

This section tells you how to open the housing cover when you need to install additional components inside the system unit.

Removing the Housing Cover

1. Turn off the system power and unplug all cables.
2. Place the system unit on a flat, steady surface.
3. Turn the screws counterclockwise to remove the cover. Set the screws aside. You will need them when replacing the housing cover.
4. Hold the sides of the cover with both hands and slide it back about an inch and tilt it out to remove the cover..

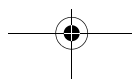
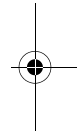
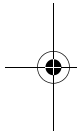
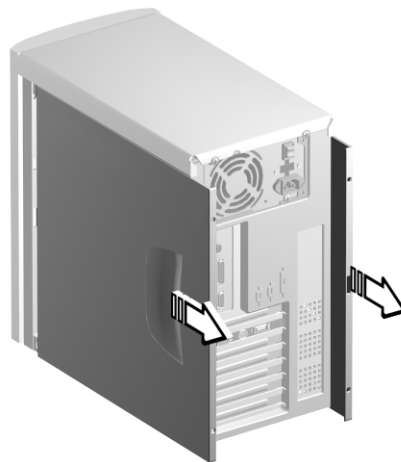



Replacing the Housing Cover

1. Hold the cover as shown and slide it back into place..

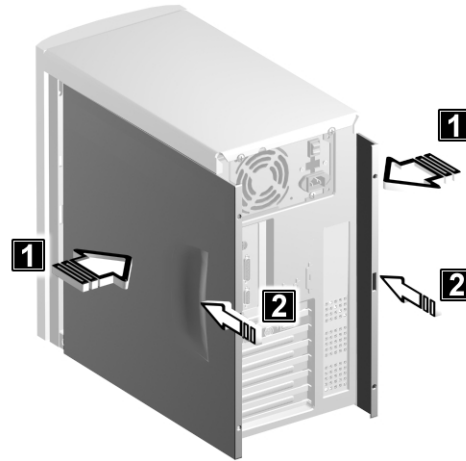

2. Replace the screws and turn it clockwise to secure the cover.

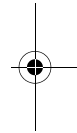
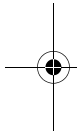

Replacing the Hard Disk

Follow these steps to replace the hard disk drive:

1. Remove the cover as shown on page 15.
2. Remove the four screws that hold the hard disk to the metal bracket frame.

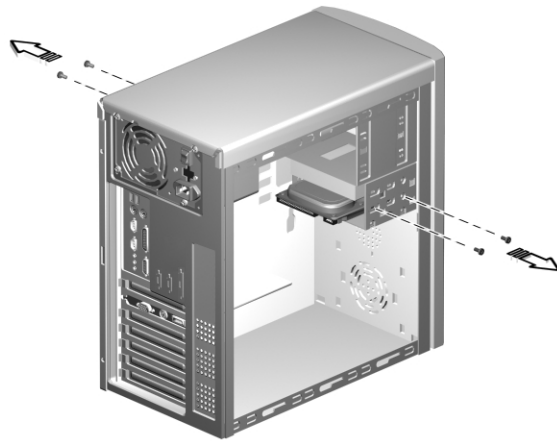

3. Pull out the hard disk drive and remove the power cable and disk drive cable as shown below..

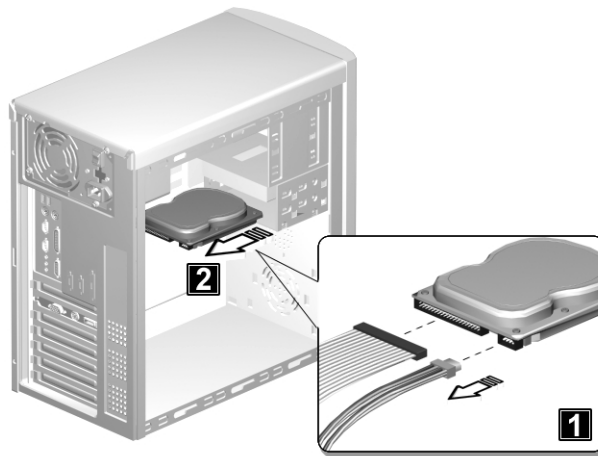

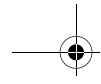

4. Install a new 3.5-inch hard disk drive and connect the disk drive cable and power cable

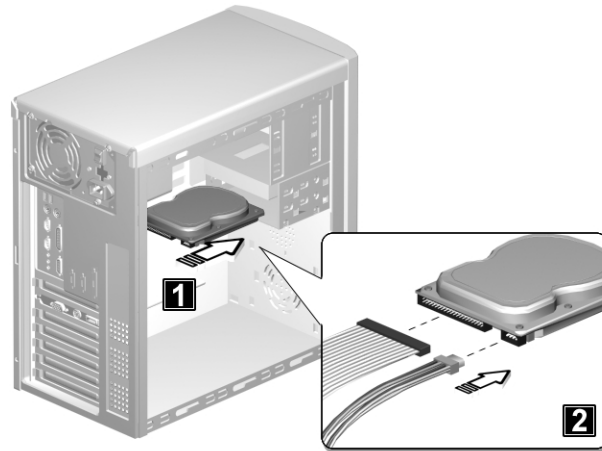

5. Secure the hard disk with the four screws that you have removed previously..

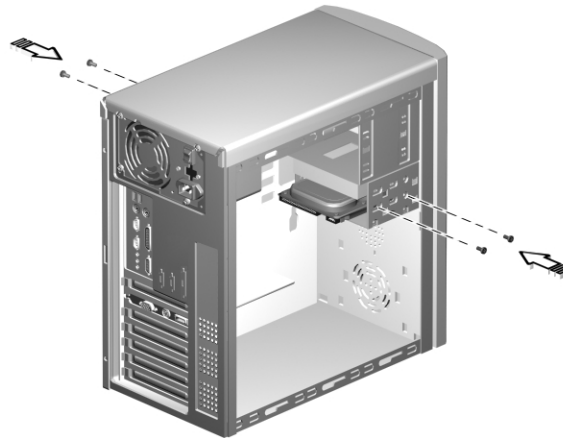

6. Reinstall the housing cover as shown on page 16.



Make sure that the other ends of the diskette drive cables are securely connected to their corresponding connectors on the system board.





Installing and Removing a PCI Card

Installing a PCI Card

1. Locate an empty PCI slot on the system board.
2. Remove the bracket on the housing opposite the selected empty PCI slot.



3. Remove the PCI card from its protective packaging.
4. Align then insert the PCI card into the slot. Make sure that the card is properly seated.

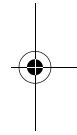
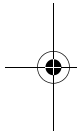
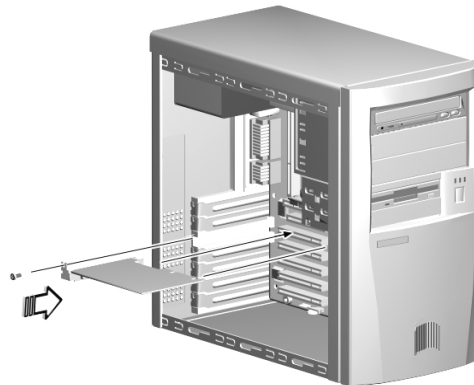

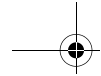

5. Secure the card to the housing with a screw.
6. Reinstall the housing cover (see page 16).

When you turn on the system, BIOS automatically detects and assigns resources to the PCI devices.

Removing a PCI Card

To remove a PCI card, simply reverse the instructions listed under the “Installing a PCI Card” section.

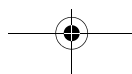
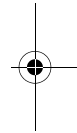
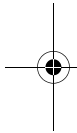



Installing and Removing a AGP Card

Installing a AGP Card

1. Locate an empty AGP slot on the system board.
2. Remove the bracket on the housing opposite the selected empty AGP slot.



3. Remove the AGP card from its protective packaging.
4. Align then insert the AGP card into the slot. Make sure that the card is properly seated.

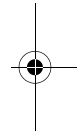
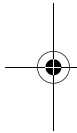
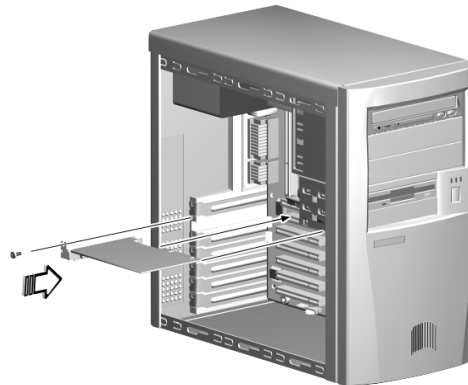

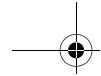

5. Secure the card to the housing with a screw.
6. Reinstall the housing cover (see page 16).

When you turn on the system, BIOS automatically detects and assigns resources to the AGP devices.

Removing a AGP Card

To remove a AGP card, simply reverse the instructions listed under the “Installing a AGP Card” section.

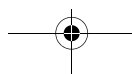
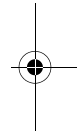
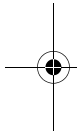

Board Layout

Your system board should look just like the following figure:

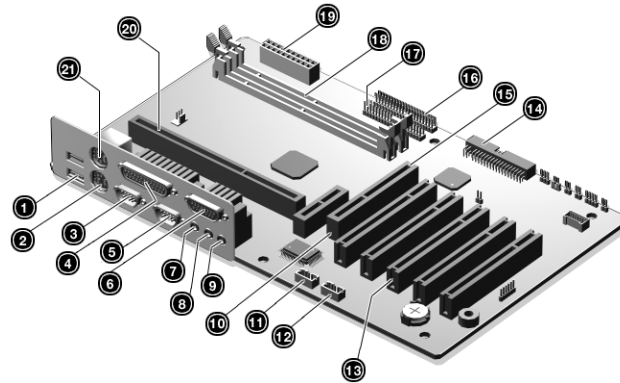

The following table lists the components that you will find on the system board:

No.	Component
1	USB ports
2	PS/2 keyboard port
3	Serial port 1
4	Parallel port
5	Serial port 2
6	Game/Midi port
7	Speaker-out/Line-out port
8	Line-in port

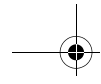

No.	Component
9	Microphone-in port
10	AMR socket
11	Voice modem connector
12	CD-in connector
13	PCI slots
14	Floppy disk drive connector
15	AGP socket
16	IDE 1 connector
17	IDE 2 connector
18	RIMM sockets
19	ATX power supply connector
20	CPU socket
21	PS/2 mouse port

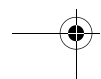
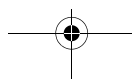
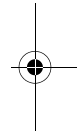
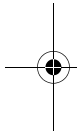

Jumpers and Connectors

Refer to the following figure for the location of the jumpers and connectors on the system board:

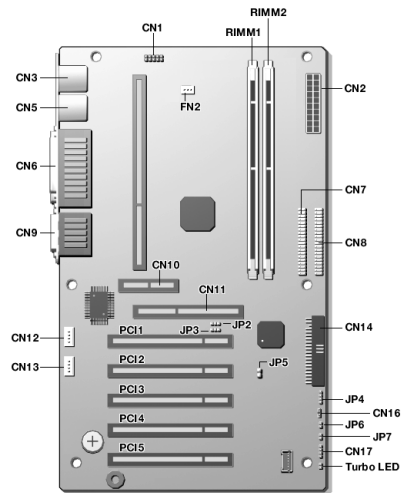

The following table lists the onboard jumpers, their respective functions and possible settings:

Jumper	Function and Settings
JP2	Password Check
	1-2 Check password
	2-3 Bypass password (default)
JP3	Boot Block
	1-2 Write disable (default)
	2-3 Write enable
JP5	Intruder alert connector



The following table lists the onboard connectors and their respective functions:

Connector	Function
CN1	USB upgrade connector
CN2	ATX power connector
CN3	USB
CN5	Lower: Keyboard, Upper: Mouse
CN6	Lower left: Serial 1; Lower right: Serial 2; Upper: Parallel/Printer
CN7	IDE 2
CN8	IDE 1
CN9	Upper: game/MIDI; Lower right: line-out; Lower center: line-in; Lower left: microphone-in
CN10	Audio/Modem riser
CN11	AGP connector
CN12	Fax-voice modem
CN13	CD-in connector
CN14	Floppy disk connector
CN16	LAN PME
CN17	Hard disk LED
CN19	AOL connector
RIMM 1, 2	Memory module sockets
PCI 1, 2, 3, 4, 5	PCI expansion slots
FN2	3-pin CPU fan

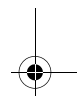
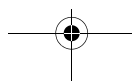
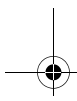
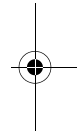
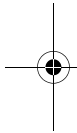

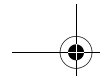

Connector	Function
JP4	Power LED
JP5	Housing Intrusion conn.
JP6	Reset key
JP7	Power switch

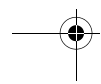
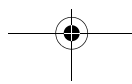
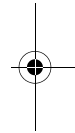
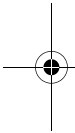

Installing Additional Memory

The system memory is upgradeable to a maximum of 1 GB via two 184-pin RIMM sockets on the system board. These RIMM sockets accept PC-600, 700 and 800 compliant RIMMs with 64-, 128-, 256- and 512-MB capacities. See “Board Layout” on page 29 for the location of the RIMM sockets. For instructions on how to install RIMMs, refer to “Installing a RIMM” on page 30.

The following table lists the possible memory configurations:

RIMM 1	RIMM 2	Total Memory
64 MB	C-RIMM	64 MB
128 MB	C-RIMM	128 MB
256 MB	C-RIMM	256 MB
512 MB	C-RIMM	512 MB
C-RIMM	64 MB	64 MB
C-RIMM	128 MB	128 MB
C-RIMM	256 MB	256 MB
C-RIMM	512 MB	512 MB
64 MB	64 MB	128 MB
64 MB	128 MB	192 MB
64 MB	256 MB	320 MB
64 MB	512 MB	576 MB
128 MB	64 MB	192 MB
128 MB	128 MB	256 MB
128 MB	256 MB	384 MB
128 MB	512 MB	640 MB

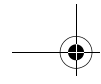

RIMM 1	RIMM 2	Total Memory
256 MB	64 MB	320 MB
256 MB	128 MB	384 MB
256 MB	256 MB	512 MB
256 MB	512 MB	768 MB
512 MB	512 MB	1024 MB or 1 GB

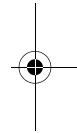
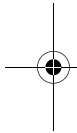



Installing a RIMM

1. Open the clips on the socket.
2. Align the RIMM with the socket.
3. Press the RIMM into the socket until the clips lock into the RIMM.

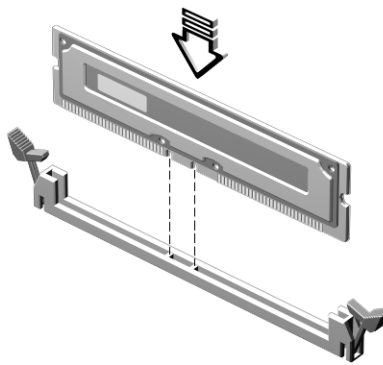

Note: The RIMM socket is slotted to ensure proper installation. If you insert a RIMM but it does not fit easily into the socket, you may have inserted it incorrectly. Turn the RIMM around and try to insert it again.

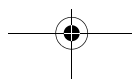
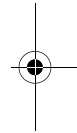
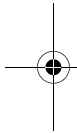

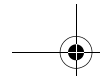

Removing a RIMM

1. Press the holding clips on both sides of the socket outward to release the RIMM.
2. Gently pull the RIMM out of the socket.

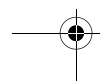
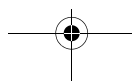
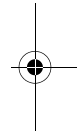
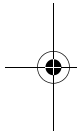
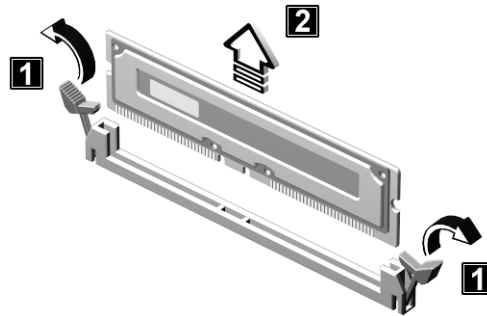

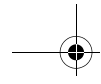

Installing a C-RIMM



Note: The C-RIMM module is needed for the RIMM module to function properly, because the RIMM module only work in series.

1. Open the clips on the socket.
2. Align the C-RIMM with the socket.
3. Press the C-RIMM into the socket until the clips lock into the C-RIMM.

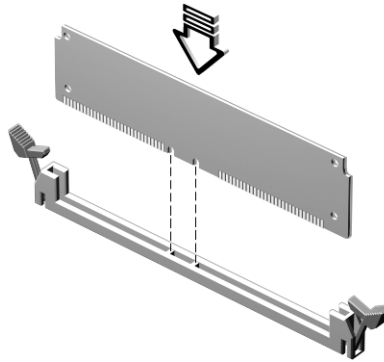

Note: The C-RIMM socket is slotted to ensure proper installation. If you insert a C-RIMM but it does not fit easily into the socket, you may have inserted it incorrectly. Turn the C-RIMM around and try to insert it again.

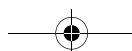
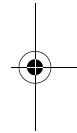
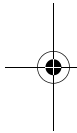

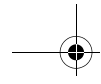

Removing a C-RIMM

1. Press the holding clips on both sides of the socket outward to release the C-RIMM.
2. Gently pull the C-RIMM out of the socket.

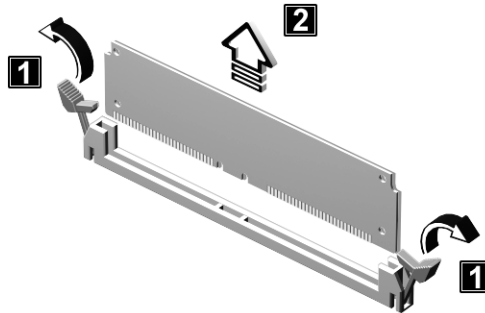

Reconfiguring the System

The system automatically detects the amount of memory installed. Run Setup to view the new value for total system memory and make a note of it.

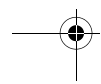
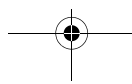
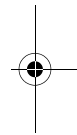
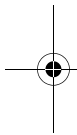

Upgrading the CPU

Removing the CPU



Note: Observe the ESD precautions on page 13 when installing or removing a system component.

Before you can replace or upgrade your processor, you need to remove the previously installed processor on the system board.

Follow these steps to remove the CPU:

1. On the system board, locate the CPU mounted on the socket.
2. Detach the fan/heatsink cable connector.

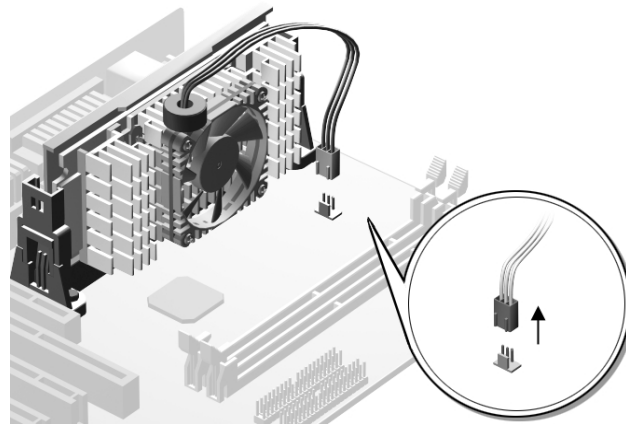

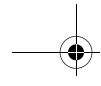

3. Gently pull the CPU straight up from its socket.

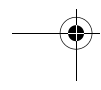
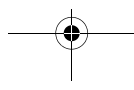
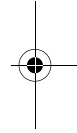
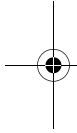
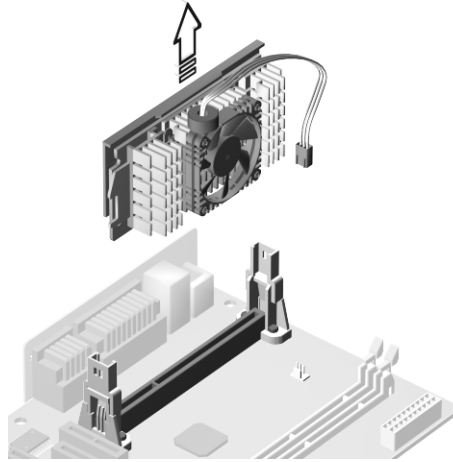

Installing the Upgrade CPU



Note: Observe the ESD precautions on page 13 when installing or removing a system component.

Before you proceed, make sure that there is no CPU installed in the CPU socket.

Follow these steps to install the upgrade CPU:

1. Insert the CPU as shown in the figure below.

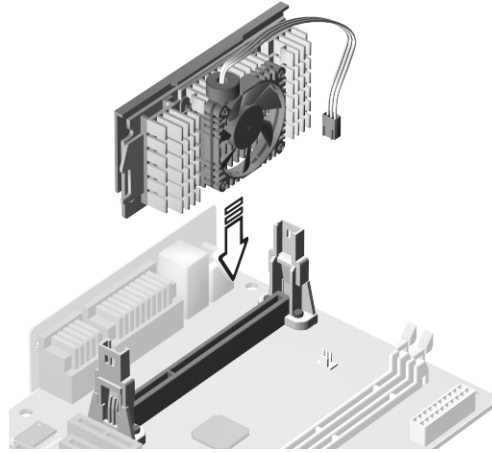

2. Plug the fan/heat sink cable to the fan connector marked FN1 (for 2-pin connector) or FN2 (for 3-pin connector).



See "Jumpers and Connectors" on page 31 for the location of the connectors on the system board.

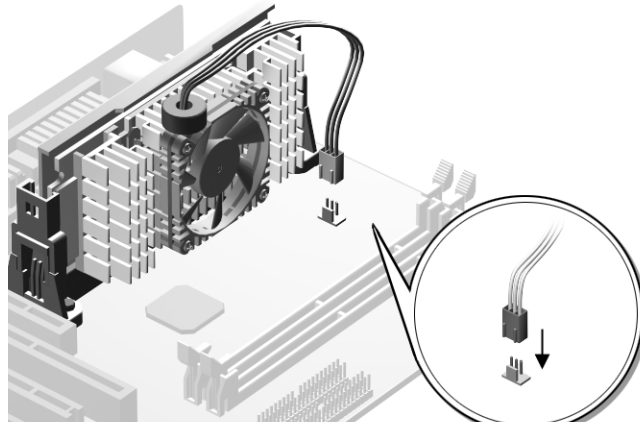

Warning! The heatsink becomes very hot when the system is on. Never touch the heatsink with any metal or with your hands.

