



AP5V Mainboard

User Guide

Copyright

Copyright © 1996 by this company. All rights reserved. No part of this publication may be reproduced, transmitted, transcribed, stored in a retrieval system, or translated into any language or computer language, in any form or by any means, electronic, mechanical, magnetic, optical, manual or otherwise, without the prior written permission of this company.

Disclaimer

This company makes no representations or warranties, either expressed or implied, with respect to the contents hereof and specifically disclaims any warranties, merchantability or fitness for any particular purpose. Any software described in this manual is sold or licensed "as is". Should the programs prove defective following their purchase, the buyer (and not this company, its distributor, or its dealer) assumes the entire cost of all necessary servicing, repair, and any incidental or consequential damages resulting from any defect in the software. Further, this company reserves the right to revise this publication and to make changes from time to time in the contents hereof without obligation to notify any person of such revision or changes.

Intel and Pentium are registered trademarks of Intel Corporation.
XT/AT is a registered trademark of International Business Machines Corporation.

Other brand and product names are trademarks and/or registered trademarks of their respective holders.

FCC Statement

FCC Class B Radio Frequency Interference Statement

Note:

This equipment has been tested and found to comply with the limits for a Class B digital device, pursuant to Part 15 of FCC Rules. These limits are designed to provide reasonable protection against harmful interference in a residential installation. This equipment generates, uses, and can radiate radio frequency energy and, if not installed and used in accordance with the instructions, may cause harmful interference to radio communications. However, there is no guarantee that interference will not occur in a particular installation. If this equipment does cause harmful interference to radio or television reception, which can be determined by turning the equipment off and on, the user is encouraged to try to correct the interference by one or more of the following measures:

1. Reorient or relocate the receiving antenna.
2. Increase the separation between the equipment and receiver.
3. Connect the equipment into an outlet on a circuit different from that to which the receiver is connected.
4. Consult the dealer or an experienced radio/television technician for help.

Notice 1:

The changes or modifications not expressly approved by the party responsible for compliance could void the user's authority to operate the equipment.

Notice 2:

Shielded interface cables, if any, must be used in order to comply with emission limits.

About This Manual

Purpose and Scope

This manual tells how to install and configure the system board.

Organization

This manual consists of three chapters and one appendix:

Chapter 1, **Overview**, covers the specifications, layout, and components of the system board.

Chapter 2, **Hardware Installation**, tells how to install the hardware components, configure the system by resetting the jumpers, install the system board and add expansion cards.

Chapter 3, **AMI BIOS Utility**, explains the system BIOS and tells how to configure the system by setting the BIOS parameters.

Appendix A, **Jumper and Connector Summary**, gives you a tabular summary of the jumper settings and onboard connectors discussed in Chapter 2.

About This Manual

Conventions

The following conventions are used in this manual:

Text entered by user,
default settings,
recommended selections

a, e, s, etc



Represent text input by the user, default
settings and recommended selections

Represent the actual keys that you
have to press on the keyboard.

NOTE

Gives bits and pieces of additional
information related to the current topic.

WARNING

Alerts you to any damage that might
result from doing or not doing specific
actions.

CAUTION

Suggests precautionary measures to
avoid potential hardware or software
problems.

IMPORTANT

Reminds you to take specific action
relevant to the accomplishment of the
procedure at hand.

TIP

Tells how to accomplish a procedure
with minimum steps through little
shortcuts.

Table of Contents

Chapter 1	Overview	
1.1	Board Layout	1-2
1.2	Specifications	1-3
1.3	System Board Parts	1-4
1.3.1	Microprocessor.....	1-4
1.3.2	ASICs.....	1-4
1.3.3	BIOS	1-4
1.3.4	Expansion Slots	1-5
1.3.5	DRAM Sockets.....	1-5
1.3.6	Second-level Cache	1-5
1.3.7	Two-channel PCI Mode 4 Enhanced IDE Interface.....	1-5
1.3.8	Super I/O Controller	1-6
1.3.9	Keyboard Connector	1-6
1.3.10	Mouse Connector.....	1-6
Chapter 2	Hardware Installation	
2.1	ESD Precautions.....	2-1
2.2	Jumper Locations.....	2-2
2.3	Setting the Jumper	2-3
2.4	Installing a Microprocessor	2-4

Table of Contents

2.5	Upgrading the Microprocessor	2-6
2.6	Voltage Regulator Module	2-7
2.6.1	Installing VRM	2-7
2.6.2	Removing a VRM	2-8
2.7	Configuring the System Memory	2-9
2.7.1	Installing a DIMM	2-10
2.7.2	Removing a DIMM	2-11
2.8	Customizing your Hardware Setup ...	2-12
2.8.1	Selecting the DIMM Type	2-12
2.8.2	Selecting the ECP DMA Channel ...	2-12
2.8.3	Clearing the CMOS	2-13
2.8.4	Disabling the Onboard Super I/O Controller	2-13
2.8.5	Setting the ISA System Clock	2-13
2.8.6	Disabling the PS/2 Mouse Function	2-14
2.8.7	Selecting the Flash ROM Type	2-14
2.8.8	Setting the Keyboard Clock	2-14
2.9	Installing the System Board	2-15
2.10	Connecting Peripherals	2-16
2.10.1	Power Cable	2-16
2.10.2	Mouse	2-16
2.10.3	Serial Devices (COM1/COM2)	2-17

Table of Contents

2.10.4	Floppy Disk Drives	2-18
2.10.5	Printer	2-18
2.10.6	IDE Devices	2-19
2.10.7	Front-panel Switches and LEDs.....	2-20
2.10.8	Keyboard.....	2-21
2.10.9	Keyboard Connector Bracket	2-22
2.11	Installing Expansion Boards	2-23
Chapter 3	AMI BIOS Utility	
3.1	Entering the AMI BIOS Setup	3-1
3.2	Setup Menu	3-3
3.2.1	Standard Setup	3-3
3.2.2	Advanced CMOS Setup	3-8
3.2.3	Chipset Features Setup.....	3-13
3.2.4	Power Management Setup.....	3-17
3.2.5	PCI/PnP Setup	3-21
3.2.6	Peripheral Setup	3-24
3.3	Security Setup	3-26
3.3.1	Supervisor Password	3-27
3.3.2	User Password.....	3-28
3.3.3	Anti-virus	3-29
3.4	Utility Setup.....	3-29
3.4.1	Color Set	3-30

Table of Contents

3.4.2	Language	3-30
3.5	Default Setup	3-31
3.5.1	Original.....	3-31
3.5.2	Optimal.....	3-32
3.5.3	Fail-safe	3-32
3.6	Exiting Setup.....	3-33
3.7	NCR SCSI BIOS and Drivers.....	3-34
Appendix A	Jumper and Connector Summary	

Chapter 1

Overview

The AP5V is a Pentium[®]-based system board with PCI/ISA architecture. It has three ISA slots and four PCI slots for future expansion. The two 168-pin dual in-line memory module (DIMM) sockets onboard allow you to expand system memory to maximum of 128 MB utilizing Synchronous DRAMs (SDRAM), Fast Page Mode, and EDO type DRAMs. The board also comes with either a 256-KB or a 512-KB pipeline-burst cache memory.

A super I/O controller and a two-channel PCI mode 4 enhanced IDE interface are also incorporated in the motherboard to further enhance system performance.

The board supports the Dark Green Power Management feature that conforms to the U.S. Environmental Protection Agency (EPA) Energy Star standards.

The board measures 220 mm x 280 mm (baby-AT), a size that easily fits most housings.

Overview

1.1 Board Layout

1	Power connector	15	Multifunction connector
2	Floppy disk drive connector	16	HDD LED connector
3	COM1 connector	17	VRM socket (optional)
4	COM2 connector	18	Voltage regulator with heatsink
5	Parallel port connector	19	Real-time clock with battery
6	168-pin DIMM sockets	20	ISA slots
7	Voltage regulator with heatsink	21	Keyboard controller
8	IDE1 connector	22	System BIOS
9	IDE2 connector	23	Super I/O controller
10	Pipeline-burst cache	24	PCI slots
11	Intel 82437 ASIC	25	Universal serial bus connector *
12	Intel 82371 ASIC	26	PS/2 mouse connector
13	CPU socket	27	AT-keyboard connector
14	Two-pin fan connector		

* Optional

Overview

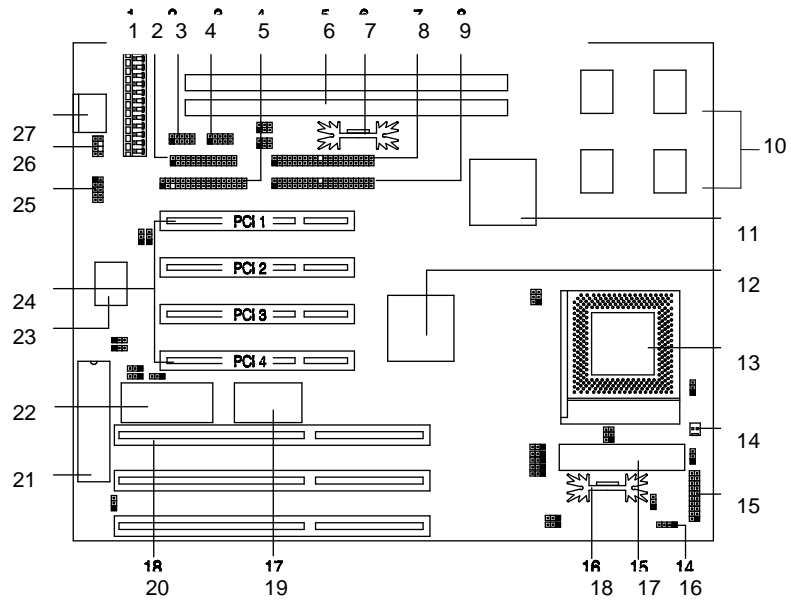

Overview

1.2 Specifications

Microprocessor	Intel Pentium (3.3V) Processor 75/90/100/120/133/150/166/200 MHz
Memory	128 MB (maximum)
DRAM Sockets	168-pin DIMM x 2, 64-bit
ASICs	Intel 430VX PCiset
Bus Architecture	ISA, PCI
Expansion Slots	Three ISA and four PCI slots
Ports	One parallel port (SPP/ECP/EPP) Two serial ports (UART 16C550) Two-channel PCI mode 4 IDE ports (bus master transfer support) One floppy disk drive port (360/720 KB, 1.2/1.44/2.88 MB formats)
Secondary Cache	256-KB/512-KB pipeline-burst cache
BIOS	AMI Plug-and-Play Flash ROM BIOS
RTC	Dallas DS12887A
Board Size	220 mm x 280 mm (baby AT)

1.3 System Board Parts

1.3.1 Microprocessor

The AP5V system board uses an Intel Pentium (3.3V) Processor running at 75, 90, 100, 120, 133, 150, 166, or 200 MHz. Chapter 2 gives details on how to install and upgrade a processor.

1.3.2 ASICs

The ASICs (application-specific integrated circuits) onboard are the Intel 82437VX, Intel 82438DX, and the Intel 82371SB. The Intel 82437VX functions as the host/PCI bridge, DRAM and second-level cache controller. The Intel 82438DX serves as the memory controller data path. The Intel 82371SB acts as the ISA/PCI bus bridge that translates the PCI bus cycles into ISA bus cycles or vice-versa. It also functions as the universal serial bus controller and supports Fast IDE and PCI/ISA master/slave interfaces.

1.3.3 BIOS

The board supports the AMI basic input-output system (BIOS). The BIOS is a program that performs the power-on self test (POST) upon booting. During POST, this program activates the peripheral devices, tests onboard memory and prepares the system for operation. For more information on AMI BIOS, see Chapter 3.

Overview

1.3.4 Expansion Slots

The board has three ISA and four PCI expansion slots. The ISA expansion slots are the black parallel bars on the system board. The PCI slots are those with white color and are shorter than the ISA slots. There are rows of golden pins inside each slot that serve as a clutch to secure the contacts of the expansion board. For information on how to install the expansion boards, see Chapter 2.

1.3.5 DRAM Sockets

The system board has two 168-pin DRAM sockets that expand system memory to a maximum of 128 B. These sockets accept single- and double-density dual in-line memory modules (DIMMs) that support 3.3V Synchronous or 3.3V Fast Page Mode (FPM)/Extended Data Out (EDO)-type DRAMs. Chapter 2 discusses the different memory configurations available.

1.3.6 Second-level Cache

The AP5V motherboard comes with either a 256-KB or a 512-KB pipeline-burst second-level cache. This pipeline-burst cache improves system performance by shortening the DRAM read prefetch time resulting to a faster data transfer rate.

1.3.7 Two-channel PCI Mode 4 Enhanced IDE Interface

The AP5V board integrates a two-channel PCI mode 4 enhanced integrated drive electronics (E-IDE) interface that allows the system to support four E-IDE devices (including hard disks with more than 528-MB capacity) via two onboard IDE connectors (see section 1.1 for the location of the connectors). This feature offers users increased data storage capacity.

1.3.8 Super I/O Controller

The onboard super I/O controller accommodates the following:

- Two UART 16450/16550-compatible fast serial ports
- A parallel port with standard parallel port (SPP), enhanced parallel port (EPP) or extended capabilities port (ECP) support. Both the EPP and ECP comply with the IEEE 1284 standards.
- 3.5-inch floppy disk drives with 720-KB, 1.44-MB or 2.88-MB format
- 5.25-inch floppy disk drives with 360-KB, 1.2-MB format

1.3.9 Keyboard Connector

The onboard keyboard connector allows you to connect any AT-compatible keyboard. See the board layout figure for the location of the keyboard connector. Chapter 2 tells how to connect an AT keyboard.

The board may also come with or without a PS/2 keyboard connector.

1.3.10 Mouse Connector

The board supports both serial and PS/2 mouse connectors. See Chapter 2 for details on how to connect a serial and a PS/2 mouse connector.

Chapter 2

Hardware Installation

This chapter gives you a step-by-step procedure on how to install your system. Follow each section accordingly.

2.1 ESD Precautions

Electrostatic discharge (ESD) can damage your processor, disk drives, expansion boards, and other components. Always observe the following precautions before you install a system component.

1. Do not remove a component from its protective packaging until you are ready to install it.
2. Wear a wrist ground strap and attach it to a metal part of the system unit before handling a component. If a wrist strap is not available, maintain contact with the system unit throughout any procedure requiring ESD protection.

Hardware Installation

2.2 Jumper Locations

The following figure shows the locations of the jumpers on the system board:

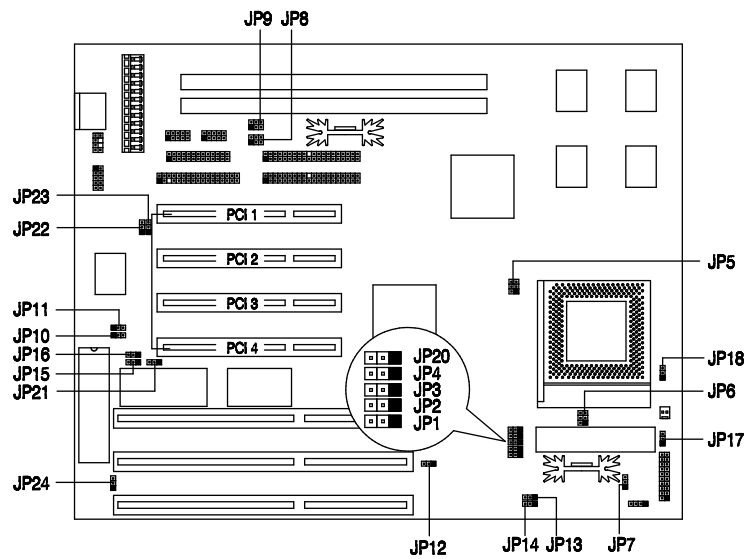

Hardware Installation

2.3 Setting the Jumper

Set a jumper switch as follows:

- To open a jumper, remove the jumper cap.
- To close a jumper, insert the plastic jumper cap over two pins of a jumper.

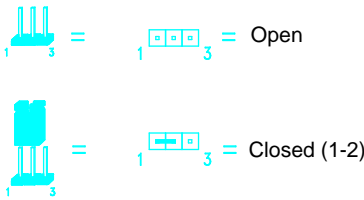

The conventions in the figure are used to represent the proper jumper settings.

Hardware Installation

2.4 Installing a Microprocessor

The motherboard comes with a zero-insertion force microprocessor socket that allows you to install a CPU without using any tool.

Follow these steps to install a CPU into a ZIF-type CPU socket:



Make sure that the system power is OFF before installing a component.

1. Locate the CPU socket on the system board and pull up the socket lever.

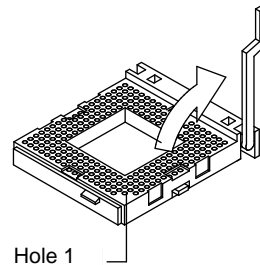

2. Insert the CPU making sure that pin 1 of the CPU aligns with hole 1 of the socket. The notched corner on the CPU indicates the location of pin 1.

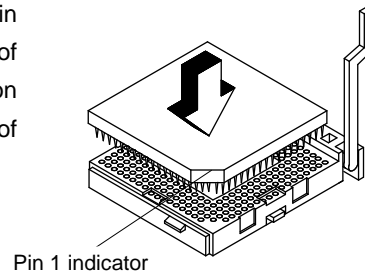

Hardware Installation

- 3. Pull down the socket lever to lock the CPU into the socket.

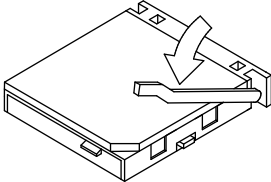

- 4. Attach the heatsink and fan to the CPU.

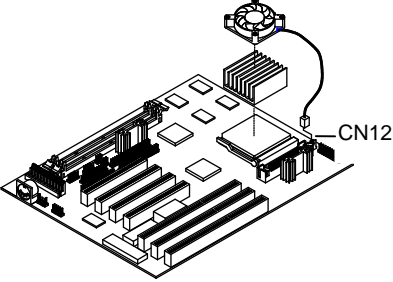

- 5. Plug the fan cable onto the two-pin fan connector onboard. The fan connector is marked **CN12** on the system board.

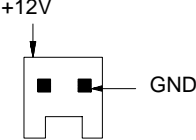

- 6. Set jumpers **JP5** and **JP6** according to the CPU type that you want to install.

CPU TYPE SELECT

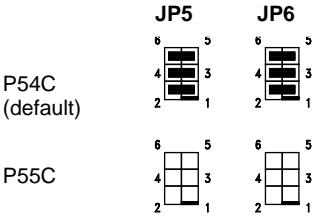

Hardware Installation

7. Set jumper **JP7** according to the CPU voltage supported.

CPU VOLTAGE SELECT

































JP7

3.45V (default) 

3.52V 

8. Set jumpers **JP1**, **JP2**, **JP3**, and **JP4** according to the frequency supported by your CPU.

CPU FREQUENCY SELECT

	JP1	JP2	JP3	JP4
75 MHz				
90 MHz				
100 MHz				
120 MHz				
133 MHz				
150 MHz				
166 MHz				
200 MHz				

2.5 Upgrading the Microprocessor

To upgrade a CPU:

1. Turn off the system power and remove the housing cover.
2. Locate the CPU socket on the system board.
3. Pull up the socket lever.
4. Remove the installed CPU, if any.

Hardware Installation

5. Install the upgrade CPU. Refer to section 2.4 for instructions on how to install a CPU.

2.6 Voltage Regulator Module



You must install the CPU first before installing the VRM. See the section 2.4 on how to install a CPU.

The system board comes with a separate voltage regulator module that enables the system to support the processor operating voltage ranging from 2.1V to 3.5V. The following sections tell how to install and remove VRM.

2.6.1 Installing VRM



Observe the ESD precautions when installing components.

Follow these steps to install a VRM:

1. Locate the VRM connector on the system board. See the board layout figure in Chapter 1.
2. Push the holding clips of the connector outward.

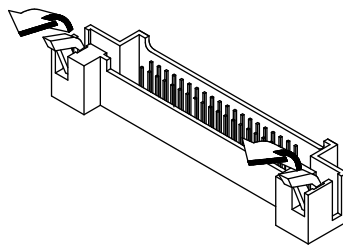

Hardware Installation

3. Align the VRM socket to the connector pins. The holding clips must be facing on the rear side of the VRM.
4. Press the VRM downward until the holding clips click into place.

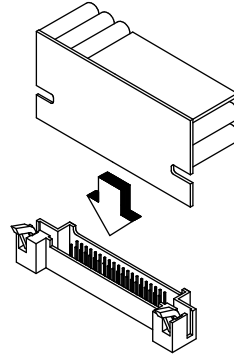

2.6.2 Removing a VRM

1. Push the holding clips outward to release the VRM.
2. Gently pull the VRM to remove it from the connector..

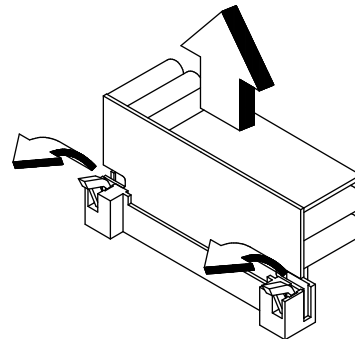

Hardware Installation

2.7 Configuring the System Memory

The system memory is expandable to 128 MB by adding dual in-line memory modules (DIMMs). The two 168-pin DIMM sockets accommodate 3.3V SDRAMs or FPM/EDO-type SDRAMs with 8, 16, 32, 64, and 128-MB capacities.

The following are the possible DIMM configurations.

Memory Configurations

DIMM 1	DIMM 2	Total Memory
8 MB		8 MB
	8 MB	8 MB
8 MB	8 MB	16 MB
16 MB		16 MB
	16 MB	16 MB
16 MB	16 MB	32 MB
32 MB		32 MB
	32 MB	32 MB
32 MB	8 MB	40 MB
8 MB	32 MB	40 MB
32 MB	16 MB	48 MB
16 MB	32 MB	48 MB
32 MB	32 MB	64 MB
64 MB		64 MB
	64 MB	64 MB
64 MB	8 MB	72 MB
8 MB	64 MB	72 MB
64 MB	16 MB	80 MB
16 MB	64 MB	80 MB
64 MB	32 MB	96 MB
32 MB	64 MB	96 MB
64 MB	64 MB	128 MB
128 MB		128 MB

Hardware Installation

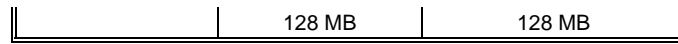

2.7.1 Installing a DIMM



Observe the ESD precautions when installing components.

Follow these steps to install a DIMM:

1. Align pin 1 of the DIMM with pin 1 of the socket. Pin 1 is labeled 1 on both the DIMM and the socket.

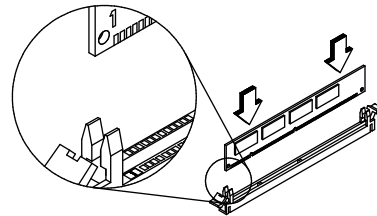

2. Gently push the DIMM until the holding clips lock the DIMM into a vertical position.

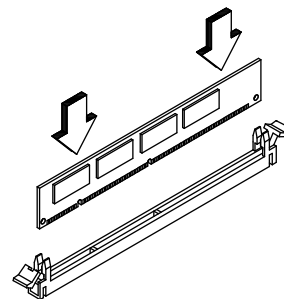

Be careful when inserting DIMMs. Forcing a DIMM in or out of a socket can damage the socket or the DIMM (or both).

Hardware Installation

2.7.2 Removing a DIMM

To remove a DIMM:

1. Press the holding clips on both sides of the socket outward to release the DIMM.
2. Gently pull the DIMM out of the socket.

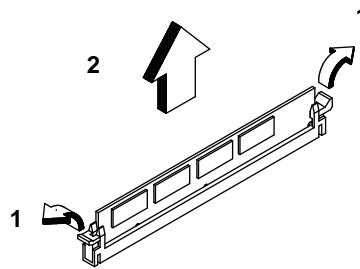

Hardware Installation

2.8 Customizing your Hardware Setup

You may customize your hardware setup according to your desired system performance. However, doing so requires resetting of several jumpers. The onboard jumpers are normally set to its default setting. See the figure in section 2.2 for the location of the jumpers on the system board.

The following sections tell how to configure the system board to meet the desired performance:

2.8.1 Selecting the DIMM Type

Set the jumpers **JP8** and **JP9** according to the DIMM type that you wish to support. The AP5V board accepts SDRAM, EDO, and FPM type DRAMs. To install SDRAMs, leave both jumpers open. To install EDO/FPM DRAMs, close pins 1-2, 3-4, and 5-6 of JP8 and JP9.

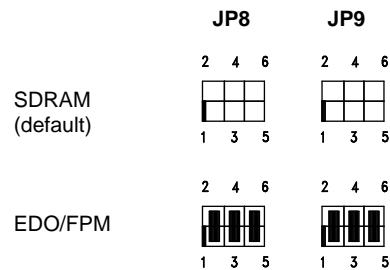

2.8.2 Selecting the ECP DMA Channel

The available ECP DMA channel selections are 3 and 1. The default is DMA channel 3. To select DMA channel 1, reset jumpers **JP10** and **JP11** to 2-3.

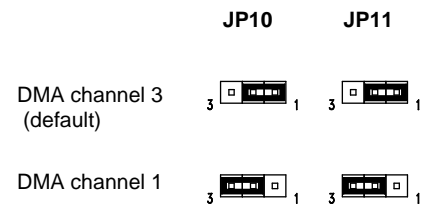

Hardware Installation

2.8.3 Clearing the CMOS

You need to clear the CMOS if you forget your system password. To do this, shut off the system power and short pins 2-3 of **JP12** for a few seconds. Reset the jumper to normal setting by shorting pins 1-2. Enter Setup to specify a new password.

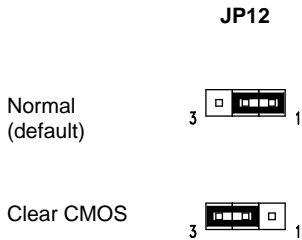

2.8.4 Disabling the Onboard Super I/O Controller

The board is preset by the manufacturer with the onboard I/O controller enabled. In case you wish to use an external I/O controller, you need to disable the onboard I/O before the external I/O card functions. To disable, you need to reset jumper **JP13** to 2-3.

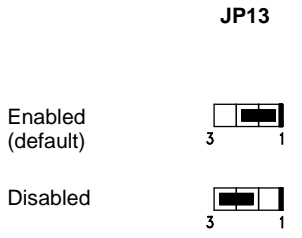

2.8.5 Setting the ISA System Clock

Set the jumper **JP14** according to the ISA system clock that your board supports. Refer to the figure on the right for the correct jumper setting.

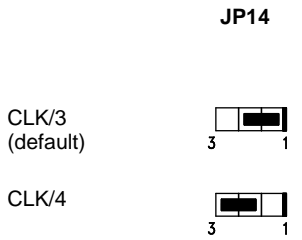

Hardware Installation

2.8.6 Disabling the PS/2 Mouse Function

The PS/2 mouse function is normally enabled and occupies IRQ12. To reassign IRQ12 to another function, you need to disable the PS/2 mouse function by setting jumper **JP15** to 2-3 and changing the BIOS setting. For detailed information on BIOS, see Chapter 3.

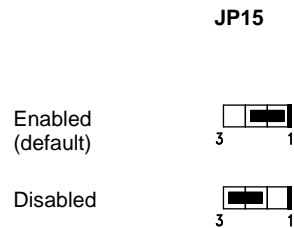

2.8.7 Selecting the Flash ROM Type

The AP5V board supports both 5V and 12V Flash ROM types. Normally, the board comes with a 5V Flash ROM and with jumper **JP16** set to 1-2. Reset the jumper to 2-3 if you want to install a 12V Flash ROM.

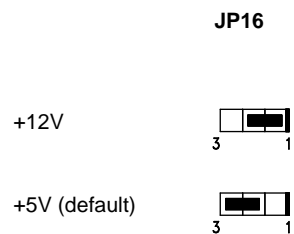

2.8.8 Setting the Keyboard Clock

By default, the keyboard clock is set to 8 MHz. However, you may increase it to 12 MHz by simply resetting jumper **JP24** to 2-3.



Hardware Installation

2.9 Installing the System Board



Make sure that you have already installed the system board components like the CPU and memory, and have set the appropriate jumpers before you proceed.

Follow these steps to install a system board into a housing:

1. Open the system housing. Refer to the housing documentation for steps on how to remove the housing cover.
2. Install the board into the housing and secure it with the screws that come with the housing.
3. Attach the cables and install the necessary peripherals. See the following section for information on how to connect the peripherals.

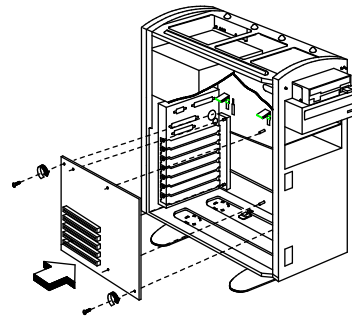

Refer to your housing documentation for more information on the system housing.

Hardware Installation

2.10 Connecting Peripherals

2.10.1 Power Cable

A standard power supply has two cables with six wires each. Plug these cables to the onboard power connector in such a way that all the black wires are in the center. The power connector is marked **CN4** on the system board.

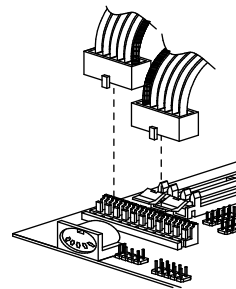

Make sure that the power supply is off before connecting or disconnecting the power cable.

Hardware Installation

2.10.2 Mouse

PS/2 Mouse (optional)

To connect a PS/2 mouse, simply insert the PS/2 bracket connector onto **CN1** on the system board.

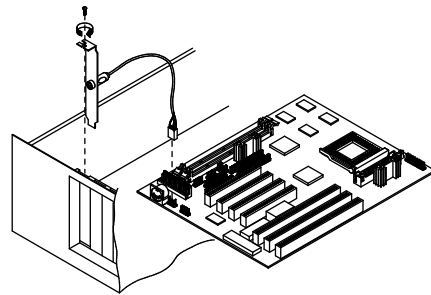

Plug a PS/2 mouse into the mouse port on the bracket.

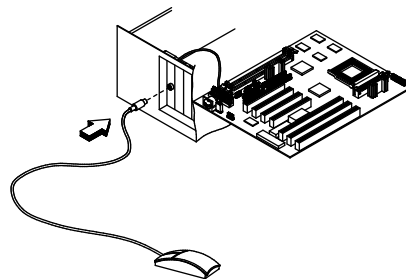

Serial Mouse

To connect a serial mouse, plug in the serial bracket connectors onto the **CN5** and **CN6**. Insert the serial mouse connector into the appropriate COM port on the bracket. See section 2.10.3.

Hardware Installation

2.10.3 Serial Devices (COM1/COM2)

To support serial devices, insert the serial device connector into the serial port on the bracket. Plug in the serial port bracket connectors onto the appropriate onboard connectors. The COM1 connector is marked **CN5** and the COM2 connector is marked **CN6** on the system board.

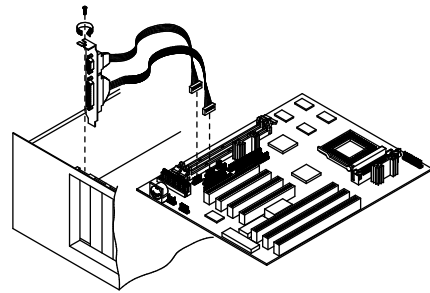

2.10.4 Floppy Disk Drives

Connect the drive cable onto the floppy disk drive connector marked **CN10** on the system board. See section 1.1 for the location of the connector. Refer to the figure on how to connect the cables.

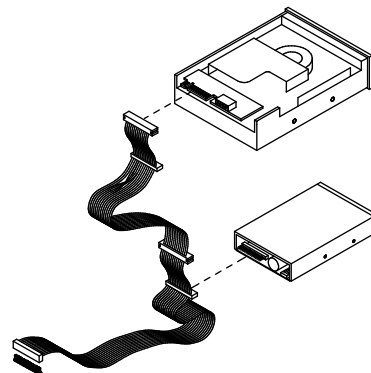

Hardware Installation

2.10.5 Printer

Plug in the printer bracket connector onto the onboard parallel connector marked **CN7** on the board. Refer to the figure.

The printer port on the bracket accepts the printer cable.

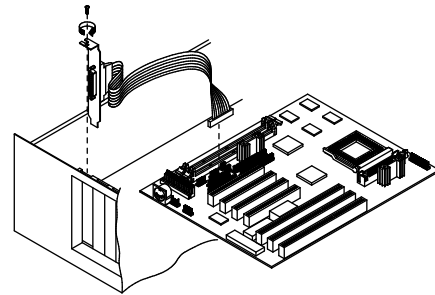

2.10.6 IDE Devices

Primary IDE Connector

The primary IDE connector marked **CN8** on the system board supports two IDE devices - one IDE hard disk and one additional IDE device. Connect your IDE HDD into the master port of the primary IDE cable. Plug in the slave port into another IDE device, if any.

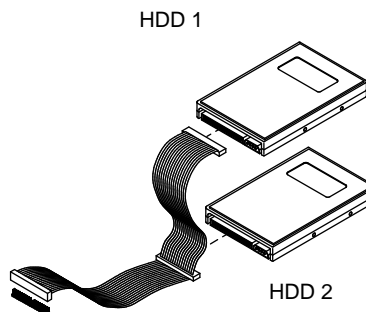

Hardware Installation

Secondary IDE Connector

The secondary IDE connector is marked **CN11** on the board. This connector also supports two IDE devices. You may connect your additional IDE HDD or CD-ROM drive to this interface. To install an IDE CD-ROM drive, connect the CD-ROM drive connector to the interface master port.

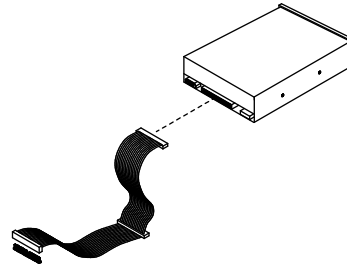

If you have more than two IDE hard disks, connect your third IDE hard disk to the master port. Then connect your CD-ROM drive to the slave port.

2.10.7 Front-panel Switches and LEDs

HDD LED

The HDD LED connector is marked **CN16** on the board. Plug the HDD LED socket onto this four-pin connector. See the figure.

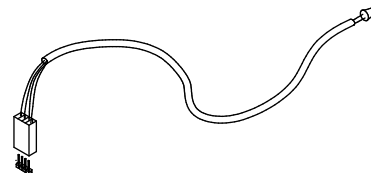

Hardware Installation

Multifunction Connector

The multifunction connector is a 20-pin connector marked **CN14** on the board. Attach the green mode LED, keylock, reset switch, turbo switch, and turbo LED connectors onto the corresponding pins as shown in the figure.

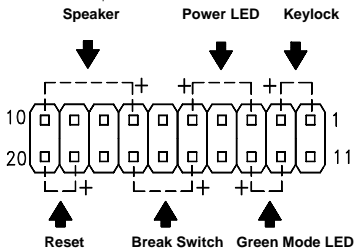

Some housings have a five-pin connector for the keylock and power LED.

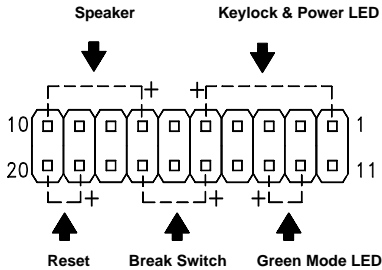

Other housings may have a 12-pin connector. If your housing has this type of connector, plug it onto CN14 as shown in the following figure. Make sure that the red wire of the connector connects to pin 11.

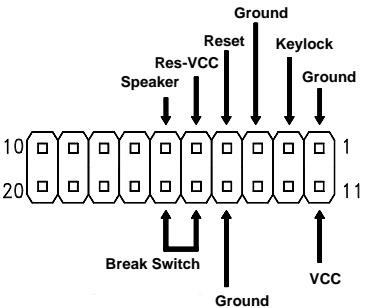

Hardware Installation

2.10.8 Keyboard

The onboard keyboard connector is a five-pin AT-compatible connector marked **CN3**. Refer to the figure on how to connect an AT keyboard.

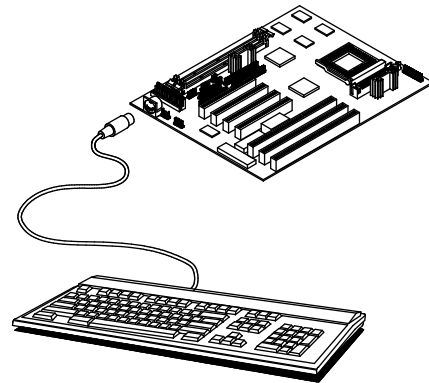

The PS/2 keyboard connector is optional.

2.10.9 Keyboard Connector Bracket

To further protect the keyboard against EMI, the motherboard comes with a keyboard connector bracket and two screws. This bracket must be attached to the keyboard port.

To attach the bracket, align the bracket holes to the connector holes. Use the two screws in the package to secure the bracket to the connector.

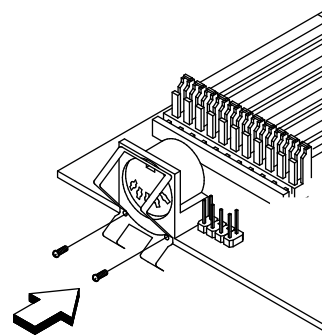

Hardware Installation

2.11 Installing Expansion Boards

Before you install any expansion board, make sure that you have secured the system board in the housing.

Follow these steps to install an expansion board:

1. Observe the ESD precautions before removing the expansion board from its protective packaging.
2. Locate an empty expansion slot on the system board.
3. Remove the bracket opposite the slot that you want to use. Save the cover and screw for future use.
4. Remove the board from its protective packaging.
5. Gently insert the golden edge of the board onto the slot until it fits into place.
6. Secure the bracket to the housing with a screw.

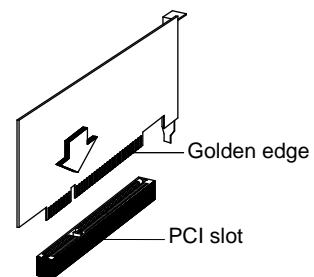
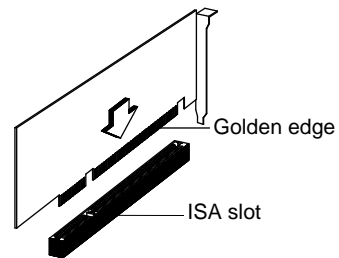

Chapter 3

AMI BIOS Utility

This chapter tells how to configure the system by setting the BIOS parameters.

3.1 Entering the AMI BIOS Setup

To enter the AMI BIOS Setup, press . The AMI BIOS Setup Main Menu appears as shown below.



AMI BIOS Utility

The AMI BIOS is in Windows form. You can use either the keyboard or a mouse to move between the items.

To select among the Setup menu groups, use  to highlight the selected group or simply click on the icon of the selected Setup menu.

To select among the options, you can either use the arrow keys to move the highlight bar or simply click on the icon of the desired option.

After making your selection, press  or double-click on the icon to open the selected menu option.



You may press  to perform the following:

- *Resolve an address conflict due to an IRQ address assigned to multiple slots. For more information on IRQ assignment, see the section 3.2.3 (Chipset Features Setup).*
- *Return to the BIOS default settings if the PnP BIOS does not recognize the hardware modifications under Windows 95.*

3.2 Setup Menu

The figure below shows the Setup window. Use the arrow keys to highlight an option.



3.2.1 Standard Setup

The following screen appears if you select Standard from the Setup options:

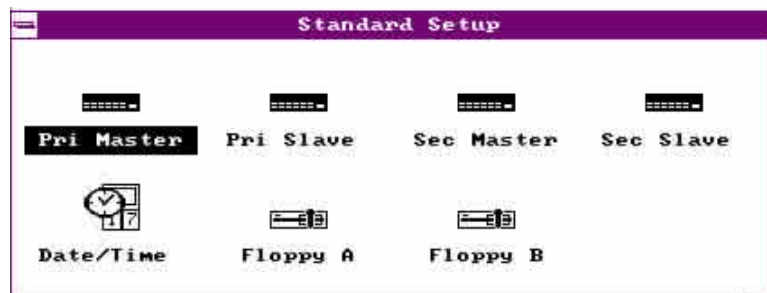

AMI BIOS Utility

You can input configuration values such as date, time and disk types in this menu.

PRIMARY MASTER AND SLAVE/ SECONDARY MASTER AND SLAVE

These parameters allow you to configure the hard disks and the IDE devices connected to your IDE connectors. To configure the hard disk connected to the master port of the primary IDE connector, select `Primary Master` and press `Enter`. The following screen appears:

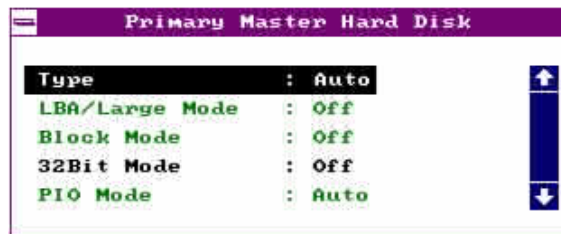

To configure the hard disk connected to the slave port of the primary IDE connector, select `Primary Slave`.

The secondary IDE connector also supports two IDE devices. To configure the hard disk or the IDE device connected to the master port, select `Secondary Master`. Choose `Secondary Slave` to configure the device connected to the slave port.

The following are the parameters that you need to set to configure your hard disks or the IDE devices:

AMI BIOS Utility

Type

This parameter lets you set the IDE device type that your system supports. The options are `User`, `Auto`, `CD-ROM`, `Type 1-46`, and `Not Installed`. Select `Auto` to automatically configure the installed hard disk or IDE device. Select `CD-ROM` if you have a CD-ROM installed in your system. If you have an old type HDD installed, you may need to enter the HDD parameters manually. To do this, you must set this parameter to `User`. Set this to `Not Installed` to bypass the function.

LBA/Large Mode

This enhanced IDE feature allows the system to use a hard disk with a capacity of more than 504 MB. This is made possible through the Logical Block Address (LBA) mode translation. Set the parameter to `Off` to disregard the feature.

This parameter becomes nonconfigurable when the HDD Type parameter is set to `Auto`.

Block Mode

This function enhanced disk performance depending on the hard disk in use. If enabled, it allows data transfers in block (multiple sectors) by increasing the data transfer rate to 256 bytes/cycle. However, if your hard disk does not support this function, set this parameter to `Off`.

This parameter becomes nonconfigurable when the HDD Type parameter is set to `Auto`.

AMI BIOS Utility

32-bit Mode

Enabling this parameter improves system performance by increasing the hard disk access to 32-bit mode. However, make sure that your hard disk supports this function before you enable the parameter. Otherwise, set this parameter to Off.

PIO Mode

Setting this parameter to On allows the system to use a faster hard disk drive. If your hard disk does not support the PIO mode feature, set this parameter to Off.



This parameter becomes nonconfigurable when the HDD Type parameter is set to Auto.

HARD DISK TYPES

After you have set all the necessary parameters, press . A list of the HDD drive parameters appears:



AMI BIOS Utility



Select your hard disk type. Press  or  to move among the selections. After you have made your selection, press .

If you cannot find your hard disk drive type on the list, select `User`. This allows you to enter the disk parameters manually.

DATE/TIME

To set the date and time, highlight `Date/Time` and press . The following screen appears:



Select the arrow keys to move among the items. Press or click on  or  to set the current time and date. Press  or double-click on the Control menu box in the upper-left corner of the window.

FLOPPY DRIVES A AND B

To configure the first floppy drive, select `Floppy A`. The following values appear on screen:



After selecting the proper setting, press .

AMI BIOS Utility

Select Floppy B and follow the same procedure to configure the second floppy drive.

3.2.2 Advanced CMOS Setup

The following screen appears if you select the option Advanced from the Setup menu:



The first screen does not show all the parameters of the Advanced Configuration menu. To scroll down the rest of the parameters, press **PGDN**. Press **↑** or **↓** to highlight the desired parameter.

AMI BIOS Utility



Do not change the settings of the Advanced Setup parameters if you are not a qualified technician. Doing so may cause fatal system failure.

AMI BIOS Utility

Quick Boot

During boot-up, the system performs power-on self test (POST) routines. Enable the parameter if you want to skip some POST routines during the boot process. Set this to `Disabled` to let the system perform all the POST routines and follow the specified boot-up sequence.

Boot-up Sequence

The boot-up sequence allows you to specify the system search sequence. The selections are `C:`, `A:`, `CD-ROM`, `A:`, `C:`, `CD-ROM` and `CD-ROM`, `A:`, `C:`. If you have a bootable CD-ROM installed, you may set the CD-ROM as the first priority. The default is `A:`, `C:`, `CD-ROM`.

Boot-up Numlock

Setting this parameter to `On` enables the numeric function of the numeric keypad. Set this parameter to `Off` to disregard the function. Disabling the numeric function allows you to use the cursor control numeric keypad. The default setting is `Off`.

Floppy Drive Swap

This parameter allows you to swap floppy drives. For example, if you have two floppy drives (A and B), you can assign the first drive as drive B and the second drive as drive A or vice-versa. Disable the parameter to bypass the function. The default is `Disabled`.

Floppy Drive Seek

When enabled, BIOS detects whether there is a floppy disk drive installed in the system. Disable the parameter to skip the function.

AMI BIOS Utility

PS/2 Mouse

Setting this parameter to `Enabled` lets you enable the PS/2 mouse function and assign IRQ12 for the said function. Set this to `Disabled` to bypass the function and to reserve IRQ12 for other functions.

Typematic Rate

This parameter lets you specify the typematic rate, i.e., the number of characters that can be entered per second.

System Keyboard

Set this parameter to `Present` if there is a keyboard connected to the system. Otherwise, select `Absent`.

Primary Display

This function specifies the VGA type in use. The selections are `VGA/EGA`, `CGA 40 x 25`, `CGA 80 x 25`, `Mono`, and `Absent`. The default setting is `VGA/EGA`.

Password Check

This parameter allows you to use the password feature. When set to `Always`, a user-password prompt appears every time you turn on the computer. When set to `Setup`, the password prompt appears when you try to enter setup. The optimal and fail-safe default setting is `Setup`.

AMI BIOS Utility

OS/2 Compatible Mode

Enable the parameter if you have an OS/2 operating system installed in your system. Otherwise, set this to *Disabled*. The default setting is *Disabled*.

Internal Cache

This function lets you enable or disable the internal cache.

External Cache

This function lets you enable or disable the external cache.

System BIOS Cacheable

Enabling this parameter allows you to change the system BIOS from ROM to RAM. When the system boots, the BIOS routines are copied into the RAM area. This enhances system performance as information access is faster in RAM than in ROM. Disabling the parameter prevents the system BIOS from being cached. The default setting is *Enabled*.

C000 ~ DC00, 16K Shadow

These parameters are for shadowing expansion cards with ROM. You need to know the specific addresses that ROMs use to shadow the expansion cards before you set any of these parameters. If you do not know this information, enable all the ROM shadow settings. This ensures shadowing of any present ROMs and reduces the available memory. Select *Cached* if the data in the chosen addresses are already copied into RAM.

AMI BIOS Utility





The F000 and E000 addresses are exclusively shadowed for BIOS.

AMI BIOS Utility

3.2.3 Chipset Features Setup

The Chipset Features Setup controls the board chipset settings. The controls for this menu are the same as for the previous screens. The Chipset Features Setup screen appears as follows.



To scroll down the rest of the parameters, press . Use  or  to highlight the desired parameter.



AMI BIOS Utility

Memory Hole

This option lets you assign the system memory area to avoid memory conflicts. The settings are 512~640K, 15~16M and Disabled.

DRAM Timing Setting

The selections for this parameter are *Auto* and *Manual*. If you select either *Auto*, the DRAM Timing subparameters become nonconfigurable since BIOS automatically sets the values. Select *Manual* if you want to specify your own parameter settings.

FAST MA TO RAS# DELAY

This option specifies the wait state between the master address (MA) and row address strobe (RAS) signals. The settings are 1 clock and 2 clocks.

EDO:SPM READ BURST TIMING

This parameter adjusts the read wait state for Extended Data Out (EDO) DRAM and Standard Page Mode (SPM) DRAM. Every time the CPU reads L2 cache miss, it reads four continuous memory cycles on four continues addresses from the EDO and SPM cache. Therefore, it has four settings to adjust.

The selections for this parameter are x444/X444, X333/X444, X222/X333, and X3222/X333.

AMI BIOS Utility

DRAM WRITE BURST TIMING

This parameter adjusts the write wait state between L2 and DRAM cache. The L2 cache is processed through write-back method and each cache write process consists of four continuous cache write cycles. Therefore, it has four settings to adjust.

The parameter settings are X444, X333, and X222. Faster DRAMs require shorter wait states. The value of X depends on the DRAM Lead-off Timing parameter setting.

FAST RAS TO CAS DELAY

This option specifies the wait state between the row address strobe (RAS) and column address strobe (CAS) signals. The available settings are 3 clocks and 2 clocks.

DRAM LEAD-OFF TIMING

This option specifies the DRAM waiting time or the delay before data can be accessed. Some DRAMs may require a longer delay to access data. The selections are 11-7-3, 10-6-3, 11-7-4, and 10-6-4.

REFRESH RAS# ASSERTION

This function controls the number of clocks required to assert RAS# for refresh cycles. The available settings are 4 clocks and 5 clocks.

FAST EDO PATH SELECT

Enable this option to select a fast path for CPU to DRAM read cycles to minimize the lead-off time. This is applicable only for EDO DRAMs. For other DRAM types, we recommend that you set this to Disabled.

AMI BIOS Utility

SDRAM CAS# LATENCY *

This parameter controls the wait state between SDRAM row address, strobe and SDRAM CAS signals.

SDRAM RAS# TIMING *

This parameter controls the RAS# precharge, RAS# active-to-precharge time, and refresh-to-RAS# active signal delay.

8-bit I/O Recovery Time (Sysclk)

This parameter allows you to set the response time of the 8-bit I/O devices connected to your system. The settings range from 1-8 SYSCLK and Disabled.

16-bit I/O Recovery Time (Sysclk)

This parameter allows you to set the response time of the 16-bit I/O devices connected to your system. The settings range from 1-4 SYSCLK and Disable.

ISA Clock Divisor

This option specifies the ISA bus clock divisor. The selections are PCICLK/4 and PCICLK/3.

Peer Concurrency

Enable the parameter to allow the CPU to run secondary DRAM PCI master cycles to target PCI peer devices. Select Disabled to hold the CPU bus. The default setting is Disabled.

* This parameter is nonconfigurable.

AMI BIOS Utility



PCI 2.1 Compliant

This parameter lets you enable or disable the PIIX3 PCI register delayed transaction and passive release functions. When enabled, the PIIX3 controls the USB operation to make sure that the system complies with the PCI revision 2.1 specification. Set this to `Disabled` to disregard the function.

3.2.4 Power Management Setup

To take advantage of the power-management feature, select `Power Management` from the Setup menu. The following screen appears:



To scroll down the rest of the parameters, press . Use  or  to highlight the desired parameter.

AMI BIOS Utility

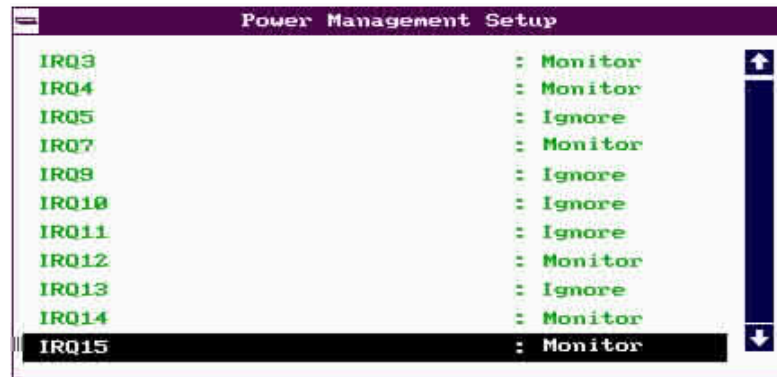

Power Management/APM

This parameter enables or disables the advanced power-management function.

Instant On Time-out (Minutes)

This parameter is configurable only if the Power Management/APM parameter is set to *Instant On*. This lets you specify when to resume system power after being in power-saving mode for a certain period of time.

Green Monitor Power-down State

This function lets you set when to power down your green PC monitor. The options are *Standby*, *Suspend*, and *Off*. The default is *Standby*.

Display Card Power-down Mode

This option allows you to set when to power down your system display card. The card function returns to full power once the system resumes to normal mode. The selections are *Standby*, *Suspend*, and *Disabled*. The default setting is *Standby*.

AMI BIOS Utility

Hard Disk Power-down Mode

This option lets you set when to pin down your IDE hard disk. The disk returns to full speed once the system resumes to normal mode. The available settings are Standby, Suspend, and Disabled. The default setting is Suspend.

Hard Disk Time-out (Minutes)

This option lets you specify when to set the hard disk to the specified power-down mode. The setting range from 1 ~ 15 Minutes and Disabled.

Standby Time-out (Minutes)

This function lets you set when to put the system into standby mode. In standby mode, the CPU clock slows down. Any event detected returns the system to full power. The setting range from 1 ~ 15 Minutes and Disabled.

Suspend Time-out (Minutes)

This function lets you set when to put the system into suspend mode. In suspend mode, the CPU clock stops. Any event detected returns the system to full power. The settings are 1 ~15 Minutes and Disabled.

Slow Clock Ratio

When the system enters the standby mode, the CPU clock starts to slow down. This parameter lets you set the "low down" clock ratio. The selections are from 1:1, 1:2, 1:4, 1:8, 1:16, 1:32, 1:64, and 1:128.

AMI BIOS Utility

Display Activity

This function lets you check the activity of the monitor. When set to **Monitor**, any detected activity from the display resumes the system to normal mode. When set to **Ignore**, the power management function bypasses the display activities detected.

IRQ 3, 4, 5, 7, 9, 10, 11, 12, 13, 14, 15

These parameters enable or disable specific I/O devices as wake up events in the power management mode. Any activity detected from the enabled IRQs resets the power-management timers and returns the system to normal mode.





*You must enable at least one IRQ activity.
Otherwise, the system stays in suspend mode.*

AMI BIOS Utility

3.2.5 PCI/PnP Setup

The PCI/PnP Setup allows you to specify the setting for your PCI devices. The screen below appears on screen if you select PCI/PnP from the Setup menu.



To scroll down the rest of the parameters, press . Use  or  to highlight the desired parameter.



AMI BIOS Utility

Plug and Play Aware O/S

Enable this parameter only if you have a Plug-and-Play operating system, such as Windows 95.

PCI IRQ Priority Auto Setting

Set this parameter to *Yes* to automatically set the appropriate interrupt for each PCI slot. Select *No* if you prefer to manually set the interrupts.

1st/2nd/3rd/4th Available IRQ

These parameters are configurable only if the PCI IRQ Priority Auto Setting parameter is set to *No*. When configurable, these let you specify the appropriate interrupt for each occupied PCI slots.

PCI VGA Palette Snoop

PCI devices support the palette snooping technique that enables the device to control access to their palette registers. Enable this parameter to activate the palette snooping function in the PCI VGA devices installed in the system. Check your VGA card manual for more information about his function. The default setting is *Disabled*.

PCI IDE Card

This function allows you to select the PCI slot(s) that you want to enable, if there is any offboard PCI IDE card present. Set this parameter to *Auto* to automatically configure the installed PCI card.

AMI BIOS Utility

PCI IDE Primary IRQ

This parameter lets you assign an IRQ for the IDE device connected to your primary IDE connector. The settings are *INTA*, *INTB*, *INTC*, *INTD*, *Hardwired* and *Disabled*. If the *PCI IDE Card* parameter is set to *Auto*, this parameter becomes nonconfigurable.

PCI IDE Secondary IRQ

This parameter lets you assign an IRQ for the IDE device connected to your secondary IDE connector. The settings are *INTA*, *INTB*, *INTC*, *INTD*, *Hardwired* and *Disabled*. If the *PCI IDE Card* parameter is set to *Auto*, this parameter becomes nonconfigurable.

Reserved Memory Size for ISA

This option lets you specify the memory area reserved for ISA devices.

Reserved Memory Base for ISA

This option lets you specify the memory base address reserved for ISA devices.

3.2.6 Peripheral Setup

Select `Peripheral` from the `Setup` menu and the following screen appears.



Onboard FDC

This parameter enables or disables the floppy drive controller.

Onboard Serial Port 1

This parameter allows you to select the address for the first serial port. The available settings are `Auto`, `3F8h`, `2F8h`, `3E8h`, `2E8h`, and `Disabled`. Selecting `Disabled` deactivates the port.

Onboard Serial Port 2

This parameter allows you to select the address for the second serial port. The available settings are `Auto`, `3F8h`, `2F8h`, `3E8h`, `2E8h`, and `Disabled`. Selecting `Disabled` deactivates the port.

AMI BIOS Utility

Onboard Parallel Port

This parameter allows you to select the address for the parallel port. The available settings are `Auto`, `378h`, `278h`, `3BCh`, and `Disabled`. Selecting `Disabled` deactivates the parallel port.

PARALLEL PORT MODE

This parameter specifies the parallel port mode. The mode options are `Normal`, `EPP`, and `ECP`. The default is `Normal`.

PARALLEL PORT ECP DMA CHANNEL 1

This parameter is configurable only if the Onboard Parallel Port is NOT set to `Auto`. and the Parallel Port Mode is set to `ECP`. This allows you to set an ECP DMA channel for the parallel port function. The selections are `0`, `1`, and `3`.



Make sure that your system board ECP DMA setting and the Parallel Port ECP DMA channel setting are the same.

Onboard IDE

This parameter enables or disables the IDE device(s) connected to your system. The selections are `Primary`, `Secondary`, `Both` and `Disabled`.

3.3 Security Setup

The Security window contains the password and anti-virus features.



AMI BIOS Utility

3.3.1 Supervisor Password

The use of password prevents unauthorized use of your computer. If you enabled the Supervisor password, the system prompts for the correct password before granting access to Setup.

To set a Supervisor password, select `Supervisor` from the Security window. The following screen appears:



Follow these steps to set up a password using the keyboard:

1. Type in a six-character password using letters, numbers, or a combination of both. When you type the characters, they appear as asterisks on the password screen boxes.
2. Press .
3. Retype the password when a password confirmation box appears asking you to retype the password.

AMI BIOS Utility

You may also use the mouse and the characters on the screen to set up a password.

1. Click on six characters from the password screen. The characters appear on the boxes as asterisks.
2. Click on .
3. Enter the password when a confirmation box appears.

3.3.2 User Password

If you enabled the User password, it is impossible to boot the computer and enter Setup without entering the correct password.

To set a User password, select `User` from the Security window. The following screen appears:



For instructions on how to enter a password, follow the procedures listed in section 3.3.1.

AMI BIOS Utility

3.3.3 Anti-virus

Select `Anti-Virus` from the Security window to display the following option box.

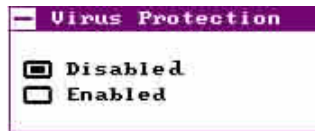

The virus protection options allow you to enable or disable the virus protection feature.

3.4 Utility Setup

The Utility window lets you change WinBIOS Setup colors and language setting.



AMI BIOS Utility

3.4.1 Color Set

Select `Color Set` from the Utility window to display the following screen.



Use the arrow keys or simply click an option to select your desired background color for WinBIOS.

3.4.2 Language

Select `Language` from the Utility window to display the following screen.



The system language currently supported is only English.

AMI BIOS Utility

3.5 Default Setup

The Default window allows you to select a group of settings for all WinBIOS Setup options.



3.5.1 Original

When you select *Original*, a dialog box prompts you to restore the old values. Select *No* to keep your current settings or *Yes* to restore the original values.



3.5.2 Optimal

When you select `Optimal`, a dialog box prompts you to load the optimal values. Select `No` to keep your current settings or `Yes` to load the optimal values.



3.5.3 Fail-safe

When you select `Fail-safe`, a dialog box prompts you to load the fail-safe values. Select `No` to keep your current settings or `Yes` to load the fail-safe values.







AMI BIOS Utility

3.6 Exiting Setup

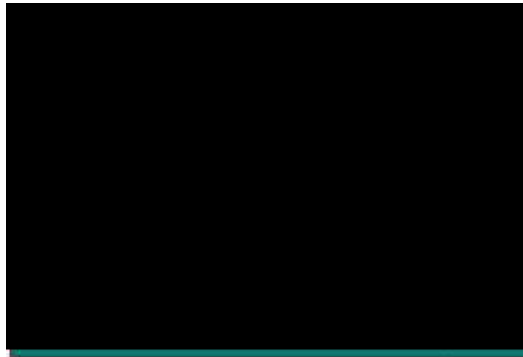
Carefully check your new settings when you have finished configuring the system. If correct, write them down and keep the recorded values in a safe place. If in the future, the battery loses power or the CMOS chip is damaged, you will know what values to enter when you rerun setup.

Press  to display the following screen.



Press  or , then  or simply click on an option to select. Select `Save changes and Exit` to save the changes that you made. Select `Do not save changes and Exit` to leave setup without saving your changes. Select `Continue` if you want to make any more configuration changes.

3.7 NCR SCSI BIOS and Drivers

The NCR 53C810 SCSI BIOS resides on the same flash memory chip as the system BIOS. To use the onboard NCR BIOS, you need to install an NCR 53C810 SCSI controller card in your system.

All SCSI devices that you install in your system require software drivers. The NCR SCSI BIOS directly supports SCSI hard disks under DOS, Windows and OS/2. It also uses DOS-format and SCO UNIX-format support floppy disk device drivers that come with the NCR 53C810 SCSI controller card. The DOS-format device drivers are for SCSI devices used with DOS, Windows NT, Novell NetWare and OS/2. The SCO UNIX-format device drivers are for SCSI devices used with SCO UNIX. These drivers offer higher performance than the direct BIOS support.

To use the device drivers, you must install them in your system hard disk drive and add them to your system configuration files. For detailed installation instructions, see the README files that come with the drivers.



The system board also supports the AMI Flash Memory Writer Utility that allows you to upgrade the system BIOS. For more information on this utility, contact your local distributor.

Appendix A

Jumper and Connector Summary

CPU Type

CPU Type	JP5	JP6
P54C *	Closed	Closed
P55C (optional)	Open	Open

CPU Voltage

CPU Voltage	JP7
3.45V *	1-2
3.52V	2-3

CPU Frequency

CPU Frequency	JP1	JP2	JP3	JP4
75 MHz *	1-2	1-2	1-2	1-2
90 MHz	1-2	1-2	2-3	1-2
100 MHz	1-2	1-2	1-2	2-3
120 MHz	1-2	2-3	2-3	1-2
133 MHz	1-2	2-3	1-2	2-3
150 MHz	2-3	2-3	2-3	1-2
166 MHz	2-3	2-3	1-2	2-3
200 MHz	2-3	1-2	1-2	2-3

* Default

Jumper and Connector Summary

DIMM Type

DIMM Type	JP8	JP9
SDRAM *	Open	Open
EDO/FPM	Closed	Closed

ECP DMA Channel

ECP DMA Channel	JP10	JP11
DMA 3 *	1-2	1-2
DMA 1	2-3	2-3

CMOS

Function	JP12
Normal *	1-2
Clear CMOS	2-3

Onboard I/O

Function	JP13
Enabled *	1-2
Disabled	2-3

ISA System Clock

Clock	JP14
Clk/3 *	1-2
Clk/4	2-3

* Default

Jumper and Connector Summary

PS/2 Mouse

Function	JP15
Enabled *	1-2
Disabled	2-3

Flash ROM Type

Type	JP16
+12V	1-2
+5V *	2-3

Keyboard Clock

KB Clock	JP24
8 MHz *	1-2
12 MHz	2-3

Reserved Jumpers

Jumper	Setting (default)
JP17	1-2
JP18	1-2
JP20	1-2
JP22 & JP23	2-3

* Default

Jumper and Connector Summary

Onboard Connectors

Connector	Function
CN1	PS/2 mouse connector
CN2	PS/2 keyboard connector
CN3	AT-keyboard connector
CN4	Power connector
CN5	COM1 connector
CN6	COM2 connector
CN7	Printer connector
CN8	Primary E-IDE connector
CN9	USB connector (optional)
CN10	FDC connector
CN11	Secondary E-IDE connector
CN12	Fan power connector
CN13	VRM connector (optional)
CN14	Multifunction connector
CN15	IR connector (optional)
CN16	HDD LED connector