



Dell™ OptiPlex™ GX1 Small-Form-Factor System User's Guide

[Introduction](#)

[Setup and Operation](#)

[Using the System Setup Program](#)

[Installing Upgrades](#)

[Troubleshooting](#)

[Specifications](#)



NOTE: You can obtain the latest version of this document from the Dell Web support site at <http://support.dell.com>.

Model DCP

Notes, Notices, and Cautions

Throughout this guide, there may be blocks of text printed in bold type or in italic type. These blocks are notes, notices, and cautions, and they are used as follows:



NOTE: A NOTE indicates important information that helps you make better use of your system.

NOTICE: A NOTICE indicates either potential damage to hardware or loss of data and tells you how to avoid the problem.



CAUTION: A CAUTION indicates a potentially hazardous situation which, if not avoided, may result in minor or moderate injury.

Information in this document is subject to change without notice.

© 1999–2000 Dell Computer Corporation. All rights reserved.

Reproduction in any manner whatsoever without the written permission of Dell Computer Corporation is strictly forbidden.

Trademarks used in this text: *Dell*, *OptiPlex*, *Dimension*, *Inspiron*, *Latitude*, *DellWare*, *Dell OpenManage*, and the *DELL* logo are trademarks of Dell Computer Corporation; *Intel*, *Pentium*, and *LANDesk* are registered trademarks and *MMX* is a trademark of Intel Corporation; *Microsoft*, *MS-DOS*, *Windows*, *Windows NT*, and *DirectX* are registered trademarks and *Windows for Workgroups* is a trademark of Microsoft Corporation; *IBM* and *OS/2* are registered trademarks of International Business Machines Corporation; *3Com* is a registered trademark of 3Com Corporation; *VESA* is a registered trademark of Video Electronics Standards Association. As an ENERGY STAR Partner, Dell Computer Corporation has determined that this product meets the ENERGY STAR guidelines for energy efficiency.

Other trademarks and trade names may be used in this document to refer to either the entities claiming the marks and names or their products. Dell Computer Corporation disclaims any proprietary interest in trademarks and trade names other than its own.

Initial release: 9 Jun 1999

Last revised: 17 Feb 2000

[Back to Contents Page](#)

Introduction: Dell™ OptiPlex™ GX1 Small-Form-Factor System User's Guide

- [Overview](#)
- [System Features](#)
- [Hardware Features](#)
- [Software Features](#)
- [Manageability Features](#)
- [Security Features](#)
- [ENERGY STAR® Compliance](#)

Overview

Dell OptiPlex GX1 small-form-factor systems are high-speed, expandable personal computers designed around the Intel® Pentium® II or III microprocessor. Each computer system uses a high-performance Peripheral Component Interconnect (PCI) design that allows you to configure the computer system to your initial requirements and then add Dell-supported upgrades as necessary.

System Features

Your system offers the following features:

- An Intel Pentium II or Pentium III microprocessor.

The Intel Pentium II and Pentium III microprocessors include MMX™ technology designed to handle complex multimedia and communications software. This microprocessor incorporates new instructions and data types as well as a technique called single instruction, multiple data (SIMD) that allows the microprocessor to process multiple data elements in parallel, thereby improving overall system performance.

- A keyboard command (<Ctrl><Alt><\\>) that lets you switch between the microprocessor's rated speed and a slower compatibility speed.



NOTE: This keyboard command is not available under the Microsoft® Windows NT® and IBM® OS/2® operating systems.

- A secondary cache of 512 KB of static random-access memory (SRAM) included within the single-edge contact (SEC) cartridge, which also contains the microprocessor.
- System memory that can be increased up to 768 megabytes (MB) by installing 32-, 64-, 128-, or 256-MB synchronous dynamic RAM (SDRAM) dual in-line memory modules (DIMMs) in the three DIMM sockets on the system board. The system also supports both error checking and correction (ECC) and nonparity DIMMs. See "[System Memory](#)" for details.

Self-Monitoring and Analysis Reporting Technology II (SMART II) support, which warns you at system start-up if your hard-disk drive has become unreliable. To take advantage of this technology, you must have a SMART II-compliant hard-disk drive in your computer. All hard-disk drives shipped with OptiPlex GX1 systems are SMART II-compliant.

- A basic input/output system (BIOS), which resides in flash memory and can be upgraded by diskette or remotely over a network, if required.
- Full compliance with PCI specification 2.1.
- Full Plug and Play version 1.0a capability, which greatly simplifies the installation of expansion cards. Plug and Play support included in the system BIOS allows you to install Plug and Play expansion cards without setting jumpers or switches or performing other configuration tasks. Also, because the system BIOS is stored in flash memory, it can be updated to support future enhancements to the Plug and Play standard.
- Wakeup On LAN capability, which, when enabled in the [System Setup program](#), allows the system to be turned on from a server management console. Wakeup On LAN capability also allows remote computer setup, software downloading and installation, file updates, and asset tracking after hours and on weekends when network traffic is at a minimum.
- Universal Serial Bus (USB) capability, which can simplify connecting peripheral devices such as mice, printers, and computer speakers. The USB connectors on your computer's back panel, which are enabled by default, provide a single connection point for multiple USB-compliant devices. USB-compliant devices can also be connected and disconnected while the system is running.
- A modular computer chassis with a minimum number of screws for easy disassembly and improved serviceability.

Hardware Features

The system board includes the following integrated features:

- Two 32-bit PCI expansion slots on a riser board (half-length PCI expansion cards only).
- A 64-bit accelerated graphics port (AGP) video subsystem, which includes the ATI 3D Rage Pro super video graphics array (SVGA) video controller. This video subsystem contains 4 MB (upgradable to 8 MB) of synchronous graphics RAM (SGRAM) video memory. Maximum resolutions are 1600 x 1200 with 65,536 colors noninterlaced and 1280 x 1024 and 1024 x 768 with true-colors noninterlaced. In 800 x 600 and 640 x 480 resolutions, 16.7 million colors are available for true-color graphics using a 32-bits per pixel (bpp) format. True-color provides higher performance, but uses more graphics memory. Table 1 lists the video memory requirements for the Microsoft Windows® 95 and Windows NT 4.0 operating systems.

Table 1. Video Memory Requirements

| Video Resolution | Maximum Color Depth | Maximum Refresh Rate | Maximum SGRAM Required |
|------------------|------------------------|----------------------|------------------------|
| 640 x 480 | True-Color (32 bpp) | 85 hertz (Hz) | 4 MB |

| | | | |
|-------------|---------------------------|-------|------|
| 800 x 600 | True-color (32 bpp) | 85 Hz | 4 MB |
| 1024 x 768 | True-color (32 bpp) | 85 Hz | 4 MB |
| 1280 x 1024 | True-color (32 bpp) | 75 Hz | 8 MB |
| 1600 x 1200 | 65,536 colors (16 bpp) | 75 Hz | 8 MB |

2X AGP provides a dedicated bus from the video subsystem to the system chip set. AGP-based video subsystems have two significant performance advantages over PCI-based video subsystems:

— The AGP bus reduces bandwidth requirements of the PCI bus, improving overall system performance.

— The AGP bus allows a 3D video subsystem to execute directly from main memory.

- A diskette interface, which supports a 3.5-inch diskette drive.
- Enhanced integrated drive electronics (EIDE) support. The primary and secondary interface are both located on the PCI bus to provide faster data throughput. Each interface supports high-capacity EIDE drives, as well as devices such as ATA 33 hard-disk drives and EIDE CD-ROM drives.
- Two high-performance serial ports and one bidirectional parallel port for connecting external devices. The parallel port is fully Enhanced Capabilities Port (ECP)-compliant.
- A Personal System/2 (PS/2)-style keyboard port and a PS/2-compatible mouse port.
- An optional integrated, 10/100-megabit-per-second (Mbps) 3Com® PCI 3C905B-TX Ethernet network interface controller (NIC). The NIC is configured using software on the *Dell ResourceCD*.
- A 16-bit, integrated Plug and Play Crystal CS4236B audio controller that provides all the sound functions of the Sound Blaster Pro expansion card. For more information, see the *Dell ResourceCD*.

Software Features

The following software is included with your Dell computer system:

- System utilities that safeguard your system and enhance the operation of its features. For more information, see the *Dell ResourceCD*.
- Video drivers for displaying many popular applications in high-resolution modes. For more information, see the *Dell ResourceCD*.
- Audio drivers for enabling the sound functions on the expansion sound card. For more information, see the *Dell ResourceCD*.
- Bus-mastering EIDE drivers to improve performance by off-loading certain functions from the microprocessor during multithreaded operation (when several application programs are running simultaneously). For more information, see the *Dell ResourceCD*.

- The System Setup program for quickly viewing and changing the configuration information for your system. For more information on this program, see "[System Setup Program](#)."
 - Enhanced security features (a setup password, a system password, a system-password lock option, a write-protect option for diskette drives, and automatic display of the system's service tag number) available through the System Setup program. In addition, a customer-definable asset tag number can be assigned via a software support utility and viewed on the [System Setup screen](#). For more information, see "[System Setup Program](#)."
 - Advanced power management options that can reduce the energy consumption of your system. For more information, see "[System Setup Program](#)."
 - [Dell Diagnostics](#) for evaluating the computer's components and devices.
 - Network device drivers for several network operating systems. For more information, see the *Dell ResourceCD*.
 - Desktop Management Interface (DMI) support, which enables the management of your computer system's software and hardware. DMI defines the software, interfaces, and data files that enable your system to determine and report information about system components.
-

Manageability Features

Your system incorporates many hardware and software features to improve the manageability of the system. Installed features include:

- [Dell OpenManage™ program](#)
- [Fault management](#)
- [Configuration management](#)
- [Asset management](#)
- [Security management](#)
- [Preboot eXecution Environment \(PXE\)](#)
- [Wakeup On LAN](#)
- [Auto Power On](#)
- [Temperature monitoring](#)

Dell OpenManage Program

The Dell OpenManage program is the Dell software-management application interface for DMI. It allows you to manage system-level information, such as system configuration information and management information format (MIF) database values (see Figure 1).

Figure 1. Dell OpenManage Program



On systems running Windows 95, Windows 98, and Windows NT 4.0, the Dell OpenManage program is available in client and administrator versions. The Dell OpenManage administrator version enables system administrators to view, manage, and inventory remote systems in a Dell DMI client network and incorporates the following manageability features, which are based on the DMI 2.0 specification.

Fault Management

Fault management features of Dell OpenManage include:

- Alerts to warn you about events generated by SMART drives on a local or remote system and about thermal errors
- An event log that stores events in a text file and reports information about the event under the following options: **System Name, Component Name, Date and Time, Event Type, Event Severity, Event Class, Event System**

Configuration Management

Configuration management features of Dell OpenManage include:

- Wakeup On LAN support, which allows network administrators to remotely turn on Managed PC systems with Wakeup On LAN capability in a Dell DMI network.
- A **System Properties** window that enables network administrators to view, set, or disable certain hardware configuration settings for the local and remote systems in a Dell DMI network.
- Support for the Microsoft System Management Server (SMS), which allows the exporting of one or more groups to an SMS directory that the SMS administrator can access.
- A monitor component for systems running Windows 95 that have a display data channel (DDC)-

compliant video subsystem and monitor.

- Automated inventory control of one or more groups for the remote systems in a Dell DMI network. Network administrators can automate inventory to occur every day, week, or month at a certain hour, on the hour; or they can enable inventory as needed. Dell OpenManage creates a text file for the group(s) and saves it to a user-defined directory.
- Support for the application program used to create user-definable attributes (UDAs).

Asset Management

Asset management features of Dell OpenManage include:

- Support that enables network administrators to remotely view, enter, and modify an asset tag for a remote system in a Dell DMI network
- Automated and manual mapping of one or more groups to a user-defined directory

Security Management

Security management features of Dell OpenManage include:

- Password security that enables network administrators to maintain standard attribute values for the local and remote systems in a Dell DMI network

For more information about Dell OpenManage, refer to the online *Dell OpenManage Help* that accompanied the software.

PXE

The Preboot eXecution Environment (PXE) allows a personal computer to be managed by one or more configuration management servers running the Intel LANDesk® Configuration Manager (LCM) software, which provides management services for the many Managed PC systems on the network. The LCM allows network administrators to do the following:

- Provide preboot support for a new Managed PC system that depends on the server for its initial operating system installation
- Service the network boot requests from the Managed PC systems
- Download diagnostics and BIOS update utilities
- Format the hard-disk drive, if required
- Download and install the operating system, based on previously established profiles
- Download and install application software
- Update the operating system and applications as required

For additional information about the Intel LCM, refer to the documentation that accompanied the software.

Wakeup On LAN

The Wakeup On LAN feature allows you to remotely turn on a Managed PC system that is in a sleep state. The ability to turn on the Managed PC systems remotely allows you to perform remote computer setup, software downloading and installation, file updates, and asset tracking after hours and on weekends when users are not using the systems and network traffic is at a minimum.

To use the Wakeup On LAN feature, each Managed PC system must contain a NIC that supports Wakeup On LAN. You must also enable the [Wakeup On LAN](#) option in the System Setup program.

Auto Power On

Auto Power On enables you to turn on the computer system automatically on certain days of the week at a preset time. You can set Auto Power On to turn on the system either every day or every Monday through Friday.



NOTE: This feature does not work if the system is shut off using a power strip or surge protector.

Temperature Monitoring

Your system includes temperature probes to sense when the processor becomes overheated. In such a case, a message appears on the screen when Dell OpenManage is running or at the next system start-up notifying you of the problem.

Security Features

Your system has the following integrated security features.

- [Chassis intrusion](#)
- [Security cable slot and padlock ring](#)
- [Passwords](#)

Chassis Intrusion

An integrated chassis intrusion alarm displays the status of the system chassis intrusion monitor. If the chassis has been opened, the setting changes to **Detected** and the following message is displayed during the boot sequence at system start-up:

```
Alert! Cover was previously removed.
```

The field can be cleared using the System Setup program to enable future intrusions to be detected. For more information, see "[System Setup Program](#)."

Security Cable Slot and Padlock Ring

The padlock ring allows you to secure the computer cover to the chassis to prevent unauthorized access to the inside of the computer. To use the padlock ring, insert a commercially available padlock through the ring

and then lock the padlock.

On the back of the computer are a security cable slot and padlock ring (see [Figure 3](#) in "Setup and Operation") for attaching commercially available antitheft devices. (The padlock ring is recessed inside the cover.) Security cables for personal computers usually include a segment of galvanized cable with an attached locking device and key. To prevent unauthorized removal of your computer, loop the cable around an immovable object, insert the locking device into the security cable slot on the back of your computer, and lock the device with the key provided. Complete instructions for installing this kind of antitheft device are usually included with the device.

 **NOTES:** *Antitheft devices are of differing designs. Before purchasing such a device, make sure it will work with the cable slot on your computer.*

Installing a security cable with a locking device in the security cable slot also prevents unauthorized access to the inside of the computer.

Passwords

The password feature enables you to set a user-defined password to restrict access to the system. Additional protection is available through the System Setup program. When the **Setup Password** option is set to **Enabled**, **Password Status** allows you to prevent the system password from being changed or disabled at boot time. For more information, see "[System Setup Program](#)."

ENERGY STAR® Compliance

Certain configurations of Dell computer systems comply with the requirements set forth by the Environmental Protection Agency (EPA) for energy-efficient computers. If the front panel of your computer bears the ENERGY STAR® Emblem (see [Figure 2](#)), your original configuration complied with these requirements and all ENERGY STAR® power management features of the computer are enabled. To disable or change the operation of these features, you must change the setting for the [Power Management](#) option in the [System Setup program](#).

 **NOTES:** *As an ENERGY STAR® Partner, Dell Computer Corporation has determined that this product meets the ENERGY STAR® guidelines for energy efficiency.*

*Any Dell computer bearing the ENERGY STAR® Emblem is certified to comply with EPA ENERGY STAR® requirements **as configured when shipped by Dell**. Any changes you make to this configuration (such as installing additional expansion cards or drives) may increase the system's power consumption beyond the limits set by the EPA's ENERGY STAR® Computers program.*

Figure 2. ENERGY STAR Emblem



The EPA's ENERGY STAR® Computers program is a joint effort between the EPA and computer

manufacturers to reduce air pollution by promoting energy-efficient computer products. The EPA estimates that use of ENERGY STAR® computer products can save computer users up to two billion dollars annually in electricity costs. In turn, this reduction in electricity usage can reduce emissions of carbon dioxide, the gas primarily responsible for the greenhouse effect, and sulfur dioxide and nitrogen oxides, which are the two primary causes of acid rain.

Computer users can also help to reduce electricity usage and its side effects by turning off their computer systems when they are not in use for extended periods of time, particularly at night and on weekends.

[Back to Contents Page](#)

[Back to Contents Page](#)

Setup and Operation: Dell™ OptiPlex™ GX1 Small-Form-Factor System User's Guide

- [Getting Started](#)
- [Connecting Peripheral Devices](#)
- [Controls and Indicators](#)
- [Chassis Intrusion](#)
- [Security Cable Slot and Padlock Ring](#)
- [Using the System Password Feature](#)
- [Using the Setup Password Feature](#)
- [Disabling a Forgotten Password](#)

Getting Started

If you need to set up your computer system yourself (rather than having it set up by a network administrator), see "Getting Started" in the *System Information Guide* that accompanied your system for instructions on connecting cables and turning on your system for the first time.

After you correctly connect all the cables to your system and turn it on, see the setup guide for your operating system to complete its installation. When the operating system is installed, you can connect peripheral devices such as a printer or install application programs not already installed by Dell.

Connecting Peripheral Devices

Figure 1 shows the connectors on the back of your computer for attaching external devices.

Figure 1. I/O Ports, Connectors, and Indicators

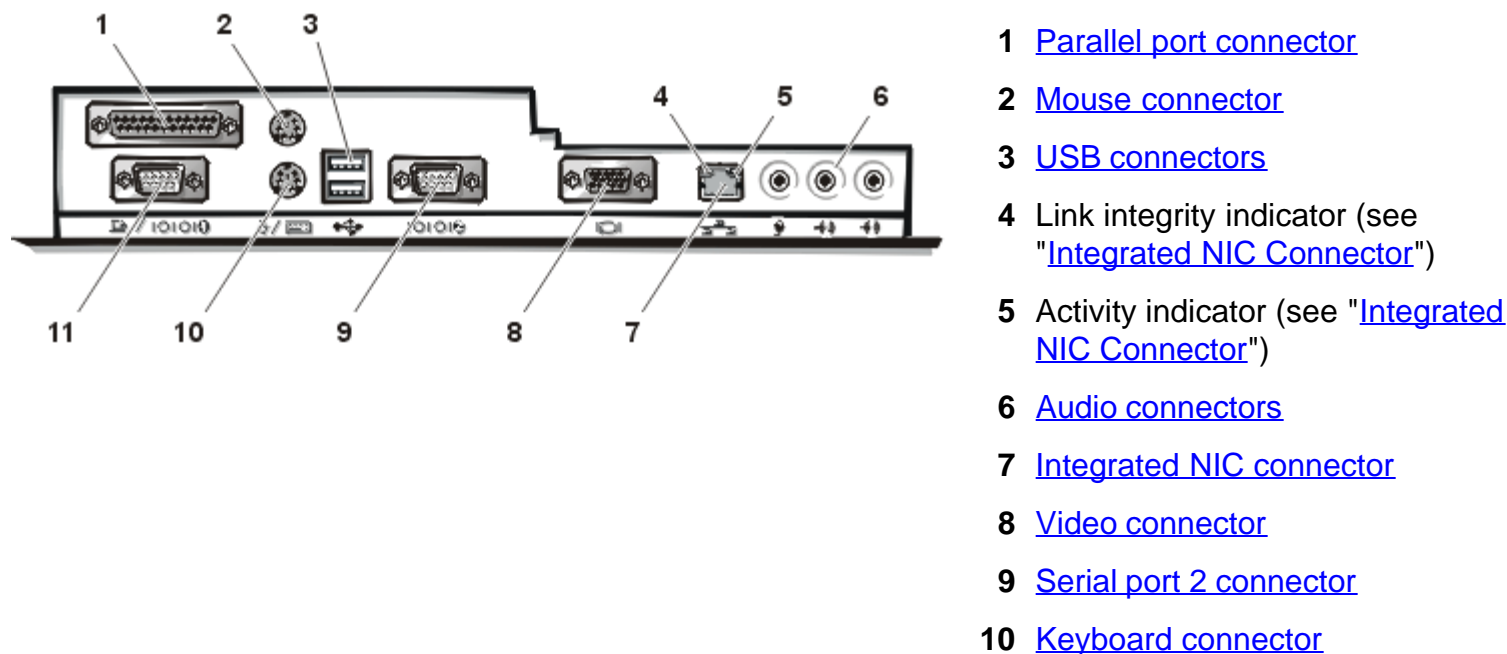

- 1 [Parallel port connector](#)
- 2 [Mouse connector](#)
- 3 [USB connectors](#)
- 4 Link integrity indicator (see "[Integrated NIC Connector](#)")
- 5 Activity indicator (see "[Integrated NIC Connector](#)")
- 6 [Audio connectors](#)
- 7 [Integrated NIC connector](#)
- 8 [Video connector](#)
- 9 [Serial port 2 connector](#)
- 10 [Keyboard connector](#)
- 11 [Keyboard connector](#)

When you connect external devices to your computer's back panel, follow these guidelines:

- Check the documentation that accompanied the device for specific installation and configuration instructions.

For example, you must connect most devices to a particular input/output (I/O) port or connector to operate properly. Also, external devices like a mouse or printer usually require you to load device drivers into system memory before they will work.

- Always attach external devices *while your computer is turned off*. Then turn on the computer *before* turning on any external devices, unless the documentation for the device specifies otherwise. (If the computer does not seem to recognize the device, try turning on the device before turning on the computer.)

NOTICE: When you disconnect external devices from the back of the computer, wait 5 seconds after turning off the computer before you disconnect any devices to avoid possible damage to the system board.

Parallel Port Connector

The integrated parallel port uses a 25-pin D-subminiature connector on the computer's back panel.

This I/O port sends data in parallel format (where eight data bits, or one byte, are sent simultaneously over eight separate lines in a single cable). The parallel port is used primarily for printers.

The default designation of your computer's integrated parallel port is LPT1. Port designations are used, for example, in software installation procedures to identify the port to which your printer is attached, thus telling your software where to send its output. (An incorrect designation prevents the printer from printing or causes scrambled print.)



NOTE: The integrated parallel port is automatically disabled if the system detects an installed expansion card containing a parallel port configured to the same address as specified in the [Parallel Port](#) option in the [System Setup program](#).

Mouse Connector

Your system uses a Personal System/2 (PS/2)-compatible mouse. The mouse cable attaches to a 6-pin miniature Deutsche Inductive Norm (DIN) connector on the back panel of your computer. Turn off the computer and any attached peripherals before connecting a mouse to the computer.

A PS/2-compatible mouse works as does an industry-standard serial mouse or bus mouse except that it has its own dedicated connector, which frees up the serial ports and does not require an expansion card. Mouse driver software gives the mouse priority with the microprocessor by issuing interrupt request (IRQ) 12 whenever a new mouse movement is made. The drivers also pass along the mouse data to the application that is in control.

USB Connectors

Your system contains two Universal Serial Bus (USB) connectors for attaching USB-compliant devices. USB-compliant devices are typically peripherals such as keyboards, mice, printers, and computer speakers.

If you reconfigure your hardware, you may need pin number and signal information for the USB connectors. Click one of the pins in the illustration for information on a particular signal.

Integrated NIC Connector

Your system has an integrated 10/100-megabit-per-second (Mbps) 3Com® Peripheral Component Interconnect (PCI) 3C905B-TX Ethernet network interface controller (NIC). The NIC provides all the functions of a separate network expansion card and supports both the 10BASE-T and 100BASE-TX Ethernet standards.

The NIC includes a Wakeup On LAN feature that enables the computer to be started by a special local area network (LAN) signal from a server management console. Wakeup On LAN provides remote computer setup, software downloading and installation, file updates, and asset tracking after hours and on weekends when LAN traffic is typically at a minimum.

The NIC connector on the computer's back panel has the following indicators:

- A yellow *activity indicator* flashes when the system is transmitting or receiving network data. (A high volume of network traffic may make this indicator appear to be in a steady "on" state.)
- A dual-colored *link integrity indicator*, which lights up green when there is a good connection between a 10-Mbps network and the NIC, or it lights up orange when there is a good connection between a 100-Mbps network and the NIC. When the green indicator is off, the computer is not detecting a physical connection to the network.

Audio Connectors

You can use the microphone jack to attach a standard personal computer microphone. Connect the audio cable from the microphone to the microphone jack. The microphone input is a monaural source with maximum signal levels of 89 millivolts root-mean-squared (mVrms).

You can use the line-out jack to attach most computer speakers. The line-out jack is amplified, so speakers with integrated amplifiers are not required. Connect the audio cable from the speakers to this jack.

You can use the line-in jack to attach record/playback devices such as cassette players, CD players, and VCRs. Connect the line-out cable from any of these devices to the line-in jack on the back of your computer.

Video Connector

The system uses a 15-pin high-density D-subminiature connector on the back panel for attaching a video graphics array (VGA)-compatible monitor to your system.

Serial Port Connectors

The serial ports use 9-pin D-subminiature connectors on the back panel. These ports support devices such as external modems or plotters that require serial transmission (sending one bit of data at a time over one line).

The default designations for these integrated serial ports are COM1 for serial port 1 and COM2 for serial port 2. Port designations are used in software installation procedures to identify the port used by a device—for example, specifying the port used by a modem when installing communications software.

The system contains a reconfiguration feature to reassign the serial port's designation if you add an expansion card containing a serial port using this designation.

If you set the system's integrated serial ports to **Auto** in the [System Setup program](#) and add an expansion card containing a serial port configured to a specific designation, the computer automatically maps (assigns) the integrated ports to the appropriate COM setting as necessary.

Before you add a card with a serial port, check the documentation that accompanied your software to make sure that the software can be mapped to the new COM port designation.

Keyboard Connector

Your system uses a PS/2-style keyboard. The keyboard cable attaches to a 6-pin miniature DIN connector on the back panel of your computer.

Network Cable Requirements

Your computer's NIC connector (an RJ45 connector located on the back panel) is designed for attaching an unshielded twisted pair (UTP) Ethernet cable. Press one end of the UTP cable into the NIC connector until the cable snaps securely into place.

Connect the other end of the cable to an RJ45 jack wall plate or to an RJ45 port on a UTP concentrator or hub, depending on your network configuration.

Controls and Indicators

Figure 2 shows the controls and indicators on the front panel of your computer.

Figure 2. Controls and Indicators

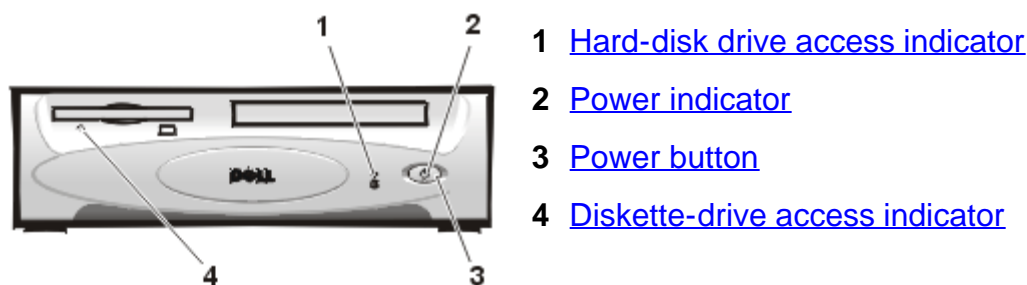

Hard-Disk Drive Access Indicator

The hard-disk drive access indicator lights up when a hard-disk drive is reading data from or writing data to the drive.

Power Indicator

The power indicator in the center of the power button lights up when the computer is receiving power. Use the power indicator to help you identify a system problem if the system does not boot when you press the power button to turn on the computer.

 **CAUTION:** Before you remove DIMMs, see "[Safety First—For You and Your Computer.](#)"

- A solid green power indicator and a beep code during power-on self-test (POST) indicate that a dual in-line memory module (DIMM) may be faulty or is not properly seated. [Remove all DIMMs](#), install only one DIMM, and then reboot. Repeat this procedure until you identify the faulty or improperly seated DIMM.
- A solid green power indicator and no beep code and no video during POST indicate that the monitor or the integrated video controller may be faulty. See "[Troubleshooting the Monitor.](#)" If the monitor is operating properly and is correctly connected, see "[Getting Help](#)" for instructions on getting technical assistance from Dell.
- A solid green power indicator and no beep code with video during POST indicate that an integrated system board device may be faulty. See "[Getting Help](#)" for instructions on getting technical assistance from Dell.

Power Button

The power button controls the system's AC input power.

The Microsoft® Windows® 98 and Windows 98 Second Edition (SE) operating systems let you configure the function of the power button through the Advanced Configuration and Power Interface (ACPI) feature (see Table 1).

NOTICE: To turn off your computer system, perform an orderly system shutdown using the operating system menu when possible.

Table 1. Power Button Behavior Under Microsoft Windows 98 and Windows 98 SE Operating Systems With ACPI

| Action | Results | | |
|----------------------------------|--------------------------------------------------------------------------------------|------------------------------|---------------------------|
| | System Turned On and ACPI Enabled | System in Standby Mode | System Turned Off |
| Press power button | System goes into standby mode or turns off (depending on the operating system setup) | System turns on | Boots and system turns on |
| Hold power button for 6 seconds* | System turns off immediately | System turns off immediately | Boots and system turns on |

* Pressing or holding the power button to shut down the system may result in data loss. Use the power button to shut down the system only if the operating system is not responding.

Microsoft Windows 95 does not support ACPI. Table 2 shows power button functions for Windows 95 operating systems and for Windows 98 operating systems that have the ACPI feature disabled.

Table 2. Power Button Behavior Under Microsoft Windows 95 and Windows 98 (With Dell AutoShutdown Loaded)

| Action | Results | | |
|----------------------------------|------------------------------|------------------------------|---------------------------|
| | System Turned On | System in Suspend Mode | System Turned Off |
| Press power button | System turns off | System turns off | Boots and system turns on |
| Hold power button for 6 seconds* | System turns off immediately | System turns off immediately | Boots and system turns on |

* Pressing or holding the power button to shut down the system may result in data loss. Use the power button to shut down the system only if the operating system is not responding.

Table 3 shows power button functions for Microsoft Windows NT® operating systems.

Table 3. Power Button Behavior Under Microsoft Windows NT (With Dell AutoShutdown Loaded)

| Action | Results | |
|----------------------------------|------------------------------|---------------------------|
| | System Turned On | System Turned Off |
| Press power button | System shuts down | Boots and system turns on |
| Hold power button for 6 seconds* | System turns off immediately | Boots and system turns on |

* Pressing or holding the power button to shut down the system may result in data loss. Use the power button to shut down the system only if the operating system is not responding.

If the system does not turn off when you press the power button, the system may be hung. Press and hold the power button until the system turns off completely (this process may take several seconds). Alternatively, press the reset button to reset the system and reboot. If the system is hung and both buttons fail to function properly, unplug the AC power cable from the computer, wait for it to completely stop running, plug in the AC power cable, and if the system does not restart, press the power button to restart the system.

Diskette-Drive Access Indicator

The diskette-drive access indicator lights up when the drive is reading data from or writing data to a diskette. Wait until the access indicator turns off before removing a diskette from the drive.

Chassis Intrusion

An integrated chassis intrusion alarm displays the status of the system chassis intrusion monitor. If the chassis has been opened, the setting changes to **Detected** and the following message is displayed during the boot sequence at system start-up:

Alert! Cover was previously removed.

Use the the [Chassis Intrusion](#) options in the [System Setup program](#) to reset the alarm so that future intrusions are detected.

Security Cable Slot and Padlock Ring

On the back of the computer are a security cable slot and padlock ring (see [Figure 3](#)) for attaching commercially available antitheft devices. (The padlock ring is recessed inside the cover.) Security cables for personal computers usually include a segment of galvanized cable with an attached locking device and key. To prevent unauthorized removal of your computer, loop the cable around an immovable object, insert the locking device into the security cable slot on the back of your computer, and lock the device with the key provided. Complete instructions for installing this kind of antitheft device are usually included with the device.



NOTE: Antitheft devices are of differing designs. Before purchasing such a device, make sure it works with the cable slot on your computer.

The padlock ring allows you to secure the computer cover to the chassis to prevent unauthorized access to the inside of the computer. To use the padlock ring, insert a commercially available padlock through the ring and then lock the padlock.

Figure 3. Security Cable Slot and Padlock Ring

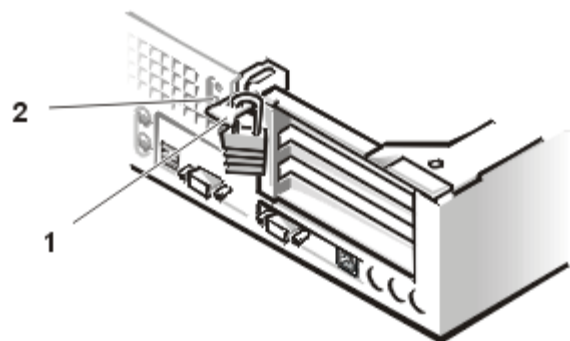

- 1 Padlock ring
- 2 Security cable slot

Using the System Password Feature

NOTICE: The password features provide a basic level of security for the data on your system. However, they are not foolproof. If your data requires more security, it is your responsibility to obtain and use additional forms of protection, such as data encryption programs.

Your Dell system is shipped to you without the system password feature enabled. If system security is a concern, operate your system only with system password protection.

You can assign a system password, as described in "[Assigning a System Password](#)," whenever you use the [System Setup program](#). After a system password is assigned, only those who know the password have full use of the system.

When the [System Password](#) option is set to **Enabled**, the computer system prompts you for the system password just after the system boots. See "[Using Your System Password to Secure Your System](#)" for more information.

To change an existing system password, you must know the password (see "[Deleting or Changing an](#)

[Existing System Password](#)"). If you assign and later forget a system password, you must remove the computer cover to change a jumper setting that disables the system password feature (see "[Disabling a Forgotten Password](#)"). Note that you erase the *setup password* at the same time.

NOTICE: If you leave your system running and unattended without having a system password assigned, or if you leave your computer unlocked so that someone can disable the password by changing a jumper setting, anyone can access the data stored on your hard-disk drive.

Assigning a System Password

Before you can assign a system password, you must enter the [System Setup program](#) and check the [System Password](#) option.

When a system password is assigned, the setting shown in [System Password](#) is **Enabled**. When the system password feature is disabled by a jumper setting on the system board, the setting shown is **Disabled by Jumper**. *You cannot change or enter a new system password if either of these options is displayed.*

When no system password is assigned and the password jumper on the system board is in the **Enabled** position (its default), the option shown for the [System Password](#) option is **Not Enabled**. *Only when [System Password](#) is set to **Not Enabled** can you assign a system password, using the following procedure:*

1. Verify that [Password Status](#) is set to **Unlocked**.
2. Highlight [System Password](#), and then press the left- or right-arrow key.

The option heading changes to **Enter Password**, followed by an empty 32-character field in square brackets.

3. Type your new system password.

You can use up to 32 characters in your password.

As you press each character key (or the spacebar for a blank space), a placeholder appears in the field. The password assignment operation recognizes keys by their location on the keyboard, without distinguishing between lowercase and uppercase characters. For example, if you have an *M* in your password, the system recognizes either *M* or *m* as correct.

Certain key combinations are not valid. If you enter one of these combinations, the speaker emits a beep.

To erase a character when entering your password, press the <Backspace> key or the left-arrow key.



NOTE: To escape from the field without assigning a system password, press the <Tab> key or the <Shift><Tab> key combination to move to another field, or press the <Esc> key at any time prior to completing step 5.

4. Press <Enter>.

If the new system password is less than 32 characters, the whole field fills with placeholders. Then the option heading changes to **Verify Password**, followed by another empty 32-character field in square brackets.

- To confirm your password, type it a second time and press <Enter>.

The password setting changes to **Enabled**. Your system password is now set; you can exit the System Setup program and begin using your system. Note, however, that password protection does not take effect until you reboot the system by pressing the reset button or by turning the system off and then on again.

Using Your System Password to Secure Your System

Whenever you either turn on your system or press the reset button, or when you reboot the system by pressing the <Ctrl><Alt> key combination, the following prompt appears on the screen when **Password Status** is set to **Unlocked**:

Type in the password and
 - press <ENTER> to leave password security enabled.
 - press <CTRL><ENTER> to disable password security.
 Enter password:

If **Password Status** is set to **Locked**, the following prompt appears:

Type the password and press <Enter>.

After you type the correct system password and press <Enter>, your system boots and you can use the keyboard and/or mouse to operate your system as usual.



NOTE: If you have assigned a setup password (see "[Using the Setup Password Feature](#)"), the system accepts your setup password as an alternate system password.

If you enter a wrong or incomplete system password, the following message appears on the screen:

```
** Incorrect password. **
```

Enter password:

If you again enter an incorrect or incomplete system password, the same message appears on the screen.

The third and subsequent times you enter an incorrect or incomplete system password, the system displays the following message:

```
** Incorrect password. **
Number of unsuccessful password attempts: 3
System halted! Must power down.
```

The number of unsuccessful attempts made to enter the correct system password can alert you to an unauthorized person attempting to use your system.

Even after your system is turned off and on, the previous message is displayed each time an incorrect or incomplete system password is entered.



NOTE: You can use **Password Status** in conjunction with **System Password** and **Setup Password** to further protect your system from unauthorized changes.

Deleting or Changing an Existing System Password

To delete or change an existing system password, perform the following steps:

1. Enter the [System Setup program](#), and verify that **Password Status** is set to **Unlocked**.
2. Reboot your system to force it to prompt you for a system password.
3. When prompted, type the system password.
4. Press <Ctrl><Enter> to disable the existing system password, instead of pressing <Enter> to continue with the normal operation of your system.
5. Confirm that **Not Enabled** is displayed for the [System Password](#) option of the System Setup program.

If **Not Enabled** appears in the **System Password** option, the system password has been deleted. If you want to assign a new password, continue to step 6. If **Not Enabled** is not displayed for the **System Password** option, press <Alt> to reboot the system, and then repeat steps 3 through 5.

6. To assign a new password, follow the procedure in "[Assigning a System Password](#)."

Using the Setup Password Feature

Your Dell system is shipped to you without the setup password feature enabled. If system security is a concern, you should operate your system with setup password protection.

You can assign a setup password, as described in "[Assigning a Setup Password](#)," whenever you use the System Setup program. After you assign a setup password, only those who know the password have full use of the System Setup program. See "[Operating Your System With A Setup Password Enabled](#)" for more information.

To change an existing setup password, you must know the setup password (see "[Deleting or Changing an Existing Setup Password](#)"). If you assign and later forget a setup password, you need to remove the computer cover to change a jumper setting that disables the setup password feature (see "[Disabling a Forgotten Password](#)"). Note that you erase the system password at the same time.

Assigning a Setup Password

You can assign a setup password only if **Setup Password** is set to **Not Enabled**. To assign a setup password, highlight **Setup Password** and press the left- or right-arrow key. The system prompts you to enter and verify the password. If a character is illegal for password use, the system emits a beep.



NOTES: The setup password can be the same as the system password.

If the two passwords are different, the setup password can be used as an alternate system password. However, the system password cannot be used in place of the setup password.

After you verify the password, the **Setup Password** setting changes to **Enabled**. The next time you enter the [System Setup](#) program, the system prompts you for the setup password.

A change to **Setup Password** becomes effective immediately (rebooting the system is not required).

Operating Your System With a Setup Password Enabled

If [Setup Password](#) is set to **Enabled**, you must enter the correct setup password before you can modify the majority of the System Setup options.

When you start the [System Setup program](#), the [System Setup screen](#) appears with **Setup Password** highlighted, prompting you to type the password.

If you do not enter the correct password in three tries, the system lets you view, but not modify, the System Setup screen—with the following exceptions:

- You can still modify the [Date](#), [Time](#), [CPU Speed](#), [Num Lock](#), and [Speaker](#) options.
- If [System Password](#) is not enabled and is not locked via the [Password Status](#) option, you can assign a system password (however, you cannot disable or change an existing system password).



NOTE: You can use [Password Status](#) in conjunction with **Setup Password** to protect the system password from unauthorized changes.

Deleting or Changing an Existing Setup Password

To delete or change an existing setup password, perform the following steps:

1. Enter the [System Setup program](#).
2. Highlight [Setup Password](#) and press the left- or right-arrow key to delete the existing setup password.
The setting changes to **Not Enabled**.
3. If you want to assign a new setup password, perform the steps in "[Assigning a Setup Password](#)."

Disabling a Forgotten Password

If you forget your system or setup password, you cannot operate your system or change settings in the [System Setup program](#) until you remove the computer cover, change the password jumper setting to disable the passwords, and erase the existing passwords.

To disable a forgotten password, perform the following steps.



CAUTION: Before you remove the computer cover, see "[Safety First—For You and Your Computer](#)."

1. Remove the computer cover according to the instructions in "[Removing and Replacing the Computer Cover](#)."
2. Remove the jumper plug from the PSWD jumper to disable the password feature.

Refer to "[System Board Jumpers](#)" for jumper information and to [Figure 4](#) in "Inside Your Computer" for the location of the password jumper (labeled "PSWD") on the system board.

3. Replace the computer cover.
4. Reconnect your computer and peripherals to an electrical outlet, and then turn them on.

Booting your system with the PSWD jumper plug removed erases the existing password(s).

5. Enter the System Setup program, and verify that the password is disabled. Proceed to step 6 if you want to assign a new password.



NOTE: Before you assign a new system and/or setup password, you must replace the PSWD jumper plug.



CAUTION: Before you remove the computer cover, see "[Safety First—For You and Your Computer](#)."

6. Remove the computer cover according to the instructions in "[Removing and Replacing the Computer Cover](#)."
7. Replace the PSWD jumper plug.
8. Replace the computer cover, and then reconnect the computer and peripherals to an electrical outlet and turn them on.

Booting your system with the PSWD jumper installed reenables the password feature. When you enter the [System Setup program](#), both password options appear as **Not Enabled**, meaning that the password feature is enabled but that no password has been assigned.

9. Assign a new system and/or setup password.

To assign a new system password, see "[Assigning a System Password](#)." To assign a new setup password, see "[Assigning a Setup Password](#)."

[Back to Contents Page](#)

[Back to Contents Page](#)

Using the System Setup Program: Dell™ OptiPlex™ GX1 Small-Form-Factor System User's Guide

- [Overview](#)
 - [Entering the System Setup Program](#)
 - [System Setup Screens](#)
 - [System Setup Navigation Keys](#)
 - [System Setup Options](#)
-

Overview

Each time you turn on your computer system or press the reset button, the system compares the hardware installed in the system to the hardware listed in the system configuration information stored in nonvolatile random-access memory (NVRAM) on the system board. If the system detects a discrepancy, it generates error messages that identify the incorrect configuration settings. The system then prompts you to enter the System Setup program to correct the setting.

You can use the System Setup program as follows:

- To change the system configuration information after you add, change, or remove any hardware in your system
- To set or change user-selectable options—for example, the time or date on your system

You can *view* the current settings at any time. When you *change* a setting, in many cases you must reboot the system before the change takes effect.

After you set up your system, run the System Setup program to familiarize yourself with your system configuration information and optional settings. Dell recommends that you print the [System Setup screens](#) (by pressing the <Print Screen> key) or write down the information for future reference.

Before you use the System Setup program, you need to know the kind of diskette drive(s) and hard-disk drive(s) installed in your computer. If you are unsure of any of this information, see the Manufacturing Test Report that was shipped with your system and is located in the **Dell Accessories** folder.

Entering the System Setup Program

To enter the System Setup program, perform the following steps:

1. Turn on your system.

If your system is already on, shut it down and then turn it on again.

2. Press <F2> immediately when the **F2 = Setup** prompt appears in the upper-right corner of the Dell

logo screen.

If you wait too long and your operating system begins to load into memory, *let the system complete the load operation*; then shut down the system and try again.

 **NOTE:** To ensure an orderly system shutdown, consult the documentation that accompanied your operating system.

You can also enter the System Setup program by responding to certain error messages. See "[Responding to Error Messages](#)."

System Setup Screens

The two System Setup screens, Page 1 and Page 2, display the current setup and configuration information and optional settings for your system. (Typical examples are illustrated in Figure 1.)

Figure 1. Typical Examples of System Setup Screens (Page 1 and Page 2)

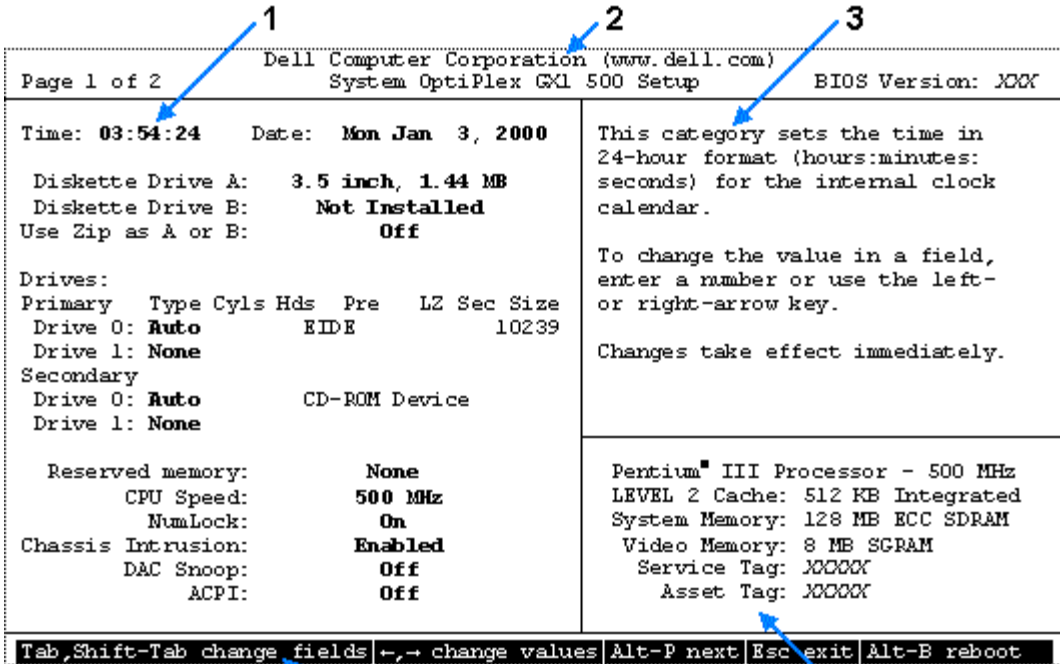

The screenshot displays the Dell System Setup program interface. It is titled "Dell Computer Corporation (www.dell.com) System OptiPlex GX1 500 Setup" and shows "Page 1 of 2" and "BIOS Version: X00X". The interface is divided into several sections:

- Configuration options (1):** Includes "Time: 03:54:24", "Date: Mon Jan 3, 2000", and "This category sets the time in 24-hour format (hours:minutes:seconds) for the internal clock calendar." It also provides instructions: "To change the value in a field, enter a number or use the left- or right-arrow key. Changes take effect immediately."
- Title box (2):** The top header area containing the system name and version.
- Help (3):** The right-hand side of the screen containing detailed instructions and system specifications.
- Key functions (4):** A footer bar with navigation instructions: "Tab, Shift-Tab change fields", "←, → change values", "Alt-P next", "Esc exit", and "Alt-E reboot".
- System data (5):** The bottom right section of the screen displaying hardware details: "Pentium® III Processor - 500 MHz", "LEVEL 2 Cache: 512 KB Integrated", "System Memory: 128 MB ECC SDRAM", "Video Memory: 8 MB SGRAM", "Service Tag: X000X", and "Asset Tag: X000X".

Other visible information includes diskette drive status (A: 3.5 inch, 1.44 MB; B: Not Installed), drive configurations (Primary and Secondary), and system settings like "Reserved memory: None", "CPU Speed: 500 MHz", "NumLock: On", "Chassis Intrusion: Enabled", "DAC Snoop: Off", and "ACPI: Off".

| Dell Computer Corporation (www.dell.com) | | BIOS Version: XXX |
|--------------------------------------------------------------------------------|-------------------------------|-------------------------------------------------------------------------------------------------------------------------------------------------------------------------------------------|
| Page 2 of 2 | System OptiPlex GX1 500 Setup | |
| Keyboard Errors: | Report | This category sets whether keyboard-related error messages are reported at system startup. |
| System Password: | Not Enabled | |
| Password Status: | Unlocked | |
| Boot Sequence: | Diskette First | |
| Setup Password: | Not Enabled | |
| Auto Power On: | Disabled 00:00 | |
| Power Management: | Disabled | |
| Wakeup on LAN: | On | |
| Integrated Devices | | |
| Sound: | On | |
| NIC: | On | |
| Mouse: | On | |
| Serial Port 1: | Auto | Pentium [®] III Processor - 500 MHz LEVEL 2 Cache: 512 KB Integrated System Memory: 128 MB ECC SDRAM Video Memory: 8 MB SGRAM Service Tag: XXXXX Asset Tag: XXXXX |
| Serial Port 2: | Auto | |
| Parallel Port: | 378h | |
| Parallel Mode: | PS/2 | |
| IDE Hard Disk: | Auto | |
| Diskette: | Auto | |
| Speaker: | On | |
| Tab,Shift-Tab change fields ←,→ change values Alt-P next Esc exit Alt-E reboot | | |

Information on the two System Setup screens is organized in five boxed areas:

- **Configuration options**

The box on the left half of both screens lists the options that define the installed hardware in your computer.

Fields beside the options contain settings; those that appear bright on the screen can be changed. Settings that you cannot change because they are determined by the system appear less bright.

Some options have multiple fields, which may show settings as bright or less bright depending on what options or values you entered in other fields.

- **Title box**

The box at the top of both screens lists the system name, page number (Page 1 or Page 2), and the revision number of the basic input/output system (BIOS).

- **Help**

The box on the upper-right half of both screens displays help information for the option with a currently highlighted field.

- **Key functions**

The line of boxes across the bottom of both screens lists keys and their functions within the System Setup program.

















- **System data**

The box in the lower-right corner of both screens displays information about your system.

System Setup Navigation Keys

Table 1 lists the keys you use to view or change information on the System Setup screens and to exit the program.

Table 1. System-Setup Navigation Keys

| Keys | Action |
|------------------------------------------------------------------------------------------------------------------------------------------------------------------------|-----------------------------------------------------------------------------------------------------------------------------------------------------------------------------------------------------------------------------------------------|
|  or  | Moves to the next field. |
|  or  | Moves to the previous field. |
|  or  | Cycles through the options in a field. In many fields, you can also type the appropriate value. |
|  or  | Scrolls through help information. |
|   | Switches between Page 1 and Page 2. |
|  | Exits the System Setup program without rebooting the system and returns the system to its previous state—the boot routine.* |
|   | Exits the System Setup program and reboots the system, implementing any changes you have made. |
|   | Resets the selected option to its default. |
|   | Enters the Device List screen when the Boot Devices menu option is set to Device List . See Table 2 in "System Setup Options" for more information on the keys you use in the Device List screen. |

*For most of the options, any changes you make are recorded but do not take effect until the next time you boot the system. For a few options (as noted in the help area), the changes take effect immediately.

System Setup Options

See [System Setup Options](#) for information.

[Back to Contents Page](#)

[Back to Contents Page](#)

Installing Upgrades: Dell™ OptiPlex™ GX1 Small-Form-Factor System User's Guide

- [Inside Your Computer](#)
 - [Expansion Cards](#)
 - [System Memory](#)
 - [Video Memory](#)
 - [Microprocessor](#)
 - [Battery](#)
 - [CD-ROM Drives](#)
 - [Hard-Disk Drives](#)
-

[Back to Contents Page](#)

[Back to Contents Page](#)

Troubleshooting: Dell™ OptiPlex™ GX1 Small-Form-Factor System User's Guide

-  [Basic Checks](#)
-  [Messages and Codes](#)
-  [Software Checks](#)
-  [Dell Diagnostics](#)
-  [External Components](#)
-  [Internal Components](#)
-  [Getting Help](#)

[Back to Contents Page](#)

[Back to Contents Page](#)

Specifications: Dell™ OptiPlex™ GX1 Small-Form-Factor System User's Guide

[Processor](#)[Memory](#)[System Information](#)[Video](#)[Audio](#)[Expansion Bus](#)[Drives](#)[Ports](#)[Key Combinations](#)[Controls and Indicators](#)[Power](#)[Physical](#)[Environmental](#)

Processor

| | |
|---------------------|---------------------------------------------------------------------------------------------|
| Microprocessor type | Intel® Pentium® II or Pentium III microprocessor |
| Internal cache | 32 kilobyte (KB) (16-KB data cache, 16-KB instruction cache) |
| L2 cache memory | 512-KB pipeline burst, 4-way set-associative, write-back static random-access memory (SRAM) |
| Math coprocessor | Internal to the microprocessor |

Memory

| | |
|------------------------------------------|---------------------------------------------------------------------------------------------------------------|
| Architecture | 64-bit (non-error checking and correction [ECC]) or 72-bit (ECC), noninterleaved, "PC100" 100 megahertz (MHz) |
| Dual inline memory module (DIMM) sockets | Three (gold contacts) |
| DIMM capacities | 32-, 64-, 128-, and 256-megabyte (MB) synchronous dynamic random-access memory (SDRAM) |
| System RAM | 32–768 MB |

Basic input/output system (BIOS) address F0000h

System Information

System chip set Intel 440BX PIIX4e

Data bus width 64 bits

Address bus width 32 bits

Direct memory access (DMA) channels Eight

Interrupts 15

System BIOS 2-megabit (Mb) flash chip

System clock 66 or 100 MHz (matches external bus speed)

Video

Video type Integrated ATI Rage Pro (AGP 2X) graphics

Video memory 4 MB standard (upgradable to 8 MB) synchronous graphics RAM (SGRAM)

Video resolutions 640 x 480; true-color (32 bits per pixel [bpp]); 85 hertz (Hz); 4 MB SGRAM
800 x 600; true-color (32 bpp); 85 Hz; 4 MB SGRAM
1024 x 768; true-color (32 bpp); 85 Hz;
4 MB SGRAM
1280 x 1024; true-color (32 bpp); 85 Hz;
8 MB SGRAM
1600 x 1200; 65,535 colors (16 bpp); 75 Hz;
8 MB SGRAM

Audio

Model Crystal Semiconductor

Chip set CS4236

Expansion Bus

Bus types Peripheral Component Interconnect (PCI)

Bus speed 33 MHz

Expansion-card connectors: Two PCI expansion slots (half-length PCI expansion cards only)

| | |
|-----------------------------------|----------|
| PCI expansion-card connector size | 120 pins |
|-----------------------------------|----------|

| | |
|---------------------------------------------------|---------|
| PCI expansion-card connector data width (maximum) | 32 bits |
|---------------------------------------------------|---------|

Drives

| | |
|----------------------------|---------------------------------------------------------------------------------------------------------------------------|
| Externally accessible bays | One 3.5-inch bay for a 3.5-inch diskette drive; one 5.25-inch bay for a removable media device (slim-height devices only) |
| Internally accessible bays | One bay for a 1-inch-high enhanced integrated drive electronics (EIDE) hard-disk drive |

Ports

Externally accessible:

| | |
|-----------------------------------------|------------------------------------------|
| Serial (data terminal equipment [DTE]) | Two 9-pin connectors; 16550-compatible |
| Parallel | 25-hole connector (bidirectional) |
| Video | 15-hole connector |
| Network interface controller (NIC) | RJ45 connector |
| Personal System/2 (PS/2)-style keyboard | 6-pin mini-Deutsche Industrie Norm (DIN) |

| | |
|---------------------------------------------------------|-----------------------------------|
| PS/2-compatible mouse | 6-pin mini-DIN |
| Universal Serial Bus (USB) | Two USB-compliant connectors |
| Audio line-in | Miniature audio jack |
| Audio line-out (amplified source) | Miniature audio jack |
| Microphone | Miniature audio jack |
| Internally accessible: | |
| Primary EIDE hard-disk drive | 40-pin connector on PCI local bus |
| Secondary EIDE hard-disk drive | 40-pin connector on PCI local bus |
| Diskette drive | 34-pin connector |
| ATI multimedia | 40-pin connector |
| Advanced Technology Attachment Packet Interface (ATAPI) | 4-pin connector |

Key Combinations

| | |
|------------------|-------------------------------|
| <Ctrl><Alt> | Restarts (reboots) the system |
|------------------|-------------------------------|

| | |
|-------------------------------|-------------------------------------------------------------------------------------------------------------------------------------------------------------------------------------------------------------|
| <Ctrl><Alt><\\> | Toggles microprocessor speeds on 101-key keyboard (in MS-DOS® real mode only) |
| <Ctrl><Alt><#> | Toggles microprocessor speeds on 102-key keyboard (in MS-DOS real mode only) |
| <F2> or <Ctrl><Alt><Enter> | Starts the System Setup program (during power-on system test [POST] only) |
| <F3> or <F12> | Automatically starts (boots) the system from the network environment specified by the Managed Boot Agent (MBA) rather than from one of the devices in the System Setup Boot Sequence option |
| <F10> | Launches the utility partition (if installed) during system start-up |

Controls and Indicators

| | |
|---------------------------------------------|-------------------------------------------------------------------------------------------------------------------------------------------------------|
| Reset control | No reset button on small-form-factor systems |
| Power control | Push button |
| Power indicators | Green light-emitting diode (LED) on riser board; blinking green in sleep state; dual-color LED on front panel—green for power, yellow for diagnostics |
| Hard-disk drive access indicator | Green LED |
| Link integrity indicator (on NIC connector) | Green LED for 10-Mb operation; orange LED for 100-Mb operation |
| Activity indicator (on NIC connector) | Yellow LED |

Power

DC power supply:

| | |
|------------------|-------------------------------------------------------------------------|
| Wattage | Small-form-factor chassis: 110 |
| Heat dissipation | Small-form-factor chassis: 808 British thermal units (BTU)/hr (nominal) |
| Voltage | 90 to 135 volts (V) at 60 Hz; 180 to 265 V at 50 Hz |
| Backup battery | 3-V CR2032 coin cell |

Physical

| | |
|--------|---------------------------------------|
| Height | 9.1 cm (3.6 inches) |
| Width | 31.8 cm (12.5 inches) |
| Depth | 37.8 cm (14.9 inches) |
| Weight | 6.6 kilograms (kg) (14.5 pounds [lb]) |

Environmental

Temperature:

Operating 10° to 35°Celsius (C) (50° to 95°Fahrenheit [F])

Storage -40° to 65°C (-40° to 149°F)

Relative humidity 20% to 80% (noncondensing)

Maximum vibration:

Operating 0.25 gravities (G) at 3 to 200 Hz at 1 octave/min

Storage 0.5 G at 3 to 200 Hz at 1 octave/min

Maximum shock:

Operating Bottom half-sine pulse with a change in velocity of 20 inches/sec (50.8 cm/sec)

Storage 27-G faired square wave with a velocity change of 200 inches/sec (508 cm/sec)

Altitude:

Operating -16 to 3048 meters (m)* (-50 to 10,000 feet [ft])

Storage -16 to 10,600 m (-50 to 35,000 ft)

* The maximum operating temperature of 35°C (95°F) is for altitudes below 914.6 m (3000 ft). Above 914.6 m the maximum operating temperature is reduced.

[Back to Contents Page](#)

[Back to Contents Page](#)

System Memory: Dell™ OptiPlex™ GX1 Small-Form-Factor System User's Guide

-  [Overview](#)
-  [Removing DIMMs](#)
-  [Installing DIMMs](#)

Overview

You can increase system memory up to 768 megabytes (MB) by using synchronous dynamic random-access memory (SDRAM) dual in-line memory modules (DIMMs). [Figure 3](#) in "Inside Your Computer" shows the location of the DIMM sockets on the system board.

When you add system memory, you may install DIMMs in any socket. For optimum operation, Dell recommends that you install a DIMM in socket A first (closest to the processor) before installing a DIMM in another socket.

Installing DIMMs

To upgrade memory, perform the following steps.

 **CAUTION:** To avoid the possibility of electric shock, turn off the computer and any peripherals, disconnect them from electrical outlets, and then wait at least 5 seconds before you remove the computer cover. Also, before removing the computer cover, see the other precautions in "[Safety First—For You and Your Computer.](#)"

1. [Remove the computer cover.](#)
2. If necessary, remove any DIMMs that occupy sockets in which you plan to install the upgrade DIMMs.
3. Install the upgrade DIMMs.
 - a. Locate the plastic securing clips at each end of the socket (see [Figure 1](#)).
 - b. Press the clips outward until they snap open.
 - c. Align the two slots on the bottom of the DIMM with the two ridges inside the socket.



NOTE: Make sure to insert the bottom of the DIMM into the socket. The bottom of the DIMM has two slots.

- d. Press the DIMM straight into the slot running down the center of the socket until the securing clips snap into place around the ends of the DIMM.



NOTE: Press the top center of the DIMM, and then press the top corners of the DIMM. This action firmly seats the DIMM in the socket, which allows the securing clips to snap into place around the end of the DIMM.

Figure 1. Installing a DIMM

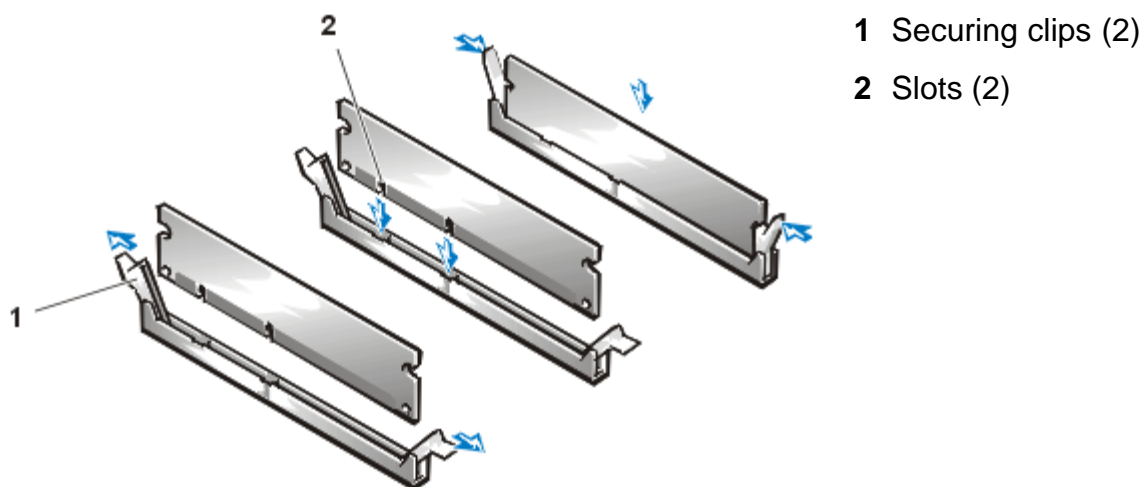

4. [Replace the computer cover](#), and reconnect your computer and peripherals to their electrical outlets and turn them on.



NOTE: If Enabled, the [Chassis Intrusion](#) option will cause the following message to be displayed at the next system start-up:

```
ALERT! Cover was previously removed.
```

The system detects that the new memory does not match the existing system configuration information and generates the following message:

```
The amount of system memory has changed.
Strike the F1 key to continue, F2 to run the setup utility
```

5. Press <F2> to enter the [System Setup program](#), and check the value for [System Memory](#).

The system should have already changed the value of **System Memory** to reflect the newly installed memory modules. Verify the new total. If it is correct, skip to step 7.

6. If the memory total is incorrect, turn off and disconnect your computer and peripherals from their electrical outlets. Remove the computer cover, and check the installed DIMMs to make sure that they are seated properly in their sockets. Then repeat steps 4 and 5.
7. When the **System Memory** total is correct, press <Esc> to exit the System Setup program.
8. Run the [Dell Diagnostics](#) to verify that the DIMMs are operating properly.

Removing DIMMs

To remove a DIMM, press the securing clips outward simultaneously until the DIMM disengages from the

socket (see Figure 2). It should pop out slightly.

Figure 2. Removing a DIMM

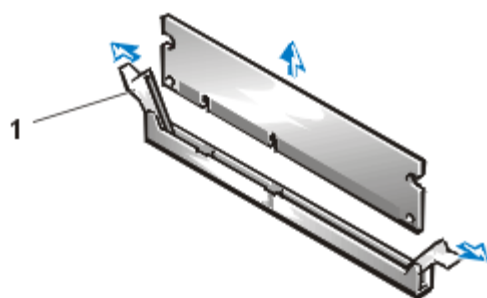

1 Securing clips (2)

[Back to Contents Page](#)

[Back to Contents Page](#)

Dell™ Diagnostics: Dell OptiPlex™ GX1 Small-Form-Factor System User's Guide

- [Overview](#)
- [Features of the Dell Diagnostics](#)
- [When to Use the Dell Diagnostics](#)
- [Before You Start Testing](#)
- [Starting the Dell Diagnostics](#)
- [How to Use the Dell Diagnostics](#)
- [Confirming the System Configuration Information](#)
- [How to Use the Menu](#)
- [Main Menu Categories](#)
- [Tests in the Dell Diagnostics](#)
- [Error Messages](#)

Overview

Unlike many diagnostic programs, the Dell Diagnostics helps you check your computer's hardware without any additional equipment and without destroying any data. By using the diagnostics, you can have confidence in your computer system's operation. And if you find a problem you cannot solve by yourself, the diagnostic tests can provide you with important information you will need when talking to Dell's service and support personnel.

NOTICE: Use the Dell Diagnostics to test *only* your Dell computer system. Using this program with other computers may cause incorrect computer responses or result in error messages.

Features of the Dell Diagnostics

The Dell Diagnostics provides a series of menus and options from which you choose particular test groups or subtests. You can also control the sequence in which the tests are run. The diagnostic test groups or subtests also have these helpful features:

- Options that let you run tests individually or collectively
- An option that allows you to choose the number of times a test group or subtest is repeated
- The ability to display or print out test results, or to save them in a file
- Options to temporarily suspend testing if an error is detected, or to terminate testing when an adjustable error limit is reached
- A menu category called Devices that briefly describes each test and its parameters
- A menu category called Config that describes the configuration of the devices in the selected device

group

- Status messages that inform you whether test groups or subtests were completed successfully
 - Error messages that appear if any problems are detected
-

When to Use the Dell Diagnostics

Whenever a major component or device in your computer system does not function properly, you may have a component failure. As long as the microprocessor and the input and output components of your computer system (the monitor, keyboard, and diskette drive) are working, you can use the Dell Diagnostics. If you are experienced with computers and know what component(s) you need to test, simply select the appropriate diagnostic test group(s) or subtest(s). If you are unsure about how to begin diagnosing a problem, read the rest of this section.

Before You Start Testing

Turn on your printer if one is attached, and make sure it is online. Also, you must create a copy of the Dell Diagnostics on diskette.

1. Enter the [System Setup program](#) by restarting the computer and pressing <F2> when prompted.
2. Confirm that all ports are enabled, and make sure that the [Boot Sequence](#) option is set to **CD-ROM First**.
3. Place the *Dell ResourceCD* in the CD-ROM drive, and press <Alt> to restart the system.
4. At the prompt, select the option to run the Dell Diagnostics.
5. Insert a blank diskette in drive A.



NOTE: Make sure that there is no data on the diskette that you want to keep. The diskette creation process will destroy any data on the diskette.

6. At the prompt, select the option for the 16-bit Dell Diagnostics, and type *y* to continue.

The Dell Diagnostics diskette is created from the *Dell ResourceCD*.

7. Restart the computer, enter the [System Setup program](#), change the [Boot Sequence](#) option to **Diskette First**, and press <Alt> to reboot the system.

Your computer boots from the Dell Diagnostics diskette in drive A, and the Dell Diagnostics automatically loads.



NOTE: At your first opportunity, make a working copy of the Dell Diagnostics diskette. Refer to your operating system's documentation for information on how to duplicate diskettes. Label both diskettes as "Dell Diagnostics diskette," and put the original diskette away for safekeeping.

Starting the Dell Diagnostics

Perform the following steps to start the diagnostics:

1. Turn on the system.
2. Enter the [System Setup program](#) by restarting the computer and pressing <F2> when prompted.
3. Confirm that all ports are enabled. Also, make sure that the [Boot Sequence](#) option is set to **Diskette First**.
4. Place your Dell Diagnostics diskette in the diskette drive, and press <Alt> to restart the system.
5. At the MS-DOS® prompt, type `delldiag` and press <Enter>.



NOTE: Before you read the rest of this section, you may want to start the Dell Diagnostics so that you can see it on the screen of your monitor.

When you start the diagnostics, the Dell logo screen appears, followed by a message telling you that the diagnostics is loading.

After the diagnostics loads, the **Diagnostics Menu** appears (see [Figure 1](#)). The menu allows you to run all or specific diagnostic tests or to exit to the MS-DOS prompt.

For a quick check of your system, select the **Run Quick Tests** option. This option runs only the subtests that do not require user interaction and that do not take a long time to run. Dell recommends that you choose this option first to increase the odds of tracing the source of the problem quickly. For a thorough check of your system, select the **Run All Tests** option. To check a particular area of your system, select the **Run Specific Tests** option.

To select an option from this menu, highlight the option and press <Enter>, or press the key that corresponds to the highlighted letter in the option you choose.

Figure 1. Diagnostics Menu

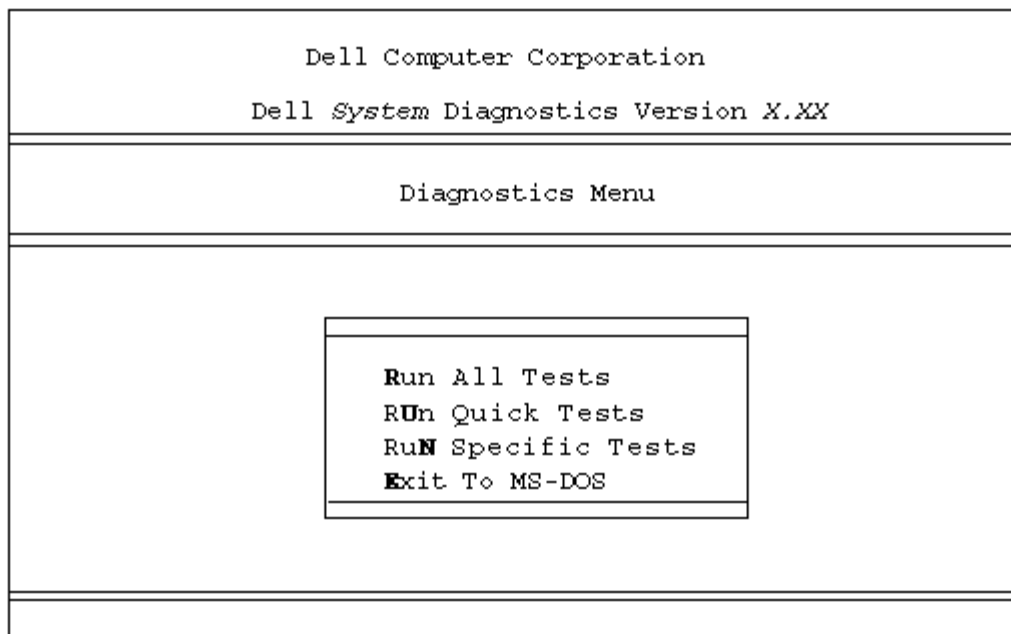

How to Use the Dell Diagnostics

When you select **Run Specific Tests** from the **Diagnostics Menu**, the main screen of the diagnostics appears (see [Figure 2](#)). The main screen lists the diagnostic test groups, gives information about the configuration of your computer system, and allows you to select categories from a menu. From this screen, you can enter two other types of screens.

Information on the main screen of the diagnostics is presented in the following five areas:

- Two lines at the top of the screen identify the version number of the Dell Diagnostics.
- On the left side of the screen, the **Available Test Group** area lists the diagnostic test groups in the order they will run if you select **All** from the **Run** menu category. Press the up- or down-arrow key to highlight a test group.
- On the right side of the screen, the **System Configuration** area lists the computer's currently detected hardware and some of the relevant settings.
- The lower-right side of the screen displays information about your integrated drive electronics (IDE) hard-disk and CD-ROM drive(s).
- Two lines at the bottom of the screen make up the menu area. The first line lists the categories you can select; press the left- or right-arrow key to highlight a menu category. The second line gives information about the category currently highlighted.

Figure 2. Dell Diagnostics Screen

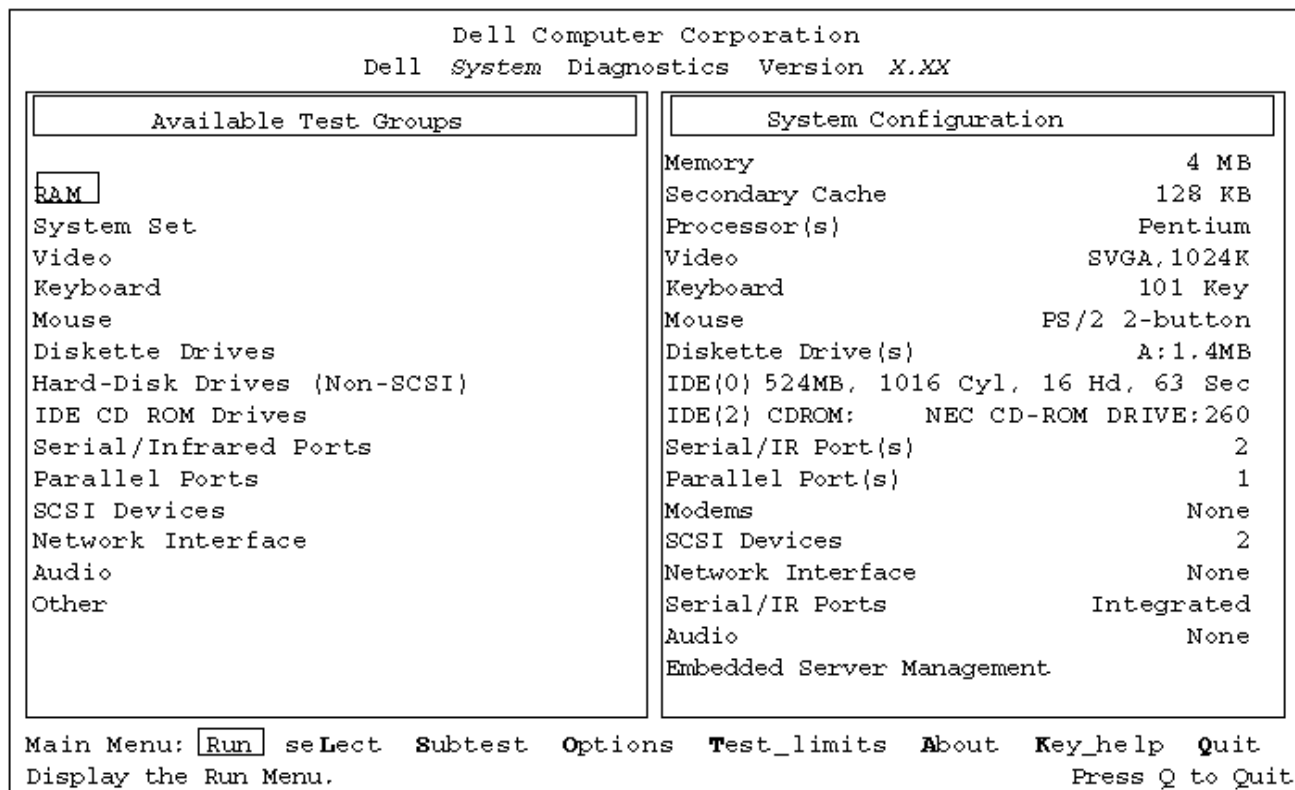

Confirming the System Configuration Information

When you boot your system from the *Dell ResourceCD*, the diagnostics checks your system configuration information and displays it in the **System Configuration** area on the main screen.

The following sources supply this configuration information for the diagnostics:

- The system configuration information settings (stored in nonvolatile random-access memory [NVRAM]) that you selected while using the [System Setup program](#)
- Identification tests of the microprocessor, the video controller, the keyboard controller, and other key components
- Basic input/output system (BIOS) configuration information temporarily saved in RAM

Do not be concerned if the **System Configuration** area does not list the names of all the components or devices you know are part of your computer system. For example, you may not see a printer listed, although you know one is attached to your computer. Instead, the printer is listed as a parallel port. The computer recognizes the parallel port as LPT1, which is an address that tells the computer where to send outgoing information and where to look for incoming information. Because your printer is a parallel communications device, the computer recognizes the printer by its LPT1 address and identifies it as a parallel port.

How to Use the Menu

One of the menu categories is already highlighted. You can move the highlight from one category to another by pressing the left- or right-arrow key. As you move from one menu category to another, a brief explanation of the currently highlighted category appears on the bottom line of the screen.

If you want more information about a test group or subtest, move the highlight to the **About** option and press <Enter>. After reading the information, press the <Esc> key to return to the previous screen.

Main Menu Categories

Eight categories are listed in the **Main** menu of the diagnostics main screen: [Run](#), [Select](#), [Subtest](#), [Options](#), [Test Limits](#), [About](#), [Key-Help](#), and [Quit](#).



*NOTE: Before running any test groups or subtests (by selecting **Run**), you should consider setting global parameters within the **Options** category. They offer you greater control over how the test groups or subtests are run and how their results are reported.*

There are two ways to select a menu category:

- Look on the screen to see which letter in the category is capitalized, and type that letter (for example, type **r** to select the **Run** category).
- Move the highlight to the category you wish to select by pressing the left- or right-arrow key, and then press <Enter>.

Whenever one of the eight categories is selected, additional choices become available.

The following subsections explain the menu categories as listed from left to right in the **Main** menu.

Run

Run displays five categories: **One**, **Selected**, **All**, **Key-Help**, and **Quit Menu**. If you select **One**, all the subtests within the highlighted test group are run. If you choose **Selected**, only the selected test groups or the subtests that you selected within the test groups are run. If you select **All**, all of the subtests in all of the test groups are run. (The test groups or subtests are run in the same order as they are listed.)

The **Key-Help** category displays a list of key controls available for the particular category you have chosen.

The **Quit Menu** category returns you to the **Main** menu.

Select

Select allows you to select individual test groups to tailor the testing process to your particular needs. You can choose one or more test groups and run them sequentially or individually. When you choose **Select**, five categories are displayed: **All**, **One**, **Clear All**, **Key-Help**, and **Quit Menu**.

To select all the test groups, press <Enter> when **All** is highlighted in the **Select** menu.

To select an individual test group, highlight the test group and press the spacebar or highlight **One** and press <Enter>. Press the up- or down-arrow key to change the highlighted test group.

To reverse a test group selection, highlight the test group and press the spacebar. To clear all selections, select **Clear All**.

The **Key-Help** category displays a list of key controls available for the particular category you have chosen. The **Quit Menu** category returns you to the [Main](#) menu.

Subtest

Most of the test groups consist of several subtests. Use the **Subtest** category to select individual subtests within the test group(s).

When you select **Subtest**, many of the same categories as those on the [Main](#) menu are displayed: [Run](#), [Select](#), [Options](#), [Test Limits](#), [About](#), [Key-Help](#), and [Quit Menu](#). Each of these categories is explained in the following subsections.

- **Run Under Subtest**

Run in the **Subtest** menu displays five categories: **One**, **Selected**, **All**, **Key-Help**, and **Quit Menu**. If you select **One**, only the highlighted subtest is run. If you select **Selected**, only the selected subtests are run. If you select **All**, all of the subtests listed on the screen are run. (The subtests are run in the same order as they are listed.)

The **Key-Help** category displays a list of key controls available. The **Quit Menu** category returns you to the previous menu.

- **Select Under Subtest**

Select in the **Subtest** menu allows you to select individual subtests to tailor the testing process to your particular needs. You can choose one or more subtests from the list. When you choose **Select**, five categories are displayed: **All**, **One**, **Clear All**, **Key-Help**, and **Quit Menu**.

To select all the subtests, press <Enter> when **All** is highlighted in the **Select** menu. To select an individual subtest, highlight the subtest and press the spacebar or highlight **One** and press <Enter>. Press the up- or down-arrow key to highlight a subtest to be selected.

To reverse a subtest selection, highlight the subtest and press the spacebar. To clear all selections, select **Clear All**.

The **Key-Help** category displays a list of key controls available. The **Quit Menu** category returns you to the previous menu.

- **Options Under Subtest**

The **Options** category in the **Subtest** menu functions the same way as the **Options** category in the [Main](#) menu. For information on this category, see "[Options](#)."

- **Test Limits Under Subtest**

The **Test Limits** category in the **Subtest** menu functions the same way as the **Test Limits** category in the [Main](#) menu. For information on this category, see "[Test Limits](#)."

- **About Under Subtest**

The **About** category in the **Subtest** menu displays information about the highlighted subtest.

- **Key-Help Under Subtest**

The **Key-Help** category in the **Subtest** menu displays a list of key controls available.

- **Quit Menu Under Subtest**

The **Quit Menu** category in the **Subtest** menu returns you to the [Main](#) menu.

Options

Table 1 lists all of the possible values for each global parameter of Options. A brief description of each parameter follows the table. To change **Options** parameters, press the spacebar, the left- and right- arrow keys, or the plus (+) and minus (-) keys.

Table 1. Option Parameters

| Option Limit | Possible Values |
|------------------------------------------|--------------------------------------------------------------------------------------------------------------------------------------------------------------------------------------------------------------------------------------------------------------------------------------------------------------------------------------------------------------------------------------------------------------------------------------------------------------------------------------------------------------------------------------------------------------------------|
| Number of Times to Repeat Test(s) | 0001 through 9999 , or 0000 , which loops indefinitely until you press the <Ctrl> and <Break> keys. The default is 1 . |
| Maximum Errors Allowed | 0000 through 9999 , where 0000 means that there is no error limit. The default is 1 . |
| Pause For User Response | Yes, No Allows you to decide whether tests will wait for user input. The default is Yes to wait for user input. |
| Output Device for Status Messages | Display, Printer, File If you have a printer attached to your computer, you can use it to print the status messages, if any, that are generated when a test runs. (The printer must be turned on and in the online mode to print.) If you select File , the messages are printed to a file named result on a diskette that you insert into drive A when prompted. If you are running the diagnostics from a utility partition on your hard-disk drive, the result file is created on the hard-disk drive. The default is Display . |
| Output Device for Error Messages | Display, Printer, File This parameter has the same effect as the Output Device for Status Messages parameter, except that it pertains only to error messages. The default is Display . |

- **Number of Times to Repeat Test(s)**

This parameter specifies the number of times the tests run when you select Run. To change the default, type in the desired value. If you type 0 (zero), the tests will run indefinitely.

- **Maximum Errors Allowed**

This parameter specifies the maximum number of errors that can occur before testing is stopped. The error count begins from zero each time you run a subtest or test group individually or each time you select All to run all of them. To change the default, type in the desired value. If you type 0 (zero), you

are specifying that there be no limit on the number of errors that can occur—testing will not be stopped, regardless of the number of errors.

• **Pause for User Response**

If this parameter value is set to **Yes**, the diagnostics pauses when one of the following occurs:

- Your interaction is needed to verify the [Video Test Group](#) screens or the [Keyboard Test Group](#) key functions or other types of interaction such as inserting a diskette.
- The maximum error limit is reached.

If the **Pause** parameter is set to **No**, the diagnostics ignores some subtests that require your interaction; certain subtests can run only if this option is set to **Yes** because they require user interaction. Use the **Pause** parameter in situations where you may want to prevent subtests that require user interaction from running—such as when you run the diagnostics overnight.

• **Output Device for Status Messages**

Ordinarily, all status messages appear only on the screen. This parameter allows you to direct status messages to either a printer or a file, in addition to the screen. If you choose the **File** option, status messages are written to a file named **result**. This file is automatically created on a diskette that you insert into drive A when prompted. If you are running the diagnostics from a utility partition on your hard-disk drive, the **result** file is created on the hard-disk drive. If the **result** file already exists, new status messages are added to it.

The **result** file is an ordinary American Standard Code for Information Interchange (ASCII) text file that you can open in any text viewer or word processor. You can also access the **result** file with the MS-DOS type command as follows:

1. Select **Quit** to exit the diagnostics and return to the operating system prompt.
2. At the operating system prompt, type the appropriate command and press <Enter>:

```
type result
```

The contents of the file appear on the screen.

After running particular diagnostic tests and viewing the status messages generated by the tests in the **result** file, you can erase the contents of the file so that it is clear for the next set of messages generated. Otherwise, the next messages are added at the end of the previous ones in the file.

• **Output Device for Error Messages**

Ordinarily, all error messages appear only on the screen. This parameter allows you to direct error messages to either a printer or a file, in addition to the screen. If you choose the **File** option, error messages are written to the **result** file used for status messages. This file is automatically created on a diskette that you insert into drive A when prompted. If you are running the diagnostics from a utility partition on your hard-disk drive, the **result** file is created on the hard-disk drive. If the **result** file already exists, new error messages are added to it.

The **result** file is an ordinary ASCII text file. You can access and review the **result** file as described in

the previous subsection, "[Output Device for Status Messages](#)."

After running particular diagnostic tests and viewing the error messages generated by the tests in the **result** file, you can erase the contents of the file so that it is clear for the next set of messages generated. Otherwise, the next messages are added at the end of the previous ones in the file.

Test Limits



NOTE: The Dell Diagnostics sets default limits on all tests. The only reason to change the default would be to limit the amount of testing done.

The [RAM Test Group](#), the [Video Test Group](#), the [Diskette Drives Test Group](#), the [IDE \(ATA/ATAPI\) Devices Test Group](#), the [Serial/Infrared Ports Test Group](#), the [Parallel Ports Test Group](#), and the [SCSI Devices Test Group](#) allow you to designate limits. Whether you select **Test Limits** for a highlighted test group (from the [Main](#) menu) or a subtest (from the [Subtest](#) menu), you set the limits for all the subtests in that test group. When you select **Test Limits**, a new screen appears and the **Key-Help** area lists keys to use with the new screen. Press <Page Down> to select the next menu or submenu. Press <Esc> to return to the main **Test Limits** window.

How you change a value for the limits of a test group or subtest depends on the type of parameter associated with it. Different keys are used to change values for different types of parameters. For example, memory address limits specified for the [RAM Test Group](#) are changed by typing in numbers over the digits of a given limit or by pressing the plus (+) or minus (-) keys to increase or decrease the given limit. In contrast, to set limits for the [Serial/Infrared Ports Test Group](#), you use the spacebar to toggle between **Yes** and **No**.

After you are satisfied with the limits, return to the Dell Diagnostics main screen by pressing <Esc>. The values you selected under **Test Limits** remain in effect during all the test groups or subtests you run, unless you change them. However, the values are reset to their defaults when you restart the diagnostics.

About

About in the [Main](#) menu lists all of the subtests for the selected test group and displays information about the subtest that is highlighted.

Key-Help

Key-Help always displays a list of key controls available for the particular category you have selected.

Quit

Selecting **Quit** from the [Main](#) menu exits the diagnostics and returns you to your operating system environment.

After you return to the operating system environment, remove your diagnostics diskette from drive A and reboot the computer.

NOTICE: It is important that you quit the diagnostics correctly because the program writes data to the computer's memory that can cause problems unless properly cleared.

Tests in the Dell Diagnostics

To troubleshoot components or devices, run the appropriate test (test group or subtest) in the diagnostics on your diagnostics diskette. The diagnostics exercises the functional components and devices of your computer system more vigorously and thoroughly than they are exercised during normal operation. The diagnostics is organized by components into test groups and subtests within each test group. Each subtest is designed to detect any errors that may interfere with the normal operation of a specific device of the computer.



NOTE: Some subtests requiring hardware not listed in the **System Configuration** area of the diagnostics screen appear to run, but they conclude with a status message stating **Component not present (or disabled)**.

The diagnostic test groups, their subtests, and comments concerning their use are listed in Table 2.

Table 2. Dell Diagnostic Test Groups and Subtests

| Test Group | Subtest | Comment |
|----------------------------|----------------------------------------------------------------------------------------------------------------------------------------------------------------------------------------------------------------------------------------------------------------------------------------------------------------------------|------------------------------------------------------------------------------------------------------------------------------------------------------------|
| RAM | Quick Memory Test Comprehensive Memory Test Secondary Cache Memory Test | Tests the RAM and cache. (Some computers include expanded or extended memory; all memory is tested.) |
| System Set | CMOS Confidence Test CMEM Confidence Test DMA Controller Test Real-Time Clock Test System Timers Test Interrupt Controller Test Reset Button Test System Speaker Test | Tests the system board's support chips, DMA controller, computer timer, NVRAM, speaker controller, cache, and EISA configuration RAM chip, as appropriate. |
| | Coprocesor Calculation Test Coprocesor Error Exception Test | Tests the math coprocessor that is internal to the microprocessor. |
| | PC Card Controller Test | Tests the PC Card controller on the system board. |
| | Thermal Control Test | Checks the functionality of the thermal-monitoring and microprocessor speed-switching device on the system board. |
| | Multiprocessor Test | For systems with multiprocessors, confirms that the secondary microprocessor is operational. |
| | USB Register Test | Checks the onboard registers of the USB interface. This subtest does not test USB peripherals. |
| | USB Memory Structure Test | Monitors the ability of a USB controller to process a simple set of memory- |

| | | |
|-----------------------------------------|--------------------------------------------------------------------------------------------------------------------------------------------------------------------------------------------------------------------------------------------------------------------------------------------------------------------------------------------------------------------------------------|---------------------------------------------------------------------------------------------------------------------------------------------------------------------------------------------|
| | | resident instructions. |
| Video | Video Memory Test Video Hardware Test Text Mode Character Test Text Mode Color Test Text Mode Pages Test Graphics Mode Test Color Palettes Test Solid Colors Test | Tests the video subsystem and monitor by checking various aspects of video output. |
| Keyboard | Keyboard Controller Test Keyboard Key Sequence Test Keyboard Interactive Test Stuck Key Test External Key Pad Test | Tests the keyboard by checking the keyboard controller and by finding keys that stick or respond incorrectly. |
| Mouse | Mouse | Tests the electronic pointing device (bus mouse, serial mouse, trackball, or PS/2 mouse). |
| Diskette Drives | Change Line Test Seek Test Read Test Write Test | Tests a drive that uses removable diskettes (3.5-inch or 5.25-inch). Also tests the associated interface. |
| IDE (ATA/ATAPI) Devices | Display Information Confidence Test Self Diagnostics Test Seek Test Read Test Verify Test Write Test SMART Test CD-ROM Audio Test Media Eject Test Tape Retension Test | Tests drives connected to the system IDE bus, including hard-disk drives and removable media drives such as CD-ROM and tape drives. |
| Serial/Infrared Ports | Serial/Infrared Baud Rate Test Serial/Infrared Interrupt Test Serial/Infrared Internal Transmission Test Serial External Transmission Test | Tests the components through which peripherals that use the serial or infrared ports, such as printers and communications devices, send and receive data. |
| Parallel Ports | Parallel Internal Test Parallel External Loopback Test Parallel External Interrupt Test Parallel Printer Pattern Test | Tests the components through which peripherals that use the parallel port, such as printers and communications devices, send and receive data. |
| SCSI Devices | Internal Diagnostic Seek Test Read Test Write Test Audio Output Test | Tests any installed SCSI host adapters and all the SCSI devices attached to them. Also can be used to remove CDs and tape cartridges from SCSI devices and to display information about the |

| | | |
|----------------------------------------|---------------------------------------------------------------------------------------------------------------------------------------------------------------------------------------------------------------------------------------------------------------------------------------------------------|--------------------------------------------------------------------------------------------------------------------------------------------------------------|
| | Eject Removable Media Display Information | types of SCSI devices installed and the resources allocated to them. |
| Network Interface | Registers Test Internal Loopback Test External Loopback Test Shared RAM Test Display Information | Tests the read and write access capability to the NIC registers. Also tests the ability of the NIC to transmit and receive data. |
| Audio | Software Reset Test Compatibility ID Test Interrupt Test DMA Test FIFO RAM Test Initial Reset Status Test Internal Register Test Dual Channel Test | Tests the operation of the audio chip set. |
| | FM Sound Playback Test Analog Sound Playback Test Record and Playback Test | Tests the record and playback ability of the internal microphone and speakers. |
| System Management BIOS | BIOS Information Environment Information I/O Information Memory Information Processor Information System Information | Tests the state of various system devices, such as the temperature of the processor. Also displays system management information for various system devices. |

RAM Test Group

The **RAM Test Group** subtests check all the directly addressable RAM.

The **RAM Test Group** program has parameters for the subtests that you can set: **Test Limits** and **Options**.

Three subtests are available for RAM: the **Quick Memory Test**, the **Comprehensive Memory Test**, and the **Secondary Cache Memory Test**. The **Quick Memory Test** performs an address check to determine whether the computer is properly setting and clearing individual bits in RAM and whether the RAM read and write operations are affecting more than one memory address location at one time. This subtest checks all available RAM. The **Comprehensive Memory Test** also performs an address check, as well as the following:

- Data pattern checks, to look for RAM bits that are stuck high or low, short-circuited data lines, and some data pattern problems that are internal to the memory chips
- A parity check that verifies the ability of the memory subsystem to detect errors
- A refresh check, to verify that the dynamic RAM (DRAM) is being recharged properly

The **Secondary Cache Memory Test** confirms the functionality of the computer's cache controller chip and the cache memory.

Why Run a RAM Test?

Faulty memory can cause a variety of problems that may not, at first glance, appear to be happening in RAM. If your computer is displaying one or more of the following symptoms, run the subtests in the **RAM Test Group** to verify that the memory is not at fault:

- A program is not running as usual, or a proven piece of software appears to malfunction and you confirm that the software itself is not at fault. (You can confirm that the software is functioning properly by moving it to another computer and running it there.)
- Your computer periodically locks up (becomes unusable and must be rebooted), especially at different places and times in different programs.
- You get parity errors (any error message that contains the word parity) at any time during operation. These errors are usually accompanied by a reference to an address—the location of the portion of memory where the error occurred—which you should record on a copy of the [Diagnostics Checklist](#).

System Set Test Group

The subtests in the **System Set Test Group** check the computer's basic system board components and verify their related functions.

The subtests that constitute the **System Set Test Group** and the computer functions they confirm follow:

- **CMOS Confidence Test**

Checks the NVRAM for accessibility and reliability of data storage by performing a data pattern check and verifying the uniqueness of memory addresses.

- **CMEM Confidence Test**

Verifies the accessibility and reliability of the 8 kilobytes (KB) of RAM on the Extended Industry-Standard Architecture (EISA) Configuration RAM chip, which stores the EISA hardware configuration information. On systems without flash RAM, performs a data pattern and address uniqueness test.



NOTE: This test applies only to systems with an EISA bus.

- **DMA Controller Test**

Tests the direct memory access (DMA) controller and verifies the correct operation of its page and channel registers by writing patterns to the registers.

- **Real-Time Clock Test**

Confirms the functionality and accuracy of the computer's real-time clock (RTC).

- **System Timers Test**

Checks the timers used by the microprocessor for event counting, frequency generation, and other functions. Only the functions that can be activated by software are tested.

Interrupt Controller Test

Generates an interrupt on each interrupt request (IRQ) line to verify that devices using that line can communicate with the microprocessor and that the interrupt controllers send the correct memory addresses to the microprocessor.

- **Reset Button Test**

Confirms that the reset button works.

- **System Speaker Test**

Checks the functionality of the speaker by generating eight tones.

- **Coprocessor Calculation Test**

Checks the use of different types of numbers and the math coprocessor's ability to calculate correctly.

- **Coprocessor Error Exception Test**

Verifies the math coprocessor's ability to handle errors and to send IRQs to the microprocessor.

- **PC Card Controller Test**

Tests the functionality of the PC Card controller on the system board.

- **Thermal Control Test**

Checks the functionality of the thermal-monitoring and microprocessor speed-switching device on the system board.

- **Multiprocessor Test**

For systems with multiprocessors, confirms that the secondary microprocessor is operational.

- **USB Register Test**

Checks the onboard registers of the Universal Serial Bus (USB) interface. This subtest does not test USB peripherals.

- **USB Memory Structure Test**

Monitors the ability of a USB controller to process a simple set of memory-resident instructions.

Why Run a System Set Test?

The **System Set** subtests double-check many system board components, such as the computer's input/output (I/O) circuitry, that are tested by other test groups or subtests in the diagnostics. You should run the **System Set Test Group** if you are having a problem and cannot isolate the failure or malfunction to a particular system board component.

The **System Set Test Group** also verifies the proper operation of other computer components, such as the speaker, that are not tested elsewhere in the Dell Diagnostics.

The following symptoms usually suggest a problem with a component or subassembly that warrants running a **System Set** subtest:

- A program is not running as usual, or a proven piece of software appears to malfunction and you confirm that the software itself is not at fault. (You can confirm that the software is functioning properly by moving it to another computer and running it there.)
- An option card you previously accessed can no longer be accessed.
- You get parity errors or page fault failures (any error message that contains the word *parity* or *page fault*) at any time during operation. These errors are usually accompanied by a reference to an address, which you should record on a copy of the [Diagnostics Checklist](#).
- Correcting errors in the system configuration information in the [System Setup program](#) does not resolve a problem.
- The computer's clock/calendar stops.
- The speaker no longer functions. The problem could be a failure of the system timers as well as a failure of the speaker itself. Run the **System Timers Test**, followed by the **System Speaker Test**.
- If a peripheral device appears to malfunction, run the **Interrupt Controllers Test**.
- A spreadsheet program or other type of mathematical application runs abnormally slow, generates error messages concerning calculations or operations, runs incorrectly, or generates incorrect results, or a proven piece of the program appears to malfunction and you confirm that the software itself is not at fault. (You can confirm that the software is not at fault by moving the program to another computer and running it there.)
- The computer periodically locks up, especially at different places and times in different programs.
- The computer halts in the middle of performing calculations or complex mathematical operations.

Video Test Group

The subtests in the **Video Test Group** verify the proper operation of the video controller and the video control circuitry installed in your computer. These subtests check for the correct operation of the readable registers in the video circuitry and the controller. They write, read, and verify data patterns in the cursor registers of the controller. The **Video Test Group** also tests all the video memory and provides additional subtests to test the color features of a color monitor.

The eight subtests in the **Video Test Group** confirm the following video functions:

- **Video Memory Test**

Checks the read/write capability of video memory in various video modes.

- **Video Hardware Test**

Checks the cursor registers and the horizontal and vertical retrace bit registers in the video controller.

Text Mode Character Test

Checks the video subsystem's ability to present data in text modes.

- **Text Mode Color Test**

Checks the video subsystem's ability to present color in text modes.

- **Text Mode Pages Test**

Checks the video subsystem's ability to map and present all available video pages on the screen, one page at a time.

- **Graphics Mode Test**

Checks the video subsystem's ability to present data and color in graphics modes.

- **Color Palettes Test**

Checks the video subsystem's ability to display all of the available colors.

- **Solid Colors Test**

Checks the video subsystem's ability to show screens full of solid colors. Allows you to check for missing color subpixels.

Many of these tests display characters or graphics on the screen for you to verify. Samples of these screens are shown in "[Diagnostics Video Tests](#)."



*NOTE: The default limit for testing super video graphics array (SVGA) modes is **No**. If you are testing an external monitor, change the default to **Yes**.*

Why Run a Video Test?

Many of the symptoms that would prompt you to run a subtest in the **Video Test Group** are obvious, because the monitor is the visual component of your computer system. Before you run the **Video Test Group** or any of its subtests, you should make sure that the problem is not in your software or caused by a hardware change. You should also try running all of the software support utilities provided for the monitor and the video subsystem.

If the following symptoms still occur, run the appropriate test(s) as follows:

- If your monitor shows a partially formed or distorted image, run *all* of the subtests in the **Video Test Group**.
- If the alignment of text or images is *off*, regardless of the program you are running, run the **Text Mode Character Test**, **Text Mode Pages Test**, and **Graphics Mode Test**.
- If you have a color monitor or a program that runs in color, but the color is intermittent or not displayed at all, run the **Text Mode Color Test**, **Color Palettes Test**, and **Solid Color Test**.
- If your monitor malfunctions in one mode but works fine in another (for example, text is displayed correctly, but graphics are not), run the **Text Mode Character Test**, **Text Mode Color Test**, **Text**

Mode Pages Test, and Graphics Mode Test.

Keyboard Test Group

The subtests in the **Keyboard Test Group** verify the correct operation of your keyboard and the keyboard controller chip.

The five keyboard subtests confirm the following keyboard functions:

- **Keyboard Controller Test**

Confirms the ability of the keyboard controller chip to communicate with the keyboard and the programming of the controller chip

- **Keyboard Key Sequence Test**

Verifies that the keys on the keyboard function correctly when you press the keys in a predefined order

- **Keyboard Interactive Test**

Checks the internal microcode of the keyboard and the external interface of the keyboard controller chip for a malfunctioning key

- **Stuck Key Test**

Checks the internal microcode of the keyboard and the external interface of the keyboard controller chip for a repeating key signal

- **External Key Pad Test**

Checks the contact beneath the key for an electrical impulse to ensure that the key is working properly

Why Run a Keyboard Test?

Keyboard problems are not always caused by the keyboard. For example, a complete lockup of the computer system, rendering the keyboard inoperable, is more likely caused elsewhere. There are three symptoms that are likely to be keyboard-related. Sometimes, the configuration of a program changes the function of a key or key combination. Likewise, key configuration programs such as ProKey can change a key's function.

Because these programs are memory resident, you should be sure to clear them out of your computer's memory before running a subtest in the **Keyboard Test Group**. (Clear them from memory by booting your computer from the diagnostics diskette.) When these possibilities have been eliminated, and if the following symptoms occur, you should run one or more of the subtests in the **Keyboard Test Group**:

- When you press a key, the character represented by that key appears repeatedly; the key seems to be stuck. Run the **Stuck Key Test**.
- When you press a key and the response is different from the usual response or the response you anticipated, the key contact may be damaged. Run the **Keyboard Interactive Test**.
- When a key does not work at all, run *all* of the subtests in the **Keyboard Test Group**.

Mouse Test

The **Mouse Test** checks the functionality of the mouse controller (which coordinates cursor movement on the screen with corresponding movement of your mouse or touch pad) and the operation of the mouse keys/touch pad.

There are no subtests for the **Mouse Test Group**.

Why Run the Mouse Test?

Mouse or touch pad problems are as likely to originate in RAM as they are to be caused by a faulty mouse or touch pad. Three sources of RAM-related problems include the configuration of a program (which changes the function of the mouse or touch pad), memory-resident programs such as Sidekick or ProKey, and failure of a device driver (the software that controls the function of the mouse or touch pad). If these possibilities have been eliminated and the following symptoms persist, run the **Mouse Test**:

- When you press a mouse button or the touch pad, the function of the button (or touch pad) continues; that is, the button (or touch pad) seems to be stuck.
- If the response when you press a mouse button or the touch pad is different from the usual or anticipated response, the button (or touch pad) contact may be damaged.
- A mouse button or the touch pad does not work at all.
- The cursor does not respond on the screen in accordance with the movements you make with the mouse or touch pad.

Diskette Drives Test Group

The subtests in the **Diskette Drives Test Group** allow you to test both 5.25-inch and 3.5-inch diskette drives of all capacities.

The four diskette drive subtests available in the **Diskette Drives Test Group** confirm the following drive functions:

- **Change Line Test**

Checks for bent pins on the diskette drive controller and for defective lines on the diskette cable

- **Seek Test**

Checks the drive's ability to search for a specified track on the diskette and to position its read/write heads to all tracks

- **Read Test**

Positions the read/write heads at each cylinder of the diskette for reading data and verifies that all tracks on the diskette can be read correctly

- **Write Test**

Positions the read/write heads at each cylinder of the diskette and verifies that all tracks on the

diskette can be written to correctly

Why Run a Diskette Drives Test?

Very often, a diskette drive problem may first appear to be a diskette problem. A box of defective diskettes might produce faulty-drive error messages. The test results can be confusing, so Dell suggests running the subtests in the **Diskette Drives Test Group** more than once using diskettes from different sources.

Another possible cause of diskette drive problems is human error—typing a command in an incorrect form (usually called a *syntax* error). Be sure you have entered the command in the proper form.

When the diskette(s) and command syntax are eliminated as causes, the following symptoms usually suggest a drive problem and warrant running a subtest in the **Diskette Drives Test Group**:

- An error message appears on the screen stating that the computer cannot *read* from or *write* to a diskette.
- A diskette cannot be properly formatted, or format error messages appear on the screen.
- Data on diskettes is corrupted or lost; these problems may be intermittent.

IDE (ATA/ATAPI) Devices

The subtests in the **IDE (ATA/ATAPI) Devices Test Group** check the functionality of all drives connected to the system IDE bus, including hard-disk and removable media drives. Some of the subtests listed in this section apply only to particular types of drives, such as the **Tape Retension Test**, which applies only to tape drives.

The eleven subtests in the **IDE (ATA/ATAPI) Devices Test Group** confirm the following drive functions:

- **Display Information**

Displays information about any drives connected to the IDE bus.

- **Confidence Test**

Runs a quick test on any hard-disk drives to ensure that they are operating properly.

- **Self Diagnostics Test**

Uses the drive's internal test capability to determine whether the drive is functioning properly.

- **Seek Test**

Checks the drive's ability to search for each block on the device.

- **Read Test**

Positions the read heads at each block of the device for reading data and verifies that all blocks on the device can be read correctly.

- **Verify Test**

Similar to the Read Test, but no data is transferred from the drive to the system.

- **Write Test**

Positions the read/write heads at each block of the drive and verifies that all tracks on the drive can be written to correctly.

- **SMART Test**

Checks to see if a hard-disk drive's internal error thresholds have been exceeded, which might predict impending hard-disk drive failure. If any thresholds have been exceeded, the test fails.

- **CD-ROM Audio Test**

Attempts to play an audio track from a CD in a CD-ROM drive. If the system does not have speakers and an integrated audio controller or sound card, you must connect headphones to the CD-ROM headphone jack to verify whether the test completes successfully.

- **Media Eject Test**

Attempts to electronically eject media from a removable media drive. If the drive does not support electronic media ejection, the test is meaningless.

- **Tape Retension Test**

Performs a tape retension operation on a tape drive with a tape cartridge installed. Tape drive errors are sometimes due to a cartridge that needs to be retensioned.

Why Run an IDE (ATA/ATAPI) Devices Test?



NOTE: If you check your hard-disk drive to determine the amount of available space, your operating system will probably report problem areas. Problem areas on hard-disk drives are common because most hard-disk drives have a small amount of space that is not usable. The hard-disk drive keeps a record of this space so that your computer will not attempt to use it. Identification of unusable disk space, unless it is an unusually large amount (over five percent of the possible total), should not be regarded as a cause for testing the hard-disk drive.

These are the most common symptoms that might prompt you to test an IDE drive:

- The drive fails during the boot routine.
- Seek errors are reported by the operating system or application programs.
- An error message appears on the screen stating that the computer cannot read from or write to the drive.
- Data on the drive is corrupted or lost; this problem may be intermittent. Once saved by a program, files cannot be properly recalled.

Serial/Infrared Ports Test Group

The subtests in the **Serial/Infrared Ports Test Group** check the computer's interface with external devices,

such as a printer and a mouse, that are connected to the computer through a serial or infrared port. The subtests in this test group are not intended as a diagnostic test for the actual peripheral attached to each port.



*NOTES: With certain modems installed, the **Serial/ Infrared Ports Test Group** subtests may fail because the modem appears to the Dell Diagnostics as a serial or infrared port, but it cannot be tested as a serial or infrared port. If a modem is installed and one of the serial/ infrared ports subtests fails, remove the modem and run the diagnostic tests again.*

*If an external loopback connector is not attached to a serial or infrared port, the **Serial External Transmission Test** will fail for that port and the results of this test should therefore be ignored. An external modem connected to the port does not substitute for an external loopback connector.*

The four subtests in the **Serial/Infrared Ports Test Group** confirm the following port functions:

- **Serial/Infrared Baud Rate Test**

Checks the baud rate generator in each serial communications chip against the computer's clock

- **Serial/Infrared Interrupt Test**

Checks the serial port's ability to send IRQs to the microprocessor

- **Serial/Infrared Internal Transmission Test**

Checks several internal functions of the serial port using the internal loopback mode of the serial communications chip

- **Serial External Transmission Test**

If a loopback device is attached, checks the line control bits of the serial port and sends a test pattern at several baud rates, checking the returned values

Why Run a Serial/Infrared Ports Test?

If the Dell Diagnostics does not recognize your computer's serial or infrared ports, enter the [System Setup program](#) and check the **Serial/infrared Port** category to see whether the port has been disabled. The subtests in the **Serial/Infrared Ports Test Group** cannot test a port unless it is enabled.

When a port is faulty, it may not be immediately evident that the port, and not the device connected to the port, is faulty. Instead, the peripheral (such as a printer or mouse) might behave erratically or not operate at all. If the external device is not properly installed through your software, it also may not function properly. Try operating the peripheral from different programs or through the operating system. If it still does not work, you can eliminate the software configuration as the cause of the problem.

Another possible cause for errors is the external device. Use the documentation that came with the peripheral to troubleshoot it and confirm that it is working properly. (Most printers have a self-test.)

After you eliminate incorrect system configuration information settings, peripheral malfunctions, and software errors as potential causes of port problems, you can run the subtests in the **Serial/Infrared Ports Test Group** to check your hardware. Although the following symptoms can be caused by faulty peripherals or software errors, they might also suggest a port problem:

- If a peripheral works intermittently or produces intermittent errors, the port may be faulty.
- If the computer displays an error message that is related to the external device connected to a port, but corrections to the device do not resolve the error, run the appropriate subtest in the **Serial/Infrared Ports Test Group**.
- If your software and the diagnostics do not recognize that you have a serial or infrared port, you should check the **Serial/Infrared Port** category in the [System Setup program](#), and if necessary, run the appropriate subtest in the **Serial/Infrared Ports Test Group**.

Parallel Ports Test Group

The subtests in the **Parallel Ports Test Group** check the computer's interface with external devices, such as a printer, that are connected to the computer through a parallel port. The subtests in this test group are not intended as a diagnostic test for the actual peripheral attached to each port. (The only exception is a printer, as described in the **Parallel Internal Test**.)



*NOTE: If an external loopback connector is not attached to the parallel port, the **Parallel External Loopback Test** will fail for that port and the results of this test should therefore be ignored.*

The four subtests in the **Parallel Ports Test Group** confirm the following port functions:

- **Parallel Internal Test**

Checks several internal functions of the parallel port

- **Parallel External Loopback Test**

Tests the functionality of the control lines through an external loopback connector, if an external loopback connector is available

- **Parallel External Interrupt Test**

Tests the parallel port's ability to generate interrupts from all possible sources, if an external loopback connector or printer is available

- **Parallel Printer Pattern Test**

Tests a printer and tests the parallel port's ability to send a pattern to the printer, if connected

Why Run a Parallel Ports Test?

If the Dell Diagnostics does not recognize your computer's parallel port, enter the [System Setup program](#) and check the **Parallel Port** category to see if the port has been disabled. The subtests in the **Parallel Ports Test Group** cannot test a port unless it is enabled.

When a port is faulty, it may not be immediately evident that the port, and not the device connected to the port, is faulty. Instead, the peripheral (such as a printer) might behave erratically or not operate at all. If the external device is not properly installed through your software, it also may not function properly. Try operating the peripheral from different programs or through the operating system. If it still does not work, you can eliminate the software setup as the cause of the problem.

Another possible cause for errors is the external device. Use the documentation that came with the peripheral to troubleshoot it and confirm that it is working properly. (Most printers have a self-test.)

After you eliminate incorrect system configuration information settings, peripheral malfunctions, and software errors as potential causes of port problems, you can run the subtests in the **Parallel Ports Test Group** to check your hardware. Although the following symptoms can be caused by faulty peripherals or software errors, they might also suggest a port problem:

- If a peripheral works intermittently or produces intermittent errors, the port may be faulty.
- If the computer displays an error message that is related to the external device connected to a port, but corrections to the device do not resolve the error, run the appropriate subtest in the **Parallel Ports Test Group**.
- If your software and the Dell Diagnostics do not recognize that you have a parallel port, you should check the **Parallel Port** category in the [System Setup program](#), and if necessary, run the appropriate subtest in the **Parallel Ports Test Group**.

SCSI Devices Test Group

The subtests in the **SCSI Devices Test Group** check the functionality of up to four SCSI host adapters and all the SCSI devices attached to them.



*NOTES: Before conducting these subtests on CD-ROM drives, insert a CD with audio and data tracks (such as a multimedia CD) into each CD-ROM drive. All of the subtests, except for the **Audio Output Test**, require a CD with data tracks. The **Audio Output Test** requires a CD with audio tracks.*

If a CD-ROM drive is empty or if it contains a CD that does not have the required data or audio tracks (depending on the subtest[s] being conducted), the subtest(s) will fail.

The seven subtests in the **SCSI Devices Test Group** confirm the following drive functions:

- **Internal Diagnostic**

Causes the device to run its internal self-test.

- **Seek Test**

Checks the device's ability to search for a specified track on the device and to position its read/write heads to all tracks.

- **Read Test**

Positions the read/write heads at each block of the device for reading data and verifies that all tracks on the device can be read correctly.

- **Write Test**

Positions the read/write heads at each block of the device and verifies that all tracks on the device can be written to correctly.

- **Audio Output Test**

Causes the CD-ROM drive to begin playing the first audio track on an audio CD. To determine whether the test passed, listen to the audio output of the drive.



NOTE: To conduct the **Audio Output Test**, you must select it individually. It will not run as part of the test group.

- **Eject Removable Media**

Causes a CD-ROM drive to eject its CD or a SCSI tape drive to eject its tape cartridge.

- **Display Information**

Displays a screen of information about each SCSI host adapter in the computer, the resources allocated to each SCSI host adapter, and a list of target devices attached to the SCSI host adapter.

Why Run a SCSI Devices Test?

If you check your SCSI hard-disk drive to determine the amount of available space, your operating system will probably report problem areas. Problem areas on hard-disk drives are common, because most hard-disk drives have a small amount of space that is not usable. The hard-disk drive keeps a record of this space so that your computer will not attempt to use it. Identification of unusable disk space, unless it is an unusually large amount (over 5 percent of the possible total), should not be regarded as a cause for testing the hard-disk drive.

These are the most common symptoms that might prompt you to test a SCSI device:

- A SCSI hard-disk drive fails during the boot routine.
- *Seek* errors are reported by the operating system or application programs.
- An error message appears on the screen stating that the computer cannot read from or write to a SCSI device.
- Data on a SCSI device is corrupted or lost; this problem may be intermittent. Once saved by a program, files cannot be properly recalled.

Network Interface Test Group

The subtests in the **Network Interface Test Group** verify the basic operation of the network interface controller (NIC). They test its internal functions, including read and write access to its registers and internal transmit and receive (loopback) capability.

The subtests in the **Network Interface Test Group** confirm the following functions:

- **Registers Test**

Writes patterns to the writable registers in the controller and reads the patterns back to verify whether they are accessible and able to retain data. This subtest also tests interrupt generation and register-specific functionality based on the type of controller.

- **Internal Loopback Test**

Places the controller into its various internal loopback modes and tests its ability to transmit and receive data.

 *NOTE: For some controllers, this test is not applicable.*

- **External Loopback Test**

Places the controller into its various external loopback modes and tests its ability to transmit and receive data. A loopback plug is required to perform this test.

 *NOTE: For some controllers, this test is not applicable.*

- **Shared RAM Test**

Performs a memory test on controllers with memory-mapped shared RAM. On controllers with first-in first-out (FIFO)-shared RAM, writes a data pattern to all locations and reads the pattern back to verify the operation. Some controllers do not support shared RAM tests.

- **Display Information**

Displays addresses and configuration information about the NIC. This information includes the network address used for communication on the local area network (LAN).

Why Run a Network Interface Test?

Running a subtest in the **Network Interface Test Group** helps diagnose problems that may be encountered while the system is operating in a network environment. Most network failures are caused by one of the following:

- Poor network connections
- Failure in the controller
- Interrupt conflict (the controller trying to use the same IRQ line as another device)
- Software configuration error

If a problem occurs while the system is operating in a network, the network connection should be inspected. If the connection is good, the **Network Interface Test Group** can be run to indicate whether the NIC is functioning, and if the test group is run in a loop, it can be used to detect intermittent failures.

The **Registers Test** subtest checks the interrupt generation capability of the controller. The **Display Information Test** displays the controller's IRQ level. You can then make sure there is not an interrupt conflict by verifying that the IRQ level is not being used by another device in the system.

Audio Test Group

The subtests in the **Audio Test Group** check the functions of the audio controller and the computer's recording and playback features.



NOTE: The following subtests are only applicable for systems with built-in speakers.

The eleven subtests in the **Audio Test Group** confirm the following functions:

- **Software Reset Test**

Checks for the presence of an active audio controller in your system

- **Compatibility ID Test**

Determines if the correct sound controller is installed in your system

- **Interrupt Test**

Checks to see if the audio controller is generating an interrupt on the IRQ line configured for that controller

- **DMA Test**

Tests for the presence of a DMA channel on the system chip set, and determines if the DMA controller and audio controller can exchange signals

- **FIFO RAM Test**

Checks the read/write capabilities and status of the audio controller

- **Initial Reset Status Test**

Verifies the reset values of the extended registers on the audio controller

- **Internal Register Test**

Writes test patterns to the internal registers of the audio controller, then reads other registers to confirm that the patterns are correctly interpreted

- **Dual Channel Test**

Confirms the presence of a second DMA channel on the system chip set and determines if the DMA controller and audio controller can exchange signals on that second DMA channel

- **FM Sound Playback Test**

Tests whether the system can synthesize sounds and play them through the built-in speakers

- **Analog Sound Playback Test**

Tests whether the system can play sampled sounds through the built-in speakers

- **Record and Playback Test**

Checks the ability of the audio controller to generate a sampled sound from signals received from the built-in microphone

Why Run an Audio Test?

If you do not hear sounds from your built-in speakers when you expect to, it is possible that your operating system or sound application uses resource settings different from those of the audio controller in the computer. In the absence of an expected sound, first check the documentation that accompanied your operating system or sound application to see if the sound features are correctly configured to work with the computer. The default settings for the audio controller are:

- DMA channel: 1
- IRQ line: 5
- Port address: 220h

If necessary, change the resource settings in your operating system or sound application to match these default settings.

If you still do not hear sound when you expect to, run the **Audio Test Group**.



*NOTE: Before running the **Audio Test Group**, make sure to enable the built-in speaker(s), and make sure that the speaker volume has not been muted.*

System Management BIOS Test Group

The subtests in the **System Management BIOS Test Group** test the state of various system devices, such as the temperature of the processor, and display information about these system devices.

The six subtests in the **System Management BIOS Test Group** test and display information about the following system devices:

- **BIOS Information**

Covers general BIOS information, language support, hardware security, and system power controls

- **Environment Information**

Covers cooling devices, voltage probe states, and temperature probe states

- **I/O Information**

Covers port information, system expansion slots, and integrated devices

- **Memory Information**

Covers physical memory array information, memory device information, memory array mapped address information, and memory device mapped address information

- **Processor Information**

Covers processor states and cache information

- **System Information**

Covers general system information, chassis information, and system configuration options

Error Messages

When you run a test group or subtest in the Dell Diagnostics, error messages may result. These particular error messages are not covered in this section because the errors that generate these messages can be resolved only with Dell technical assistance. Record the messages on a copy of the [Diagnostics Checklist](#). For instructions on obtaining technical assistance and for informing the support technician of these messages, also see "[Contacting Dell](#)."

[Back to Contents Page](#)

[Back to Contents Page](#)

System Setup Options: Dell™ OptiPlex™ GX1 Small-Form-Factor System User's Guide

- | | |
|---------------------------------------------------------------------------|---------------------------------------------------|
| Time | Power Management |
| Date | Wakeup On LAN |
| Diskette Drive A, Diskette Drive B, and Use ZIP as A or B | Sound |
| Drives: Primary and Secondary | NIC |
| Reserved Memory | Mouse |
| CPU Speed | Serial Port 1 and Serial Port 2 |
| Num Lock | Parallel Port |
| Chassis Intrusion | Parallel Mode |
| DAC Snoop | IDE Hard Disk |
| ACPI | Diskette |
| Keyboard Errors | Speaker |
| System Password | System Data Options |
| Password Status | Using the System Password Feature |
| Boot Sequence | Using the Setup Password Feature |
| Setup Password | Disabling a Forgotten Password |
| Auto Power On | Responding to Error Messages |

Time

Time resets the time on the computer's internal clock.

Time is kept in a 24-hour format (*hours:minutes:seconds*). To change the time, press the right-arrow key to increase the number in the highlighted field or press the left-arrow key to decrease the number. If you prefer, you can type numbers in each of the appropriate fields.

Date

Date resets the date on the computer's internal calendar.

Your system automatically displays the day of the week corresponding to the settings in the three fields that follow (*month*, *day-of-month*, and *year*).

To change the date, press the right-arrow key to increase the number in the highlighted field or press the left-arrow key to decrease the number. If you prefer, you can type numbers in the month and day-of-month fields.

Diskette Drive A, Diskette Drive B, and Use ZIP as A or B

Diskette Drive A and **Diskette Drive B** identify the type of diskette drives installed in your computer. With the standard cabling configuration, **Diskette Drive A** (the boot diskette drive) is the 3.5-inch diskette drive installed in the top externally accessible drive bay; **Diskette Drive B** is any drive installed in the bottom externally accessible drive bay that is connected to the system's diskette/tape drive interface.

The option settings always match the physical locations of the drives in your computer—the first drive listed on Page 1 of the [System Setup screens](#) is the top drive in your computer.

The options are:

- **5.25 Inch, 360 KB**
- **5.25 Inch, 1.2 MB**
- **3.5 Inch, 720 KB**
- **3.5 Inch, 1.44 MB**
- **Not Installed**

Use ZIP as A or B is used to control the operation of an internally installed Advanced Technology Attachment Packet Interface (ATAPI) Zip drive. The options are **On** and **Off**. When set to **On**, the Zip drive operates as a diskette drive and can be booted. When set to **Off**, the Zip drive operates as a normal ATAPI device.

You can have a total of two diskette devices, either diskette drives or Zip drives.



NOTE: *Tape drives are not reflected in the **Diskette Drive A** and **Diskette Drive B** options. For example, if you have a single diskette drive and a tape drive attached to the diskette/tape drive interface cable, set the **Diskette Drive A** option to match the characteristics of the diskette drive and set the **Diskette Drive B** option to **Not Installed**.*

Drives: Primary and Secondary

Primary identifies drives attached to the primary enhanced integrated drive electronics (EIDE) interface connector (labeled "IDE1") on the system board; **Secondary** identifies drives connected to the secondary EIDE interface connector (labeled "IDE2"). Dell recommends that you use the secondary EIDE interface connector for EIDE CD-ROM and EIDE tape drives.

The System Setup program reports hard-disk drives in one of two ways:

- Newer hard-disk drives and all hard-disk drives over 8 gigabytes (GB) are reported as an **EIDE Drive**, without details on type, cylinders, heads, cylinder numbers, and sectors. See [Figure 1](#) in "Using the System Setup Program" for an example.
- Older hard-disk drives are reported with full details about type, cylinders, heads, cylinder numbers, sectors, and size.



*NOTE: For all Dell-installed hard-disk drives, set the appropriate drive option to **Auto**.*

Use one of the following options if you have an older EIDE hard-disk drive not shipped with the system from Dell and with less than 528 megabytes (MB) in capacity:

- A specific drive-type number
- **Usr1** or **Usr2**

For each drive, you can choose the seven parameters as a group by drive-type number or you can enter the parameters individually from the keyboard. A *drive-type number* specifies the parameters of a hard-disk drive, based on a table recorded in the system's basic input/output system (BIOS).



NOTE: Operating systems that bypass the system BIOS may not obtain optimum hard-disk drive performance

If you choose the **Usr1** or **Usr2** option, you must supply the following parameters for the drive:

- **Type** is the drive-type number for the selected hard-disk drive (in this case, **Usr1** or **Usr2**).
- **Cyls** is the number of logical cylinders.
- **Hds** indicates the number of logical heads in the drive.
- **Pre** (*precompensation cylinder*) is the cylinder number at which the electrical current for the drive head changes to compensate for differences in data density across the disk surface (this parameter has no effect for EIDE drives).
- **LZ** is the cylinder number that is used as the drive's landing zone for the heads when the drive is not in use.
- **Sec** is the number of logical sectors per track.
- **Size** (automatically calculated by the system) indicates the number of millions of bytes of storage provided by the drive.

Reserved Memory

Reserved Memory allows you to designate a region of system board memory that can be supplied by an expansion card. You should not enable the reserved memory feature unless you are using an expansion card that requires special addressing.

For example, you may have a memory expansion card that needs to be addressed starting at 15 MB. Selecting the **15M - 16M** option in the **Reserved Memory** option specifies that the base memory from 15 to 16 MB comes from the memory expansion card (the base memory below the 15-MB address comes from the dual in-line memory modules [DIMMs] on the system board).

The **Reserved Memory** option has the following settings:

- **None** (the default option)
 - **512K - 640K**
 - **15M - 16M**
-

CPU Speed

CPU Speed indicates the processor speed at which your system boots.

Press the left- or right-arrow key to toggle the **CPU Speed** option between the resident microprocessor's rated speed (the default) and a lower compatibility speed, which lets you accommodate speed-sensitive application programs. A change to this option takes effect immediately (rebooting the system is not required).

You can also toggle between the rated processor speed and the compatibility speed while the system is running in real mode by pressing <Ctrl><Alt><.>. (For keyboards that do not use American English, press <Ctrl><Alt><#>.)

Num Lock

Num Lock determines whether your system boots with the Num Lock mode activated on 101- or 102-key keyboards (it does not apply to 84-key keyboards).

When Num Lock mode is activated, the rightmost bank of keys on your keyboard provides the mathematical and numeric functions shown at the tops of the keys. When Num Lock mode is turned off, these keys provide cursor-control functions according to the label on the bottom of each key.

Chassis Intrusion

Chassis Intrusion displays the status of the system chassis intrusion monitor. The settings for this option are **Enabled**, **Enabled-Silent**, or **Disabled**. The default is **Enabled**.

If the computer cover is removed while the intrusion monitor is set to **Enabled**, the setting changes to **Detected**, and the following message appears during the boot sequence at the next system start-up:

```
Alert! Cover was previously removed.
```

If the computer cover is removed while the intrusion monitor is set to **Enabled-Silent**, the setting changes to **Detected**, but the alert message is not displayed during the boot sequence at the next system start-up.

If the intrusion monitor is set to **Disabled**, no intrusion monitoring occurs and no messages are displayed.

To reset the **Detected** setting, enter the [System Setup program](#) during the system's power-on self-test (POST). Highlight the **Chassis Intrusion** option and press the left- or right-arrow key to choose **Enabled**, **Enabled-Silent**, or **Disabled**.



*NOTE: When the setup password is enabled, you must enter the setup password before you can reset the **Chassis Intrusion** option.*

DAC Snoop

DAC Snoop lets you correct video problems that may occur when certain video add-in cards are used. The default is **Off**. If you are using a video add-in card and problems such as incorrect colors or blank windows occur, set **DAC Snoop** to **On**.

ACPI

This option controls the operation of the system's Advanced Configuration and Power Interface (ACPI) feature.

When **ACPI** is set to **On**, momentarily pressing the power button places the system in a power-saving mode. To turn the system off completely, press the power button for more than 4 seconds. When **ACPI** is set to **On**, interrupt request (IRQ) line 9 is not available for use by an expansion card.

When **ACPI** is set to **Off**, momentarily pressing the power button turns off the system completely. With this setting, IRQ9 is available for use by an expansion card.

Keyboard Errors

Keyboard Errors enables or disables reporting of keyboard errors during the POST, which is a series of tests that the system performs on the hardware each time you turn on the system or press the reset button.

This option is useful when applied to self-starting servers or host systems that have no permanently attached keyboard. In these situations, selecting **Do Not Report** suppresses all error messages relating to the keyboard or to the keyboard controller during POST. This option does not affect the operation of the keyboard itself if a keyboard is attached to the computer.

System Password

System Password displays the current status of your system's password security feature and allows you to assign and verify a new password. No one can assign a new password unless the current status is **Not Enabled**, which is displayed in bright characters.

The settings for the **System Password** option are:

- **Not Enabled** (the default)
- **Enabled**

Disabled by Jumper



NOTE: See "[Using the System Password Feature](#)" for instructions on assigning a system password and using or changing an existing system password. See "[Disabling a Forgotten Password](#)" for instructions on disabling a forgotten system password.

Password Status

When [Setup Password](#) is set to **Enabled**, **Password Status** allows you to prevent the system password from being changed or disabled at system start-up.

To lock the system password, you must first assign a setup password in the **Setup Password** option and then change the **Password Status** setting to **Locked**. In this state, the system password cannot be changed through the [System Password](#) option and cannot be disabled at system start-up by pressing <Ctrl><Enter>.

To unlock the system password, you must enter the setup password in the **Setup Password** option and then change the **Password Status** setting to **Unlocked**. In this state, the system password can be disabled at system start-up by pressing <Ctrl><Enter> and then changed through the **System Password** option.

Boot Sequence

Boot Sequence can be set to [Diskette First](#) (the default), [Hard Disk Only](#), [CD-ROM First](#), or [Device List](#).

The term *boot* refers to the system's start-up procedure. When turned on, the system "bootstraps" itself into an operational state by loading into memory a small program, which in turn loads the necessary operating system. **Boot Sequence** tells the system where to look for the files that it needs to load.

Diskette First

Selecting **Diskette First** causes the system to try booting from drive A first. If the system finds a diskette that is not bootable in the drive or finds a problem with the drive itself, it displays an error message. If it does not find a diskette in the drive, the system tries to boot from the hard-disk drive (drive 0), then from the CD-ROM drive, and finally from the Plug and Play network adapters in the order found.

Hard Disk Only

Selecting **Hard Disk Only** causes the system to attempt to boot first from the hard-disk drive and then from the Plug and Play network adapters in the order found.











CD-ROM First

Selecting **CD-ROM First** causes the system to try booting from the CD-ROM drive first. If the system finds a CD that is not bootable in the drive or finds a problem with the drive itself, it displays an error message. If it does not find a CD in the drive, the system tries to boot from drive A, then from drive C, and finally from the Plug and Play network adapters in the order found.

Device List

Device List provides access to the **Device List** screen where you can choose from a list of available boot devices to boot from and specify the order in which your computer attempts to boot from these devices. To view the **Device List** screen (see [Figure 1](#)), press <Ctrl> and the right-arrow key. Table 2 lists other navigation keys used on the **Device List** screen.

Table 2. Device-List Screen Navigation Keys

| Keys | Action |
|------------------------------------------------------------------------------------------------------------------------------------------------------------------------------------------------------------------------------------------------------------------------------------------------------------------------------------------------|--------------------------------------------------------------------------------|
|   | Returns the boot device lists to the default settings |
|   or   | Moves the selected item up or down in the boot sequence |
|   | Exits to Page 2 of the System Setup screens |
|   or  | Moves the selected item from one Boot Device Priority list to the other |

NOTICE: Only a technically knowledgeable person should change the settings in the Device List screen.

The **Device List** screen (see Figure 1) provides three options for listing and prioritizing the available boot devices in your system.

Figure 1. Sample Device List Screen

| Dell Computer Corporation (www.dell.com) System OptiPlex GX1 500 Setup | | BIOS Version: XXXX |
|----------------------------------------------------------------------------------------------------------------------------------------------|-----------------------------------------------------------------------------------------------------------------------------------------------------------------------------------------------------------------|--------------------|
| Device List | | |
| Boot Device Priority: Diskette Drive A: LANdesk Service Agent for 3C090X Hard Drive C: CD-ROM Device | The DEVICE LIST contains devices that may be bootable. The system attempts to boot from the devices in the list as ordered. If you ESC or ALT-B from this menu, the displayed order becomes the boot selection. | |
| Exclude from Boot Device Priority: | Ctrl-Ins moves items between "Boot Device Priority" and "Exclude from Device Priority" only. | |
| Device Controller Priority: System BIOS boot devices | PgDn next 1 of 2 PgUp prev | |
| | Pentium® III Processor - 500 MHz LEVEL 2 Cache: 512 KB Integrated System Memory: 128 MB ECC SDRAM Video Memory: 8 MB SGRAM Service Tag: XXXXX Asset Tag: XXXXX | |
| Ctrl-Del original list Ctrl↑,↓ move item Ctrl-return Ctrl-Ins move to other list | | |

- **Boot Device Priority**

The **Boot Device Priority** option lists all bootable devices (hard-disk drives, CD-ROM drives, and so on) that are controlled by the system BIOS and any Plug and Play network adapters installed in the computer.

- **Exclude From Boot Device Priority**

The **Exclude From Boot Device Priority** option allows you to remove from the **Boot Device Priority** option any boot devices that you want the system to ignore during system start-up.

- **Device Controller Priority**

The **Device Controller Priority** option lists the system BIOS controller; any non-Plug and Play devices, such as network adapter cards; and any secondary controller cards, such as a small computer system interface (SCSI) adapter, installed in the computer.

 *NOTE: Non-Plug and Play devices appear in this list as **Adapters** without ID support.*

When determining the order of devices to boot from, the system first considers the order of the devices listed under the **Device Controller Priority** option, then the order of devices under **Boot Device Priority**.

To specify your priority preferences, order the devices under these options so that the highest-priority controller is at the top of the **Device Controller Priority** option and the highest-priority device is at the top of the **Boot Device Priority** option. Order the remainder of the devices in the **Boot Device Priority** option according to your preferences. Move any devices that you want the system to ignore during system start-up into the **Exclude From Boot Device Priority** option.

 *NOTE: The system defines drive C in the **Boot Device Priority** option as the first hard-disk drive attached to the highest-priority device controller. Therefore, if you have a SCSI adapter installed in your computer and you want the SCSI drive 0 to be drive C, you must move the SCSI adapter item to the top of the **Device Controller Priority** option.*

To change the order of the devices, press <Ctrl> and the up- or down-arrow key. If you want to revert to the original **Boot Device Priority** option settings, press <Ctrl>.

 *NOTE: If you exit the **Device List** option by pressing <Esc> or <Alt> without making any changes, the **Boot Sequence** option is set to the **Device List** option.*

Setup Password

Setup Password indicates whether a password is required before you can change option settings on the System Setup screen. The settings for this option are normally **Enabled** or **Not Enabled**. A third setting, **Disabled By Jumper**, displays if the **Setup Password** option is deactivated. (You can set a jumper on the system board to deactivate the **Setup Password** option.)

If **Setup Password** is set to **Enabled**, you must enter the correct setup password before you can change the settings for the majority of the System Setup options. If you do not enter the correct password in three tries, the system lets you view, but not change, the settings on the System Setup screen, with one exception: if **Password Status** is **Unlocked**, you may change the system password.



NOTE: See "[Using the Setup Password Feature](#)" for instructions on assigning a setup password and using or changing an existing setup password. See "[Disabling a Forgotten Password](#)" for instructions on disabling a forgotten setup password.

Auto Power On

Auto Power On allows you to set the time and days of the week to turn on the computer system automatically. You can set **Auto Power On** to turn on the system either every day or every Monday through Friday.



NOTE: This feature does not work if you turn off your system using a power strip or surge protector.

Time is kept in a 24-hour format (*hours:minutes*). To change the start-up time, press the right-arrow key to increase the number in the highlighted field or press the left-arrow key to decrease the number. If you prefer, you can type numbers in both fields.

The default for **Auto Power On** is **Disabled**. For more information, see the System Utilities on the *Dell ResourceCD*.

Power Management

This section explains the following topics:

- [Saving Monitor Power](#)
- [Saving EIDE Hard-Disk Drive Power](#)

For certain types of monitors and most EIDE hard-disk drives, you can reduce system power consumption by enabling the power management feature. With **Power Management** enabled, these monitors and drives automatically switch into low-power mode during periods of system inactivity.

Power Management can be implemented at three levels—**Maximum**, **Regular**, and **Minimum**. (The different levels apply to the monitor only; hard-disk drive operation is the same for all three.) The default for this option is **Disabled**.

Saving Monitor Power

If you have a Video Electronics Standards Association (VESA®) Display Power Management Signaling (DPMS)-compliant monitor, enabling the **Power Management** option reduces monitor power consumption during periods of keyboard and mouse inactivity.

NOTICE: Check your monitor documentation to make sure you have a DPMS-compliant monitor before you enable this feature. Otherwise, you risk damaging the monitor.



NOTE: The power management feature monitors activity of a mouse connected to the Personal System/2 (PS/2)-compatible mouse port.

By setting **Power Management** to **Maximum**, **Regular**, or **Minimum**, you can set predefined time-out

periods (see [Table 3](#)) for the two successive monitor shutdown stages, *standby* and *off*.



NOTE: Each monitor manufacturer defines the details of the shutdown stages for its own monitors. But in all cases, power consumption decreases with each stage from "on" (full power) to "standby" (reduced power; the display image usually disappears) to "off" (where power consumption is minimal). To define these stages for your monitor, see the documentation that came with the monitor.

From either shutdown stage, you can return full power to the monitor in one of the following ways:

- For most DPMS-compliant monitors, any subsequent activity—including moving the mouse—should return full power to the monitor.
- A few DPMS-compliant monitors require that you turn monitor power off and then on again to return to full power.

Check your monitor documentation for information on how your monitor is designed to operate.

Saving EIDE Hard-Disk Drive Power

For most systems, enabling **Power Management** at any level causes EIDE hard-disk drives to switch to low-power mode after about 20 minutes of system inactivity (see [Table 3](#)).



NOTES: All EIDE drives shipped with your system support this feature. (For more information, see "[ENERGY STAR® Compliance](#).")

However, not all EIDE hard-disk drives support this feature. Enabling this feature for drives that do not support it may cause the EIDE drive to become inoperable until the computer is restarted and the **Power Management** option is disabled.

In low-power mode, the disks inside the drive stop spinning. They remain idle until the next drive access, which causes them to start spinning again. (Because the disks take a few seconds to regain full speed, you may notice a slight delay when you next access the hard-disk drive.)

When **Power Management** is set to **Disabled** (the default), the disks spin constantly as long as the system is turned on.

Table 3. Power Time-Out Periods

| Power Management Setting | EIDE Drive Spindown Time-Outs | Monitor Standby Time-Outs | Monitor Off Time-Outs |
|--------------------------|-------------------------------|---------------------------|-----------------------|
| Disabled | Never | Never | Never |
| Maximum | 20 minutes | 10 minutes | 1 hour |
| Regular | 20 minutes | 20 minutes | 1 hour |
| Minimum | 20 minutes | 1 hour | Never |

Wakeup On LAN

Wakeup On LAN determines whether the Wakeup On LAN feature is set to **On** or **Off**. You must reboot your system before a change takes effect.

Sound

Sound determines whether the integrated audio controller is **On** or **Off**. You must reboot your system before a change takes effect.

NIC

NIC determines whether an integrated network interface controller (NIC) is **On** or **Off**. You must reboot your system before a change takes effect.

Mouse

Mouse enables or disables the system's built-in PS/2-compatible mouse port. Disabling the mouse allows an expansion card to use IRQ 12.

Serial Port 1 and Serial Port 2

Serial Port 1 and **Serial Port 2** configure the system's built-in serial ports. These options can be set to **Auto** (the default) to automatically configure a port, to a particular designation (**COM1** or **COM3** for **Serial Port 1**; **COM2** or **COM4** for **Serial Port 2**), or to **Off** to disable the port.

If you set a serial port to **Auto** and add an expansion card containing a port configured to the same designation, the system automatically remaps the built-in port to the next available port designation that shares the same IRQ setting as follows:

- **COM1** (input/output [I/O] address 3F8h), which shares IRQ4 with **COM3**, is remapped to **COM3** (I/O address 3E8h).
- Likewise, **COM2** (I/O address 2F8h), which shares IRQ3 with **COM4**, is remapped to **COM4** (I/O address 2E8h).



*NOTES: When two COM ports share an IRQ setting, you can use either port as necessary, but **you may not be able to use them both at the same time**. If the second port (COM3 or COM4) is also in use, the built-in port is turned off.*

If you are using the Microsoft® Windows® 95 or IBM® OS/2® operating system, you cannot use both serial ports at the same time.

Parallel Port

Parallel Port configures the system's built-in parallel port. This option can be set to **378h** (the default), to

alternate addresses **278h** or **3BCh**, or to **Off** to disable the port.



*NOTE: Do not set **Parallel Port** to **278h** if you have an Enhanced Capabilities Port (ECP) device connected to the port.*

Parallel Mode

Parallel Mode controls whether the system's built-in parallel port acts as an AT-compatible (unidirectional) or PS/2-compatible (bidirectional) port.

Your system also supports ECP mode, which can be used by Windows 95 and Windows 98. Windows 95 and Windows 98 use ECP protocol automatically if the operating system detects an ECP-capable device, eliminating the need for an ECP setting in this option.

Set this option according to the type of peripheral device connected to the parallel port. To determine the correct mode to use, see the documentation that came with the device.

IDE Hard Disk

IDE Hard Disk enables or disables the system's built-in EIDE hard-disk drive interface.

With **Auto** (the default option) selected, the system turns off the built-in EIDE interface when necessary to accommodate a controller card installed in an expansion slot.

As part of the boot routine, the system first checks for a primary hard-disk drive controller card installed in an expansion slot. If no card is found, the system enables the built-in EIDE interface to use IRQ14 and IRQ15.

If a primary controller is detected on the expansion bus, the built-in EIDE interface is disabled.

Selecting **Off** disables the built-in EIDE interface.

Diskette

Diskette controls the operation of the system's built-in diskette drive controller.

With **Auto** (the default) selected, the system turns off the built-in diskette drive controller when necessary to accommodate a controller card installed in an expansion slot.

With **Write Protect** selected, nothing can be written to diskette drives and tape drives using the system's built-in diskette drive controller. (The system can still read from the drives.) When this option is selected, the **Auto** option (whereby the system turns off the built-in diskette drive controller as necessary) is also in effect.

Selecting **Off** turns off the built-in diskette/tape drive controller; this option is used primarily for troubleshooting purposes.

Speaker

Speaker determines whether the on-board speaker is **On** (the default) or **Off**. A change to this option takes

effect immediately (rebooting the system is not required).

System Data Options

The following options, which are not selectable, display information about the system. The microprocessor type is also listed in the **System Data** box.

- **Level 2 Cache** displays the size of the integrated cache (512 kilobytes [KB]).
 - **System Memory** indicates the entire amount of installed memory detected in your system, except for memory on Expanded Memory Specification (EMS) expansion cards. After adding memory, check this option to confirm that the new memory is installed correctly and is recognized by the system.
 - **Video Memory** displays the amount of video memory detected in your system.
 - **Service Tag** displays the system's five-character service tag number, which was programmed into nonvolatile random-access memory (NVRAM) by Dell during the manufacturing process. Refer to this number during technical assistance or service calls. The service tag number is also accessed by certain Dell support software, including the diagnostics software.
 - **Asset Tag** displays the customer-programmable asset tag number for the system if an asset tag number has been assigned. You can use the Asset Tag utility, which is included with your system utilities, to enter an asset tag number up to ten characters long into NVRAM. For information on using the utility, see the *Dell ResourceCD User's Guide*.
-

Using the System Password Feature

NOTICE: The password features provide a basic level of security for the data on your system. However, they are not foolproof. If your data requires more security, it is your responsibility to obtain and use additional forms of protection, such as data encryption programs.

Your Dell system is shipped to you without the system password feature enabled. If system security is a concern, you should operate your system only with system password protection.

You can assign a system password, as described in "[Assigning a System Password](#)," whenever you use the [System Setup program](#). After a system password is assigned, only those who know the password have full use of the system.

When the [System Password](#) option is set to **Enabled**, the computer system prompts you for the system password just after the system boots.

To change an existing system password, you must know the password (see "[Deleting or Changing an Existing System Password](#)"). If you assign and later *forget* a system password, you need to be able to remove the computer cover to change a jumper setting that disables the system password feature (see "[Disabling a Forgotten Password](#)"). Note that you erase the *setup password* at the same time.

Assigning a System Password

NOTICE: If you leave your system running and unattended without having a system password assigned, or if you leave your computer unlocked so that someone can disable the password by

changing a jumper setting, anyone can access the data stored on your hard-disk drive.

Before you can assign a system password, you must enter the System Setup program and check the **System Password** option.

When a system password is assigned, the option shown in the **System Password** option is **Enabled**. When the system password feature is disabled by a jumper setting on the system board, the option shown is **Disabled by Jumper**. You cannot change or enter a new system password if either of these options is displayed.

When no system password is assigned and the password jumper on the system board is in the enabled position (its default), the option shown for the **System Password** option is **Not Enabled**. Only when this option is set to **Not Enabled** can you assign a system password, using the following procedure:

1. Verify that the [Password Status](#) option is set to **Unlocked**.
2. Highlight the **System Password** option, and then press the left- or right-arrow key.

The option heading changes to **Enter Password**, followed by an empty seven-character field in square brackets.

3. Type your new system password.

You can use up to seven characters in your password.

As you press each character key (or the spacebar for a blank space), a placeholder appears in the field.

The password assignment operation recognizes keys by their location on the keyboard, without distinguishing between lowercase and uppercase characters. For example, if you have an *M* in your password, the system recognizes either *M* or *m* as correct.

Certain key combinations are not valid. If you enter one of these combinations, the speaker emits a beep.

To erase a character when entering your password, press the <Backspace> key or the left-arrow key.



NOTE: To escape from the field without assigning a system password, press the <Tab> key or the <Shift><Tab> key combination to move to another field, or press the <Esc> key at any time prior to completing step 5.

4. Press <Enter>.

If the new system password is less than seven characters, the whole field fills with placeholders. Then the option heading changes to **Verify Password**, followed by another empty seven-character field in square brackets.

5. To confirm your password, type it a second time and press <Enter>.

The password setting changes to **Enabled**. Your system password is now set; you can exit the System Setup program and begin using your system. Note, however, that password protection does not take effect until you reboot the system by pressing the reset button or by turning the

system off and then on again.

Using Your System Password to Secure Your System

Whenever you turn on your system, press the reset button, or reboot the system by pressing the <Ctrl><Alt> key combination, the following prompt appears on the screen when the **Password Status** option is set to **Unlocked**:

Type in the password and...

– press <ENTER> to leave password security enabled.

– press <CTRL><ENTER> to disable password security.

Enter password:

If the **Password Status** option is set to **Locked**, the following prompt appears:

Type the password and press <Enter>.

After you type the correct system password and press <Enter>, your system boots and you can use the keyboard and/or mouse to operate your system as usual.



NOTE: If you have assigned a setup password (see "[Using the Setup Password Feature](#)") the system accepts your setup password as an alternate system password.

If a wrong or incomplete system password is entered, the following message appears on the screen:

```
** Incorrect password. **
```

Enter password:

If an incorrect or incomplete system password is entered again, the same message appears on the screen.

The third and subsequent times an incorrect or incomplete system password is entered, the system displays the following message:

```
** Incorrect password. **
```

```
Number of unsuccessful password attempts: 3
```

```
System halted! Must power down.
```

The number of unsuccessful attempts made to enter the correct system password can alert you to an unauthorized person attempting to use your system.

Even after your system is turned off and on, the previous message is displayed each time an incorrect or incomplete system password is entered.



NOTE: You can use the **Password Status** option in conjunction with **System Password** and **Setup Password** to further protect your system from unauthorized changes.

Deleting or Changing an Existing System Password

To delete or change an existing system password, perform the following steps:

1. Press the <F2> key to enter the [System Setup program](#), and verify that the **Password Status** option is

set to **Unlocked**.

Press the <Alt><p> key combination to move to Page 2 of the [System Setup screens](#).

2. Reboot your system to force it to prompt you for a system password.
3. When prompted, type the system password.
4. Press the <Ctrl><Enter> key combination to disable the existing system password, instead of pressing <Enter> to continue with the normal operation of your system.
5. Confirm that **Not Enabled** is displayed for the System [Password](#) option of the System Setup program.

If **Not Enabled** appears in the **System Password** option, the system password has been deleted. If you want to assign a new password, continue to step 6. If **Not Enabled** is *not* displayed for the **System Password** option, press the <Alt><p> key combination to reboot the system, and then repeat steps 3 through 5.

6. To assign a new password, follow the procedure in "[Assigning a System Password](#)."

Using the Setup Password Feature

Your Dell system is shipped to you without the setup password feature enabled. If system security is a concern, you should operate your system with setup password protection.

You can [assign a setup password](#) whenever you use the [System Setup program](#). After a setup password is assigned, only those who know the password have full use of the System Setup program.

[To change an existing password](#), you must know the setup password. If you assign and later *forget* a setup password, you need to remove the computer cover to change a jumper setting that [disables the setup password](#) feature. Note that you erase the *system password* at the same time.

Assigning a Setup Password

A setup password can be assigned (or changed) only when the [Setup Password](#) option is set to **Not Enabled**. To assign a setup password, perform the following steps:

1. Enter the [System Setup program](#) and go to Page 2 of the System Setup screens.
2. Highlight the **Setup Password** option and press the left- or right-arrow key.

The system prompts you to enter and verify the password. If a character is illegal for password use, the system emits a beep.



NOTES: *The setup password can be the same as the system password.*

If the two passwords are different, the setup password can be used as an alternate system password. However, the system password cannot be used in place of the setup password.

3. Enter and verify the password and click **OK**.

After you verify the password, the **Setup Password** setting changes to **Enabled**. The next time you enter the System Setup program, the system will prompt you for the setup password.

A change to the **Setup Password** option becomes effective immediately (rebooting the system is not required).

Operating With a Setup Password Enabled

If **Setup Password** is set to **Enabled**, you must enter the correct setup password before you can modify the majority of the System Setup options.

When you start the [System Setup program](#), Page 2 of the System Setup screens appears with the **Setup Password** option highlighted, prompting you to type the password.

If you do not enter the correct password in three tries, the system lets you view, but not modify, the System Setup screens—with the following exceptions:

If [System Password](#) is not enabled and is not locked via the **Password Status** option, you can assign a system password (however, you cannot disable or change an existing system password).



*NOTE: You can use the **Password Status** option in conjunction with **Setup Password** to protect the system password from unauthorized changes.*

Deleting or Changing an Existing Setup Password

To delete or change an existing setup password, perform the following steps:

1. Enter the [System Setup program](#) and go to Page 2 of the System Setup screens.
2. Highlight the **Setup Password** option, type in the setup password, and press the left- or right-arrow key to delete the existing setup password.

The setting changes to **Not Enabled**.

3. If you want to assign a new setup password, follow the procedure in "[Assigning a Setup Password](#)."

Disabling a Forgotten Password

If you forget your system or setup password, you cannot operate your system or change settings in the System Setup program until you remove the computer cover, change the password jumper setting to disable the passwords, and erase the existing passwords.

To disable a forgotten password, perform the following steps.



CAUTION: To avoid the possibility of electric shock, turn off the computer and any peripherals, disconnect them from electrical outlets, and then wait at least 5 seconds before you remove the computer cover. Also, before removing the computer cover, see the other precautions in "[Safety First—For You and Your Computer](#)."

1. [Remove the computer cover.](#)

NOTICE: Verify that the AC power cable is removed before changing any jumper settings.

2. Remove the [jumper plug](#) from the PSWD jumper to disable the password feature.

See [Figure 4](#) in "Inside Your Computer" for the location of the password jumper (labeled "PSWD") on the system board.

3. Replace the computer cover.
4. Reconnect your computer and peripherals to their electrical outlets, and then turn them on.

Booting your system with the PSWD jumper plug removed erases the existing password(s).

5. Enter the [System Setup program](#) and verify that the password is disabled. Proceed to step 6 if you want to assign a new password.



NOTE: Before you assign a new system and/or setup password, you must replace the PSWD jumper plug.

6. [Remove the computer cover.](#)

7. Replace the PSWD jumper plug.

8. Replace the computer cover, and then reconnect the computer and peripherals to their electrical outlets and turn them on.

Booting with the PSWD jumper installed reenables the password feature. When you enter the System Setup program, both password options appear as **Not Enabled**, meaning that the password feature is enabled but that no password has been assigned.

9. [Assign a new system password](#) and/or [setup password](#).

Responding to Error Messages

If an error message appears on your monitor screen while the system is booting, make note of the message. Then, before entering the System Setup program, refer to "[Messages and Codes](#)" for an explanation of the message and suggestions for correcting any errors. However, it is normal to receive an error message the first time you boot the system after a memory upgrade. In that case, refer to the instructions in "[System Memory](#)."

If you are given an option to press either <F1> to continue or <F2> to run the System Setup program, press the <F2> key.

[Back to Contents Page](#)

[Back to Contents Page](#)

Internal Components: Dell™ OptiPlex™ GX1 Small-Form-Factor System User's Guide

- [Overview](#)
- [Safety First — For You and Your Computer](#)
- [Removing and Replacing the Computer Cover](#)
- [Troubleshooting a Wet Computer](#)
- [Troubleshooting a Damaged Computer](#)
- [Troubleshooting the Battery](#)
- [Troubleshooting Expansion Cards](#)
- [Troubleshooting System Memory](#)
- [Troubleshooting the Video Subsystem](#)
- [Troubleshooting the System Board](#)
- [Troubleshooting Drives](#)

Overview

This section provides troubleshooting procedures for components inside your computer. Before you start any of the procedures in this section, do the following:

- Perform the procedures described in "[Checking Connections and Switches](#)" and "[System Setup Program](#)."
- Read the safety instructions in "[Safety First—For You and Your Computer](#)."

You need the following items to perform the procedures in this section:

- A copy of the *Dell ResourceCD*
- A small flat-blade screwdriver and a #1 Phillips-head screwdriver (or quarter-inch hex-nut driver)

Safety First—For You and Your Computer

The procedures in this section require that you remove the cover and work inside your computer. While working inside your computer, do not attempt to service the computer except as explained in this guide and elsewhere in Dell documentation. Always follow the instructions closely.

Working inside your computer is safe—if you observe the following precautions.



CAUTION: FOR YOUR PERSONAL SAFETY AND PROTECTION OF THE EQUIPMENT

Before you start to work on the computer, perform the following steps in the sequence indicated:

1. *Turn off* the computer and all peripherals.

2. *Touch* an unpainted metal surface on the computer chassis, such as the metal around the card-slot openings at the back of your computer, before touching anything inside your computer.
3. *Disconnect* the computer and peripherals from their electrical outlets. Doing so reduces the potential for personal injury or shock. Also disconnect any telephone or telecommunication lines from the computer.

While you work, periodically touch an unpainted metal surface on the computer chassis to dissipate any static electricity that might harm internal components.

In addition, Dell recommends that you periodically review the safety instructions in your *System Information Guide*.

Removing and Replacing the Computer Cover

 **NOTE:** If your small-form-factor chassis has an optional stand for vertical orientation attached to it, [remove the optional stand](#) before you remove the computer cover.

To remove the computer cover, perform the following steps:

1. Turn off your computer and peripherals, and observe the caution for your personal safety and protection of the equipment described in "[Safety First—For You and Your Computer](#)."
2. If you have installed a padlock through the [padlock ring](#) on the back panel, remove the padlock.
3. Remove the computer cover as follows:
 - a. Press in on the two securing buttons until the cover is free to swing up (see [Figure 1](#)).
 - b. Raise the back of the cover, and pivot it toward the front of the computer.
 - c. Lift the cover off the hooks at the front of the chassis.

Figure 1. Removing the Small-Form-Factor Computer Cover

1 Securing buttons (2)



Front of Computer

To replace the computer cover, perform the following steps:

1. Check all cable connections, especially those that might have come loose during your work. Fold cables out of the way so that they do not catch on the computer cover. Make sure cables are not routed over the drive cage—they will prevent the cover from closing properly.
2. Check to see that no tools or extra parts (including screws) are left inside the computer's chassis.
3. Replace the computer cover as follows:
 - a. Face the front of the computer and hold the cover at a slight angle as shown in [Figure 2](#).
 - b. Align the bottom of the cover with the bottom of the chassis, and insert the three hooks on the cover into the three recessed slots on the computer chassis so that the tabs catch the hooks inside the slots.

 **NOTE:** The three hooks on the cover are located in the front at the bottom. The three recessed slots on the computer chassis are located in the front at the bottom (see [Figure 2](#)).
 - c. Pivot the cover down toward the back of the chassis and into position. Press down on the back corners of the cover until the securing buttons click into place.

Figure 2. Replacing the Small-Form-Factor Computer Cover

- 1 Securing buttons (2)
- 2 Hooks (3)
- 3 Recessed slots (3)

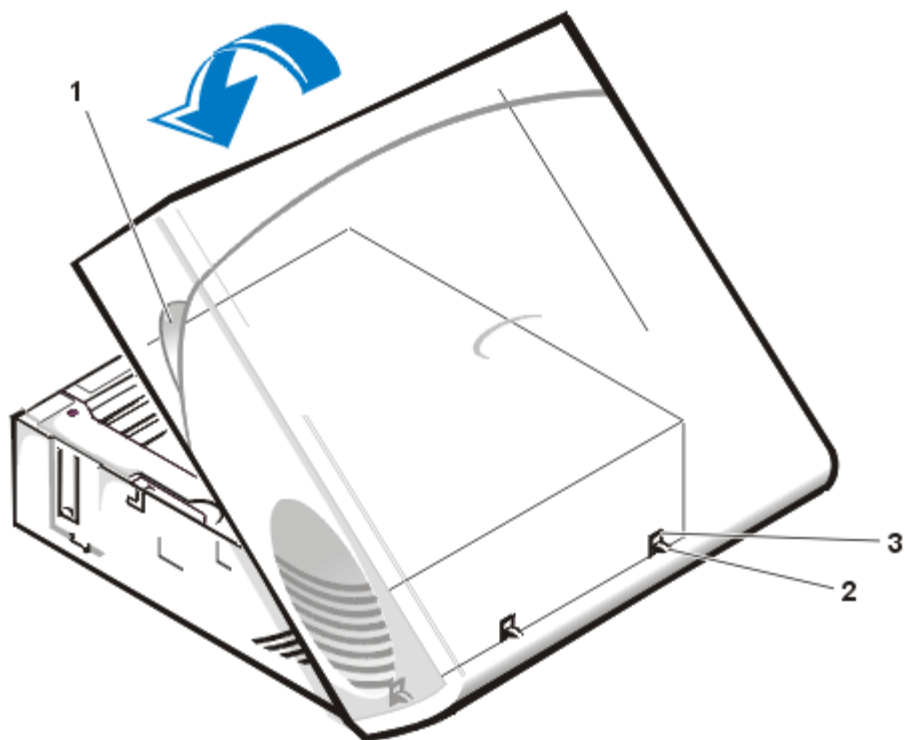

Front of Computer

4. If you are using a padlock to secure your system, reinstall the padlock.

Troubleshooting a Wet Computer

Liquids can damage your computer. While you are not likely to submerge your computer, spills, splashes, and excessive humidity can also cause damage. If an external device (such as a printer or an external drive) gets wet, contact the manufacturer for instructions. If your computer gets wet, perform the following steps:

1. Turn off the system, including any attached peripherals, and disconnect all the AC power cables from their electrical outlets. Also, disconnect any telephone or telecommunication lines from the computer.

⚠ CAUTION: Before you remove the computer cover, see "[Safety First—For You and Your Computer](#)."

2. [Remove the computer cover](#).
3. Let the computer dry for at least 24 hours.

Make sure that it is thoroughly dry before proceeding.

4. Remove all expansion cards installed in the computer except a drive controller card and video expansion card.
5. Replace the computer cover, reconnect the system to an electrical outlet, and turn it on.

If the system has power, proceed to step 6. If the system does not have power, see "[Getting Help](#)" for instructions on obtaining technical assistance.

6. Turn off the system, disconnect it from the electrical outlet, remove the computer cover, and reinstall all

expansion cards you removed in step 4.

7. Replace the computer cover, and reconnect the system to an electrical outlet. Also, reconnect any telephone or telecommunication lines to the computer.
8. Insert the *Dell ResourceCD* into the appropriate drive, reboot the system, and run the [System Set Test Group](#) in the [Dell Diagnostics](#).

If the tests complete successfully, your system is operating properly. If any of the tests fail, see "[Getting Help](#)" for instructions on obtaining technical assistance.

Troubleshooting a Damaged Computer

If your computer was dropped or damaged, you should check your computer to see if it functions properly. If an external device attached to your computer is dropped or damaged, contact the manufacturer of the device for instructions or see "[Getting Help](#)" for information on obtaining technical assistance from Dell. To troubleshoot a damaged computer, perform the following steps:

1. Turn off the system, including any attached peripherals, and disconnect all the AC power cables from their electrical outlets. Also, disconnect any telephone or telecommunication lines from the computer.



CAUTION: Before you remove the computer cover, see "[Safety First—For You and Your Computer](#)."

2. [Remove the computer cover](#).
3. Check all the expansion-card connections in the computer.
4. Verify the diskette/tape drive, hard-disk drive, and all other internal connections.

Make sure that all cables are properly connected and that all components are properly seated in their connectors and sockets.

5. [Replace the computer cover](#), reconnect the system to an electrical outlet, and reconnect any telephone or telecommunication lines.
6. Insert the *Dell ResourceCD* into the appropriate drive, reboot the system, and run the [System Set Test Group](#) in the [Dell Diagnostics](#).

If the tests complete successfully, your system is operating properly. If any of the tests fail, see "[Getting Help](#)" for instructions on obtaining technical assistance.

Troubleshooting the Battery



CAUTION: There is a danger of a new battery exploding if it is incorrectly installed. Replace the battery only with the same or equivalent type recommended by the manufacturer. Discard used batteries according to the manufacturer's instructions.

If an error message indicates a problem with the battery or if the [System Setup program](#) loses the system configuration information when the computer is turned off, the battery may be defective.

To troubleshoot the battery, perform the following steps:

1. Turn off the system, including any attached peripherals, and disconnect all the AC power cables from their electrical outlets. Also, disconnect any telephone or telecommunication lines from the computer.



CAUTION: Before you remove the computer cover, see "[Safety First—For You and Your Computer](#)."

2. [Remove the computer cover](#).

3. Reseat the battery in its socket.

The battery is a coin cell that snaps into a socket on the system board.

4. If the problem is not resolved, replace the battery.

If the problem is still not resolved, you may have a faulty system board. See "[Getting Help](#)" for instructions on obtaining technical assistance.

Troubleshooting Expansion Cards

If an error message indicates an expansion-card problem or if an expansion card seems to perform incorrectly or not at all, the problem could be a faulty connection, a conflict with software or other hardware, or a faulty expansion card. To troubleshoot expansion cards, perform the following steps:

1. Turn off the system, including any attached peripherals, and disconnect all the AC power cables from their electrical outlets. Also, disconnect any telephone or telecommunication lines from the computer.



CAUTION: Before you remove the computer cover, see "[Safety First—For You and Your Computer](#)."

2. [Remove the computer cover](#).

3. Verify that each expansion card is firmly seated in its connector. If any expansion cards are loose, reseat them.

4. Verify that any cables are firmly connected to their corresponding connectors on the expansion cards. If any cables appear loose, reconnect them.

For instructions on which cables should be attached to specific connectors on an expansion card, see the expansion card's documentation.

5. [Remove all expansion cards](#) except the video card.

6. [Replace the computer cover](#), reconnect the system to an electrical outlet, and turn it on.

7. Insert the *Dell ResourceCD* into the appropriate drive, reboot the system, and run the [RAM Test Group](#) in the [Dell Diagnostics](#).

If the tests complete successfully, proceed to step 8. If any of the tests fail, see "[Getting Help](#)" for instructions on obtaining technical assistance.

8. Turn off the system, disconnect it from the electrical outlet, and remove the computer cover.
9. Reinstall one of the expansion cards you removed previously, and repeat steps 6 and 7.

If any of the tests fail, the expansion card you just reinstalled is faulty and needs to be replaced. If the tests complete successfully, repeat steps 8 and 9 with another expansion card.

10. If you have replaced all the expansion cards removed previously and the expansion card problem is not resolved, see "[Getting Help](#)" for information on obtaining technical assistance.

Troubleshooting System Memory

A computer memory problem can be a faulty dual in-line memory module (DIMM) or a faulty system board. If a random-access memory (RAM) error message appears, the computer probably has a memory problem.

When you turn on or reboot the system, the Caps Lock and Scroll Lock indicators on the keyboard should flash momentarily and then turn off. If the [Num Lock](#) option in the System Setup program is set to **On**, the Num Lock indicator should flash momentarily and then remain on; otherwise, it should turn off. Abnormal operation of these indicators can result from a defective DIMM in socket A. Follow these steps to troubleshoot system memory:

1. Turn on the system, including any attached peripherals.



CAUTION: Before you remove the computer cover, see "[Safety First—For You and Your Computer](#)."

2. If an error message indicates invalid system configuration information, enter the [System Setup program](#) and check the [System Memory](#) option.

If the amount of memory displayed does not match the amount of memory installed, turn off the computer, disconnect it from the electrical outlet, [remove the computer cover](#), and reseal the DIMMs in their sockets.

3. [Replace the computer cover](#), reconnect the system to an electrical outlet, and turn it on.
4. If the problem is not resolved, insert the *Dell ResourceCD* into the appropriate drive, reboot the system, and run the [RAM Test Group](#) in the [Dell Diagnostics](#).

If the Dell Diagnostics identifies a faulty DIMM, [replace that DIMM](#). If the Dell Diagnostics determines that the system board is faulty or if the Dell Diagnostics does not identify the cause of the problem and the problem is still not resolved, see "[Getting Help](#)" for instructions on obtaining technical assistance.

Troubleshooting the Video Subsystem

Troubleshooting video problems involves determining which of the following is the source of the problem: the

monitor, the monitor interface cable, or the integrated video subsystem.

Before attempting to troubleshoot the video subsystem, perform the procedure found in "[Troubleshooting the Monitor](#)" to determine whether or not the monitor is the source of the problem.

If the monitor is not at fault, perform the following steps:

1. Check the [monitor cable connections](#).
2. If the problem is not resolved, insert the *Dell ResourceCD* into the appropriate drive, reboot the system, and run the [Video Test Group](#) in the [Dell Diagnostics](#).

If any of the tests fail, see "[Getting Help](#)" for instructions on obtaining technical assistance.

Troubleshooting the System Board

A system board problem can result from a defective system board component, a faulty power supply, or a defective component connected to the system board. If an error message indicates a system board problem, perform the following steps:

1. Insert the *Dell ResourceCD* into the appropriate drive, reboot the system, and run the [System Set Test Group](#) in the [Dell Diagnostics](#).

If any of the tests fail, see "[Getting Help](#)" for instructions on obtaining technical assistance.

2. Turn off the system, including any attached peripherals, and disconnect all the AC power cables from their electrical outlets. Also, disconnect any telephone or telecommunication lines from the computer.



CAUTION: Before you remove the computer cover, see "[Safety First—For You and Your Computer](#)."

3. [Remove the computer cover](#).
 4. Verify that the power cables from the power supply are firmly connected to the connectors on the system board.
 5. [Replace the computer cover](#), reconnect the system to an electrical outlet, and turn it on. If the problem is not resolved, proceed to step 6.
 6. Perform the procedure in "[Troubleshooting Expansion Cards](#)."
 7. Perform the procedure in "[Troubleshooting the Keyboard](#)."
 8. If the problem is still not resolved, see "[Getting Help](#)" for instructions on obtaining technical assistance.
-

Troubleshooting Drives

If the monitor displays a system error message to indicate a drive problem during execution of either the boot routine or the [Dell Diagnostics](#), or if a drive is not operating correctly, perform the following steps:

1. Enter the [System Setup program](#), and verify that the problem drive is configured correctly. Make any necessary changes, and reboot the system.
2. If the problem is not resolved, turn off the system, including any attached peripherals, and disconnect all the AC power cables from their electrical outlets. Also, disconnect any telephone or telecommunication lines from the computer.



CAUTION: Before you remove the computer cover, see "[Safety First—For You and Your Computer](#)."

3. [Remove the computer cover](#).
4. Verify that the power cables from the electrical outlet are firmly connected to the connectors on each drive. Also verify that the interface cable for each drive is firmly connected to the drive and to the system board.
5. [Replace the computer cover](#), reconnect the system to an electrical outlet, and turn it on.

If the problem is not resolved, proceed to step 6.

6. Insert the *Dell ResourceCD* into the appropriate drive, reboot the system, and run the appropriate test group in the [Dell Diagnostics](#).

If the Dell Diagnostics identifies a faulty drive, replace the drive. If the Dell Diagnostics identifies a faulty controller, the system board may be faulty. See "[Getting Help](#)" for instructions on obtaining technical assistance.

[Back to Contents Page](#)

[Back to Contents Page](#)

External Components: Dell™ OptiPlex™ GX1 Small-Form-Factor System User's Guide

- [Overview](#)
- [Troubleshooting the Monitor](#)
- [Troubleshooting the Keyboard](#)
- [Troubleshooting the Mouse](#)
- [Troubleshooting I/O Ports](#)
- [Troubleshooting Basic I/O Functions](#)
- [Troubleshooting a Parallel Printer](#)
- [Troubleshooting a Serial I/O Device](#)

Overview

This section provides troubleshooting procedures for equipment that connects directly to the input/output (I/O) panel of your computer, such as your monitor, keyboard, mouse, or printer. Before performing any of the procedures in this section, see "[Checking Connections and Switches](#)." Then perform the troubleshooting procedures for the equipment that is malfunctioning.

You need a copy of the *Dell ResourceCD* to perform the procedures in this section.

Troubleshooting the Monitor

Troubleshooting video problems involves determining which of the following is the source of the problem:

- Monitor or monitor interface cable
- Video controller

The procedures in this section troubleshoot problems with the monitor and the monitor interface cable only.

If information on the monitor screen is displayed incorrectly or not at all, perform each of the following steps in the order indicated until the problem is resolved:

1. Turn on the system, including any attached peripherals.
2. Adjust the switches and controls as specified in the monitor's documentation to correct the video image, including the horizontal and vertical position and size.
3. Insert the *Dell ResourceCD* into the appropriate drive, reboot the system, and run the [Video Test Group](#) in the [Dell Diagnostics](#).
4. Turn off the system and disconnect it from the electrical outlet. Swap the monitor with one of the same type that is working, and reconnect the system to an electrical outlet.
5. Reboot the system, and run the **Video Test Group** again.

If the tests complete successfully, the original monitor was faulty. If the tests still fail, the video controller on the system board may be faulty. See "[Getting Help](#)" for instructions on obtaining technical assistance.

Troubleshooting the Keyboard

This procedure determines what kind of keyboard problem you have. If a system error message indicates a keyboard problem when you start the computer system or if the keyboard does not operate as expected, perform the following steps in the order indicated until the problem is resolved:

1. If the keyboard or its cable shows signs of physical damage or if the keys do not work, replace the keyboard with a working keyboard.
2. Insert the *Dell ResourceCD* into the appropriate drive, reboot the system, and run the [Keyboard Test Group](#) in the [Dell Diagnostics](#).

If the [Keyboard Interactive Test](#) fails, replace the keyboard.

If the [Keyboard Controller Test](#) fails, the system board may be faulty. See "[Getting Help](#)" for instructions on obtaining technical assistance.

Troubleshooting the Mouse

This procedure determines what kind of mouse problem you have. If a system error message indicates a mouse problem when you start the computer system or if the mouse does not operate as expected, perform the following steps in the order indicated until the problem is resolved:

1. Clean the mouse as instructed in your mouse documentation.

Most mice have a ball that can be removed and cleaned of debris by turning the mouse upside down and removing a cover on the bottom of the mouse. Also remove any lint or other debris that has accumulated on the bottom of the mouse.

2. If the mouse or its cable shows signs of physical damage or if the buttons do not work, replace the mouse with a working mouse.
3. Insert the *Dell ResourceCD* into the appropriate drive, reboot the system, and run the [Mouse Test](#) in the [Dell Diagnostics](#).

If the **Mouse Test** fails, the system board may be faulty. See "[Getting Help](#)" for instructions on obtaining technical assistance.

Troubleshooting I/O Ports

This section provides a procedure for troubleshooting the ports on your computer's I/O panel and the equipment connected to them, such as a printer, scanner, or other peripheral device.

You can also use this procedure to test I/O ports on expansion cards. However, you should first complete the

procedures in "[Troubleshooting Expansion Cards](#)" to verify that the card is configured and installed correctly.

If a system error message indicates a port problem or if equipment connected to a port seems to perform incorrectly or not at all, the source of the problem may be any of the following:

- A faulty connection between the I/O port and the peripheral device
- A faulty cable between the I/O port and the peripheral device
- A faulty peripheral device
- Incorrect settings in the [System Setup program](#)
- Incorrect settings in the system's configuration files
- Faulty I/O port logic on the system board



NOTE: With certain modems installed, the [Serial/Infrared Port Test Group](#) subtests may fail because the modem appears to the diagnostics as a serial port, but it cannot be tested as a serial port. If you have a modem installed and you experience a serial port test failure, remove the modem and run the diagnostic tests again.

Troubleshooting Basic I/O Functions

If a system error message indicates an I/O port problem or the device connected to the port does not function properly, follow these steps in the order indicated until the problem is resolved:

1. Enter the [System Setup program](#) and verify that the settings for the **Serial Port 1**, **Serial Port 2**, and **Parallel Port** options are set to **Auto**.
2. Insert the *Dell ResourceCD* into the appropriate drive, reboot the system, and run the [Serial/Infrared Ports Test Group](#) and/or the [Parallel Ports Test Group](#) in the [Dell Diagnostics](#).

If any of the tests fail, the system board may be faulty. See "[Getting Help](#)" for instructions on obtaining technical assistance.

If the problem persists, go to "[Troubleshooting a Parallel Printer](#)" or "[Troubleshooting a Serial I/O Device](#)," depending on which device appears to be malfunctioning.

Troubleshooting a Parallel Printer

If the information in "[Troubleshooting Basic I/O Functions](#)" indicates that the problem is with a parallel printer, perform the following steps in the order indicated until the problem is resolved:

1. Reinstall the printer device driver.

See the documentation for the printer and for your operating system for instructions on reinstalling the printer driver.

2. Turn off the parallel printer and computer, replace the parallel printer interface cable with a known

working cable, and turn on the parallel printer and computer.

If the problem is resolved, the original printer cable was faulty.

3. Run the parallel printer's self-test.

If the test fails, the printer is faulty.

If the problem still is not resolved, the system board may be faulty. See "[Getting Help](#)" for instructions on obtaining technical assistance.

Troubleshooting a Serial I/O Device

If the information in "[Troubleshooting Basic I/O Functions](#)" indicates that the problem is with a device connected to one of the serial ports, perform the following steps in the order indicated until the problem is resolved:

1. Attach the serial device to the other serial port (for example, if it is currently connected to serial port 1, attach the device to serial port 2).

If the problem is resolved, the serial port on the system board is faulty. See "[Getting Help](#)" for instructions on obtaining technical assistance.

2. If the faulty device has a detachable serial cable, replace the serial cable.

If the problem is resolved, the serial cable was faulty.

3. Replace the faulty serial device.

If the problem is still not resolved, the system board may be faulty. See "[Getting Help](#)" for instructions on obtaining technical assistance.

[Back to Contents Page](#)

[Back to Contents Page](#)

Getting Help: Dell™ OptiPlex™ GX1 Small-Form-Factor System User's Guide

 [Help Overview](#)

 [Contacting Dell](#)

[Back to Contents Page](#)

[Back to Contents Page](#)

Inside Your Computer: Dell™ OptiPlex™ GX1 Small-Form-Factor System User's Guide

- [Overview](#)
- [Internal Views](#)
- [System Board Components](#)
- [System Board Jumpers](#)
- [System Board Labels](#)
- [Removing and Replacing the Expansion-Card Cage](#)

Overview

This section describes the inside of your computer and may be used as a reference before performing an upgrade procedure. Before removing the computer cover, see "[Safety First—For You and Your Computer](#)" and "[Removing and Replacing the Computer Cover](#)."

Internal Views

Figure 1 shows a side view of the small-form-factor chassis to help you orient yourself when working inside the computer.

Figure 1. Small-Form-Factor Chassis Orientation View

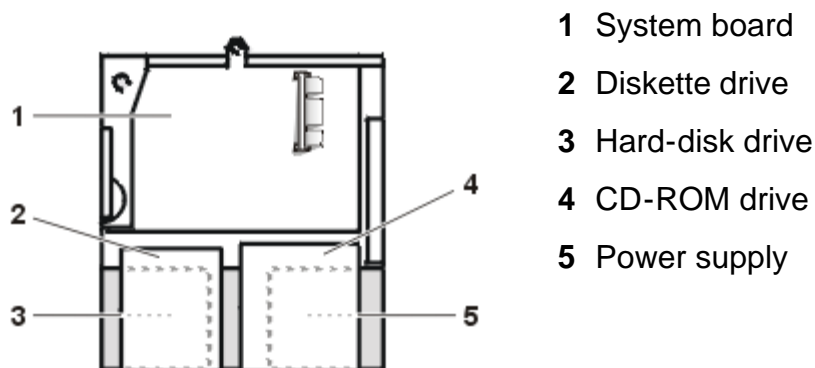
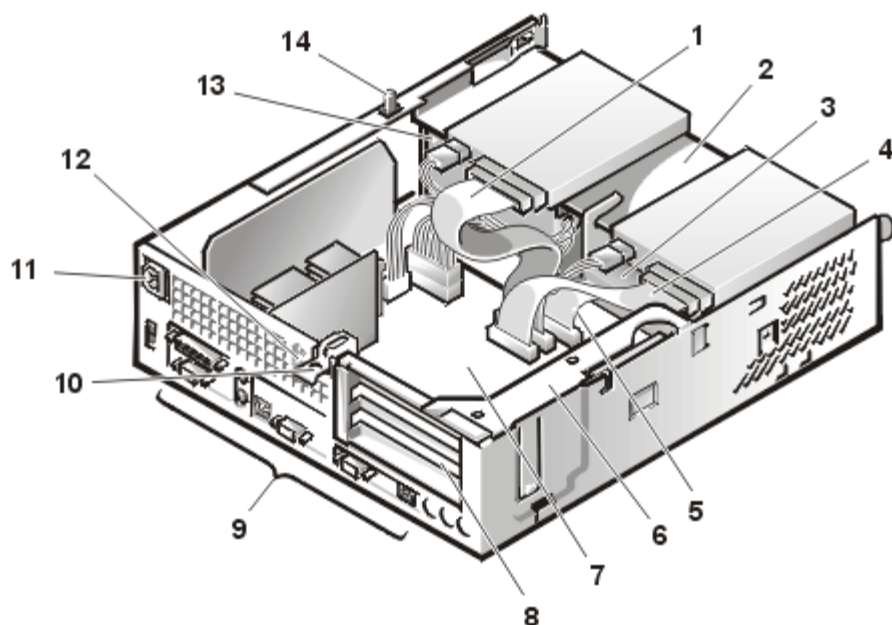

Figure 2 shows the small-form-factor chassis with the cover removed.

Figure 2. Inside the Small-Form-Factor Chassis

- 1 CD-ROM drive interface cable
- 2 Externally accessible upper bay
- 3 Hard-disk drive



- 4 Diskette-drive interface cable
- 5 Hard-disk drive interface cable
- 6 Expansion-card cage
- 7 System board
- 8 Expansion-card slots
- 9 [I/O ports and connectors](#)
- 10 Padlock ring
- 11 AC power receptacle
- 12 Security cable slot
- 13 Power supply
- 14 Chassis intrusion switch

System Board Components

Figure 3 shows the system board and the location of all its sockets and connectors.

Figure 3. System Board Components

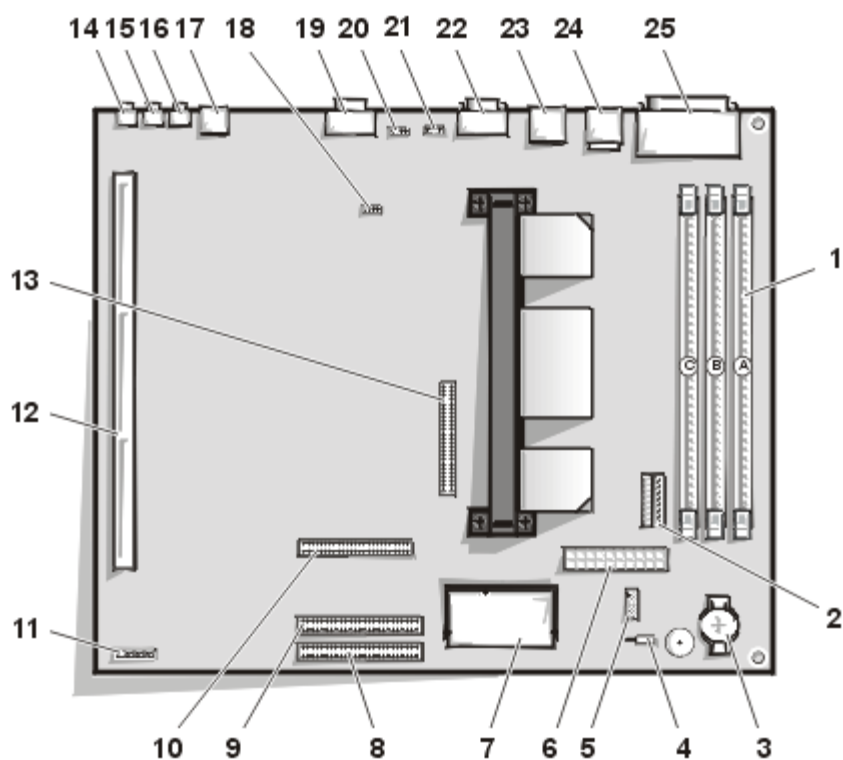

- 1 DIMM sockets (3)
- 2 3.3-V power connector
- 3 Battery socket
- 4 Chassis intrusion switch connector
- 5 Control panel connector
- 6 Main power input connector
- 7 Video-memory upgrade socket
- 8 Primary EIDE interface connector
- 9 Secondary EIDE interface connector
- 10 Diskette/tape drive interface connector
- 11 System board jumpers
- 12 Riser board connector
- 13 ATI multimedia connector
- 14 Audio line-in connector

Front of Computer

- 15 Audio line-out connector
- 16 Microphone jack
- 17 Optional integrated NIC connector
- 18 Telephony connector
- 19 Video connector
- 20 CD-in connector
- 21 Microprocessor fan connector
- 22 Serial port 2 connector
- 23 USB connectors (2)
- 24 Mouse/keyboard connector (stacked)
- 25 Parallel/serial port 1 connector (stacked)

System Board Jumpers

Figure 4 shows the layout of jumpers on the system board. [Table 1](#) lists the system board jumpers and their settings.

Figure 4. System Board Jumpers

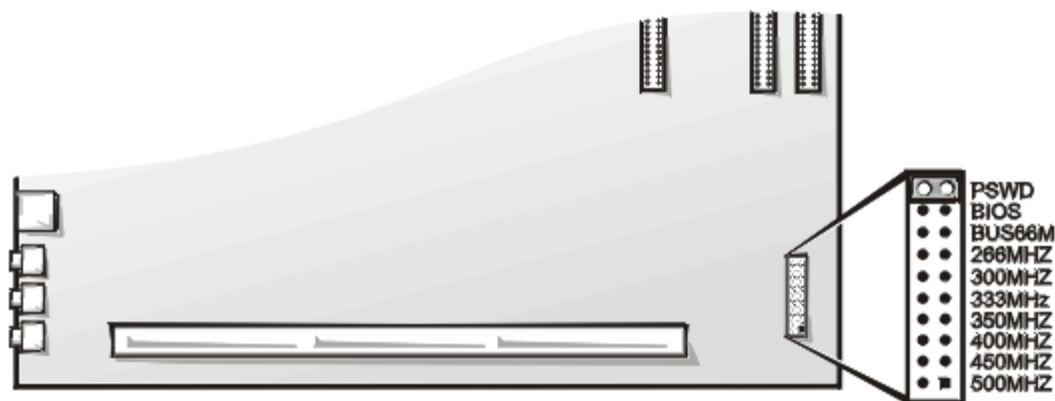











Jumpers are small blocks on a circuit board with two or more pins emerging from them. Plastic plugs containing a wire fit down over the pins. The wire connects the pins and creates a circuit.

To change a jumper setting, pull the plug off its pin(s) and carefully fit it down onto the pin(s) indicated.

NOTICE: Make sure your system is turned off and unplugged before you change a jumper setting. Otherwise, damage to your system or unpredictable results may occur.

Table 1. System-Board Jumper Settings

| Jumper | Setting | Description |
|--------|-----------------------------------------------------------------------------------------------|--------------------------------|
| PSWD |  (default) | Password features are enabled. |

| | | |
|---------|---------------------------------------------------------------------------------------------|-----------------------------------|
| |  | Password features are disabled. |
| BIOS |  (default) | Reserved (<i>do not change</i>) |
| BUS66M |  (default) | Reserved (<i>do not change</i>) |
| 266MHZ* |  (default) | Reserved (<i>do not change</i>) |
| 300MHZ* |  (default) | Reserved (<i>do not change</i>) |
| 333MHZ* |  (default) | Reserved (<i>do not change</i>) |
| 350MHZ* |  (default) | Reserved (<i>do not change</i>) |
| 400MHZ* |  (default) | Reserved (<i>do not change</i>) |
| 450MHZ* |  (default) | Reserved (<i>do not change</i>) |
| 500MHZ* |  (default) | Reserved (<i>do not change</i>) |

* *The correct microprocessor speed is automatically detected and set by the system. Do not change the settings of these jumpers.*

The system can operate with a microprocessor speed up to 600 MHz.

NOTE: For the full name of an abbreviation or acronym used in this table, see the Glossary in your online System User's Guide.

 jumpered  unjumpered

System Board Labels

Table 2 lists the labels for light-emitting diode (LED) indicators, connectors, and sockets on the system board, and it gives a brief description of their functions.

Table 2. System Board Indicators, Connectors, and Sockets

| Connector or Socket | Description |
|---------------------|------------------------------------------------|
| AMC | ATI multimedia channel |
| BATTERY | Battery socket |
| CD_IN | CD-ROM audio interface connector |
| DIMM_x | DIMM socket |
| DSKT | Diskette/tape drive interface connector |
| ENET | NIC connector (optional) |
| FAN | Microprocessor fan connector |
| HDLED | Hard-disk drive LED connector (on riser board) |
| IDE _n | EIDE interface connector |
| INTRUSION | Chassis intrusion switch connector |

| | |
|---------------|---------------------------------------------------------------|
| KYBD | Keyboard connector |
| LINE-IN | Audio line-in jack |
| LINE-OUT | Audio line-out jack |
| MIC | Microphone jack |
| MONITOR | Video connector |
| MOUSE | Mouse connector |
| P1 | Wakeup On LAN power connector (on riser board) |
| PANEL | Control panel connector |
| PARALLEL | Parallel port connector, sometimes referred to as <i>LPT1</i> |
| PCIn | PCI expansion-card connector (on riser board) |
| POWER_1 | Main power input connector |
| POWER_2 | 3.3-V power input connector |
| RISER | Riser board connector |
| SERIALn | Serial port connectors |
| SLOT1 | Microprocessor connector |
| TAPI | Telephony connector |
| USB | USB connector |
| VIDEO_UPGRADE | Video-memory upgrade socket |

Removing and Replacing the Expansion-Card Cage

To remove the expansion-card cage from the small-form-factor chassis, perform the following steps.



CAUTION: Before you remove the computer cover, see "[Safety First—For You and Your Computer.](#)"

1. [Remove the computer cover.](#)
2. Check any cables connected to expansion cards through the back-panel openings. Disconnect any cables that will not reach to where the cage must be placed upon removal from the chassis.
3. Locate the securing lever (see Figure 5). Rotate the lever upward until it stops in an upright position.

Figure 5. Removing the Expansion-Card Cage From the Small-Form-Factor Chassis

- 1 Securing lever
- 2 Expansion-card

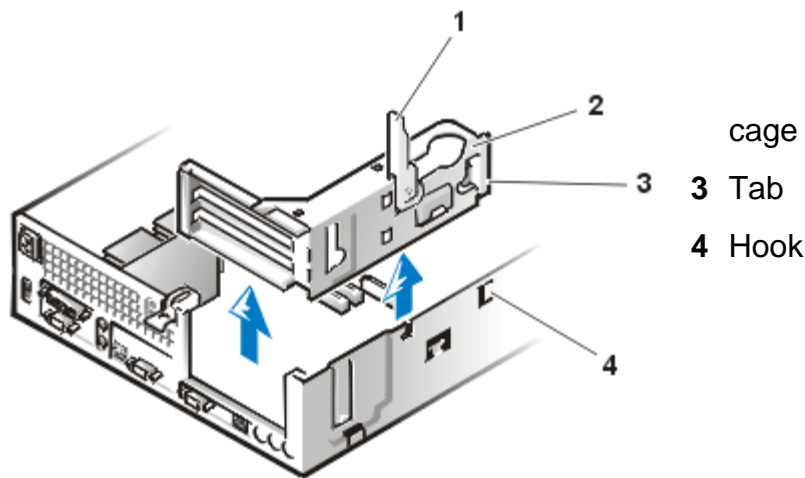

4. Slide the expansion-card cage out of the chassis.
5. Lift the expansion-card cage up and away from the chassis.

To replace the expansion-card cage in the small-form-factor chassis, perform the following steps:

1. With the securing lever in the upright position, align the slots in the left side of the expansion-card cage with the tabs on the back and bottom of the chassis (see [Figure 5](#)). Slide the expansion-card cage into place.
2. Rotate the securing lever downward until it is flush with the top side of the chassis. Make sure that the riser board is fully seated in the RISER connector on the system board.
3. Reconnect any cables you removed in [step 2](#) of the previous procedure.
4. [Replace the computer cover](#), and reconnect your computer and peripherals to their electrical outlets and turn them on.



NOTE: If Enabled, the [Chassis Intrusion](#) option will cause the following message to be displayed at the next system start-up:

ALERT! Cover was previously removed.

[Back to Contents Page](#)

[Back to Contents Page](#)

Microprocessor: Dell™ OptiPlex™ GX1 Small-Form-Factor System User's Guide

To upgrade an existing microprocessor, perform the following steps.

 **NOTE:** Dell recommends that only a technically knowledgeable person perform this procedure.

 **CAUTION:** Before you remove the computer cover, see "[Safety First—For You and Your Computer.](#)"

1. [Remove the computer cover.](#)
2. Disconnect the microprocessor fan cable from the connector (labeled "FAN") on the system board.
3. Gently pull out the guide-bracket assembly latches, grasp the microprocessor/heat sink assembly firmly, and pull straight up to remove it from the guide bracket assembly.

You must use up to 15 pounds of force to disengage the microprocessor from the connector. Do not rock the microprocessor while removing it.

4. Slide the microprocessor/heat sink assembly into the guide bracket assembly, with the heat sink toward the right side of the computer, and firmly seat the microprocessor/heat sink assembly.

You must use up to 25 pounds of force to seat the microprocessor. Do not rock the microprocessor/heat sink assembly while inserting it into the connector.

Figure 1. Microprocessor Removal

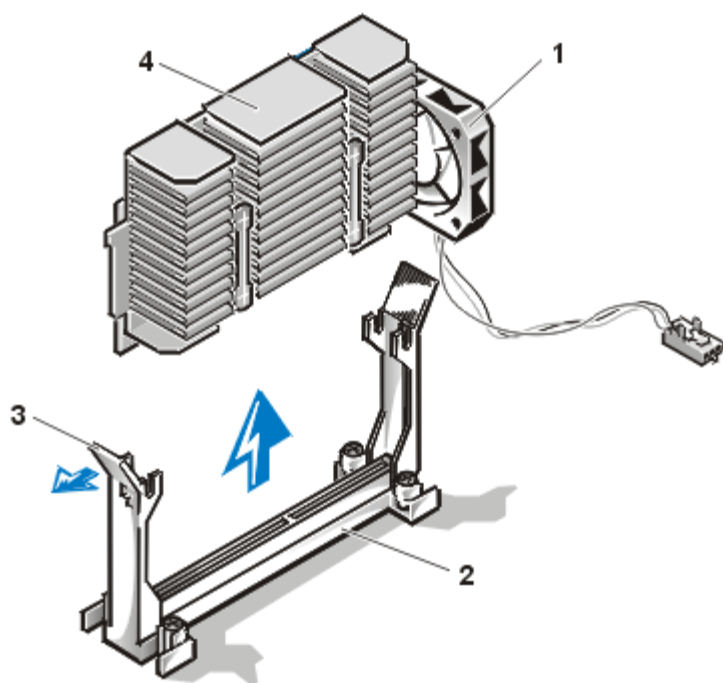

- 1 Microprocessor fan
- 2 Guide bracket assembly
- 3 Guide bracket assembly latch
- 4 Microprocessor/heat sink assembly

5. Connect the microprocessor fan cable to the connector on the system board.
6. [Replace the computer cover](#), and reconnect your computer and peripherals to their electrical outlets and turn them on.



NOTE: If Enabled, the [Chassis Intrusion](#) option will cause the following message to be displayed at the next system start-up:

ALERT! Cover was previously removed.

7. Enter the [System Setup program](#), and confirm that the top line in the system data area correctly identifies the installed processor(s).
8. Run the [Dell Diagnostics](#) to verify that the new microprocessor is operating correctly.

[Back to Contents Page](#)

[Back to Contents Page](#)

Expansion Cards: Dell™ OptiPlex™ GX1 Small-Form-Factor System User's Guide

[Overview](#)[Riser Board](#)[Installing an Expansion Card](#)[Removing an Expansion Card](#)

Overview

The OptiPlex GX1 small-form-factor chassis accommodates up to two 32-bit Peripheral Component Interconnect (PCI) half-length expansion cards. See Figure 1 for an example of a PCI expansion card.

Figure 1. 32-Bit PCI Expansion Card

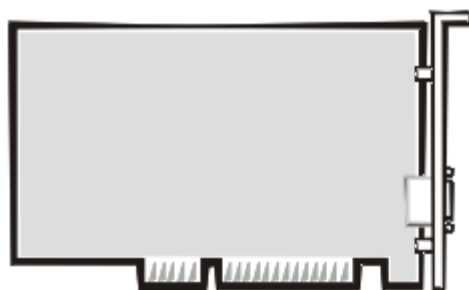

Riser Board

The small-form-factor chassis riser board has two PCI expansion-card connectors (see Figure 2).

Figure 2. Small-Form-Factor Chassis Riser Board

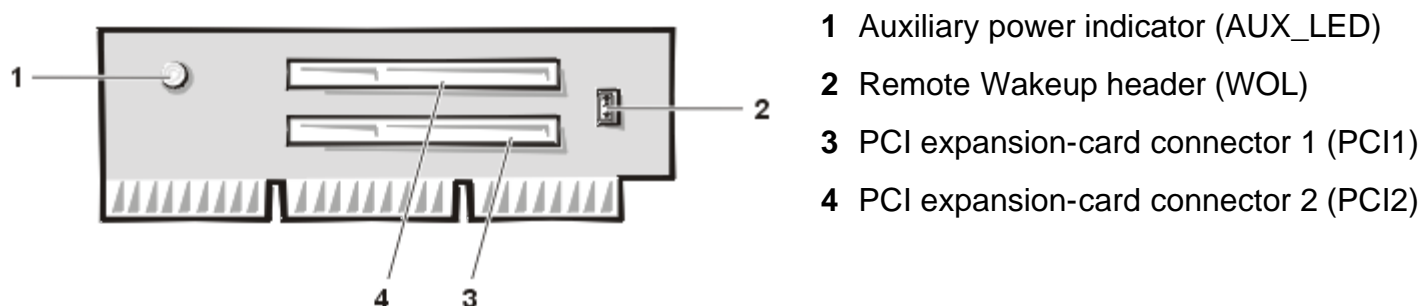

Installing an Expansion Card

To install an expansion card, perform the following steps.



CAUTION: To avoid the possibility of electric shock, turn off the computer and any peripherals,

disconnect them from electrical outlets, and then wait at least 5 seconds before you remove the computer cover. Also, before removing the computer cover, see the other precautions in "[Safety First—For You and Your Computer](#)."

1. [Remove the computer cover](#).

See the documentation that came with the expansion card for information on configuring the card, making internal connections, or otherwise customizing it for your system.

⚠ CAUTION: Some network cards automatically start up the system when they are connected. To guard against electrical shock, be sure to unplug your computer from its electrical outlet before installing any expansion cards.

2. [Remove the expansion-card cage](#).

Unscrew and remove the metal filler bracket that covers the card-slot opening for the expansion-card connector you intend to use (see Figure 3).

Save the screw to use when installing the expansion card later in this procedure.

Figure 3. Removing the Filler Bracket

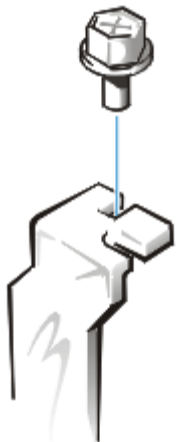

3. Insert the expansion card into the expansion-card connector.
- Insert the card's edge connector firmly into the expansion-card connector.
 - Gently rock the card into the connector until it is fully seated (see Figure 4).

Figure 4. Installing an Expansion Card

- Expansion card
- Card-edge connector
- Riser board
- Expansion-card connector

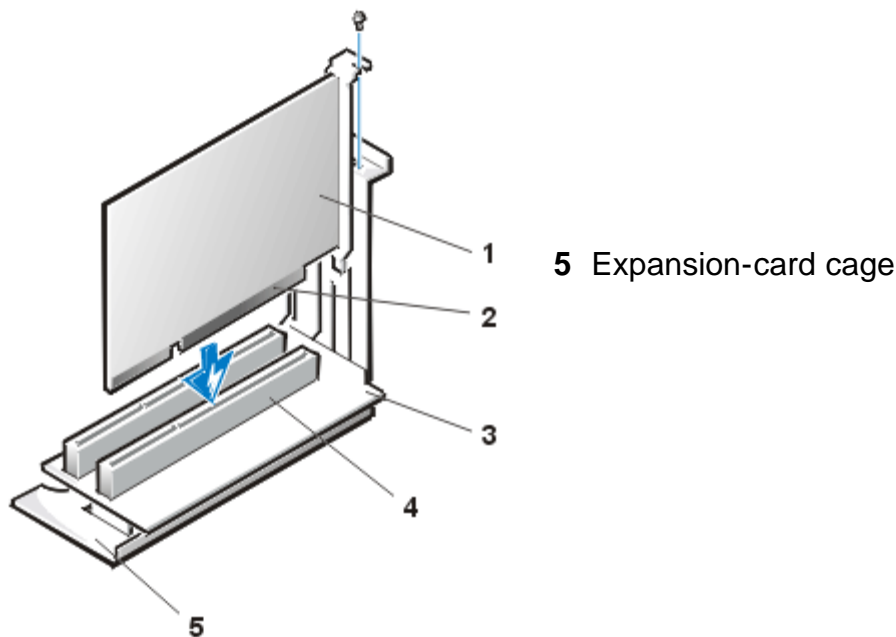

4. When the card is firmly seated in the connector, secure the card's mounting bracket to the chassis with the screw you removed in step 2.
5. Connect any cables that should be attached to the card.
See the documentation for the card for information about the card's cable connections.
6. [Replace the expansion-card cage.](#)
7. [Replace the computer cover](#), and reconnect your computer and peripherals to their electrical outlets and turn them on.



NOTE: If Enabled, the [Chassis Intrusion](#) option will cause the following message to be displayed at the next system start-up:

ALERT! Cover was previously removed.

Removing an Expansion Card

To remove an expansion card, perform the following steps.



CAUTION: To avoid the possibility of electric shock, turn off the computer and any peripherals, disconnect them from electrical outlets, and then wait at least 5 seconds before you remove the computer cover. Also, before removing the computer cover, see the other precautions in "[Safety First—For You and Your Computer.](#)"

1. [Remove the computer cover.](#)
2. If necessary, disconnect any cables connected to the card.
3. Unscrew the mounting bracket of the card you want to remove.

4. Grasp the card by its outside corners, and ease it out of its connector.
5. If you are removing the card permanently, install a metal filler bracket over the empty card-slot opening.



NOTE: You must install filler brackets over empty card-slot openings to maintain Federal Communications Commission (FCC) certification of the system. The brackets also keep dust and dirt out of your computer.

6. [Replace the computer cover](#), and reconnect your computer and peripherals to their electrical outlets and turn them on.



NOTE: If Enabled, the [Chassis Intrusion](#) option will cause the following message to be displayed at the next system start-up:

ALERT! Cover was previously removed.

[Back to Contents Page](#)

[Back to Contents Page](#)

Battery: Dell™ OptiPlex™ GX1 Small-Form-Factor System User's Guide

 [Overview](#)

 [Replacing the Battery](#)

Overview

A 3.0-volt (V) CR2032 coin-cell battery installed on the system board maintains system configuration, date, and time information in a special section of memory.

The operating life of the battery can extend up to ten years. The battery may need replacing if an incorrect time or date is displayed during the boot routine along with a message such as:

```
Time-of-day not set - please run SETUP program
```

or

```
Invalid configuration information -  
please run SETUP program
```

or

```
Strike the F1 key to continue,  
F2 to run the setup utility
```

To determine whether you need to replace the battery, reenter the time and date through the [System Setup program](#) and exit the program properly to save the information. Turn off your system and disconnect it from the electrical outlet for a few hours; then reconnect and turn on your system. Enter the System Setup program. If the date and time are not correct in the System Setup program, replace your battery.

You can operate your system without a battery; however, without a battery, the system configuration information is erased if the system is turned off or unplugged from the electrical outlet. In this case, you must enter the System Setup program and reset the configuration options.

 **CAUTION: There is a danger of the new battery exploding if it is incorrectly installed. Replace the battery only with the same or equivalent type recommended by the manufacturer. Discard used batteries according to the manufacturer's instructions.**

Replacing the Battery

To replace the system battery, perform the following steps:

1. If you have not already done so, make a copy of your system configuration information in the System Setup program.

If the settings are lost while you are replacing the battery, refer to your written or printed copy of the system configuration information to restore the correct settings. See "[Using the System Setup](#)"

[Program](#)" for instructions.

⚠ CAUTION: Before you remove the computer cover, see "[Safety First—For You and Your Computer](#)."

2. [Remove the computer cover](#).

3. Remove the battery.

See [Figure 3](#) in "Inside Your Computer" for the location of the battery.

NOTICE: If you pry the battery out of its socket with a blunt object, be careful not to touch the system board with the object. Make certain that the object is inserted between the battery and the socket before attempting to pry out the battery. Otherwise, you may damage the system board by prying off the socket or by breaking circuit traces on the system board.

Pry the battery out of its socket with your fingers or with a blunt, nonconductive object, such as a plastic screwdriver.

4. Install the new battery.

Orient the battery with the side labeled "+" facing up (see [Figure 1](#)). Then insert the battery into the socket, and snap it into place.

Figure 1. System Battery Replacement

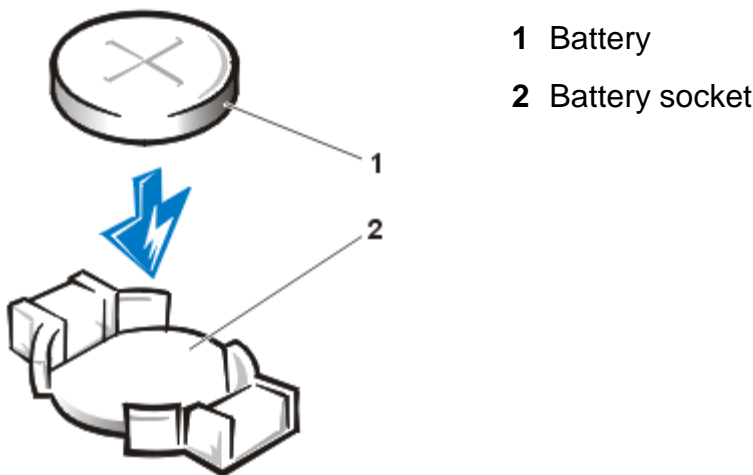

5. [Replace the computer cover](#), and reconnect your computer and peripherals to their electrical outlets and turn them on.

📝 NOTE: If Enabled, the [Chassis Intrusion](#) option will cause the following message to be displayed at the next system start-up:

ALERT! Cover was previously removed.

6. Enter the [System Setup program](#), and confirm that the battery is operating properly.

Enter the correct time and date through the System Setup program's [Time](#) and [Date](#) options. Also, use the copy you made in [step 1](#) of the preceding procedure to restore the correct settings for other system

configuration information. Then exit the System Setup program.

7. Turn off and unplug your computer.

Leave the computer turned off for at least 10 minutes.

8. After 10 minutes, plug in the computer, turn it on, and enter the System Setup program.

If the time and date are still incorrect, see "[Getting Help](#)" for instructions on obtaining technical assistance.

[Back to Contents Page](#)

[Back to Contents Page](#)

CD-ROM Drives: Dell™ OptiPlex™ GX1 Small-Form-Factor System User's Guide

[Installing a CD-ROM Drive](#)[Connecting Drives](#)

Installing a CD-ROM Drive

To install a CD-ROM drive in the slimline CD-ROM drive bay in the small-form-factor chassis, perform the following steps.

 **CAUTION:** To avoid the possibility of electric shock, turn off the computer and any peripherals, disconnect them from electrical outlets, and then wait at least 5 seconds before you remove the computer cover. Also, before removing the computer cover, see the other precautions in "[Safety First—For You and Your Computer](#)."

1. Unpack the drive and prepare it for installation.

NOTICE: To avoid the possibility of damaging the drive from electrostatic discharge (ESD), ground yourself by touching an unpainted metal surface on the back of the computer.

Check the documentation that accompanied the drive to verify that the drive is configured for your computer system. Change any settings necessary for your configuration.

2. [Remove the computer cover](#).
3. If a drive is already installed in the drive bay, remove it.

Disconnect the power cable and interface cable from the back of the drive. Push down on the drive release tab on the right side of the drive (see Figure 1), and slide the drive forward out of the chassis.

Figure 1. Removing a CD-ROM Drive

1 Drive release tab

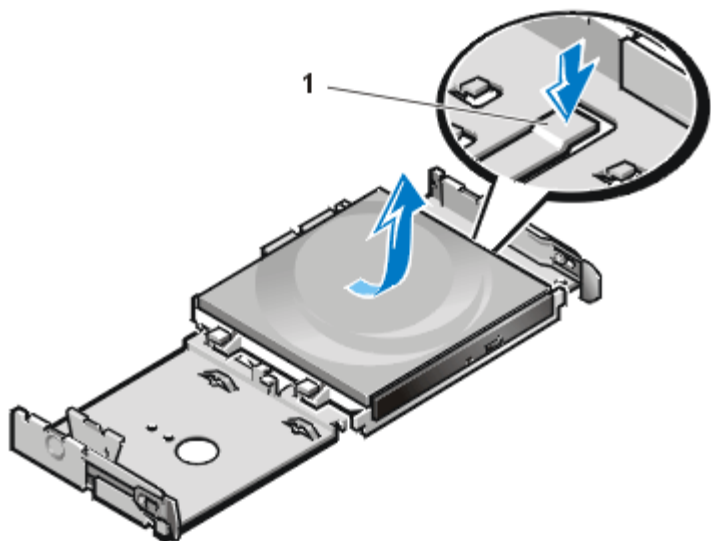

4. Install the new drive in the chassis.

Align the tabs along the bottom of the drive with the notches on the chassis, and slide the drive toward the back of the chassis until it snaps into place (see Figure 2).

Figure 2. Inserting a CD-ROM Drive

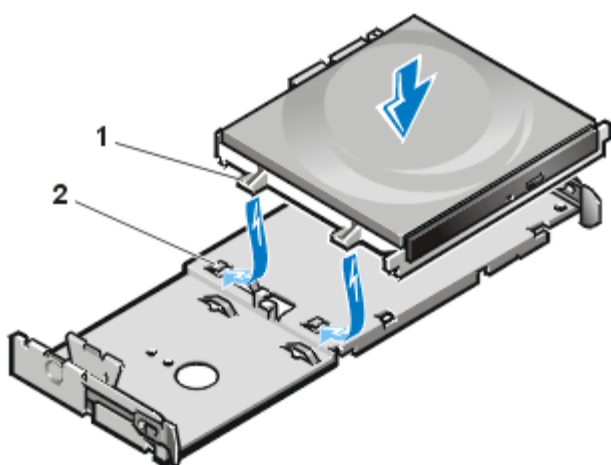

- 1 Tabs (2)
- 2 Notches (2)

5. Connect a power cable and an interface cable to the appropriate connectors on the back of the drive (see Figure 3).

Figure 3. Attaching Cables to a CD-ROM Drive

- 1 Interface cable
- 2 Power cable
- 3 Power input connector
- 4 Interface connector

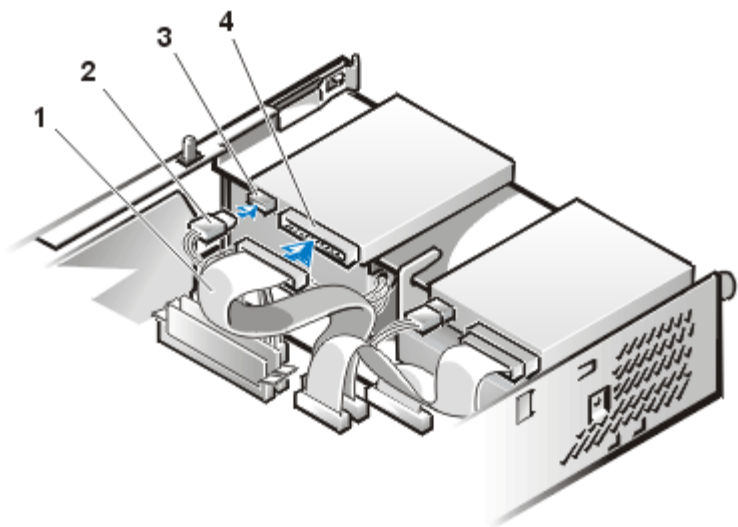

Check all cable connections. Fold cables out of the way to provide airflow for the fan and cooling vents.

6. [Replace the computer cover](#), and reconnect your computer and peripherals to their power sources and turn them on.



NOTE: If Enabled, the [Chassis Intrusion](#) option will cause the following message to be displayed at the next system start-up:

ALERT! Cover was previously removed.

7. Enter the [System Setup Program](#) and update the system configuration information.

Set the **Drive Type** option for the appropriate drive under [Drives: Primary and Secondary](#) to **Auto**.



NOTE: Tape drives attached to a small computer system interface (SCSI) host adapter card are not part of the system configuration information.

After you update the System Setup options, reboot the system.

8. Run the [Dell Diagnostics](#) to verify that the new CD-ROM drive is operating properly.

Connecting Drives

When you install a drive, you connect two cables—a DC power cable and an interface cable—to the back of the drive. Your drive's power input connector (to which you connect the DC power cable) resembles the connector shown in Figure 4.

Figure 4. Power Cable Connector

- 1 Power input connector
- 2 Power cable

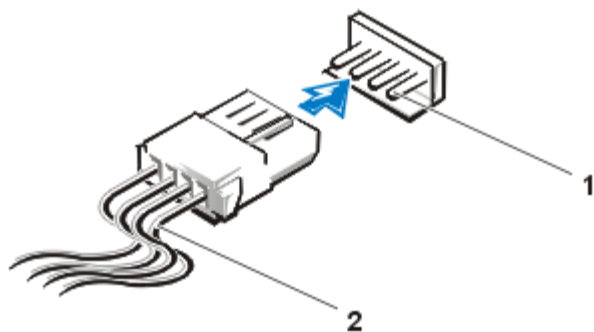

The drive's interface connector is a card-edge connector or a header connector, as shown in Figure 5.

Figure 5. Drive Interface Connectors

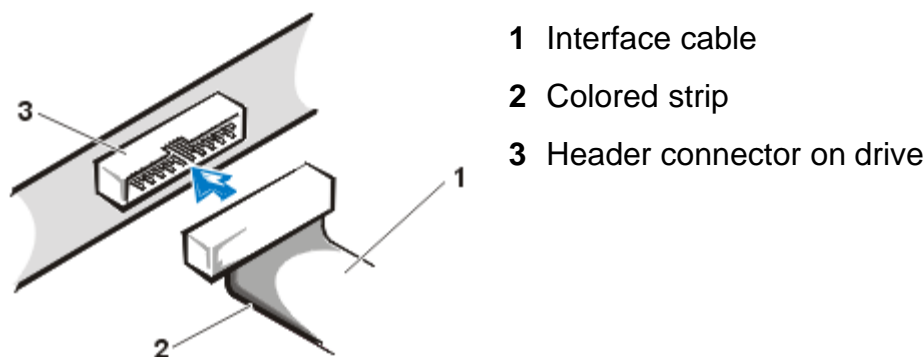

- 1 Interface cable
- 2 Colored strip
- 3 Header connector on drive

NOTICE: When you connect an interface cable, do not reverse the interface cable (do not place the colored strip away from pin 1 of the connector). Reversing the cable prevents the drive from operating and could damage the controller, the drive, or both.

When you attach the interface cable to a drive, be sure to match the colored strip on the cable to pin 1 of the drive's interface connector. For the location of pin 1 on the drive's interface connector, see the documentation that came with the drive.

When you disconnect an interface cable from the system board, be sure to press in on the locking tabs on the cable connector before you disconnect the cable. When you attach an interface cable to the system board, be sure that the locking tabs snap into place so that the cable is firmly attached to the connector on the system board.

Most interface connectors are keyed for correct insertion; that is, a notch or a missing pin on one connector matches a tab or a filled-in hole on the other connector (see Figure 5). Keyed connectors ensure that the pin-1 wire in the cable (indicated by the colored strip along one edge of the cable) goes to the pin-1 end of the connector.

The pin-1 end of a connector on a board or a card is usually indicated by a silk-screened "1" printed directly on the board or card.

[Back to Contents Page](#)

[Back to Contents Page](#)

Video Memory: Dell™ OptiPlex™ GX1 Small-Form-Factor System User's Guide

You can upgrade video memory from 4 to 8 megabytes (MB) by installing a video-memory upgrade module. Upgrading the video memory increases video performance and allows you to use video modes for application programs that require high resolutions and many colors.

To upgrade the video memory, perform the following steps.

⚠ CAUTION: To avoid the possibility of electric shock, turn off the computer and any peripherals, disconnect them from electrical outlets, and then wait at least 5 seconds before you remove the computer cover. Also, before removing the computer cover, see the other precautions in "[Safety First—For You and Your Computer](#)."

1. [Remove the computer cover](#).
2. To access the video-memory upgrade socket (labeled "VIDEO_UPGRADE") on the system board, [remove the expansion-card cage](#).
3. Orient the module as shown in [Figure 1](#). Then install it in the socket.

Video memory modules are *keyed*, or designed to fit in the socket in only one direction.

The socket on the system board is notched so that the video memory module can be firmly seated only one way.

- a. Align the video memory module's edge connector with the slot in the center of the socket.
- b. Press the video memory module's edge connector firmly into the socket.
- c. Pivot the module down until it clicks into place.
- d. If you do not hear a sharp click, you should remove the module and reinstall it.

Figure 1. Installing Video Memory

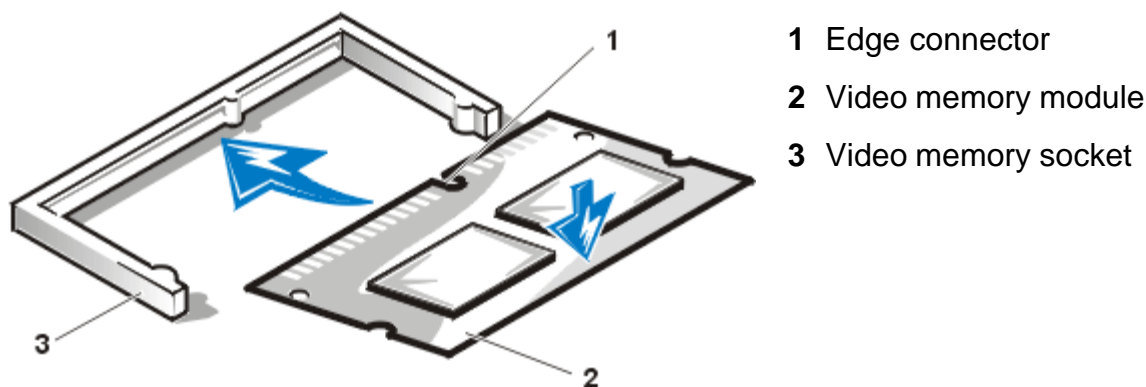

4. [Replace the expansion-card cage](#).
5. [Replace the computer cover](#), and reconnect your computer and peripherals to their electrical outlets and turn them on.



NOTE: If Enabled, the [Chassis Intrusion](#) option will cause the following message to be displayed at the next system start-up:

ALERT! Cover was previously removed.

As the system boots, it detects the presence of the new video memory and automatically changes the system configuration information in the System Setup program.

6. Enter the [System Setup program](#), and confirm that the amount of video memory displayed in the [Video Memory](#) option is 8 MB.

If the video memory total is incorrect, turn off the system, remove the computer cover, and reseal the video-memory upgrade module in its socket.

7. Run the [Dell Diagnostics](#) to verify that the new video memory is operating properly.

[Back to Contents Page](#)

[Back to Contents Page](#)

Hard-Disk Drives: Dell™ OptiPlex™ GX1 Small-Form-Factor System User's Guide

 [General Information About EIDE Hard-Disk Drives](#)

 [Installing an EIDE Hard-Disk Drive in a Small-Form-Factor Chassis](#)

General Information About EIDE Hard-Disk Drives

The small-form-factor chassis supports a single enhanced integrated drive electronics (EIDE) hard-disk drive in the hard-disk drive bay.

EIDE Drive Addressing

You must configure all EIDE devices for the Cable Select jumper position, which assigns master and slave status to devices by their position on the interface cable. When you connect two EIDE devices to a single EIDE interface cable and configure them for the Cable Select jumper position, the device attached to the last connector on the interface cable is the master or boot device (drive 0), and the device attached to the middle connector on the interface cable is the slave device (drive 1). Refer to the drive documentation in your upgrade kit for information on setting devices to the Cable Select jumper position.

With the two EIDE interface connectors on the system board, your system supports up to four EIDE devices in the mini tower chassis; the small-form-factor and low profile chassis support up to two EIDE devices. EIDE hard-disk drives should be connected to the EIDE interface connector labeled "IDE1." (Always connect EIDE tape drives and CD-ROM drives to the EIDE interface connector labeled "IDE2.")

Installing an EIDE Hard-Disk Drive in a Small-Form-Factor Chassis

To install an EIDE hard-disk drive in a small-form-factor chassis, perform the following steps.

 **CAUTION: To avoid the possibility of electric shock, turn off the computer and any peripherals, disconnect them from electrical outlets, and then wait at least 5 seconds before you remove the computer cover. Also, before removing the computer cover, see the other precautions in "[Safety First—For You and Your Computer.](#)"**

1. If you are replacing a hard-disk drive that contains data you want to keep, be sure to make a backup of your files before you continue this procedure.
2. Prepare the drive for installation.

NOTICE: Ground yourself by touching an unpainted metal surface on the back of the computer.

NOTICE: When you unpack the drive, do not set it on a hard surface, which may damage the drive. Instead, set the drive on a surface, such as a foam pad, that will sufficiently cushion it.

Check the documentation for the drive to verify that it is configured for your computer system.

3. [Remove the computer cover.](#)
4. Remove the drive shelf from the chassis.
 - a. Disconnect the power and interface cables from the diskette drive and CD-ROM drive (if any).
 - b. Press inward on the two drive shelf release tabs, and pull the shelf forward and out of the chassis (see Figure 1).

Figure 1. Removing the Drive Shelf From the Small-Form-Factor Chassis

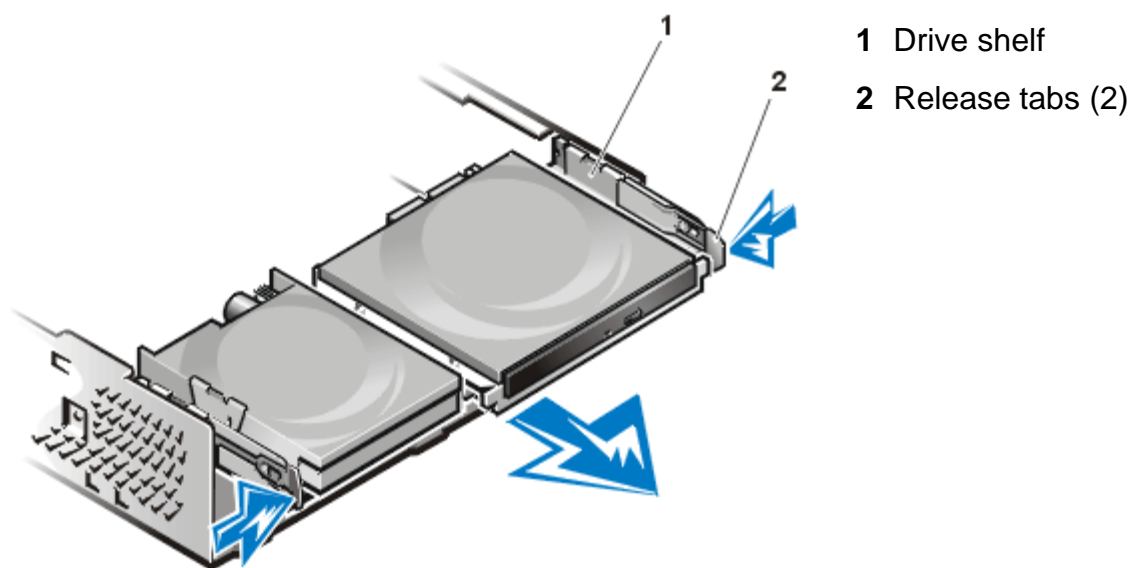

5. Remove the drive bracket from the chassis.
 - a. If a drive is already installed in the bracket, disconnect the power and interface cables from the back of the drive.
 - b. Squeeze the release tabs on each side of the drive bracket, and slide it forward about one inch (see Figure 2).

Figure 2. Removing the Hard-Disk Drive Bracket From the Small-Form-Factor Chassis

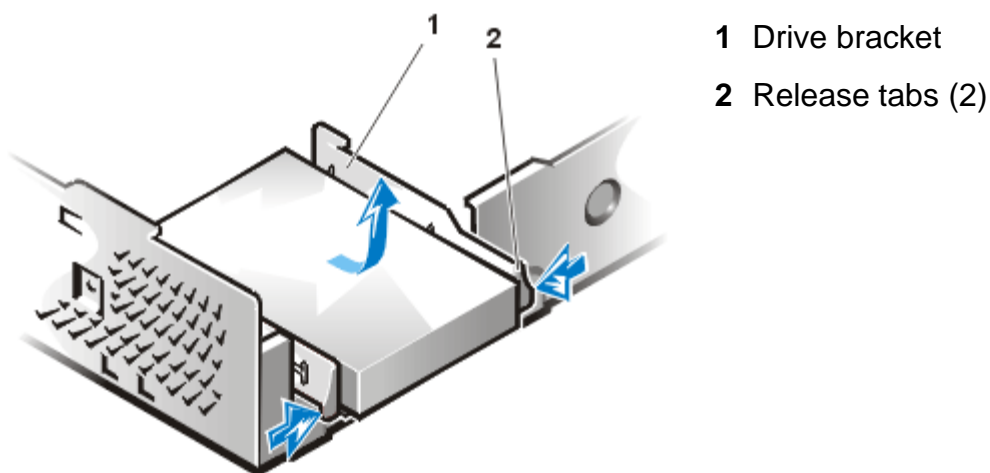

- c. Lift the drive bracket away from the chassis.
- d. If a drive is already installed in the bracket, remove the four screws securing the drive to the bottom of the bracket (see Figure 3).

Figure 3. Removing a Hard-Disk Drive From the Hard-Disk Drive Bracket

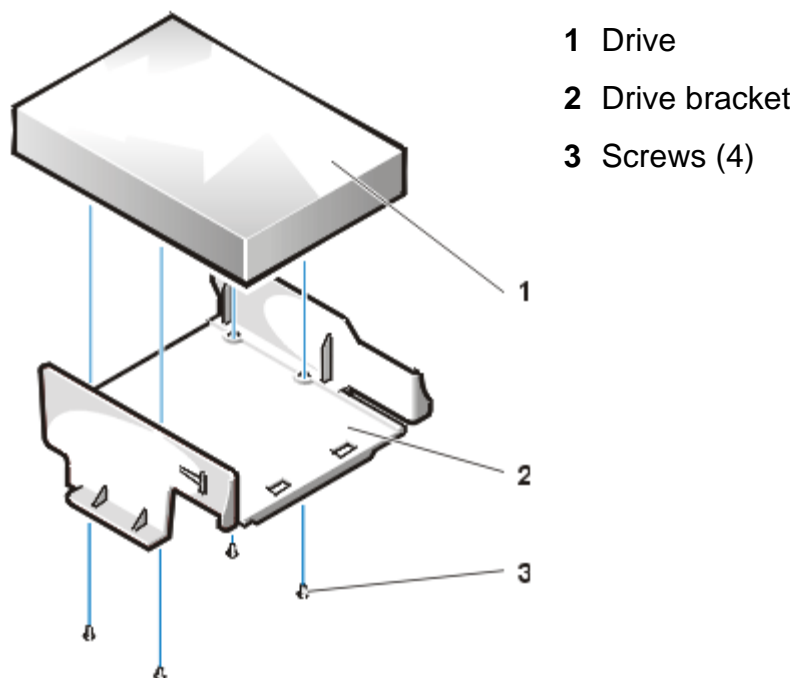

6. Secure the new drive to the drive bracket with four screws (see Figure 3).
7. Reinstall the hard-disk drive bracket in the chassis.
 - a. Place the bracket so that the release tabs extend about one inch past the front of the chassis, and align the tabs on the bottom of the bracket with the hooks on the chassis floor.
 - b. Then slide the bracket toward the back of the chassis until the tabs snap under the hooks (see Figure 4). The bracket release tabs should also snap into the front of the chassis.

Figure 4. Reinstalling the Hard-Disk Drive Bracket in the Small-Form-Factor Chassis

- 1 Tabs on bottom of drive bracket
- 2 Hooks on chassis floor
- 3 Drive bracket
- 4 Release tabs (2)

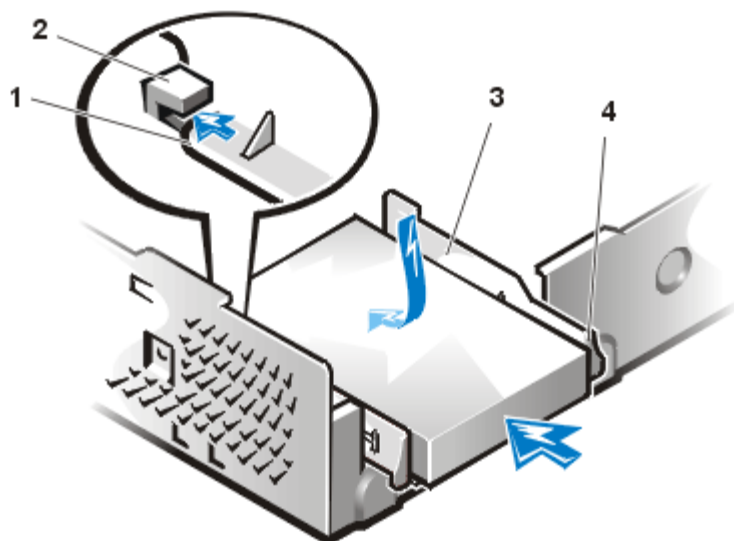

NOTICE: You must match the colored strip on the EIDE cable with pin 1 on the drive's interface connector to avoid possible damage to your system.

8. Connect a power cable to the power input connector on the back of the drive, and connect an EIDE cable to the interface connector on the back of the drive (see [Figure 5](#)).

Check all connectors to be certain that they are properly cabled and firmly seated.

Figure 5. Attaching Hard-Disk Drive Cables in the Small-Form-Factor Chassis

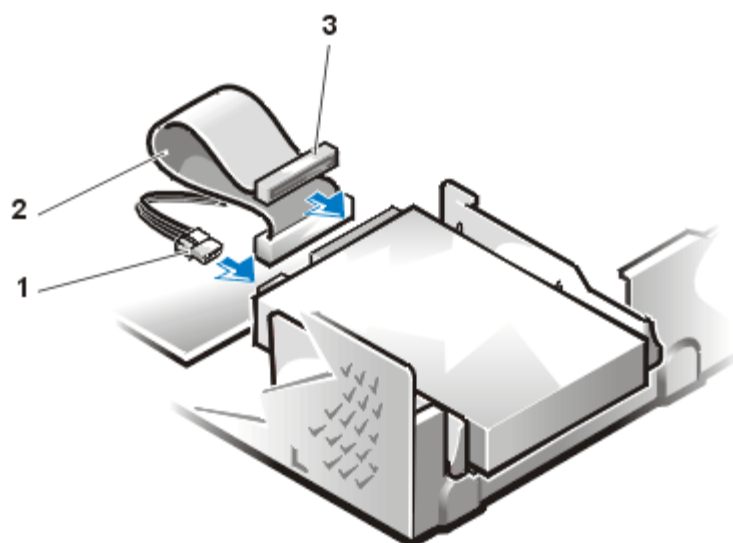

- 1 Power cable
- 2 EIDE cable
- 3 IDE1 connector

NOTICE: You must match the colored strip on the EIDE cable with pin 1 on the IDE1 connector to avoid possible damage to your system.

9. If it is not already connected, connect the other end of the EIDE cable to the IDE1 connector on the system board.

To locate the IDE1 connector on the system board, see [Figure 3](#) in "Inside Your Computer."

10. [Replace the computer cover](#), and reconnect your computer and peripherals to their power sources.
11. Turn on the peripherals connected to the computer.

12. Start the computer system.



NOTE: If the drive you just installed is the primary drive and no operating system is installed, you must start the computer using a bootable diskette or CD.

- *To boot the system from a diskette, insert a bootable diskette (such as an operating system installation or recovery diskette) into diskette drive A, and turn on the computer.*
- *To boot the system from a CD, enter the [System Setup program](#) and set the **Boot Sequence** to **CD-ROM First**. Insert a bootable CD (such as an operating system installation CD or the Dell ResourceCD) into CD-ROM drive, and turn on the computer.*



NOTE: If Enabled, the [Chassis Intrusion](#) option will cause the following message to be displayed at the next system start-up:

ALERT! Cover was previously removed.

13. Enter the [System Setup program](#) and update the [Drives: Primary and Secondary](#) options.

After you update the System Setup options, reboot the system.

14. Partition and logically format the drive before proceeding to the next step.
15. Run the Hard-Disk Drive(s) Test Group in the [Dell Diagnostics](#) to verify that the new hard-disk drive is operating properly.
16. If the drive you just installed is the primary drive, install the operating system on the hard-disk drive.

Refer to the documentation that came with the operating system.

[Back to Contents Page](#)

[Back to Contents Page](#)

Basic Checks: Dell™ OptiPlex™ GX1 Small-Form-Factor System User's Guide

- [Overview](#)
- [Backing Up Your Files](#)
- [Basic Checks](#)
- [Checking Connections and Switches](#)
- [Look and Listen](#)
- [System Setup Program](#)

Overview

If your Dell computer system is not working as expected, and if you are not sure what to do, start your troubleshooting with the procedures in this section. This section guides you through basic steps to solve basic computer problems. It also directs you to further detailed troubleshooting information and procedures to solve more complex problems.

Backing Up Your Files

If your system is behaving erratically, back up your files immediately. If your system has a tape drive installed, see the documentation that came with the tape backup software for instructions on performing a backup operation. Otherwise, see your operating system documentation for information on backing up data files.

Basic Checks

See the following sections in the order indicated until the problem is resolved:

- If your computer is wet or damaged, see "[Troubleshooting a Wet Computer](#)" or "[Troubleshooting a Damaged Computer](#)."
- Perform the steps in "[Checking Connections and Switches](#)."
- Perform the steps in "[Look and Listen](#)."
- If your system did not complete the boot (start-up) routine, see "[Getting Help](#)."



NOTE: The boot routine is the operating system's attempt to load its files into memory from the boot-up sector on the hard-disk drive or another bootable device.

- If your system displayed a message or emitted a beep code, see "[Messages and Codes](#)."
- Verify the settings in the [System Setup program](#).
- Run the [Dell Diagnostics](#).

Checking Connections and Switches

Improperly set switches and controls and loose or improperly connected cables are the most likely source of problems for your computer, monitor, or other peripheral (such as a printer, keyboard, mouse, or other external equipment).



NOTE: See "[Controls and Indicators](#)" and "[Connecting Peripheral Devices](#)" for the location of your computer's external connections and switches.

Complete the following steps in the order indicated to check all the connections and switches:

1. Turn off the system, including any attached peripherals (such as the monitor, keyboard, printer, external drives, scanners, or plotters).

Disconnect all the AC power cables from their electrical outlets.

2. If your computer is connected to a power strip, turn the power strip off and then on again. If the problem is not resolved, try another power strip or connect the system directly to an electrical outlet to see if the original power strip is faulty.
3. Connect the system to a different electrical outlet.
If doing so corrects the problem, the original outlet is faulty.
4. Reconnect the system to an electrical outlet. Make sure that all connections fit tightly together, and turn on the system.
5. If the problem is resolved, you have corrected a faulty connection.
6. If your monitor is not operating properly, see "[Troubleshooting the Monitor](#)."
7. If your keyboard is not operating properly, see "[Troubleshooting the Keyboard](#)."
8. If your mouse or printer is not operating properly, see "[Troubleshooting I/O Ports](#)." Otherwise, see "[Look and Listen](#)."

Look and Listen

Looking at and listening to your system is important in determining the source of a problem. Look and listen for the indications described in [Table 1](#).

If after looking and listening to your computer you have not resolved the problem, continue with the recommendations in "[System Setup Program](#)."

Table 1. Boot Routine Indications

| Look/Listen for: | Action |
|------------------|--------|
| | |

| | |
|--------------------------------------|------------------------------------------------------------------------------------------------------------------------------------------------------------------------------------------------------------------------------------------------------------------------------------------------------------------------------------------------------------------------------------------------------------------------------------------------------------------------------------------------------------------------------------------------------------------------------------------------------------------------------------------------------------------------------------------------------------------------------------------------------------------------------------------------------------------------------------------------------------------------------------------------------------------------------------------------------------------------------------------------------------------------------------------------------------------------------------------------------------------------------------------------------------------------------------------------------------------------------------------------------------------------------------------------------------------------------------------------------------------------------------------------------------------------------------------------------------------------------------------------------------------------------------------------------------------------------------------------------------------------------------------------------------------------------------------------------------------------------------------------------------------------------------------------------------------------------------|
| An error message | See " Messages and Codes ." |
| The monitor's power indicator | Most monitors have a power indicator (usually on the front bezel). If the monitor's power indicator does not light up, see " Troubleshooting the Monitor ." |
| The power indicator | <p>Use the power indicator to help you identify a system problem when you press the power button to turn on the computer but the system does not boot:</p> <ul style="list-style-type: none"> • A blinking yellow power indicator before power-on self-test (POST) indicates that the power supply may be faulty. In rare cases, the system board may be faulty. See "Getting Help" for instructions on getting technical assistance from Dell. • A solid yellow power indicator before POST indicates that a device on the system board may be faulty or is incorrectly installed. Be sure that the microprocessor is properly seated, remove all expansion cards, and then reboot. If the system does not boot, see "Getting Help" for instructions on getting technical assistance from Dell. • A solid green power indicator and a beep code during POST indicate that a dual in-line memory module (DIMM) may be faulty or is not properly seated. Remove all DIMMs, install only one DIMM, and then reboot. Repeat this procedure until you identify the faulty or improperly seated DIMM. • A solid green power indicator and no beep code and no video during POST indicate that the monitor or the integrated video controller may be faulty. See "Troubleshooting the Monitor." If the monitor is operating properly and is correctly connected, see "Getting Help" for instructions on getting technical assistance from Dell. • A solid green power indicator and no beep code with video during POST indicate that an integrated system board device may be faulty. See "Getting Help" for instructions on getting technical assistance from Dell. |
| The keyboard indicators | Most keyboards have one or more indicators (usually in the upper-right corner). Press the <Num Lock> key, the <Caps Lock> key, and the <Scroll Lock> key to toggle the keyboard indicators on and off. If the keyboard indicators do not light up, see " Troubleshooting the Keyboard ." |
| The diskette-drive access indicator | The diskette-drive access indicator should quickly flash on and off when you access data on the diskette drive. On a system running a Microsoft® Windows® operating system, you can test the drive by opening Windows Explorer and clicking the icon for drive A. If the diskette-drive access indicator does not light up, see " Troubleshooting Drives ." |
| The hard-disk drive access indicator | The hard-disk drive access indicator should quickly flash on and off when you access data on the hard-disk drive. On a system running a Windows operating system, you can test the drive by opening Windows Explorer and clicking the icon for drive C. If the hard-disk drive access indicator does not light up, see " Troubleshooting Drives ." |
| A series of beeps | See " Messages and Codes ." |
| An unfamiliar constant scraping | Make sure the sound is not caused by the application program you are running. The sound could be caused by a hardware malfunction. See " Getting Help " for instructions |

| | |
|-------------------------------------------|-----------------------------------------------------------------------------------------------------------------------------------------------------------------------------------------------------------------------------------------------------------------------------------------------------------|
| or grinding sound when you access a drive | on getting technical assistance from Dell. |
| The absence of a familiar sound | When you turn on your system, you can hear the hard-disk drive spin up, and the system tries to access the boot files from the hard-disk drive or the diskette drive. If your system boots, see " Dell Diagnostics ." If your system does not boot, see " Getting Help ." |

System Setup Program

You can easily correct certain system problems by verifying the correct settings in the [System Setup program](#). When you boot your system, your system checks the system configuration information and compares it with the current hardware configuration. If your system hardware configuration does not match the information recorded by the System Setup program, an error message may appear on your screen.

This problem can happen if you changed your system's hardware configuration and forgot to run the System Setup program. To correct this problem, enter the System Setup program, correct the setting for the corresponding the System Setup program option, and reboot your system.

If after checking the settings in the System Setup program you have not resolved the problem, see "[Dell Diagnostics](#)."

[Back to Contents Page](#)

[Back to Contents Page](#)

Messages and Codes: Dell™ OptiPlex™ GX1 Small-Form-Factor System User's Guide

- [Overview](#)
- [Warning Messages](#)
- [System Messages](#)
- [Diagnostics Messages](#)
- [System Beep Codes](#)

Overview

Your application programs, operating system, and the computer itself are capable of identifying problems and alerting you to them. When a problem occurs, a message may appear on your monitor screen or a beep code may sound. See "[System Messages](#)" or "[System Beep Codes](#)" for information about each message or beep code.

System Messages

If you receive a system message, see [Table 1](#) for suggestions on resolving any problems indicated by the message. The system messages are listed alphabetically.



NOTE: If the system message you received is not listed in the table, check the documentation for the application program that you were running at the time the message appeared and/or the operating system documentation for an explanation of the message and a recommended action.

Table 1. System Messages

| Message | Cause | Action |
|------------------------------|-------------------------------------------------------------------------------------------------------------|------------------------------------------------------------------------------------------------------------------------|
| Address mark not found | The basic input/output system (BIOS) found a faulty disk sector or could not find a particular disk sector. | See " Troubleshooting Drives. " |
| Attachment failed to respond | The diskette drive or hard-disk drive controller cannot send data to the associated drive. | See " Troubleshooting Drives. " |
| Bad command or file name | The command you entered does not exist or is not in the pathname you specified. | Make sure you have spelled the command correctly, placed spaces in the proper location, and used the correct pathname. |

| | | |
|----------------------------------------------------------------|---------------------------------------------------------------------------------------------------------|-------------------------------------------------------------------------------------------------------------------------------------------------------------------------------------------------------------------------------------------------------------------------------------------------------------------------------------------------------------------------------------------|
| Bad error-correction code(ECC) on disk read | The diskette drive or hard-disk drive controller detected an uncorrectable read error. | See " Troubleshooting Drives. " |
| Controller has failed | The hard-disk drive or the associated controller is defective. | See " Troubleshooting Drives. " |
| Data error | The diskette or hard-disk drive cannot read the data. | Run the ScanDisk utility in the Microsoft® Windows® operating system to check the file structure of the diskette or hard-disk drive. See your operating system documentation for more information. If you are using another operating system, run the appropriate utility to check the file structure of the diskette or hard-disk drive. See your operating system documentation. |
| Decreasing available memory | One or more dual in-line memory modules (DIMMs) may be faulty or improperly seated. | See " Troubleshooting System Memory. " |
| Diskette drive 0 seek failure Diskette drive 1 seek failure | A cable may be loose, or the system configuration information may not match the hardware configuration. | See " Troubleshooting Drives. " |
| Diskette read failure | A cable may be loose, or the diskette may be faulty. | See " Troubleshooting Drives. " |
| Diskette subsystem reset failed | The diskette drive controller may be faulty. | Run the Diskette Drive(s) Test in the Dell Diagnostics. |
| Diskette write protected | The diskette write-protect feature is activated. | Remove the diskette from drive A and move the write-protect tab to the unlocked position. |
| Drive not ready | No diskette is in the drive. The operation requires a diskette in the drive before it can continue. | Put a diskette in the drive or close the drive latch. |
| Gate A20 failure | One or more DIMMs may be loose. | See " Troubleshooting System Memory. " |
| General failure | The operating system is | This message is usually followed |

| | | |
|--------------------------------------------------------------------------------------------------------------------------------------------|----------------------------------------------------------------------------------------------------------------------------------------------------------------------------------------------------------------------------------|--------------------------------------------------------------------------------------------------------------------------------------------------------------------------------------------------------------------------------------------------------------------------------------------------------------------------------------------|
| | unable to carry out the command. | by specific information—for example, PRINTER OUT OF PAPER. Respond by taking the appropriate action. |
| Hard disk configuration error | The hard-disk drive failed initialization. | See " Troubleshooting Drives. " |
| Hard disk controller failure Hard disk failure Hard-disk drive read failure | The hard-disk drive failed initialization. | See " Troubleshooting Drives. " |
| Incompatible Processor: CPU0 is B0 step or below! Incompatible Processor: CPU1 is B0 step or below! | An old, unsupported version of the microprocessor is installed. In a single-microprocessor system, CPU0 refers to the primary microprocessor; in a dual-microprocessor system, it refers to the secondary microprocessor. | Replace the indicated microprocessor with a current version of the microprocessor. If you need technical assistance, see " Getting Help. " <i>NOTE: These messages indicate a fatal error. When a fatal error occurs, the system usually cannot be rebooted until an appropriate hardware change has been made.</i> |
| Incompatible Processors: Cache sizes different! | This message appears for a dual-processor system if both processors do not have the same-size level-2 cache. | Replace one of the microprocessors to make the level-2 cache sizes match. If you need technical assistance, see " Getting Help. " <i>NOTE: This message indicates a fatal error. When a fatal error occurs, the system usually cannot be rebooted until an appropriate hardware change has been made.</i> |
| Invalid configuration information - please run SETUP program | The system configuration information does not match the hardware configuration. | Enter the System Setup program and correct the system configuration information. |
| Keyboard clock line failure Keyboard controller failure Keyboard data line failure Keyboard failure Keyboard stuck key failure | A cable or connector may be loose, or the keyboard or keyboard/mouse controller may be faulty. | See " Troubleshooting the Keyboard. " |

| | | |
|-----------------------------------------------------------------------------------------------------------------------------------------------------------------------------------------------------------------------------------------------------------------------------------------------------------------------------------------------------------------------------------------------|-----------------------------------------------------------------------------------------------------------------------------------|----------------------------------------------------------------------------------------------------------------------------------------------------------------------------------------------------------------------------------------------------------------------------------------------------|
| <p>Memory address line failure at <i>address</i>, read <i>value</i> expecting <i>value</i></p> | <p>One or more DIMMs may be faulty or improperly seated.</p> | <p>See "Troubleshooting System Memory."</p> |
| <p>Memory allocation error</p> | <p>The software you are attempting to run is conflicting with the operating system or another application program or utility.</p> | <p>Turn off the computer, wait 30 seconds, and then turn it on. Try to run the program again. If the problem persists, contact the software company.</p> |
| <p>Memory data line failure at <i>address</i>, read <i>value</i> expecting <i>value</i></p> <p>Memory double word logic failure at <i>address</i>, read <i>value</i> expecting <i>value</i></p> <p>Memory odd/even logic failure at <i>address</i>, read <i>value</i> expecting <i>value</i></p> <p>Memory write/read failure at <i>address</i>, read <i>value</i> expecting <i>value</i></p> | <p>One or more DIMMs may be faulty or improperly seated.</p> | <p>See "Troubleshooting System Memory."</p> |
| <p>Memory size in CMOS invalid</p> | <p>The amount of memory recorded in the system configuration information does not match the memory installed in the computer.</p> | <p>Reboot the computer. If the error appears again, see "Getting Help" for instructions on obtaining technical assistance.</p> |
| <p>Memory tests terminated by keystroke</p> | <p>The memory test did not complete.</p> | <p>Rerun the memory test.</p> |
| <p>No boot device available</p> | <p>The computer cannot find the diskette or hard-disk drive.</p> | <p>Enter the System Setup program, check the system configuration information for the diskette and hard-disk drive, and if necessary, correct the information.</p> |
| <p>No boot sector on hard-disk drive</p> | <p>The system configuration information in System Setup may be incorrect, or the operating system may be corrupted.</p> | <p>Enter the System Setup program, check the system configuration information for the hard-disk drive, and if necessary, correct the information.</p> <p>If the message persists, reinstall your operating system. See the documentation that came with your operating system.</p> |
| <p>No timer tick interrupt</p> | <p>A chip on the system board might be malfunctioning.</p> | <p>Run the System Set Test Group in the Dell Diagnostics.</p> |

| | | |
|--------------------------------------------------|---------------------------------------------------------------------------------------------------------------------------------------------------------------------------------------|-------------------------------------------------------------------------------------------------------------------------------------------------------------------------------------------------------------------------------------------------------------------------------------------------------------------------------------------|
| <p>Non-system disk or disk error</p> | <p>The diskette in drive A or your hard-disk drive does not have a bootable operating system installed on it.</p> | <p>A nonbootable diskette is in drive A. Either replace the diskette with one that has a bootable operating system, or remove the diskette from drive A and restart the computer.</p> |
| <p>Not a boot diskette</p> | <p>There is no operating system on the diskette.</p> | <p>Boot the computer with a diskette that contains an operating system.</p> |
| <p>Plug and Play Configuration Error</p> | <p>The system has encountered a problem in trying to configure one or more expansion cards.</p> | <p>Turn your system off and unplug it. Remove all but one of the cards. Plug in your system and reboot it. If the message persists, the expansion card may be malfunctioning. If the message does not appear, turn off the power and reinsert one of the other cards. Repeat this process until you identify the malfunctioning card.</p> |
| <p>Read fault Requested sector not found</p> | <p>The operating system cannot read from the diskette or hard-disk drive.</p> <p>The system could not find a particular sector on the disk, or the requested sector is defective.</p> | <p>See "Troubleshooting Drives."</p> |
| <p>Reset failed</p> | <p>The disk reset operation failed.</p> | <p>See "Troubleshooting Drives."</p> |
| <p>Sector not found</p> | <p>The operating system is unable to locate a sector on the diskette or hard-disk drive.</p> | <p>See "Troubleshooting Drives."</p> |
| <p>Seek error</p> | <p>The operating system is unable to find a specific track on the diskette or hard-disk drive.</p> | <p>If the error is on the diskette drive, try another diskette in the drive.</p> |
| <p>Shutdown failure</p> | <p>A chip on the system board might be malfunctioning.</p> | <p>Run the System Set Test Group in the Dell Diagnostics.</p> |
| <p>Time-of-day clock stopped</p> | <p>The battery may be dead.</p> | <p>Enter the System Setup program and correct the date or time.</p> <p>If the problem persists, see</p> |

| | | |
|-------------------------------------------------------------------------------------------------------------------------------------------------------------------------------------------------------------------------------------------------------------------------------------------------------------|------------------------------------------------------------------------------------------------------------------------------------------------------------------------------------------------------------------------------------------------------------------|--------------------------------------------------------------------------------------------------------------------------------------------------------------------------------------------------------------------------------------------------------------------------------------------------------------------------------------------------------------------------------------------------------------------------------------------------------------|
| | | "Troubleshooting the Battery." |
| Time-of-day not set | The time or date displayed in the system configuration information does not match the system clock. | Enter the System Setup program and correct the date or time. |
| Timer chip counter 2 failed | A chip on the system board might be malfunctioning. | Run the System Set Test Group in the Dell Diagnostics. |
| Unexpected interrupt in protected mode | The keyboard controller may be malfunctioning, or one or more DIMMs may be loose. | Run the RAM Test Group and the Keyboard Controller Test in the Dell Diagnostics. |
| WARNING: Dell's Disk Monitoring System has detected that drive [0/1] on the [primary/secondary] EIDE controller is operating outside of normal specifications. It is advisable to immediately back up your data and replace your hard-disk drive by calling your support desk or Dell Computer Corporation. | Power-on self-test (POST) has queried the enhanced integrated drive electronics (EIDE) drive for status information. The drive has returned a parameter from the call that indicates it has detected possible error conditions for its operating specifications. | Once your computer finishes booting, immediately back up your data and replace your hard-disk drive. Restore the data to the replaced drive. If a replacement drive is not immediately available and the drive is not the only bootable drive, enter the System Setup program and change the appropriate drive setting to None . Remove the drive from the system. This should be done only after you have backed up the data. |
| Write fault Write fault on selected drive | The operating system cannot write to the diskette or hard-disk drive. | See " Troubleshooting Drives. " |

System Beep Codes

When errors occur during a boot routine that cannot be reported on the monitor, your computer may emit a series of beeps that identify the problem. The beep code is a pattern of sounds: for example, one beep, followed by a second beep, and then a burst of three beeps (code 1-1-3) means that the computer was unable to read the data in nonvolatile random-access memory (NVRAM). This information is invaluable to the Dell support staff if you need to call for technical assistance.

When a beep code is emitted, write it down on a copy of the [Diagnostics Checklist](#) found in "Getting Help," and then look it up in Table 2. If you are unable to resolve the problem by looking up the meaning of the beep code, use the [Dell Diagnostics](#) to identify a more serious cause. If you are still unable to resolve the problem, see "[Getting Help](#)" for instructions on obtaining technical assistance.

Table 2. System Beep Codes

| Code | Cause | Action |
|---------------------|---------------------------------------------------|-------------------------------------------------------------------------------------------------------------------------------------------------------------------------------|
| 1-1-2 | Microprocessor register failure | See " Getting Help " for instructions on obtaining technical assistance. |
| 1-1-3 | NVRAM | Run the System Set Test Group in the Dell Diagnostics. |
| 1-1-4 | ROM BIOS checksum failure | Run the System Set Test Group in the Dell Diagnostics, if possible. |
| 1-2-1 | Programmable interval timer | Run the System Set Test Group in the Dell Diagnostics, if possible. |
| 1-2-2 | Direct memory access (DMA) initialization failure | Run the System Set Test Group in the Dell Diagnostics, if possible. |
| 1-2-3 | DMA page register read/write failure | Run the System Set Test Group in the Dell Diagnostics, if possible. |
| 1-3 | Video Memory Test failure | Run the Video Test Group in the Dell Diagnostics. |
| 1-3-1 through 2-4-4 | DIMMs not being properly identified or used | See " Troubleshooting System Memory ." |
| 3-1-1 | Slave DMA register failure | Run the System Set Test Group in the Dell Diagnostics, if possible. |
| 3-1-2 | Master DMA register failure | Run the System Set Test Group in the Dell Diagnostics, if possible. |
| 3-1-3 | Master interrupt mask register failure | See " Getting Help " for instructions on obtaining technical assistance. |
| 3-1-4 | Slave interrupt mask register failure | See " Getting Help " for instructions on obtaining technical assistance. |
| 3-2-2 | Interrupt vector loading failure | See " Getting Help " for instructions on obtaining technical assistance. |
| 3-2-4 | Keyboard Controller Test failure | Run the Keyboard Controller Test in the Dell Diagnostics. Otherwise, see " Getting Help " for instructions on obtaining technical assistance. |
| 3-3-1 | NVRAM power loss | Run the System Set Test Group in the Dell Diagnostics, if possible. |
| 3-3-2 | NVRAM configuration | Run the System Set Test Group in the Dell Diagnostics, if possible. |
| 3-3-4 | Video Memory Test failure | Run the Video Test Group in the Dell Diagnostics. |
| 3-4-1 | Screen initialization failure | Run the Video Test Group in the Dell Diagnostics. |

| | | |
|-------|------------------------------------------------|-------------------------------------------------------------------------------------------------------------------------------------|
| 3-4-2 | Screen retrace failure | Run the Video Test Group in the Dell Diagnostics. |
| 3-4-3 | Search for video ROM failure | Run the Video Test Group in the Dell Diagnostics. |
| 4-2-1 | No time tick | See " Getting Help " for instructions on obtaining technical assistance. |
| 4-2-2 | Shutdown failure | See " Getting Help " for instructions on obtaining technical assistance. |
| 4-2-3 | Gate A20 failure | See " Getting Help " for instructions on obtaining technical assistance. |
| 4-2-4 | Unexpected interrupt in protected mode | See " Getting Help " for instructions on obtaining technical assistance. |
| 4-3-1 | Memory failure above address 0FFFFh | Run the RAM Test Group in the Dell Diagnostics. |
| 4-3-3 | Timer-chip counter 2 failure | See " Getting Help " for instructions on obtaining technical assistance. |
| 4-3-4 | Time-of-day clock stopped | See " Getting Help " for instructions on obtaining technical assistance. |
| 4-4-1 | Serial or parallel port test failure | Run the Serial/Infrared Ports Test Group and the Parallel Ports Test Group in the Dell Diagnostics. |
| 4-4-2 | Failure to decompress code to shadowed memory. | Run the System Set Test Group in the Dell Diagnostics. |
| 4-4-3 | Math-coprocessor test failure | Run the System Set Test Group in the Dell Diagnostics. |
| 4-4-4 | Cache test failure | Run the System Set Test Group in the Dell Diagnostics. |

Warning Messages

A warning message alerts you to a possible problem and asks you to do something before execution continues. For example, before you format a diskette, a message may warn you that you may lose all data on the diskette as a way to protect against inadvertently erasing or writing over the data. These warning messages usually interrupt the procedure and require you to respond by typing a *y* (yes) or *n* (no).



NOTE: Warning messages are generated by either your application programs or your operating system. See "[Software Checks](#)" and the documentation that accompanied your operating system and application programs.

Diagnostics Messages

When you run a test group or subtest in the [Dell Diagnostics](#), an error message may result. These particular error messages are not covered in this section. Record the message on a copy of the [Diagnostics Checklist](#). Also see "[Getting Help](#)" for instructions on obtaining technical assistance.

[Back to Contents Page](#)

[Back to Contents Page](#)

Software Checks: Dell™ OptiPlex™ GX1 Small-Form-Factor System User's Guide

- [Overview](#)
 - [Installing and Configuring Software](#)
 - [Error Messages](#)
 - [Input Errors](#)
 - [Memory-Resident Programs](#)
 - [Program Conflicts](#)
 - [Memory Address Conflicts](#)
 - [Interrupt Assignment Conflicts](#)
-

Overview

Because most computers have several application programs installed in addition to the operating system, isolating a software problem can be confusing. Software errors can also appear to be hardware malfunctions at first. Software problems can result from the following circumstances:

- Improper installation or configuration of a program
- Input errors
- Device drivers that conflict with certain application programs
- Memory conflicts resulting from the use of terminate-and-stay-resident (TSR) programs
- Interrupt conflicts between devices

You can confirm that a computer problem is caused by software by running the [System Set Test Group](#) in the [Dell Diagnostics](#). If all tests in the test group complete successfully, the error condition is most likely caused by software.

This section provides some general guidelines for analyzing software problems. For detailed troubleshooting information on a particular program, see the documentation that accompanied the software or consult the support service for the software.

Installing and Configuring Software

When you obtain software, check it for viruses with virus-scanning software before installing it on your computer's hard-disk drive. Viruses, which are pieces of code that can replicate themselves, can quickly use all available system memory, damage or destroy data stored on the hard-disk drive, and permanently affect the performance of the programs they infect. Several commercial virus-scanning programs are available for purchase, and most bulletin board services (BBSs) archive freely distributed virus-scanning programs that you can download with a modem.

Before you install a program, read its documentation to learn how the program works, what hardware it

requires, and what its defaults are. A program usually includes installation instructions in its accompanying documentation and a software installation routine on its program diskette(s) or CD(s).

The software installation routine assists you in transferring the appropriate program files to your computer's hard-disk drive. Installation instructions may provide details about how to configure your operating system to successfully run the program. Always read the installation instructions before running a program's installation routine. You may be instructed to modify some operating system start-up files, such as **config.sys** and **autoexec.bat**, or the installation routine may modify start-up files automatically.

When you run the installation routine, be prepared to respond to prompts for information about how your computer's operating system is configured, what type of computer you have, and what peripherals are connected to your computer.

Error Messages

Error messages can be produced by an application program, the operating system, or the computer. "[Messages and Codes](#)" discusses the error messages that are generated by the system. If you receive an error message that is not listed in "Messages and Codes," check your operating system or application program documentation.

Input Errors

If a specific key or set of keys is pressed at the wrong time, a program may give you unexpected results. See the documentation that came with your application program to make sure the values or characters you are entering are valid.

Make sure the operating environment is set up to accommodate the programs you use. Keep in mind that whenever you change the parameters of the computer's operating environment, you may affect the successful operation of your programs. Sometimes, after modifying the operating environment, you may need to reinstall a program that no longer runs properly.

Memory-Resident Programs

There are a variety of utilities and supplementary programs that can be loaded either when the computer boots or from an operating system prompt. These programs are designed to stay resident in system memory and thus always be available for use. Because they remain in the computer's memory, memory conflicts and errors can result when other programs require use of all or part of the memory already occupied by these TSR programs.

Typically, your operating system's start-up files (such as **config.sys** and **autoexec.bat**) contain commands to start TSR programs when you boot your system. If you suspect that one of these TSR programs is causing a memory conflict, remove the commands that start them from the start-up file. If the problem you were experiencing does not recur, one of the TSR programs probably created the conflict. Add the TSR commands back into the start-up files one at a time until you identify which TSR program is creating the conflict.

Program Conflicts

Some programs may leave portions of their setup information behind, even though you have exited from them. As a result, other programs cannot run. Rebooting your system can confirm whether or not these programs are the cause of the problem.

Programs that use specialized subroutines called *device drivers* can also cause problems with your computer system. For example, a variation in the way the data is sent to the monitor may require a special screen driver program that expects a certain kind of video mode or monitor. In such cases, you may have to develop an alternative method of running that particular program—the creation of a boot file made especially for that program, for example. Call the support service for the software you are using to help you with this problem.

Memory Address Conflicts

Memory address conflicts occur when two or more devices try to access the same address in the upper memory blocks (UMB). For example, if a network expansion card and an expanded-memory page frame are assigned an overlapping block of addresses, a memory address conflict arises. As a result, when you try to log in to the network, the operation fails.

To resolve this type of conflict, you can change the address of one of the devices. For example, in the case of the network expansion card and expanded-memory page-frame address conflict, you can move the network card to an address block in the range of CC000h through D0000h. To reassign the expansion card's address block, refer to the documentation for the card.

Interrupt Assignment Conflicts

Problems can arise if two devices attempt to use the same interrupt request (IRQ) line. To avoid this type of conflict, check the documentation for the default IRQ-line setting for each installed expansion card. Then consult [Table 1](#) to configure the card for one of the available IRQ lines.



NOTE: Table 1 lists default IRQ settings. In systems with Plug and Play capabilities, you can modify the default settings. If you install a Plug and Play card in a Plug and Play system, the system automatically selects an open IRQ line if any are available. If you install a non-Plug and Play or legacy card, you may need to run the ISA Configuration Utility to determine the current IRQ settings and to find an available IRQ line.

Table 1. Default IRQ Line Assignments

| IRQ Line | Used/Available |
|----------|---------------------------------------------------------------|
| IRQ0 | Used by the system timer |
| IRQ1 | Used by the keyboard to signal that the output buffer is full |
| IRQ2 | Used by interrupt controller 1 to enable IRQ8 through IRQ15 |
| IRQ3 | Used by serial port 2 |
| IRQ4 | Used by serial port 1 |
| IRQ5 | Available |
| | |

| | |
|-------|-------------------------------------------------------------------|
| IRQ6 | Used by the diskette/tape drive controller |
| IRQ7 | Used by the parallel port |
| IRQ8 | Used by the real-time clock (RTC) |
| IRQ9 | Used by the video graphics array (VGA) interface (optional) |
| IRQ10 | Available |
| IRQ11 | Available |
| IRQ12 | Used by the mouse port |
| IRQ13 | Used by the math coprocessor (if applicable) |
| IRQ14 | Used by the primary integrated drive electronics (IDE) controller |
| IRQ15 | Used by the secondary IDE controller |

[Back to Contents Page](#)

[Back to Contents Page](#)

Help Overview: Dell™ OptiPlex™ GX1 Small-Form-Factor System User's Guide

 [Technical Assistance](#)

 [Product Information](#)

 [Help Tools](#)

 [Returning Items for Warranty Repair or Credit](#)

 [Problems With Your Order](#)

 [Before You Call](#)

Technical Assistance

If you need assistance with a technical problem, perform the following steps:

1. Run the Dell Diagnostics.
2. Make a copy of the [Diagnostics Checklist](#) and fill it out.
3. Use Dell's extensive suite of online services available at Dell's World Wide Web site (<http://www.dell.com>) for help with installation and troubleshooting procedures.
4. If the preceding steps have not resolved the problem, call Dell for technical assistance.

When prompted by Dell's automated telephone system, enter your Express Service Code to route the call directly to the proper support personnel. If you do not have an Express Service Code, open the **Dell Accessories** folder, double-click the **Express Service Code** icon, and follow the directions.



NOTE: Dell's Express Service Code system may not be available in all countries.

For instructions on using the technical support service, see "[Technical Support Service](#)" and "[Before You Call](#)."

Help Tools

Dell provides a number of tools to assist you. These tools are described in the following sections.



NOTE: Some of the following tools are not always available in all locations outside the continental U.S. Please call your local Dell representative for information on availability.

World Wide Web

The Internet is your most powerful tool for obtaining information about your computer and other Dell products. Through the Internet, you can access most of the services described in this section, including

AutoTech, TechFax, order status, technical support, and product information.

You can access Dell's support Web site at <http://support.dell.com>. To select your country, click the map that appears. The **Welcome to support.dell.com** page opens. Enter your system information to access help tools and information.

You can contact Dell electronically by using the following addresses:

- World Wide Web

<http://www.dell.com/>

<http://www.dell.com/ap/> (for Asian/Pacific countries only)

<http://www.euro.dell.com> (for Europe only)

<http://www.dell.com/la/> (for Latin American countries)

- Anonymous file transfer protocol (FTP)

<ftp.dell.com/>

Log in as user: anonymous, and use your e-mail address as your password.

- Electronic Support Service

mobile_support@us.dell.com

support@us.dell.com

apsupport@dell.com (for Asian/Pacific countries only)

support.euro.dell.com (for Europe only)

- Electronic Quote Service

sales@dell.com

apmarketing@dell.com (for Asian/Pacific countries only)

- Electronic Information Service

info@dell.com

AutoTech Service

Dell's automated technical support service—AutoTech—provides recorded answers to the questions most frequently asked by Dell customers.

When you call AutoTech, you use your touch-tone telephone to select the subjects that correspond to your questions. You can even interrupt an AutoTech session and continue the session later. The code number that the AutoTech service gives you allows you to continue your session where you ended it.

The AutoTech service is available 24 hours a day, seven days a week. You can also access this service

through the technical support service. For the telephone number to call, see the [contact numbers](#) for your region.

TechFax Service

Dell takes full advantage of fax technology to serve you better. Twenty-four hours a day, seven days a week, you can call the Dell TechFax line toll-free for all kinds of technical information.

Using a touch-tone phone, you can select from a full directory of topics. The technical information you request is sent within minutes to the fax number you designate. For the TechFax telephone number to call, see the [contact numbers](#) for your region.

TechConnect BBS

Use your modem to access Dell's TechConnect bulletin board service (BBS) 24 hours a day, seven days a week. The service is menu-driven and fully interactive. The protocol parameters for the BBS are 1200 to 19.2K baud, 8 data bits, no parity, 1 stop bit.

Automated Order-Status System

You can call this automated service to check on the status of any Dell products that you have ordered. A recording prompts you for the information needed to locate and report on your order. For the telephone number to call, see the [contact numbers](#) for your region.

Technical Support Service

Dell's industry-leading hardware technical support service is available 24 hours a day, seven days a week, to answer your questions about Dell hardware.

Our technical support staff pride themselves on their track record: more than 90 percent of all problems and questions are taken care of in just one toll-free call, usually in less than 10 minutes. When you call, our experts can refer to records kept on your Dell system to better understand your particular question. Our technical support staff uses computer-based diagnostics to provide fast, accurate answers to questions.

To contact Dell's technical support service, see "[Before You Call](#)" and then call the number for your country as listed in "[Contacting Dell](#)."

Problems With Your Order

If you have a problem with your order, such as missing parts, wrong parts, or incorrect billing, contact Dell for customer assistance. Have your invoice or packing slip handy when you call. For the telephone number to call, see the [contact numbers](#) for your region.

Product Information

If you need information about additional products available from Dell, or if you would like to place an order, visit Dell's World Wide Web site at <http://www.dell.com>. For the telephone number to call to speak to a sales specialist, see "[Contacting Dell](#)."

Returning Items for Warranty Repair or Credit

Prepare all items being returned, whether for repair or credit, as follows:

1. Call Dell to obtain an authorization number, and write it clearly and prominently on the outside of the box.

For the telephone number to call, see the [contact numbers](#) for your region.

2. Include a copy of the invoice and a letter describing the reason for the return.
3. Include a copy of the [Diagnostics Checklist](#) indicating the tests you have run and any error messages reported by the Dell Diagnostics.
4. Include any accessories that belong with the item(s) being returned (power cables, software diskettes, guides, and so on) if the return is for credit.
5. Pack the equipment to be returned in the original (or equivalent) packing materials.

You are responsible for paying shipping expenses. You are also responsible for insuring any product returned, and you assume the risk of loss during shipment to Dell. Collect On Delivery (C.O.D.) packages are not accepted.

Returns that are missing any of the preceding requirements will be refused at our receiving dock and returned to you.

Before You Call



NOTE: Have your Express Service Code ready when you call. The code helps Dell's automated-support telephone system direct your call more efficiently.

Remember to fill out the [Diagnostics Checklist](#). If possible, turn on your system before you call Dell for technical assistance and call from a telephone at or near the computer. You may be asked to type some commands at the keyboard, relay detailed information during operations, or try other troubleshooting steps possible only at the computer system itself. Make sure the system documentation is available.



CAUTION: If you need to remove the computer covers, be sure to first disconnect the computer system's power and modem cables from all electrical outlets.

Diagnostics Checklist

| |
|---------------|
| Date: |
| Name: |
| Address: |
| Phone number: |

| |
|-------------------------------------------------------------------------------------------------------------------------------------------------------------------------------------------------------------------------------------|
| Service tag (bar code on the back of the computer): |
| Express Service Code: |
| Return Material Authorization Number (if provided by Dell support technician): |
| Operating system and version: |
| Peripherals: |
| Expansion cards: |
| Are you connected to a network? Yes No |
| Network, version, and network card: |
| Programs and versions: |
| Refer to your operating system documentation to determine the contents of the system's start-up files. If the computer is connected to a printer, print each file. Otherwise, record the contents of each file before calling Dell. |
| Error message, beep code, or diagnostic code: |
| Description of problem and troubleshooting procedures you performed: |

[Back to Contents Page](#)

[Back to Contents Page](#)

Diagnostics Video Tests: Dell™ OptiPlex™ GX1 Small-Form-Factor System User's Guide

- [Overview](#)
- [Video Memory Test](#)
- [Video Hardware Test](#)
- [Text Mode Character Test](#)
- [Text Mode Color Test](#)
- [Text Mode Pages Test](#)
- [Graphics Mode Test](#)
- [Color Palettes Test](#)
- [Solid Colors Test](#)

Overview

The **Video Test Group** of the Dell Diagnostics consists of the following tests, each of which verifies a particular video function or group of functions:

- [Video Memory Test](#) — Checks the integrity of characters generated from data in the video memory.
- [Video Hardware Test](#) — Checks the functions of the cursor register and the horizontal and vertical retrace bit registers.
- [Text Mode Character Test](#) — Checks the video subsystem's ability to present text mode data.
- [Text Mode Color Test](#) — Checks the video subsystem's ability to present color in text modes.
- [Text Mode Pages Test](#) — Checks the video subsystem's ability to map and present all available video text pages on the monitor screen, one page at a time.
- [Graphics Mode Test](#) — Checks the video subsystem's ability to present graphics mode data and colors.
- [Color Palettes Test](#) — Checks the video subsystem's ability to display all available colors.
- [Solid Colors Test](#) — Checks the video subsystem's ability to show screens full of solid colors. Allows you to check for missing color subpixels.

All of these tests, except the [Video Memory Test](#) and the [Video Hardware Test](#), are interactive. These interactive tests display images on the monitor screen and require the user to respond with the following steps:

1. Examine a displayed image for correctness.
2. If an image is correct, type `y`.
3. If an image is incorrect, type `n`.

Video Memory Test

The **Video Memory Test** verifies the integrity of the video memory either on the system board or on a video expansion card. As the test runs, it describes which 64-kilobyte (KB) block of video memory is being tested. When a test is complete, a message indicates whether the video memory has passed or failed the test. This test does not require any interaction on your part.

Video Hardware Test

The **Video Hardware Test** verifies the operation of the cursor registers and the horizontal and vertical retrace bit registers. When a test is complete, a message indicates whether these registers have passed or failed the test. This test does not require any interaction on your part.

Text Mode Character Test

The **Text Mode Character Test** consists of a group of subtests that display printable characters and character attributes. The subtests check character quality and the monitor's ability to display the characters correctly on its screen. A prompt at the bottom of each screen asks the user to decide whether the display is satisfactory and to respond by typing *y* or *n*.

If you respond affirmatively to each subtest, the **Text Mode Character Test** passes. A negative response to any subtest causes the test to fail.

The following subsections describe the subtests of the **Text Mode Character Test** in the order in which they appear:

[Character Attributes Subtest \(80 x 25\)](#)

[Character Set Subtest \(80 x 25\)](#)

[Video Scan Alignment Subtest](#)

[Character Attributes Subtest \(40 x 25\)](#)

[Character Set Subtest \(40 x 25\)](#)

Character Attributes Subtest (80 x 25)

The 80-column x 25-line character attributes subtest displays four lines of text that demonstrate normal-intensity video, reverse video, intensified video, and blinking video. Figure 1 shows an example of the 80-column x 25-line character attributes subtest screen.

Figure 1. 80-Column x 25-Line Character Attributes Subtest Screen

Video Scan Alignment Subtest

The video scan alignment subtest displays two successive screens: The first screen is a pattern of horizontal and vertical lines, which should be straight and evenly spaced. The second screen is a pattern of boxes (arranged in columns and rows), which should have straight borders and be evenly spaced. [Figure 3](#) and [Figure 4](#), respectively, show examples of the first and second video scan alignment subtest screens.

Figure 3. Video Scan Alignment Subtest (Screen 1)

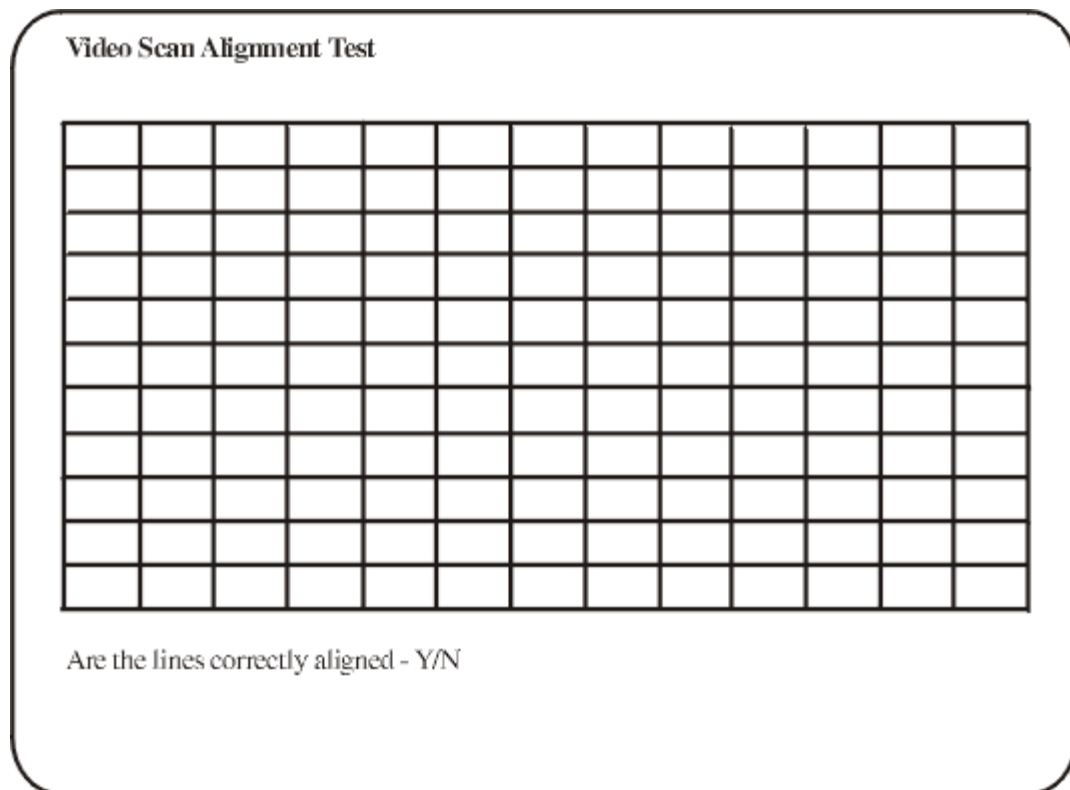
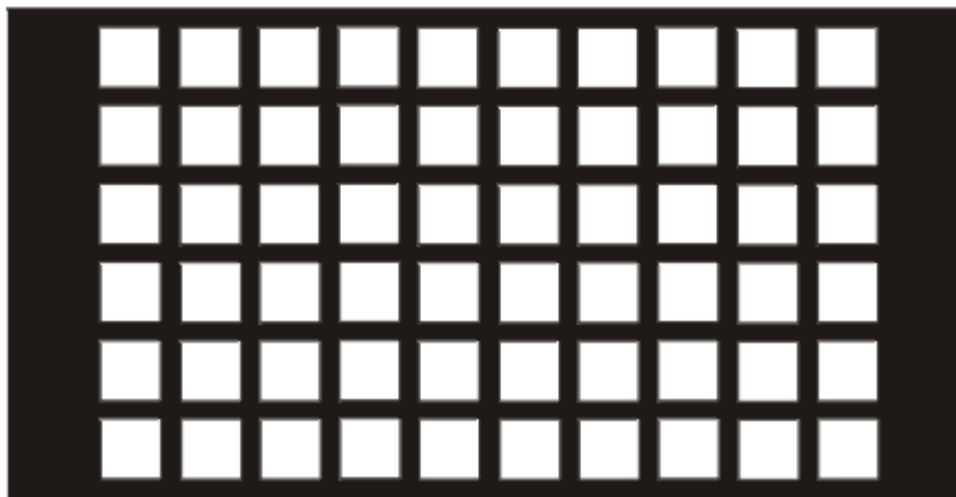

Figure 4. Video Scan Alignment Subtest (Screen 2)

Video Scan Alignment Test



Are the boxes correctly aligned - Y/N?

Character Attributes Subtest (40 x 25)

The 40-column x 25-line character attributes subtest displays four lines of text in 40-column by 25-line (double-wide) text mode that demonstrate normal-intensity video, reverse video, intensified video, and blinking video. Figure 5 shows an example of the 40-column x 25-line character attributes subtest screen.

Figure 5. 40-Column x 25-Line Character Attributes Subtest Screen

Character Attributes Test (40 x 25)

This line is normal intensity.

This line is in reverse video.

This line is intensified.

This line is blinking.

Is this correct - Y/N?

| Row or Column Number | Foreground Color | Background Color |
|---------------------------------------|------------------|------------------|
| 0 | Black | Black |
| 1 | Blue | Blue |
| 2 | Green | Green |
| 3 | Cyan | Cyan |
| 4 | Red | Red |
| 5 | Magenta | Magenta |
| 6 | Brown | Brown |
| 7 | White | White |
| 8 | Dark gray* | Black |
| 9 | Light blue* | Blue |
| A | Light green* | Green |
| B | Light cyan* | Cyan |
| C | Light red | Red |
| D | Light magenta* | Magenta |
| E | Yellow* | Brown |
| F | Intense white* | White |
| * These colors blink during the test. | | |

Color Attributes Subtest (40 x 25)

The 40-column x 25-line color attributes subtest is the same as the previous subtest except that the characters are displayed in 40-column by 25-line (double-wide) text mode. Type `y` if each character is displayed correctly; otherwise, type `n`.

Color Bars Subtest

The color bars subtest displays 16 bars in different colors with background intensity enabled. Under each bar is the name of the color that should be displayed. Type `y` if each color bar is displayed correctly; otherwise, type `n`.

Text Mode Pages Test

The **Text Mode Pages Test** checks the video subsystem's ability to map and present all available video pages on the monitor screen, one page at a time. The test displays eight successive screens, the first of which contains 21 lines of 77 zeros. The remaining seven screens are identical to the first, except that each

screen substitutes a different numeral (1 through 7) for the zeros.

Type **y** if all the rows of numbers on each screen are displayed correctly; otherwise, type **n**. Figure 7 shows an example of the first of these screens.

Figure 7. Text Mode Pages Test Screen

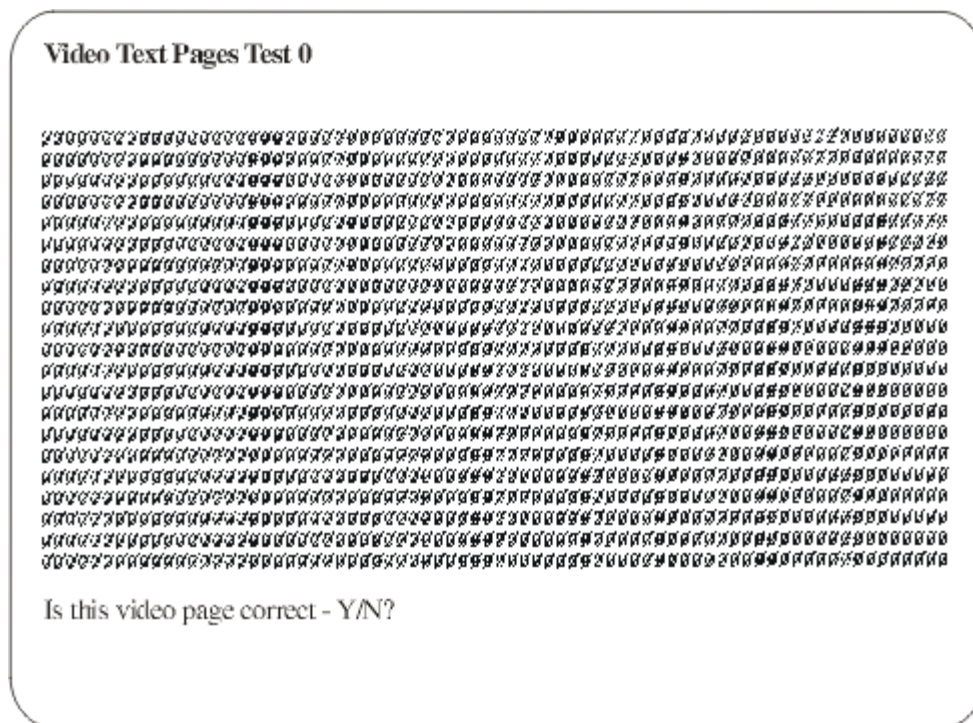

Graphics Mode Test

The **Graphics Mode Test** checks the video subsystem's ability to present graphics mode data and colors. This test displays nine different screens, each of which allows you to check some aspect of graphics mode data and colors. The following subsections describe **Graphics Mode Test** screens in the order in which they appear.



NOTE: Some of the following tests may not appear if your system does not support the video mode being tested.

- [320 x 200 Graphics Mode Screens](#)
- [640 x 200 Black/White Graphics Mode Screen](#)
- [640 x 480 Monochrome Graphics Mode Screen](#)
- [320 x 200 16-Color Graphics Mode Screen](#)
- [640 x 200 16-Color Graphics Mode Screen](#)
- [640 x 350 16-Color Graphics Mode Screen](#)
- [640 x 480 2-Color Graphics Mode Screen](#)
- [640 x 480 16-Color Graphics Mode Screen](#)
- [320 x 200 256-Color Graphics Mode Screen](#)
- [640 x 480 256-Color Graphics Mode Screen](#)
- [800 x 600 16-Color Graphics Mode Screen](#)
- [800 x 600 256-Color Graphics Mode Screen](#)
- [1024 x 768 16-Color Graphics Mode Screen](#)

[1024 x 768 256-Color Graphics Mode Screen](#)

[1280 x 1024 16-Color Graphics Mode Screen](#)

320 x 200 Graphics Mode Screens

The **Graphics Mode Test** displays two successive 320- x 200-pixel graphics mode screens: The first screen displays three pyramids in red, green, and yellow. The second screen displays three pyramids in magenta, cyan, and white. Type *y* if all the pyramids are the correct colors; otherwise, type *n*.

640 x 200 Black/White Graphics Mode Screen

The 640- x 200-pixel black/white graphics mode screen displays a black rectangle and a white rectangle on a gray background. Type *y* if the boxes are displayed correctly; otherwise, type *n*. Figure 8 shows an example of this screen.

Figure 8. 640 x 200 Black/White Graphics Mode Screen

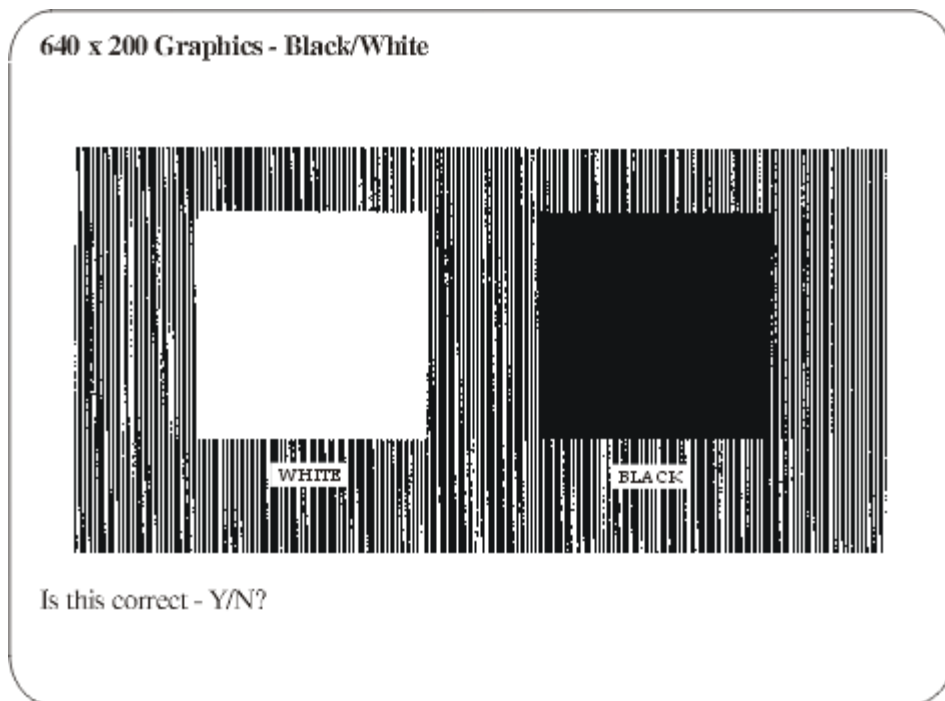

640 x 480 Monochrome Graphics Mode Screen

The 640- x 480-pixel monochrome graphics mode screen displays three chess pieces. Type *y* if all the chess pieces are identical and displayed correctly; otherwise, type *n*. Figure 9 shows an example of this screen.

Figure 9. 640 x 480 Monochrome Graphics Mode Screen

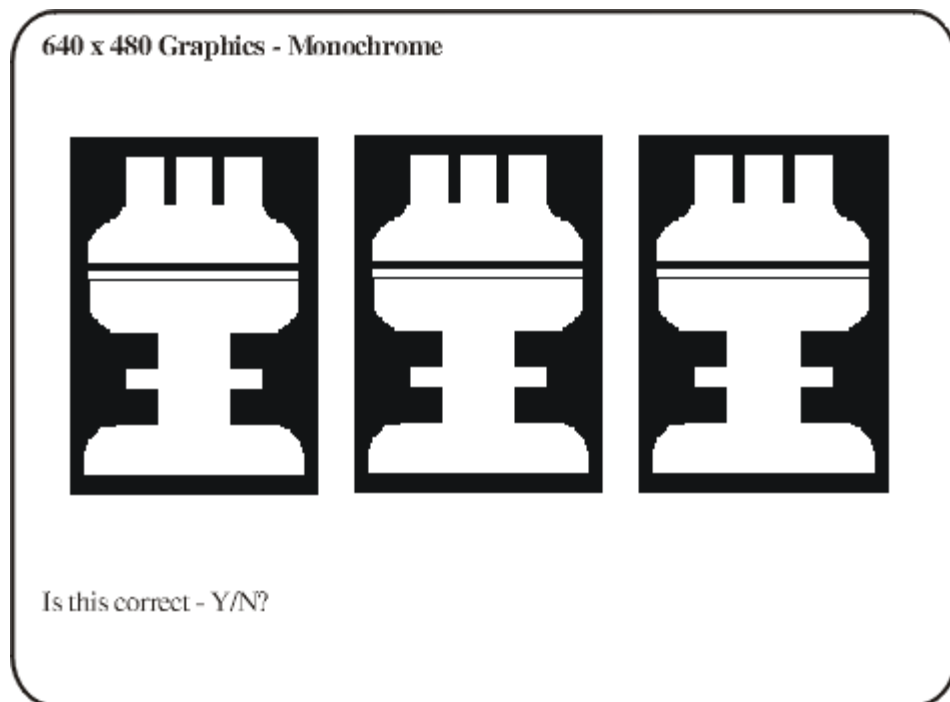

320 x 200 16-Color Graphics Mode Screen

The 320- x 200-pixel 16-color graphics mode screen displays a series of Xs in 16 different colors with the name of the color beneath each X. Type *y* if all the Xs are the correct colors; otherwise, type *n*.

640 x 200 16-Color Graphics Mode Screen

The 640- x 200-pixel 16-color graphics mode screen displays a series of hexagons in 16 different colors with the name of the color beneath each hexagon. Type *y* if all the hexagons are the correct colors; otherwise, type *n*.

640 x 350 16-Color Graphics Mode Screen

The 640- x 350-pixel 16-color graphics mode screen displays a series of octagons in 16 different colors with the name of the color displayed beneath each octagon. Type *y* if all the octagons are the correct colors; otherwise, type *n*.

640 x 480 2-Color Graphics Mode Screen

The 640- x 480-pixel 2-color graphics mode screen displays three chess pieces. Type *y* if all the chess pieces are identical and displayed correctly; otherwise, type *n*. Figure 10 shows an example of this screen.

Figure 10. 640 x 480 2-Color Graphics Mode Screen

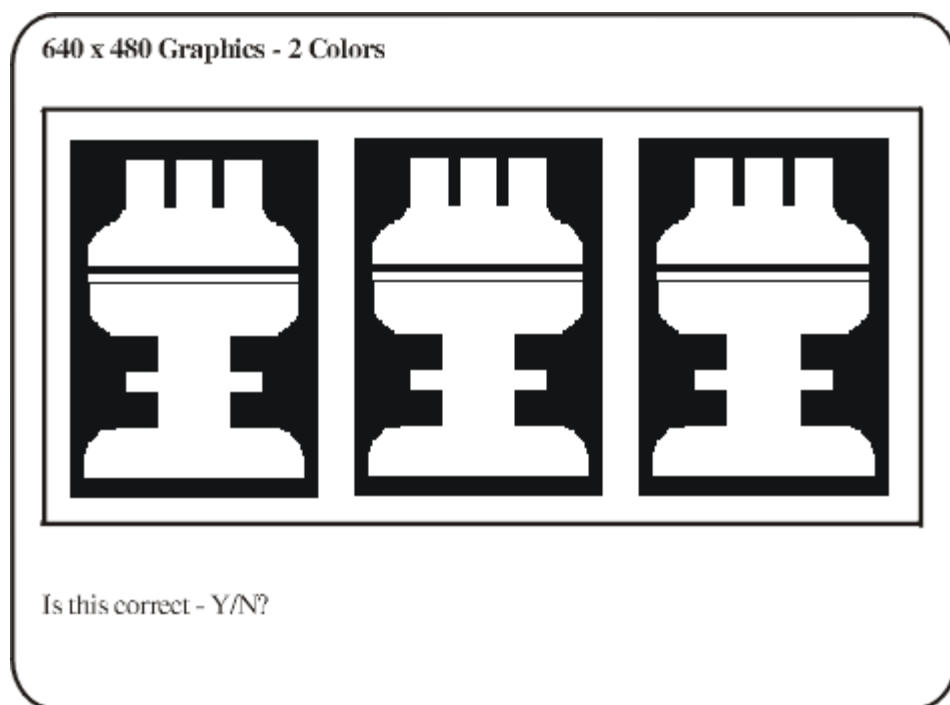

640 x 480 16-Color Graphics Mode Screen

The 640- x 480-pixel 16-color graphics mode screen displays a series of stars in 16 different colors with the name of the color beneath each star. Type *y* if all the stars are the correct colors; otherwise, type *n*.

320 x 200 256-Color Graphics Mode Screen

The 320- x 200-pixel 256-color graphics mode screen displays a series of squares in 256 different color hues and intensities. Type *y* if all the squares are the correct colors; otherwise, type *n*.

640 x 480 256-Color Graphics Mode Screen

The 640- x 480-pixel 256-color graphics mode screen displays a series of squares with two colors in each square. Type *y* if all the squares appear to be correct; otherwise, type *n*.

800 x 600 16-Color Graphics Mode Screen

The 800- x 600-pixel 16-color graphics mode screen displays a series of pyramids in 16 different colors. Type *y* if all the pyramids appear to be correct; otherwise, type *n*.

800 x 600 256-Color Graphics Mode Screen

The 800- x 600-pixel 256-color graphics mode screen displays a series of squares with four colors in each square. Type *y* if all the squares appear to be correct; otherwise, type *n*.

1024 x 768 16-Color Graphics Mode Screen

The 1024- x 768-pixel 16-color graphics mode screen displays a series of hourglasses in 16 different colors. Type *y* if all the hourglasses appear to be correct; otherwise, type *n*.

1024 x 768 256-Color Graphics Mode Screen

The 1024- x 768-pixel 256-color graphics mode screen displays a series of asterisks with four colors in each asterisk. Type **y** if all the asterisks appear to be correct; otherwise, type **n**.

1280 x 1024 16-Color Graphics Mode Screen

The 1280- x 1024-pixel 16-color graphics mode screen displays a series of squares in 16 different colors located in various positions on the screen. Type **y** if all the squares appear to be correct; otherwise, type **n**.

Color Palettes Test

The **Color Palettes Test** checks the video subsystem's ability to display all available colors. The test displays two screens that allow you to check the quality of different shades of the basic colors and to test the monitor's ability to vary the intensity of these colors.

The first screen contains four sets of 64 squares, one for gray and one for each of the three basic colors (red, green, and blue). Each square contains a different shade of its associated color, ranging from very light to very dark. Type **y** if all the squares are the correct colors; otherwise type **n**.

The second screen is the red/green/blue (RGB) color combination screen. This screen allows you to test the monitor's ability to increase or decrease the intensity of the three basic colors.

The RGB color combination screen displays an RGB box in the top center of the screen with individual red, green, and blue boxes beneath it. Underneath the individual color boxes are three lines that show the intensity of each color. Type **r**, **g**, or **b** to adjust the intensity of the corresponding color; then press the right-arrow key to increase the color intensity, or press the left-arrow key to decrease the intensity. The RGB box should be able to display 262,144 different colors when you adjust the intensity levels of red, green, and blue. Type **y** if all the squares are the correct colors; otherwise type **n**.

Solid Colors Test

The **Solid Colors Test** checks whether the video subsystem is displaying the correct colors. This test also lets you check for missing pixels. When this test is running, four screens appear sequentially—a red screen, a green screen, a blue screen, and a white screen. Check each screen for missing pixels, and verify that the correct color is being displayed.

When the test is complete, a message asks if you are satisfied with the quality of the colors. Type **y** if all the pixels were present and if the correct colors were displayed; otherwise, type **n**.

[Back to Contents Page](#)

[Back to Contents Page](#)

Contacting Dell: Dell™ OptiPlex™ GX1 Small-Form-Factor System User's Guide

[Overview](#)

[International Dialing Codes](#)

[Americas Contact Numbers](#)

[Europe Contact Numbers](#)

[Asia and Other Regions Contact Numbers](#)

Overview

When you need to contact Dell, use the telephone numbers, codes, and electronic addresses provided in the following sections. "[International Dialing Codes](#)" provides the various codes required to make long-distance and international calls. "[Americas Contact Numbers](#)," "[Europe Contact Numbers](#)," and "[Asia and Other Regions Contact Numbers](#)" provide local telephone numbers, area codes, toll-free numbers, and e-mail addresses, if applicable, for each department or service available in various countries around the world.

If you are making a direct-dialed call to a location outside of your local telephone service area, determine which codes to use (if any) in "[International Dialing Codes](#)," in addition to the local numbers provided in the other sections.

For example, to place an international call from Paris, France to Bracknell, England, dial the international access code for France followed by the country code for the U.K., the city code for Bracknell, and then the local number as shown in the following illustration:



To place a long-distance call within your own country, use area codes instead of international access codes, country codes, and city codes. For example, to call Paris, France from Montpellier, France, dial the area code plus the local number as shown in the following illustration:



The codes required depend on where you are calling from as well as the destination of your call; in addition, each country has a different dialing protocol. If you need assistance in determining which codes to use, contact a local or an international operator.



NOTES: Toll-free numbers are for use only within the country for which they are listed. Area codes are most often used to call long distance within your own country (not internationally)—in other words, when your call originates in the same country you are calling.

Have your Express Service Code ready when you call. The code helps Dell's automated-support

telephone system direct your call more efficiently.

International Dialing Codes

Click a listed country to obtain the appropriate contact numbers.

| Country (City) | International Access Code | Country Code | City Code |
|----------------------------------------------|---------------------------|--------------|--------------|
| Australia (Sydney) | 0011 | 61 | 2 |
| Austria (Vienna) | 900 | 43 | 1 |
| Belgium (Brussels) | 00 | 32 | 2 |
| Brazil | 0021 | 55 | 51 |
| Brunei | — | 673 | — |
| Canada (North York, Ontario) | 011 | — | Not required |
| Chile (Santiago) | — | 56 | 2 |
| China (Xiamen) | — | 86 | 592 |
| Czech Republic (Prague) | 00 | 420 | 2 |
| Denmark (Horsholm) | 009 | 45 | Not required |
| Finland (Helsinki) | 990 | 358 | 9 |
| France (Paris) (Montpellier) | 00 | 33 | (1) (4) |
| Germany (Langen) | 00 | 49 | 6103 |
| Hong Kong | 001 | 852 | Not required |
| Ireland (Bray) | 16 | 353 | 1 |
| Italy (Milan) | 00 | 39 | 2 |
| Japan (Kawasaki) | 001 | 81 | 44 |
| Korea (Seoul) | 001 | 82 | 2 |
| Luxembourg | 00 | 352 | — |
| Macau | — | 853 | Not required |
| Malaysia (Penang) | 00 | 60 | 4 |
| Mexico (Colonia Granada) | 95 | 52 | 5 |
| Netherlands (Amsterdam) | 00 | 31 | 20 |
| New Zealand | 00 | 64 | — |
| Norway (Lysaker) | 095 | 47 | Not required |

| | | | |
|---------------------------------------------|--------|-----|--------------|
| Poland (Warsaw) | 011 | 48 | 22 |
| Singapore (Singapore) | 005 | 65 | Not required |
| South Africa (Johannesburg) | 09/091 | 27 | 11 |
| Spain (Madrid) | 07 | 34 | 91 |
| Sweden (Upplands Vasby) | 009 | 46 | 8 |
| Switzerland (Geneva) | 00 | 41 | 22 |
| Taiwan | 002 | 886 | — |
| Thailand | 001 | 66 | — |
| U.K. (Bracknell) | 010 | 44 | 1344 |
| U.S.A. (Austin, Texas) | 011 | 1 | Not required |

Americas Contact Numbers

| Country (City) | Department Name or Service | Area Code | Local Number or Toll-Free Number |
|-------------------------------------------------------------------------------------------------------------------------------------------------------|-----------------------------------------------------------------------|---------------------------|----------------------------------|
| Brazil | Sales, Customer Support, Technical Support | | toll free: 0800 90 3355 |
| | Web site: http://www.dell.com.br | | |
| Canada (North York, Ontario) <i>NOTE: Customers in Canada call the U.S.A. for access to TechConnect BBS.</i> | Automated Order-Status System | | toll free: 1-800-433-9014 |
| | AutoTech (Automated technical support) | | toll free: 1-800-247-9362 |
| | Customer Care (From outside Toronto) | | toll free: 1-800-387-5759 |
| | Customer Care (From within Toronto) | 416 | 758-2400 |
| | Customer Technical Support | | toll free: 1-800-847-4096 |
| | Sales (Direct Sales—from outside Toronto) | | toll free: 1-800-387-5752 |
| | Sales (Direct Sales—from within Toronto) | 416 | 758-2200 |
| | Sales (Federal government, education, and medical) | | toll free: 1-800-567-7542 |
| | Sales (Major Accounts) | | toll free: 1-800-387-5755 |
| | TechConnect BBS (Austin, Texas, U.S.A.) | 512 | 728-8528 |
| TechFax | | toll free: 1-800-950-1329 | |

| | | | |
|----------------------------------------------------------------------------------------------------------------------------------------------------------------------|-----------------------------------------------------------------------------|------------|---------------------------------------------------------------------------|
| <p>Chile (Santiago)</p> <p><i>NOTE: Customers in Chile call the U.S.A. for sales, customer, and technical assistance</i></p> | <p>Sales, Customer Support, and Technical Support</p> | | <p>toll free: 1230-020-4823</p> |
| <p>Latin America</p> <p><i>NOTE: Customers in Latin America call the U.S.A. for sales, customer, and technical assistance.</i></p> | <p>Customer Technical Support (Austin, Texas, U.S.A.)</p> | <p>512</p> | <p>728-4093</p> |
| | <p>Customer Service (Austin, Texas, U.S.A.)</p> | <p>512</p> | <p>728-3619</p> |
| | <p>Fax (Technical Support and Customer Service) (Austin, Texas, U.S.A.)</p> | <p>512</p> | <p>728-3883</p> |
| | <p>Sales (Austin, Texas, U.S.A.)</p> | <p>512</p> | <p>728-4397</p> |
| | <p>SalesFax (Austin, Texas, U.S.A.)</p> | <p>512</p> | <p>728-4600 728-3772</p> |
| <p>Mexico (Colonia Granada)</p> <p><i>NOTE: Customers in Mexico call the U.S.A. for access to the Automated Order-Status System and AutoTech.</i></p> | <p>Automated Order-Status System (Austin, Texas, U.S.A.)</p> | <p>512</p> | <p>728-0685</p> |
| | <p>AutoTech (Automated technical support) (Austin, Texas, U.S.A.)</p> | <p>512</p> | <p>728-0686</p> |
| | <p>Customer Technical Support</p> | <p>525</p> | <p>228-7870</p> |
| | <p>Sales</p> | <p>525</p> | <p>228-7811 toll free: 91-800-900-37 toll free: 91-800-904-49</p> |
| | <p>Customer Service</p> | <p>525</p> | <p>228-7878</p> |
| | <p>Main</p> | <p>525</p> | <p>228-7800</p> |
| <p>U.S.A. (Austin, Texas)</p> | <p>Automated Order-Status System</p> | | <p>toll free: 1-800-433-9014</p> |
| | <p>AutoTech (Automated technical support)</p> | | <p>toll free: 1-800-247-9362</p> |
| <p>Dell Home and Small Business Group:</p> | | | |
| | <p>Customer Technical Support (Return Material Authorization Numbers)</p> | | <p>toll free: 1-800-624-9896</p> |
| | <p>Customer Service (Credit Return Authorization Numbers)</p> | | <p>toll free: 1-800-624-9897</p> |

| | | |
|-----------------------------------------------------------------------------------------------------------------------------------------------------------------------------|-----|--------------------------------------------------------|
| National Accounts (systems purchased by established Dell national accounts [have your account number handy], medical institutions, or value-added resellers [VARs]): | | |
| Customer Service and Technical Support (Return Material Authorization Numbers) | | toll free: 1-800-822-8965 |
| Public Americas International (systems purchased by governmental agencies [local, state, or federal] or educational institutions): | | |
| Customer Service and Technical Support (Return Material Authorization Numbers) | | toll free: 1-800-234-1490 |
| Dell Sales | | toll free: 1-800-289-3355 toll free: 1-800-879-3355 |
| Spare Parts Sales | | toll free: 1-800-357-3355 |
| DellWare™ | | toll free: 1-800-753-7201 |
| DellWare FaxBack Service | 512 | 728-1681 |
| Fee-Based Technical Support | | toll free: 1-800-433-9005 |
| Sales (Catalogs) | | toll free: 1-800-426-5150 |
| Fax | | toll free: 1-800-727-8320 |
| TechFax | | toll free: 1-800-950-1329 |
| TechConnect BBS | 512 | 728-8528 |
| Dell Services for the Deaf, Hard-of-Hearing, or Speech-Impaired | | toll free: 1-877-DELLTTY (1-877-335-5889) |
| Switchboard | 512 | 338-4400 |

Europe Contact Numbers

| Country (City) | Department Name or Service | Area Code | Local Number or Toll-Free Number |
|------------------------------------------------------------------------------------------------------------------------------------------------------------|--------------------------------------------|-----------|----------------------------------|
| Austria (Vienna) <i>NOTE: Customers in Austria call Langen, Germany for Technical Support and Customer Care.</i> | Switchboard | 01 | 491 040 |
| | Home/Small Business Sales | 01 | 795676-02 |
| | Home/Small Business Sales Fax | 01 | 795676-05 |
| | Home/Small Business Customer Care | 01 | 795676-03 |
| | Preferred Accounts/Corporate Customer Care | | 0660-8056 |
| | Home/Small Business Technical Support | 01 | 795676-04 |

| | | | |
|------------------------------------------------------------------------------------------------------------------------------|--------------------------------------------------------------------------------------------|----|-----------------------|
| | Preferred Accounts/Corporate Technical Support | | 0660-8779 |
| | Web site: http://support.euro.dell.com/at | | |
| | E-mail: tech_support_germany@dell.com | | |
| Belgium (Brussels) | Technical Support | 02 | 481 92 88 |
| | Customer Care | 02 | 481 91 19 |
| | Home/Small Business Sales | | toll free: 0800 16884 |
| | Corporate Sales | 02 | 481 91 00 |
| | Fax | 02 | 481 92 99 |
| | Switchboard | 02 | 481 91 00 |
| | Web site: http://support.euro.dell.com/be | | |
| | E-mail: tech_be@dell.com | | |
| Czech Republic (Prague) | Technical Support | 02 | 22 83 27 27 |
| | Customer Care | 02 | 22 83 27 11 |
| | Fax | 02 | 22 83 27 14 |
| | TechFax | 02 | 22 83 27 28 |
| | Switchboard | 02 | 22 83 27 11 |
| | Web site: http://support.euro.dell.com/cz | | |
| | E-mail: czech_dell@dell.com | | |
| Denmark (Horsholm) <i>NOTE: Customers in Denmark call Sweden for fax technical support.</i> | Technical Support | | 45170182 |
| | Relational Customer Care | | 45170184 |
| | Home/Small Business Customer Care | | 32875505 |
| | Switchboard | | 45170100 |
| | Fax Technical Support (Upplands Vasby, Sweden) | | 859005594 |
| | Fax Switchboard | | 45170117 |
| | Web site: http://support.euro.dell.com/dk | | |
| | E-mail: den_support@dell.com | | |
| Finland | Technical Support | 09 | 253 313 60 |

| | | | |
|--------------------------------------|-----------------------------------------------------------------------------------------------------|-------|---------------|
| (Helsinki) | Technical Support Fax | 09 | 253 313 81 |
| | Relational Customer Care | 09 | 253 313 38 |
| | Home/Small Business Customer Care | 09 | 693 791 94 |
| | Fax | 09 | 253 313 99 |
| | Switchboard | 09 | 253 313 00 |
| | Web site: http://support.euro.dell.com/fin | | |
| | E-mail: fin_support@dell.com | | |
| France (Paris/Montpellier) | Technical Support | 0803 | 387 270 |
| | Customer Care (Paris) | 01 | 47 62 68 92 |
| | Customer Care (Montpellier) | 04 | 67 06 61 96 |
| | TechConnect BBS (Montpellier) | 04 | 67 22 53 04 |
| | Fax (Montpellier) | 04 | 67 06 60 07 |
| | Switchboard (Paris) | 01 | 47 62 69 00 |
| | Switchboard (Montpellier) | 04 | 67 06 60 00 |
| | Web site: http://support.euro.dell.com/fr | | |
| | E-mail: web_fr_tech@dell.com | | |
| Germany (Langen) | Technical Support | 06103 | 766-7200 |
| | Technical Support Fax | 06103 | 766-9222 |
| | Home/Small Business Customer Care | | 0180-5-224400 |
| | Global Segment Customer Care | 06103 | 766-9570 |
| | Preferred Accounts Customer Care | 06103 | 766-9420 |
| | Large Accounts Customer Care | 06103 | 766-9560 |
| | Public Accounts Customer Care | 06103 | 766-9555 |
| | TechConnect BBS | 06103 | 766-9666 |
| | Switchboard | 06103 | 766-7000 |
| | Web site: http://www.dell.de/support | | |
| | E-mail: tech_support_germany@dell.com | | |
| Ireland (Bray) | Technical Support | | 1-850-543-543 |
| | Customer Care | 01 | 204 4026 |

| | | | |
|---------------------------------------------------------------------------------------------------------------------------------------------------|---------------------------------------------------------------------------------------------------|-----|----------------------|
| | Sales | | 1-850-235-235 |
| | SalesFax | 01 | 286 2020 |
| | Fax | 01 | 286 6848 |
| | TechConnect BBS | 01 | 204 4711 |
| | TechFax | 01 | 204 4708 |
| | Switchboard | 01 | 286 0500 |
| | Web site: http://support.euro.dell.com/ie | | |
| | E-mail: dell_direct_support@dell.com | | |
| Italy (Milan) | Technical Support | 2 | 57782.690 |
| | Customer Care | 2 | 57782.555 |
| | Sales | 2 | 57782.411 |
| | Fax | 2 | 57503530 |
| | Switchboard | 2 | 57782.1 |
| | Web site: http://support.euro.dell.com/it | | |
| | E-mail: support_italy@dell.com | | |
| Luxembourg <i>NOTE: Customers in Luxembourg call Belgium for sales, customer, and technical assistance.</i> | Technical Support (Brussels, Belgium) | 02 | 481 92 88 |
| | Home/Small Business Sales (Brussels, Belgium) | | toll free: 080016884 |
| | Corporate Sales (Brussels, Belgium) | 02 | 481 91 00 |
| | Customer Care (Brussels, Belgium) | 02 | 481 91 19 |
| | Switchboard (Brussels, Belgium) | 02 | 481 91 00 |
| | Fax (Brussels, Belgium) | 02 | 481 92 99 |
| | Web site: http://support.euro.dell.com/be | | |
| | E-mail: tech_be@dell.com | | |
| | | | |
| Netherlands (Amsterdam) | Technical Support | 020 | 581 8838 |
| | Customer Care | 020 | 581 8740 |
| | Home/Small Business Sales | | toll free: 0800-0663 |
| | Home/Small Business Sales Fax | 020 | 682 7171 |
| | Corporate Sales | 020 | 581 8818 |

| | | | |
|---------------------------------------------------------------------------------------------------------------------------|---------------------------------------------------------------------------------------------------|-----|-------------|
| | Corporate Sales Fax | 020 | 686 8003 |
| | Fax | 020 | 686 8003 |
| | Switchboard | 020 | 581 8818 |
| | Web site: http://support.euro.dell.com/nl | | |
| | E-mail: tech_nl@dell.com | | |
| Norway (Lysaker) <i>NOTE: Customers in Norway call Sweden for fax technical support.</i> | Technical Support | | 671 16882 |
| | Relational Customer Care | | 671 17514 |
| | Home/Small Business Customer Care | | 231 62298 |
| | Switchboard | | 671 16800 |
| | Fax Technical Support (Upplands Vasby, Sweden) | | 590 05 594 |
| | Fax Switchboard | | 671 16865 |
| | Web site: http://support.euro.dell.com/no | | |
| | E-mail: nor_support@dell.com | | |
| Poland (Warsaw) | Technical Support | 22 | 60 61 999 |
| | Customer Care | 22 | 60 61 999 |
| | Sales | 22 | 60 61 999 |
| | Switchboard | 22 | 60 61 999 |
| | Fax | 22 | 60 61 998 |
| | Web site: http://support.euro.dell.com/pl | | |
| | E-mail: pl_support@dell.com | | |
| Spain (Madrid) | Technical Support | | 902 100 130 |
| | Corporate Customer Care | | 902 118 546 |
| | Home/Small Business Customer Care | | 902 118 540 |
| | TechConnect BBS | 91 | 329 33 53 |
| | Corporate Sales | | 902 100 185 |
| | Home/Small Business Sales | | 902 118 541 |
| | Switchboard | 91 | 722 92 00 |
| | Web site: http://support.euro.dell.com/es | | |

| | | | |
|-----------------------------------|--------------------------------------------------------------------------------------------|-------|---------------|
| | E-mail: es_support@dell.com | | |
| Sweden (Upplands Vasby) | Technical Support | 08 | 590 05 199 |
| | Relational Customer Care | 08 | 590 05 642 |
| | Home/Small Business Customer Care | 08 | 587 70 527 |
| | Fax Technical Support | 08 | 590 05 594 |
| | Sales | 08 | 590 05 185 |
| | Web site: http://support.euro.dell.com/se | | |
| | E-mail: swe_support@dell.com | | |
| Switzerland (Geneva) | Technical Support | | 0844 811 411 |
| | Customer Care | | 0848 802 802 |
| | Switchboard | 022 | 799 01 01 |
| | Fax | 022 | 799 01 90 |
| | Web site: http://support.euro.dell.com/ch | | |
| | E-mail: swisstech@dell.com | | |
| U.K. (Bracknell) | Technical Support | | 0870-908-0800 |
| | Corporate Customer Care | 01344 | 720206 |
| | Home/Small Business Customer Care | | 0870-906-0010 |
| | TechConnect BBS | | 0870-908-0610 |
| | Sales | 01344 | 720000 |
| | AutoFax | | 0870-908-0510 |
| | Web site: http://support.euro.dell.com/uk | | |
| | E-mail: dell_direct_support@dell.com | | |

Asia and Other Regions Contact Numbers

| Country (City) | Department Name or Service | Area Code | Local Number or Toll-Free Number |
|------------------------------|-----------------------------------|-----------|----------------------------------|
| Australia (Sydney) | Home and Small Business | | 1-300-65-55-33 |
| | Government and Business | | toll free: 1-800-633-559 |
| | Preferred Accounts Division (PAD) | | toll free: 1-800-060-889 |
| | | | |

| | | | |
|--------------------------------------------------------------------------------------------------------------------|--------------------------------------------------------------|-----|--------------------------------------------|
| | Customer Care | | toll free: 1-800-819-339 |
| | Corporate Sales | | toll free: 1-800-808-385 |
| | Transaction Sales | | toll free: 1-800-808-312 |
| | Fax | | toll free: 1-800-818-341 |
| Brunei <i>NOTE: Customers in Brunei call Malaysia for customer assistance.</i> | Customer Technical Support (Penang, Malaysia) | | 810 4966 |
| | Customer Service (Penang, Malaysia) | | 810 4949 |
| | Transaction Sales (Penang, Malaysia) | | 810 4955 |
| China (Xiamen) | Customer Service | | toll free: 800 858 2437 |
| | Sales | | toll free: 800 858 2222 |
| Hong Kong <i>NOTE: Customers in Hong Kong call Malaysia for customer assistance.</i> | Technical Support | | toll free: 800 96 4107 |
| | Customer Service (Penang, Malaysia) | | 810 4949 |
| | Transaction Sales | | toll free: 800 96 4109 |
| | Corporate Sales | | toll free: 800 96 4108 |
| Japan (Kawasaki) | Technical Support (Server) | | toll free: 0120-1984-35 |
| | Technical Support (Dimension™ and Inspiron™) | | toll free: 0120-1982-56 or 0088-25-3355 |
| | Technical Support (WorkStation, OptiPlex™, and Latitude™) | | toll free: 0120-1984-39 or 0088-22-7890 |
| | Y2K Support | 044 | 556-4298 |
| | Customer Care | 044 | 556-4240 |
| | Home and Small Business Group Sales | 044 | 556-3344 |
| | Preferred Accounts Division Sales | 044 | 556-3433 |
| | Large Corporate Accounts | 044 | 556-3430 |
| | Faxbox Service | | 03-5972-5840 |
| | Switchboard | 044 | 556-4300 |
| Korea (Seoul) | Technical Support | | toll free: 080-200-3800 |
| | Sales | | toll free: 080-200-3777 |
| | Customer Service (Penang, | | 604-810-4949 |

| | | | |
|---------------------------------------------------------------------------------------------------------------------------------------|--------------------------------------------------------------------------------------------|-----|--------------------------|
| | Malaysia) | | |
| | Customer Service (Seoul, Korea) | | 2194-6220 |
| | Fax | | 2194-6202 |
| | Switchboard | | 2194-6000 |
| Macau <i>NOTE: Customers in Macau call Malaysia for customer assistance.</i> | Technical Support | | toll free: 0800 582 |
| | Customer Service (Penang, Malaysia) | | 810 4949 |
| | Transaction Sales | | toll free: 0800 581 |
| Malaysia (Penang) | Technical Support | | toll free: 1 800 888 298 |
| | Customer Service | 04 | 810 4949 |
| | Transaction Sales | | toll free: 1 800 888 202 |
| | Corporate Sales | | toll free: 1 800 888 213 |
| New Zealand | Home and Small Business | | 0800 446 255 |
| | Government and Business | | 0800 444 617 |
| | Sales | | 0800 441 567 |
| | Fax | | 0800 441 566 |
| Singapore (Singapore) <i>NOTE: Customers in Singapore call Malaysia for customer assistance.</i> | Technical Support | | toll free: 800 6011 051 |
| | Customer Service (Penang, Malaysia) | 04 | 810 4949 |
| | Transaction Sales | | toll free: 800 6011 054 |
| | Corporate Sales | | toll free: 800 6011 053 |
| South Africa (Johannesburg) | Technical Support | 011 | 709 7710 |
| | Customer Care | 011 | 709 7710 |
| | Sales | 011 | 706 7700 |
| | Fax | 011 | 709 0495 |
| | Switchboard | 011 | 709 7700 |
| | Web site: http://support.euro.dell.com/za | | |
| | E-mail: dell_za_support@dell.com | | |
| Southeast | Customer Technical Support, | | 60 4 810-4810 |

| | | | |
|-----------------------------------------------------------------------------------------------------------------------------------------------------------------------------------------------------------------|---------------------------------------------------|--|----------------------------------------|
| Asian/Pacific Countries (excluding Australia, Brunei, China, Hong Kong, Japan, Korea, Macau, Malaysia, New Zealand, Singapore, Taiwan, and Thailand—refer to individual listings for these countries) | Customer Service, and Sales (Penang, Malaysia) | | |
| Taiwan | Technical Support | | toll free: 0080 60 1225 |
| | Technical Support (Servers) | | toll free: 0080 60 1256 |
| | Customer Service (Penang, Malaysia) | | 810 4949 |
| | Transaction Sales | | toll free: 0080 651 228/0800 33 556 |
| | Corporate Sales | | toll free: 0080 651 227/0800 33 555 |
| Thailand <i>NOTE: Customers in Thailand call Malaysia for customer assistance.</i> | Technical Support | | toll free: 088 006 007 |
| | Customer Service (Penang, Malaysia) | | 810 4949 |
| | Sales | | toll free: 088 006 009 |

[Back to Contents Page](#)

[Back to Contents Page](#)

Optional Stand: Dell™ OptiPlex™ GX1 Small-Form-Factor System User's Guide

To remove the optional stand, perform the following steps:

1. Turn the computer over so that the stand is at the top.
2. Loosen the captive screw and lift the stand away (see Figure 1).
3. Place the computer in a horizontal position.

Figure 1. Optional Stand

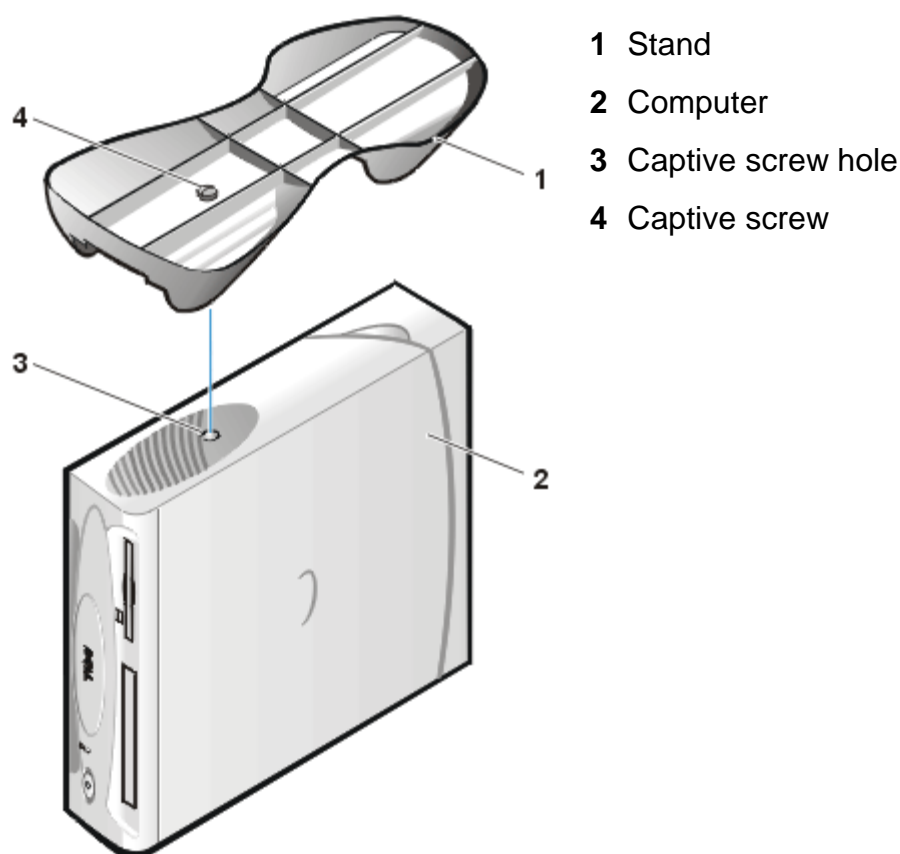

To attach the optional stand, perform the following steps.

NOTICE: Attach the optional stand to the computer only as described in this procedure. Operating the computer with the stand attached in any other position may damage the computer.

1. Turn the computer onto its right side.
2. Fit the stand onto what now is the top of the computer.

Position the stand as shown in [Figure 1](#). Align the captive thumbscrew in the stand with the screw

hole in the cover.

Tighten the thumbscrew.

3. Rotate the computer so that the stand is at the bottom.
-

[Back to Contents Page](#)