

AK79G MAX
AK79D MAX
Online Manual

DOC. NO.: AK79GMAX-OL-E0212A

What's in this manual

AK79G MAX/AK79D MAX..... 1

What's in this manual 2

You Must Notice 8

Before You Start 9

Overview 10

AK79G MAX/AK79D MAX Comparison Table 11

Feature Highlight..... 12

Quick Installation Procedure 16

Motherboard Map..... 17

Block Diagram..... 18

Hardware Installation..... 19

JP14 Clear CMOS Data 20

CPU Installation 21

AOpen Overheat Protection (O.H.P.) Technology..... 23

CPU Jumper-less Design 24

CPU and Housing Fan Connector 27

JP28 Keyboard/Mouse Wakeup Jumpers..... 28

DIMM Sockets..... 29





STBY LED 31

Front Panel Connector 32

ATX Power Connector 33

AC Power Auto Recovery 33

IDE and Floppy Connector 34

Serial ATA Connector 36

S/PDIF (Sony/Philips Digital Interface) Connector 37

Super 5.1 Channel Audio Effect 38

TV Output Connector (for AK79G MAX) 39

IrDA Connector 40

AGP (Accelerated Graphic Port) 8X Expansion Slot 41

AGP Protection Technology and AGP LED 42

Support 10/100 Mbps LAN Onboard 43

ACR (Audio and Communication Riser) Expansion Slot 44

Game Port Bracket Supported 45

Color Coded Back Panel 46

COM2 Connector 47

Support Front USB 2.0 Connector 48

IEEE 1394 Connectors 49

Case Open Connector..... 50

CD Audio Connector 51

AUX-IN Connector..... 52

Front Audio Connector 53

Battery-less and Long Life Design..... 54

CPU Over-current Protection..... 55

 AConfig Utility..... 56

Resetable Fuse 58

2200 μ F Low ESR Capacitor..... 59

Enlarged Aluminum Heatsink 60

 Open JukeBox Player..... 61

 Vivid BIOS technology..... 65

 The noise is gone!! --- SilentTek 66

 EzClock..... 69

Driver and Utility 73

Auto-run Menu from Bonus CD 73

nVIDIA nForce Drivers 74

NVIDIA Windows 98/ME/2000/XP Display Driver 75

Installing Promise SATA150 Driver in Existing Windows XP/2000/ME/98/NT4.0 System..... 76



Installing USB2.0 Driver in Existing Windows XP System 88

Installing USB 2.0 Driver in Existing Windows 98/ME/2000 System 89

Phoenix Award BIOS..... 90

How To Use Phoenix Award™ BIOS Setup Program 91

How To Enter BIOS Setup 93

WinBIOS Utility 94

BIOS Upgrade under Windows environment 96



Glossary 98

AC97 CODEC 98

ACPI (Advanced Configuration & Power Interface) 98

ACR (Advanced Communication Riser)..... 98

AGP (Accelerated Graphic Port)..... 99

AMR (Audio/Modem Riser)..... 99

ATA (AT Attachment) 99

BIOS (Basic Input/Output System) 100

Bluetooth..... 100

CNR (Communication and Networking Riser)..... 101

DDR (Double Data Rate) RAM..... 101

ECC (Error Checking and Correction) 101



<i>EEPROM (Electronic Erasable Programmable ROM)</i>	101
<i>EPROM (Erasable Programmable ROM)</i>	102
<i>EV6 Bus</i>	102
<i>FCC DoC (Declaration of Conformity)</i>	102
<i>FC-PGA (Flip Chip-Pin Grid Array)</i>	102
<i>FC-PGA2 (Flip Chip-Pin Grid Array)</i>	102
<i>Flash ROM</i>	103
<i>Hyper Threading</i>	103
<i>IEEE 1394</i>	103
<i>Parity Bit</i>	104
<i>PCI (Peripheral Component Interface) Bus</i>	104
<i>PDF Format</i>	104
<i>PnP (Plug and Play)</i>	104
<i>POST (Power-On Self Test)</i>	105
<i>PSB (Processor System Bus) Clock</i>	105
<i>RDRAM (Rambus Dynamic Random Access Memory)</i>	105
<i>RIMM (Rambus Inline Memory Module)</i>	105
<i>SDRAM (Synchronous DRAM)</i>	105
<i>SATA (Serial ATA)</i>	106

<i>SMBus (System Management Bus)</i>	106
<i>SPD (Serial Presence Detect)</i>	106
<i>USB 2.0 (Universal Serial Bus)</i>	106
<i>VCM (Virtual Channel Memory)</i>	107
<i>Wireless LAN – 802.11b</i>	107
<i>ZIP file</i>	107
Troubleshooting	108
Technical Support	112
Product Registration	115
How to Contact Us	116

You Must Notice



Adobe, the Adobe logo, Acrobat is trademarks of Adobe Systems Incorporated.

AMD, the AMD logo, Athlon and Duron are trademarks of Advanced Micro Devices, Inc.

Intel, the Intel logo, Intel Celeron, Pentium II, Pentium III, Pentium 4 are trademarks of Intel Corporation.

Microsoft, Windows, and Windows logo are either registered trademarks or trademarks of Microsoft Corporation in the United States and/or other countries.

All product and brand names used on this manual are used for identification purposes only and may be the registered trademarks of their respective owners.

All of the specifications and information contained in this manual are subject to change without notice. AOpen reserves the right to revise this publication and to make reasonable changes. AOpen assumes no responsibility for any errors or inaccuracies that may appear in this manual, including the products and software described in it.

This documentation is protected by copyright law. All rights are reserved.

No part of this document may be used or reproduced in any form or by any means, or stored in a database or retrieval system without prior written permission from AOpen Corporation.

Copyright® 1996-2003, AOpen Inc. All Rights Reserved.

Before You Start



This Online Manual will introduce to the user how this product is installed. All useful information will be described in later chapters. Please keep this manual carefully for future upgrades or system configuration changes. This Online Manual is saved in [PDF format](#), we recommend using Adobe Acrobat Reader 5.0 for online viewing, it is included in Bonus CD disc or you can get free download from [Adobe web site](#).

Although this Online Manual is optimized for screen viewing, it is still capable for hardcopy printing, you can print it by A4 paper size and set 2 pages per A4 sheet on your printer. To do so, choose **File > Page Setup** and follow the instruction of your printer driver.

Thanks for the help of saving our earth.

Overview

Thank you for choosing AOpen AK79G MAX/AK79D MAX. The AK79G MAX/AK79D MAX is based on AMD® Socket 462 motherboard with ATX form factor featuring the AMD Duron/Athlon/Athlon XP CPU. As high performance chipset built in the M/B, the AK79G MAX/AK79D MAX supports AMD® Socket 462 series Athlon™, Duron™ and AthlonXP™ processor. (with CPU Overheat Protection circuit to Athlon™XP CPU only). The motherboard also support 333/266/200MHz EV6 bus. For better graphic performance, GeForce4 MX Graphics is integrated for delivering fastest speed, multi-display functionality and multiple configurations of CRTs and TVs. Hence, AK79G MAX supports TV-OUT function which supports TV-Out card. It also supports 1.5V AGP interface of AGP 8x/4x with Fast Write data transfer. According to different customers' requirements, this motherboard supports [DDR400](#), [DDR333](#) and [DDR266](#) dual channel DDRAM up to 3GB maximum. The on-board IDE controller supports [Ultra DMA 66/100/133](#) mode and the transfer rate is up to 133MB/s. Besides, the AK79G MAX/AK79D MAX has an [AC97 CODEC RealTek ALC650](#) chipset onboard to provide high performance and magic surround stereo sound to let people enjoy working with it. More than that, this motherboard supports [USB 2.0](#) function with a fancy speed up to 480Mbps. Now, enjoy all features from AOpen AK79G MAX/AK79D MAX.

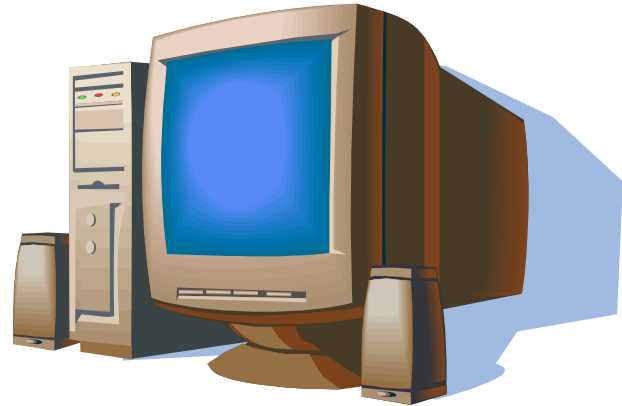

AK79G MAX/AK79D MAX Comparison Table

Following we list functions of all models. “V” represents those functions that the model equips with and “X” represents functions that models don’t have. Please always refer to this page to see the functions of your model.

	AK79D MAX	AK79G MAX
Chipset	nForce2-ST	nForce2-GT
VGA Onboard	X	V
VGA Connector	X	V
LAN Onboard	V	V
LAN Port	V	V
IEEE 1394 Function	V	V
IEEE 1394 Connector	V	V
TV Out Header	X	V

Feature Highlight

CPU

Supports AMD® Socket 462 series CPU with 200MHz, 266MHz and 333MHz, EV6 Bus designed for Socket 462 technology.

Athlon: 600MHz~1.4GHz

Duron: 600MHz~1.2GHz

AthlonXP: 1500+(1.33GHz)~2800+(2.25GHz)

Chipset

NVIDIA nForce™2-ST/GT are excellent in providing amazing digital media performance, such as 400MHz DDR memory controller, optimized 128-bit architecture reducing overall system memory latency. What nForce™2-GT integrated in this excellent chipset is the GeForce4 MX Graphics, which provides the fastest integrated graphics performance and the most comprehensive set of features. Of five PCI slots provided, this model supports all five master PCI slots with arbitration and decoding for all integrated functions and LPC bus.

Ultra DMA 66/100/133 Bus Master IDE

Embedded within NVIDIA MCP/MCP-T, this motherboard equips with Ultra DMA 66/100/133 that supports three connectors, and that means six IDE devices in three channels, and supports Enhanced IDE devices.

Expansion Slots

Including five 32-bit/33MHz PCI slots and one AGP 8X slot which supports AGP card. The [PCI](#) local bus throughput can be up to 132MB/s. The [Accelerated Graphics Port \(AGP\)](#) specification provides a new level of video display sophistication and speed with data transfer rate up to 2.1GB/s.

Memory

With NVIDIA nForce™2 chipsets, the AK79G MAX/AK79D MAX can support dual channel [Double-Data-Rate \(DDR\) RAM](#). The dual channel mode allows chipsets to get data in 128 bit. The DDR RAM interface allows zero wait state bursting between the SDRAM and the data buffers at 333/266/200MHz. The three slots of DDR RAM can be composed of an arbitrary mixture of 64, 128, 256, 512MB or 1GB DDR RAM and maximum up to 3GB. The AK79G MAX/AK79D MAX allows DDR RAM to run at either synchronous or pseudo-synchronous mode with the host CPU bus frequency (400/333/266MHz).

On-board AC97 Sound

AK79G MAX/AK79D MAX uses the [AC97](#) CODEC RealTek ALC650 chip. This on-board audio includes a complete audio recording and playback system.

LAN Port

LAN MAC embedded in nForce2 chipsets and a Realtek RTL8201BL PHY onboard, which support 10/100Mbps BaseT Fast Ethernet and is IEEE802.3 compliant.

Six USB 2.0 Connectors

Provides three ports, six [USB](#) 2.0 connectors with transfer rates at high speed of 480Mbps for USB interface devices, such as mouse, keyboard, modem, scanner, etc.

1MHz Stepping CPU Frequency Adjustment

Provides “1MHz Stepping Frequency Adjustment” function in the BIOS. This magic function allows you adjust CPU [FSB](#) frequency from 100~200 by 1MHz stepping, and lets your system can get maximum performance.

Power Management/Plug and Play

Supports the power management function that conforms to the power-saving standards of the U.S. Environmental Protection Agency (EPA) Energy Star program. It also offers [Plug-and-Play](#), which helps saving users from configuration problems, thus making the system much more user-friendly.

Hardware Monitoring Management

Supports CPU or system fans status, temperature and voltage monitoring and alert, through the on-board hardware monitor module and Aopen Hardware Monitoring Utility.

SilentTek

Combines “Hardware-Status Monitoring”, “Overheat Warning” and “Fan Speed Control” with user-friendly interfaces to provide a perfect balance among noises, system performance and stability.

Enhanced ACPI

Fully implement the [ACPI](#) standard for Windows® 95/98/ME/NT/2000/XP series compatibility, and supports Soft-Off, STR (Suspend to RAM, S3), STD (Suspend to Disk, S4) features.

Quick Installation Procedure

This page gives you a quick procedure on how to install your system. Follow each step accordingly.

1. [Installing CPU and Fan](#)
2. [Installing System Memory \(DIMM\)](#)
3. [Connecting Front Panel Cable](#)
4. [Connecting IDE and Floppy Cable](#)
5. [Connecting ATX Power Cable](#)
6. [Connecting Back Panel Cable](#)
7. [Power-on and Load BIOS Setup Default](#)
8. [Setting CPU Frequency](#)
9. Reboot
10. [Installing Driver and Utility](#)

Motherboard Map

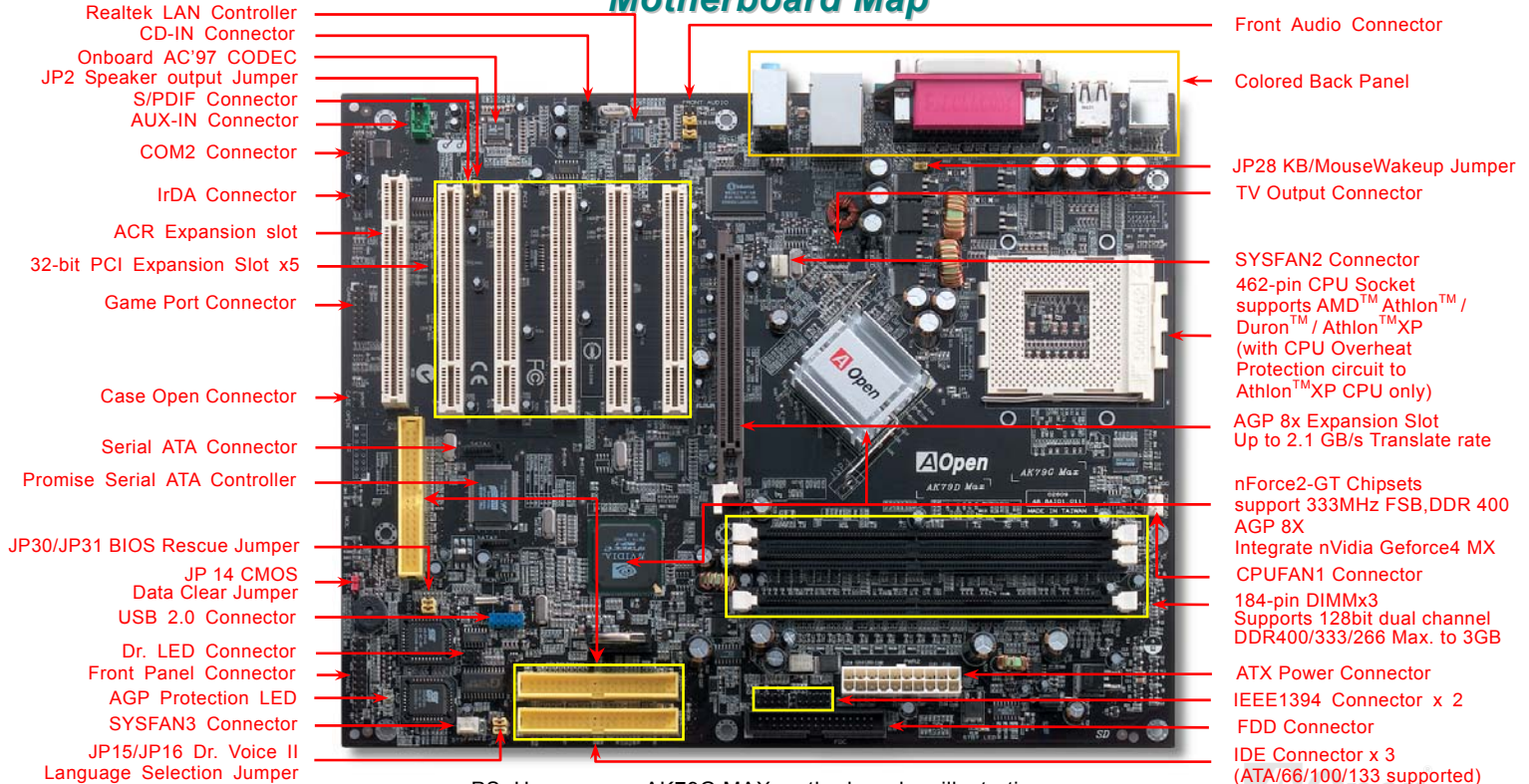

PS. Here we use AK79G MAX motherboard as illustration.



Block Diagram

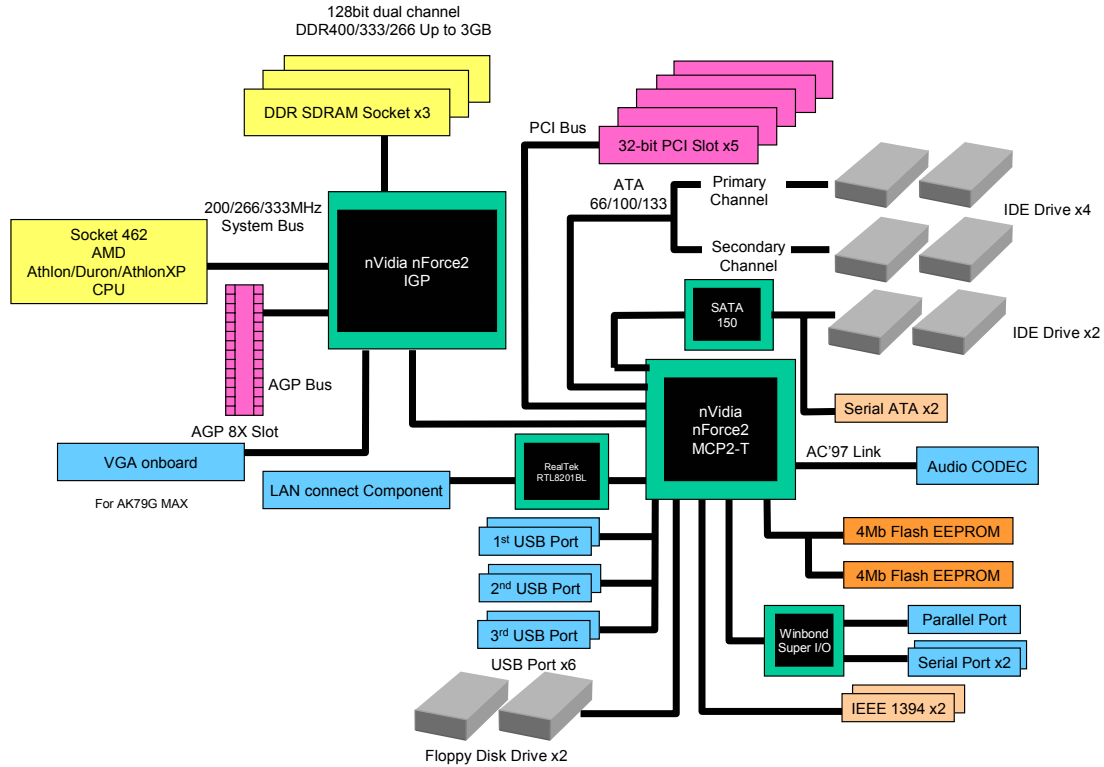

Hardware Installation

This chapter describes jumpers, connectors and hardware devices of this motherboard.



Note: *Electrostatic discharge (ESD) can damage your processor, disk drives, expansion boards, and other components. Always observe the following precautions before you install a system component.*

1. *Do not remove a component from its protective packaging until you are ready to install it.*
2. *Wear a wrist ground strap and attach it to a metal part of the system unit before handling a component. If a wrist strap is not available, maintain contact with the system unit throughout any procedures requiring ESD protection.*

JP14 Clear CMOS Data

You can clear CMOS to restore system default setting. To clear the CMOS, follow the procedures below.

1. Turn off the system and unplug the AC power.
2. Remove ATX power cable from connector PWR2.
3. Locate JP14 and short pins 2-3 for a few seconds.
4. Return JP14 to its normal setting by shorting pin 1 & pin 2.
5. Connect ATX power cable back to connector PWR2.

Pin 1

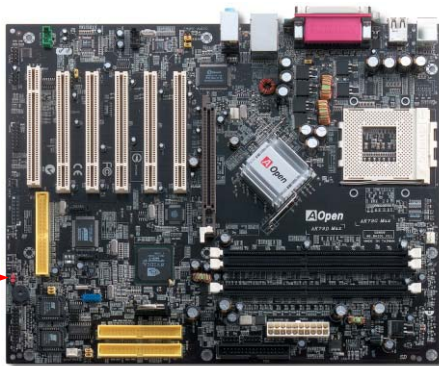
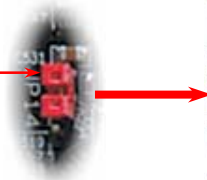

Normal Operation
(default)



Clear CMOS

Tip: When should I Clear CMOS?

1. Boot fail because of overclocking...
2. Forget password...
3. Troubleshooting...

CPU Installation

This motherboard supports AMD® Athlon and Duron Socket 462 series CPU. Be careful of CPU orientation when you plug it into CPU socket (with **CPU Overheat Protection** function implemented, the system will be automatically power off when the temperature of CPU reached 97 degree, but works on AthlonXP CPU only).

1. Pull up the CPU socket lever and up to 90-degree angle.

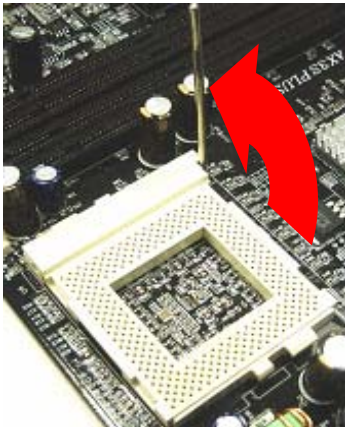

2. Locate Pin 1 in the socket and look for a black dot or cut edge on the CPU upper interface. Match Pin 1 and cut edge, then insert the CPU into the socket.

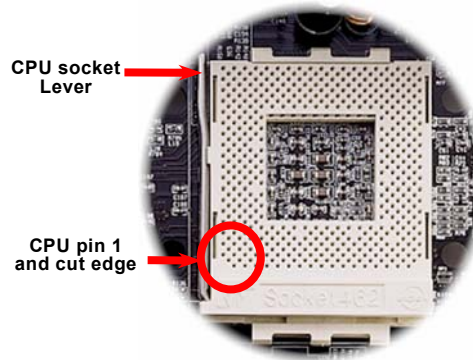

Black dot and cut edge

Note: This picture is for example only; it may not exactly be the same motherboard.

3. Press down the CPU socket lever and finish CPU installation.

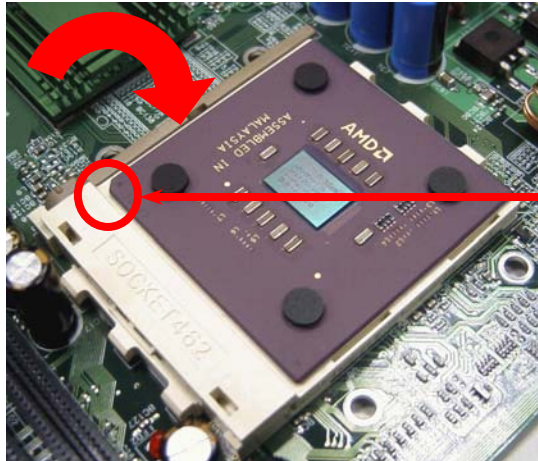

CPU cut edge

Note: If you do not match the CPU socket Pin 1 and CPU cut edge well, you may damage the CPU.

Note: This picture is for example only; it may not exactly be the same motherboard.

AOpen Overheat Protection (O.H.P.) Technology

With AMD platform substantially keeps increasing the speed of its CPU, it inevitably led to the annoying problem of high CPU operation temperature at the same time. In order to prevent accidental failure of CPU fan, which could cause the burning down of the AthlonXP CPU, we, AOpen, have meticulously developed a new technology, named, O.H.P. (Overheat Protection) Technology to protect them. Thanks to the intelligent monitoring design of AOpen O.H.P. technology, user can now finally set their mind at ease even when fan failed to work without fearing the possible damage of CPU.

Under the circumstances that CPU fan is running properly, AthlonXP temperature should be way below the highest temperature

limit of 97°C. However, if CPU fan accidentally becomes malfunction or improperly installed, the CPU temperature would rocket abruptly, and you may find your system hang up or crying over the smoking CPU if you haven't installed AOpen O.H.P. previously. With AOpen O.H.P. technology applied, the specific thermal detection pins on AthlonXP CPU would sense voltage difference when processor is overheated with fan failed, and the overheat protection system would immediately send out a signal to abort your system by cutting CPU electricity before any damage is done. Unlike other manufacturers who use BIOS or software to control the power supply of CPU, AOpen O.H.P. Technology is purely hardware-controlled the minute after system boot-up, and occupies no system resource. We are pleasant to phase in this practical function on all AOpen AMD series motherboards to protect customer's valuable hardware and personal data.

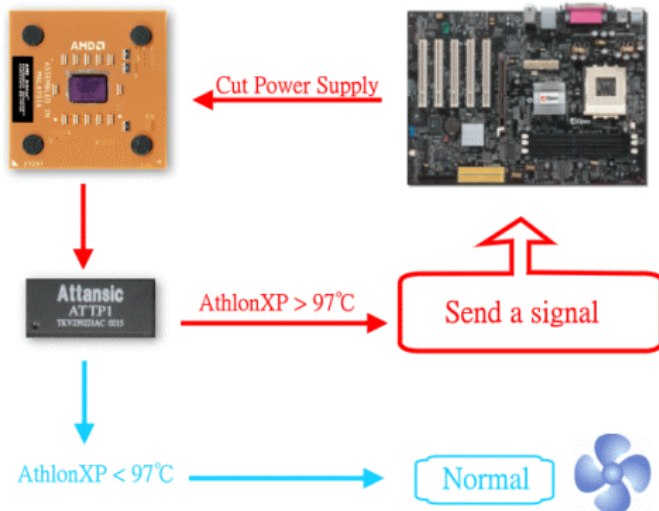

CPU Jumper-less Design

CPU VID signal and [SMbus](#) clock generator provide CPU voltage auto-detection and allows the user to set the CPU frequency through the [BIOS setup](#), therefore no jumpers or switches are used. The disadvantages of the Pentium based jumper-less designs are eliminated. There will be no worry of wrong CPU voltage detection.

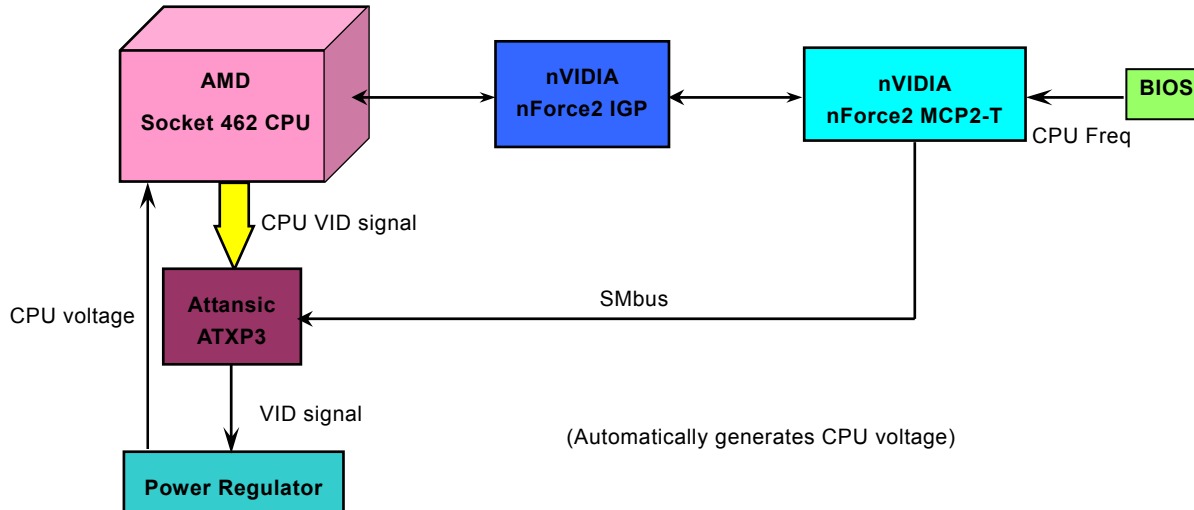

Full-range Adjustable CPU Core Voltage

This motherboard supports CPU VID function. The CPU core voltage will be automatically detected and the range is from 1.1V to 1.85V. It is not necessary to set CPU Core Voltage.

Setting CPU Frequency

This motherboard is CPU jumper-less design, you can set CPU frequency through the BIOS setup, and no jumpers or switches are needed.

BIOS Setup > Frequency/Voltage Control > CPU Speed Setting

CPU Ratio	From 5.5x to 16x step 0.5x
CPU FSB (Adjustment manually)	FSB=100~200 by 1MHz Stepping CPU Overclocking



Warning: nForce2-ST/GT chipsets support 166MHz FSB (with performance reaches maximum 333MHz EV6 system bus) and 66MHz AGP clock, higher clock setting may cause serious system damage.

Tip: If your system hangs or fails to boot because of overclocking, simply use <Home> key to restore the default setting or you can wait the AOpen "Watch Dog Timer" reset the system after few seconds and system will auto-detect hardware again.

Supported CPU Frequency

Core Frequency = CPU Bus Clock * CPU Ratio

EV6 Bus Speed = CPU external bus clock x 2

PCI Clock = CPU Bus Clock / Clock Ratio

AGP Clock = PCI Clock x 2

CPU	CPU Core Frequency	EV6 Bus Clock	Ratio
Athlon 1G	1GHz	266MHz	7.5x
Athlon 1.13G	1.13GHz	266MHz	8.5x
Athlon 1.2G	1.2GHz	266MHz	9.0x
Athlon 1.33G	1.33GHz	266MHz	10.0x
Athlon 1.4G	1.4GHz	266MHz	10.5x
AthlonXP 1500+	1.3GHz	266MHz	10.0x
AthlonXP 1600+	1.4GHz	266MHz	10.5x
AthlonXP 1700+	1.46GHz	266MHz	11.0x
AthlonXP 1800+	1.53GHz	266MHz	11.5x
AthlonXP 1900+	1.6GHz	266MHz	12.0x
AthlonXP 2000+	1.667GHz	266MHz	12.5x
AthlonXP 2100+	1.73GHz	266MHz	13x
AthlonXP 2200+	1.80GHz	266MHz	13.5x
AthlonXP 2400+	2.0GHz	266MHz	15x
AthlonXP 2600+	2.13GHz	266MHz	16x
AthlonXP 2700+	2.16GHz	333MHz	13x
AthlonXP 2800+	2.25GHz	333MHz	13.5x
Duron 1G	1GHz	200MHz	10.0x
Duron 1.1G	1.1GHz	200MHz	11.0x
Duron 1.2G	1.2GHz	200MHz	12.0x
Duron 1.3G	1.3GHz	200MHz	13.0x

Note: With CPU speed changing rapidly, there might be fastest CPU on the market by the time you received this installation guide. This table is kindly for your references only.

Note: You have to adjust CPU FSB in BIOS after installing CPU; otherwise CPU will run at default speed of CPU FSB value.

Note: : Due to the limitation of nVidia chipset itself, if the FSB overclocking frequency is extremely high, (for example, over 160MHz), the WatchDog ABS and Home key function may not be able to automatically recover your motherboard. In such case, please clear CMOS by JP14.

CPU and Housing Fan Connector

Plug in the CPU fan cable to the 3-pin **CPUFAN1** connector. If you have chassis fan, you can also plug it on **SYSFAN2** or **SYSFAN3** connector.

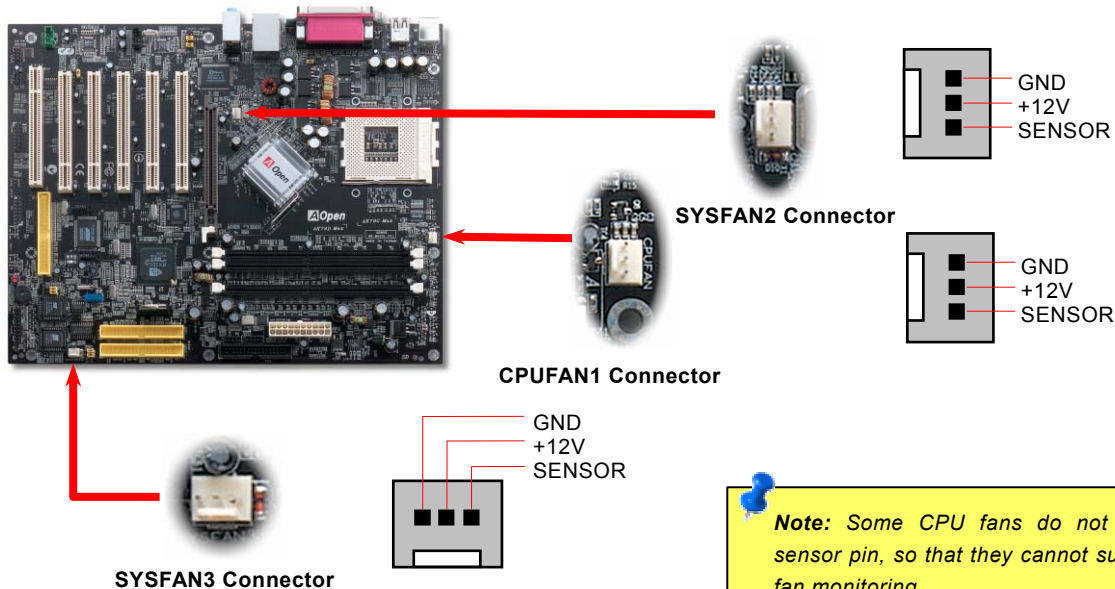

JP28 Keyboard/Mouse Wakeup Jumpers

This motherboard provides keyboard / mouse wake-up function. You can use JP28 to enable or disable this function, which could resume your system from suspend mode with keyboard or mouse. The factory default setting is “Disable”(1-2), and you may enable this function by setting the jumper to 2-3.

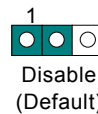
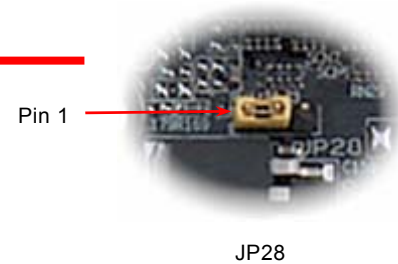
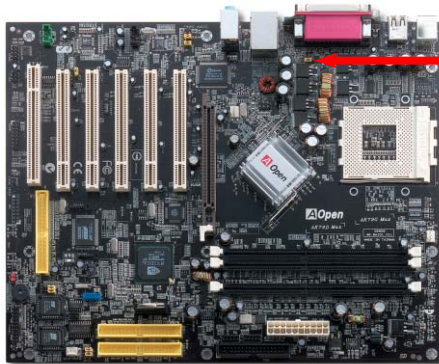

DIMM Sockets

This motherboard has three 184-pin DDR DIMM sockets that allow you to install 128bit dual channel [DDR400](#) or [DDR333](#) or [DDR266](#) memory up to 3GB. To reach maximal performance, you had better install at least 2 RAM in the sockets. Only Non-ECC DDR RAM is supported, otherwise, it will cause serious damage on memory sockets or SDRAM module. For over clocking purpose, you can adjust memory voltage in BIOS from 2.5V to 2.65V.

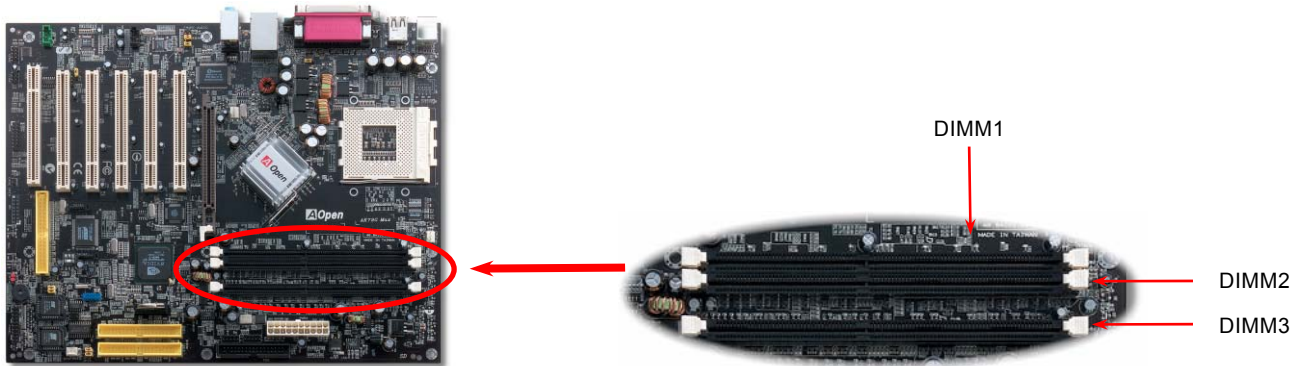

Warning: This motherboard supports DDR RAM. Please do not install the SDRAM on the DDR RAM sockets, otherwise, it will cause serious damage on memory sockets or SDRAM module.

How to Install Memory Modules

Please follow the procedure as shown below to finish memory installation.

1. Make sure the DIMM module's pin face down and match the socket's size as depicted below.



2. Insert the module straight down to the DIMM slot with both hands and press down firmly until the DIMM module is securely in place.

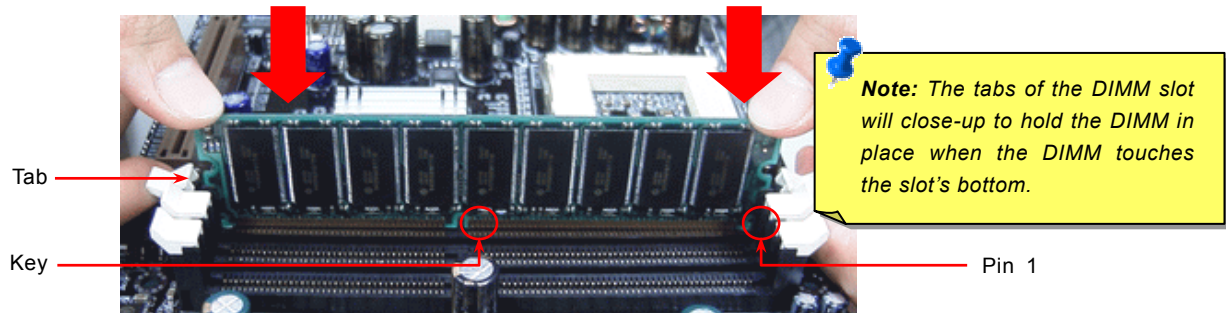

3. Repeat step 2 to finish additional DIMM modules installation.

STBY LED

STBY LED is AOpen's considerate design that aims at providing you friendly system information. The STBY LED will light up when power is connected to the motherboard. This is a convenient indication for you to check the system power status in many circumstances such as power on/off, stand-by mode and RAM power status during Suspend to RAM mode.

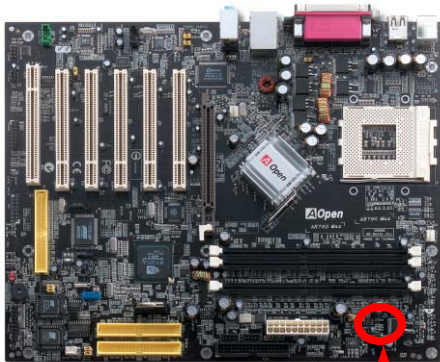

STBY LED

Warning: Do not install or remove the DIMM module or others devices when the STBY LED lights on.

Front Panel Connector

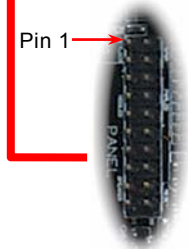
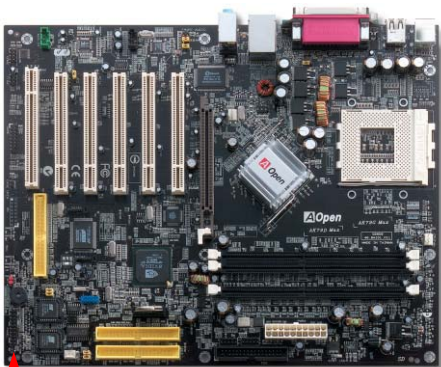

Attach the power LED, speaker, power and reset switch connectors to the corresponding pins. If you enable "Suspend Mode" item in BIOS Setup, the ACPI & Power LED will keep flashing while the system is in suspend mode.

Locate the power switch cable from your ATX housing. It is 2-pin female connector from the housing front panel. Plug this connector to the soft-power switch connector marked **SPWR**.

Suspend Type	ACPI LED
Power on Suspend (S1) or Suspend to RAM (S3)	Blinking between green and red.
Suspend to Disk (S4)	The LED will be turned off

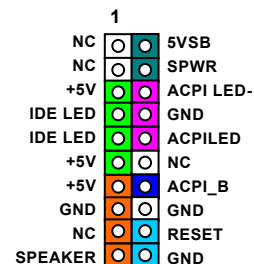
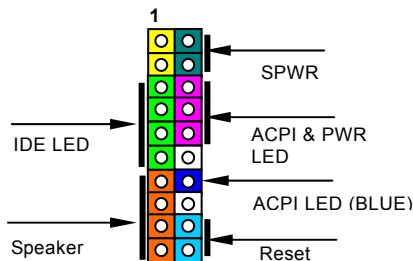

ATX Power Connector

The ATX power supply uses 20-pin connector shown below. Make sure you plug in the right direction.

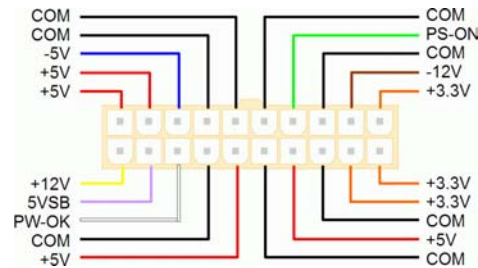
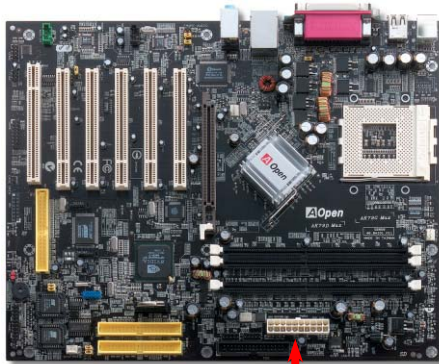

20-Pin Power Connector

AC Power Auto Recovery

A traditional ATX system should remain at power off stage when AC power resumes from power failure. This design is inconvenient for a network server or workstation, without an UPS, that needs to keep power-on. This motherboard implements an AC Power Auto Recovery function to solve this problem.

IDE and Floppy Connector

Connect 34-pin floppy cable and 40-pin IDE cable to floppy connector FDC connector. Be careful of the pin1 orientation. Wrong orientation may cause system damage.

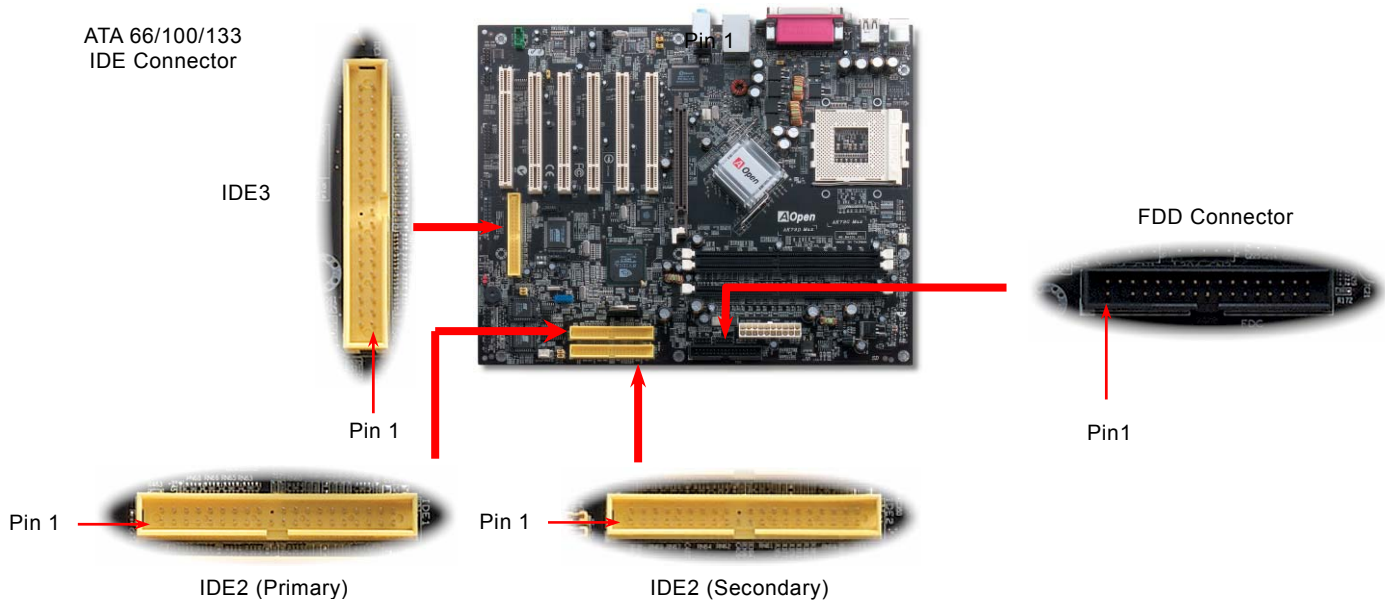

IDE1 is also known as the primary channel and IDE2 as the secondary channel. Each channel supports two IDE devices that make a total of four devices. In order to work together, the two devices on each channel must be set differently to **Master** and **Slave** mode. Either one can be the hard disk or the CDROM. The setting as master or slave mode depends on the jumper on your IDE device, so please refer to your hard disk and CDROM manual accordingly.

This motherboard supports [ATA66](#), [ATA100](#) or [ATA133](#) IDE devices. Following table lists the transfer rate of IDE PIO and DMA modes. The IDE bus is 16-bit, which means every transfer is two bytes.

Mode	Clock Period	Clock Count	Cycle Time	Data Transfer Rate
PIO mode 0	30ns	20	600ns	(1/600ns) x 2byte = 3.3MB/s
PIO mode 1	30ns	13	383ns	(1/383ns) x 2byte = 5.2MB/s
PIO mode 2	30ns	8	240ns	(1/240ns) x 2byte = 8.3MB/s
PIO mode 3	30ns	6	180ns	(1/180ns) x 2byte = 11.1MB/s
PIO mode 4	30ns	4	120ns	(1/120ns) x 2byte = 16.6MB/s
DMA mode 0	30ns	16	480ns	(1/480ns) x 2byte = 4.16MB/s
DMA mode 1	30ns	5	150ns	(1/150ns) x 2byte = 13.3MB/s
DMA mode 2	30ns	4	120ns	(1/120ns) x 2byte = 16.6MB/s
ATA33	30ns	4	120ns	(1/120ns) x 2byte x 2 = 33MB/s
ATA66	30ns	2	60ns	(1/60ns) x 2byte x 2 = 66MB/s
ATA100	20ns	2	40ns	(1/40ns) x 2byte x 2 = 100MB/s
ATA133	15ns	2	30ns	(1/30ns) x 2byte x 2 = 133MB/s

Tip:

1. For better signal quality, it is recommended to set the far end side device to master mode and follow the suggested sequence to install your new device. Please refer to above diagram
2. To achieve the best performance of Ultra DMA 66/100/133 hard disks, a special **80-wires IDE cable** for Ultra DMA 66/100/133 is required.

Warning: The specification of the IDE cable is a maximum of 46cm (18 inches); make sure your cable does not exceed this length.

Serial ATA Connector



To connect a Serial ATA disk, you must use a 7-pin serial ATA cable. Connect two ends of the serial ATA cable to the serial ATA header on the main board and the disk. Like every other traditional disk, you also have to connect a power cable. Please note that it is a jumper free implement; you don't need to set jumpers to define a master or slave disk. When connecting two serial ATA disks, the system will automatically take the one connected to "Serial ATA 1" header as a master disk



SATA Header 1



SATA Header 2

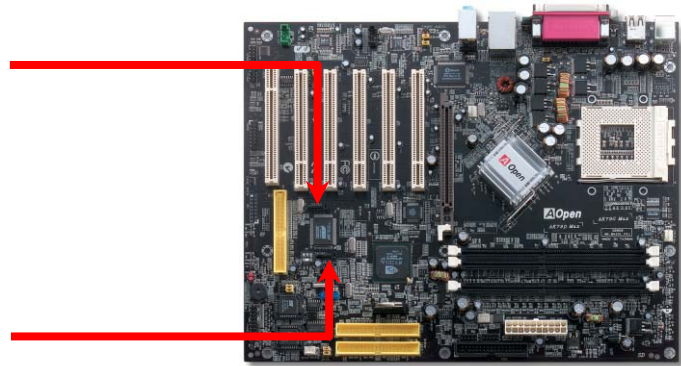

S/PDIF (Sony/Philips Digital Interface) Connector

S/PDIF (Sony/Philips Digital Interface) is a newest audio transfer file format, which provides impressive audio quality through optical fiber and allows you to enjoy digital audio instead of analog audio. Through a specific audio cable, you can connect the S/PDIF connector to other end of the S/PDIF audio module, which bears S/PDIF digital output. Normally there are two S/PDIF outputs as shown, one for RCA connector, the most common one used for consumer audio products, and the other for optical connector with better audio quality. Same as outputs, you can also connect RCA or optical audio products to input connectors on the module and have the voice or music come out from your computer. However, you must have a S/PDIF supported speaker/amplifier/decoder with S/PDIF digital input/output to connect to the S/PDIF digital input/output to make the most out of this function.

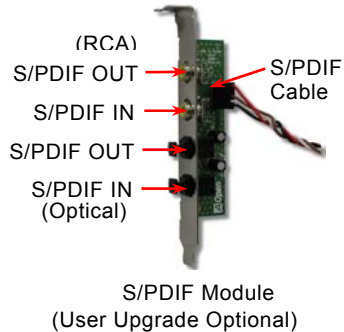

Pin 1

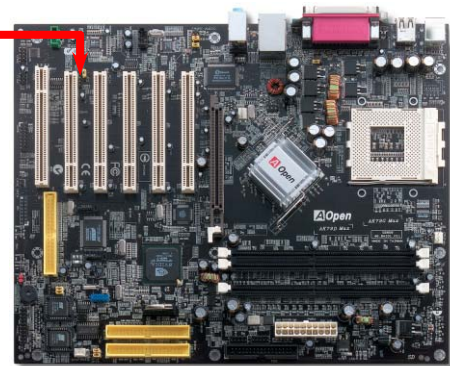
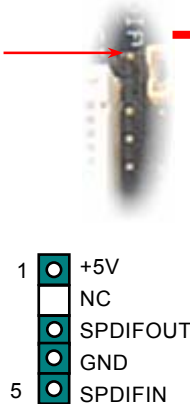



Super 5.1 Channel Audio Effect

This motherboard comes with an ALC650 CODEC, which supports high quality of 5.1 Channel audio effects, bringing you a brand new audio experience. On the strength of the innovative design of ALC650, you're able to use standard line-jacks for surround audio output without connecting any external module. To apply this function, you have to install the audio driver in the Bonus Pack CD as well as an audio application supporting 5.1 Channel. Picture bellow represents the standard location of all speakers in 5.1Channel sound track. Please connect the plug of your front speakers to the green "Speaker out" port, rear speakers' plug to the blue "Line in" port and both of the center and subwoofer speakers to the red "MIC in" port.

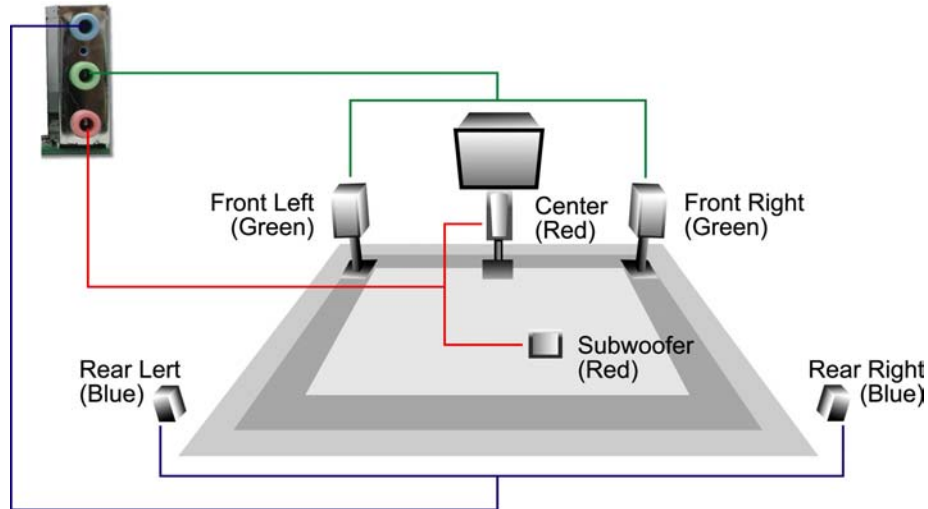



TV Output Connector (for AK79G MAX)

This motherboard comes with a TV Output connector which allows you to accept digital graphic input signal, and encodes, and transmit data through DVI or TV Output. Both NTSC and PAL TV formats are supported for this function. You may just install a TV Output module (as shown) to your back panel, connect S-Terminal or AV-terminal to your TV, then use it as your another monitor.

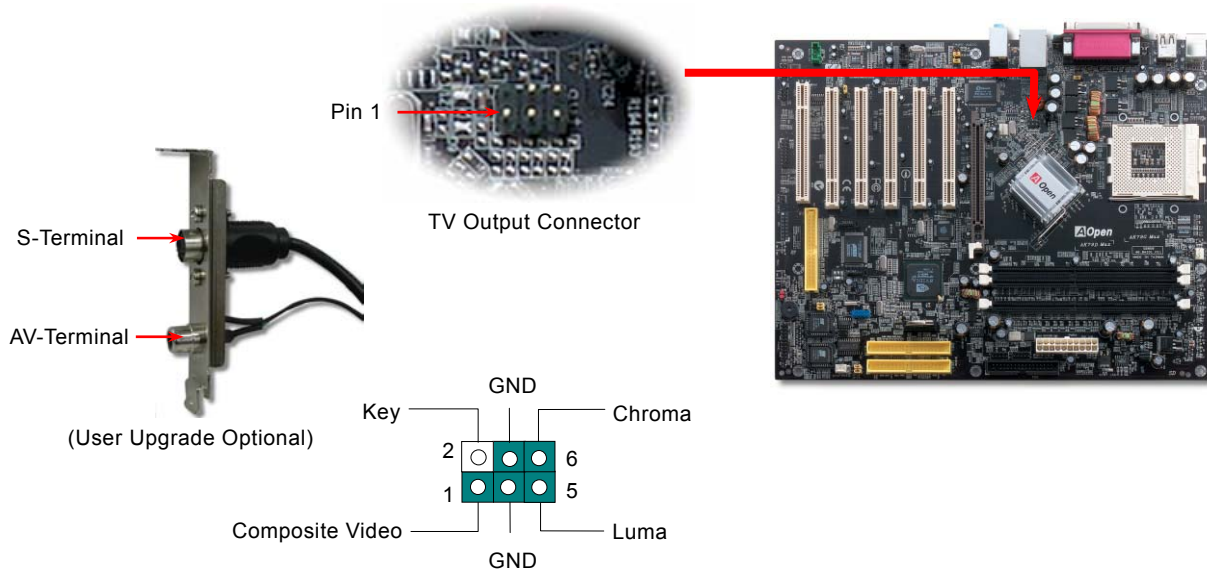

IrDA Connector

The IrDA connector can be configured to support wireless infrared module, with this module and application software such as Laplink or Windows 95 Direct Cable Connection, the user can transfer files to or from laptops, notebooks, PDA devices and printers. This connector supports HPSIR (115.2Kbps, 2 meters) and ASK-IR (56Kbps).

Install the infrared module onto the **IrDA** connector and enable the infrared function from BIOS Setup, UART2 Mode, make sure to have the correct orientation when you plug in the IrDA connector.

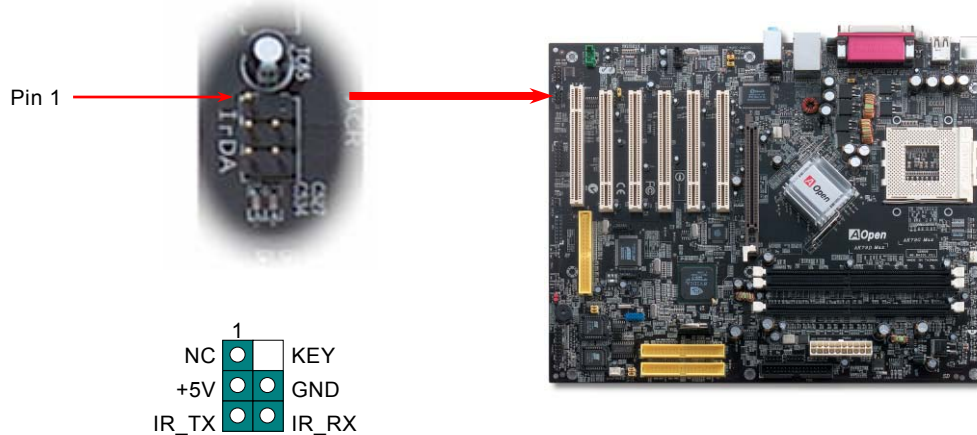

AGP (Accelerated Graphic Port) 8X Expansion Slot

Integrated GeForce4 MX Graphics, which provides the fastest integrated graphics performance and the most comprehensive set of features. This motherboard provides an [AGP](#) 8x slot targeted for high-performance 3D graphic. AGP uses both rising and falling edge of the 66MHz clock, for 4X AGP, the data transfer rate is 66MHz x 4bytes x 4 = 1056MB/s. AGP is now moving to AGP 8x mode, which is . You can also adjust AGP voltage in BIOS within a rage from 1.5V to 1.6V.

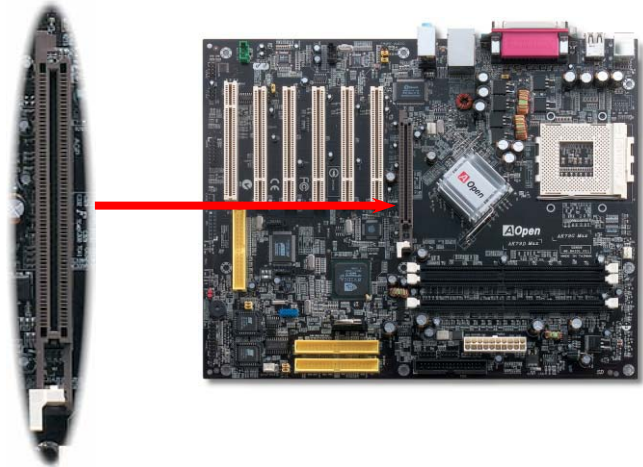

Note: Please note that when an extra AGP card is installed and the onboard AGP function in BIOS is disabled, the system can support DDR400/333/266; otherwise it only supports up to DDR333.

AGP Protection Technology and AGP LED

With the outstanding R&D ability of AOpen and its specially developed circuit, this model implements a blend new technology to protect your motherboard from being damaged by over-voltaging of AGP card. When AGP Protection Technology is implemented, this motherboard will automatically detect the voltage of AGP card and prevent your chipsets from being burnt out. Please note that if you install a AGP card with 3.3V, which is not supported, the AGP LED on the motherboard will light up to warn you the possible damage of the exceeding voltage. You may contact your AGP card vendor for further support.

Warning: It is strongly recommended not to install a AGP card with 3.3V, which is not supported, the LED3 will light up to warn you the possible damage.



AGP LED

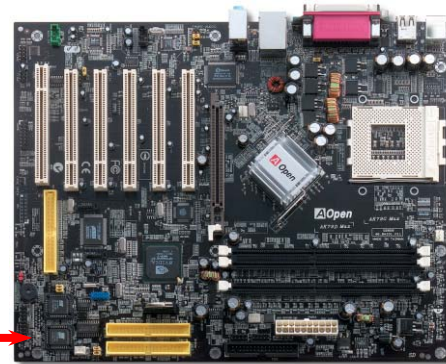

Support 10/100 Mbps LAN Onboard

On the strength of nVIDIA nForce2 LAN controller on chip (with RealTek RTL8201BL PHY), which is a highly-integrated Platform LAN Connect device, it provides 10/100M bps Ethernet for office and home use, the Ethernet RJ45 connector is located on top of USB connectors. The orange LED indicates the link mode, it lights when linking to network. The green LED indicates the transfer mode, and it lights when data is transferring. To enable or disable this function, you may simply adjust it through BIOS.

Green/Transfer

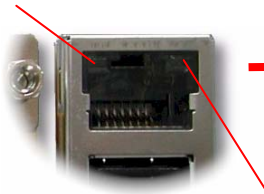

Orange/Link

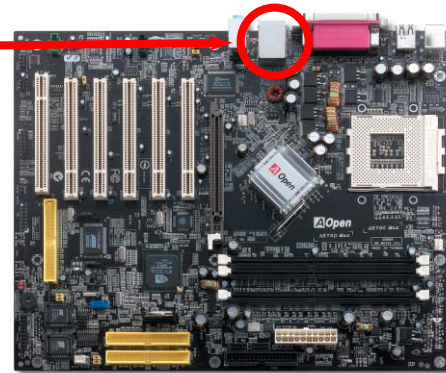

ACR (Audio and Communication Riser) Expansion Slot

Building on the PC motherboard riser architecture, ACR slot is backward compatible with AMR but beyond the limitation of it. The ACR specification is designed to support modem, audio, Local Area Network (LAN) and Digital Subscriber Line (DSL). On the strength of nVIDIA MCP-D controller on chip, which is a highly integrated Platform LAN Connect device, it provides 10/100M bps Ethernet for office and home use.

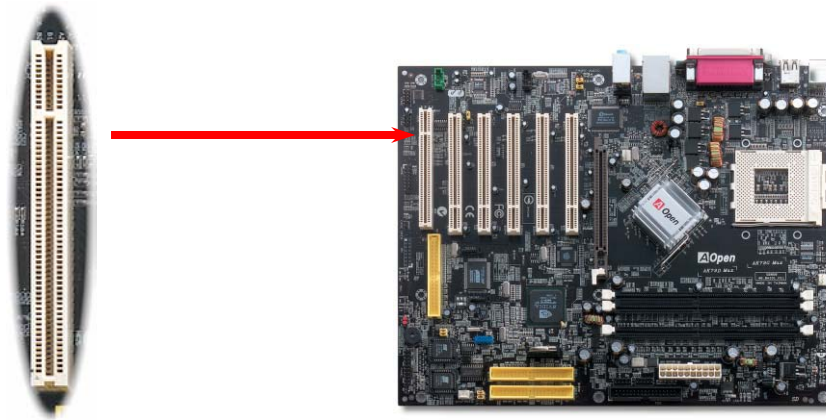

ACR Connector

Game Port Bracket Supported

This motherboard comes with a game port (Joystick-Midi) for you to connect any midi devices or joysticks. To use this function you have to have a joystick module and connect it with a game port cable to this port on the motherboard.

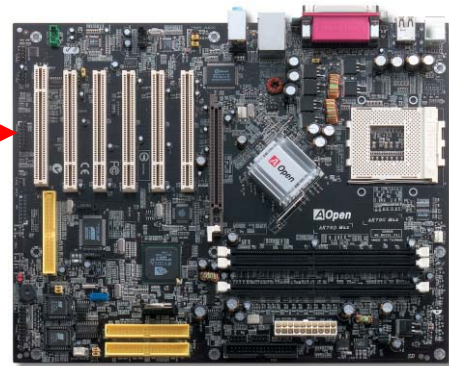
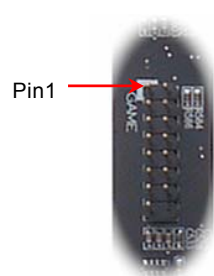

Game Port Connector

1		
+5V	●	+5V
JAB1	●	JBB1
JACX	●	JBCX
GND	●	MIDI_TXD
GND	●	JBCY
JACY	●	JBB2
JAB2	●	MIDI_RXD
+5V	●	KEY

Note: This picture is for example only; it may not exactly look the same with the motherboard you purchased.

Color Coded Back Panel

The onboard I/O devices are PS/2 Keyboard, PS/2 Mouse, serial ports COM1 and VGA, Printer, [USB](#), AC97 sound and game port. The view angle of drawing shown here is the back panel of the housing.

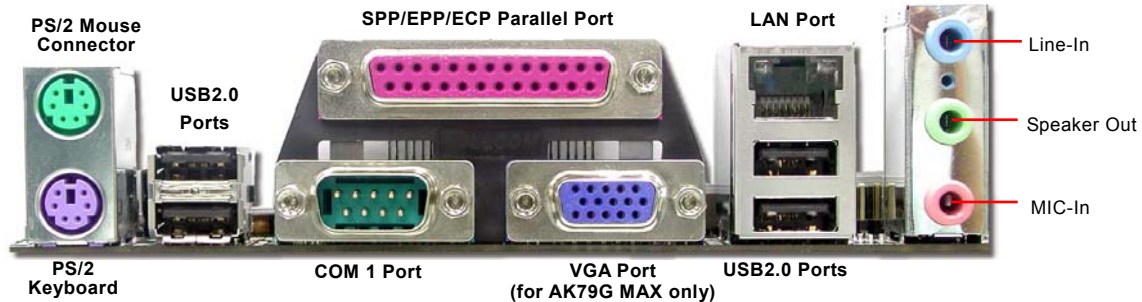

PS/2 Keyboard:	For standard keyboard, which is using a PS/2 plug.
PS/2 Mouse:	For PC-Mouse, which is using a PS/2 plug.
USB Port:	Available for connecting USB devices.
Parallel Port:	To connect with SPP/ECP/EPP printer.
COM1 Port:	To connect with pointing devices, modem or others serial devices.
VGA Connector:	To connect with PC monitor.
Speaker Out:	To External Speaker, Earphone or Amplifier.
Line-In:	Comes from the signal sources, such as CD/Tape player.
MIC-In:	From Microphone.
LAN Port:	Available for 10/100 LAN connection.

COM2 Connector

This motherboard provides two serial ports. One of them is on back panel connector, and the other is on the upper left of board. With proper cable, you can connect it to the back panel of chassis.

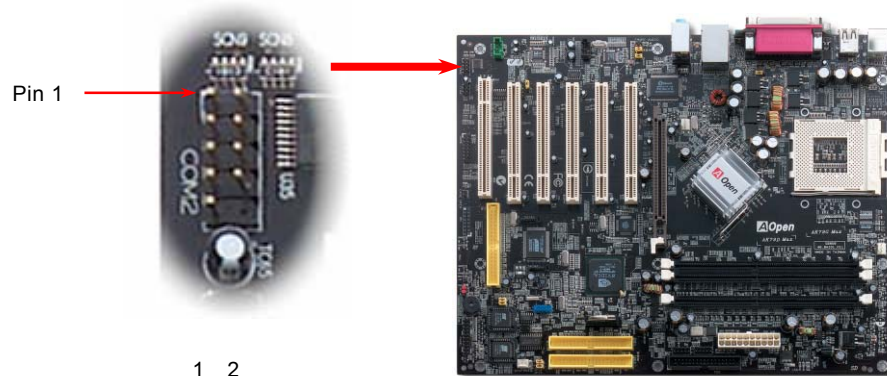

	1	2	
DCD#	●	●	SIN
SOUT	●	●	DTR#
GND	●	●	DSR#
RI#	●	●	CTS#
RTS#	●	□	

COM2 Connector



Support Front USB 2.0 Connector

This motherboard provides six [USB](#) 2.0 connectors to connect USB devices, such as mouse, keyboard, modem, printer, etc. There are four connectors on the back panel. You can use proper cables to connect the Front USB connector to USB modules or front panel of chassis.

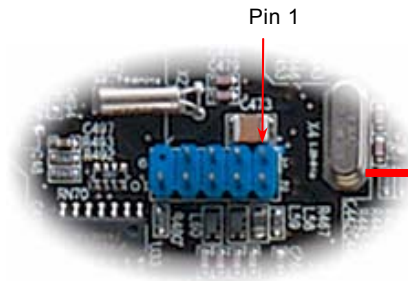

Pin 1

USB 2.0 Connector

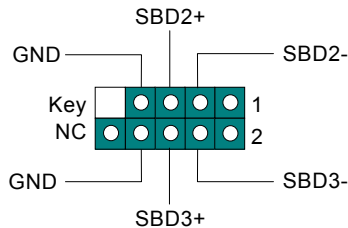
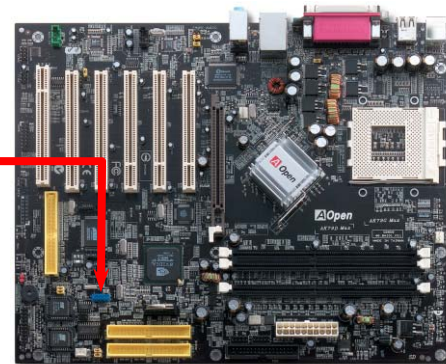

Note: Please note that if you would like to use USB devices (Example: keyboard, mouse etc.) under DOS environment, you must install driver comes with the devices to make it work.



Case Open Connector

The “CASE OPEN” header provides chassis intrusion-monitoring function. To make this function works, you have to enable it in the system BIOS, connect this header to a sensor somewhere on the chassis. So, whenever the sensor is triggered by lights or the opening of the chassis, the system will send out beep sound to inform you. Please be informed that this useful function only applies to advanced chassis, you may purchase an extra sensor, attach it on your chassis, and make a good use of this function.

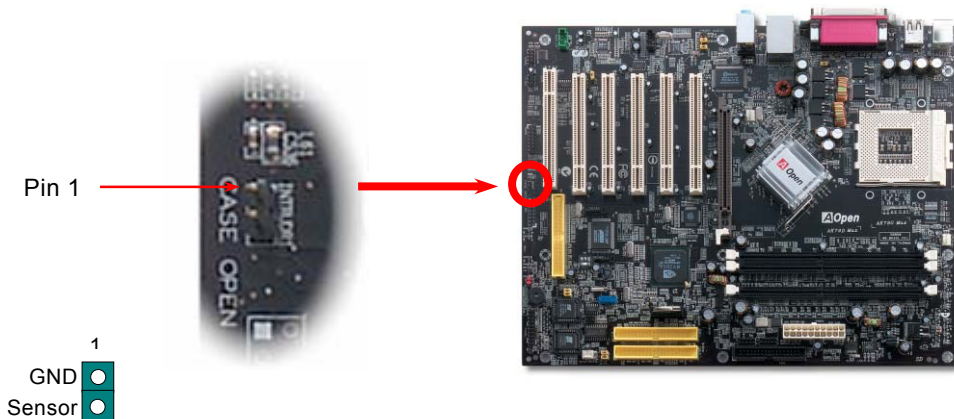

CD Audio Connector

This connector is used to connect CD Audio cable from CD-ROM or DVD drive to onboard sound.

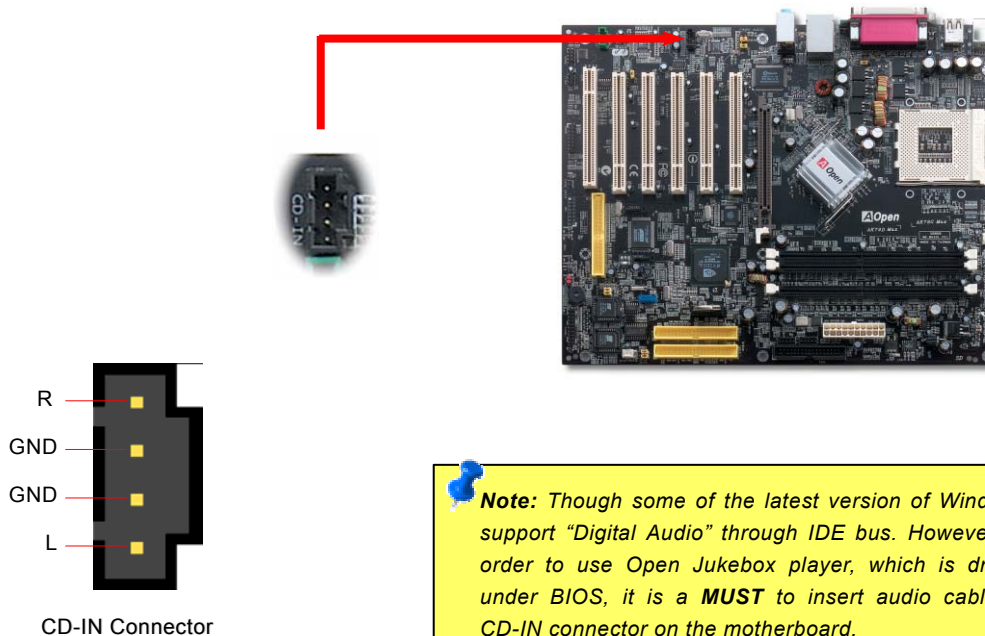

AUX-IN Connector

This connector is used to connect MPEG Audio cable from MPEG card to onboard sound.

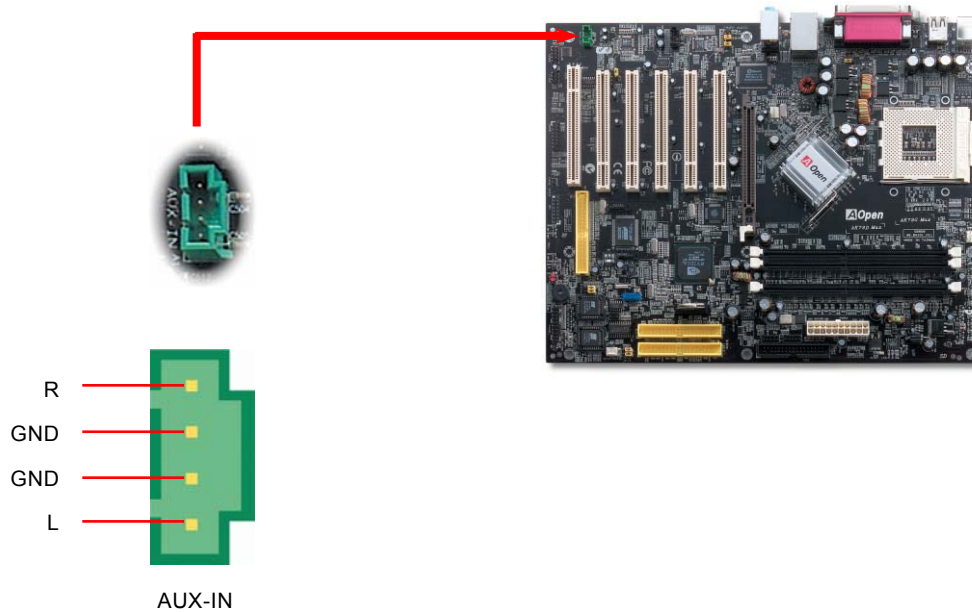

Front Audio Connector

If the housing has been designed with an audio port on the front panel, you'll be able to connect onboard audio to front panel through this connector. By the way, please remove 5-6 and 9-10 jumper caps from the Front Audio Connector before connecting the cable. Please do not remove these 5-6 and 9-10 yellow jumper caps if there's no audio port on the front panel.

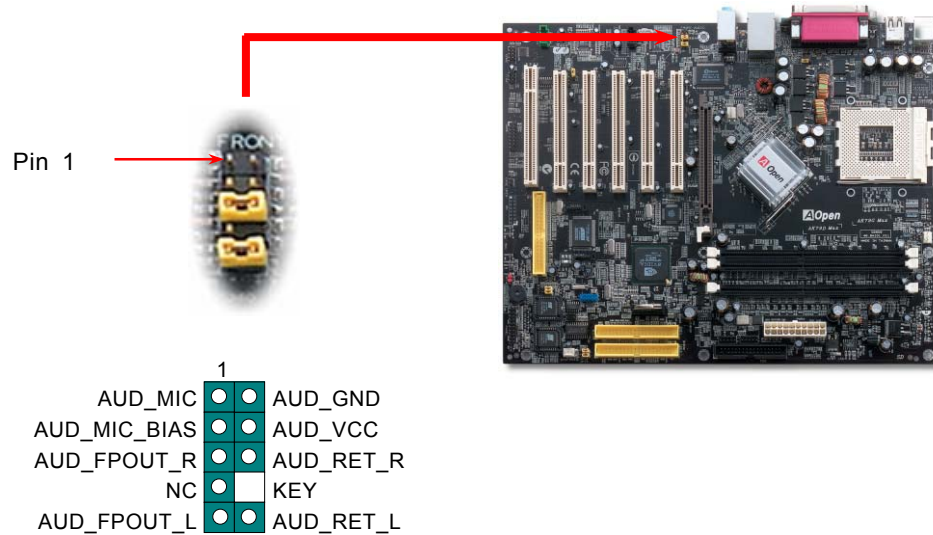

Battery-less and Long Life Design

This Motherboard implements [Flash ROM](#) and a special circuit that allows you to save your current CPU and CMOS Setup configurations without using the battery. The RTC (real time clock) can also keep running as long as the power cord is plugged. If you lose your CMOS data by accident, you can just reload the CMOS configurations from Flash ROM and the system will recover as usual.

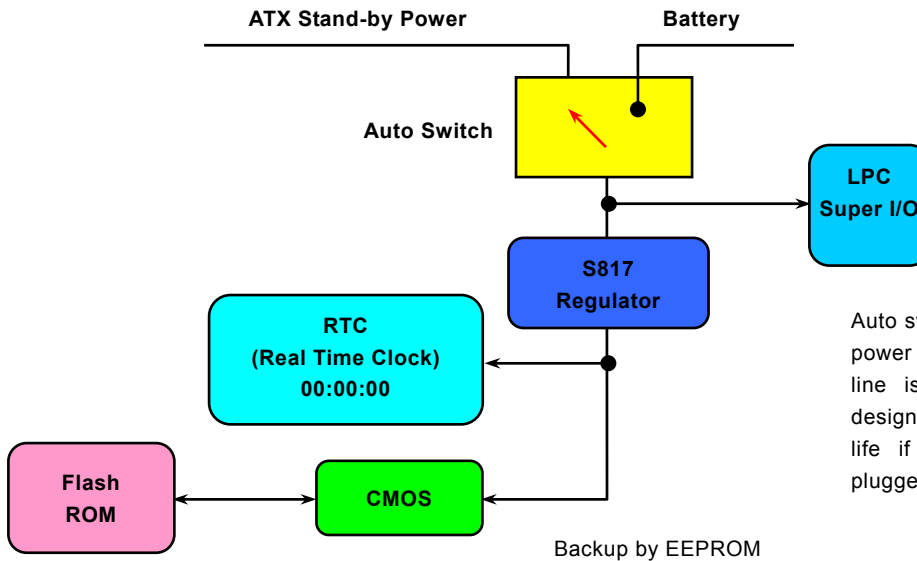

Auto switching to ATX standby power as long as AC power line is plugged. This smart design can increase battery life if you still had battery plugged on motherboard.

CPU Over-current Protection

Over Current Protection has been popularly implemented on ATX 3.3V/5V/12V switching power supply for a while. However, new generation CPU is able to use regulator of different voltages to transfer 12V to CPU voltage (for example, to 2.0V). This motherboard is with switching regulator onboard that supports CPU over-current protection, and it applies to 3.3V/5V/12V power supply for providing full line over-current protection.

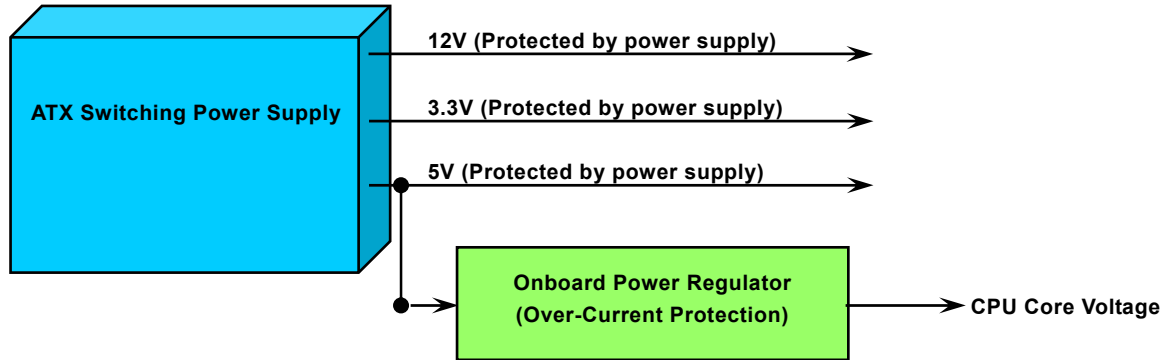

Note: Although we have implemented protection circuit try to prevent any human operating mistake, there is still certain risk that CPU, memory, HDD, add-on cards installed on this motherboard may be damaged because of component failure, human operating error or unknown nature reason. **AOpen cannot guaranty the protection circuit will always work perfectly.**

AOConfig Utility



AOOpen always dedicated to provide users a much friendlier computer environment. We now bring you a comprehensive system detective utility. AOconfig is a Windows based utility with user-friendly interface that allows users to obtain information of the operation system and hardware such as motherboard, CPU, memory, PCI devices and IDE devices. The powerful utility also displays the version of BIOS and firmware for your convenience of maintenance.

Moreover, AOconfig allows users to save information in *.BMP or *.TXT format which users may collect the system information in detail and send them to AOOpen directly for technical support or further diagnosis of system problem.

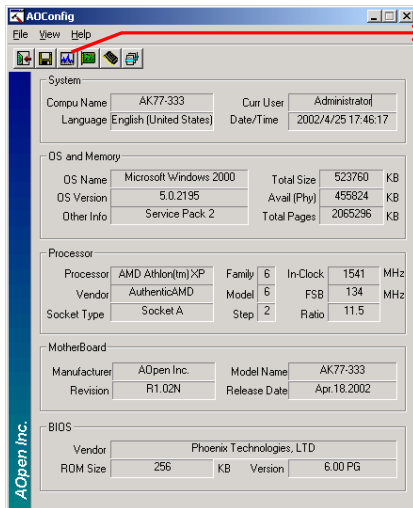

1. The system page shows the detail information of the motherboard, the operating system, the processor, and BIOS version.

2. The PCI device page shows the configurations of all PCI devices installed on your motherboard.

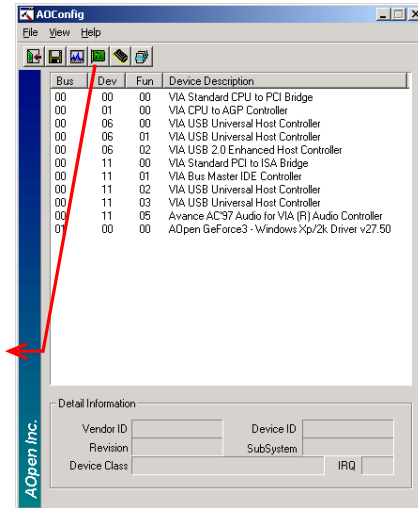

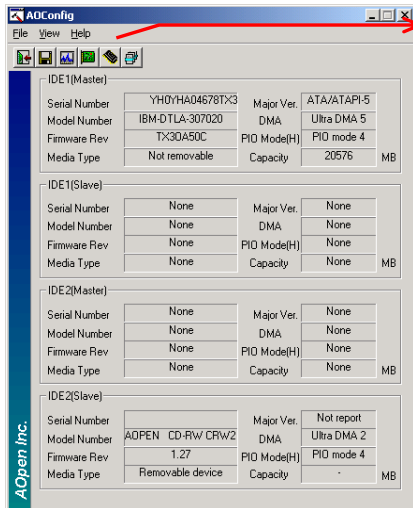

3. This page presents the IDE devices information, such as the serial number, the manufacturer, the firmware version, and capacity.

4. From this page, users may obtain the technical support information of AOpen. Moreover, detailed information could be saved in .bmp or .txt format.

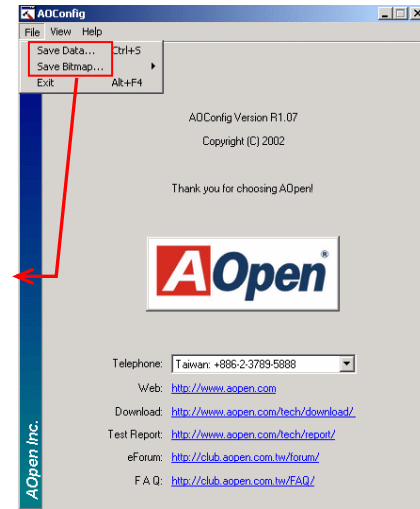

NOTE: AOconfig can be used in Windows 98SE/ME, NT4.0/2000 and Windows XP. Please be informed that AOconfig can only be operated in a system equipped with an AOpen motherboard. Meanwhile, all applications must be closed before starting AOconfig.

Resettable Fuse

Traditional motherboard has fuse for Keyboard and [USB](#) port to prevent over-current or shortage. These fuses are soldered onboard that user cannot replace it when it is damaged (did the job to protect motherboard), and the motherboard remains malfunction.

With expensive Resettable Fuse, the motherboard can resume back to normal function after fuse had done its protection job.

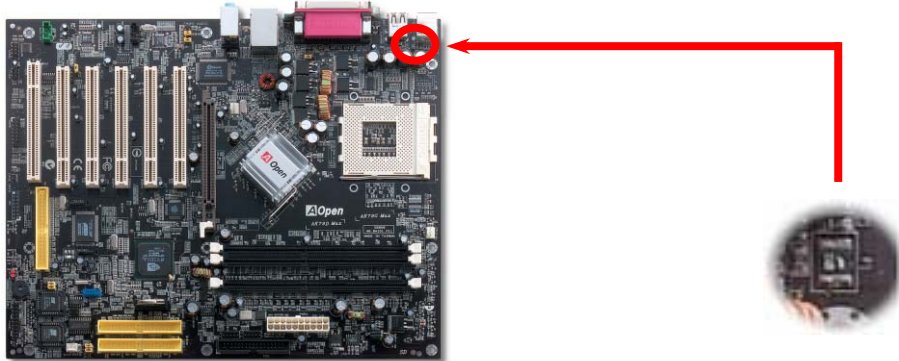

2200 μF Low ESR Capacitor

The quality of low ESR capacitor (Low Equivalent Series Resistance) during high frequency operation is very important for the stability of CPU power. The idea of where to put these capacitors is another know-how that requires experience and detail calculation.

Not only that, this motherboard implements 2200 μF capacitor, which is much larger than normal capacitor (1000 or 1500 μF) and it provides better stability for CPU power.

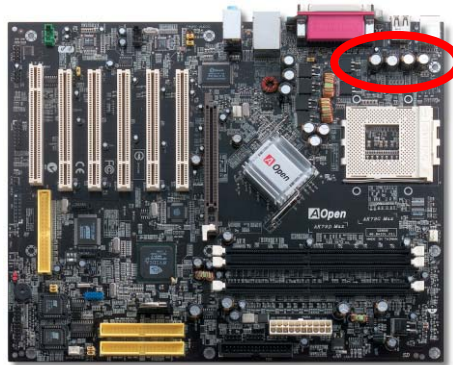

Enlarged Aluminum Heatsink

Cool down CPU and Chipset is important for system reliability. Enlarged aluminum heat sink provides better heat consumption especially when you are trying to over clocking the CPU.

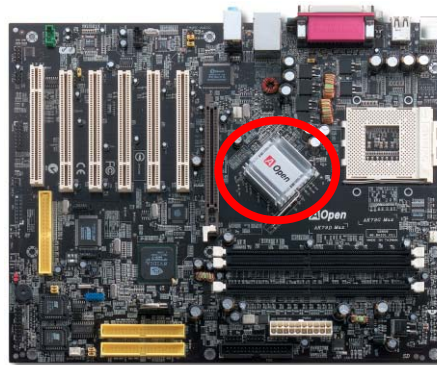

Open JukeBox Player



Here we are pleased to provide you a brand-new powerful interface—Open JukeBox. Without any cost you can have your PC turn into a fashionable CD player! This latest Open JukeBox motherboard aims at helping you directly operate your CD player on the PC

without any hassle of entering Windows operation system.



How Your Open JukeBox Works

The operation of Open JukeBox Player is the same as other CD players. By pressing specific keys on the keyboard you will find playing Open JukeBox Player couldn't be easier than the traditional CD Players. Below is the function description of respective buttons.



Power: Pressing **O**, to directly power off your computer with no hassle of entering Windows Operation System.

Boot: Pressing **B**, to intelligently boot to Windows Operation System for you.

Play: Pressing **A**, to start playing CD music.

Stop: Pressing **S**, to stop the music playing.

Pause: Pressing **P**, to pause the music playing temporarily.

Eject: Pressing **E**, to eject CD tray for you to change CD disc.

Repeat: Like other CD Players, pressing **R**, to shift the repeat mode.

Volume +/-: Pressing + or - to adjust the volume of playing music.

Rewind/Forward **← / →**: Pressing **arrow keys**, to rewind or forward the music.

Note: Though some of the latest version of Windows support "Digital Audio" through IDE bus. However, in order to use Open Jukebox player, which is driven under BIOS, it is a **MUST** to insert audio cable to CD-IN connector on the motherboard.

Your Open JukeBox Settings in BIOS

There are three Open JukeBox settings in BIOS as follows.

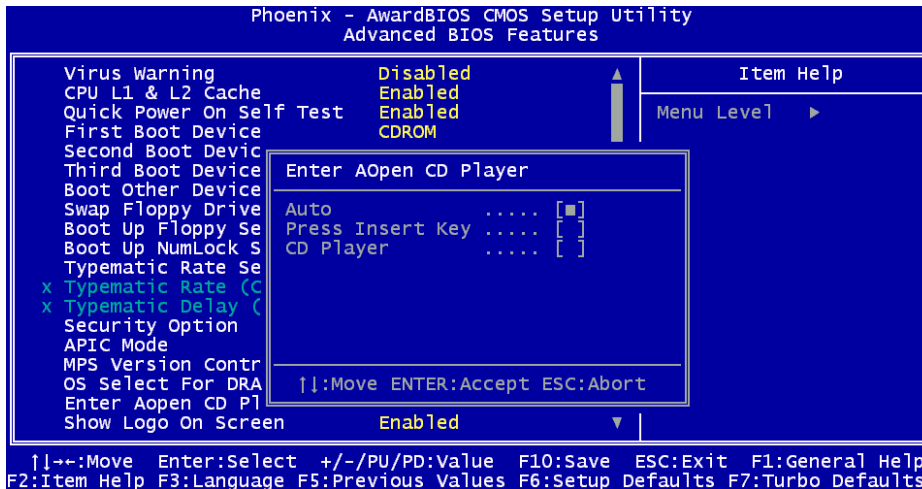

Auto: The default setting is “Auto” with which the Open JukeBox will automatically check the CD player every time you power on. The Open JukeBox will automatically be launched when it detects a music CD in your CD player.

Press Insert Key: Choosing this setting will allow a reminder message popped up on the screen during BIOS POST. It reminds you of pressing “Ins” key on your keyboard to start Open JukeBox Player; otherwise the system will launch the Windows Operation System.

CD Player: Choosing this setting allows the system to launch Open JukeBox Player every time you power on. However, by pressing **B** on your keyboard the Windows Operation System will be launched.

Your Open JukeBox EzSkin



Except these powerful functions above, Open JukeBox Player is also equipped with another fancy feature for you to change its "skin". You can download as many skins as you want from AOpen Website, and changing them whenever you want by using this useful utility – **EzSkin** – which may also be downloaded from our website.

Even more, you may design your own skins with innovative idea and sharing them to users around the world by uploading to our website. For further technical information, we welcome you to visit our website at

<http://english.aopen.com.tw/tech/download/skin>



Vivid BIOS technology



Have you been fed up with the conservative and immutable POST screen? Let's rule out the tradition idea that POST screen are stiff and frigid, and let AOpen show you the newly developed VividBIOS to experience the lively vivid colorful POST screen!

Unlike earlier graphic POST screen, which could occupy the whole screen and mask text information during POST, AOpen VividBIOS deals with graphics and texts separately, and makes them running simultaneously during POST. With this innovative design, VividBios now brings you a beautiful and sleek 256 colors screen without missing any important information shown on POST screen.

In addition, the limited space of BIOS ROM is another big issue. When all of the traditional BIOS can only show space-consuming and uncompressed Bitmap, AOpen has considerably tuned the BIOS to next generation, to recognize the smaller-sized GIF format and even dynamic-showing GIF animation.



Vivid BIOS shares the same fundamental technology with Open JukeBox CD Player, you may use the same EzSkin utility to

change your Vivid BIOS screen or to download your favorite Open JukeBox skin. If you see this little logo  shown beside your model name on the BIOS download page, <http://english.aopen.com.tw/tech/download/skin>, it is assured that your motherboard supports this innovative feature!

The noise is gone!! ---- SilentTek



As the clock of CPU keeps rocketing higher and higher, it inevitably brings higher heat and system temperature in a relative way. The way we deal with this heat problem, however, is to spare no effort to add one fan after another to protect our pampered system, expecting these fans could cool down our machine as much as they could.

But at the same time, we believe that same users are affected terribly by the irritating noises of these fans while working with their PC. As a matter of fact, we do not have to get our fans running at such a high speed in most cases; on the contrary, we

discovered that having your fans running at appropriate time and speed not only reduces the noise, but also consumes the least power the system needs, so as to prevent over-wasting of energy resource.

Today, AOpen Motherboard is honored to bring you a new overall solution, SilentTek, to make your system quiet. To collocate with hardware circuit, BIOS and the utility under Windows, SilentTek combined "Hardware-Status Monitoring", "Overheat Warning" and "Fan Speed Control" with user-friendly interfaces to provide you a perfect balance among noises, system performance and stability.

```
Phoenix - AwardBIOS CMOS Setup Utility
Silent PC/PC Health Status

CPU Warning Temp.      60° C/140° F
CPUFan1 Boot Speed    70% 3150 RPM
SYSFan2 Boot Speed    70% 3500 RPM
CPUFan1 OS Speed      100% 4500 RPM
SYSFan2 OS Speed      100% 5000 RPM
Fan Mode               Smart Control
x CPUFan1 Fixed Speed 100% 4500 RPM
x SYSFan2 Fixed Speed 100% 5000 RPM
CPU Set Temp.         40° C
SYS Set Temp.         30° C

CPU Kernel Temp.      69° C/156° F
CPU Temp.             47° C/116° F
SYS Temp.             31° C/107° F
CPUFAN1 Speed         4500 RPM
SYSFAN2 Speed         5000 RPM
SYSFAN3 Speed         5532 RPM
Vcore(V)              1.48 V

Item Help
Menu Level ▶
This is fan control mode during POST and Open Jukebox, after exiting the Jukebox, the fan will be set to Fan OS Speed.

[Full Speed]
Run in full speed.
[Smart Control]
According to the safety temperature you set below, fan speed will be controlled as slow as possible.

↑↓←→:Move  Enter:Select  +/-/PU/PD:Value  F10:Save  ESC:Exit  F1:General Help
F2:Item Help  F5:Previous Values  F6:Setup Defaults  F7:Turbo Defaults
```

The first image you have here is the Voltage Status page. You can find current status of all voltages and set your expected margins of warning level.

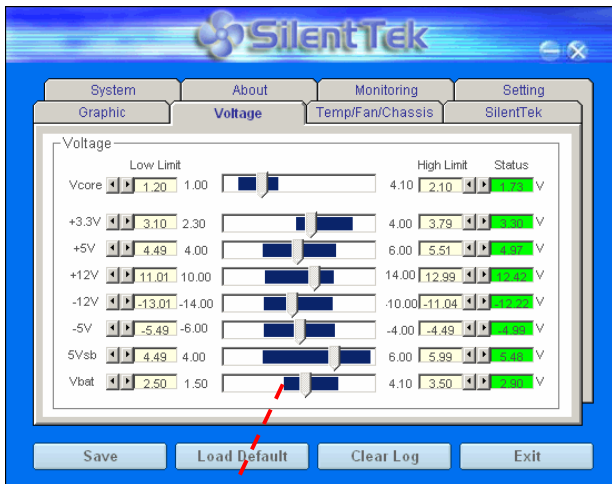

You may check your system voltage from the indicating bar here.

In "Temp/Fan/Case" page, you may get aware of the current temperature of CPU and the heat inside chassis. Also, you can check if fans are running properly.

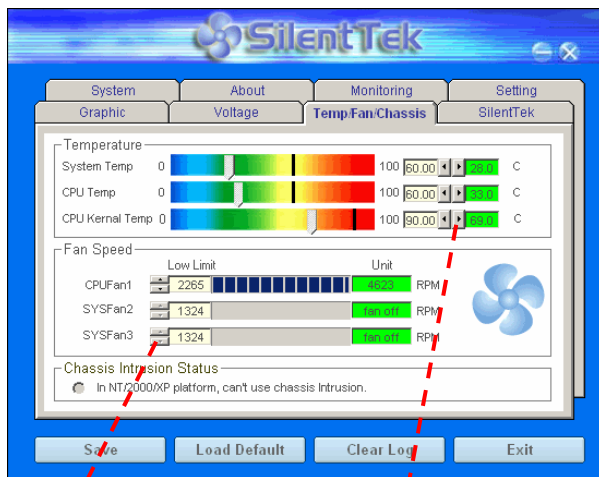

Of course, you may set your defaulted lowest margin for your fans and SilentTek would also pop up a message box to alarm you when the fan is rotating slower than this specified speed.

You may set the highest margin of your CPU and system temperature as default, and SilentTek would pop up a message box to alert you with alarm when the temperature goes beyond the specified margin.

The following page is surely the most important part of this utility. You may control the rotation speed of specific fans that you have got the options inside in this page.

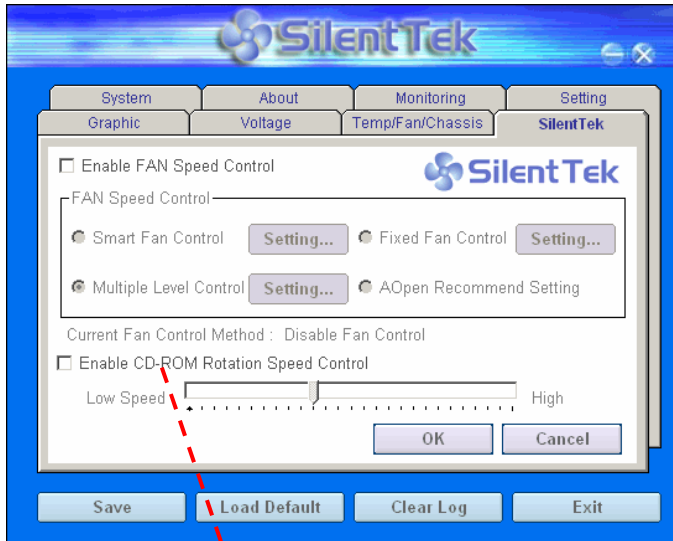

CD-ROM Rotation Speed Control: by enabling the CD-ROM Rotation Speed Control, you can adjust the rotation speed of your CD-ROM. When you set the speed to high level, the CD-ROM will work at its fastest speed and it will run at basic required speed while you set the value to low speed.

1. **Smart FAN Control:** This is the default setting of SilentTek and can be used for any branded computer housing. With a special algorithm developed by AOpen, the fan speed is automatically adjusted by the factors of CPU and ambient temperature. Ease-of-use and trouble free at your service.
2. **Fixed FAN Control:** Under this setting, a desired fan speed is set fixed when operating.
3. **Multiple Level Control:** This is the most versatile setting that allows you to set fan speed in relation to temperature. You may find that this setting fits you best.
4. **AOpen Recommend Setting:** This setting is designed specifically for AOpen housing. A series of lab tests were conducted under the real world scenario to determine optimum fan speed to reduce noise level within CPU working condition and temperature. Most of the time, the fan would remain still when CPU is not fully utilized.

Note: Due to hundreds different brands of fan on the market, inaccuracy may happen in some cases when you had your rotation speed adjusted. It is still under the criterion and please rest assured that it won't cause any problem to your system.

EzClock**NEW!**

Have you ever thought how great it would be if you can adjust the frequency setting on your motherboard under Windows environment and be a real master of your system? Everybody knows that the ratio and frequency setting are key factors to influence the system performance, however, it's absolutely not an easy task for an amateur to adjust the setting value. On most traditional motherboards, you have to get into BIOS screen for the frequency and reboot the system again and again. But from now on, you don't have to surfer the boring stuffs anymore.

With brand-new and user-friendly EzClock that AOpen specially designs for his users, you can adjust those important values as you please and think of suitable. This tailor-made EzClock allows you to set the voltage and frequency of CPU, VGA, PCI and memory under Windows environment as well as in BIOS setting page; even better, those settings will be displayed realtime. Having this handy EzClock, you can monitor the system when you're fine-tuning the performance of your system. It provides you detailed and necessary information. Now let's take a look how it works on utility, BIOS and POST.



How You Adjust the Settings in EzClock Utility

In EzClock utility, you can adjust CPU Front Side Bus (FSB), the voltage and frequency of VGA, AGP, PCI and DRAM. Besides, the CPU related information such as CPU voltage, temperature and CPUFAN rotation speed will also be displayed on this utility.

CPU Color Bars:

The color bar will light on and show different colors as values change. On default values, it will show green.



On the left circle area shows Ratio, FSB and frequency information about CPU. When the values are set to factory default, the light on the top and bottom of the circle will show green and it will vary as you change these CPU settings.

CPU Ratio, FSB and frequency displaying area:

You can adjust CPU FSB here by entering preferred value.

On the right part of the panel is the section that you adjust the settings of VGA, AGP, PCI and memory. To adjust the voltage and clock frequency of those installments, you can press “-” or “+” on corresponding items. The color parts represent the situation of values. The higher value you set, the light on the color bar goes to right and turns red. After finishing those value settings, you can press “S” button on the upper right hand corner to save changes to CMOS.

VGA, AGP, PCI and DRAM Voltage / Clock Area:

Pressing “-” and “+” buttons, you can adjust the voltage and clock frequency values of onboard VGA, AGP, PCI and DRAM.

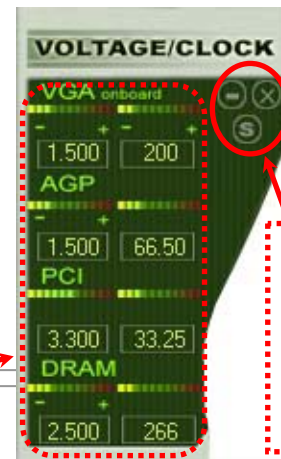

Control buttons:

“-” button allows you to minimize the utility and “X” button to close the utility. Pressing “S” button you can save the changes to CMOS.

On the bottom rectangular panel represents CPU fan speed, CPU voltage and CPU temperature. The three color bars on the right hand side will light on according to operation temperature. Please refer to the picture shown above.

CPU Color Bars:
The color bars will light on according to CPU operation temperature.

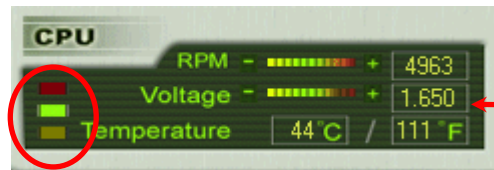

CPU Fan, Voltage and Temperature:
representing CPU fan speed, CPU voltage and CPU temperature in Celsius and Fahrenheit degrees.

How You Adjust the Settings in BIOS

Apart from EzClock utility, the voltage and frequency values of CPU, PCI and memory can also be adjusted on BIOS page. By pressing “+”, “-”, “PgUp” or “PgDn” keys, you can adjust the frequency values of CPU Bus, PCI Bus and DRAM.

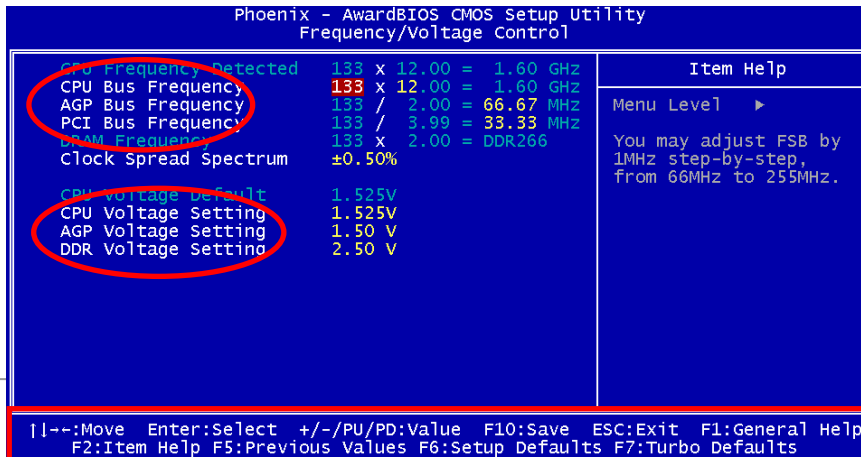

Also, the same keys help you adjust the voltage of CPU and DDR settings. Some values may change while you adjust the settings. You can press “F10” to save the changes you’ve made.

Function Keys
Description



How Your Boot Screen Looks Like

After you finish setting BIOS, these setting values will be displayed on the boot screen like the shown picture here.

Every time you boot your system, both default and current settings will pop up on the screen. Your personal settings that had been adjusted earlier will be highlighted; thus, you can have clear idea how your system functions and monitor your system more easily.

Current values of your system

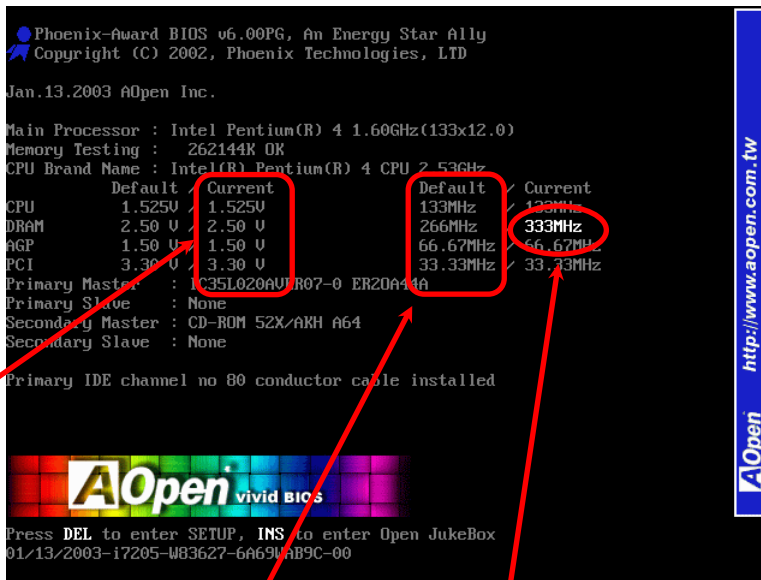

Default settings of this motherboard

The highlighted setting value you manually adjust

AOpen <http://www.aopen.com.tw>

Driver and Utility

There are motherboard drivers and utilities included in AOpen Bonus CD. You don't need to install all of them in order to boot your system. But after you finish the hardware installation, you have to install your operation system first (such as Windows 2000/XP) before you can install any drivers or utilities. Please refer to your operation system's installation guide.

Auto-run Menu from Bonus CD

You can use the auto-run menu of Bonus CD. Choose the utility and driver and select model name.

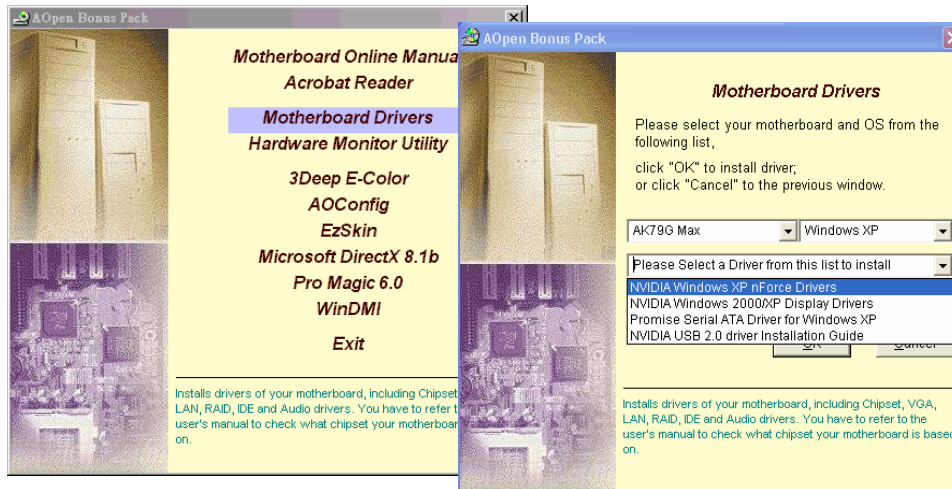

nVIDIA nForce Drivers

This nForce driver is an all in one package, which contains the below components:

GPU driver, Audio driver, Audio utilities, Network driver, GART driver, SMBus driver, Memory controller driver



NVIDIA Windows 98/ME/2000/XP Display Driver

For Display Driver of 98/ME/2000/XP, please use this driver for installation

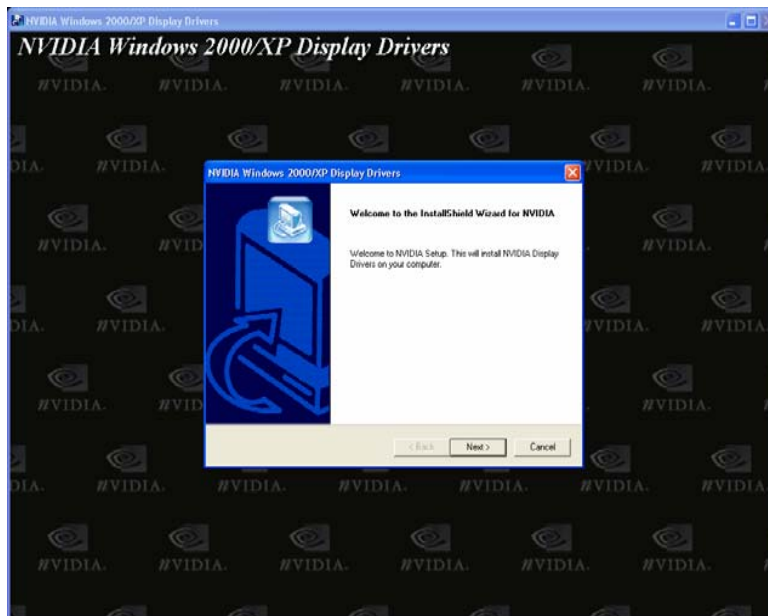

Installing Promise SATA150 Driver in Existing Windows XP/2000/ME/98/NT4.0 System

Windows XP Installation Guide

Installing Driver in Existing Windows XP System

WARNING: If you will be moving the boot drive containing the existing Windows XP operating system to the SATA150 connector, the SATA150 driver **MUST** be loaded on to this hard drive while it is still attached to your existing hard drive controller. Do not attach this drive or any other hard drive to the SATA150 controller before completing this step.

After enabling the SATA150, Windows XP setup will show a "Found New Hardware" dialog box. Under Windows XP, "Mass Storage Controller" will be displayed.

1. Click on "Next," and from the generated list box, choose "Install from a list or special location (Advanced)"
2. Click on "Next," and from the generated choices, choose "Include this location in the search:"
3. Insert the Promise SATA150 driver diskette into drive A:.
4. Type "A:\\" in the text box that appears. Press "OK ".
 - 3a. Insert the Bonus CD in CD-ROM.
 - 4a. Type "[CD-ROM]:\Driver\Promise\SATA150\Driver\WinXP" in the text box that appears. Press "OK ".



5. Click on "Next." A message informing you that Windows XP has found "WinXP Promise SATA TX2plus (tm) IDE Controller" should appear.
6. When the New Hardware Wizard has finished installing the Promise SATA150 software, click on "Finish"

Confirming Windows XP Installation

1. From Windows XP, open the Control Panel from "My Computer".
2. Click on "Performance and maintenance".
3. Click on the "System" icon.
4. Choose the "Hardware" tab, and then click the "Device Manager" tab.
5. Click the "+" in front of "SCSI controllers". "WinXP Promise SATA TX2plus (tm) IDE Controller" should appear.

Windows 2000 Installation Guide

Installing Driver During New Windows 2000 Installation

1. Start the installation:
 - a. Floppy Install: Boot the computer with the Windows 2000 installation diskettes.
 - b. Floppyless Install: Boot from floppy and type "WINNT". After files have been copied, the system will reboot. On the reboot, press <F6> after the message "Setup is inspecting your computer's hardware configuration..." appears.
 - c. CD-ROM Install: Boot from the CD-ROM. Press <F6> after the message "Press F6 if you need to install third party SCSI or RAID driver" appears.
2. When the "Windows 2000 Setup" window is generated, press "S" to Specify an Additional Device(s)
3. Insert the Promise SATA150 driver diskette into drive A: and press "Enter" key.
4. Use "↑" or "↓" to choose "Win2000 Promise SATA TX2plus (tm) IDE Controller" from the list that appears on screen, and then press the "Enter" key.
5. The Windows 2000 Setup screen will appear again saying "Setup will load support for the following mass storage devices:"
The list will include "Win2000 Promise SATA TX2plus (tm) IDE Controller".

NOTE: If you need to specify any additional devices to be installed, do so at this time. Once all devices are specified, continue to the next step -

6. From the Windows 2000 Setup screen, press the Enter key. Setup will now load all device files and then continue the Windows 2000 installation.

Installing Driver in Existing Windows 2000 System

WARNING: If you will be moving the boot drive containing the existing Windows 2000 operating system to the SATA150 connector, the SATA150 driver MUST be loaded on to this hard drive while it is still attached to your existing hard drive controller. Do not attach this drive or any other hard drive to the SATA150 connector before completing this step.

After enabling the SATA150 IDE controller and rebooting your system, Windows 2000 setup will show a "New Hardware Found" dialog box. Under Windows 2000, "PCI Mass Storage Controller" will be displayed.

1. Choose "Search for a suitable driver for my device (Recommended)". from the list, and then press "Enter".
2. Choose "Specify a location." and then press "Next"
3. Choose "Mass Storage controller" and press "next" and next screen press "finish"

4. Insert the Promise SATA150 driver diskette into drive A:.
5. Type "A:\\" in the text box that appears. Press " OK " .
 - 4a. Insert the Bonus CD in CD-ROM.
 - 5a. Type "[CD-ROM]:\Driver\Promise\SATA150\Driver\Win2000" in the text box that appears. Press "OK " .
6. Click on "Next." A message informing you that Windows has found "Win2000 Promise SATA TX2plus (tm) IDE Controller" should appear.
7. Click on "Next," and then on "Finish."

Confirming Windows 2000 Installation

1. From Windows 2000, open the Control Panel from "My Computer" followed by the System icon.
2. Choose the "Hardware" tab, and then click the "Device Manager" tab.
3. Click the "+" in front of "SCSI controllers". "Win2000 Promise SATA TX2plus (tm) IDE Controller" should appear.



Installing Drivers During Windows Me Installation

The following details the installation of the Serial ATA drivers while installing Windows Me (with the Serial ATA controller is enabled already).

1. Install Windows Me fully.
2. After installation, go the "Start" menu and choose "Settings."
3. From the "Settings" menu, choose "Control Panel."
4. In the "Control Panel" window, double-click on the "System" icon.
5. In the "System" window, choose the "Device Manager" tab.
6. In the hierarchical display under "Other Devices" is a listing for "PCI Mass Storage Controller." Choose it and then press the "Properties" button.
7. Choose "Reinstall Driver," and then press "Next."
8. Choose "Specify the location of the driver (Advanced)," then press "Next".
9. Insert the Promise SATA150 driver diskette into drive A:
10. Choose "Specify a Location," and then type "A:\"
 - 9a. Insert the "Bonus CD" in CD-ROM.
 - 10a. Choose "Specify a Location," and then type "[CD-ROM]:\Driver\Promise\SATA150\Driver\Win98-Me" in the text

box.

11. Press the "Next" button. A message informing you that Windows Me has found "Win98-ME Promise SATA150 TX2plus(tm) IDE Controller" should appear.
12. Press "Next," then "Finish".

Confirming Driver Installation in Windows Me

To confirm that the driver has been properly loaded in Windows Me, perform the following steps:

1. Choose "Settings" from the "Start" menu.
2. Choose "Control Panel," and then double-click on the "System" icon.
3. Choose the "Device Manager" tab, and then click the "+" in front of "SCSI & RAID controllers".
"Win98-ME Promise SATT150 TX2plus(tm) IDE Controller" should appear.



Installing Drivers During Windows 98 SE Installation

The following details the installation of the Serial ATA drivers while installing Windows 98 SE (with the SATA controller is enabled already).

1. After enabling the Serial ATA controller and configuring the hard drive(s), partition and format your hard drive(s), if necessary.
2. Install Windows 98 SE normally.
3. After installation, go the "Start" menu and choose "Settings."
4. From the "Settings" menu, choose "Control Panel."
5. In the "Control Panel" window, double-click on the "System" icon.
6. In the "System" window, choose the "Device Manager" tab.
7. In the hierarchical display under "Other Devices" is a listing for "PCI Mass Storage Controller." Choose it and then press the "Properties" button.
8. Choose "Reinstall Driver," and then press "Next."
9. Choose "Search for a better driver than the one your device is using now (recommended)," then press "Next."
10. Insert the Promise SATA150 driver diskette into drive A:.
11. Choose "Specify a Location," and then type "A:\"

10a. Insert the "Bonus CD" in CD-ROM.

11a. Choose "Specify a Location," and then type "[CD-ROM]:\Driver\Promise\SATA150\Driver\Win98-Me" in the text box.

12. Press the "Next" button. A message informing you that Windows has found "Win98-ME Promise SATA150 TX2plus(tm) IDE Controller" should appear.

13. Press "Next," then "Finish".

Confirming Driver Installation in Windows 98

To confirm that the driver has been properly loaded in Windows 98, perform the following steps:

1. Choose "Settings" from the "Start" menu.
2. Choose "Control Panel," and then double-click on the "System" icon.
3. Choose the "Device Manager" tab, and then click the "+" in front of "SCSI controllers." "Win98-ME Promise SATA150 TX2plus(tm) IDE Controller" should appear.



Windows NT 4.x Installation Guide

Installing Drivers During New Windows NT 4.0 Installation

1. Start the system installation by booting from the Windows NT disk:
 - a. Floppy install: boot the system with the Windows NT installation diskettes.
 - b. Floppyless install: boot from floppy and type "WINNT /B". After files have been copied, the system will reboot. On the reboot, press the "F6" key when the message "Setup is inspecting your computer's hardware configuration..." appears.
 - c. CD-ROM disk install: boot from the CD-ROM disk and press the "F6" key when the message "Setup is inspecting your computer's hardware configuration..." appears.
2. When the "Windows NT Setup" window is generated, press "S" to specify an Additional Device(s).
3. Use "↑" or "↓" to select "Other" and press the "Enter" key.
4. Insert the driver diskette into drive A: and press the "Enter" key.
5. Choose "WinNT Promise SATA TX2plus (tm) IDE Controller" from the list that appears on screen, and then press the "Enter" key.
6. The Windows NT Setup screen will appear again saying, "Setup will load support for the following mass storage devices:" The list will include "WinNT Promise SATA TX2plus (tm) IDE Controller".

NOTE: If you need to specify any additional devices to be installed, do so at this time. Once all devices are specified, continue to the next step.

7. From the Windows NT Setup screen, press the Enter key. Setup will now load all device files and then continue the Windows NT installation.
8. After a successful installation, the "SCSI Adapter Setup" box will show that the "WinNT Promise SATA TX2plus (tm) IDE Controller" driver has been installed.

Installing Drivers with Existing Windows NT 4.0

WARNING: If you wish to use your current bootable drive with the Windows NT4 operating system on the SATA150, perform the steps below while the boot drive is still attached to your existing onboard IDE controller. Do not attach any drives to your SATA150 until the steps below are complete.

1. Choose "Settings" from the "Start" menu.
2. Choose "Control Panel" from the "Settings" menu.
3. Double-click on the "SCSI Adapters" icon, which generates the "SCSI Adapters" dialog box.
4. Choose "Drivers," and then press "Add."

5. In the "Install Drivers" dialog box, press "Have Disk..."
6. When the "Install From Disk" appears, Insert the driver diskette into drive A:, then choose "OK."
7. When the "Install Driver" dialog box appears, select "WinNT Promise SATA TX2plus (tm) IDE Controller" and then press "OK".
8. When the "Select SCSI Adapter Option" dialog box appears, press "Install."
9. After a successful installation, the "SCSI Adapter Setup" box will show that the "WinNT Promise SATA TX2plus (tm) IDE Controller" driver has been installed.
10. Power off your system, and then attach your hard drive(s) to the SATA150 controller.

Installing USB2.0 Driver in Existing Windows XP System

* Windows XP Installation Guide

NOTICE:

If you have install Windows XP Service Pack1 , it is not necessary to install USB 2.0 driver.

Because USB2.0 driver was packaged in Service Pack1

Installing Driver in Existing Windows XP System

Please follow these directions for a smooth installation of the USB 2.0 package.

After enabling the USB 2.0, Windows XP setup will show a "Found New Hardware" dialog box. Under Windows XP, "Universal Serial Bus (USB) Controller" will be displayed.

1. Click on "Next," and from the generated list box, choose "Install from a list or special location (Advanced)", click "Next"
2. Click on "Next," and from the generated choices, choose "Include this location in the search:"
3. Insert the Bonus CD in CD-ROM.
4. Type "[CD-ROM]:\Driver\Nvidia\USB2.0\WinXP" in the text box that appears.
5. Click on "Next." A message informing you that Windows XP has found "NVIDIA PCI to USB Enhanced Host Controller W/ Filter FPGA (3616)" should appear.
6. When the New Hardware Wizard has finished installing the USB driver, click on "Finish"

Installing USB 2.0 Driver in Existing Windows 98/ME/2000 System

For USB 2.0 driver for Windows 98/ME/2000, please use this driver for installation

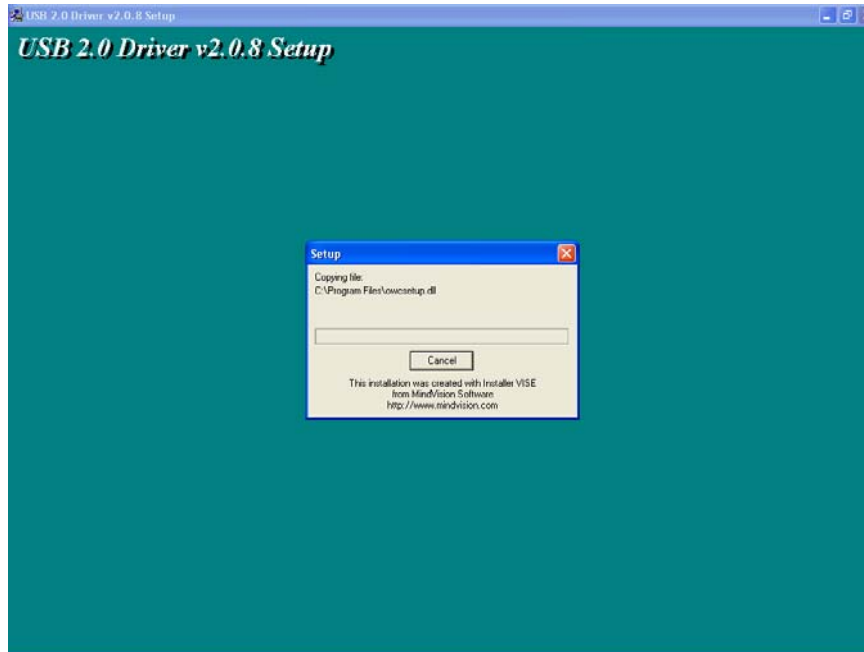

Phoenix Award BIOS

System parameters can be modified by going into [BIOS](#) Setup menu, this menu allows you to configure the system parameters and save the configuration into the 128 bytes CMOS area, (normally in the RTC chip or in the main chipset).

The Phoenix AwardBIOS™ that installed in the [Flash ROM](#) of the motherboard is a custom version of an industry standard BIOS. The BIOS provides critical low-level support for standard devices such as hard disk drives, serial and parallel ports.

Most BIOS setting of this model had been optimized by AOpen's R&D engineering team. But, the default setting of BIOS still can't fine-tune the chipset controlling the entire system. Hence, the rest of this chapter is intended to guide you through the process of configuring your system using setup procedures.

[To enter to BIOS setup menu](#), press when [POST \(Power-On Self Test\)](#) screen is shown on your monitor.

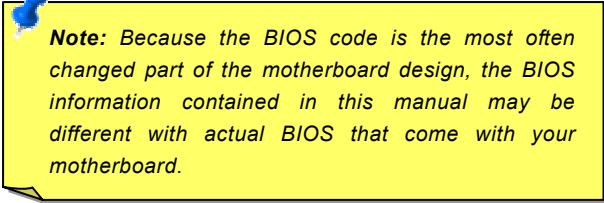

Note: *Because the BIOS code is the most often changed part of the motherboard design, the BIOS information contained in this manual may be different with actual BIOS that come with your motherboard.*

How To Use Phoenix Award™ BIOS Setup Program

Generally, you can use the arrow keys to highlight items that you want to choose, then press <Enter> key to select, and use the <Page Up> and <Page Down> key to change setting value. You also can press <F1> key for help and press <Esc> key to quit Phoenix Award™ BIOS setup program. The following table provides details about how to use keyboard in the Phoenix Award™ BIOS setup program. By the way, all products of AOpen also provides a special function in the BIOS setup, you can press <F3> key selecting preferred menu language to display.

Key	Description
Page Up or +	Changing setting to next value or increase the value.
Page Down or -	Changing setting to previous value or decrease value.
Enter	Select the item.
Esc	1. In main menu: Quit and don't save any change. 2. In sub menu: Exit current menu to main menu.
Up Arrow	Highlight previous item.
Down Arrow	Highlight next item.
Left Arrow	Move the light bar to left side of menu.
Right Arrow	Move the light bar to right side of menu.
F1	Get menu or item help description.
F3	Changing menu language.
F5	Load previous setting value from CMOS.

Key	Description
F6	Load Setup Defaults setting value from CMOS.
F7	Load turbo setting value from CMOS.
F10	Save changed setting and exit setup program.

How To Enter BIOS Setup

After you finish the setting of jumpers and connect correct cables. Power on and enter the BIOS Setup, press during POST (Power-On Self Test). Choose "Load Setup Defaults" for recommended optimal performance.

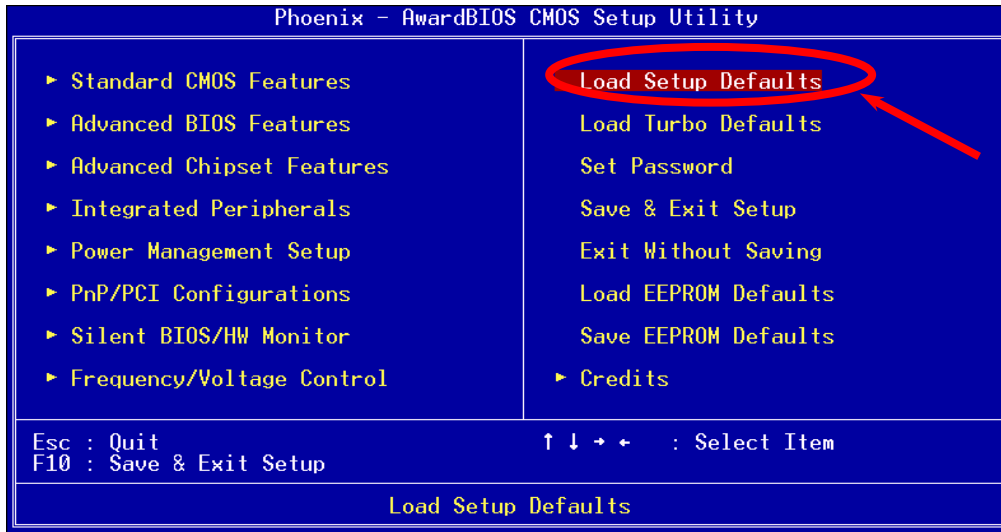

Warning: Please avoid of using "Load Turbo Defaults", unless you are sure your system components (CPU, SDRAM, HDD, etc.) are good enough for turbo setting.

WinBIOS Utility







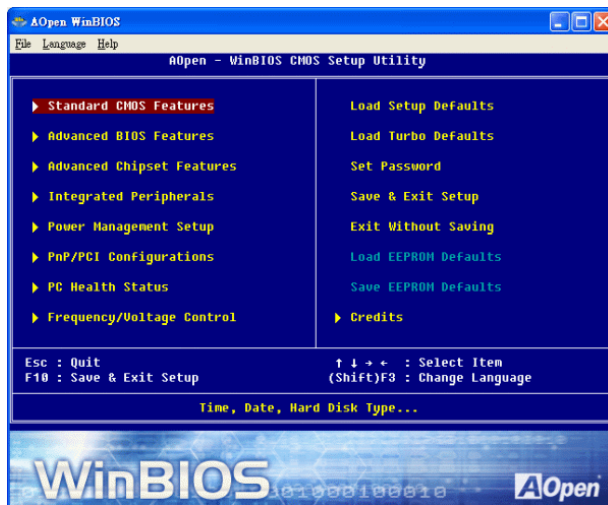

In the past, users have to keep punching the DEL key at a good timing during POST (Power-On-Self-Test) screen to get into the BIOS, which is inconvenient and clumsy. From now on, AOpen provides an easier way to configure your BIOS. WinBIOS is a customized utility for running exclusively on AOpen motherboards, which allows you to setup your BIOS under Windows environment. Designed with traditional-BIOS-alike interface, you may adjust BIOS parameter with clear descriptions for each item.

WinBIOS is natively designed with multi-language support. There are various widely-use languages provided on our website for your downloading, which also helps to prevent wrong settings caused by misunderstanding of the languages. The only thing you have to do is to visit our official website and download your respective language pack (of few KB size), then double-click on it to activate the support with your chosen language.

Moreover, with high scalability, either for newly bought motherboard or the latest BIOS version with new function, you don't have to re-install the whole program again and again. All you have to do is to grab the latest profile from our website, simply double-click on it as well to support the latest version of your BIOS. You don't have to spend any extra effort to have your motherboard supported by WinBIOS.



Function keys:

It's definitely easy to handle WinBIOS as if you're using traditional BIOS setting. Users can use the arrow keys such as     to move around the items in WinBIOS screen. And use  , "+" or "-" to change the setting value if they are available. Press  to get back to the previous screen. Furthermore, the hotkeys shown in the table may help you and save your time. Some settings may not come into effect until you reboot your system.

Hotkey	Function Description
F1	Get help description.
F2	Item Help
F3	Changing menu language.
F5	Load previous setting
F6	Load setup default setting
F7	Load turbo setting
F10	Save changed setting and exit setup program.
F12	Full Screen / Normal Mode

Caution: After updating your BIOS, please remember to update WinBIOS profile as well. If the upgraded BIOS version is newer than WinBIOS profile, WinBIOS will not be able to launch and a dialog box with error message will pop up. This verification is designed on purpose to protect your BIOS from damaged by wrong profile version.



For the latest WinBIOS profile and language pack modules, you may find them from AOpen official web site as shown below:

<http://english.aopen.com.tw/tech/download/WinBIOS/default.htm>



BIOS Upgrade under Windows environment



With outstanding R&D ability of AOpen, we now bring you a whole new BIOS Flash wizard ---- EzWinFlash. With an eye to users convenience, EzWinFlash combines the BIOS binary code and flash module together, so the only thing you have to do is just clicking on the utility you downloaded from web and let it helps you complete the flash process automatically. EzWinFlash detects your motherboard and checks the BIOS version cleverly to prevent your system from any possible failure. Moreover, EzWinFlash has been taken into consideration to go with any windows platform you might be using, no matter if you're using Windows 95/98, 98SE/ME, NT4.0/2000, or even the latest Windows XP.

In the meanwhile, in order to provide a much more user-friendly operating environment, AOpen EzWinFlash is natively designed to have multi-language function to provide easier way for users' usage in changing BIOS setting.



Caution: By updating your motherboard, you are taking a risk of BIOS flash failure. If your motherboard is working stable, and there are no major bugs that had been fixed by a latter BIOS revision, we recommend that you DO NOT try to upgrade your BIOS.

If you intent on upgrading, PLEASE BE SURE to get the right BIOS revision for the right motherboard model to avoid any possibility failure.

Note: The model name on this BIOS picture is for reference only. It may not be the exact model name.

You may accomplish BIOS upgrade procedure with EzWinFlash by the following steps, and it's STRONGLY RECOMMENDED to close all the applications before you start the upgrading.

1. Download the new version of BIOS package zip file from AOpen official web site. (ex: <http://english.aopen.com.tw/>)
2. Unzip the download BIOS package (ex: WAK79GMAX102.ZIP) with WinZip (<http://www.winzip.com>) in Windows environment.
3. Save the unzipped files into a folder, for example, WAK79GMAX102.EXE & WAK79GMAX102.BIN.
4. Double click on the WAK79GMAX102.EXE, EzWinFlash will detect the model name and BIOS version of your motherboard. If you had got the wrong BIOS, you will not be allowed to proceed with the flash steps.
5. You may select preferred language in the main menu, then click [Start Flash] to start the BIOS upgrade procedure.
6. EzWinFlash will complete all the process automatically, and a dialogue box will pop up to ask you to restart Windows. You may click [YES] to reboot Windows.
7. Press at POST to enter BIOS setup, choose "Load Setup Defaults", then "Save & Exit Setup". Done!

It is strongly recommended NOT to turn off the power or run any application during FLASH PROCESS.

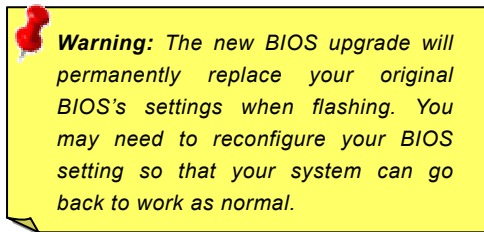

Glossary

AC97 CODEC

Basically, AC97 CODEC is the standard structure of PCI sound card. As we know, computer is digital-based, but music is based on analog-based. Therefore, there must be a process to turn digital into analog during the last stage processing of sound in computer. Hence, the component on sound card that play this important task is what we called CODEC.

Audio CODEC 97 (briefly called AC97) is the specification regulated by Intel, and it's about the structure of audio conversion. The special place about CODEC is that it is separated from sound card (CODEC is an independent chipset). Therefore, PCI sound card could possess with 90db and do other application process as well. We called CODEC that meets this structure AC97 CODEC.

ACPI (Advanced Configuration & Power Interface)

ACPI is the power management specification of PC97 (1997). It intends to save more power by taking full control of power management to operating system and bypass [BIOS](#). The chipset or super I/O chip needs to provide standard register interface to operating system (such as Windows 98). This is a bit similar as the [PnP](#) register interface. ACPI defines ATX momentary soft power switch to control the power state transition.

ACR (Advanced Communication Riser)

Building on the PC motherboard riser architecture, ACR slot is backward compatible with AMR but beyond the limitation of it. The ACR specification is designed to support modem, audio, Local Area Network (LAN) and Digital Subscriber Line (DSL).

AGP (Accelerated Graphic Port)

The main function of AGP simply put is to tell monitor what screen information had to be shown, a visual transmission device actually. With the rapid developing of AGP card, we can see that it had been developed from single colorful AGP card to 2D and 3D graphic. AGP supports only memory read/write operation and single-master single-slave one-to-one only. Though AGP and PCI share the same algorithm of 32-bit, its frequencies are 66MHz and 33MHz respectively. AGP interface had been developed from 2X to 8x.

1X AGP, data transfer rate is $66\text{MHz} \times 4\text{byte} \times 1 = 264\text{MB/s}$

2X AGP, data transfer rate is $66\text{MHz} \times 4\text{byte} \times 2 = 528\text{MB/s}$

4X AGP, data transfer rate is $66\text{MHz} \times 4\text{byte} \times 4 = 1056\text{MB/s}$.

8X AGP, data transfer rate is $66\text{MHz} \times 4\text{byte} \times 8 = 2112\text{MB/s}$.

AMR (Audio/Modem Riser)

The CODEC circuit of AC97 sound/modem solution can be put on motherboard or put on a riser card (AMR card) that connects to motherboard through AMR connector.

ATA (AT Attachment)

Before talking about ATA (AT Attachment), we must understand **DMA** (Direct Memory Access), which allows devices to skip the CPU devices and access memory directly. DMA specification could not only eliminate the workload of CPU, but also accelerate the transmission of data. DMA begins with a data transfer rate of 16.6MB/Sec, but afterward developed to new data rate of 33.3MB/Sec, which is twice the data rate and we called it **Ultra DMA**. **ATA** details power and data signals between the drive and integrated drive controller and the computer's motherboard. Two drives (master and slave) are supported. The ATA specification allows the drive to connect directly to the ISA bus on the computer. ATA transfer rate then had been developed to 133MHz/Sec and would come out with fastest rate later (please refer to [Serial ATA](#)).

DMA, data transfer rate is 16.6MHz/s.

Ultra DMA, data transfer rate is $16.6\text{MHz} \times 2 = 33\text{MB/s}$.

ATA/66, data transfer rate is $16.6\text{MHz} \times 4 = 66\text{MB/s}$.

ATA/100, data transfer rate is $16.6\text{MHz} \times 6 = 100\text{MB/s}$.

ATA/133, data transfer rate is $16.6\text{MHz} \times 8 = 133\text{MB/s}$.

(ATA/133 uses both rising edge and falling edge as ATA/66 but clock cycle time is reduced to 30ns.)

BIOS (Basic Input/Output System)

BIOS, is a set of assembly routine/program that reside in [EPROM](#) or [Flash ROM](#). BIOS controls Input/output devices and other hardware devices of motherboard. In general, to provide hardware independent portability, operation system and drivers is required to access BIOS without directly access hardware devices.

Bluetooth

Bluetooth is a wireless transferring technology that enables short-range wireless connections between desktop and laptop computers, personal digital assistants (PDAs), cellular phones, printers, scanners, digital cameras and even home appliances. The principle of Bluetooth (a chipset) is to transfer information and voices at the frequency of ISM Band. Every Bluetooth technology devices do come with a standard address for you to connect one-to-one or one-to-seven (to form a Pico-net), with transferring range up to 10 meters (100 meters to follow), using low power radio. Bluetooth do not only possess high transfer rate of 1MB/s, it also could be encrypted with pin code. With hopping rate of 1600 hops per second, it's difficult to be intercepted and are less interrupted by electromagnetic wave.

CNR (Communication and Networking Riser)

The CNR specification provides the PC industry the opportunity to deliver a flexible and cost reduced method of implementing LAN, home networking, DSL, USB, wireless, audio and modem subsystems widely used in today's "connected PCs". The CNR specification is an open industry specification and is supported by OEMs, IHV card manufacturers, silicon supplier and Microsoft.

DDR (Double Data Rate) RAM

DDR RAM utilizes the existing [SDRAM](#) (For ex, PC-100, PC-133) infrastructure and technology while doubling the nominal bandwidth available to systems in an easy to design and simple to adopt way. Based on FSB frequency, DDR RAM on the market are DDR200, DDR266 and DDR333 with more coming around soon.

DDR200, transfer bandwidth up to $200 \times 64 / 8 = 1600 \text{MB/s}$ (PC1600)

DDR266, transfer bandwidth up to $266 \times 64 / 8 = 2100 \text{MB/s}$ (PC2100)

DDR333, transfer bandwidth up to $333 \times 64 / 8 = 2700 \text{MB/s}$ (PC2700)

DDR400, transfer bandwidth up to $400 \times 64 / 8 = 3200 \text{MB/s}$ (PC3200)

ECC (Error Checking and Correction)

The ECC mode needs 8 ECC bits for 64-bit data. Each time memory is accessed; ECC bits are updated and checked by a special algorithm. The ECC algorithm has the ability to detect double-bit error and automatically correct single-bit error while parity mode can only detect single-bit error.

EEPROM (Electronic Erasable Programmable ROM)

Also known as E²PROM. Both EEPROM and [Flash ROM](#) can be re-programmed by electronic signals, but the interface technology is different. Size of EEPROM is much smaller than flash ROM.



EPROM (Erasable Programmable ROM)

Traditional motherboard stores BIOS code in EPROM. EPROM can only be erased by ultra-violet (UV) light. If BIOS has to be upgraded, you need to remove EPROM from motherboard, clear by UV light, re-program, and then insert back.

EV6 Bus

EV6 Bus is the technology of Alpha processor from Digital Equipment Corporation. EV6 bus uses both rising and falling clock edge to transfer data, similar as DDR RAM or ATA/66 IDE bus.

EV6 Bus Speed = CPU external bus clock x 2.

200 MHz EV6 bus, 200MHz = 100 MHz external bus clock x 2

FCC DoC (Declaration of Conformity)

The DoC is component certification standard of FCC EMI regulations. This standard allows DIY component (such as motherboard) to apply DoC label separately without a shielding of housing.

FC-PGA (Flip Chip-Pin Grid Array)

FC means Flip Chip, FC-PGA is a package of Intel for Pentium III for 0.18μm process CPU, which can be plugged into SKT370 socket.

FC-PGA2 (Flip Chip-Pin Grid Array)

After FC-PGA, FC-PGA2 is the package for 0.13μm process CPU developed by Intel, which can be plugged into SKT423/478 socket as well.

Flash ROM

Flash ROM can be re-programmed by electronic signals. It is easier for BIOS to upgrade by a flash utility, but it is also easier to be infected by virus. Because of increase of new functions, BIOS size is increased from 64KB to 512KB (4M bit).

Hyper Threading

Hyper-Threading technology is an innovative design from Intel that enables multi-threaded software applications to process threads in parallel within each processor resulting in increased utilization of processor execution resources. As a result, an average improvement of ~40% in CPU resource utilization yields higher processing throughput.

IEEE 1394

IEEE 1394, which also called Firewire, is a serial data transfer protocol and interconnection system. The main feature of the Firewire that assures its adoption for the digital video and audio (A/V) consumer application is its low cost. Fire wire interface is capable of supporting various high-end digital A/V applications, such as consumer A/V device control and signal routing, Digital Video (DV) editing, home networking, and more than 32 channels of digital mixing. Gone are those days of expensive video capture cards. Firewire allows for video capture from both newer DV camcorders with Firewire ports and older analog equipment using A/V to Firewire converters.

The advantages of the IEEE1394:

High data transfer rate – Start from 400 Mbps, (with 800/1600/3200 Mbps coming soon), which is about 30 times faster than USB 1.1.

Supports up to 63 devices (16 - daisy chained) with cable length up to about 4.5 m (14 feet).

Hot-pluggable (like USB). No need to turn of your device to connect or disconnect, and you don't need to reboot your PC. Also, it is a plug-and-play bus.

IEEE1394 is very easy to connect (Like USB1.1/2/0).

Parity Bit

The parity mode uses 1 parity bit for each byte, normally it is even parity mode, that is, each time the memory data is updated, parity bit will be adjusted to have even count "1" for each byte. When next time, if memory is read with odd number of "1", the parity error is occurred and this is called single bit error detection.

PCI (Peripheral Component Interface) Bus

Developed by Intel, Peripheral Component Interconnect (PCI) is a local bus standard. A bus is a channel used to transfer data to (input) and from (output) a computer and to or from a peripheral device. Most PCs have a PCI bus usually implemented at 32-bits providing a 33 MHz clock speed with a throughput rate of 133 MBps.

PDF Format

With PDF file, it is easy to do universal document exchange. Virtually any document may be converted in Portable Document Format (PDF). Contents in PDF documents are exactly the same as the original file, including fonts and graphics, and they can be distributed by e-mail or stored on the World Wide Web, an intranet, a file system, or a CD-ROM for other users to view on any platforms. You may download Acrobat Reader in order to read PDF file from its website (www.adobe.com).

PnP (Plug and Play)

Oversimplified, Plug-and-Play automatically tells the software (device drivers) where to find various pieces of hardware (devices) such as modems, network cards, sound cards, etc. Plug-and-Play's task is to match up physical devices with the software (device drivers) that operates them and to establish channels of communication between each physical device and its driver.

POST (Power-On Self Test)

The BIOS self-test procedure after power-on, sometimes, it is the first or the second screen shown on your monitor during system boot.

PSB (Processor System Bus) Clock

PSB Clock means the external bus clock of CPU.

CPU internal clock = CPU PSB Clock x CPU Clock Ratio

RDRAM (Rambus Dynamic Random Access Memory)

A DRAM technology developed by Rambus Corporation*, to achieve high speed of memory through the use of multiple channels in parallel by 16-bits. Basically, RDRAM uses new structure of Multibank, which is quite different from FPM, EDO, SDRAM. Using different memory module as well, RDRAM uses "RIMM" with transfer rate of 600/700/800MHz, providing bandwidth as high to 1.6GB.

RIMM (Rambus Inline Memory Module)

184-pin memory module that supports [RDRAM](#) memory technology. A RIMM memory module may contain up to maximum of 16 RDRAM devices.

SDRAM (Synchronous DRAM)

SDRAM is one of the DRAM technologies that allow DRAM to use the same clock as the CPU host bus (EDO and FPM are asynchronous and do not have clock signal). It is similar as PDSRAM to use burst mode transfer. SDRAM comes in 64-bit 168-pin DIMM and operates at 3.3V, and have been gradually replaced by DDR RAM.

SATA (Serial ATA)

The Serial ATA specification is designed to overcome speed limitations while enabling the storage interface to scale with the growing media rate demands of PC platforms. Serial ATA is to replace parallel [ATA](#) with the compatibility with existing operating systems and drivers, adding performance headroom for years to come. It is developed with data transfer rate of 150 Mbytes/second, and 300M/bs, 600M/bs to come. It reduces voltage and pins count requirements and can be implemented with thin and easy to route cables.

SMBus (System Management Bus)

SMBus is also called I²C bus. It is a two-wire bus developed for component communication (especially for semiconductor IC). For example, set clock of clock generator for jumper-less motherboard. The data transfer rate of SMBus is only 100Kbit/s, it allows one host to communicate with CPU and many masters and slaves to send/receive message.

SPD (Serial Presence Detect)

SPD is a small ROM or [EEPROM](#) device resided on the DIMM or [RIMM](#). SPD stores memory module information such as DRAM timing and chip parameters. SPD can be used by [BIOS](#) to decide best timing for this DIMM or RIMM.

USB 2.0 (Universal Serial Bus)

A Universal Serial Bus (USB) is an external bus (an interconnect) standard that supports data transfer rates of 12 Mbps. A single USB port can be used to connect up to 127 peripheral devices, such as mouse, modems and keyboards. Introduced in 1996, USB has completely replaced serial and parallel ports. It also supports plug-and-play installations and hot plugging. Plug-and-play is the ability to add and remove devices to a computer while the computer is running and have the operating system automatically recognize the change. USB 2.0, which supports data transfer rates of 480 Mbps, has been widely used in motherboard these days.

VCM (Virtual Channel Memory)

NEC's Virtual Channel Memory (VCM) is a new DRAM core architecture that dramatically improves the memory system's ability to service multimedia requirements. VCM increases memory bus efficiency and performance of any DRAM technology by providing a set of fast static registers between the memory core and I/O pins. Using VCM technology results in reduced data access latency and reduced power consumption.

Wireless LAN – 802.11b

802.11 is a specification developed by IEEE and Wireless LAN technology, which is an interface between a wireless client and a base station or between two wireless clients.

802.11 family includes the following specifications and with more coming:

802.11 = 1 or 2 Mbps transmission in the 2.4 GHz band, using either frequency hopping spread spectrum (FHSS) or direct sequence spread spectrum (DSSS).

802.11a = 54 Mbps in the 5GHz band, using orthogonal frequency division multiplexing)

802.11b (11 Mbps transmission in the 2.4 GHz band, using direct sequence spread spectrum (DSSS).

ZIP file

A compressed file format to reduce file size. To unzip file, run shareware PKUNZIP (<http://www.pkware.com/>) for DOS and other operating system or WINZIP (<http://www.winzip.com/>) for windows environment.



Troubleshooting

If you encounter any trouble to boot your system, follow the procedures accordingly to resolve the problem.

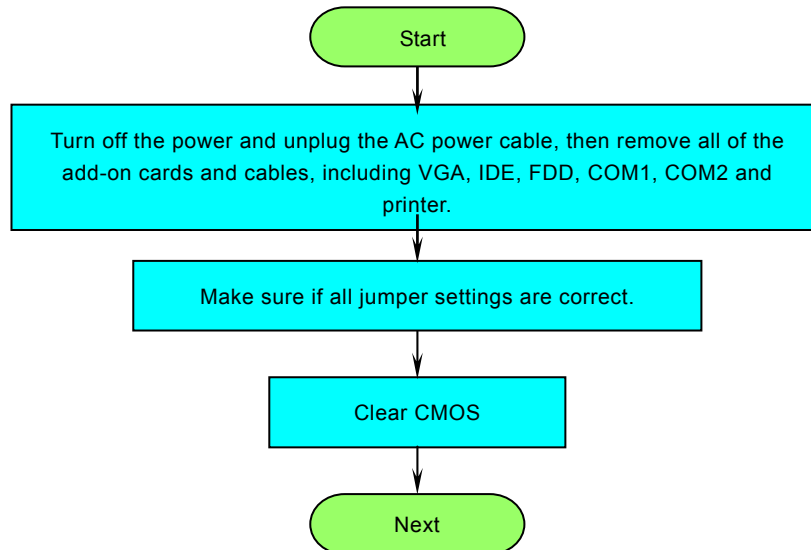

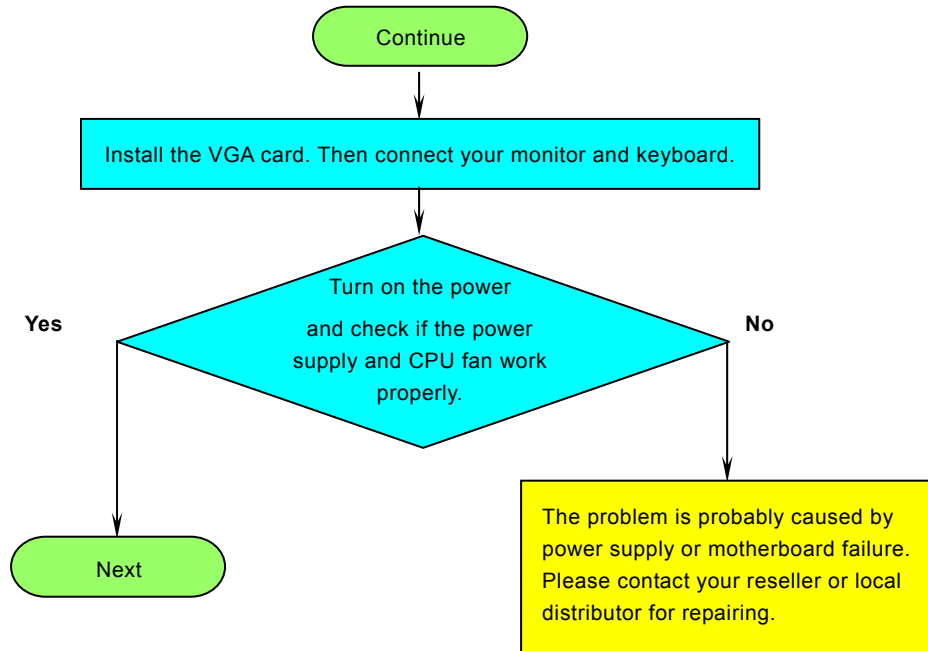

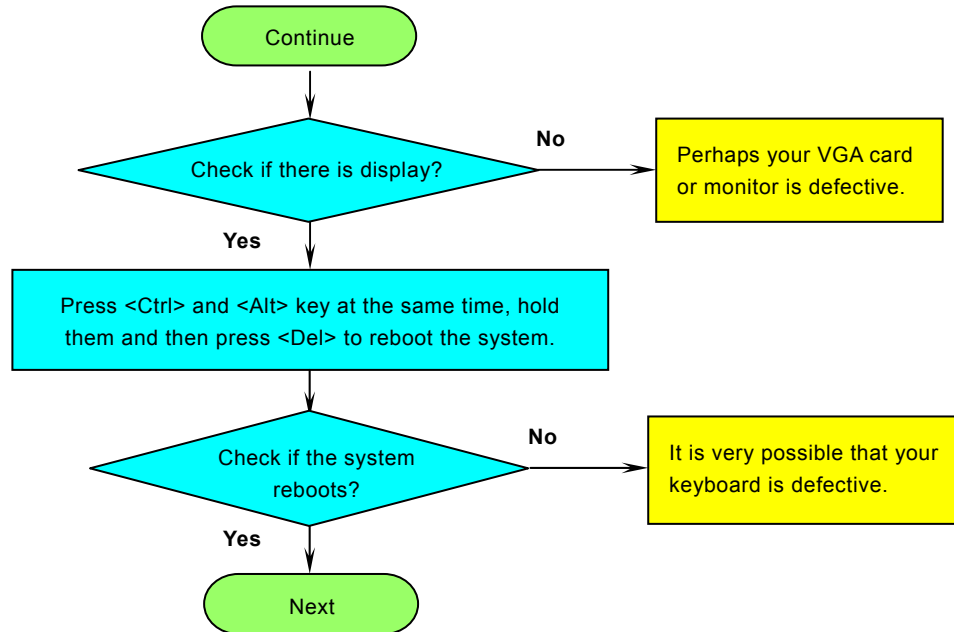

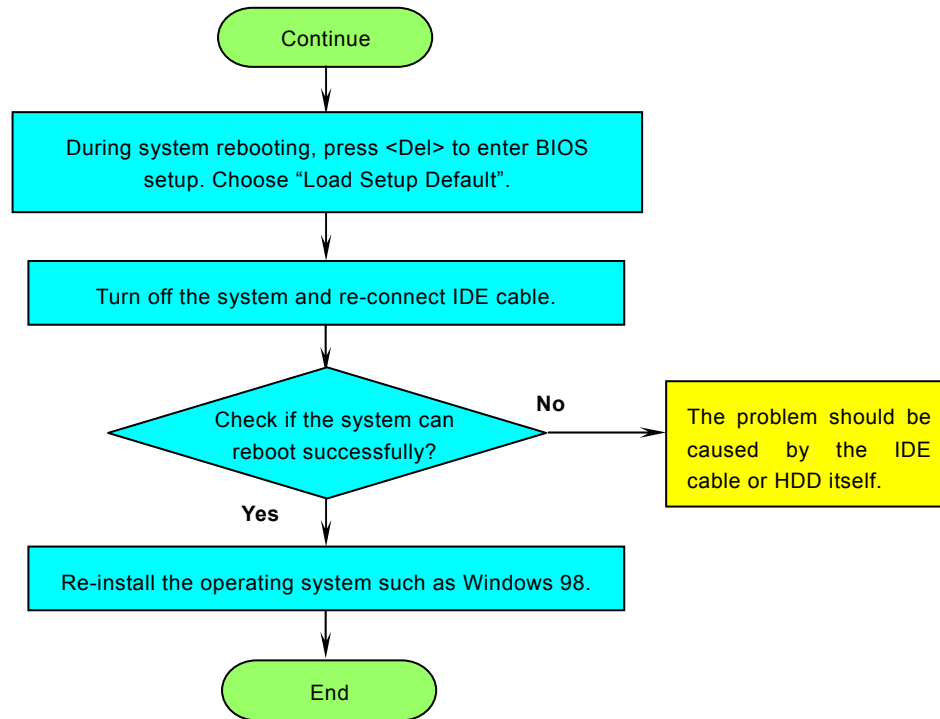



Technical Support

Dear Customer,

Thanks for choosing AOpen products. To provide the best and fastest service to our customer is our first priority. However, we receive numerous emails and phone-calls worldwide everyday, it is very hard for us to serve everyone on time. We recommend you follow the procedures below and seek help before contact us. With your help, we can then continue to provide the best quality service to more customers.

Thanks very much for your understanding!

AOpen Technical Supporting Team

1

Online Manual: To download manual, please log on and then select your preferred language. Under “Type” directory, choose “Manuals” to go to our manual database. You can also find the manual and EIG in AOpen Bonus Pack.

<http://club.aopen.com.tw/downloads>

2

Test Report: We recommend you to choose board/card/device from the compatibility test reports for assembling your PC. It may prevent incompatibility problems.

<http://english.aopen.com.tw/tech/report/default.htm>

3

FAQ: Here we list problems that users often encounter and FAQ (Frequently Asked Questions). You may be able to find a solution to your problem.

<http://club.aopen.com.tw/faq/>

4

Download Software: After log on and having language selected, you may get the latest updated BIOS/utility and drivers you need under “Type” directory. In most case, newer versions of drivers and BIOS have solved earlier bugs or compatibility problems.

<http://club.aopen.com.tw/downloads>

5

eForum: AOpen eForum is provided to discuss our products with other users, in which your problem probably had been discussed before or will be answered. After log on, you may select your preferred language under "Multi-language".

<http://club.aopen.com.tw/forum/>

6

Contact Distributors/Resellers: We sell our products through resellers and integrators. They should know your system configuration very well and should be able to solve your problem efficiently and provide important reference for you.

7

Contact Us: Please prepare detail system configuration and error symptom before contacting us. The **part number**, **serial number** and **BIOS version** are also very helpful.

Part Number and Serial Number

The Part Number and Serial number are printed on bar code label. You can find this bar code label on the outside packing, or on component side of PCB. For example:



Part No.



Serial No.

P/N: 91.88110.201 is part number, **S/N: 91949378KN73** is serial number.

Model name and BIOS version

Model name and BIOS version can be found on upper left corner of first boot screen ([POST](#) screen). For example:



AK79G MAX R1.00 Dec. 1. 2002 AOpen Inc.

Phoenix-Award Plug and Play BIOS Extension v1.0A

Copyright © 2003, Award Software, Inc.

AK79G MAX is model name of motherboard, **R1.00** is BIOS version.



Product Registration

Club AOpen

Welcome to AOpen Inc.



Thank you for choosing AOpen product. AOpen encourages you to spend few minutes in completing the following product registration. To register your product will ensure the high quality of services from AOpen. After the registration, you will:

- Have opportunities to play online slot machine and win a prize from AOpen by accumulating your bonuses for later prize exchange.
- Be upgraded to gold membership of Club AOpen program.
- Receive email notification about product safety alerts. Its purpose is to alert consumers quickly and conveniently when products contain technical issues.
- Receive email notification about latest product's announcements.
- Be able to personalize your AOpen web pages.
- Receive e-mail notification about latest BIOS/Driver/Software release information.
- Have opportunities to participate special product promotional programs.
- Enjoy higher service priority to receive technical assistance provided by AOpen specialists worldwide.
- Be able to join the discussions of web-based news groups.

AOpen makes sure that the information you provide is encrypted, so that it cannot be read or intercepted by other people or companies. Further, AOpen will not disclose any of information you submitted under any conditions. Please consult our [online privacy policy](#) for further information on our company policy.

Note: *If registering products purchased from different dealers/retails and/or purchased on different dates, please submit a separate form for each product.*



How to Contact Us



Please do not hesitate contact us if you have any problem about our products. Any opinion will be appreciated.

Pacific Rim
AOpen Inc.
Tel: 886-2-3789-5888
Fax: 886-2-3789-5899

Europe
AOpen Computer b.v.
Tel: 31-73-645-9516
Fax: 31-73-645-9604

America
AOpen America Inc.
Tel: 1-510-489-8928
Fax: 1-510-489-1998

China
艾爾鵬國際貿易(上海)有限公司
Tel: 86-21-6225-8622
Fax: 86-21-6225-7926

Japan
AOpen Japan Inc.
Tel: 81-048-290-1800
Fax: 81-048-290-1820

Germany
AOpen Computer GmbH.
Tel: 49-1805-559191
Fax: 49-2102-157799

Web Site: <http://english.aopen.com.tw/>

E-mail: Send us email by going through the contact form below.

English <http://english.aopen.com.tw/tech/default.htm>

Japanese <http://www.aopen.co.jp/tech/default.htm>

Chinese <http://www.aopen.com.tw/tech/default.htm>

German <http://www.aopencom.de/tech/default.htm>

Simplified Chinese <http://www.aopen.com.cn/tech/default.htm>

