

AK77-333



Online Manual

DOC. NO.: AK77333-OL-E0205C



What's in this manual

AK77-333	1
<i>What's in this manual</i>	2
<i>You Must Notice</i>	8
<i>Before You Start</i>	9
<i>Overview</i>	10
<i>Feature Highlight</i>	11
<i>Quick Installation Procedure</i>	15
<i>Motherboard Map</i>	16
<i>Block Diagram</i>	17
Hardware Installation	18
<i>Clear CMOS Data</i>	19
<i>CPU Installation</i>	20
<i>JP21 FSB/PCI Clock Ratio</i>	22
<i>CPU Jumper-less Design</i>	23
<i>CPU and Housing Fan Connector (with H/W Monitoring)</i>	28
<i>DIMM Sockets</i>	29
<i>System and RAM Power Indicate LED</i>	31
<i>Front Panel Connector</i>	32

	ATX Power Connector	33
	AC Power Auto Recovery	34
	IDE, Floppy Connector	35
	S/PDIF (Sony/Philips Digital Interface) Connector	37
	Super 5.1 Channel Audio Effect.....	38
	IrDA Connector.....	39
	WOM (Zero Voltage Wake on Modem) Connector	40
	WOL (Wake on LAN)	43
	AGP (Accelerated Graphic Port) Expansion Slot	45
	CNR (Communication and Network Riser) Expansion Slot	46
	PC99 Color Coded Back Panel.....	47
	Support 2 nd USB Port.....	48
	Support 3 rd and 4 th USB2.0 Ports (Optional)	49
	Chassis Intrusion Sensor.....	50
	CD Audio Connector.....	51
	AUX-IN Connector.....	52
	Front Audio Connector.....	53
	Die-Hard BIOS (100% Virus Protection, Upgrade Optional).....	54
	Dr. LED Connector (Upgrade Optional)	57

<i>Battery-less and Long Life Design</i>	59
<i>Over-current Protection</i>	60
<i>Hardware Monitoring</i>	61
<i>Resettable Fuse</i>	62
<i>2200 μF Low ESR Capacitor</i>	63
<i>Layout (Frequency Isolation Wall)</i>	64
<i>Fansink on North Bridge</i>	65
Driver and Utility	66
<i>Auto-run Menu from Bonus CD Disc</i>	67
<i>Installing Windows 95</i>	68
<i>Installing Windows 98</i>	69
<i>Installing Windows[®] 98 SE, Windows[®] ME & Windows[®] 2000</i>	70
<i>Installing VIA 4 in 1 Driver</i>	71
<i>Installing Onboard Sound Driver</i>	72
<i>Installing Hardware Monitoring Utility</i>	73
<i>Installing USB2.0 Driver (Optiona)</i>	74
<i>ACPI Suspend to Hard Drive</i>	77
<i>ACPI Suspend to RAM (STR)</i>	82
AWARD BIOS	84



How To Use Award™ BIOS Setup Program.....	85
How To Enter BIOS Setup	87
BIOS Upgrade under Windows environment.....	88
Overclocking	90
VGA Card & Hard Disk	91
Glossary	92
AC97	92
ACPI (Advanced Configuration & Power Interface).....	92
AGP (Accelerated Graphic Port).....	92
AMR (Audio/Modem Riser).....	93
AOpen Bonus Pack CD	93
APM (Advanced Power Management).....	93
ATA (AT Attachment).....	93
ATA/66.....	93
ATA/100.....	94
BIOS (Basic Input/Output System)	94
Bus Master IDE (DMA mode).....	94
CNR (Communication and Networking Riser).....	94
CODEC (Coding and Decoding)	95

<i>DDR (Double Data Rate) SDRAM</i>	95
<i>DIMM (Dual In Line Memory Module)</i>	95
<i>DMA (Direct Memory Access)</i>	95
<i>ECC (Error Checking and Correction)</i>	96
<i>EDO (Extended Data Output) Memory</i>	96
<i>EEPROM (Electronic Erasable Programmable ROM)</i>	96
<i>EPROM (Erasable Programmable ROM)</i>	96
<i>EV6 Bus</i>	97
<i>FCC DoC (Declaration of Conformity)</i>	97
<i>FC-PGA (Flip Chip-Pin Grid Array)</i>	97
<i>Flash ROM</i>	97
<i>FSB (Front Side Bus) Clock</i>	98
<i>I²C Bus</i>	98
<i>IEEE 1394</i>	98
<i>Parity Bit</i>	99
<i>PBSRAM (Pipelined Burst SRAM)</i>	99
<i>PC-100 DIMM</i>	99
<i>PC-133 DIMM</i>	99
<i>PC-1600 or PC-2100 DDR SDRAM</i>	100

<i>PCI (Peripheral Component Interface) Bus</i>	100
<i>PDF Format</i>	100
<i>PnP (Plug and Play)</i>	100
<i>POST (Power-On Self Test)</i>	101
<i>RDRAM (Rambus DRAM)</i>	101
<i>RIMM (Rambus Inline Memory Module)</i>	101
<i>SDRAM (Synchronous DRAM)</i>	101
<i>Shadow E²PROM</i>	102
<i>SIMM (Single In Line Memory Module)</i>	102
<i>SMBus (System Management Bus)</i>	102
<i>SPD (Serial Presence Detect)</i>	102
<i>Ultra DMA</i>	103
<i>USB (Universal Serial Bus)</i>	103
<i>VCM (Virtual Channel Memory)</i>	104
<i>ZIP file</i>	104
Troubleshooting.....	105
Technical Support.....	109
Product Registration.....	112
How to Contact Us.....	113

You Must Notice



Adobe, the Adobe logo, Acrobat is trademarks of Adobe Systems Incorporated.

AMD, the AMD logo, Athlon and Duron are trademarks of Advanced Micro Devices, Inc.

Intel, the Intel logo, Intel Celeron, Pentium II, Pentium III are trademarks of Intel Corporation.

Microsoft, Windows, and Windows logo are either registered trademarks or trademarks of Microsoft Corporation in the United States and/or other countries.

All product and brand names used on this manual are used for identification purposes only and may be the registered trademarks of their respective owners.

All of the specifications and information contained in this manual are subject to change without notice. AOpen reserves the right to revise this publication and to make reasonable changes. AOpen assumes no responsibility for any errors or inaccuracies that may appear in this manual, including the products and software described in it.

This documentation is protected by copyright law. All rights are reserved.

No part of this document may be used or reproduced in any form or by any means, or stored in a database or retrieval system without prior written permission from AOpen Corporation.

Copyright© 1996-2000, AOpen Inc. All Rights Reserved.

Before You Start



This Online Manual will introduce to the user how this product is installed. All useful information will be described in later chapters. Please keep this manual carefully for future upgrades or system configuration changes. This Online Manual is saved in [PDF format](#), we recommend using Adobe Acrobat Reader 4.0 for online viewing, it is included in [Bonus CD disc](#) or you can get free download from [Adobe web site](#).

Although this Online Manual is optimized for screen viewing, it is still capable for hardcopy printing, you can print it by A4 paper size and set 2 pages per A4 sheet on your printer. To do so, choose **File > Page Setup** and follow the instruction of your printer driver.

Thanks for the help of saving our earth.

Overview

Thank you for choosing AOpen AK77-333. The AK77-333 is AMD® Socket 462 motherboard (M/B) based on the ATX form factor featuring the [VIA Apollo KT333 chipset](#). As high performance chipset built in the M/B, the AK77-333 AMD® Socket 462 series Athlon™ & Duron™ processor and 200/266MHz [EV6](#) system bus. In the AGP performance, it has one AGP slot and supports AGP /4X mode and pipelined spilt-transaction long burst transfer up to 1056MB/sec. With high bandwidth 200/266MB/s 8-bit V-Link Host Controller, [DDR266\(PC2100\)](#) and [DDR333\(PC2700\)](#) [DDR SDRAM](#) can be applied to the AK77-333 and the maximum memory size can be up to 3GB. The on-board IDE controller supports [Ultra DMA](#) 66/100/133 mode and the transfer rate up to 133MB/s. Further flexibility can be achieved by taking advantage of the [Communication and Network Riser \(CNR\)](#) card option that allows audio and modem configuration on a single baseboard design. Besides, the AK77-333 has an [AC97 CODEC Realtek ALC650](#) chipset onboard for provides high performance and magic surround stereo sound to let people enjoy working with it. More than that, this motherboard supports USB 2.0 function (USB3 and USB4 only, optional) with a fancy speed up to 480Mbps. Now, enjoy all features from AOpen AK77-333.

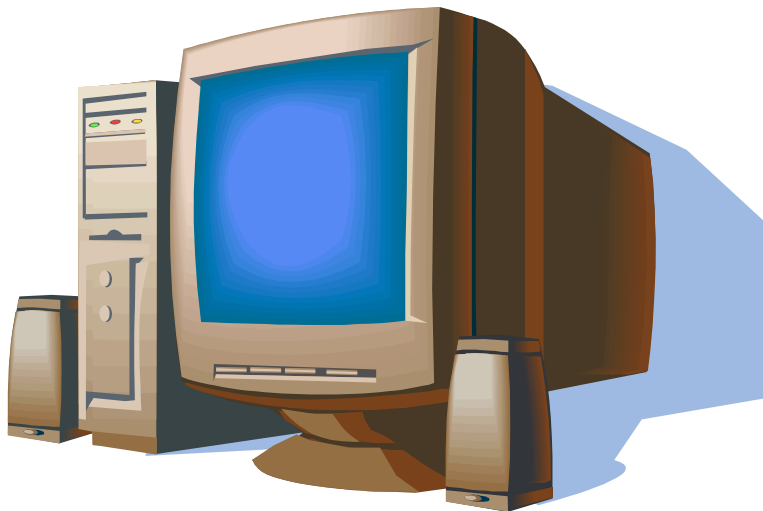

Feature Highlight

CPU

Supports AMD® Socket 462 series CPU with both 200MHz and 266MHz [EV6 Bus](#) designed for Socket 462 technology.

Athlon: 600MHz~1.4GHz

Duron: 600MHz~1.2GHz

AthlonXP: 1500+(1.3GHz)~2000+(1.667GHz)

Chipset

The VIA Apollo KT333 consists of the KT333 V-Link [DDR](#) Host system controller and the VT8233A highly integrated V-Link Client PCI/LPC controller. The Host system controller provides superior performance between the CPU, SDRAM, AGP bus, and V-Link interface with pipelined, burst, and concurrent operation. The VT8233A V-Link Client controller is a highly integrated PCI/LPC controller. Its internal bus structure is based on 66MHz PCI bus that provides 2x bandwidth compare to previous generation PCI/ISA bridge chips. The VT8233A integrated Client V-Link controller with 200/266MB/s bandwidth between Host/Client V-Link interface, provides a V-Link-PCI and V-Link-LPC controller. Of five PCI slots provided, AK77-333 supports all five master PCI slots with arbitration and decoding for all integrated functions and LPC bus.

Ultra DMA 66/100/133 Bus Master IDE

Comes with an on-board PCI Bus Master IDE controller with two connectors that supports four IDE devices in two channels, supports [Ultra DMA](#) 66/100/133, PIO Modes 3 and 4 and Bus Master IDE DMA Mode 4, and supports Enhanced IDE devices.

Expansion Slots

Including five 32-bit/33MHz PCI, one CNR and one AGP 4X slots. The [PCI](#) local bus throughput can be up to 132MB/s. The [Communication & Networking Riser \(CNR\)](#) slot provided from AK77-333 can support CNR interface for a Modem/Audio card. The [Accelerated Graphics Port \(AGP\)](#) specification provides a new level of video display sophistication and speed. The AGP video cards support data transfer rate up to 1056MB/s. As AK77-333 includes one AGP expansion slot for a bus mastering AGP graphic card, For AD and SBA signaling, AK77-333 can support 133MHz 2X/4X mode. Of five PCI slots provided, AK77-333 supports four master PCI slots for arbitration and decoding functions and one slave PCI slot.

Memory

With VIA Apollo KT333 chipset, the AK77-333 can support [Double-Data-Rate \(DDR\) SDRAM](#). The DDR SDRAM interface allows zero wait state bursting between the SDRAM and the data buffers at 266/333MHz. The six banks of DDR SDRAM can be composed of an arbitrary mixture of 1M/2M4M/8M/16M/32M/64MxN DDR SDRAM and maximum up to 3GB. The AK77-333 allows DDR SDRAM to run at either synchronous or pseudo-synchronous mode with the host CPU bus frequency (266/333MHz).

On-board AC97 Sound

AK77-333 uses the [AC97](#) CODEC Realtek ALC650 chip, which supports high quality of 5.1 Channel audio effects. This on-board audio includes a complete audio recording and playback system.

Eight USB Connectors (3rd and 4th connector are USB2.0, optional)

Provides four ports, eight [USB](#) connectors for USB interface devices, such as mouse, keyboard, modem, scanner, etc. The onboard 1st and 2nd USB Host controller are fully compliant with USB UHCI 1.1 specification that can fully compatible with low power mode and wake-up specification. While, the 3rd and 4th connector support USB2.0 have a fancy speed up to 480Mbps which is 40 times faster than the traditional one

1MHz Stepping Frequency Adjustment

Provides “1MHz Stepping Frequency Adjustment” function in the BIOS. This magic function allows you adjust CPU [FSB](#) frequency from 100~248 by 1MHz stepping, and lets your system can get maximum performance.

Watch Dog Timer

Includes AOpen “Watch Dog Timer” function that can auto-reset system in 4.8 seconds when you fail to system overclocking.

Die-Hard BIOS with external controller (Upgrade Optional)

The Die-Hard BIOS technology is a very effective hardware protection method that doesn't involve any software or BIOS coding. Hence, it is 100% virus free.

Dr. LED (Upgrade Optional)

The Dr. LED has 8 LEDs on AK77-333, which can easily show what kind of problem you may encounter.

Power Management/Plug and Play

The AK77-333 supports the power management function that conforms to the power-saving standards of the U.S. Environmental Protection Agency (EPA) Energy Star program. It also offers [Plug-and-Play](#), which helps saving users from configuration problems, thus making the system much more user-friendly.

Hardware Monitoring Management

Supports CPU or system fans status, temperature and voltage monitoring and alert, through the on-board hardware monitor module and [Aopen Hardware Monitoring Utility](#).

Enhanced ACPI

Fully implement the [ACPI](#) standard for Windows® 95/98/ME/NT/2000 series compatibility, and supports Soft-Off, [STR \(Suspend to RAM, S3\)](#), [STD \(Suspend to Disk, S4\)](#), WOM (Wake On Modem), WOL (Wake On LAN) features.

Super Multi-I/O

The AK77-333 provides two high-speed UART compatible serial ports and one parallel port with EPP and ECP capabilities. UART2 can also be directed from COM2 to the Infrared Module for the wireless connections.

Quick Installation Procedure

This page gives you a quick procedure on how to install your system. Follow each step accordingly.

1. [Installing CPU and Fan](#)
2. [Installing System Memory \(DIMM\)](#)
3. [Connecting Front Panel Cable](#)
4. [Connecting IDE and Floppy Cable](#)
5. [Connecting ATX Power Cable](#)
6. [Connecting Back Panel Cable](#)
7. [Power-on and Load BIOS Setup Default](#)
8. [Setting CPU Frequency](#)
9. Reboot
10. [Installing Operating System \(such as Windows 98\)](#)
11. [Installing Driver and Utility](#)

Motherboard Map

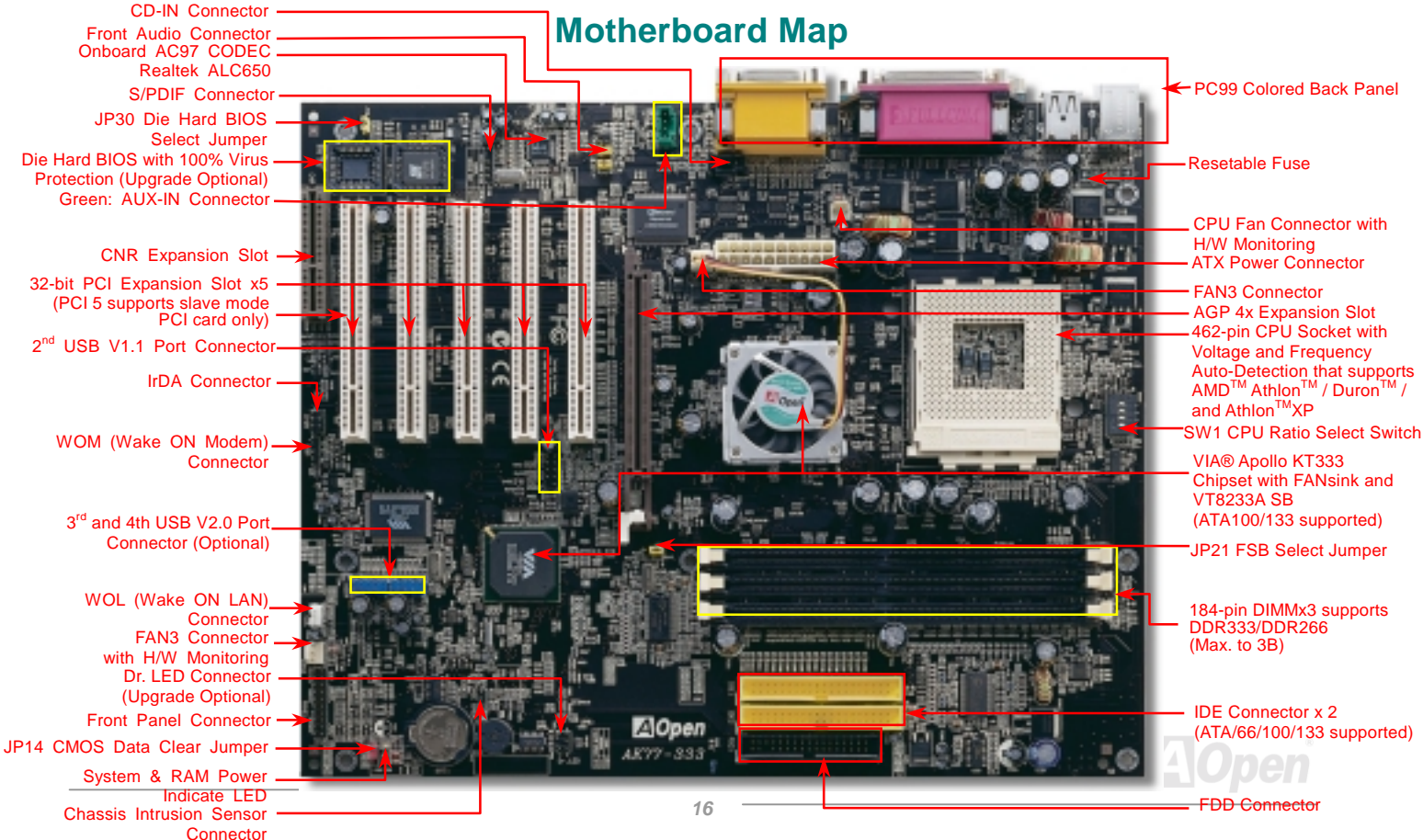

Block Diagram

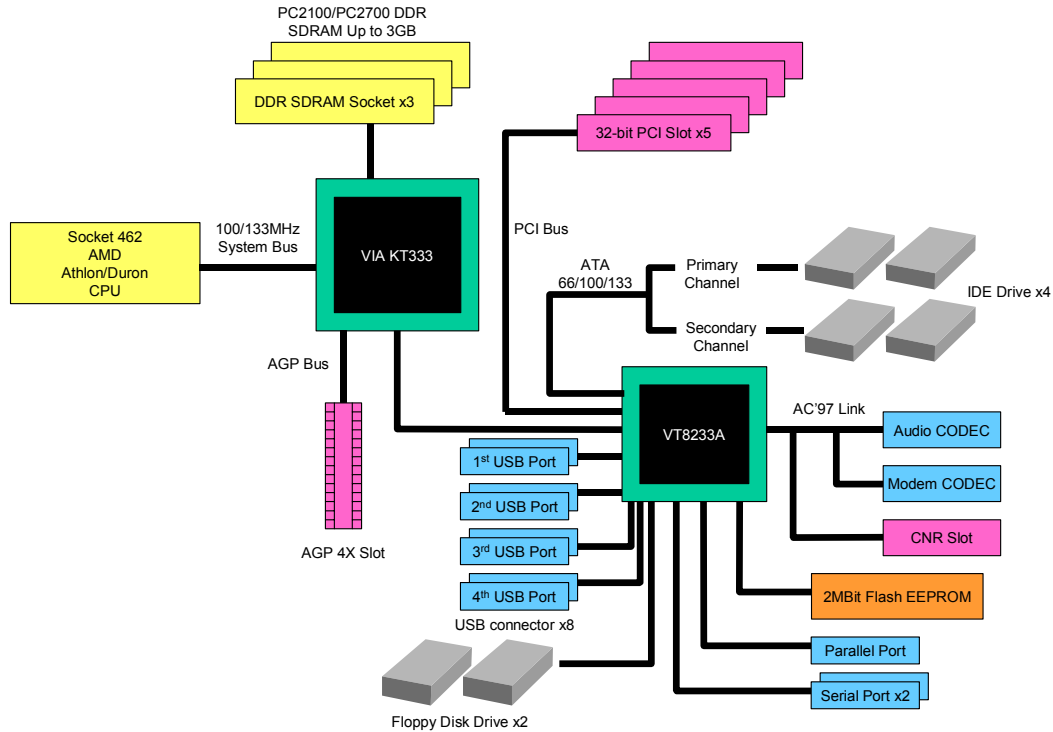

Hardware Installation

This chapter describes jumpers, connectors and hardware devices of this motherboard.



Note: *Electrostatic discharge (ESD) can damage your processor, disk drives, expansion boards, and other components. Always observe the following precautions before you install a system component.*

1. *Do not remove a component from its protective packaging until you are ready to install it.*
2. *Wear a wrist ground strap and attach it to a metal part of the system unit before handling a component. If a wrist strap is not available, maintain contact with the system unit throughout any procedures requiring ESD protection.*

Clear CMOS Data

You can clear CMOS to restore system default setting. To clear the CMOS, follow the procedures below.

1. Turn off the system and unplug the AC power.
2. Remove ATX power cable from connector PWR2.
3. Locate JP14 and short pins 2-3 for a few seconds.
4. Return JP14 to its normal setting by shorting pin 1 & pin 2.
5. Connect ATX power cable back to connector PWR2.

Pin 1

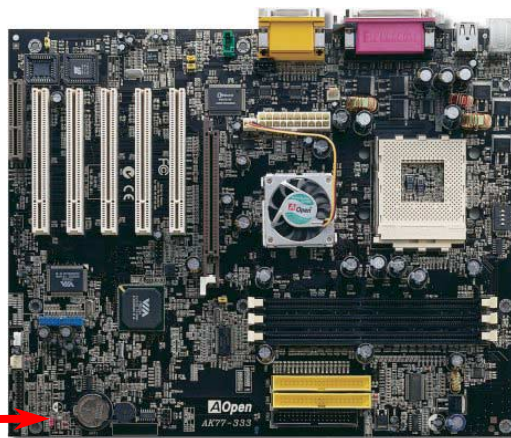
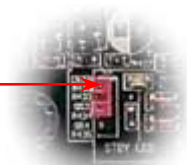

Normal Operation
(default)



Clear CMOS

Tip: When should I Clear CMOS?

1. Boot fail because of overclocking...
2. Forget password...
3. Troubleshooting...

CPU Installation

This motherboard supports AMD® Athlon and Duron Socket 462 series CPU. Be careful of CPU orientation when you plug it into CPU socket.

1. Pull up the CPU socket lever and up to 90-degree angle.

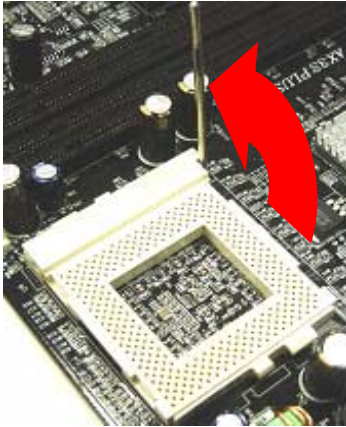

2. Locate Pin 1 in the socket and look for a black dot or cut edge on the CPU upper interface. Match Pin 1 and cut edge, then insert the CPU into the socket.

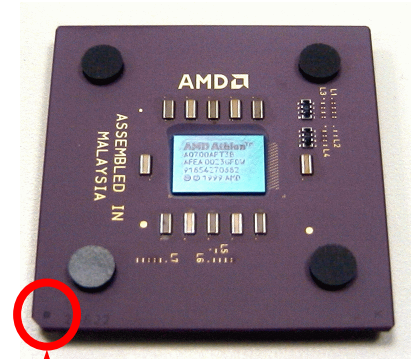
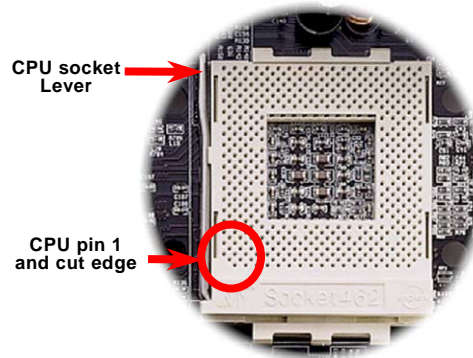

Black dot
and cut edge

Note: This picture is for example only, it may not exactly be the same motherboard.

3. Press down the CPU socket lever and finish CPU installation.

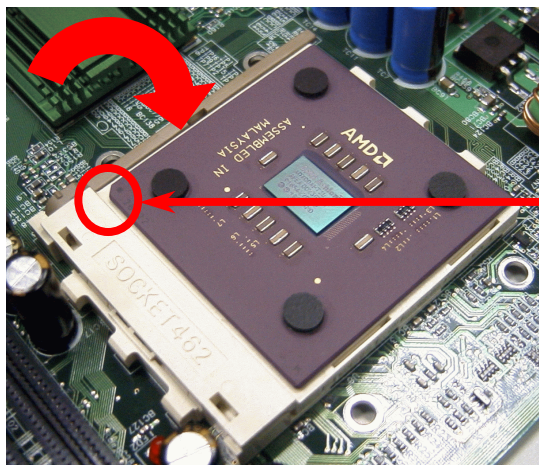

CPU cut edge

Note: If you do not match the CPU socket Pin 1 and CPU cut edge well, it may damage the CPU.

Note: This picture is for example only, it may not exactly be the same motherboard.

JP21 FSB/PCI Clock Ratio

This jumper is used to specify the relationship of PCI and [FSB](#) clock. Generally speaking, if you are not overclockers, we recommend you to set it to the default setting. Additionally, this motherboard also provides “**1MHz Stepping Adjustment**” feature for overclockers to adjust CPU FSB frequency via BIOS setup program. Based on the CPU type, the adjustment range has two levels: 100~129 (FSB=100, such as Athlon 800), 130~248 (FSB=133, such as Athlon 1000) MHz for your choosing. You may also choose a specific FSB frequency ranging from 100~117 (say, 105, 110, 115 for example) and 120~156 with reference to a frequency table in BIOS setup program. If you fix the CPU FSB frequency by JP21, the “1MHz Stepping Adjustment” range will be changed and following your JP21 setting.

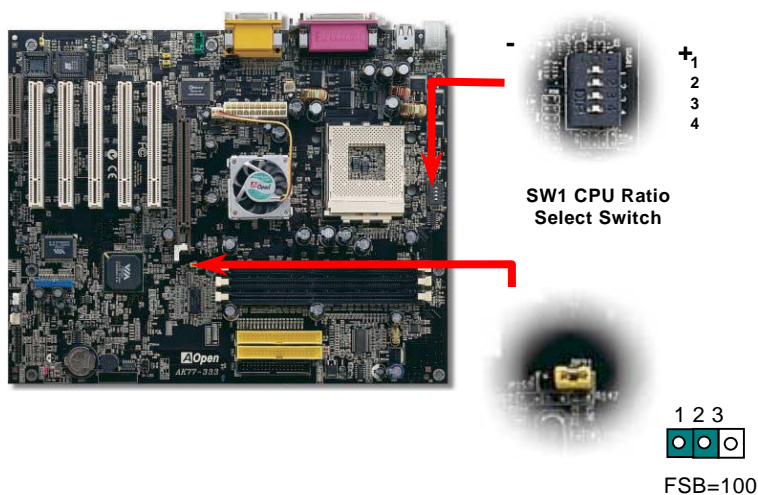

CPU Ratio	SW1-1	SW1-2	SW1-3	SW1-4
5	-	-	+	-
5.5	+	-	+	-
6	-	+	+	-
6.5	+	+	+	-
7	-	-	-	+
7.5	+	-	-	+
8	-	+	-	+
8.5	+	+	-	+
9	-	-	+	+
9.5	+	-	+	+
10	-	+	+	+
10.5	+	+	+	+
11	-	-	-	-
11.5	+	-	-	-
12	-	+	-	-
12.5	+	+	-	-
CPU Default	0	0	0	0

CPU Jumper-less Design

CPU VID signal and [SMBus](#) clock generator provide CPU voltage auto-detection and allows the user to set the CPU frequency through the [BIOS setup](#), therefore no jumpers or switches are used. The disadvantages of the Pentium based jumper-less designs are eliminated. There will be no worry of wrong CPU voltage detection.

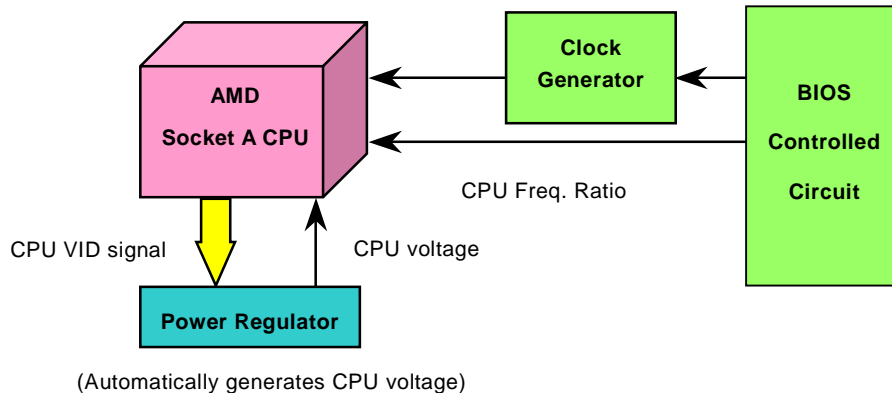

Full-range Adjustable CPU Core Voltage

This function is dedicated to overclockers, AOpen works together with Fairchild to develop a special chip FM3540 that supports Adjustable CPU Core Voltage from 1.1V to 1.85V by 0.05V stepping. But this motherboard can also automatically detect CPU VID signal and generates proper CPU core voltage.

BIOS Setup > Frequency/Voltage Control > CPU Voltage Setting



Warning: Higher CPU core voltage may be able to increase CPU speed for overclocking, but you may damage the CPU or reduce the CPU lifecycle.

Setting CPU Frequency

This motherboard is CPU jumper-less design, you can set CPU frequency through the BIOS setup, and no jumpers or switches are needed.

BIOS Setup > Frequency/Voltage Control > CPU Speed Setting

CPU Ratio	From 5.5x to 12.5x step 0.5x
CPU FSB (By BIOS Table)	100, 102, 105, 108, 110, 113, 115, 117, 120, 122, 124, 133, 136, 138, 140, 142, 144, 147, 152, 154, and 156MHz.
CPU FSB (By manual Adjustment)	FSB=100, 100~129 by 1MHz stepping adjustment technology FSB=133, 130~248 by 1MHz stepping adjustment technology

Warning: VIA® Apollo KT333 chipset supports 133MHz FSB (with performance reaches maximum 266MHz EV6 system bus) and 66MHz AGP clock, higher clock setting may cause serious system damage.



Tip: If your system hangs or fails to boot because of overclocking, simply use <Home> key to restore the default setting or you can wait the AOpen "Watch Dog Timer" reset the system after five seconds and system will auto-detect hardware again.

Supported CPU Frequency

Core Frequency = CPU Bus Clock * CPU Ratio

PCI Clock = CPU Bus Clock / Clock Ratio

AGP Clock = PCI Clock x 2

EV6 Bus Speed = CPU external bus clock x 2

CPU	CPU Core Frequency	EV6 Bus Clock	Ratio
Athlon 1G	1GHz	200MHz	10.0x
Athlon 1.1G	1.1GHz	200MHz	11.0x
Athlon 1.2G	1.2GHz	200MHz	12.0x
Athlon 1.3G	1.3GHz	200MHz	13.0x
Athlon 1G	1GHz	266MHz	7.5x
Athlon 1.13G	1.13GHz	266MHz	8.5x
Athlon 1.2G	1.2GHz	266MHz	9.0x
Athlon 1.33G	1.33GHz	266MHz	10.0x
Athlon 1.4G	1.4GHz	266MHz	10.5x
AthlonXP 1500+	1.3GHz	266MHz	10.0x
AthlonXP 1600+	1.4GHz	266MHz	10.5x
AthlonXP 1700+	1.46GHz	266MHz	11.0x
AthlonXP 1800+	1.53GHz	266MHz	11.5x
AthlonXP 1900+	1.6GHz	266MHz	12.0x
Duron 800	800MHz	200MHz	8.0x
Duron 850	850MHz	200MHz	8.5x
Duron 900	900MHz	200MHz	9.0x
Duron 950	950MHz	200MHz	9.5x
Duron 1G	1GHz	200MHz	10.0x
Duron 1.1G	1.1GHz	200MHz	11.0x

Note: This motherboard support CPU auto-detection function. Hence, you don't need to setup the CPU frequency manually.

AOpen “Watch Dog Timer”

With this motherboard, AOpen provides a very special, useful feature for overclockers. When you power-on the system, the BIOS will check last system [POST](#) status. If it succeeded, the BIOS will enable “Watch Dog Timer” function immediately, and set the CPU [FSB](#) frequency by user’s setting that stored in the BIOS. If system failed in BIOS POST, the “Watch Dog Timer” will reset the system to reboot in five seconds. Then, BIOS will detect the CPU’s default frequency and POST again. With this special feature, you can easily overclock your system to get higher system performance without removing the cover of system housing, and be able to set the jumper to clear CMOS data when your system hanged.

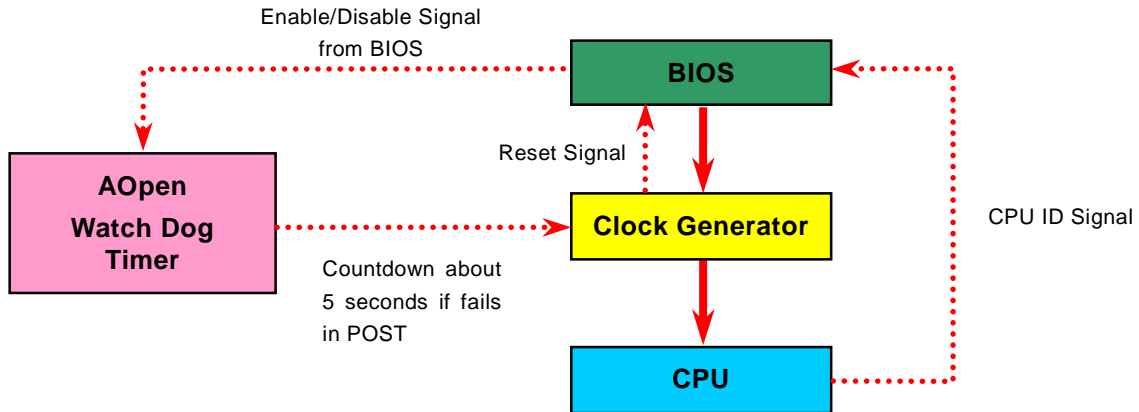

CPU and Housing Fan Connector (with H/W Monitoring)

Plug in the CPU fan cable to the 3-pin **CPU FAN** connector. If you have chassis fan, you can also plug it on **System Fan** (FAN2) or **AUX Fan** (FAN3) (without H/W monitoring) connector.

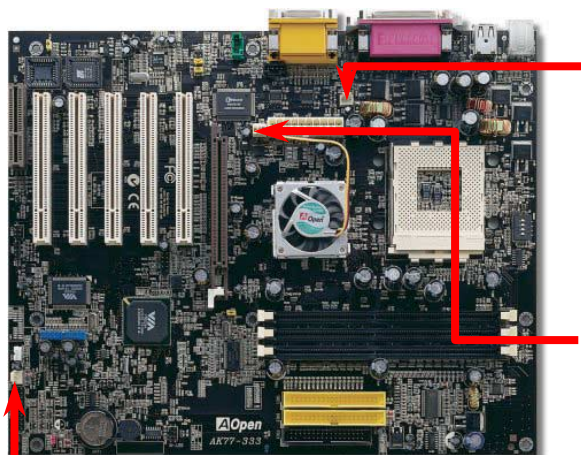

FAN3 Connector

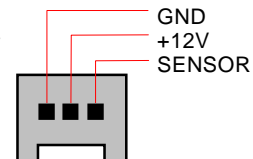

CPU Fan Connector

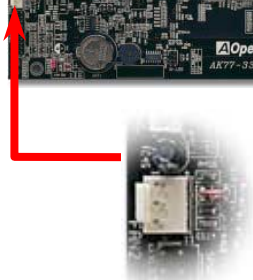
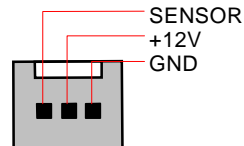

FAN2 Connector

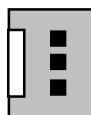

GND
+12V
SENSOR

Note: Some CPU fans do not have sensor pin, so that cannot support fan monitoring.

DIMM Sockets

This motherboard has three 184-pin DDR DIMM sockets that allow you to install PC2100 or PC2700 memory up to 3 GB. Only Non-ECC DDR SDRAM are supported.

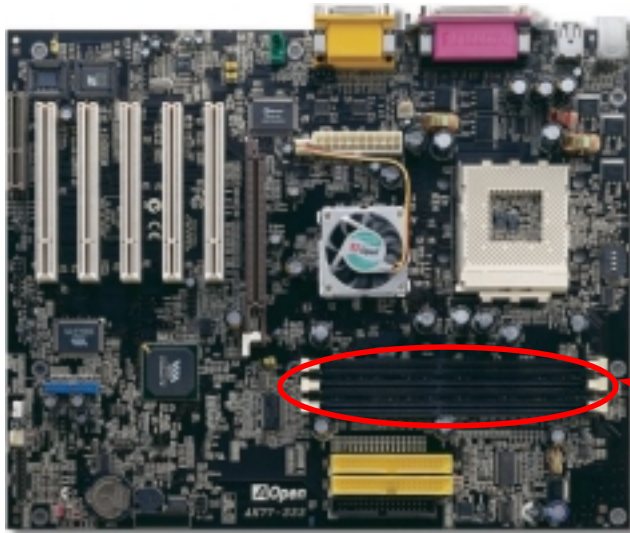

Warning: The AK77-333 support DDR SDRAM, please do not install the SDRAM on the DDR SDRAM sockets. Otherwise, it will cause serious damage on memory sockets or SDRAM module.



DDR
SDRAM

How to Install Memory Modules

Please follow the procedure as shown below to finish memory installation.

1. Make sure the DIMM module's pin face down and match the socket's size as depicted below.

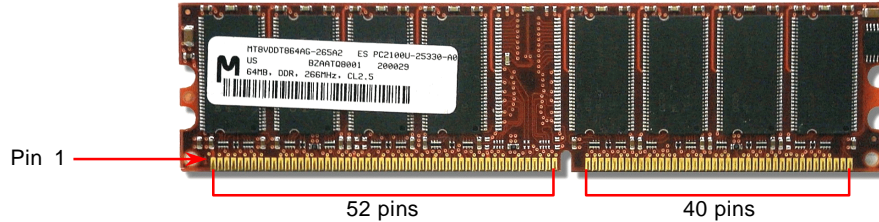

2. Insert the module straight down to the DIMM slot with both hands and press down firmly until the DIMM module is securely in place.

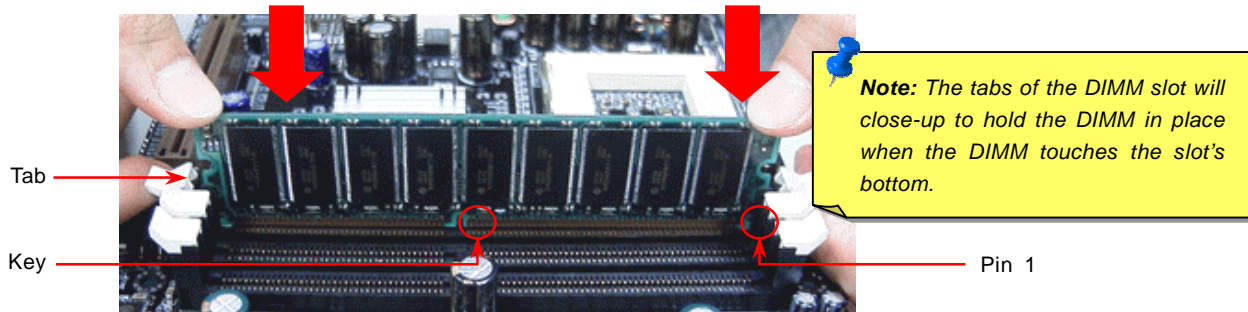

3. Repeat step 2 to finish additional DIMM modules installation.

System and RAM Power Indicate LED

This LED indicates there is power applies to motherboard and memory. If you connect power to the motherboard, this LED will be lighting. It is useful to check the system power status when power on/off and stand-by mode or RAM power status during [Suspend to RAM mode](#).

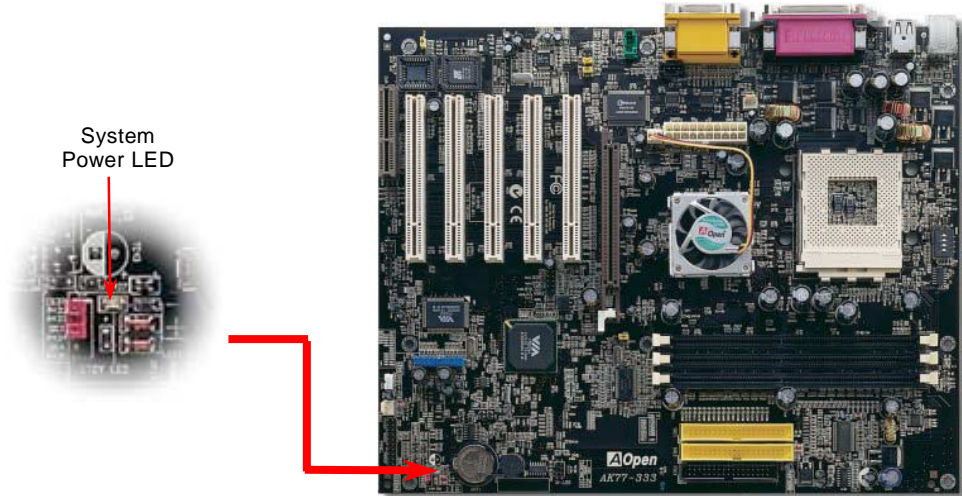

Warning: Do not install or remove the DIMM module or others devices when the LED is lighting.

Front Panel Connector

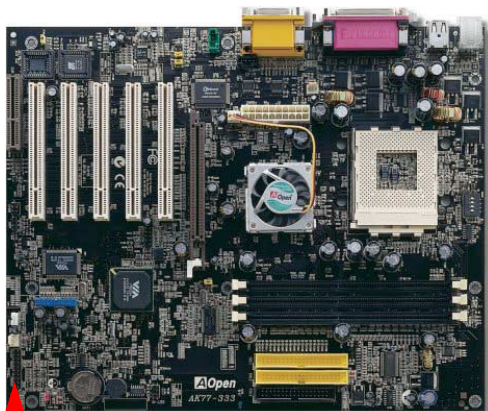

Attach the power LED, EMPI, speaker, power and reset switch connectors to the corresponding pins. If you enable “Suspend Mode” item in BIOS Setup, the ACPI & Power LED will keep flashing while the system is in suspend mode.

Locate the power switch cable from your ATX housing. It is 2-pin female connector from the housing front panel. Plug this connector to the soft-power switch connector marked **SPWR**.

Suspend Type	ACPI LED
Power on Suspend (S1)	Flashing for every second
Suspend to RAM (S3) or Suspend to Disk (S4)	The LED will be turned off

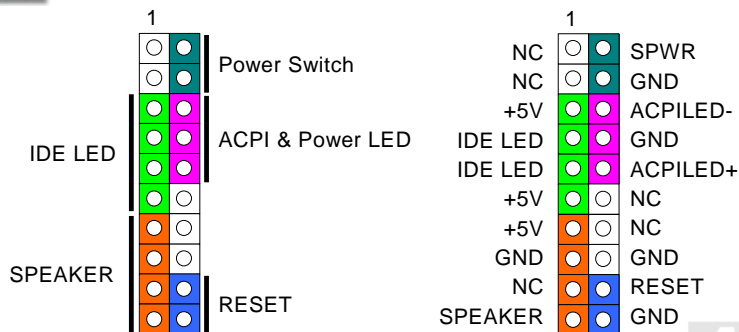

ATX Power Connector

The ATX power supply uses 20-pin connector shown below. Make sure you plug in the right direction.

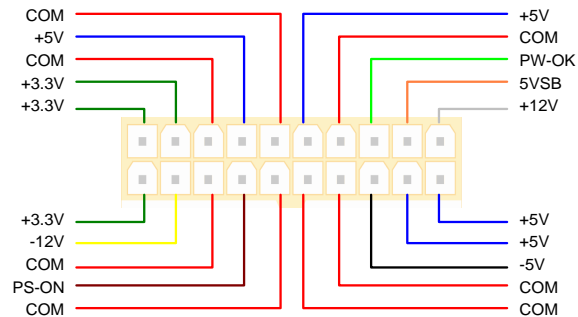
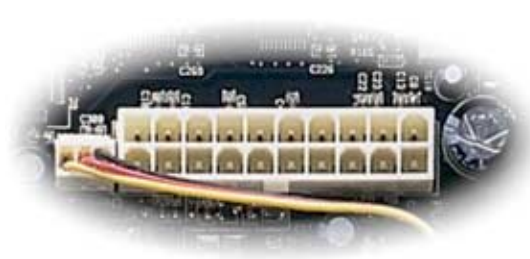
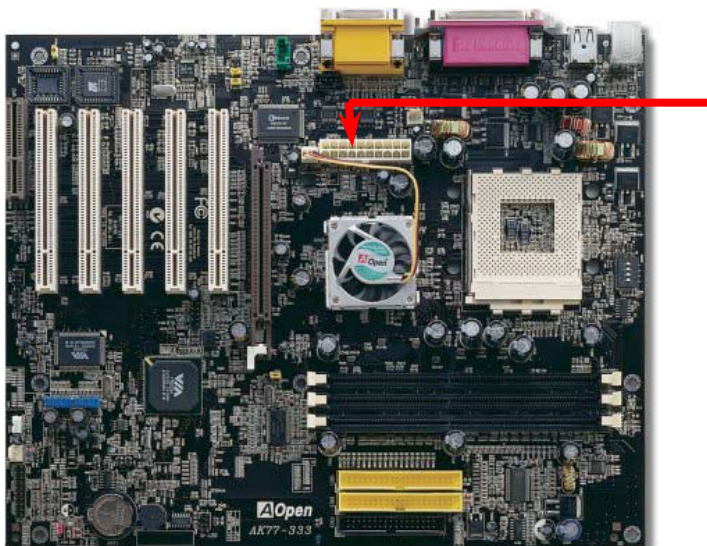

AC Power Auto Recovery

A traditional ATX system should remain at power off stage when AC power resumes from power failure. This design is inconvenient for a network server or workstation, without an UPS, that needs to keep power-on. This motherboard implements an AC Power Auto Recovery function to solve this problem.



IDE, Floppy Connector

Connect 34-pin floppy cable and 40-pin IDE cable to floppy connector FDC connector. Be careful of the pin1 orientation. Wrong orientation may cause system damage.

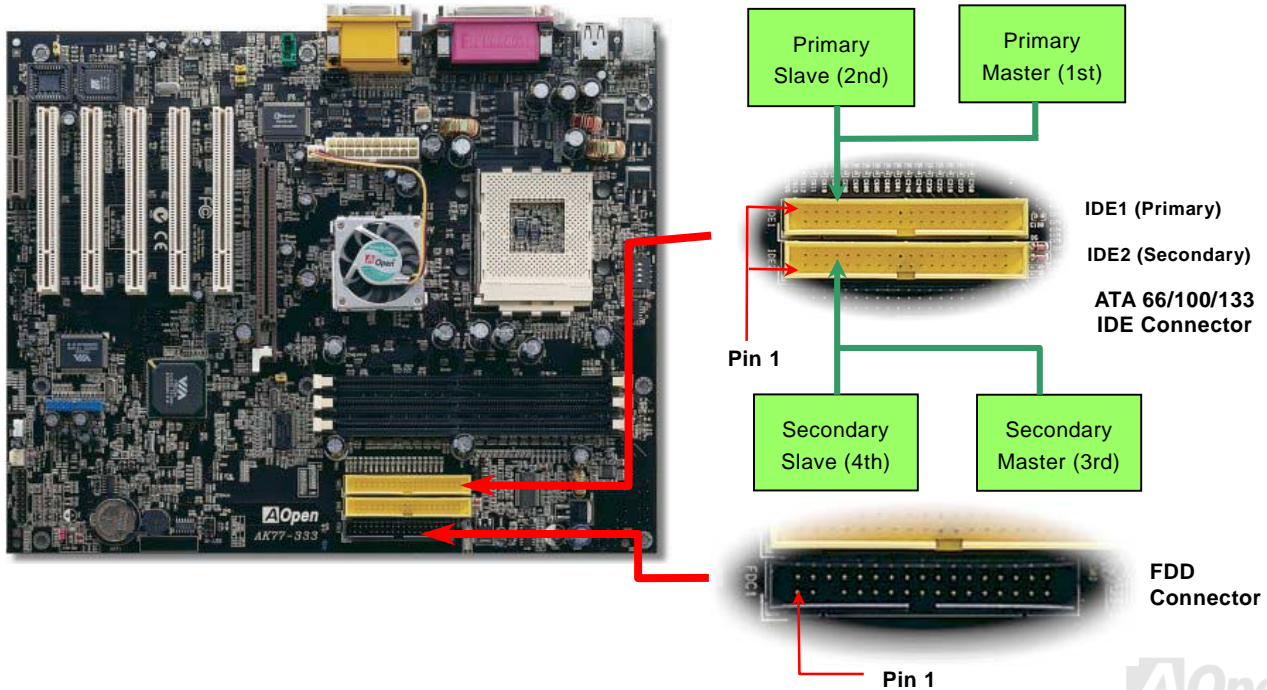

IDE1 is also known as the primary channel and IDE2 as the secondary channel. Each channel supports two IDE devices that make a total of four devices. In order to work together, the two devices on each channel must be set differently to **Master** and **Slave** mode. Either one can be the hard disk or the CDROM. The setting as master or slave mode depends on the jumper on your IDE device, so please refer to your hard disk and CDROM manual accordingly.

This motherboard supports [ATA66](#), [ATA100](#) or [ATA133](#) DE devices. Following table lists the transfer rate of IDE PIO and DMA modes. The IDE bus is 16-bit, which means every transfer is two bytes.

Mode	Clock Period	Clock Count	Cycle Time	Data Transfer Rate
PIO mode 0	30ns	20	600ns	$(1/600\text{ns}) \times 2\text{byte} = 3.3\text{MB/s}$
PIO mode 1	30ns	13	383ns	$(1/383\text{ns}) \times 2\text{byte} = 5.2\text{MB/s}$
PIO mode 2	30ns	8	240ns	$(1/240\text{ns}) \times 2\text{byte} = 8.3\text{MB/s}$
PIO mode 3	30ns	6	180ns	$(1/180\text{ns}) \times 2\text{byte} = 11.1\text{MB/s}$
PIO mode 4	30ns	4	120ns	$(1/120\text{ns}) \times 2\text{byte} = 16.6\text{MB/s}$
DMA mode 0	30ns	16	480ns	$(1/480\text{ns}) \times 2\text{byte} = 4.16\text{MB/s}$
DMA mode 1	30ns	5	150ns	$(1/150\text{ns}) \times 2\text{byte} = 13.3\text{MB/s}$
DMA mode 2	30ns	4	120ns	$(1/120\text{ns}) \times 2\text{byte} = 16.6\text{MB/s}$
ATA33	30ns	4	120ns	$(1/120\text{ns}) \times 2\text{byte} \times 2 = 33\text{MB/s}$
ATA66	30ns	2	60ns	$(1/60\text{ns}) \times 2\text{byte} \times 2 = 66\text{MB/s}$
ATA100	20ns	2	40ns	$(1/40\text{ns}) \times 2\text{byte} \times 2 = 100\text{MB/s}$
ATA133	15ns	2	30ns	$(1/30\text{ns}) \times 2\text{byte} \times 2 = 133\text{MB/s}$

Warning: The specification of the IDE cable is a maximum of 46cm (18 inches); make sure your cable does not exceed this length.

Tip:

- For better signal quality, it is recommended to set the far end side device to master mode and follow the suggested sequence to install your new device. Please refer to above diagram
- To achieve the best performance of Ultra DMA 66/100 hard disks, a special **80-wires IDE cable** for Ultra DMA 66/100 is required.



S/PDIF (Sony/Philips Digital Interface) Connector

S/PDIF (Sony/Philips Digital Interface) is a newest audio transfer file format, which provides impressive quality through optical fiber and allows you to enjoy digital audio instead of analog audio. Normally there are two S/PDIF outputs as shown, one for RCA connector, the most common one used for consumer audio products, and the other for optical connector with better audio quality. Through a specific audio cable, you can connect the S/PDIF connector to other end of the S/PDIF audio module, which bears S/PDIF digital output. However, you must have a S/PDIF supported speaker with S/PDIF digital input to connect to the S/PDIF digital output to make the most out of this function.

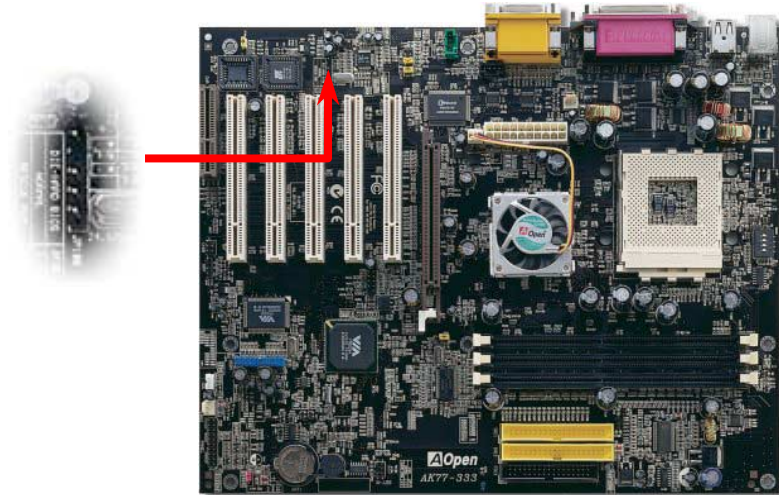
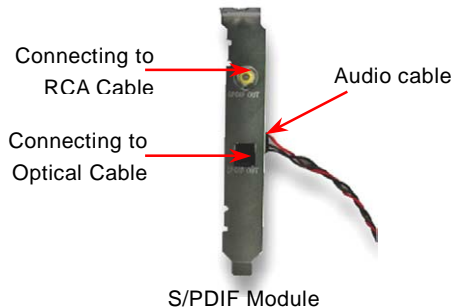

Super 5.1 Channel Audio Effect



This motherboard comes with an ALC650 Codec which supports high quality of 5.1 Channel audio effect, bringing you a brand new audio experience. On the strength of the innovative design of ALC650, you're able to use standard line-jacks for surround audio output without connecting any external module. To apply this function, you have to install the audio driver in the Bonus Pack CD as well as an audio application supporting 5.1 Channel. Picture bellow represents the standard location of all speakers in 5.1 Channel sound track. Please connect the plug of your front speakers to the green "Speaker out" port, rear speakers' plug to the blue "Line in" port and both of the center and subwoofer speakers to the red "MIC in" port.

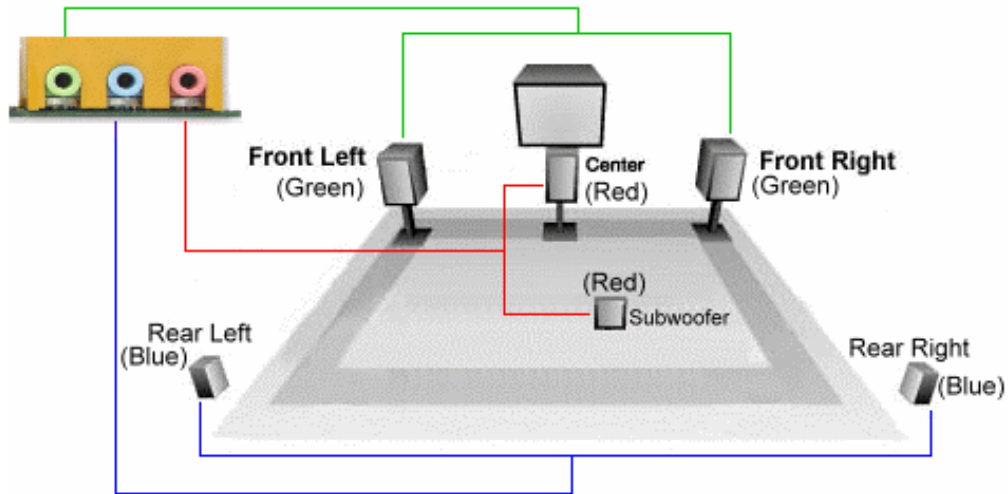

IrDA Connector

The IrDA connector can be configured to support wireless infrared module, with this module and application software such as Laplink or Windows 95 Direct Cable Connection, the user can transfer files to or from laptops, notebooks, PDA devices and printers. This connector supports HPSIR (115.2Kbps, 2 meters) and ASK-IR (56Kbps).

Install the infrared module onto the **IrDA** connector and enable the infrared function from BIOS Setup, [UART2 Mode](#), make sure to have the correct orientation when you plug in the IrDA connector.

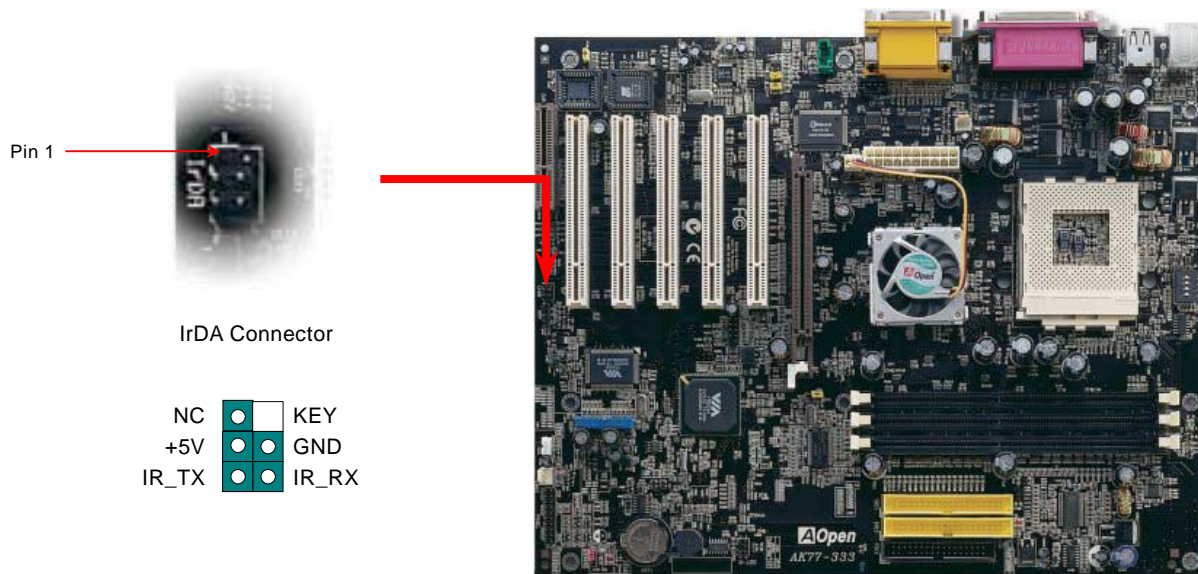

WOM (Zero Voltage Wake on Modem) Connector

This motherboard implements special circuit to support Wake On Modem, both Internal modem card and external box modem are supported. Since Internal modem card consumes no power when system power is off, it is recommended to use an internal modem. To use internal modem, connect 4-pin cable from **RING** connector of modem card to the **WOM** connector on the motherboard.

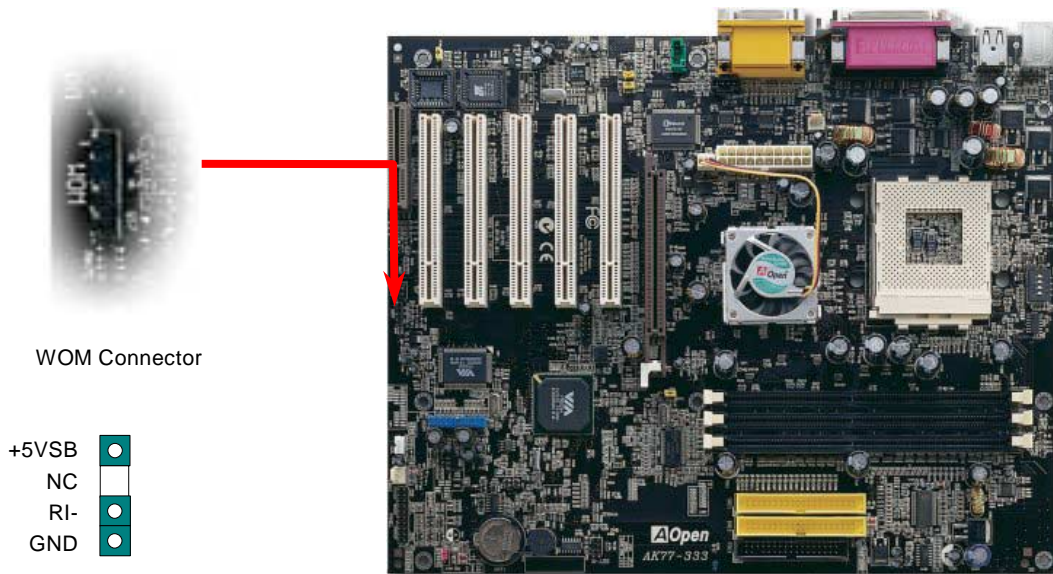

WOM by External BOX Modem

Traditional Green PC suspend mode does not really turn off the system power supply, it uses external box modem to trigger MB COM port and resume back to active.

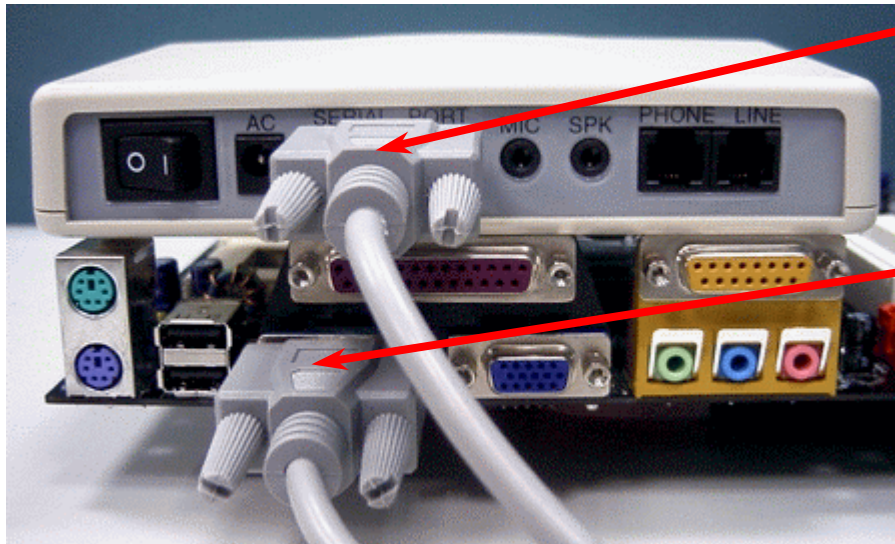

Note: This picture is for example only, it may not exactly be the same motherboard.

WOM by Internal Modem Card

With the help of the ATX soft power On/Off, it is possible to have a system totally power off, and wakeup to automatically answer a phone call as an answering machine or to send/receive a fax. You may identify whether or not your system is in true power off mode by checking to see if the fan of your power supply is off. Both an external box modem and an internal modem card can be used to support Modem Wake Up, but if you use an external modem, you have to leave your box modem on.

WOM Connector
(Motherboard Side)

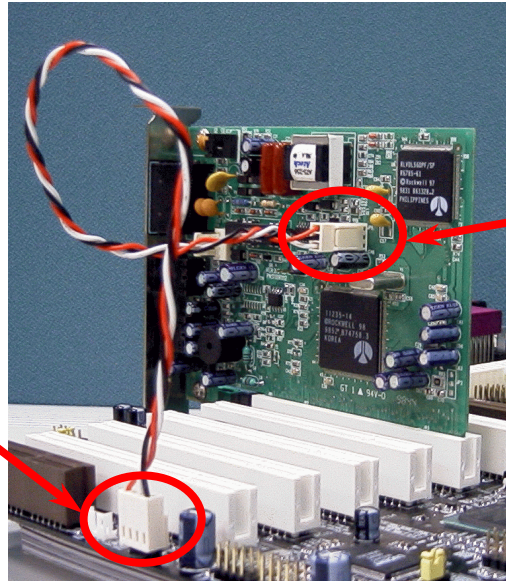

WOM Connector
(Modem Card)

Note: This picture is for example only, it may not exactly be the same motherboard.

WOL (Wake on LAN)

This feature is very similar as Wake On Modem, but it goes through local area network. To use Wake On LAN function, you must have a network card with chipset that supports this feature, and connect a cable from LAN card to motherboard WOL connector. The system identification information (probably IP address) is stored on network card and because there is a lot of traffic on the Ethernet, you need to install network management software, such as ADM, for the checking of how to wake up the system. Note that, at least 600mA ATX standby current is required to support the LAN card for this function.

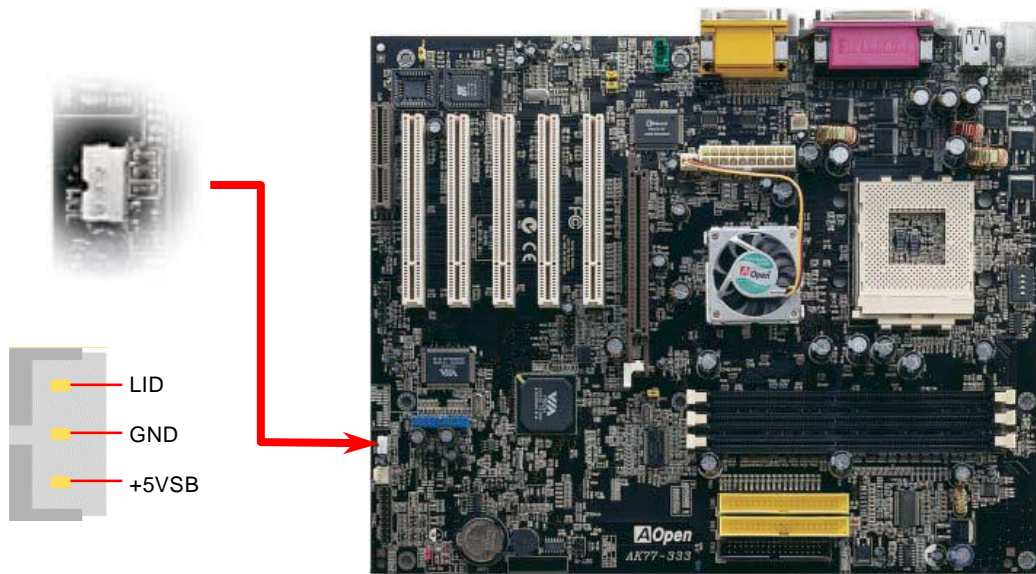

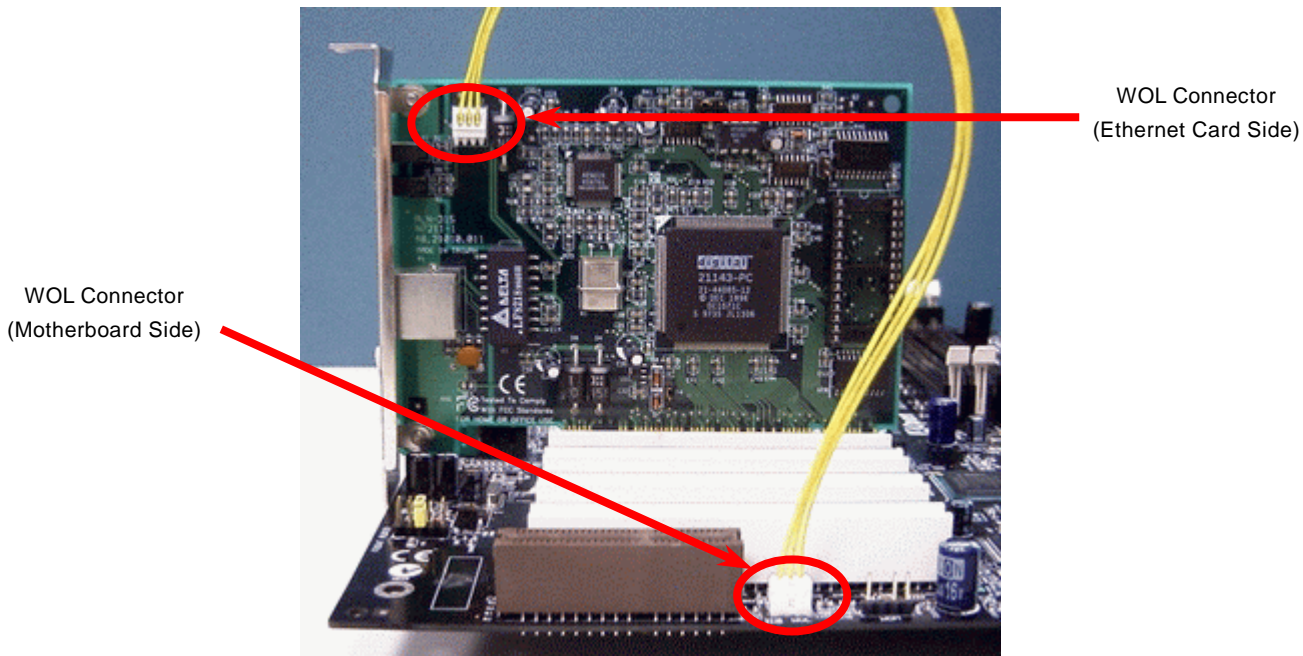

Note: This picture is for example only, it may not exactly be the same motherboard.

AGP (Accelerated Graphic Port) Expansion Slot

The AK77-333 provides an [AGP](#) 2x4x slot. The AGP 2x4x is a bus interface targeted for high-performance 3D graphic. AGP supports only memory read/write operation and single-master single-slave one-to-one only. AGP uses both rising and falling edge of the 66MHz clock, for 2X AGP, the data transfer rate is $66\text{MHz} \times 4\text{bytes} \times 2 = 528\text{MB/s}$. AGP is now moving to AGP 4x mode, $66\text{MHz} \times 4\text{bytes} \times 4 = 1056\text{MB/s}$. This AGP expansion slot is for 1.5V AGP card only.

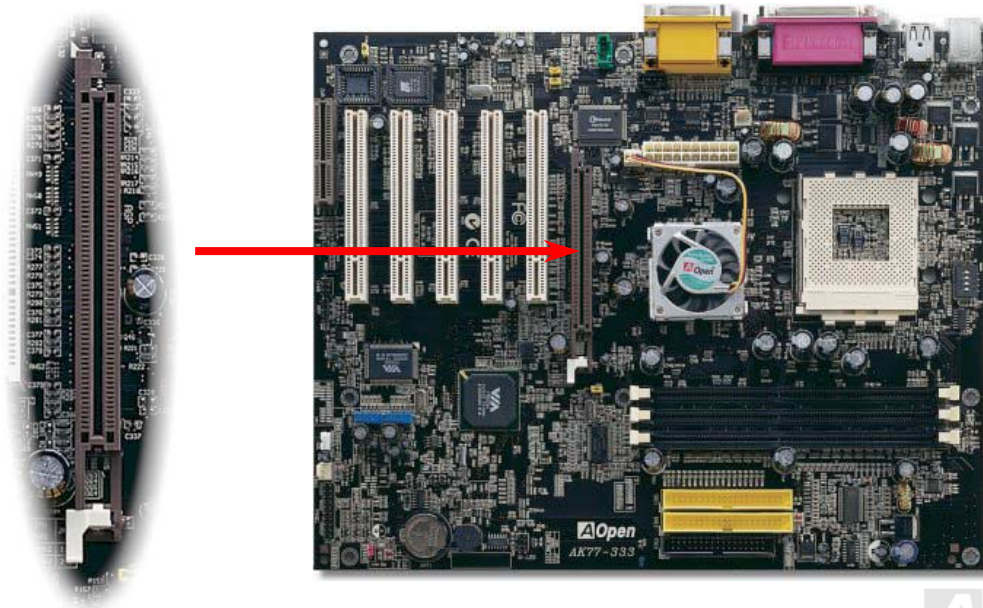

CNR (Communication and Network Riser) Expansion Slot

[CNR](#) is a riser card specification to replace the [AMR \(Audio/Modem Riser\)](#) that supports V.90 analog modem, multi-channel audio, and phone-line based networking. Owing to CPU computing power getting stronger, the digital processing job can be implemented in main chipset and share CPU power. The analog conversion ([CODEC](#)) circuit requires a different and separate circuit design, which is put on CNR card. This motherboard implements sound CODEC on board, but reserve CNR slot for the option of modem function. Note that you can still use PCI modem card.

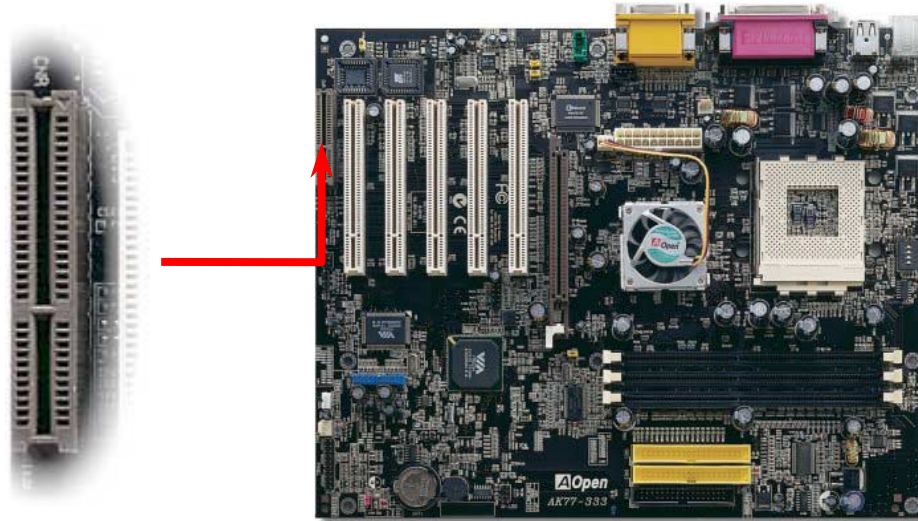

PC99 Color Coded Back Panel

The onboard I/O devices are PS/2 Keyboard, PS/2 Mouse, serial ports COM1 and COM2, Printer, [Eight USB](#), AC97 sound and game port. The view angle of drawing shown here is the back panel of the housing.

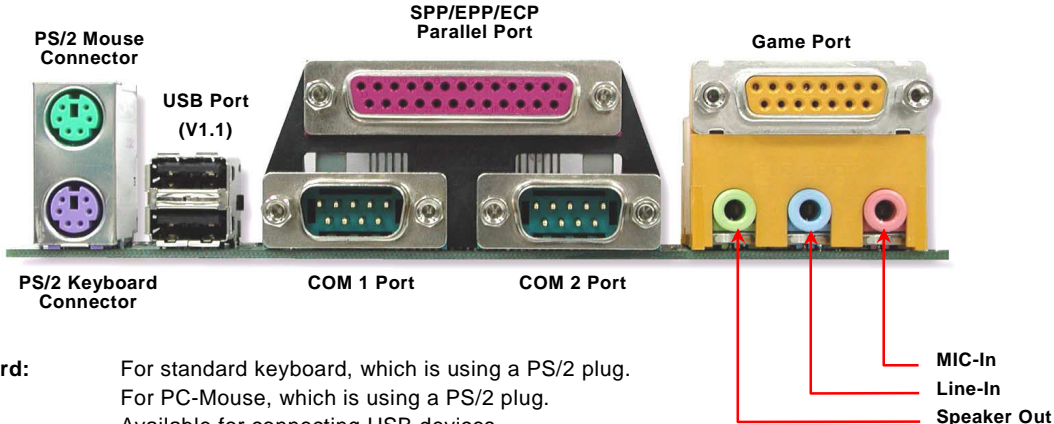

- PS/2 Keyboard:** For standard keyboard, which is using a PS/2 plug.
- PS/2 Mouse:** For PC-Mouse, which is using a PS/2 plug.
- USB Port:** Available for connecting USB devices.
- Parallel Port:** To connect with SPP/ECP/EPP printer.
- COM1 Port:** To connect with pointing devices, modem or others serial devices.
- Speaker Out:** To External Speaker, Earphone or Amplifier.
- Line-In:** Comes from the signal sources, such as CD/Tape player.
- MIC-In:** From Microphone.
- MIDI/Game Port:** For 15-pin PC joystick, game pad or MIDI devices.

Support 2nd USB Port

This motherboard provides eight [USB](#) ports to connect USB devices, such as mouse, keyboard, modem, printer, etc. There are two connectors on the PC99 back panel. You can use proper cables to connect the other USB connectors to the USB modules or front panel of chassis. Please note that both USB3 and USB4 connectors support USB 2.0 function (optional) which we will introduce in next section

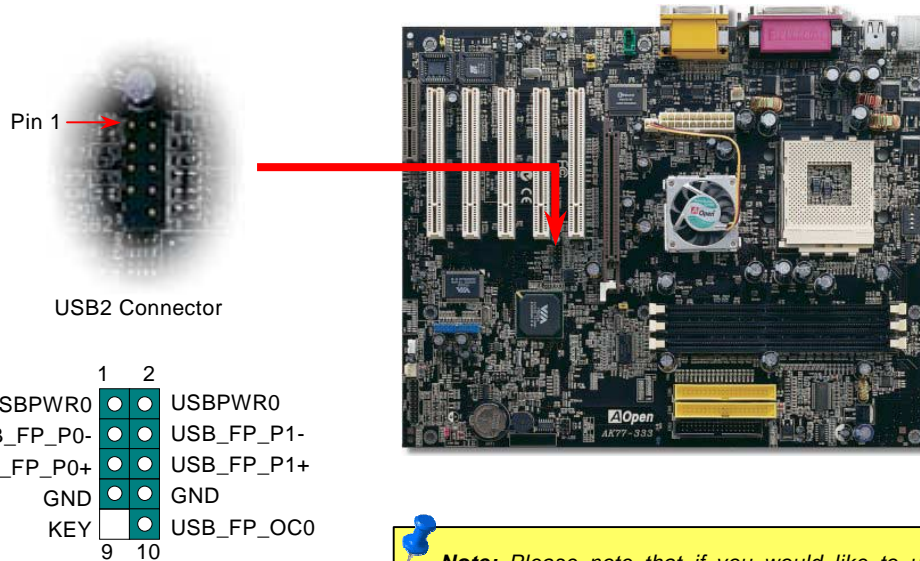

Note: Please note that if you would like to use USB devices (Example: keyboard, mouse.etc.) under DOS environment, you must install driver comes with the devices to make it work.

Support 3rd and 4th USB2.0 Ports (Optional)



Compared to traditional USB 1.0/1.1 with the speed of 12Mbps, USB 2.0 has a fancy speed up to 480Mbps which is 40 times faster than the traditional one. Except for the speed increase, USB 2.0 supports old USB 1.0/1.1 software and peripherals, offering impressive and even better compatibility to customers. On this motherboard, USB3 and USB4 connectors support USB 2.0 function. To connect those two headers, you have to use proper USB cables and connect them to any USB models.



Pin 1

USB4 and USB3 Connector

	1	2		
USBPWR0	●	●	USBPWR0	
USB_FP_P0-	●	●	USB_FP_P1-	
USB_FP_P0+	●	●	USB_FP_P1+	
GND	●	●	GND	
KEY	□	●	USB_FP_OC0	
	9	10		

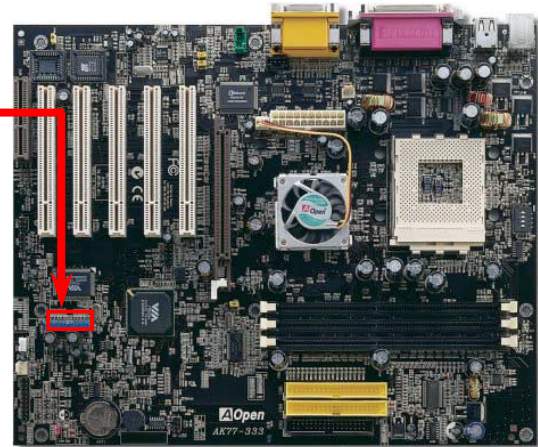

Chassis Intrusion Sensor

The “CASE OPEN” header provides chassis intrusion-monitoring function. To make this function works, you have to enable it in the system BIOS, connect this header to a sensor somewhere on the chassis. So, whenever the sensor is triggered by lights or the opening of the chassis, the system will send out beep sound to inform you. Please be informed that this useful function only applies to advanced chassis, you may purchase an extra sensor, attach it on your chassis, and make a good use of this function.

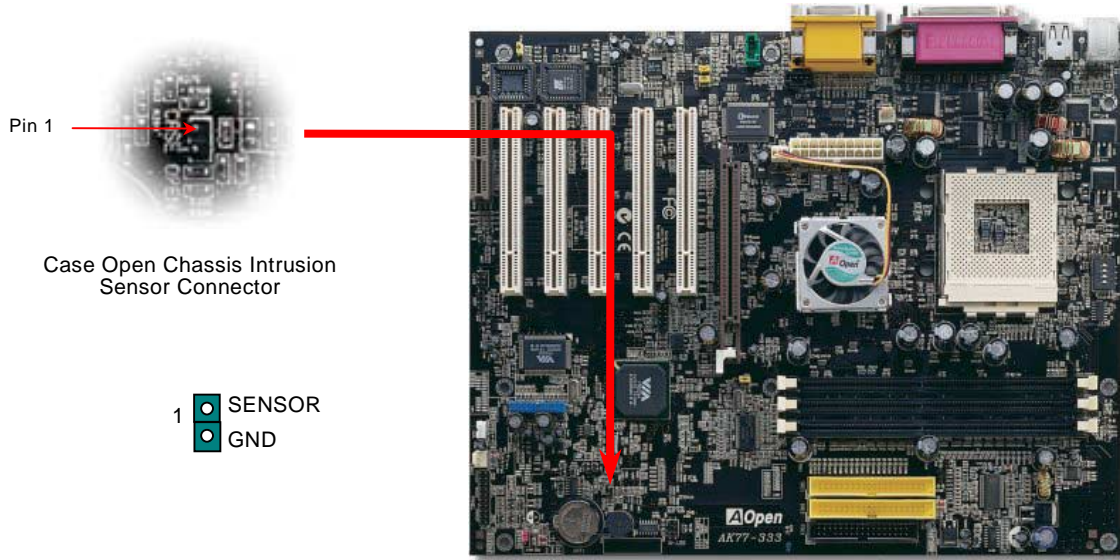

CD Audio Connector

This connector is used to connect CD Audio cable from CD-ROM or DVD drive to onboard sound.

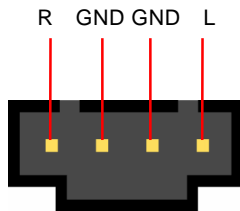

CD-IN

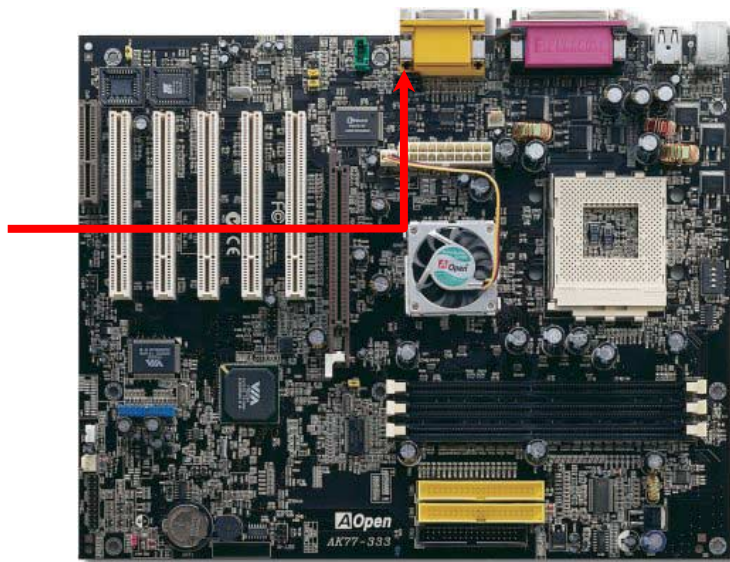

AUX-IN Connector

This connector is used to connect MPEG Audio cable from MPEG card to onboard sound.

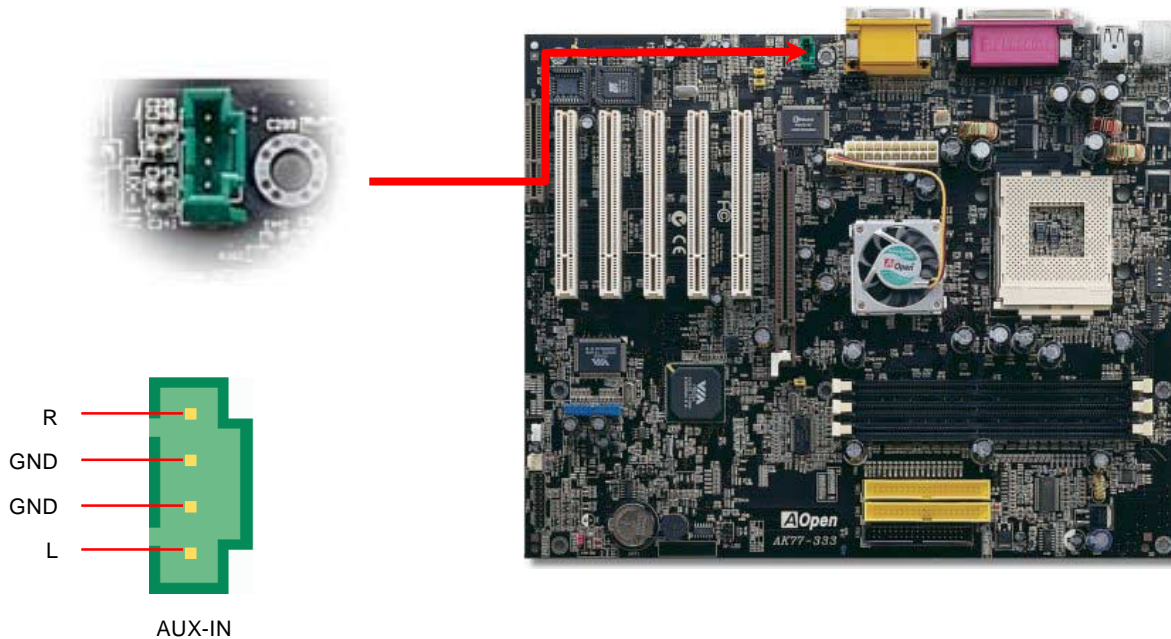

Front Audio Connector

If the housing has been designed with an audio port on the front panel, you'll be able to connect onboard audio to front panel through this connector. By the way, please remove 5-6 and 9-10 jumper caps from the Front Audio Connector before connecting the cable. Please do not remove these 5-6 and 9-10 yellow jumper caps if there's no audio port on the front panel.

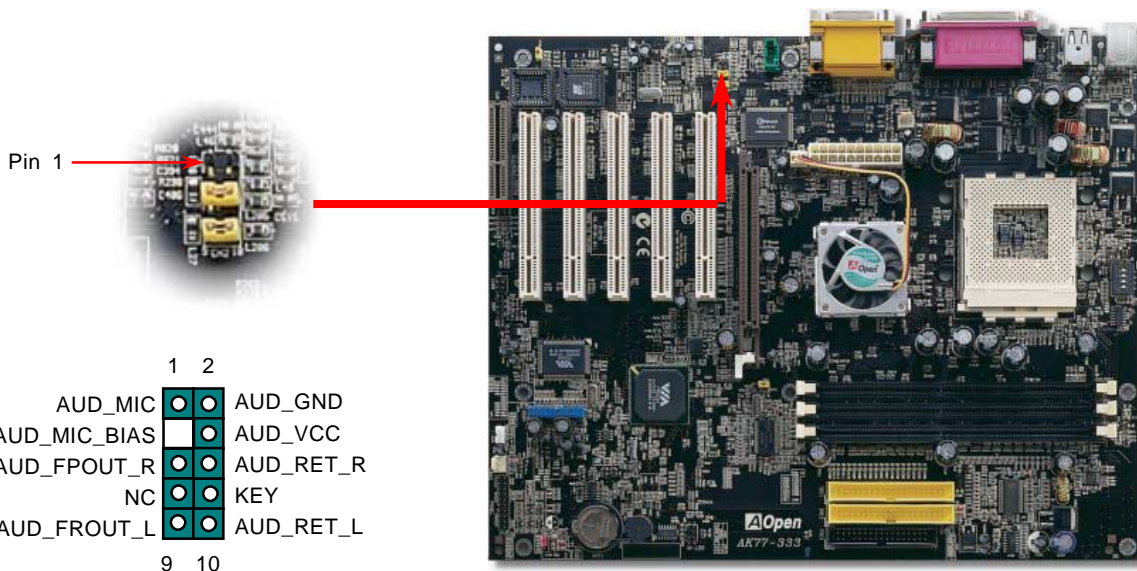

Die-Hard BIOS (100% Virus Protection, Upgrade Optional)

Recently, many viruses have been found that they may destroy bios code and data area. Therefore, this motherboard implements a very effective hardware protection method that does not involve any software or BIOS coding, hence it is 100% virus free. You may restore the originally mounted BIOS with 2nd BIOS ROM by setting JP30 to pin 2-3 if it fails to act normally. This motherboard comes with one BIOS ROM, you may contact our local distributor or reseller for purchasing the extra BIOS ROM. Please visit our website: www.aopen.com for details.

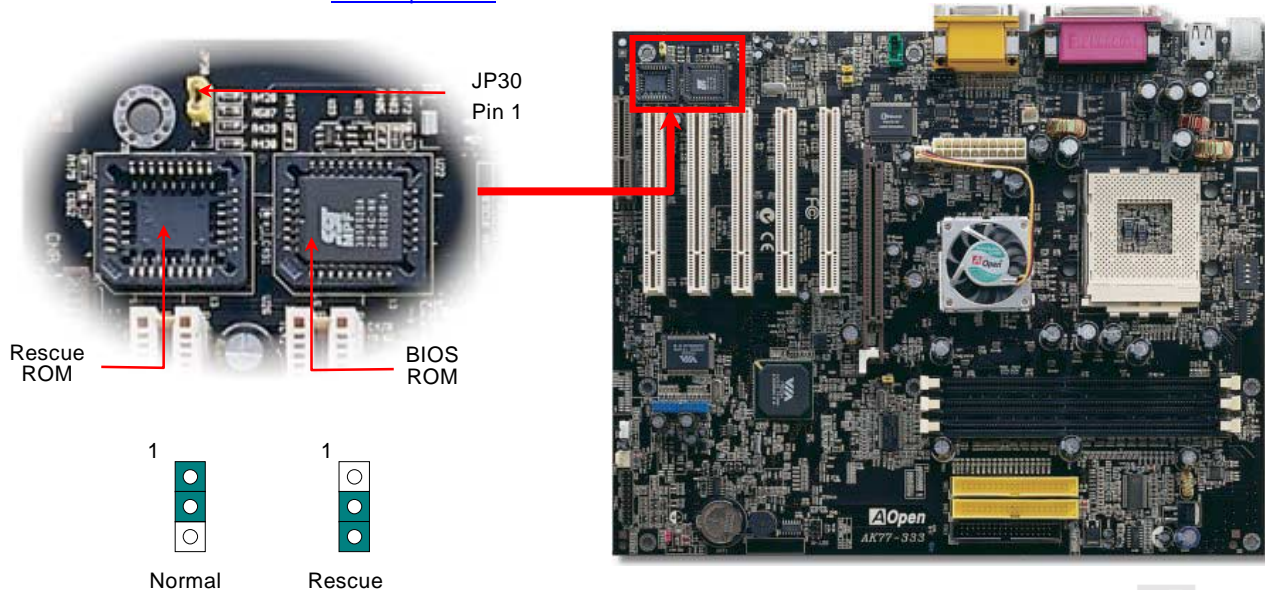

External Controller for DIE-HARD BIOS (Upgrade Optional)

External Controller provides you a better and convenience way to switch the BIOS status between “**Rescue**” and “**Normal**” without opening the case of your computer. You have to plug the jumper cable to the connector pin (**JP30**) on the motherboard. Be careful of the orientation when you connect, the red wire should correspond to Pin1.

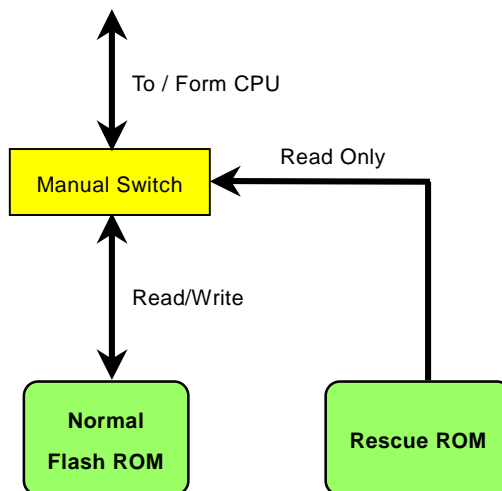

Note: If you suspect your BIOS is infected by virus, just rescue your bios by following steps:

1. Turn off the system, set the External Controller to "**Rescue**" to read from rescue ROM.
2. Boot the system and set the switch back to "**Normal**".
3. Follow the BIOS upgrade procedure to rehabilitate BIOS.

Reboot the system, and you should be able to go back to normal mode.

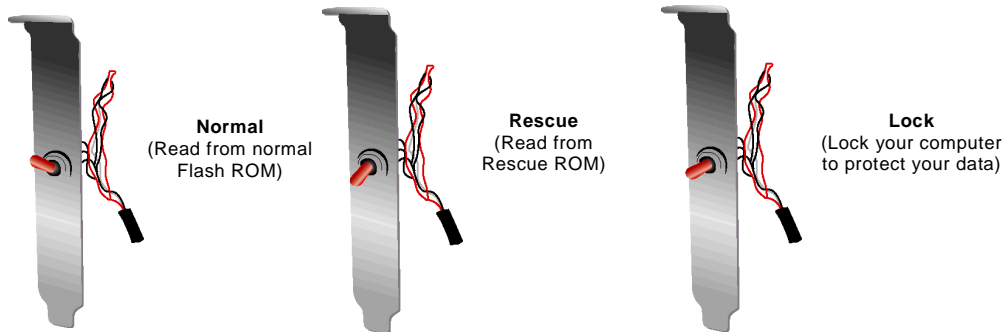

Tip: If you place the switch to the middle (as 3rd picture shows), you will not be able to boot your system, thus you can protect your data from molesting.

Dr. LED Connector (Upgrade Optional)

In conjunction with Dr. LED (Upgrade Optional), which can easily show what kind of problem you may incur on your system during assembly. It can clearly indicate whether there is a component issue or an installed issue by the 8 LEDs on the front panel of Dr. LED. This helps you quickly self-diagnostic your system status.

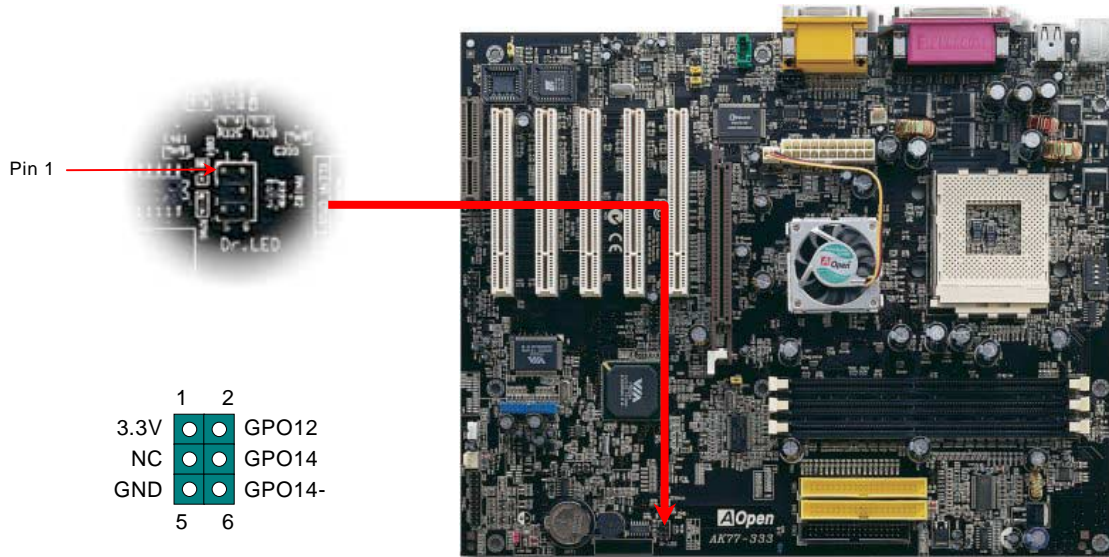

Dr. LED is a CD disc storage box with 8 LEDs on its front panel, the size of Dr. LED is exactly the same as 5.25 in floppy drive, so that it can be mount into normal 5.25 in drive bay of any housing.

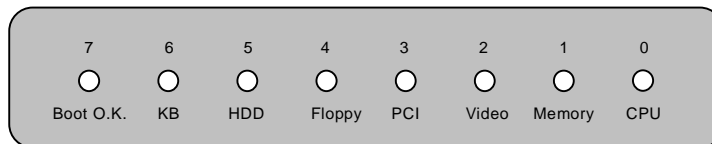

The total 8 LEDs light up alternatively if the system fails in one of eight stages. Once the LED7 (latest LED) is lit, this indicates that the system has completed its boot-up procedure.

The 8 LEDs indicate the following messages when lit:

LED 0 - Indicates that the CPU may have been installed incorrectly or is damaged.

LED 1 - Indicates that the memory may have been installed incorrectly or is damaged.

LED 2 - Indicates that the AGP may have been installed incorrectly or is damaged.

LED 3 - Indicates that the PCI card may have been installed incorrectly or is damaged.

LED 4 - Indicates that the floppy disk drive may have been installed incorrectly or is damaged.

LED 5 - Indicates that the HDD may have been installed incorrectly or is damaged.

LED 6 - Indicates that the keyboard may have been installed incorrectly or is damaged.

LED 7 - Indicates that the system is OK.

Note: During POST (Power On Self Test) procedure, the Debug LED will light on sequentially from LED0 to LED7 until the system boot O.K

Battery-less and Long Life Design

This Motherboard implements [Flash ROM](#) and a special circuit that allows you to save your current CPU and CMOS Setup configurations without using the battery. The RTC (real time clock) can also keep running as long as the power cord is plugged. If you lose your CMOS data by accident, you can just reload the CMOS configurations from Flash ROM and the system will recover as usual.

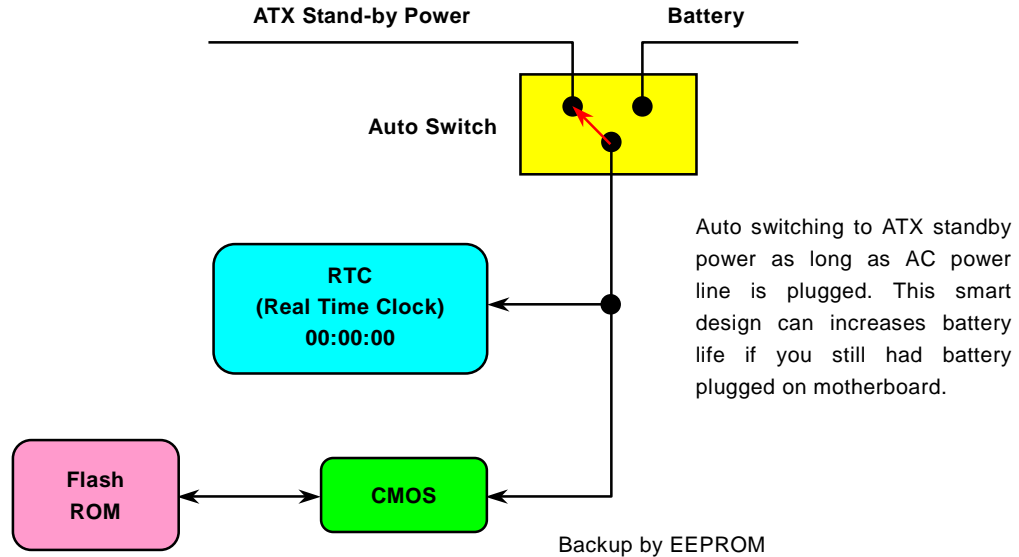

Over-current Protection

It is very popular that the Over Current Protection was implemented on ATX 3.3V/5V/12V switching power supply. However, the new generation CPU uses different voltages that has regulator to transfer 5V to CPU voltage (for example, 2.0V), and thus makes 5V over current protection useless. This motherboard is equipped with switching regulator onboard which supports CPU over-current protection; in conjunction with 3.3V/5V/12V power supply to provide the full line over-current protection.

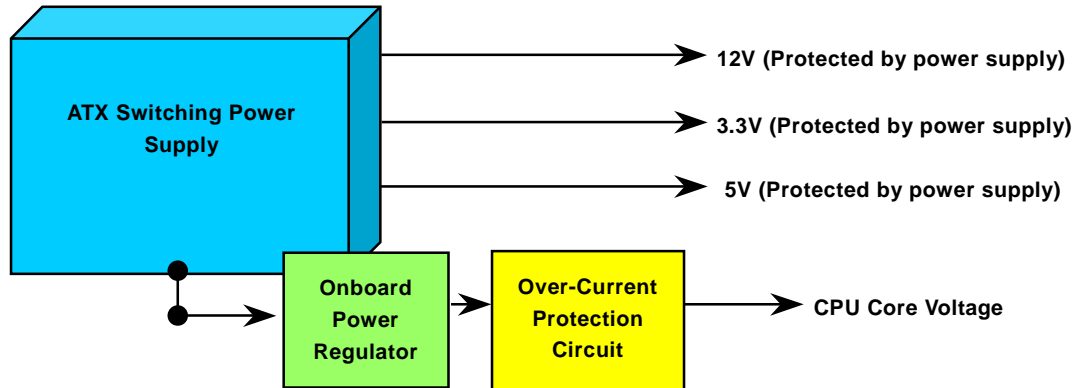

Note: Although we have implemented protection circuit try to prevent any human operating mistake, there is still certain risk that CPU, memory, HDD, add-on cards installed on this motherboard may be damaged because of component failure, human operating error or unknown nature reason. **AOpen cannot guaranty the protection circuit will always work perfectly.**

Hardware Monitoring

This motherboard implements a hardware monitoring system. As you turn on your system, this smart design will continue to monitor your system's working voltage, fan status and CPU temperature. If any of these systems' status goes wrong, there will be an alarm through the AOpen [Hardware Monitoring Utility](#) to warn the user.

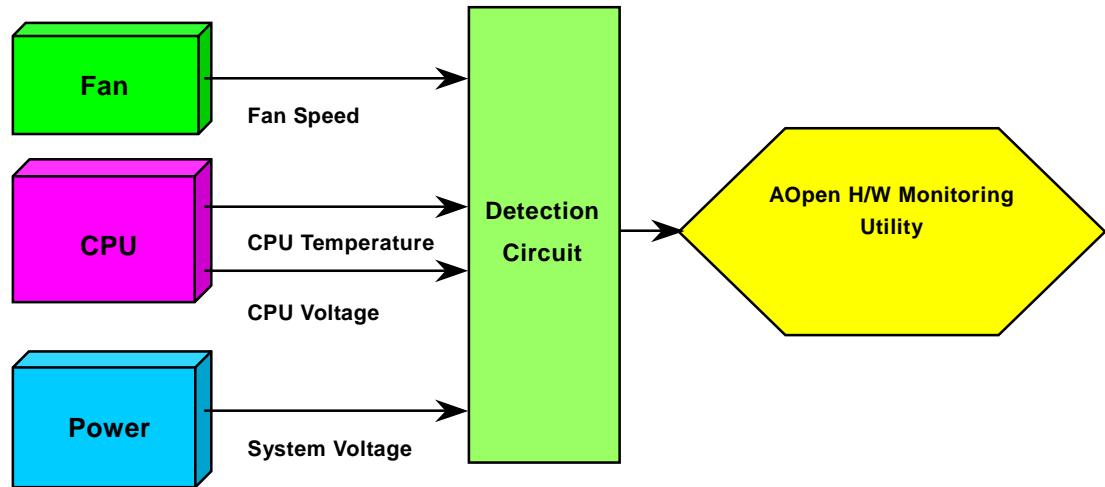

Resettable Fuse

Traditional motherboard has fuse for Keyboard and [USB](#) port to prevent over-current or shortage. These fuses are soldered onboard that user cannot replace it when it is damaged (did the job to protect motherboard), and the motherboard remains malfunction.

With expensive Resettable Fuse, the motherboard can resume back to normal function after fuse had done its protection job.

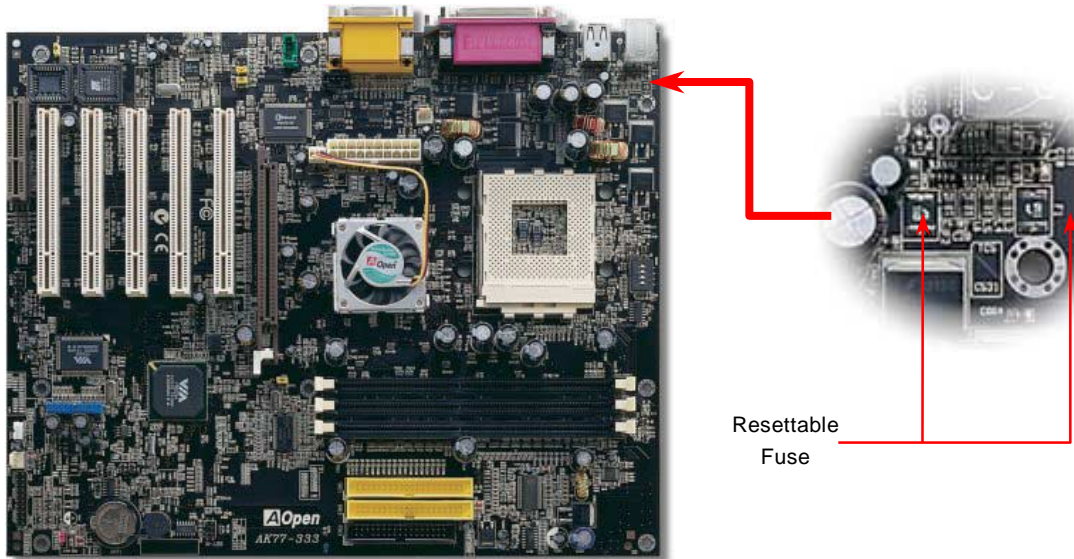

2200 μF Low ESR Capacitor

The quality of low ESR capacitor (Low Equivalent Series Resistance) during high frequency operation is very important for the stability of CPU power. The idea of where to put these capacitors is another know-how that requires experience and detail calculation.

Not only that, this motherboard implements 2200 μF capacitor, which is much larger than normal capacitor (1000 or 1500 μF) and it provides better stability for CPU power.

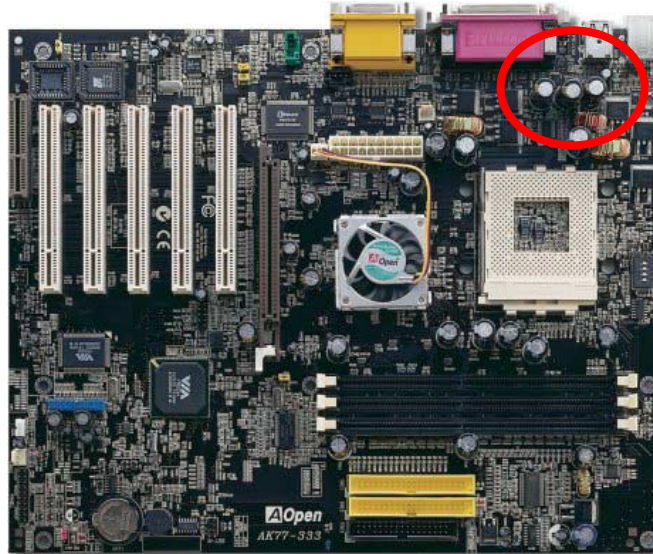

Layout (Frequency Isolation Wall)

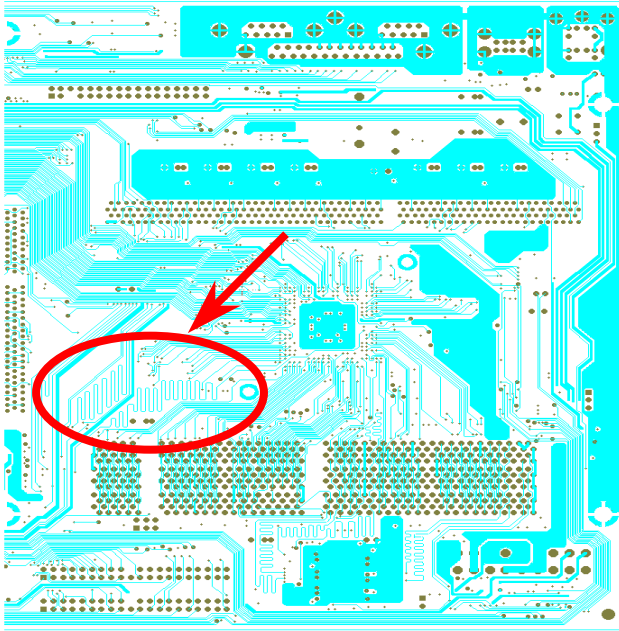

For high frequency operation, especially overclocking, layout is the most important factor to make sure chipset and CPU working in stable condition. The layout of this motherboard implements AOpen's unique design called " Frequency Isolation Wall". Separating each critical portion of motherboard into regions where each region operates in a same or similar frequency range to avoid cross talk and frequency interference between each region's operations and condition. The trace length and route must be calculated carefully. For example, the clock trace must be equal length (not necessarily as short as possible) so that clock skew will be controlled within few a pico second ($1/10^{12}$ Sec)

Note: This diagram is for example only, it may not exactly be the same diagram of this motherboard.

Fansink on North Bridge

In order to provide a better effect of cooling and make the chipset work more stable, we especially design a fansink on the north bridge. After locating the fansink on the north bridge, plug the connector to the header marked FAN3 (AUX Fan) on the motherboard.

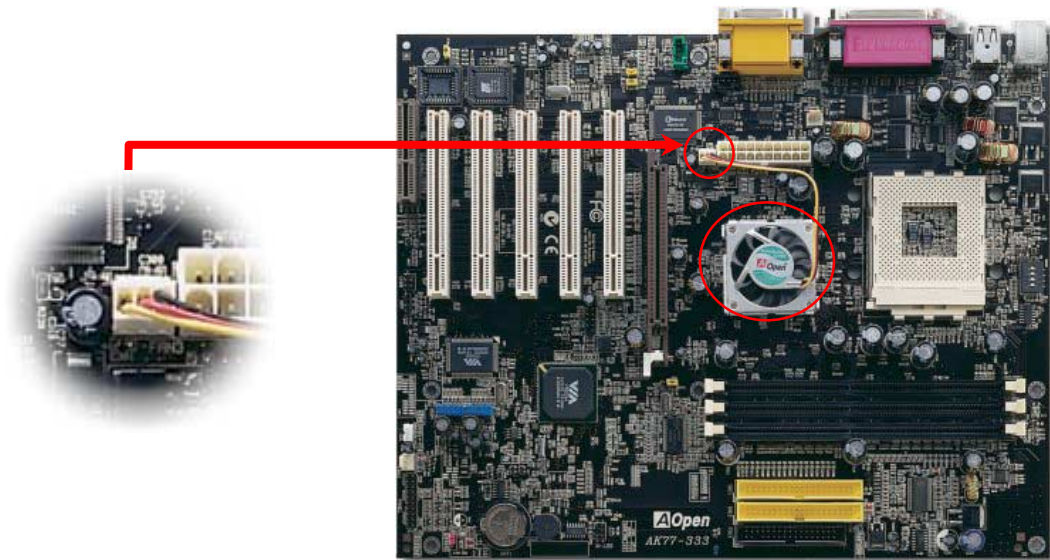

Driver and Utility

There are motherboard drivers and utilities included in [AOpen Bonus CD disc](#). You don't need to install all of them in order to boot your system. But after you finish the hardware installation, you have to install your operation system first (such as Windows 98) before you can install any drivers or utilities. Please refer to your operation system's installation guide.



Note: Please follow recommended procedure to install [Windows 95](#) and [Windows 98](#).

Auto-run Menu from Bonus CD Disc

You can use the auto-run menu of Bonus CD disc. Choose the utility and driver and select model name.

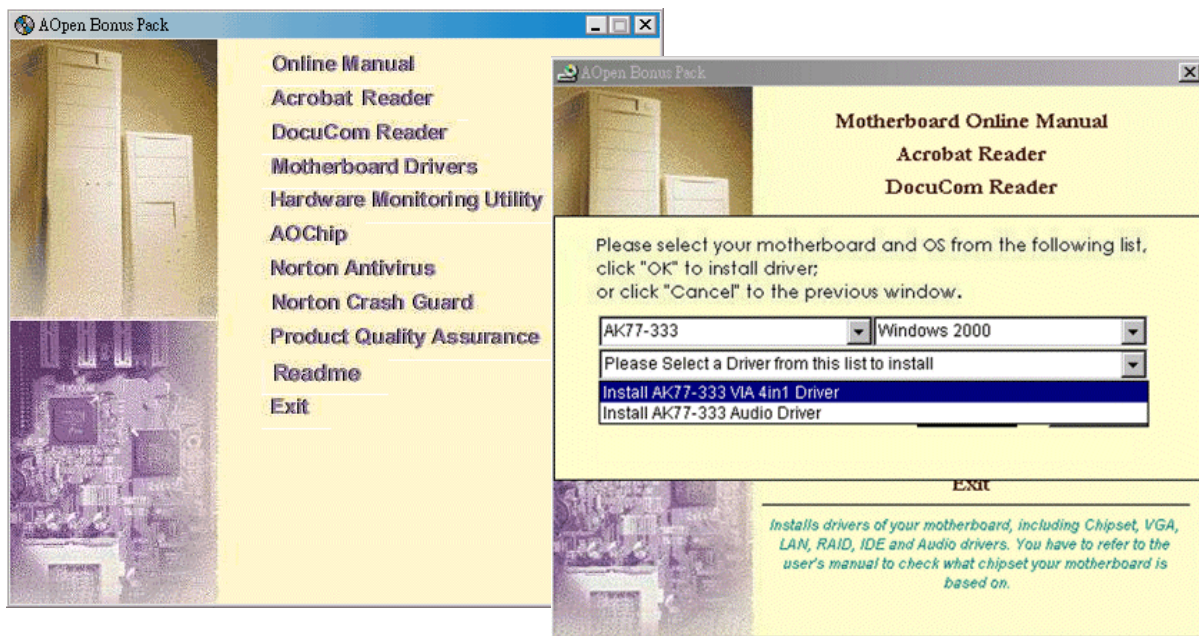

Installing Windows 95

1. First, don't install any add-on card except [AGP](#) card.
2. Install Windows 95 OSR2 v2.1, 1212 or 1214 version and later with USB support. Otherwise, you need to install USBSUPP.EXE.
3. Install the [VIA 4 in 1 driver](#), which includes VIA AGP Vxd driver, VIA ATAPI Vendor Support driver and VIA registry (INF) program.
4. Finally, Install other add-on cards and their drivers.

Installing Windows 98

1. First, don't install any add-on card except [AGP](#) card.
2. Enable USB Controller in BIOS Setup > Advanced Chipset Features > OnChip USB, to make BIOS fully capable of controlling IRQ assignment.
3. Install Window 98 into your system.
4. Install the [VIA 4 in 1 driver](#), which includes VIA AGP Vxd driver, IRQ Routing, VIA ATAPI Vendor Support driver and VIA registry (INF) program.
5. Finally, Install other add-on cards and their drivers.

Installing Windows® 98 SE, Windows® ME & Windows® 2000

If you are using Windows® 98 Second Edition, Windows® Millennium Edition or Windows® 2000, you do not need to install the 4-in-1 driver as the IRQ Routing Driver and the ACPI Registry are already incorporated into the operating system. Users with Windows® 98 SE may update the VIA Registry INF and AGP drivers by installing them individually.

Please refer to [VIA Technologies Inc.](http://www.via.com/) for latest version of 4 in 1 driver:

<http://www.via.com/>

<http://www.via.com/drivers/4in1420.exe>

Installing VIA 4 in 1 Driver

You can install the VIA 4 in 1 driver ([IDE Bus master](#) (For Windows NT use), VIA ATAPI Vendor Support Driver, VIA [AGP](#), IRQ Routing Driver (For Windows 98 use), VIA Registry (INF) Driver) from the Bonus Pack CD disc auto-run menu.

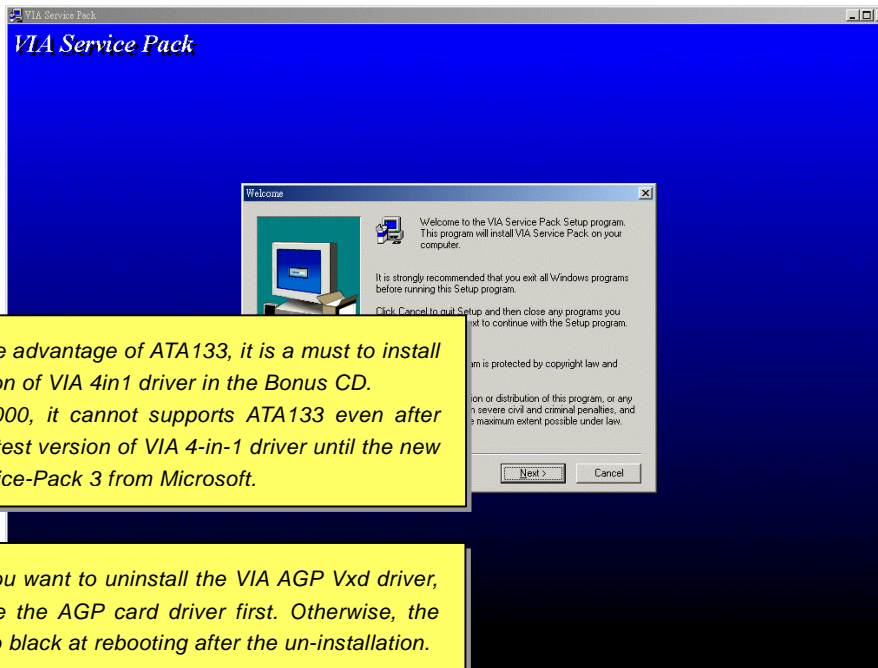

Warning: To take advantage of ATA133, it is a must to install the latest version of VIA 4in1 driver in the Bonus CD. For Windows2000, it cannot supports ATA133 even after installing the latest version of VIA 4-in-1 driver until the new release of Service-Pack 3 from Microsoft.

Warning: If you want to uninstall the VIA AGP Vxd driver, please remove the AGP card driver first. Otherwise, the screen may go black at rebooting after the un-installation.

Installing Onboard Sound Driver

This motherboard comes with Realtek ALC650 [AC97 CODEC](#) and the sound controller is in VIA South Bridge chipset. You can find the audio driver from the Bonus Pack CD disc auto-run menu.

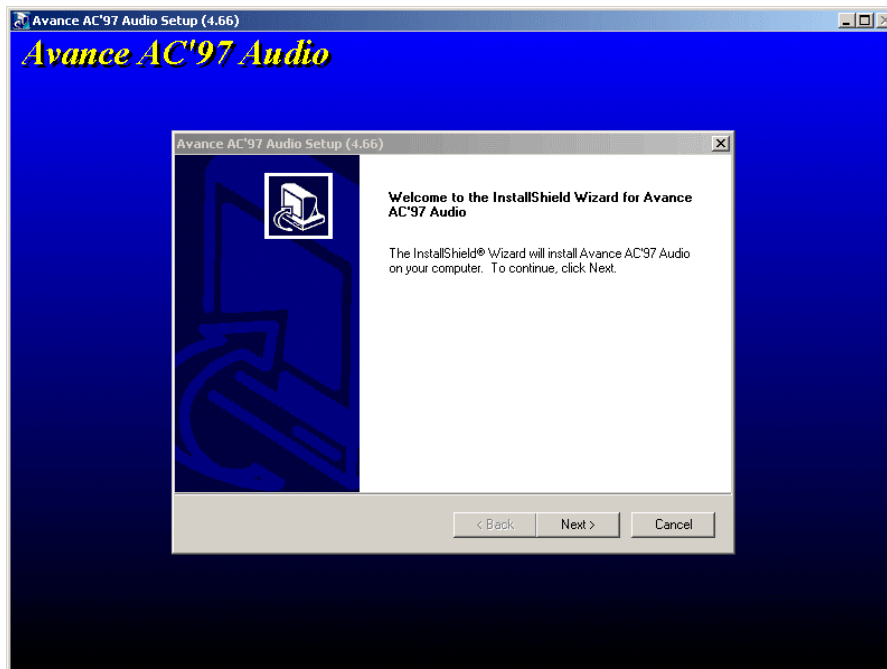

Installing Hardware Monitoring Utility

You can install Hardware Monitoring Utility to monitor CPU temperature, fans and system voltage. The hardware monitoring function is automatically implemented by the BIOS and utility software. No hardware installation is needed.

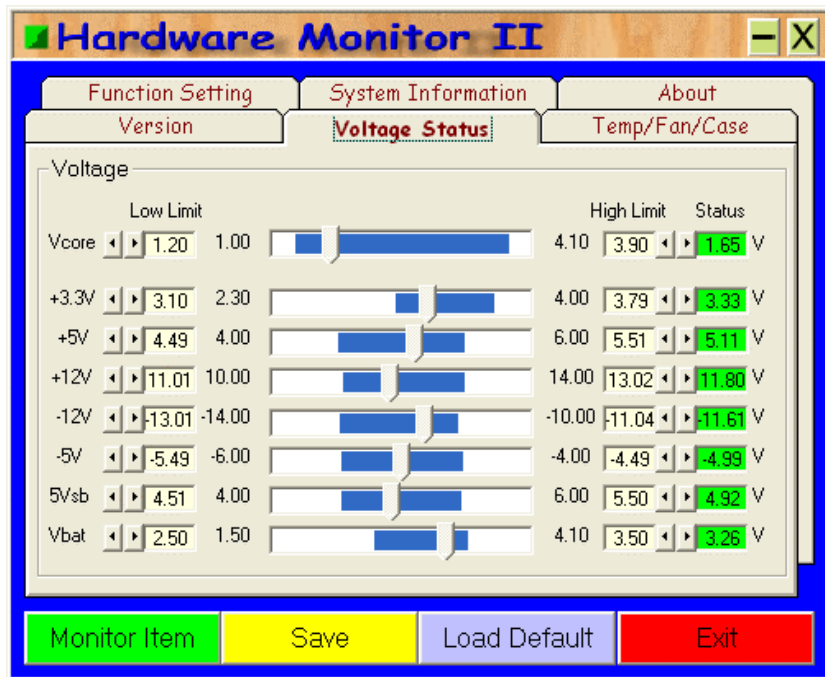

Installing USB2.0 Driver (Optional)

This motherboard comes with USB2.0 function. You can install USB2.0 Driver under Windows 98SE, Windows ME, Windows 2000 and Windows XP from the Bonus Pack CD disc auto-run menu.

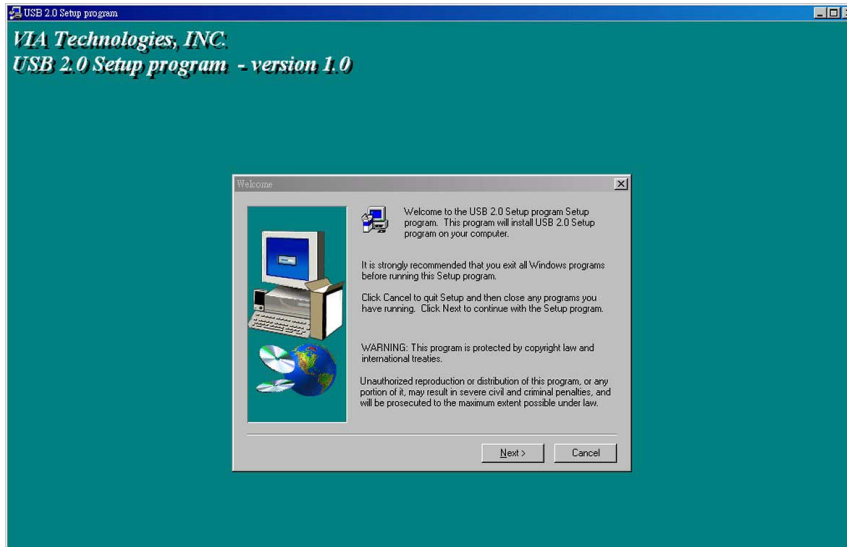

Note: After installing USB 2.0 driver under WinME, there would be a "green question mark" on "VIA USB 2.0 Enhanced Host Controller" item. Please rest assured that it is not an error message. You may just ignore it.

(This page is intentionally left blank for notes)

(This page is intentionally left blank for notes)

ACPI Suspend to Hard Drive

[ACPI](#) Suspend to Hard Drive is basically controlled by Windows operation system. It saves your current work (system status, memory and screen image) into hard disk, and then the system can be totally power off. Next time, when power is on, you can resume your original work directly from hard disk within few seconds without go through the Windows booting process and run your application again. If your memory is 64MB, normally, you need to reserve at least 64MB HDD space to save your memory image.

When go into Suspend:

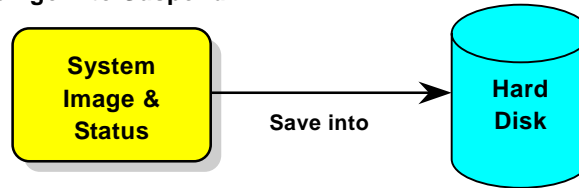

When power-on next time:

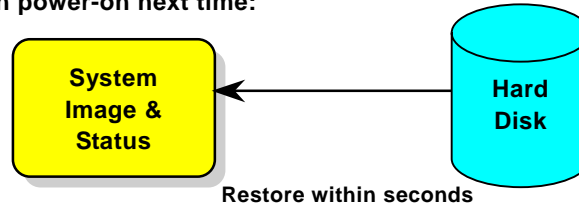

System Requirement

1. **AOZVHDD.EXE 1.30b** or later.
2. Delete **config.sys** and **autoexec.bat**.

Fresh installation of Windows 98 on a new system

1. Execute "**Setup.exe /p j**" to install Windows 98
2. After Windows 98's installation is complete, go to the **Control Panel > Power Management**.
 - a. Set **Power Schemes > System Standby** to "Never".
 - b. Click on "Hibernate" and select "Enable Hibernate Support" then "Apply".
 - c. Click on the "Advanced" tab, you'll see "Hibernate" on "Power Buttons". Note that this option will only be seen after step b mentioned above has been completed; otherwise only "Standby" and "Shutdown" will be shown. Select "Hibernate" and "Apply".
3. Clean boot into DOS and run AOZVHDD utility.
 - a. If you assign the whole disk to your Win 98 system (FAT 16 or FAT 32), please run "**aozvhd /c /file**". Please remember sufficient free space has to be reserved in the disk, e.g. if you have 64 MB DRAM and 16 MB VGA card installed, the system needs at least 80 MB free space. The utility will locate the space automatically.
 - b. If you assign an individual partition for Win 98, please run "**aozvhd /c /partition**". Of course, the system needs to provide unformatted an empty partition.
4. Reboot system.
5. You've already implemented ACPI Suspend to-Hard Drive. Click "**Start > Shut Down > Standby**" then the screen will go off immediately. And 1 minute or so will be taken for the system to save what's in the memory to the hard drive; the larger the

memory size the longer this process will take.

Changing from APM to ACPI (Windows 98 only)

1. Run "Regedit.exe"

- a. Go through the following path

HKEY_LOCAL_MACHINE

SOFTWARE

MICROSOFT

WINDOWS

CURRENT VERSION

DETECT

- b. Select "ADD Binary" and name it as "**ACPIOPTION**".
- c. Right click and select Modify, add "01" after "0000" to make it "0000 01".
- d. Save changes.

2. Select "Add New Hardware" under Control Panel. Allow Windows 98 to detect new hardware. (It will find "**ACPI BIOS**" and remove "**Plug and Play BIOS**")

3. Reboot system.

4. Clean boot into DOS and run "AOZVHDD.EXE /C /File"

Changing from ACPI to APM

1. Run "Regedit.exe"

- a. Go through the following path

HKEY_LOCAL_MACHINE
SOFTWARE
MICROSOFT
WINDOWS
CURRENT VERSION
DETECT
ACPI OPTION

- b. Right click and select "Modify, change "01" to "02" to make it "0000 02".



Tip: "02" means Windows 98 is ACPI acknowledged but the ACPI function is disabled.

- c. Save changes.
2. Select "Add New Hardware" under Control Panel. Allow Windows 98 to detect new hardware. (It will find "**Plug and Play BIOS**" and **remove "ACPI BIOS"**)
 3. Reboot system.
 4. Run "Add New Hardware" again and it will find "Advanced Power Management Resource".
 5. Click "OK".



Tip: Currently we found only ATI 3D Rage Pro AGP card would support ACPI suspend to disk. Please refer to AOpen web site for latest update

ACPI Suspend to RAM (STR)

This motherboard supports [ACPI](#) Suspend to RAM function. With this function, you can resume your original work directly from SDRAM without going through the Windows 98 booting process and run your application again. Suspend to SDRAM saves your current work in the system memory, it is faster than Suspend to Hard Drive but requires power supplied to SDRAM, while Suspend to Hard Drive requires no power.

When go into Suspend:

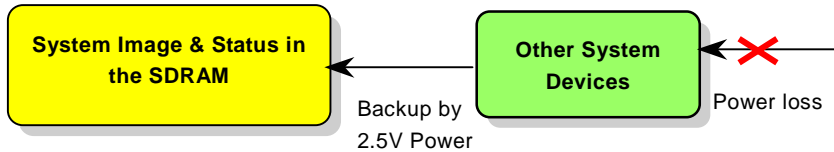

When power-on next time:

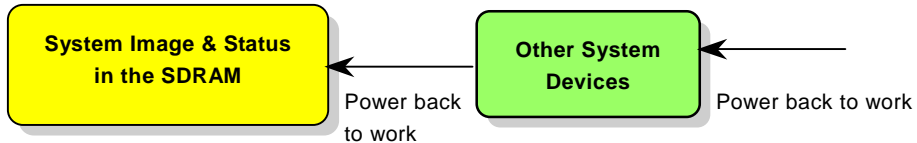

To implement ACPI Suspend to DRAM, please follow the procedures as below:

System Requirement

1. An ACPI OS is required. Currently, except Windows 95 and Windows NT, all other Windows Systems support ACPI.
2. The VIA 4 in 1 Driver must have been installed properly.

Procedures

1. Changed the following BIOS settings.

BIOS Setup > Power Management Setup > [ACPI Function](#): Enabled

BIOS Setup > Power Management Setup > [ACPI Suspend Type](#): S3.

2. Go to Control Panel > Power Management. Set "Power Buttons" to "Standby".
3. Press power button or standby button to wake up the system.

AWARD BIOS

System parameters can be modified by going into [BIOS](#) Setup menu, this menu allows you to configure the system parameters and save the configuration into the 128 bytes CMOS area, (normally in the RTC chip or in the main chipset).

The AwardBIOS™ that installed in the [Flash ROM](#) of the motherboard is a custom version of an industry standard BIOS. The BIOS provides critical low-level support for standard devices such as hard disk drives, serial and parallel ports.

Most BIOS setting of AK77-333 had been optimized by AOpen's R&D engineering team. But, the default setting of BIOS still can't fine-tune the chipset controlling the entire system. Hence, the rest of this chapter is intended to guide you through the process of configuring your system using setup procedures.

[To enter to BIOS setup menu](#), press when [POST \(Power-On Self Test\)](#) screen is shown on your monitor.

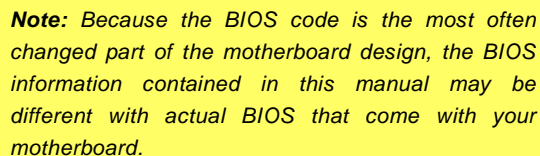

Note: *Because the BIOS code is the most often changed part of the motherboard design, the BIOS information contained in this manual may be different with actual BIOS that come with your motherboard.*

How To Use Award™ BIOS Setup Program

Generally, you can use the arrow keys to highlight items that you want to choose, then press <Enter> key to select, and use the <Page Up> and <Page Down> key to change setting value. You also can press <F1> key for help and press <Esc> key to quit Award™ BIOS setup program. The following table provides details about how to use keyboard in the Award™ BIOS setup program. By the way, all products of AOpen also provides a special function in the BIOS setup, you can press <F3> key selecting preferred menu language to display.

Key	Description
Page Up or +	Changing setting to next value or increase the value.
Page Down or -	Changing setting to previous value or decrease value.
Enter	Select the item.
Esc	<ol style="list-style-type: none"> In main menu: Quit and don't save any change. In sub menu: Exit current menu to main menu.
Up Arrow	Highlight previous item.
Down Arrow	Highlight next item.
Left Arrow	Move the light bar to left side of menu.
Right Arrow	Move the light bar to right side of menu.
F1	Get menu or item help description.
F3	Changing menu language.
F5	Load previous setting value from CMOS.

Key	Description
F6	Load fail-save setting value from CMOS.
F7	Load turbo setting value from CMOS.
F10	Save changed setting and exit setup program.

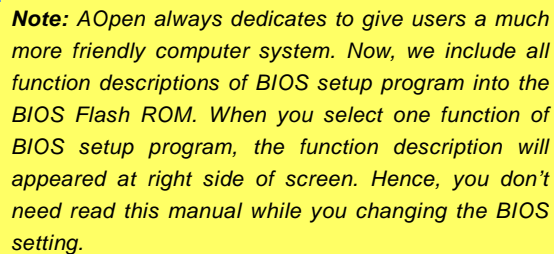

Note: AOpen always dedicates to give users a much more friendly computer system. Now, we include all function descriptions of BIOS setup program into the BIOS Flash ROM. When you select one function of BIOS setup program, the function description will appeared at right side of screen. Hence, you don't need read this manual while you changing the BIOS setting.

How To Enter BIOS Setup

After you finish the setting of jumpers and connect correct cables. Power on and enter the BIOS Setup, press during [POST \(Power-On Self Test\)](#). Choose "[Load Setup Defaults](#)" for recommended optimal performance.

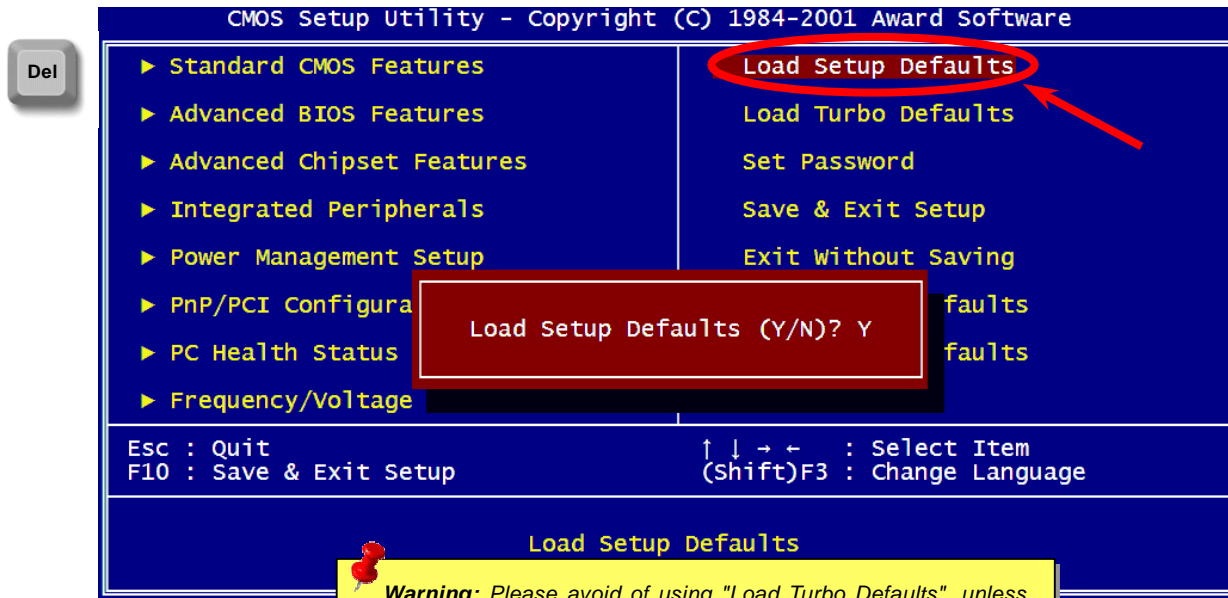



BIOS Upgrade under Windows environment

With outstanding R&D ability of AOpen, we now bring you a whole new BIOS Flash wizard ---- EZWinFlash. With an eye to users convenience, EZWinFlash combines the BIOS binary code and flash module together, so the only thing you have to do is just clicking on the utility you downloaded from web and let it helps you complete the flash process automatically. EZWinFlash detects your motherboard and checks the BIOS version cleverly to prevent your system from any possible failure. Moreover, EZWinFlash has been taken into consideration to go with any windows platform you might be using, no matter if you're using Windows 95/98, 98SE/ME, NT4.0/2000, or even the latest Windows XP.

In the meanwhile, in order to provide a much more user-friendly operating environment, AOpen EZWinFlash is natively designed to have multi-language function to provide easier way for users' usage in changing BIOS setting.

Caution: By updating your motherboard, you are taking a risk of BIOS flash failure. If your motherboard is working stable, and there are no major bugs that had been fixed by a latter BIOS revision, we recommend that you DO NOT try to upgrade your BIOS.

If you intent on upgrading, PLEASE BE SURE to get the right BIOS revision for the right motherboard model to avoid any possibility failure.

You may accomplish BIOS upgrade procedure with EZWinFlash by the following steps, and it's STRONGLY RECOMMENDED to close all the applications before you start the upgrading.

1. Download the new version of BIOS package zip file from AOpen official web site. (ex: <http://www.aopen.com>)
2. Unzip the download BIOS package (ex: WAK77333102.ZIP) with WinZip (<http://www.winzip.com>) in Windows environment.
3. Save the unzipped files into a folder, for example, WAK77333102.EXE & WAK77333102.BIN.
4. Double click on the WAK77333102.EXE, EZWinFlash will detect the model name and BIOS version of your motherboard. If you had got the wrong BIOS, you will not be allowed to proceed with the flash steps.
5. You may select preferred language in the main menu, then click [Start Flash] to start the BIOS upgrade procedure.
6. EZWinFlash will complete all the process automatically, and a dialogue box will pop up to ask you to restart Windows. You may click [YES] to reboot Windows.
7. Press at POST to [enter BIOS setup](#), choose "Load Setup Defaults", then "Save & Exit Setup". Done!

It is strongly recommended NOT to turn off the power or run any application during FLASH PROCESS.

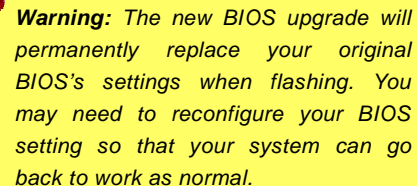

Warning: The new BIOS upgrade will permanently replace your original BIOS's settings when flashing. You may need to reconfigure your BIOS setting so that your system can go back to work as normal.

Overclocking

As a leading manufacturer in motherboard industry, AOpen always listens to what customers want and develop products to fit different user's requirements. Reliability, compatibility, leading technology and friendly features are our basic goals when designing motherboards. Other than above mentioned design criteria, there are power users who are always seeking to push the limitation of the system performance by overclocking who we call them "Overclocker".

This section is dedicated to overclockers.

This high performance motherboard is designed for maximum **133MHz** CPU bus clock. But it comes with clock generator of **248MHz** when we design it to accommodate future CPU bus clock. Our lab test results shown that **150MHz** is achievable when proper setting and qualified components were presented, we feel quite comfortable overclocking to **150MHz**. Not only that, this motherboard has full-range (CPU core voltage) settings and an option to adjust CPU core voltage. The CPU clock ratio can be up to 12.5x that supports almost all of Athlon / Duron CPUs in the future and provides flexibility for overclockers. For your reference, the following configurations are what we feel comfortable at **150MHz** bus clock.

But not guaranty. 😊

***Tip:** Note that overclocking may also cause thermal problem. Please make sure that the cooling fan and the heatsink were adequate to dissipate excessive heat that's generated by overclocking the CPU.*

***Warning:** The design of this product follows CPU and chipset vendor's design guideline. Any attempts to push beyond product specification are not recommended and you are taking your own risk to damage your system or important data. Before doing overclocking, you must make sure your components are able to tolerate such abnormal setting, especially CPU, SDRAM, hard disks, and AGP VGA cards.*

VGA Card & Hard Disk

VGA and HDD is key components for overclocking, for your reference, the following list are what have been successful overclocked in our lab. Please note that AOpen can not guaranty they can be successful overclocked again. Please check the **Available Vendor List (AVL)** by link to our official website.

VGA: <http://www.aopen.com.tw/tech/report/overclk/mb/vga-oc.htm>

HDD: <http://www.aopen.com.tw/tech/report/overclk/mb/hdd-oc.htm>

Glossary

AC97

Basically, AC97 specification separates sound/modem circuit to two parts, digital processor and a [CODEC](#) for analogy I/O they are linked by AC97 link bus. Since digital processor can be put into motherboard main chipset, the cost of sound/modem onboard solution can be reduced.

ACPI (Advanced Configuration & Power Interface)

ACPI is the power management specification of PC97 (1997). It intends to save more power by taking full control of power management to operating system and bypass [BIOS](#). The chipset or super I/O chip needs to provide standard register interface to operating system (such as Windows 98). This is a bit similar as the [PnP](#) register interface. ACPI defines ATX momentary soft power switch to control the power state transition.

AGP (Accelerated Graphic Port)

AGP is a bus interface targeted for high-performance 3D graphic. AGP supports only memory read/write operation and single-master single-slave one-to-one only. AGP uses both rising and falling edge of the 66MHz clock, for 2X AGP, the data transfer rate is $66\text{MHz} \times 4\text{byte} \times 2 = 528\text{MB/s}$. AGP is now moving to 4X mode, $66\text{MHz} \times 4\text{byte} \times 4 = 1056\text{MB/s}$. AOpen is the first company to support 4X AGP motherboards by both AX6C (Intel 820) and MX64/AX64 (VIA 694x), started from Oct 1999.

AMR (Audio/Modem Riser)

The [CODEC](#) circuit of AC97 sound/modem solution can be put on motherboard or put on a riser card (AMR card) that connects to motherboard through AMR connector.

AOpen Bonus Pack CD

A disc bundled with AOpen motherboard product, there are motherboard drivers, Acrobat Reader for [PDF](#) online manual and other useful utilities.

APM (Advanced Power Management)

Unlike [ACPI](#), BIOS controls most APM power management functions. AOpen Suspend to Hard Drive is a good example of APM power management.

ATA (AT Attachment)

ATA is the specification of diskette interface. In 80's, many software and hardware manufacturers instituted the ATA specification together. The AT is meaning International Business Machines Corporation (IBM) personal computer/AT's bus structure.

ATA/66

ATA/66 uses both rising edge and falling edge but doubles [UDMA/33](#) transfer rate. The data transfer rate is 4 times of the PIO mode 4 or DMA mode 2, 16.6MB/s x4 = 66MB/s. To use ATA/66, you need special ATA/66 IDE cable.

ATA/100

ATA/100 is a new IDE specification under developing. ATA/100 uses both rising edge and falling edge as [ATA/66](#) but clock cycle time is reduced to 40ns. The data transfer rate is $(1/40\text{ns}) \times 2 \text{ bytes} \times 2 = 100\text{MB/s}$. To use ATA/100, you need special 80-wire IDE cable, the same as ATA/66.

BIOS (Basic Input/Output System)

BIOS is a set of assembly routine/program that reside in [EPROM](#) or [Flash ROM](#). BIOS controls Input/output devices and other hardware devices of motherboard. In general, to provide hardware independent portability, operation system and drivers is required to access BIOS without directly access hardware devices.

Bus Master IDE (DMA mode)

The traditional PIO (Programmable I/O) IDE requires the CPU to involve in all the activities of the IDE access including waiting for the mechanical events. To reduce the workload of the CPU, the bus master IDE device transfers data from/to memory without interrupting CPU, and releases CPU to operate concurrently while data is transferring between memory and IDE device. You need the bus master IDE driver and the bus master IDE HDD to support bus master IDE mode.

CNR (Communication and Networking Riser)

The CNR specification provides the PC industry the opportunity to deliver a flexible and cost reduced method of implementing LAN, home networking, DSL, USB, wireless, audio and modem subsystems widely used in today's "connected PCs". The CNR specification is an open industry specification and is supported by OEMs, IHV card manufacturers, silicon supplier and Microsoft.

CODEC (Coding and Decoding)

Normally, CODEC means a circuit that can do digital to analog conversion and also the analog to digital conversion. It is part of [AC97](#) sound/modem solution.

DDR (Double Data Rate) SDRAM

DDR SDRAM utilizes the existing SDRAM infrastructure and technology while doubling the nominal bandwidth available to systems in an easy to design and simple to adopt way. Initially a perfect solution for memory intensive server and workstation applications, DDR low cost and low voltage will ultimately make it an ideal solution for all segments of the PC market, high performance desktop and mobile PCs, Value PCs and even Internet Appliances and mobile devices.

DIMM (Dual In Line Memory Module)

DIMM socket has total 168-pin and supports 64-bit data. It can be single or double side, the golden finger signals on each side of PCB are different, and that is why it was called Dual In Line. Almost all DIMMs are made by [SDRAM](#), which operate at 3.3V. Note that some old DIMMs are made by FPM/[EDO](#) and only operate at 5V. Do not confuse them with SDRAM DIMM which operates at 2.5V..

DMA (Direct Memory Access)

Channel for communications between the memory and surrounding devices.

ECC (Error Checking and Correction)

The ECC mode needs 8 ECC bits for 64-bit data. Each time memory is accessed; ECC bits are updated and checked by a special algorithm. The ECC algorithm has the ability to detect double-bit error and automatically correct single-bit error while parity mode can only detect single-bit error.

EDO (Extended Data Output) Memory

The EDO DRAM technology is actually very similar to FPM (Fast Page Mode). Unlike traditional FPM that tri-states the memory output data to start the pre-charge activity, EDO DRAM holds the memory data valid until the next memory access cycle, that is similar to pipeline effect and reduces one clock state.

EEPROM (Electronic Erasable Programmable ROM)

Also known as E²PROM. Both EEPROM and [Flash ROM](#) can be re-programmed by electronic signals, but the interface technology is different. Size of EEPROM is much smaller than flash ROM.

EPROM (Erasable Programmable ROM)

Traditional motherboard stores BIOS code in EPROM. EPROM can only be erased by ultra-violet (UV) light. If BIOS has to be upgraded, you need to remove EPROM from motherboard, clear by UV light, re-program, and then insert back.

EV6 Bus

EV6 Bus is the technology of Alpha processor from Digital Equipment Corporation. EV6 bus uses both rising and falling clock edge to transfer data, similar as DDR SDRAM or ATA/66 IDE bus.

EV6 Bus Speed = CPU external bus clock x 2.

For example, 200 MHz EV6 bus is actually using 100 MHz external bus clock, but the equivalent speed is 200 MHz.

FCC DoC (Declaration of Conformity)

The DoC is component certification standard of FCC EMI regulations. This standard allows DIY component (such as motherboard) to apply DoC label separately without a shielding of housing.

FC-PGA (Flip Chip-Pin Grid Array)

FC means Flip Chip, FC-PGA is a new package of Intel for Pentium III CPU. It can plug into SKT370 socket, but require motherboard to add some signals on socket 370. That is, the motherboard needs to be redesigned. Intel is going to ship FC-PGA 370 CPU and phase out slot1 CPU.

Flash ROM

Flash ROM can be re-programmed by electronic signals. It is easier for BIOS to upgrade by a flash utility, but it is also easier to be infected by virus. Because of increase of new functions, BIOS size is increased from 64KB to 256KB (2M bit). AOpen AX5T is the first board to implement 256KB (2Mbit) Flash ROM. Now flash ROM size is moving to 4M bit on AX6C (Intel 820) and MX3W (Intel 810) motherboard. , AOpen motherboard uses EEPROM for jumper-less and battery-less design.

FSB (Front Side Bus) Clock

FSB Clock means CPU external bus clock.

CPU internal clock = CPU FSB Clock x CPU Clock Ratio

I²C Bus

See [SMBus](#).

IEEE 1394

IEEE 1394 is a low-cost digital interface originated by Apple Computer as a desktop LAN and developed by the IEEE 1394 working group. The IEEE 1394 can transport data at 100, 200 or 400 Mbps. One of the solutions to connect digital television devices together at 200 Mbps. Serial Bus Management provides overall configuration control of the serial bus in the form of optimizing arbitration timing, guarantee of adequate electrical power for all devices on the bus, assignment of isochronous channel ID, and notification of errors. There are two type of IEEE 1394 data transfer: asynchronous and isochronous. Asynchronous transport is the traditional computer memory-mapped, load and store interface. Data requests are sent to a specific address and an acknowledgment is returned. In addition to an architecture that scales with silicon technology, IEEE 1394 features a unique isochronous data channel interface. Isochronous data channels provide guaranteed data transport at a pre-determined rate. This is especially important for time-critical multimedia data where just-in-time delivery eliminates the need for costly buffering.

Parity Bit

The parity mode uses 1 parity bit for each byte, normally it is even parity mode, that is, each time the memory data is updated, parity bit will be adjusted to have even count "1" for each byte. When next time, if memory is read with odd number of "1", the parity error is occurred and this is called single bit error detection.

PBSRAM (Pipelined Burst SRAM)

For Socket 7 CPU, one burst data read requires four QWord (Quad-word, $4 \times 16 = 64$ bits). PBSRAM only needs one address decoding time and automatically sends the remaining QWords to CPU according to a predefined sequence. Normally, it is 3-1-1-1, total 6 clocks, which is faster than asynchronous SRAM. PBSRAM is often used on L2 (level 2) cache of Socket 7 CPU. Slot 1 and Socket 370 CPU do not need PBSRAM.

PC-100 DIMM

[SDRAM](#) DIMM that supports 100MHz CPU [FSB](#) bus clock.

PC-133 DIMM

[SDRAM](#) DIMM that supports 133MHz CPU [FSB](#) bus clock.

PC-1600 or PC-2100 DDR SDRAM

Based on FSB frequency, the DDR SDRAM has 200MHz and 266MHz two type of working frequency. Because of DDR SDRAM data bus is 64-bit, it provides data transfer bandwidth up to $200 \times 64 / 8 = 1600 \text{MB/s}$, and $266 \times 64 / 8 = 2100 \text{MB/s}$. Hence, the PC-1600 DDR SDRAM is working with 100MHz and PC-2100 DDR SDRAM is working with 133MHz FSB frequency.

PCI (Peripheral Component Interface) Bus

Bus for the internal connection of peripheral devices, high-speed data channel between the computer and expansion card.

PDF Format

A file format for electronic document, PDF format is independent from platform, you can read PDF file under Windows, Unix, Linux, Mac ... with different PDF reader. You can also read PDF file by web browser such as IE and Netscape, note that you need to install PDF plug-in first (Included in Acrobat Reader).

PnP (Plug and Play)

The PnP specification suggests a standard register interface for both BIOS and operating system (such as Windows 95). These registers are used by BIOS and operating system to configure system resource and prevent any conflicts. PnP BIOS or operating system will automatically allocate the IRQ/DMA/Memory. Currently, almost all the PCI cards and most ISA cards are already PnP compliant.

POST (Power-On Self Test)

The BIOS self-test procedure after power-on, sometimes, it is the first or the second screen shown on your monitor during system boot.

RDRAM (Rambus DRAM)

Rambus is a memory technology that uses large burst mode data transfer. Theoretically, the data transfer should be high than [SDRAM](#). RDRAM is cascaded in channel operation. For Intel 820, only one RDRAM channel is supported, 16-bit data per channel, and this channel may have maximum 32 RDRAM devices, no matter how many [RIMM](#) sockets.

RIMM (Rambus Inline Memory Module)

184-pin memory module that supports [RDRAM](#) memory technology. A RIMM memory module may contain up to maximum of 16 RDRAM devices.

SDRAM (Synchronous DRAM)

SDRAM is one of the DRAM technologies that allow DRAM to use the same clock as the CPU host bus ([EDO](#) and FPM are asynchronous and do not have clock signal). It is similar as [PBSRAM](#) to use burst mode transfer. SDRAM comes in 64-bit 168-pin [DIMM](#) and operates at 3.3V. AOpen is the first company to support dual-SDRAM DIMMs onboard (AP5V), from Q1 1996

Shadow E²PROM

A memory space in Flash-ROM to simulate E²PROM operation, AOpen motherboard uses Shadow E²PROM for jumper-less and battery-less design

SIMM (Single In Line Memory Module)

SIMM socket is only 72-pin, and is only single side. The golden finger signals on each side of PCB are identical. That is why it was called Single In Line. SIMM is made by FPM or [EDO](#) DRAM and supports 32-bit data. SIMM had been phased out on current motherboard design.

SMBus (System Management Bus)

SMBus is also called I2C bus. It is a two-wire bus developed for component communication (especially for semiconductor IC). For example, set clock of clock generator for jumper-less motherboard. The data transfer rate of SMBus is only 100Kbit/s, it allows one host to communicate with CPU and many masters and slaves to send/receive message.

SPD (Serial Presence Detect)

SPD is a small ROM or [EEPROM](#) device resided on the [DIMM](#) or [RIMM](#). SPD stores memory module information such as DRAM timing and chip parameters. SPD can be used by [BIOS](#) to decide best timing for this DIMM or RIMM.

Ultra DMA

Ultra DMA (or, more accurately, Ultra DMA/33) is a protocol for transferring data between a hard disk drive through the computer's data path (or bus) to the computer's random access memory (RAM). The Ultra DMA/33 protocol transfers data in burst mode at a rate of 33.3MB/s, twice as fast as the previous [Direct Access Memory \(DMA\)](#) interface. Ultra DMA was developed as a proposed industry standard by the Quantum corporation, makes of hard disk drives, and Intel, makes of chipset that support computer bus technology. Ultra DMA support in your computer means that it will boot (start) and open new applications more quickly. It will help users of graphic-intensive and applications that require large amounts of access to data on the hard disk drive. Ultra DMA uses Cyclical Redundancy Checking (CRC), offering a new level of data protection. Ultra DMA uses the same 40-pin IDE interface cable as PIO and DMA.

16.6MB/s x2 = 33MB/s

16.6MB/s x4 = 66MB/s

16.6MB/s x6 = 100MB/s

USB (Universal Serial Bus)

USB is a 4-pin serial peripheral bus that is capable of cascading low/medium speed peripherals (less than 10Mbit/s) such as keyboard, mouse, joystick, scanner, printer and modem. With USB, the traditional complex cables from back panel of your PC can be eliminated.

VCM (Virtual Channel Memory)

NEC's Virtual Channel Memory (VCM) is a new DRAM core architecture that dramatically improves the memory system's ability to service multimedia requirements. VCM increases memory bus efficiency and performance of any DRAM technology by providing a set of fast static registers between the memory core and I/O pins. Using VCM technology results in reduced data access latency and reduced power consumption.

ZIP file

A compressed file format to reduce file size. To unzip file, run shareware PKUNZIP (<http://www.pkware.com/>) for DOS and other operating system or WINZIP (<http://www.winzip.com/>) for windows environment.



Troubleshooting

If you encounter any trouble to boot your system, follow the procedures accordingly to resolve the problem.

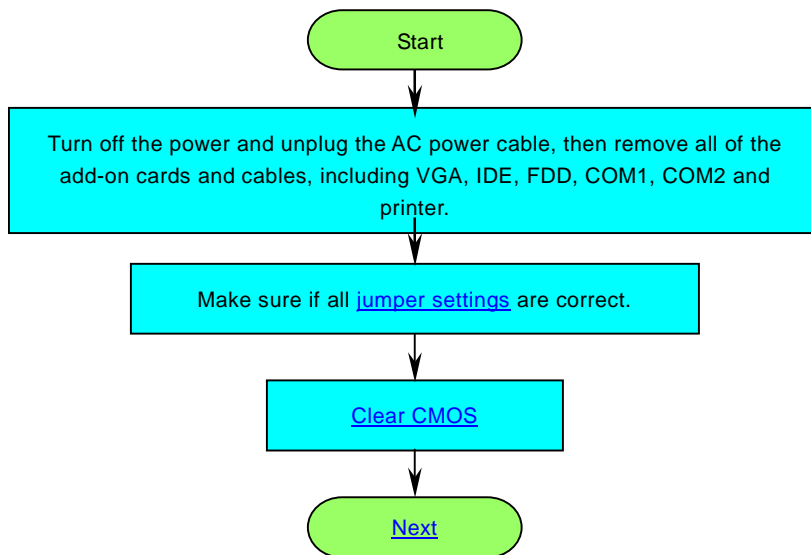

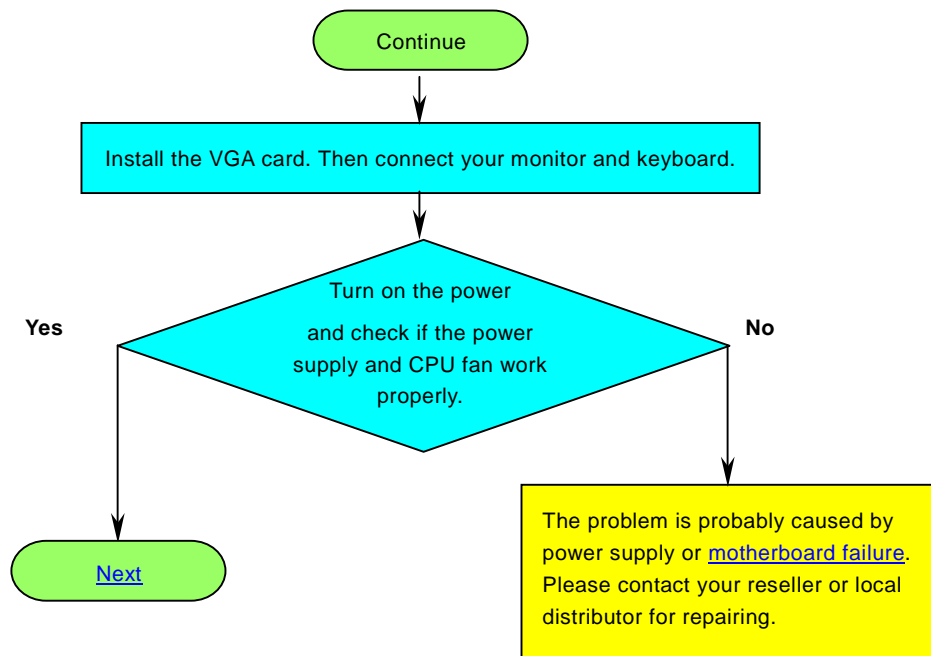

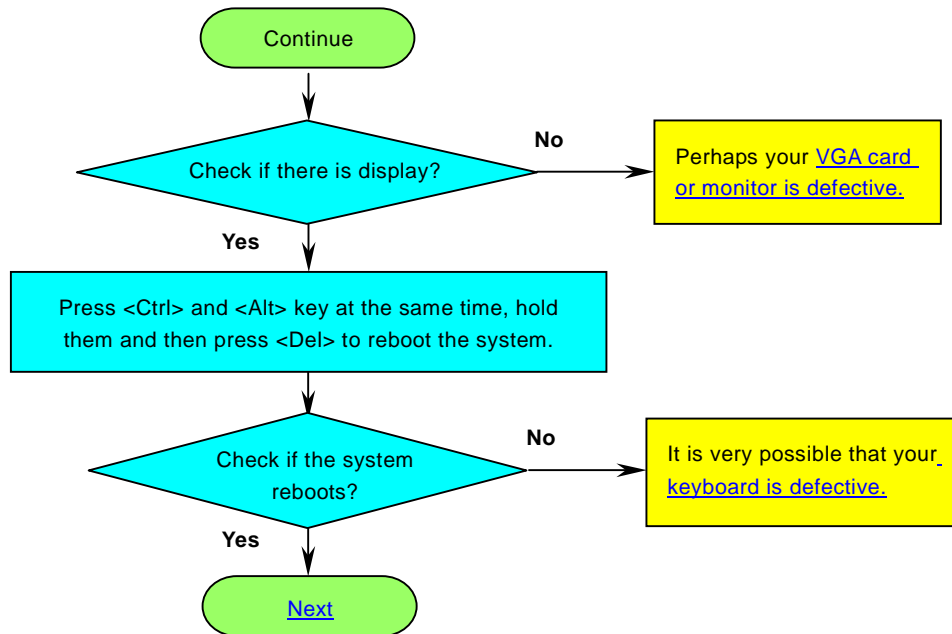

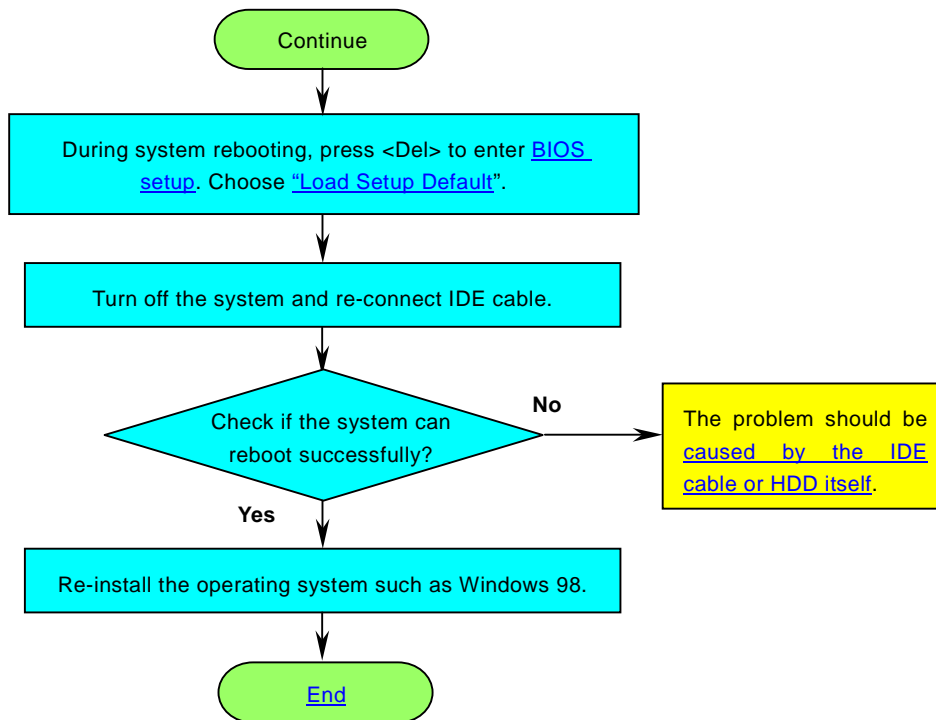



Technical Support

Dear Customer,

Thanks for choosing AOpen products. To provide the best and fastest service to our customer is our first priority. However, we receive numerous emails and phone-calls worldwide everyday, it is very hard for us to serve everyone on time. We recommend you follow the procedures below and seek help before contact us. With your help, we can then continue to provide the best quality service to more customers.

Thanks very much for your understanding!

AOpen Technical Supporting Team

1

Online Manual: Please check the manual carefully and make sure the jumper settings and installation procedure are correct.
<http://www.aopen.com/tech/download/manual/default.htm>

2

Test Report: We recommend choosing board/card/device from the compatibility test reports for assembling your PC.
<http://www.aopen.com/tech/report/default.htm>

3

FAQ: The latest FAQ (Frequently Asked Questions) may contain a solution to your problem.
<http://www.aopen.com/tech/faq/default.htm>

4

Download Software: Check out this table to get the latest updated BIOS/utility and drivers.
<http://www.aopen.com/tech/download/default.htm>

5

News Group: Your problem probably had been answered by our support engineer or professional users on the news group.

<http://www.aopen.com/tech/newsgrp/default.htm>

6

Contact Distributors/Resellers: We sell our products through resellers and integrators. They should know your system configuration very well and should be able to solve your problem more efficiently than us. After all, their attitude of service is an important reference for you if next time you want to buy something else from them.

7

Contact Us: Please prepare detail system configuration and error symptom before contacting us. The **part number**, **serial number** and **BIOS version** are also very helpful.

Part Number and Serial Number

The Part Number and Serial number are printed on bar code label. You can find this bar code label on the outside packing, on ISA/CPU slot or on component side of PCB. For example:



P/N: 91.88110.201 is part number, **S/N: 91949378KN73** is serial number.

Model name and BIOS version

Model name and BIOS version can be found on upper left corner of first boot screen ([POST](#) screen). For example:

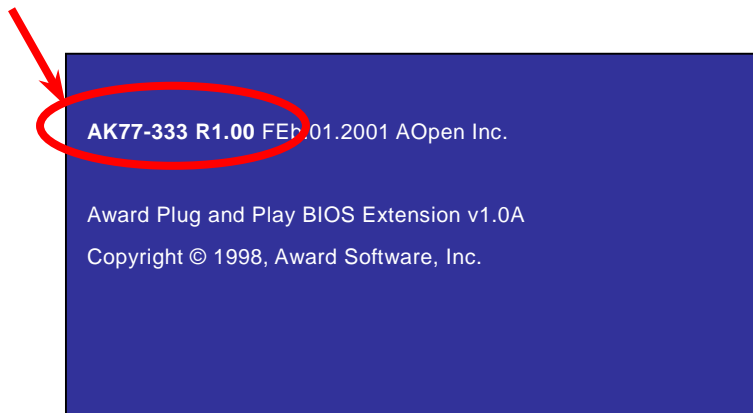

AK77-333 is model name of motherboard, **R1.00** is BIOS version.



Product Registration

ClubAOpen Welcome to AOpen Inc.



Thank you for choosing AOpen product. AOpen encourages you to spend few minutes in completing the following product registration. To register your product will ensure the high quality of services from AOpen. After the registration, you will:

- Have opportunities to play online slot machine and win a prize from AOpen by accumulating your bonuses for later prize exchange.
- Be upgraded to gold membership of Club AOpen program.
- Receive email notification about product safety alerts. Its purpose is to alert consumers quickly and conveniently when products contain technical issues.
- Receive email notification about latest product's announcements.
- Be able to personalize your AOpen web pages.
- Receive e-mail notification about latest BIOS/Driver/Software release information.
- Have opportunities to participate special product promotional programs.
- Enjoy higher service priority to receive technical assistance provided by AOpen specialists worldwide.
- Be able to join the discussions of web-based news groups.

AOpen makes sure that the information you provide is encrypted, so that it cannot be read or intercepted by other people or companies. Further, AOpen will not disclose any of information you submitted under any conditions. Please consult our [online privacy policy](#) for further information on our company policy.

Note: *If registering products purchased from different dealers/retails and/or purchased on different dates, please submit a separate form for each product.*





How to Contact Us



Please do not hesitate contact us if you have any problem about our products. Any opinion will be appreciated.

Pacific Rim
AOpen Inc.
Tel: 886-2-3789-5888
Fax: 886-2-3789-5899

Europe
AOpen Computer b.v.
Tel: 31-73-645-9516
Fax: 31-73-645-9604

America
AOpen America Inc.
Tel: 1-510-498-8928
Fax: 1-408-922-2935

China
艾尔鹏国际上海(股)有限公司
Tel: 86-21-6225-8622
Fax: 86-21-6225-7926

Germany
AOpen Computer GmbH.
Tel: 49-2102-157700
Fax: 49-2102-157799

Japan
AOpen Japan Inc.
Tel: 81-048-290-1800
Fax: 81-048-290-1820

Web Site: <http://www.aopen.com>

E-mail: Send us email by going through the contact form below.

English <http://www.aopen.com/tech/contact/techusa.htm>

Japanese <http://www.aopen.co.jp/tech/contact/techjp.htm>

Chinese <http://www.aopen.com.tw/tech/contact/techtw.htm>

German <http://www.aopencom.de/tech/contact/techde.htm>

French <http://france.aopen.com/tech/contact/techfr.htm>

Simplified Chinese <http://www.aopen.com.cn/tech/contact/techcn.htm>

