

AIMB-742

**Socket 478 Intel® Pentium®
4/Celeron® Industrial ATX
Motherboard with DDR/AGP/
Dual Gigabit LAN (400/533/
800 MHz FSB)**

User's Manual

Copyright Notice

This document is copyrighted, 2004, by Advantech Co., Ltd. All rights are reserved. Advantech Co., Ltd. reserves the right to make improvements to the products described in this manual at any time without notice. No part of this manual may be reproduced, copied, translated or transmitted in any form or by any means without the prior written permission of Advantech Co., Ltd. Information provided in this manual is intended to be accurate and reliable. However, Advantech Co., Ltd. assumes no responsibility for its use, nor for any infringements upon the rights of third parties which may result from its use.

Acknowledgements

- AWARD is a trademark of Phoenix Technologies Ltd.
- IBM and PC are trademarks of International Business Machines Corporation.
- Intel®, Pentium® 4, and Celeron™ are trademarks of Intel Corporation.
- WinBond is a trademark of Winbond Corporation.

All other product names or trademarks are the properties of their respective owners.

Part No. 2002074201	2nd. Edition
Printed in Taiwan	October 2004

1.0.1 A Message to the Customer

Advantech customer services

Each and every Advantech product is built to the most exacting specifications to ensure reliable performance in the harsh and demanding conditions typical of industrial environments. Whether your new Advantech equipment is destined for the laboratory or the factory floor, you can be assured that your product will provide the reliability and ease of operation for which the name Advantech has come to be known. Your satisfaction is our primary concern. Here is a guide to Advantech's customer services. To ensure you get the full benefit of our services, please follow the instructions below carefully.

Technical support

We want you to get the maximum performance from your products. So if you run into technical difficulties, we are here to help. For the most frequently asked questions, you can easily find answers in your product documentation. These answers are normally a lot more detailed than the ones we can give over the phone.

So please consult this manual first. If you still cannot find the answer, gather all the information or questions that apply to your problem, and with the product close at hand, call your dealer. Our dealers are well trained and ready to give you the support you need to get the most from your Advantech products. In fact, most problems reported are minor and are able to be easily solved over the phone.

In addition, free technical support is available from Advantech engineers every business day. We are always ready to give advice on application requirements or specific information on the installation and operation of any of our products

Table 1.1: AIMB-742 comparison table

Model	AIMB-742VE-00A1	AIMB-742E2-00A1	AIMB-742VG-00A1	AIMB-742G2-00A1	AIMB-742VE-LOA1	AIMB-742E2-LOA1
VGA: Intel 865G/865GV integrated	Yes (Intel 865G)	Yes (Intel 865G)	Yes (Intel 865G)	Yes (Intel 865G)	Yes (Intel 865GV)	Yes (Intel 865GV)
AGP Slot	Yes	Yes	Yes	Yes	No	No
LAN 1: Intel 82562EZ 10/100Base-T	Yes	Yes	No	No	Yes	Yes
LAN 1: Intel 82547GI 10/100/1000Base-T	No	No	Yes	Yes	No	No
LAN 2: Intel 82551QM 10/100Base-T	No	Yes	No	No	No	Yes
LAN 2: Intel 82541GI 10/100/1000Base-T	No	No	No	Yes	No	No

1.0.2 Product warranty

Advantech warrants to you, the original purchaser, that each of its products will be free from defects in materials and workmanship for two years from the date of purchase.

This warranty does not apply to any products which have been repaired or altered by persons other than repair personnel authorized by Advantech, or which have been subject to misuse, abuse, accident or improper installation. Advantech assumes no liability under the terms of this warranty as a consequence of such events.

If an Advantech product is defective, it will be repaired or replaced at no charge during the warranty period. For out-of-warranty repairs, you will be billed according to the cost of replacement materials, service time and freight. Please consult your dealer for more details.

If you think you have a defective product, follow these steps:

- Step 1. Collect all the information about the problem encountered. (For example, type of PC, CPU speed, Advantech products used, other hardware and software used, etc.) Note anything abnormal and list any on-screen messages you get when the problem occurs.
- Step 2. Call your dealer and describe the problem. Please have your manual, product, and any helpful information readily available.
- Step 3. If your product is diagnosed as defective, obtain an RMA (return material authorization) number from your dealer. This allows us to process your return more quickly.
- Step 4. Carefully pack the defective product, a fully-completed Repair and Replacement Order Card and a photocopy proof of purchase date (such as your sales receipt) in a shippable container. A product returned without proof of the purchase date is not eligible for warranty service.
- Step 5. Write the RMA number visibly on the outside of the package and ship it prepaid to your dealer.

1.0.3 Initial Inspection

Before you begin installing your motherboard, please make sure that the following materials have been shipped:

- AIMB-742 Pentium ® 4/Celeron™ processor-based industrial mother board
- 1 AIMB-742 Startup Manual
- 1 CD with driver utility and manual (in PDF format)
- 1 FDD cable P/N: 1700340640
- 2 Ultra ATA 66/100 HDD cables P/N: 1701400452
- 2 Serial ATA HDD data cable P/N: 1700071000
- 2 Serial ATA HDD power cable P/N: 1703150102
- 1 ATX 12V power converter cable P/N: 170304015K
- 1 COM port cable kit P/N: 1701090401
- 1 I/O port bracket P/N: 1962015680
- 1 Two USB ports ext kit (optional) P/N: 1700100170

If any of these items are missing or damaged, contact your distributor or sales representative immediately.

We have carefully inspected the AIMB-742 mechanically and electrically before shipment. It should be free of marks and scratches and in perfect working order upon receipt.

As you unpack the AIMB-742, check it for signs of shipping damage. (For example, damaged box, scratches, dents, etc.) If it is damaged or it fails to meet the specifications, notify our service department or your local sales representative immediately. Also notify the carrier. Retain the shipping carton and packing material for inspection by the carrier. After inspection, we will make arrangements to repair or replace the unit.

1.0.4 Release Note

Date	Revision	Change
March 2004	1st. Edition	Initial Release
October 2004	2nd. Edition	Removed riser card Added DDR module table. Added AIMB-742VE-L0A1 and AIMB-742E2-L0A1 model.

Contents

Chapter 1	Hardware Configuration	2
1.1	Introduction	2
1.2	Features	3
1.3	Specifications	3
1.3.1	System.....	3
1.3.2	Memory.....	4
1.3.3	Input/Output.....	4
1.3.4	VGA interface.....	4
1.3.5	Ethernet LAN.....	4
1.3.6	Industrial features	5
1.3.7	Mechanical and environmental specifications.....	5
1.4	Jumpers and Connectors.....	5
	Table 1.1: Jumpers.....	5
	Table 1.2: Connectors.....	6
1.5	Board Layout: Jumper and Connector Locations.....	8
	Figure 1.1: Jumper and Connector locations	8
	Figure 1.2: I/O Connectors	8
1.6	AIMB-742 Block Diagram.....	9
	Figure 1.3: AIMB-742 Block Diagram.....	9
1.7	Safety Precautions	10
1.8	Jumper Settings	11
1.8.1	How to set jumpers	11
1.8.2	CMOS clear (J1).....	11
	Table 1.3: CMOS (J1).....	11
1.8.3	Watchdog timer output (J2)	12
	Table 1.4: Watchdog timer output (J2).....	12
1.9	System Memory	12
1.9.1	CPU FSB and memory speed	13
	Table 1.5: CPU FSB and memory speed.....	13
1.9.2	Dual channel configuration.....	13
1.10	Memory Installation Procedures	14
1.11	Cache Memory	14
1.12	Processor Installation	14
Chapter 2	Connecting Peripherals	16
2.1	Introduction	16
2.2	Primary (CN1) and Secondary (CN2) IDE Connectors..	16
2.3	Floppy Drive Connector (CN3).....	17
2.4	Parallel Port (CN4).....	17
2.5	USB Ports (CN6/CN63).....	18
2.6	VGA Connector (CN7)	18

2.7	Serial Ports (COM1 : CN9; COM2 : CN10)	19
2.8	PS/2 Keyboard and Mouse Conn (CN11)	19
2.9	External Keyboard Connector (CN12)	20
2.10	CPU Fan Connector (CN14)	20
2.11	System FAN connector (CN15 and CN37)	20
2.12	Front Panel Connectors (CN16, 17, 18, 19, 21&29)	21
	2.12.1 Power LED and Keyboard Lock (CN16)	21
	2.12.2 External speaker (CN17)	21
	2.12.3 Reset (CN18)	21
	2.12.4 HDD LED (CN19)	22
	2.12.5 ATX soft power switch (CN21)	22
	2.12.6 SM Bus Connector (CN29)	22
2.13	H/W Monitor Alarm (CN22)	22
2.14	USB and LAN ports (CN31 and CN32)	23
2.15	CF socket (CN44) (Option)	23
2.16	Line Out, Mic IN connector (CN55)	24
2.17	Audio input from CD-ROM (CD IN; CN56)	24
2.18	Aux Line-In connector (AUX IN; CN57)	24
2.19	Modem-In connector (MDM IN; CN58)	25
2.20	Front Panel audio connector (FP AUDIO; CN59)	25
2.21	8-pin Alarm Board Connector (CN62)	25
2.22	Case Open Connector (CN64)	26
2.23	Serial ATA interface (SA0 and SA1)	26
2.24	Connecting to SNMP-1000 remote manager	27
2.25	Auxiliary 4-pin power connector (ATX1)	27

Chapter 3 Award BIOS Setup.....30

3.1	Introduction	30
	3.1.1 CMOS RAM Auto-backup and Restore	30
3.2	Entering Setup	31
	Figure 3.1: Award BIOS Setup initial screen	31
3.3	Standard CMOS Setup	31
	Figure 3.2: Standard CMOS features screen	31
3.4	Advanced BIOS Features	32
	Figure 3.3: Advanced BIOS features screen	32
3.4.1	Hard Disk Boot Priority	32
3.4.2	Virus Warning	32
3.4.3	CPU L1 & L2 Cache	32
3.4.4	Hyper-Threading Technology	32
3.4.5	Quick Power On Self Test	33
3.4.6	First/Second/Third Boot Device	33
3.4.7	Boot Other Device	33
3.4.8	Swap Floppy Drive	33
3.4.9	Boot UP Floppy Seek	33

3.4.10	Boot Up NumLock Status.....	33
3.4.11	Gate A20 Option.....	33
3.4.12	Typematic Rate Setting.....	33
3.4.13	Typematic Rate (Chars/Sec).....	33
3.4.14	Typematic Delay (msec).....	33
3.4.15	Security Option.....	34
3.4.16	APIC Mode.....	34
3.4.17	MPS Version Control For OS.....	34
3.4.18	OS Select For DRAM > 64MB.....	34
3.5	Advanced Chipset Features.....	34
3.5.1	DRAM Timing Selectable.....	35
3.5.2	CAS Latency Time.....	35
3.5.3	Active to Precharge Delay.....	35
3.5.4	DRAM RAS# to CAS# Delay.....	35
3.5.5	DRAM RAS# Precharge.....	35
3.5.6	Memory Frequency.....	35
	Figure 3.4:Advanced chipset features screen.....	35
3.5.7	System BIOS Cacheable.....	36
3.5.8	Video Bios Cacheable.....	36
3.5.9	Memory Hole At 15M-16M.....	36
3.5.10	Delay Prior to Thermal.....	36
3.5.11	AGP Aperture Size (MB).....	36
3.5.12	Init Display First.....	36
3.5.13	On-Chip VGA.....	36
3.5.14	On-Chip Frame Buffer Size.....	36
3.6	Integrated Peripherals.....	37
	Figure 3.5:Integrated peripherals.....	37
	Figure 3.6:On-Chip IDE Device.....	37
3.6.1	IDE HDD Block Mode.....	38
3.6.2	On-Chip IDE Device.....	38
3.6.3	On-Chip Serial ATA.....	38
3.6.4	Serial ATA Port0/Port1 Mode.....	38
	Figure 3.7:Onboard Device.....	38
3.6.5	USB Controller.....	39
3.6.6	USB 2.0 Controller.....	39
3.6.7	USB Keyboard/Mouse Support.....	39
3.6.8	AC97 Audio.....	39
3.6.9	Onboard LAN1 Control.....	39
3.6.10	Onboard LAN2 Control.....	39
3.6.11	Onboard LAN Boot ROM.....	39
	Figure 3.8:SuperIO Device.....	39
3.6.12	Onboard FDC Controller.....	40
3.6.13	Onboard Serial Port 1.....	40
3.6.14	Onboard Serial Port 2.....	40
3.6.15	UART Mode Select.....	40

3.6.16	RxD, TxD Active.....	40
3.6.17	IR Transmission Delay	40
3.6.18	UR2 Duplex Mode.....	40
3.6.19	Use IR Pins	40
3.6.20	Onboard Parallel Port.....	40
3.6.21	Parallel Port Mode	40
3.6.22	EPP Mode Select	41
3.6.23	ECP Mode Use DMA	41
3.6.24	PWRON After PWR-Fail	41
3.7	Power Management Setup.....	41
	Figure 3.9:Power management setup screen (1).....	41
3.7.1	ACPI function	42
3.7.2	ACPI Suspend Type.....	42
3.7.3	Power Management	42
3.7.4	Video Off Method.....	42
3.7.5	Video Off In Suspend	42
3.7.6	Suspend Type.....	42
3.7.7	Modem Use IRQ.....	42
3.7.8	Soft-Off by PWR-BTTN	42
3.7.9	CPU THRM-Throttling.....	43
3.7.10	Resume on LAN/PCI PME#.....	43
3.7.11	Resume on Ring.....	43
3.7.12	Resume on Alarm	43
3.7.13	Primary IDE 0 (1) and Secondary IDE 0 (1)	43
3.7.14	FDD, COM, LPT PORT	43
3.7.15	PCI PIRQ [A-D]#	44
3.8	PnP/PCI Configurations	44
	Figure 3.10:PnP/PCI configurations screen.....	44
3.8.1	Reset Configuration Data.....	44
3.8.2	Resources Controlled By	44
3.8.3	PCI/VGA Palette Snoop	44
3.9	PC Health Status.....	44
3.9.1	CPU Warning Temperature	44
	Figure 3.11:PC health status screen.....	45
3.9.2	Current System Temp	45
3.9.3	Current CPU Temperature.....	45
3.9.4	Current CPUFAN Speed.....	45
3.9.5	VCORE, +1.5V, VCC3, +5V, +12V, -12V, -5V, VBAT(V), 5VSB(V).....	45
3.10	Spread Spectrum Control	46
	Figure 3.12:Spread Spectrum Control screen	46
3.10.1	CPU Clock Ratio	46
3.10.2	Spread Spectrum.....	46
3.11	Password Setting	46
3.12	Save & Exit Setup	47

	3.13	Exit Without Saving.....	47
Chapter	4	Chipset Software Install Utility.....	50
	4.1	Before you begin	50
	4.2	Introduction	50
	4.3	Windows XP Driver Setup.....	51
Chapter	5	VGA Setup	56
	5.1	Introduction	56
	5.2	Dynamic Video Memory Technology.....	56
	5.3	Windows XP Driver Setup.....	57
Chapter	6	LAN Configuration	62
	6.1	Introduction	62
	6.2	Features	62
	6.3	Installation.....	63
	6.4	Win XP Driver Setup (Intel 82547/41/62/51).....	63
Chapter	7	Onboard Security Setup	68
	7.1	Introduction	68
	7.2	Windows XP Driver Setup.....	69
	7.3	Using the OBS Hardware Doctor Utility	72
Appendix A		Programming the watchdog timer.....	76
	A.1	Programming the Watchdog Timer.....	76
	A.1.1	Watchdog timer overview.....	76
	A.1.2	Reset/ Interrupt selection	76
	A.1.3	Programming the Watchdog Timer	76
	A.1.4	Example Program	79
Appendix B		Pin Assignments	86
	B.1	IDE Hard Drive Connector (CN1, CN2).....	86
		Table B.1:IDE hard drive connector (CN1, CN2).....	86
	B.2	Floppy Drive Connector (CN3).....	87
		Table B.2:Floppy drive connector (CN3).....	87
	B.3	Parallel Port Connector (CN4)	88
		Table B.3:Parallel port connector (CN4).....	88
	B.4	USB Connector (CN6 and CN63)	89
		Table B.4:USB1/USB2 connector (CN6 and CN63)....	89
	B.5	VGA Connector (CN7)	89
		Table B.5:VGA connector (CN7).....	89
	B.6	COM1/COM2 RS-232 Serial Port (CN9, CN10).....	90
		Table B.6:COM1/2 RS-232 serial port (CN9/10).....	90
	B.7	Keyboard and Mouse Connector (CN11).....	90
		Table B.7:Keyboard and mouse connector (CN11).....	91
	B.8	External Keyboard Connector (CN12).....	91
		Table B.8:External keyboard connector (CN12).....	91

B.9	CPU/System Fan Power Conn (CN14/15/37).....	92
	Table B.9:CPU/System Fan Power Conn (CN14/15/37).....	92
B.10	Power LED (CN16).....	92
	Table B.10: Power LED and keylock conn (CN16).....	92
B.11	External Speaker Connector (CN17).....	93
	Table B.11:External Speaker Connector (CN17).....	93
B.12	Reset Connector (CN18).....	93
	Table B.12:Reset connector (CN18).....	93
B.13	HDD LED Connector (CN19).....	94
	Table B.13:HDD LED connector (CN19).....	94
B.14	ATX Soft Power Switch (CN21).....	94
	Table B.14:ATX soft power switch (CN21).....	94
B.15	H/W Monitor Alarm (CN22).....	95
	Table B.15:H/W monitor alarm (CN22).....	95
B.16	SM Bus Connector (CN29).....	95
	Table B.16:SM Bus Connector (CN 29).....	95
B.17	USB/LAN ports (CN31 and CN32).....	95
	Table B.17:USB port.....	95
	Table B.18:Ethernet 10/100Base-T RJ-45 port.....	96
B.18	CF socket (CN44).....	96
	Table B.19:CF socket (CN44).....	96
B.19	Line Out, Mic IN connector (CN55).....	97
B.20	Audio input from CD-ROM (CD IN; CN56).....	97
	Table B.20:Audio in from CD-ROM (CD IN; CN56)..	97
B.21	Aux Line-In connector (AUX IN; CN57).....	98
	Table B.21:Aux Line-In connector (AUX IN; CN57)..	98
B.22	Modem-In connector (MDM IN; CN58).....	98
	Table B.22:Modem-In connector (MDM IN; CN58)...	98
B.23	Front Panel audio connector (FP AUDIO; CN59).....	99
	Table B.23:Front audio conn (FP AUDIO; CN59).....	99
B.24	Case Open Connector (CN64).....	99
	Table B.24:Case Open Connector (CN64).....	99
B.25	8-pin Alarm Board Connector (CN62).....	100
	Table B.25:8-pin Alarm Board Connector (CN62)....	100
B.26	System I/O Ports.....	100
	Table B.26:System I/O ports.....	100
B.27	DMA Channel Assignments.....	101
	Table B.27:DMA channel assignments.....	101
B.28	Interrupt Assignments.....	102
	Table B.28:Interrupt assignments.....	102
B.29	1st MB Memory Map.....	102
	Table B.29:1st MB memory map.....	102
B.30	PCI Bus Map.....	103

Table B.30:PCI bus map (for VE, E2 version)	103
Table B.31:PCI bus map (for VG, G2 version)	103

CHAPTER

1

General Information

Chapter 1 Hardware Configuration

1.1 Introduction

Advantech's AIMB-742 series industrial motherboard is designed based on the standard ATX form factor with additional industrial features such as long product life, high reliability and manageability. It is flexible to be installed in a commercial PC chassis or in an industrial grade rack mounting chassis. It meets the requirements of a variety of applications where a commercial motherboard cannot fit.

The AIMB-742 uses Intel's 865G/865GV chipset to support Intel's Socket 478 Pentium 4 and Celeron processor with 800/533/400 MHz front side bus. The dual channel DDR 400 SDRAM interface provides bottleneck free memory bandwidth up to 6.4GB/s. In addition to the two EIDE interfaces (up to four devices), it features a high performance serial ATA interface (up to 150MB/s) which eases cabling to hard drives in industrial chassis with thin and long cables. Other features include chipset built-in high performance VGA interface, dual Giga-bit Ethernet ports, eight USB 2.0 ports (up to 480 Mbps), and other standard PC functions like two RS-232 serial ports, one enhanced parallel port and floppy disk interface.

A backup of CMOS data is stored in the Flash memory, which protects BIOS setup data even after a battery failure. Also included is a 255-level watchdog timer, which resets the CPU or generates an interrupt if a program cannot be executed normally. This enables reliable operation in unattended environments.

The remote management interface enables the AIMB-742 to be managed through Ethernet when it is connected to the SNMP-1000 Remote HTTP/SNMP System Manager.

Note: Some of the features mentioned above are not available with all models. For more information about the specifications of a particular model, see Table 1.1 : Comparison table and Section 1.3: Specifications.

1.2 Features

1. **Standard ATX form factor with industrial features:** AIMB-742 provides industrial features like long product life, reliable operation under wide temperature range, watchdog timer, CMOS backup functions, etc.
2. **PCI and ISA bus support:** in addition to the 5 PCI slots, AIMB-742 provides 2 ISA slots, allowing existing ISA legacy devices to be used in modern high performance computing system.
3. **Healthy status monitoring and remote management:** System voltage levels, fan speed, CPU temperature are monitored to ensure stable operation. The remote management interface allows the system to be managed through Ethernet when it is connected to the SNMP-1000 Remote HTTP/SNMP System Manager.
4. **BIOS CMOS backup and restore:** When BIOS CMOS setup has been completed, data in the CMOS RAM is automatically backed up to the Flash ROM. This is particularly useful in harsh environments which may cause setup data loss such as battery failure. Upon such an error occurring, BIOS will check the data, and automatically restore the original data for booting.
5. **Automatically power on after power failure:** It is often required to have an unattended system come back to operation when power resumes after a power failure. Advantech's industrial motherboard allows users to set the system to power on automatically without pushing the power on button.

1.3 Specifications

1.3.1 System

- **CPU:** Intel® socket 478 Celeron® (Northwood) 2.0~2.8 GHz, Celeron-D 2.4~2.8 GHz, Pentium® 4 (Northwood) up to 3.4 GHz, FSB 400/533/800 MHz; supports Intel Hyper-Threading technology. Does not support CPU with 1.75V core voltage (Willamete).
- **L2 Cache:** CPU built-in 128/256/512/1024 KB full-speed L2 cache
- **BIOS:** Award Flash BIOS (4Mb Flash Memory)
- **System Chipset:** Intel 865G/865GV with ICH5
- **SATA/EIDE hard disk drive interface:** Supports up to two independent serial ATA hard drives (up to 150MB/s) and two IDE hard disk

drives or four enhanced IDE devices. Supports PIO mode 4 (16.67MB/s data transfer rate) and ATA 33/66/100 (33/66/100MB/s data transfer rate.) BIOS enabled/disabled.

- **Floppy disk drive interface:** Supports up to two floppy disk drives, 5¼" (360 KB and 1.2 MB) and/or 3½" (720 KB, 1.44 MB). BIOS enabled/disabled

1.3.2 Memory

- **RAM:** Up to 4GB in four 184-pin DIMM sockets. Supports dual channel DDR266/333/400 SDRAM

1.3.3 Input/Output

- **PCI Bus:** 5 PCI slots, 32-bit, 33MHz. PCI 2.2 compliant
- **EISA Bus:** 2 slots with PCI-to-ISA controller IT8888
- **Enhanced parallel port:** Configured to LPT1, LPT2, LPT3, or disabled. Standard DB-25 female connector provided. Supports EPP/SPP/ECP
- **Serial ports:** Two RS-232 ports with 16C550 UARTs (or compatible) with 16-byte FIFO buffer. Supports speeds up to 115.2 Kbps. Ports can be individually configured to COM1, COM2 or disabled
- **Keyboard and PS/2 mouse connector:** Two 6-pin mini-DIN connectors are located on the mounting bracket for easy connection to a keyboard and PS/2 mouse.
- **USB port:** Supports up to eight USB 2.0 and transmission rate up to 480Mbps.

1.3.4 VGA interface

- **Controller:** Intel 865G/865GV chipset integrated
- **Display memory:** Share system memory up to 64 MB, BIOS selectable
- **Resolution:** up to 1800x1440 @ 85Hz

1.3.5 Ethernet LAN

- Supports single/dual 10/100Base-T networking or single/dual 10/100/1000Base-T Ethernet networking
- **Controller:**
 - Single 10/100Base-T: Intel 82562EZ
 - Single 10/100/1000Base-T: Intel 82547GI (CSA)
 - Dual 10/100/1000Base-T: Intel 82562EZ and Intel 82551QM

Dual 10/100/1000Base-T: Intel 82547GI (CSA) and Intel 82541GI (PCI)

1.3.6 Industrial features

- **Watchdog timer:** Can generate a system reset or IRQ11. The watchdog timer is programmable, with each unit equal to one second or one minute (255 levels)

1.3.7 Mechanical and environmental specifications

- **Operating temperature:** 0°~60° C (32° ~ 140° F, Depending on CPU)
- **Storage temperature:** -20°~ 70° C (-4° ~ 158° F)
- **Humidity:** 20 ~ 95% non-condensing
- **Power supply voltage:** +5 V, ±12 V
- **Power consumption:** Typical : +3.3V:4.23A, +5V:1.35A , +12V:4.17A (Intel Pentium® 4 2.4GHz, 512MB DDR 333)
- **Board size:** 304.8 x 228.6 mm (12" x 9")
- **Board weight:** 0.7 kg (1.68 lb)

1.4 Jumpers and Connectors

Connectors on the AIMB-742 motherboard link it to external devices such as hard disk drives and a keyboard. In addition, the board has a number of jumpers used to configure your system for your application.

The tables below list the function of each of the board jumpers and connectors. Later sections in this chapter give instructions on setting jumpers. Chapter 2 gives instructions for connecting external devices to your motherboard.

Label	Function
J1	CMOS Clear
J2	Watchdog timer output selection

Table 1.2: Connectors	
Label	Function
CN1	Primary IDE connector
CN2	Secondary IDE connector
CN3	Floppy drive connector
CN4	Parallel port
CN6	USB port 4, 5
CN7	VGA connector
CN9	Serial port: COM1
CN10	Serial port: COM2
CN11	PS/2 keyboard and mouse connector
CN12	External keyboard connector
CN14	CPU FAN connector
CN15	System FAN connector 1
CN16	Power LED and Keyboard Lock
CN17	External speaker
CN18	Reset connector
CN19	HDD LED connector
CN21	ATX soft power switch (PS_ON)
CN22	HW Monitor Alarm Close: Enable OBS Alarm Open: Disable OBS Alarm
CN29	SM BUS Connector PIN1: SMB_DATA PIN2: SMB_CLOCK
CN31	USB port 0, 1 & LAN1
CN32	USB port 2, 3 & LAN2
CN37	System FAN connector 2
CN44	CF socket (Optional), Master mode only
CN55	Line Out, Mic IN connector
CN56	CD IN (Audio input from CD-ROM)
CN57	AUX IN connector
CN58	MDM IN connector

CN59	FP AUDIO connector
CN62	8-pin Alarm Board Connector
CN63	USB port 6, 7
CN64	Case Open
SA0	Serial ATA 0
SA1	Serial ATA 1
ATX1	ATX 12V Auxiliary power connector
ATX2	ATX power connector

1.5 Board Layout: Jumper and Connector Locations

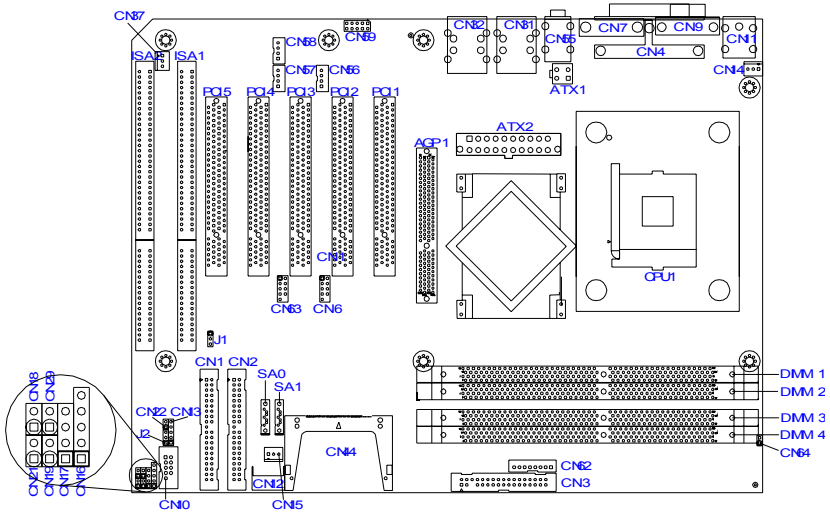

Figure 1.1: Jumper and Connector locations

Note: AIMB-742VE-L0A1 and AIMB-742E2-L0A1 do not support AGP slot.

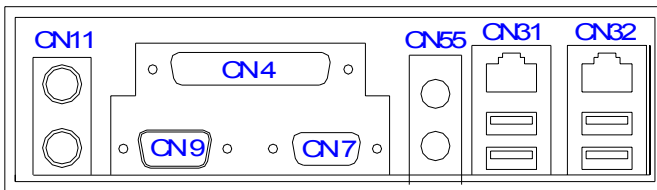

Figure 1.2: I/O Connectors

1.6 AIMB-742 Block Diagram

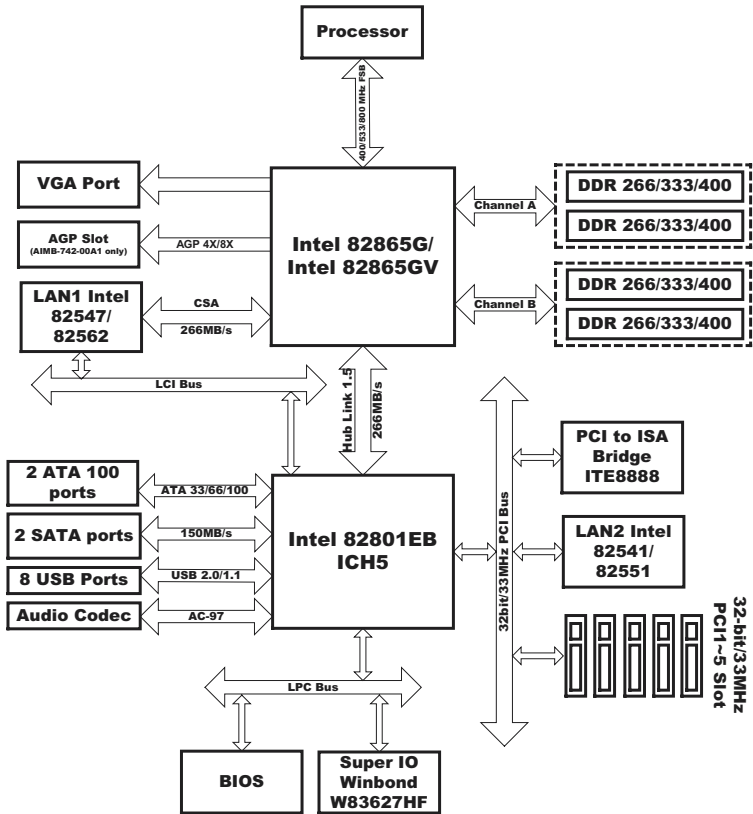

Figure 1.3: AIMB-742 Block Diagram

1.7 Safety Precautions

Warning! Always completely disconnect the power cord from your chassis whenever you work with the hardware. Do not make connections while the power is on. Sensitive electronic components can be damaged by sudden power surges. Only experienced electronics personnel should open the PC chassis.

Caution! Always ground yourself to remove any static charge before touching the motherboard. Modern electronic devices are very sensitive to static electric charges. As a safety precaution, use a grounding wrist strap at all times. Place all electronic components on a static-dissipative surface or in a static-shielded bag when they are not in the chassis.

Caution! The computer is provided with a battery-powered Real-time Clock circuit. There is a danger of explosion if battery is incorrectly replaced. Replace only with same or equivalent type recommended by the manufacturer. Discard used batteries according to manufacturer's instructions.

FCC This device complies with the requirements in part 15 of the FCC rule.F

Operation is subject to be following two conditions.F

1.) This device may not cause harmful interference, and

2.) This device must accept any interference received,

including interference that may cause undesired operation.

*Caution! Danger of explosion if battery is incorrectly replaced.
The battery need not to be charged.
Replace only with Advantech-specified batteries.*

1.8 Jumper Settings

This section provides instructions on how to configure your motherboard by setting the jumpers. It also includes the motherboard's default settings and your options for each jumper.

1.8.1 How to set jumpers

You can configure your motherboard to match the needs of your application by setting the jumpers. A jumper is a metal bridge that closes an electrical circuit. It consists of two metal pins and a small metal clip (often protected by a plastic cover) that slides over the pins to connect them. To “close” (or turn ON) a jumper, you connect the pins with the clip. To “open” (or turn OFF) a jumper, you remove the clip. Sometimes a jumper consists of a set of three pins, labeled 1, 2, and 3. In this case you connect either pins 1 and 2, or 2 and 3. A pair of needle-nose pliers may be useful when setting jumpers.

1.8.2 CMOS clear (J1)

The AIMB-742 motherboard contains a jumper that can erase CMOS data and reset the system BIOS information. Normally this jumper should be set with pins 1-2 closed. If you want to reset the CMOS data, set J1 to 2-3 closed for just a few seconds, and then move the jumper back to 1-2 closed. This procedure will reset the CMOS to its default setting.

Table 1.3: CMOS (J1)

Function	Jumper Setting
* Keep CMOS data	 1-2 closed

Table 1.3: CMOS (J1)

Clear CMOS data

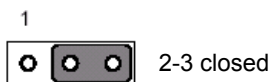

* default setting

1.8.3 Watchdog timer output (J2)

The AIMB-742 contains a watchdog timer that will reset the CPU or send a signal to IRQ11 in the event the CPU stops processing. This feature means the AIMB-742 will recover from a software failure or an EMI problem. The J2 jumper settings control the outcome of what the computer will do in the event the watchdog timer is tripped.

Table 1.4: Watchdog timer output (J2)

Function

Jumper Setting

IRQ11

1



1-2 closed

* Reset

1



2-3 closed

* default setting

Note: The interrupt output of the watchdog timer is a low level signal. It will be held low until the watchdog timer is reset.

1.9 System Memory

The AIMB-742 has four sockets for 184-pin dual inline memory modules (DIMMs) in two separated memory channels. It can operate with single channel or dual channel modules. We recommend to use dual channel mode to provide optimized performance.

All these sockets use 2.5 V unbuffered double data rate synchronous DRAMs (DDR SDRAM). They are available in capacities of 128, 256,

512 and 1024 MB. The sockets can be filled in any combination with DIMMs of any size, giving a total memory size between 128 MB and 4 GB.

Note: System resources such as PCI and AGP cards require physical memory address locations that reduce available memory addresses above 3GB. This may result in less than 4GB of memory being available to the operating system and applications.

Limitation: The system configuration does not show the memory bank when booting.

1.9.1 CPU FSB and memory speed

The AIMB-742 can accept DDR SDRAM memory chips without parity. Also note: The AIMB-742 accepts PC2100 (DDR266), PC2700 (DDR 333) and PC3200 (DDR 400) DDR SDRAM, depending on the CPU front side bus frequency (FSB). Please refer below table for the relationship between the CPU FSB and memory speed.

Table 1.5: CPU FSB and memory speed

Memory Speed	Processor	FSB frequency	Memory speed Outcome
DDR400	Pentium 4	800 MHz	400 MHz
DDR333	Pentium 4	800 MHz	320 MHz
	Pentium 4	533MHz	333 MHz
	Pentium 4 or Celeron	400 MHz	266 MHz
DDR266	Pentium 4	533 or 400 MHz	266 MHz
	Celeron	400 MHz	266 MHz

The AIMB-742 does not support ECC (error checking and correction). Memory modules with 9 SDRAM chips/side support ECC; modules with 8 chips/side do not support ECC.

1.9.2 Dual channel configuration

The four DIMM sockets are arranged in two channels: DIMM1 & DIMM2 in channel A; DIMM3 & DIMM4 in channel B. To enable dual channel operation, please install a matched pair of DIMMs in DIMM1 & DIMM3 (green sockets). If additional memory is to be used, another matched pair of DIMMs have to be installed in DIMM2 & DIMM4 (purple sockets).

"Matched pair of DIMMs" means: same in speed (DDR266, DDR333, DDR400), same in size (128MB, 256MB, 512MB or 1GB), same in chip

density (128 Mb, 256Mb or 512Mb and same in CSA latency. Any other memory configuration will result in single channel memory operation.

1.10 Memory Installation Procedures

To install DIMMs, first make sure the two handles of the DIMM socket are in the "open" position. i.e. The handles lean outward. Slowly slide the DIMM module along the plastic guides on both ends of the socket. Then press the DIMM module right down into the socket, until you hear a click. This is when the two handles have automatically locked the memory module into the correct position of the DIMM socket. To remove the memory module, just push both handles outward, and the memory module will be ejected by the mechanism in the socket.

1.11 Cache Memory

Since the second-level (L2) cache has been embedded into the Intel® socket 478 Pentium® 4/Celeron™ processor, you do not have to take care of either SRAM chips or SRAM modules. The built-in second-level cache in the processor yields much higher performance than the external cache memories. The cache size in the Intel® Pentium® 4 processor is 256/512/1024 KB. In the Celeron CPU, the cache size is 128/256KB.

1.12 Processor Installation

The AIMB-742 is designed for Intel Pentium® 4 processor/Celeron™ (socket 478)

Note: Slim Heatsink & Fan is available from Advantech. Please contact with Advantech's sales representative if needed.

Step 1 : Lift the processor socket lever

Step 2 : Align the corner having the triangle marking on the processor with the corner where the lever is attached to the socket

Step 3 : Lower the lever to its original position

CHAPTER
2

**Connecting
Peripherals**

Chapter 2 Connecting Peripherals

2.1 Introduction

You can access most of the connectors from the top of the board while it is installed in the chassis. If you have a number of cards installed or have a packed chassis, you may need to partially remove the card to make all the connections.

2.2 Primary (CN1) and Secondary (CN2) IDE Connectors

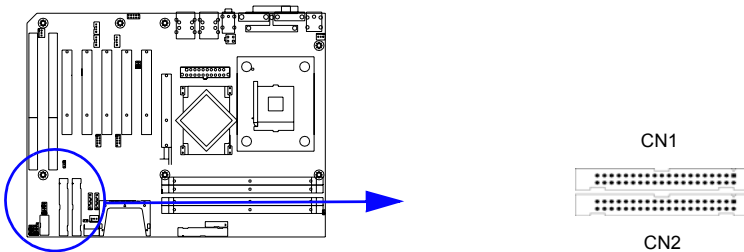

You can attach up to four IDE (Integrated Drive Electronics) drives to the AIMB-742's built-in controller. The primary (CN1) and secondary (CN2) connectors can each accommodate two drives.

Wire number 1 on the cable is red or blue and the other wires are gray. Connect one end to connector CN1 or CN2 on the motherboard. Make sure that the red/blue wire corresponds to pin 1 on the connector (in the upper right hand corner). See Chapter 1 for help finding the connector.

Unlike floppy drives, IDE hard drives can connect in either position on the cable. If you install two drives to a single connector, you will need to set one as the master and the other as the slave. You do this by setting the jumpers on the drives. If you use just one drive per connector, you should set each drive as the master. See the documentation that came with your drive for more information.

Connect the first hard drive to the other end of the cable. Wire 1 on the cable should also connect to pin 1 on the hard drive connector, which is labeled on the drive circuit board. Check the documentation that came with the drive for more information.

Connect the second hard drive to the remaining connector (CN2 or CN1), in the same way as described above. The secondary IDE shares the same

resource with CF (CompactFlash) socket. CF card is only available for master mode. While setting CF as master, the other IDE device connected to secondary IDE can work as a slave device only and vice versa.

2.3 Floppy Drive Connector (CN3)

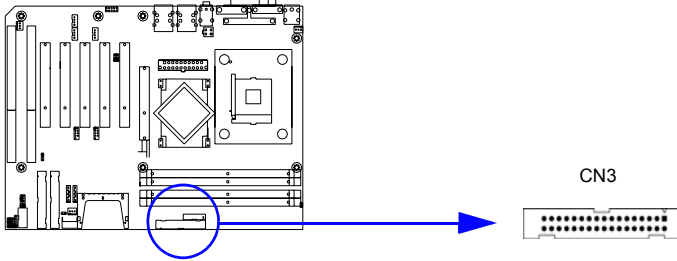

You can attach up to two floppy disk drives to the AIMB-742's onboard controller. You can use 3.5" (720 KB, 1.44 MB) drives.

The motherboard comes with a 34-pin daisy-chain drive connector cable. On one end of the cable is a 34-pin flat-cable connector. On the other end are two sets of 34-pin flat-cable connector (usually used for 3.5" drives). The set on the end (after the twist in the cable) connects to the A: floppy drive. The set in the middle connects to the B: floppy drive.

2.4 Parallel Port (CN4)

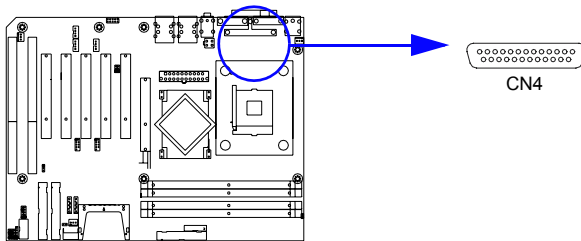

The parallel port is normally used to connect the motherboard to a printer. The AIMB-742 includes an onboard parallel port, accessed through a 26-pin flat-cable connector, CN4.

2.5 USB Ports (CN6/CN63)

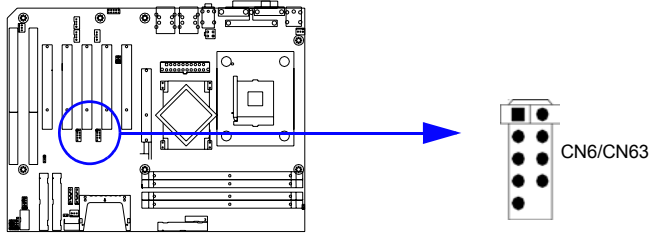

The AIMB-742 provides up to eight ports of USB (Universal Serial Bus) interface, which gives complete Plug & Play and hot swapping for up to 127 external devices. The USB interface complies with USB Specification Rev. 2.0 support transmission rate up to 480 Mbps and is fuse-protected. The USB interface can be disabled in the system BIOS setup.

2.6 VGA Connector (CN7)

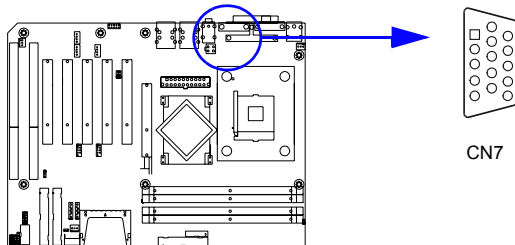

The AIMB-742 includes a VGA interface that can drive conventional CRT displays. CN7 is a standard 15-pin D-SUB connector commonly used for VGA. Pin assignments for CRT connector CN7 are detailed in Appendix B.

2.7 Serial Ports (COM1 : CN9; COM2 : CN10)

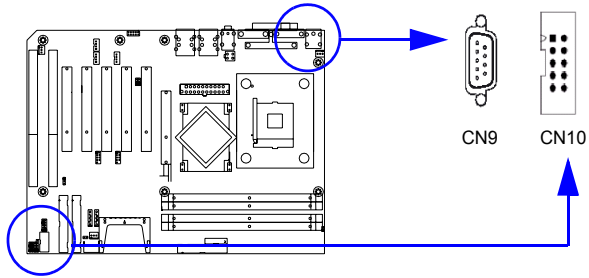

The AIMB-742 offers two serial ports, CN9 as COM1 and CN10 as COM2. These ports can connect to serial devices, such as a mouse or a printer, or to a communications network.

The IRQ and address ranges for both ports are fixed. However, if you want to disable the port or change these parameters later, you can do this in the system BIOS setup.

Different devices implement the RS-232 standard in different ways. If you are having problems with a serial device, be sure to check the pin assignments for the connector.

2.8 PS/2 Keyboard and Mouse Conn (CN11)

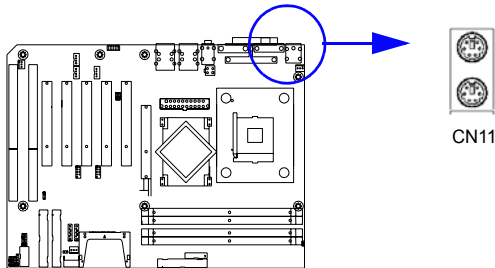

Two 6-pin mini-DIN connectors (CN11) on the motherboard provide connection to a PS/2 keyboard and a PS/2 mouse, respectively.

2.9 External Keyboard Connector (CN12)

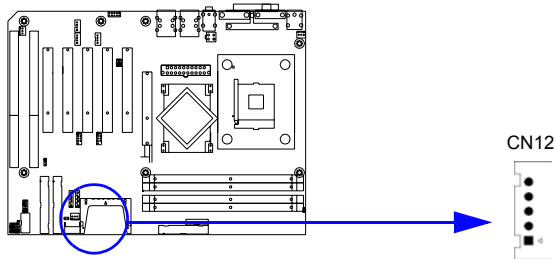

In addition to the PS/2 mouse/keyboard connector on the AIMB-742's rear plate, there is also an extra onboard external keyboard connector. This gives system integrators greater flexibility in designing their systems.

2.10 CPU Fan Connector (CN14)

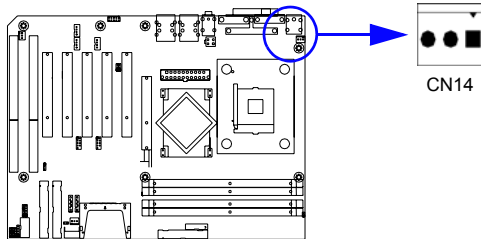

If fan is used, this connector supports cooling fans of 500mA (6W) or less.

2.11 System FAN connector (CN15 and CN37)

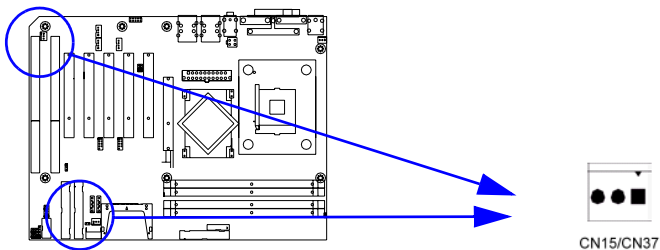

If fan is used, this connector supports cooling fans of 500mA (6W) or less.

2.12 Front Panel Connectors (CN16, 17, 18, 19, 21&29)

There are several external switches to monitor and control the AIMB-742

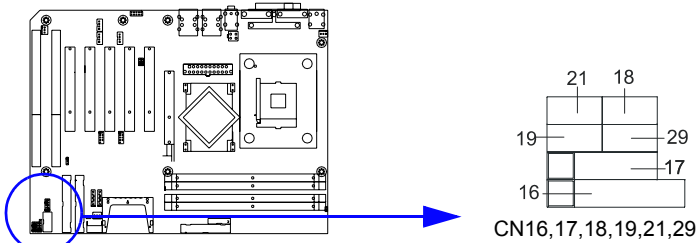

2.12.1 Power LED and Keyboard Lock (CN16)

CN16 is a 5-pin connector for the power on LED. Refer to Appendix B for detailed information on the pin assignments. If a PS/2 or ATX power supply is used, the system's power LED status will be as indicated below:

Table 2.1: PS/2 or ATX power supply LED status

Power mode	LED (PS/2 power)	LED (ATX power)
System On	On	On
System Suspend	Fast flashes	Fast flashes
System Off	Off	Slow flashes

2.12.2 External speaker (CN17)

CN17 is a 4-pin connector for an external speaker. If there is no external speaker, the AIMB-742 provides an onboard buzzer as an alternative. To enable the buzzer, set pins 3-4 as closed

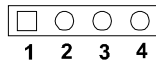

2.12.3 Reset (CN18)

Many computer cases offer the convenience of a reset button. Connect the wire from the reset button



2.12.4 HDD LED (CN19)

You can connect an LED to connector CN19 to indicate when the HDD is active.



2.12.5 ATX soft power switch (CN21)

If your computer case is equipped with an ATX power supply, you should connect the power on/off button on your computer case to CN21. This connection enables you to turn your computer on and off.

2.12.6 SM Bus Connector (CN29)

This connector is reserved for Advantech's SNMP-1000 HTTP/SNMP Remote System Manager. The SNMP-1000 allows users to monitor the internal voltages, temperature and fans from a remote computer through an Ethernet network.

CN29 can be connected to CN19 of SNMP-1000. Please be careful about the pin assignments, pin 1 must be connected to pin 1 and pin2 to pin 2 on both ends of cable.

2.13 H/W Monitor Alarm (CN22)

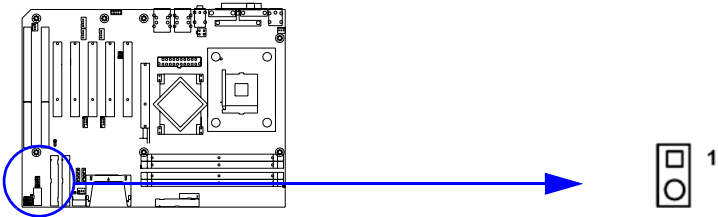

To enable or disable the function of buzzer.

2.14 USB and LAN ports (CN31 and CN32)

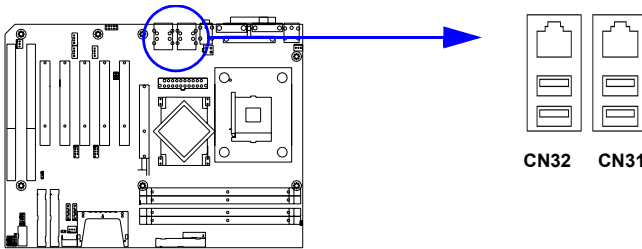

The AIMB-742 provides up to eight USB (Universal Serial Bus) ports, which gives complete Plug & Play and hot swapping for up to 127 external devices. The USB interface complies with USB Specification Rev. 2.0 support transmission rate up to 480 Mbps and is fuse-protected. The USB interface can be disabled in the system BIOS setup.

The AIMB-742 is equipped with one or two high-performance Ethernet interfaces, which are fully compliant with IEEE 802.3/u 10/100 Mbps CSMA/CD standards. Also, AIMB-742 provides the option of supporting single or dual 10/10/1000 Mbps Ethernet LANs. They are supported by all major network operating systems. The RJ-45 jacks on the rear plate provide convenient 10/100 Base-T or 10/100/1000 Base-T RJ-45 operation.

2.15 CF socket (CN44) (Option)

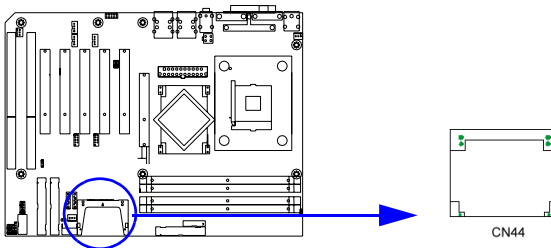

The AIMB-742 provides one CF socket, which is compatible with type I and type II CF cards. The CF socket shares the same resource with secondary IDE interface. CF card is only available for master mode. While setting CF as master, the other IDE device connected to secondary IDE can work as a slave device only.

2.16 Line Out, Mic IN connector (CN55)

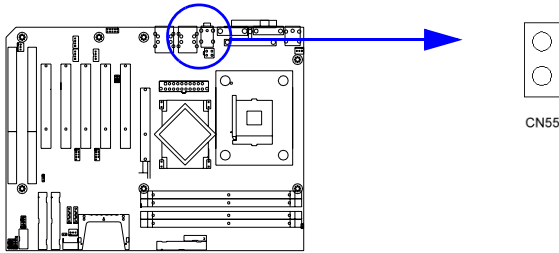

The Line Out is to output the audio signal to external audio device, like speakers or headphones. The Mic IN is to input the audio signal via microphones.

2.17 Audio input from CD-ROM (CD IN; CN56)

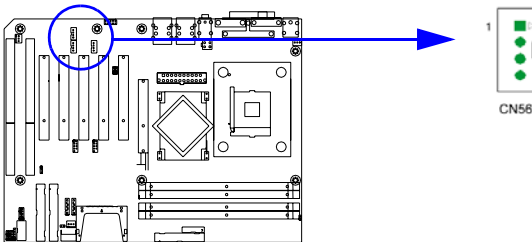

The CD IN is a connector for CD-ROM to input the audio signal.

2.18 Aux Line-In connector (AUX IN; CN57)

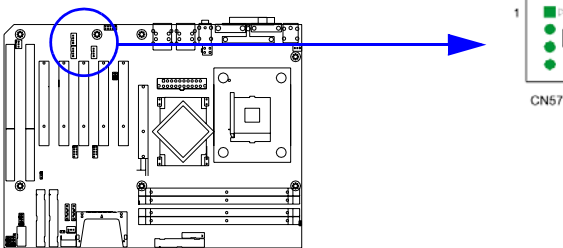

The connector is for audio device with Line-in connector.

2.19 Modem-In connector (MDM IN; CN58)

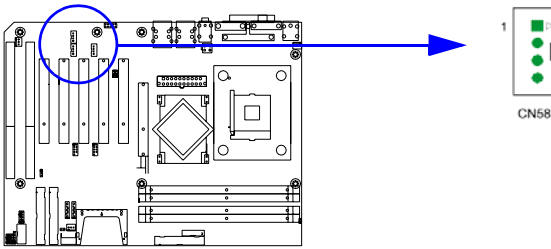

The connector is for modem with internal audio connector.

2.20 Front Panel audio connector (FP AUDIO; CN59)

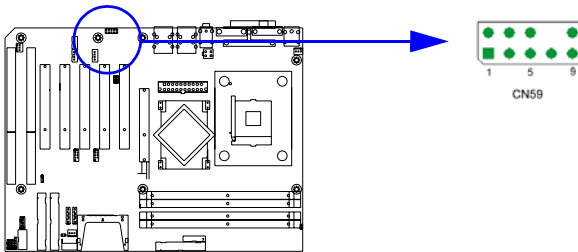

The FPAUDIO is a front panel audio connector compliant with Intel® Front Panel I/O Connectivity Design Guide. To direct the audio signal output to the rear audio ports, the 5 and 6 pins, 9 and 10 pins must be shorted by jumper to activate the rear panel audio function.

2.21 8-pin Alarm Board Connector (CN62)

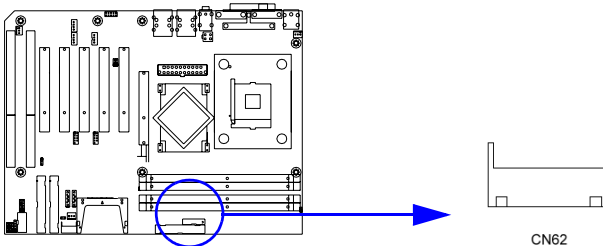

The 8-pin alarm board connector is for Advantech chassis with alarm board.

2.22 Case Open Connector (CN64)

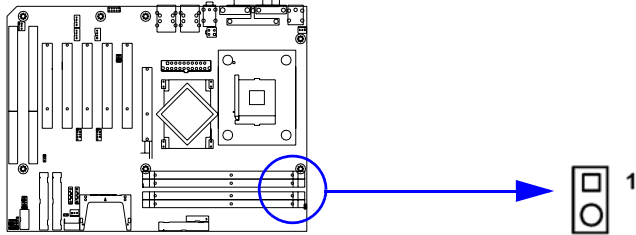

The 2-pin case open connector is for chassis with case open sensor. While opening the case, the buzzer on motherboard will ring.

2.23 Serial ATA interface (SA0 and SA1)

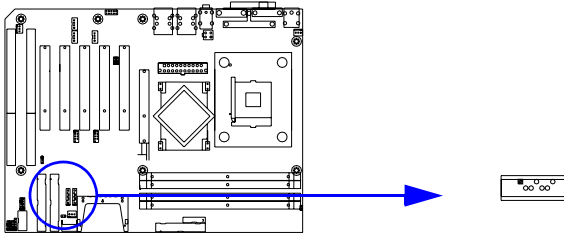

In addition to the two EIDE interfaces (up to four devices), the AIMB-742 features high performance serial ATA interface (up to 150MB/s) which eases cabling to hard drives with thin and long cables.

2.24 Connecting to SNMP-1000 remote manager

Use the 6-pin to 8-pin cable to connect the motherboard to SNMP-1000. This cable comes with the SNMP-1000.

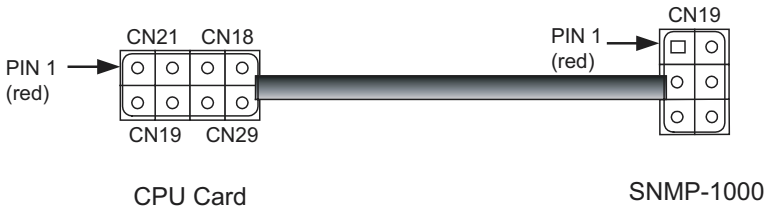

2.25 Auxiliary 4-pin power connector (ATX1)

To ensure the sufficiency of power supply for Pentium® 4 motherboard, one auxiliary 4 pin power connector is available on AIMB-742. It is strongly suggested to use ATX1 while the system is unstable.

CHAPTER
3

Award BIOS Setup

Chapter 3 Award BIOS Setup

3.1 Introduction

Award's BIOS ROM has a built-in setup program that allows users to modify the basic system configuration. This type of information is stored in battery-backed memory (CMOS RAM) so that it retains the setup information when the power is turned off.

3.1.1 CMOS RAM Auto-backup and Restore

The CMOS RAM is powered by an onboard button cell battery. When you finish BIOS setup, the data in CMOS RAM will be automatically backed up to Flash ROM. If operation in harsh industrial environment cause a soft error, BIOS will recheck the data in CMOS RAM and automatically restore the original data in Flash ROM to CMOS RAM for booting.

Note: If you intend to change the CMOS setting without restoring the previous backup, you have to click on "DEL" within two seconds of the "CMOS checksum error..." display screen message appearing. Then enter the "Setup" screen to modify the data. If the "CMOS checksum error..." message appears again and again, please check to see if you need to replace the battery in your system.

3.2 Entering Setup

Turn on the computer and press to allow you to enter the BIOS setup.

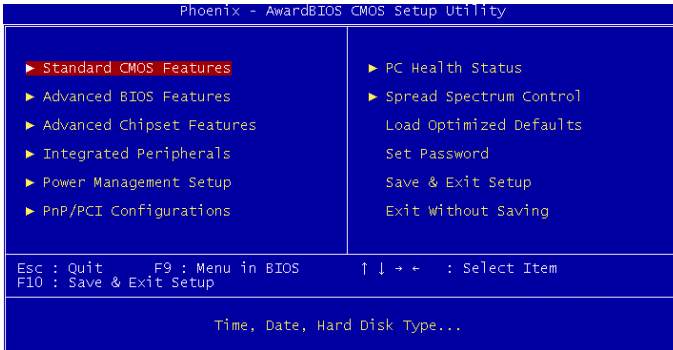

Figure 3.1: Award BIOS Setup initial screen

3.3 Standard CMOS Setup

Choose the “Standard CMOS Features” option from the “Initial Setup Screen” menu, and the screen below will be displayed. This menu allows users to configure system components such as date, time, hard disk drive, floppy drive, display, and memory.

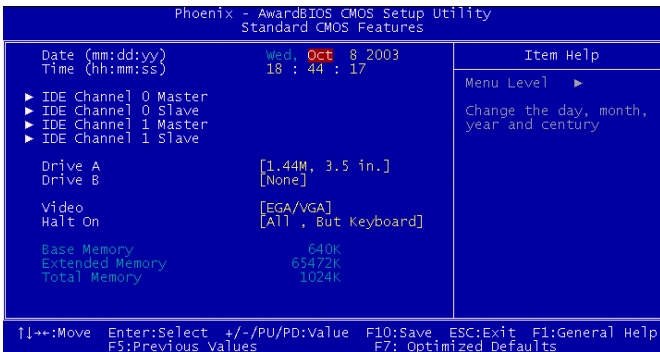

Figure 3.2: Standard CMOS features screen

3.4 Advanced BIOS Features

The “Advanced BIOS Features” screen appears when choosing the “Advanced BIOS Features” item from the “Initial Setup Screen” menu. It allows the user to configure the AIMB-742 according to his particular requirements. Below are some major items that are provided in the Advanced BIOS Features screen. A quick booting function is provided for your convenience. Simply enable the Quick Booting item to save yourself valuable time

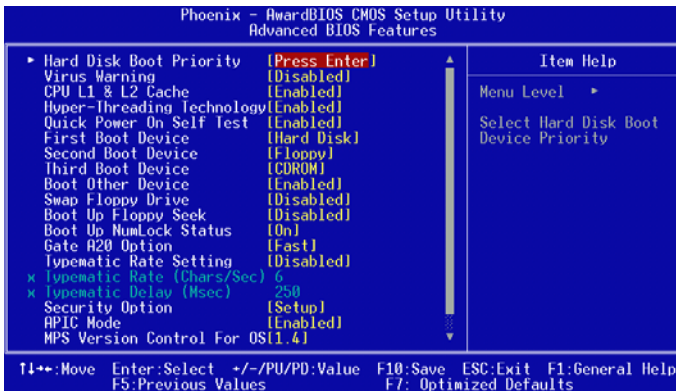

Figure 3.3: Advanced BIOS features screen

3.4.1 Hard Disk Boot Priority

Select hard disk boot device priority.

3.4.2 Virus Warning

Enable virus warning, the commands are "Enabled" or "Disabled".

3.4.3 CPU L1 & L2 Cache

Enabling this feature speeds up memory access. The commands are “Enabled” or “Disabled.”

3.4.4 Hyper-Threading Technology

While using CPU with Hyper-Threading technology, you can select "Enabled" to enable Hyper Threading Technology in OS which supports Hyper-Threading Technology or select "Disabled" for other OS which do not support HT technology.

3.4.5 Quick Power On Self Test

Allows the system to skip certain tests while booting. This will decrease the time needed to boot the system.

3.4.6 First/Second/Third Boot Device

The BIOS tries to load the OS with the devices in the sequence selected. Choices are: "Floppy", "LS120", "HDD-0", "SCSI", "CDROM", "HDD-1", "HDD-2", "HDD-3", "ZIP100", "USB-FDD", "USB-ZIP", "USB-CDROM", "USB-HDD", "LAN", "Disabled".

3.4.7 Boot Other Device

Choose other device to boot, the choice is "Enabled" or "Disabled".

3.4.8 Swap Floppy Drive

If the system has two floppy drives, choose "Enabled" to assign physical drive B to logical drive A and vice-versa. The commands are "Enabled" or "Disabled."

3.4.9 Boot UP Floppy Seek

Selection of the command "Disabled" will speed the boot up. Selection of "Enabled" searches disk drives during boot up.

3.4.10 Boot Up NumLock Status

This feature selects the "power on" state for NumLock. The commands are "Off" or "On."

3.4.11 Gate A20 Option

"Normal": A pin in the keyboard controller controls GateA20.

"Fast" (Default): Lets chipset control GateA20.

3.4.12 Typematic Rate Setting

The typematic rate is the rate key strokes repeat as determined by the keyboard controller. The commands are "Enabled" or "Disabled". Enabling allows the typematic rate and delay to be selected.

3.4.13 Typematic Rate (Chars/Sec)

BIOS accepts the following input values (characters/second) for typematic rate: 6, 8, 10, 12, 15, 20, 24, 30.

3.4.14 Typematic Delay (msec)

Typematic delay is the time interval between the appearance of two consecutive characters, when holding down a key. The input values for this category are: 250, 500, 750, 1000 (msec).

3.4.15 Security Option

Select whether the password is required every time the system boots or only when you enter setup.

"System" The system will not boot, and access to Setup will be denied if the correct password is not entered at the prompt.

"Setup" The system will boot, but access to Setup will be denied if the correct password is not entered at the prompt.

Note: To disable security, select "PASSWORD SETTING" in the main menu. At this point, you will be asked to enter a password. Simply press <Enter> to disable security. When security is disabled, the system will boot, and you can enter Setup freely.

3.4.16 APIC Mode

This setting allows to enable the APIC mode, the choice is "Disabled" or "Enabled."

3.4.17 MPS Version Control For OS

This reports if an FDD is available for Windows 95. The selections are "1.1" or "1.4."

3.4.18 OS Select For DRAM > 64MB

Select OS2 only if you are running OS/2 operating system with greater than 64MB of RAM on the system. Commands are "Non-OS2" or "OS2."

3.5 Advanced Chipset Features

By choosing the "Advanced Chipset Features" option from the "Initial Setup Screen" menu, the screen below will be displayed. This sample screen contains the manufacturer's default values for the AIMB-742, as shown in Figure 3-4:

Note: DRAM default timings have been carefully chosen and should ONLY be changed if data is being lost. Please first contact technical support.

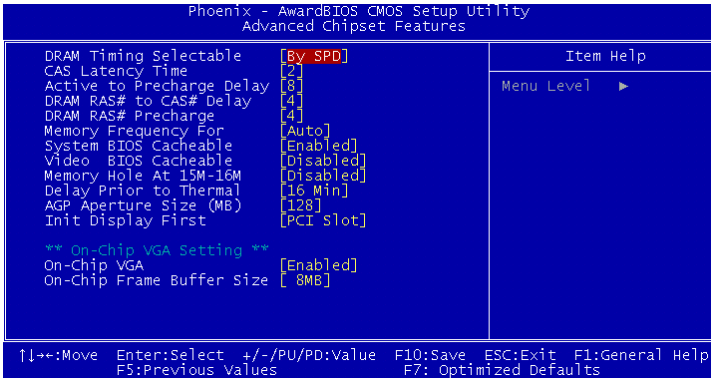

Figure 3.4: Advanced chipset features screen

3.5.1 DRAM Timing Selectable

This item allows you to control the DRAM speed. The selections are "Manual" or "By SPD".

3.5.2 CAS Latency Time

This controls the latency between DDR RAM read command and the time that the data actually becomes available. Leave this on the default setting. The options are "2", "2.5" or "3".

3.5.3 Active to Precharge Delay

This item allows you to select the value in this field, depending on whether the board has paged DRAMs or EDO (extended data output) DRAMs. The Choice: "8", "7", "6" and "5".

3.5.4 DRAM RAS# to CAS# Delay

In order to improve performance, certain space in memory is reserved for ISA cards. This memory must be mapped into the memory space below 16MB. The Choice: "4", "3" and "2".

3.5.5 DRAM RAS# Precharge

This controls the idle clocks after issuing a precharge command to DRAM. Leave this on the default setting. The choice : "4", "3" and "2".

3.5.6 Memory Frequency

To adjust the frequency of memory. The choice : "DDR266", "DDR333", "DDR400" and "Auto".

3.5.7 System BIOS Cacheable

Selecting Enabled allows caching of the system BIOS ROM at F0000h-FFFFFh, resulting in better system performance. However, if any program writes to this memory area, a system error may occur. The Choices: "Enabled", "Disabled".

3.5.8 Video Bios Cacheable

Selecting Enabled allows caching of the video BIOS, resulting in better system performance. However, if any program writes to this memory area, a system error may occur. The Choices: "Enabled", "Disabled".

3.5.9 Memory Hole At 15M-16M

Enabling this feature reserves 15 MB to 16 MB memory address space for ISA expansion cards that specifically require this setting. This makes memory from 15 MB and up unavailable to the system. Expansion cards can only access memory up to 16 MB. The default setting is "Disabled."

3.5.10 Delay Prior to Thermal

Select the period if user wants to lower the CPU speed when CPU temperature is too high. The choice: "4 Min", "8 Min", "16 Min" and "32 Min".

3.5.11 AGP Aperture Size (MB)

Select the size of Accelerated Graphics Port (AGP) aperture. The aperture is a portion of the PCI memory address range dedicated for graphics memory address space. Host cycles that hit the aperture range are forwarded to the AGP without any translation. The Choice : "4", "8", "16", "32", "64", "128", and "256".

3.5.12 Init Display First

Choose the first display interface to initiate while booting. The choice is "PCI Slot" or "Onboard".

3.5.13 On-Chip VGA

User can disable onboard VGA controller by selecting "Disabled"

3.5.14 On-Chip Frame Buffer Size

User can select frame buffer size. Option is : "1MB", "8MB" and "16MB".

3.6 Integrated Peripherals

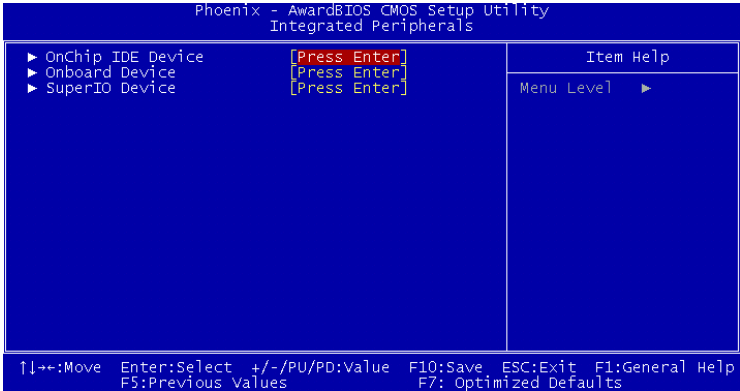

Figure 3.5: Integrated peripherals

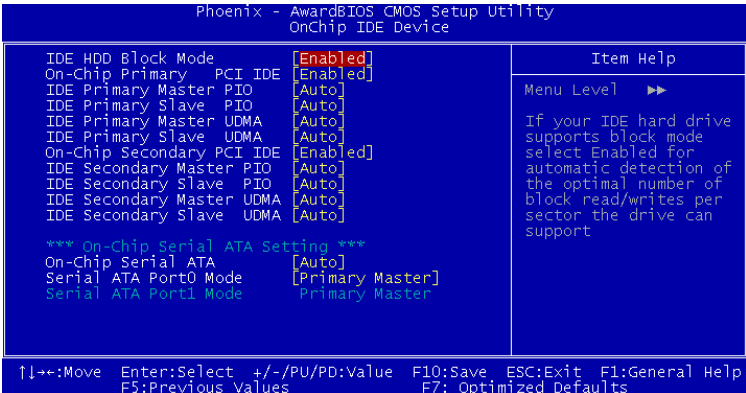

Figure 3.6: On-Chip IDE Device

3.6.1 IDE HDD Block Mode

If your IDE hard drive supports block mode select Enabled for automatic detection of the optimal number of block read/writes per sector the drive can support.

3.6.2 On-Chip IDE Device

IDE Primary (Secondary) Master/Slave PIO/UDMA Mode (Auto) Each channel (Primary and Secondary) has both a master and a slave, making four IDE devices possible. Because each IDE device may have a different Mode timing (0, 1, 2, 3, 4), it is necessary for these to be independent. The default setting "Auto" will allow auto detection to ensure optimal performance.

3.6.3 On-Chip Serial ATA

Choose the status of serial ATA, the default setting is "Auto" which let system to arrange all parallel and serial ATA resource automatically. The "Disabled" will disable SATA controller. The "Combined Mode" will combine PATA and SATA, and max of 2 IDE drives in each channel. The "Enhanced Mode" will enable both SATA and PATA, and max of 6 IDE drives are supported. The "SATA Only" means SATA is operating in legacy mode.

3.6.4 Serial ATA Port0/Port1 Mode

Select the mode for SATA port0 and SATA port1. The choices are "Primary Master", "Primary Slave", "Secondary Master", "Secondary Slave", "SATA0 Master" and "SATA1 Master".

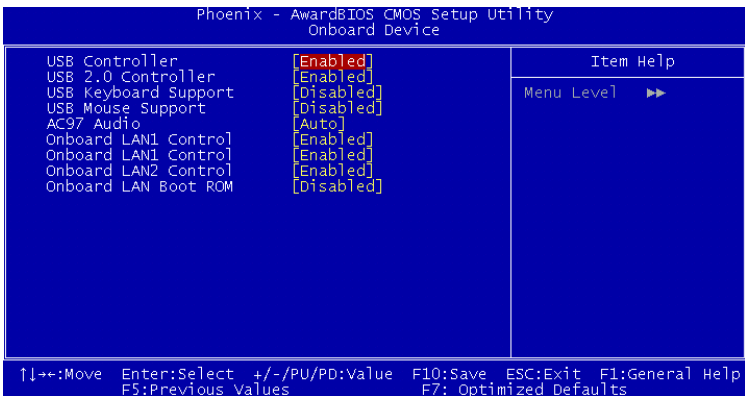

Figure 3.7: Onboard Device

3.6.5 USB Controller

Select Enabled if your system contains a Universal Serial Bus (USB) controller and you have USB peripherals. The choices: "Enabled", "Disabled".

3.6.6 USB 2.0 Controller

This entry is for disable/enable USB2.0 controller only. The BIOS itself may/may not have high speed USB support. If the BIOS has high speed USB support built in, the support will be automatically turn on when high speed device were attached. The Choice : "Enabled" and "Disabled".

3.6.7 USB Keyboard/Mouse Support

Select Enabled if user plan to use an USB keyboard. The choice: "Enabled", "Disabled".

3.6.8 AC97 Audio

Select Disable if you do not want to use AC-97 audio. Option is "Auto", "Disabled".

3.6.9 Onboard LAN1 Control

Options are "Enabled" and "Disabled" Select Disable if user does not want to use onboard LAN controller1

3.6.10 Onboard LAN2 Control

Options are "Enabled" and "Disabled" Select Disable if user does not want to use onboard LAN controller2

3.6.11 Onboard LAN Boot ROM

Decide whether to invoke the boot ROM of the onboard LAN chip. The Choice : "Disabled", "LAN1".

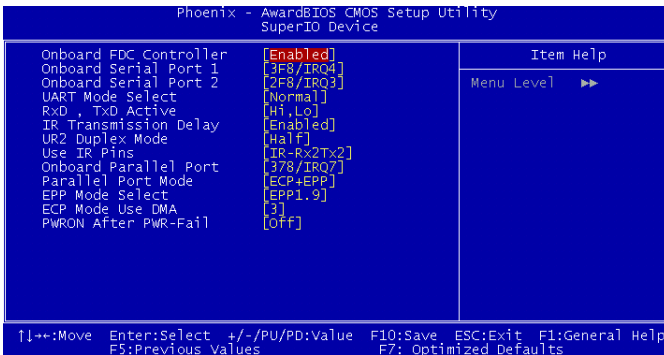

Figure 3.8: SuperIO Device

3.6.12 Onboard FDC Controller

When enabled, this field allows you to connect your floppy disk drives to the onboard floppy disk drive connector instead of a separate controller card. If you want to use a different controller card to connect the floppy disk drives, set this field to Disabled.

3.6.13 Onboard Serial Port 1

The settings are "3F8/IRQ4", "2F8/IRQ3", "3E8/IRQ4", "2E8/IRQ3" and "Disabled" for the on-board serial connector.

3.6.14 Onboard Serial Port 2

The settings are "3F8/IRQ4", "2F8/IRQ3", "3E8/IRQ4", "2E8/IRQ3" and "Disabled" for the on-board serial connector.

3.6.15 UART Mode Select

This item allows you to select UART mode. The choices: "IrDA", "ASKIR", "Normal".

3.6.16 RxD, TxD Active

This item allows you to determine the active of RxD, TxD. The Choices: "Hi, Hi," "Lo, Lo," "Lo, Hi," "Hi, Lo."

3.6.17 IR Transmission Delay

This item allows you to enable/disable IR transmission delay. The choices: "Enabled", "Disabled".

3.6.18 UR2 Duplex Mode

This item allows you to select the IR half/full duplex function. The choices: "Half", "Full".

3.6.19 Use IR Pins

The Choice : "RxD2, TxD2", "IR-Rx2Tx2".

3.6.20 Onboard Parallel Port

This field sets the address of the on-board parallel port connector. You can select either "378/IRQ7", "278/IRQ5", "3BC/IRQ7", or "Disabled". If you install an I/O card with a parallel port, make sure there is no conflict in the address assignments. The single board computer can support up to three parallel ports, as long as there are no conflicts for each port.

3.6.21 Parallel Port Mode

This field allows you to set the operation mode of the parallel port. The setting "Normal" allows normal speed operation, but in one direction only. "EPP" allows bidirectional parallel port operation at maximum speed. "ECP" allows the parallel port to operate in bi-directional mode

and at a speed faster than the maximum data transfer rate. “ECP + EPP” allows normal speed operation in a two-way mode.

3.6.22 EPP Mode Select

This field allows you to select EPP port type 1.7 or 1.9. The choices: "EPP1.9", "EPP1.7".

3.6.23 ECP Mode Use DMA

This selection is available only if you select “ECP” or “ECP + EPP” in the Parallel Port Mode field. In ECP Mode Use DMA, you can select DMA channel 1, or DMA channel 3. Leave this field on the default setting.

3.6.24 PWRON After PWR-Fail

To setup the status of system after power fail. The "Off" will keep system power off after power fail, the "On" will boot up the system after fail, and the "Former-Sts" will return to the status before power fail.

3.7 Power Management Setup

The power management setup controls the single board computer's “green” features to save power. The following screen shows the manufacturer’s defaults.

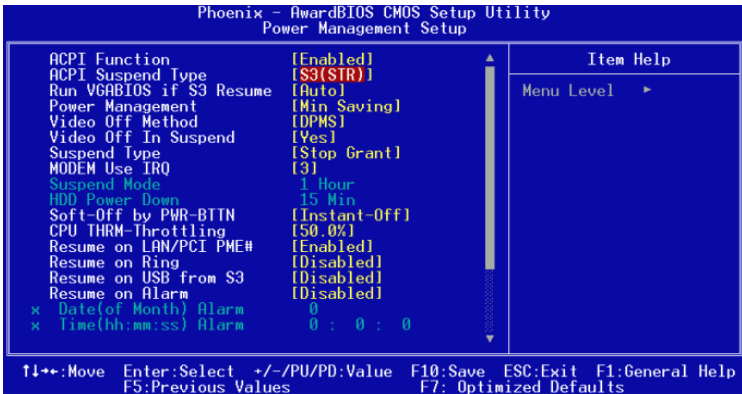

Figure 3.9: Power management setup screen (1)

3.7.1 ACPI function

The choice: "Enabled", "Disabled".

3.7.2 ACPI Suspend Type

The Choice : "S1(POS)", and "S3(STR)". While selecting "S3(STR)", the "Run VGABIOS if S3 Resume" and "Resume on USB from S3" will be active for selection.

3.7.3 Power Management

This category allows you to select the type (or degree) of power saving and is directly related to the following modes:

1. HDD Power Down
2. Suspend Mode

There are three selections for Power Management, and they have fixed mode settings.

Min Saving	Minimum power management., Suspend Mode = 1 hr., and HDD Power Down = 15 min.
Max Saving	Maximum power management., Suspend Mode = 1 min., and HDD Power Down = 1 min.
User Defined (Default)	Allows you to set each mode individually. When not disabled, each of the ranges are from 1 min. to 1 hr. except for HDD Power Down which ranges from 1 min. to 15 min. and disable.

3.7.4 Video Off Method

To select the method to off the video. The Choice : "Blank Screen", "V/H SYNC+ Blank", "DPMS".

3.7.5 Video Off In Suspend

When system is in suspend, video will turn off. The choices are "No" and "Yes".

3.7.6 Suspend Type

The Choice : "Stop Grant", "PwrOn Suspend".

3.7.7 Modem Use IRQ

This determines the IRQ in which the MODEM can use. The choices: "3", "4", "5", "7", "9", "10", "11", "NA".

3.7.8 Soft-Off by PWR-BTTN

If you choose "Instant-Off", then pushing the ATX soft power switch button once will switch the system to "system off" power mode. You can choose "Delay 4 sec." If you do, then pushing the button for more than 4

seconds will turn off the system, whereas pushing the button momentarily (for less than 4 seconds) will switch the system to “suspend” mode.

3.7.9 CPU THRM-Throttling

This field allows you to select the CPU THRM-Throttling rate. The choices: "75.0%", "50.0%", and "25.0%".

3.7.10 Resume on LAN/PCI PME#

To enabled or disable the function to resume the system by PCI card or LAN. The Choice : "Enabled", "Disabled".

3.7.11 Resume on Ring

This item allows you to wake up the system via COM port from the remotehost. The choices: "Enabled", "Disabled".

3.7.12 Resume on Alarm

The Choice : "Enabled", "Disabled".

3.7.13 Primary IDE 0 (1) and Secondary IDE 0 (1)

When Enabled, the system will resume from suspend mode if Primary IDE 0 (1) or Secondary IDE 0 (1) is active. The choice: "Enabled", "Disabled".

3.7.14 FDD, COM, LPT PORT

When Enabled, the system will resume from suspend mode if FDD, COM port, or LPT port is active. The choice: "Enabled", "Disabled".

3.7.15 PCI PIRQ [A-D]#

When Enabled, the system will resume from suspend mode if interrupt occurs. The choice: "Enabled", "Disabled".

3.8 PnP/PCI Configurations

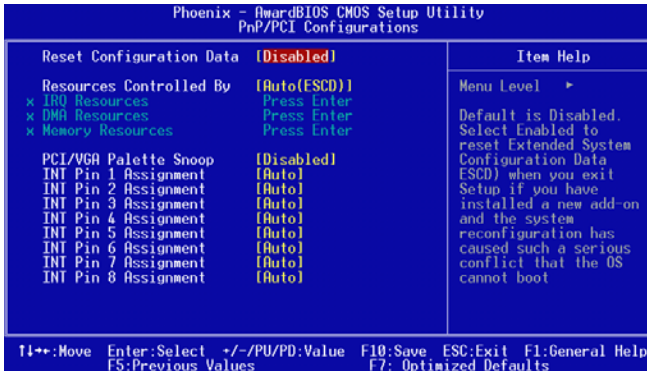

Figure 3.10: PnP/PCI configurations screen

3.8.1 Reset Configuration Data

Default is Disable. Select Enable to reset Extended System Configuration Data (ESCD) if you have installed a new add-on and system configuration has caused such a conflict that OS cannot boot.

3.8.2 Resources Controlled By

The commands here are "Auto(ESCD)" or "Manual." Choosing "manual" requires you to choose resources from each following sub-menu. "Auto(ESCD)" automatically configures all of the boot and Plug and Play devices but you must be using Windows 95 or above.

3.8.3 PCI/VGA Palette Snoop

This is left at "Disabled."

3.9 PC Health Status

3.9.1 CPU Warning Temperature

This item will prevent the CPU from overheating. The choices are: "Disabled", "50C/122F", "53C/127F", "56C/133F", "60C/140F", "63C/145F", "66C/151F", "70C/158F".

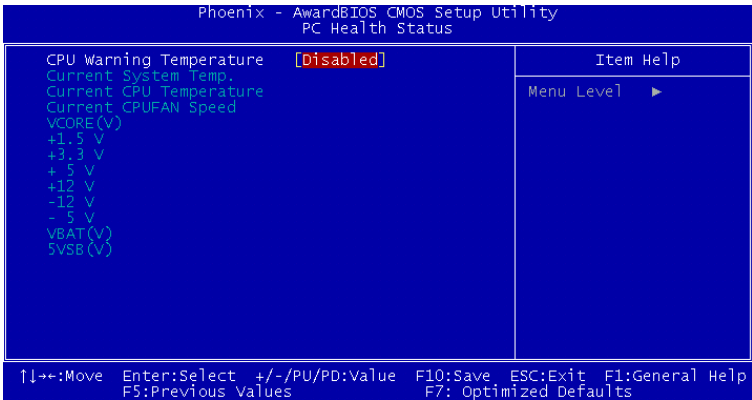

Figure 3.11: PC health status screen

3.9.2 Current System Temp

This shows you the current temperature of system.

3.9.3 Current CPU Temperature

This shows you the current CPU temperature.

3.9.4 Current CPUFAN Speed

This shows you the current CPUFAN operating speed.

3.9.5 VCORE, +1.5V, VCC3, +5V, +12V, -12V, -5V, VBAT(V), 5VSB(V)

This shows you the voltage of VCORE, +1.5V, VCC3, +5V, +12V, -12V, -5V, VBAT(V), and 5VSB(V).

3.10 Spread Spectrum Control

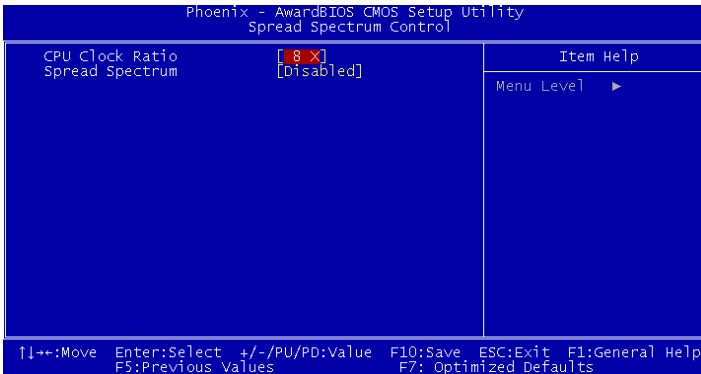

Figure 3.12: Spread Spectrum Control screen

3.10.1 CPU Clock Ratio

Key in a DEC number to setup the CPU Clodk Ratio. (Min=8; Max=50). This item only shows up under some special situations.

3.10.2 Spread Spectrum

To enable/disable the spread spectrum. The Choice : "Disabled", "- 0.40%", "- 0.50%", "- 0.60%" and "- 1.00%".

3.11 Password Setting

To change the password:

1. Choose the “Set Password” option from the “Initial Setup Screen” menu and press <Enter>.

The screen will display the following message:

Please Enter Your Password

Press <Enter>.

2. If the CMOS is good or if this option has been used to change the default password, the user is asked for the password stored in the CMOS. The screen will display the following message:

Please Confirm Your Password

Enter the current password and press <Enter>.

3. After pressing <Enter> (ROM password) or the current password (user-defined), you can change the password stored in the CMOS. The password must be no longer than eight (8) characters.

Remember, to enable the password setting feature, you must first select either “Setup” or “System” from the “Advanced BIOS Features” menu.

3.12 Save & Exit Setup

If you select this and press <Enter>, the values entered in the setup utilities will be recorded in the CMOS memory of the chipset. The microprocessor will check this every time you turn your system on and compare this to what it finds as it checks the system. This record is required for the system to operate.

3.13 Exit Without Saving

Selecting this option and pressing <Enter> lets you exit the setup program without recording any new values or changing old ones.

CHAPTER **4**

**Chipset Software
Installation Utility**

Chapter 4 Chipset Software Install Utility

4.1 Before you begin

To facilitate the installation of the enhanced display device drivers and utility software, you should read the instructions in this chapter carefully before you attempt installation. The device drivers for the AIMB-742 board are located on the software installation CD. The auto-run function of the driver CD will guide and link you to the utilities and device drivers under a Windows system. The Intel® Chipset Software Installation Utility is not required on any systems running Windows NT 4.0. Updates are provided via Service Packs from Microsoft*.

Note: The files on the software installation CD are compressed. Do not attempt to install the drivers by copying the files manually. You must use the supplied SETUP program to install the drivers.

Before you begin, it is important to note that most display drivers need to have the relevant software application already installed in the system prior to installing the enhanced display drivers. In addition, many of the installation procedures assume that you are familiar with both the relevant software applications and operating system commands. Review the relevant operating system commands and the pertinent sections of your application software's user's manual before performing the installation.

4.2 Introduction

The Intel® Chipset Software Installation (CSI) utility installs to the target system the Windows INF files that outline to the operating system how the chipset components will be configured. This is needed for the proper functioning of the following features:

- Core PCI and ISA PnP services.
- AGP support.
- IDE Ultra ATA 100/66/33 and Serial ATA interface support.
- USB 1.1/2.0 support (USB 2.0 driver needs to be installed separately for Win98)

- Identification of Intel ® chipset components in the Device Manager.
- Integrates superior video features. These include filtered sealing of 720 pixel DVD content, and MPEG-2 motion compensation for software DVD

Note: This utility is used for the following versions of Windows system, and it has to be installed before installing all the other drivers:

Windows 98SE

Windows 2000

Windows Me

Windows XP

4.3 Windows XP Driver Setup

1. Insert the driver CD into your system's CD-ROM drive. In a few seconds, the software installation main menu appears. Move the mouse cursor over the "Install" button under the "CSI UTILITY" heading, a message pops up telling you to install the CSI utility before other device drivers, as shown in the following figure. Click on this button. Taking Windows XP as example.

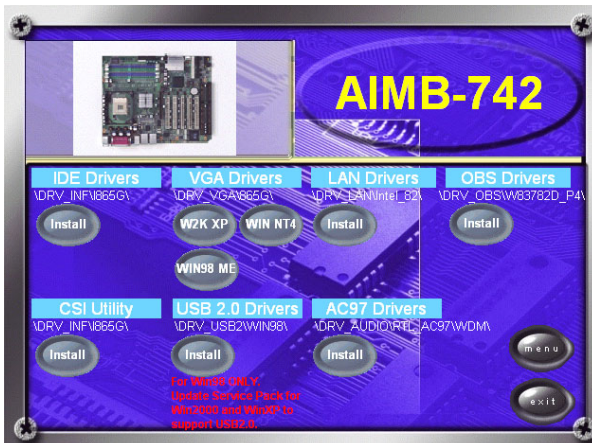

2. Click "Next" when you see the following message.

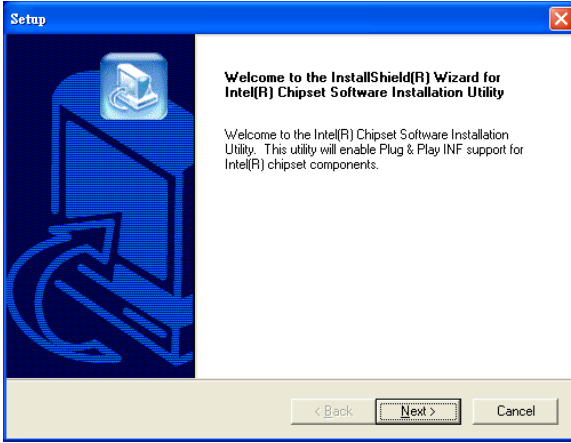

3. Click "Yes" when you see the following message.

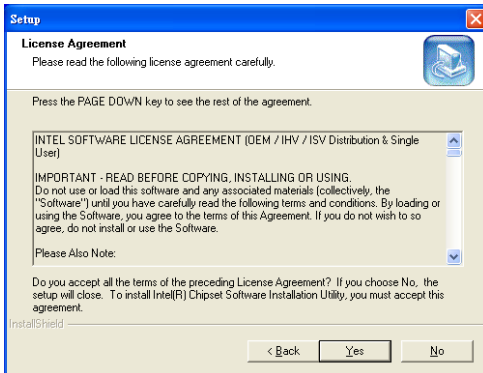

- Click "Next" when you see the following message.

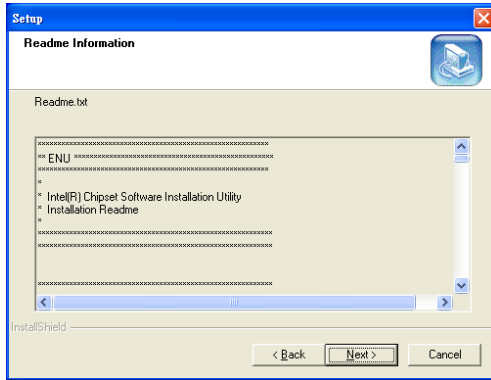

- When the following message appears, click "Finish" to complete the installation and restart Windows.

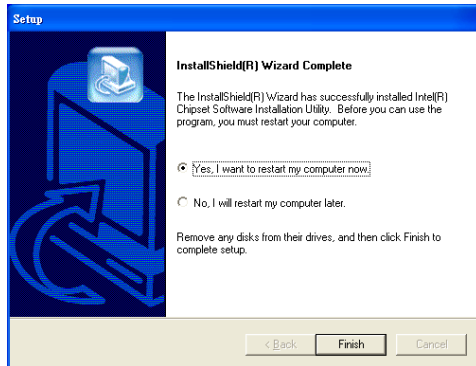

CHAPTER
5

VGA Setup

Chapter 5 VGA Setup

5.1 Introduction

The AIMB-742 has VGA onboard, you need to install the VGA driver to enable the function.

The Intel® 865G/865GV Graphics Memory Controller Hub (the 865G/865GV GMCH) provides an integrated graphics accelerator delivering cost competitive 3D, 2D, and video capabilities. The GMCH contains an extensive set of instructions for 3D operations, BLT and Stretch BLT operations, motion compensation, overlay, and display control. The 865G/865GV GMCH's video engines support video conferencing and other video applications. The GMCH does not support a dedicated local graphics memory interface; it may only be used in a UMA configuration. The features include:

- Built-in 2D/3D VGA controller.
- Use Intel® Extreme Graphics Architecture
- Integrated 350MHz RAMDAC that can directly drive a progressive scan analog monitor up to a resolution of 2048x1536 at 75Hz
- Maximum 3D resolution supported : 1600 x 1200 x 32 @ 85Hz.
- H/W motion compensation assistance for s/w MPEG 2 decoding.
- Software DVD at 30 fps Full Screen.

5.2 Dynamic Video Memory Technology

The following is quoted from "Intel® 865G/865GV Chipset Dynamic Video Memory Technology", document number : 253144-001 :

The method of memory allocation where the Operating System, Application and Graphics Memory come from a unified System Memory pool known as Unified Memory Architecture (UMA).

Dynamic Video Memory Technology (DVMT) is an enhancement of the UMA concept, wherein the optimum amount of memory is allocated for balanced graphics and system performance, through Direct AGP (known as Non-Local Video Memory, or NLVM), and a highly efficient memory utilization scheme. DVMT ensures the most efficient use of available memory – regardless of frame buffer or main memory sizing – for maximum 2D/3D graphics performance.

DVMT dynamically responds to system requirements, and application demands, by allocating the proper amount of display, texturing and buffer memory after the operating system has booted. For example, a 3D application when launched may require more vertex buffer memory to enhance the complexity of objects, or more texture memory to enhance the richness of the 3D environment. The operating system views the integrated graphics driver as an application, which uses Direct AGP to request allocation of additional memory for 3D applications, and returns the memory to the operating system (OS) when no longer required.

The Intel Extreme Graphics Driver determines the size of the pre-allocated memory needed and will make additional Non-Local Video Memory requests to achieve the amount needed for the display and application requirement. The video memory size in the Intel® 865G/865GV chipset varies and is determined using several factors. The key factors are system resources and system activity. The maximum video memory is up to 64MB SDRAM

5.3 Windows XP Driver Setup

Note: Before installing this driver, make sure the CSI utility has been installed in your system. See Chapter 4 for information on installing the CSI utility

1. Insert the driver CD into your system's CD-ROM drive. In a few seconds, the software installation main menu appears, as shown in the following figure. Under the "VGA DRIVERS" heading, click on one of the buttons (labeled "W2K XP", "WIN98 ME", and "WIN NT4" respectively) according to the operating system you are using. The following

installation procedure is for Windows XP. For other operating systems, please follow the on-screen installation guide



1. Please click on "Next" to continue the installation

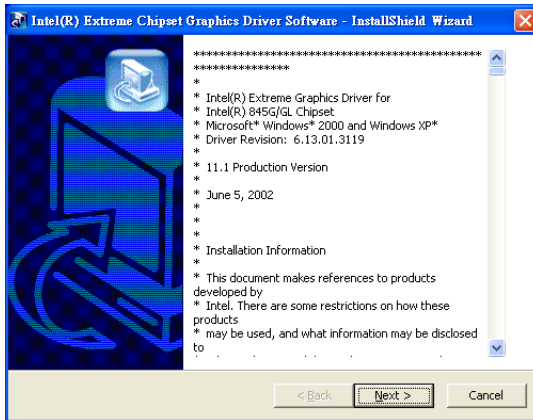

2. You will see a welcome window. Please click on "Next" to continue the installation.

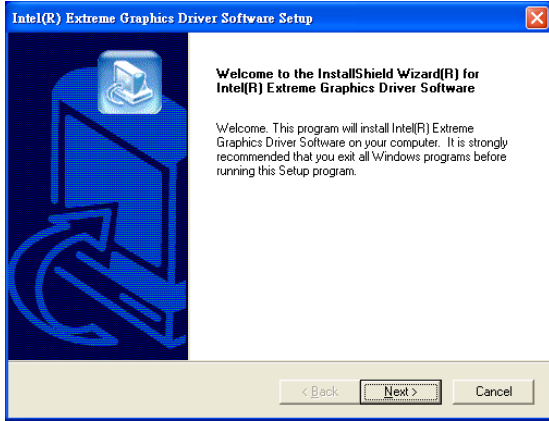

3. Click "Yes" when you see the following message.

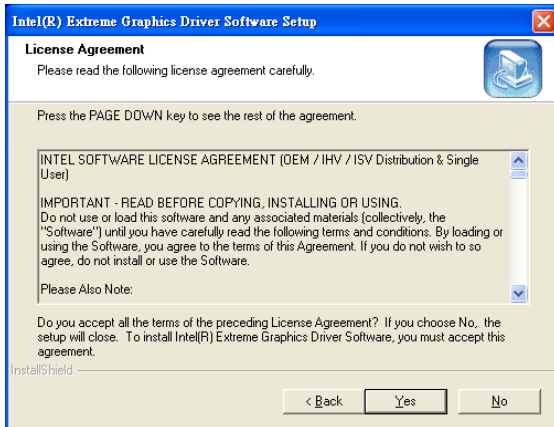

4. Click on "Yes" to continue the installation

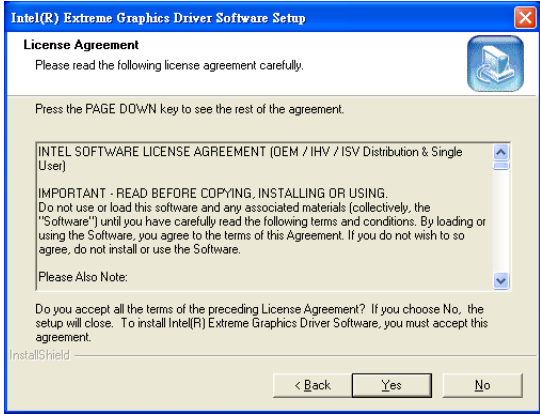

5. Click "Finish" to complete the installation and restart the computer now or later.

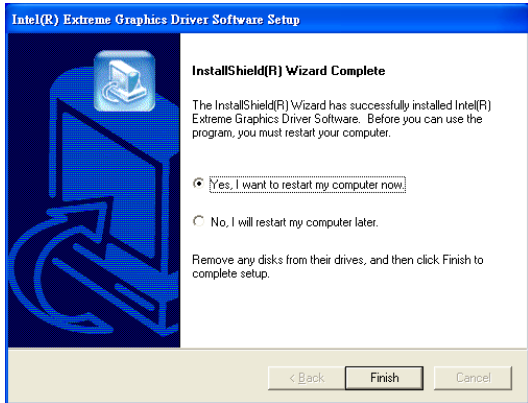

CHAPTER
6

LAN Configuration

Chapter 6 LAN Configuration

6.1 Introduction

The AIMB-742 features the 32-bit 10/100/1000 Mbps Ethernet network interface. This interface supports bus mastering architecture and auto-negotiation features. Therefore standard twisted-pair cabling with RJ-45 connectors for 10 Mbps, 100 Mbps and 1000 Mbps connections can be used. Extensive driver support for commonly-used network systems is also provided.

6.2 Features

- Optional single/dual Intel 82562/82551 10/100Base-T Ethernet LAN controller
- Optional single/dual Intel 82547/82541 10/100/1000 Base-T Ethernet LAN controller
- Supports Wake-on-LAN remote control function.
- PCI Bus Master complies with PCI Rev. 2.2
- MAC & PHY (10/100/1000 Mbps) interfaces.
- Complies with 1000Base-T, 100Base-TX, and 10Base-T applications.
- Fully supports 1000Base-T, 100Base-TX, and 10Base-T operation.
- Single RJ-45 connector gives auto-detection of 10 Mbps, 100 Mbps, or 1000 Mbps network data transfer rates and connected cable types.
- Plug and Play.
- Enhancements on ACPI & APM.
- Complies with PCI Bus Power Management Interface Rev. 1.1,
- ACPI Rev. 2.0, and Device Class Power Management Rev. 1.0.

6.3 Installation

Note: Before installing the LAN drivers, make sure the CSI utility has been installed in your system. See Chapter 4 for information on installing the CSI utility.

The AIMB-742's onboard Ethernet interface supports all major network operating systems. However, the installation procedure varies with different operating systems. In the following sections, refer to the one that provides driver setup procedure for the operating system you are using.

6.4 Win XP Driver Setup (Intel 82547/41/62/51)

1. Insert the driver CD into your system's CD-ROM drive. In a few seconds, the software installation main menu appears, as shown in the following figure. Under the "LAN Drivers" heading, click on the "Install" to complete installation procedure.

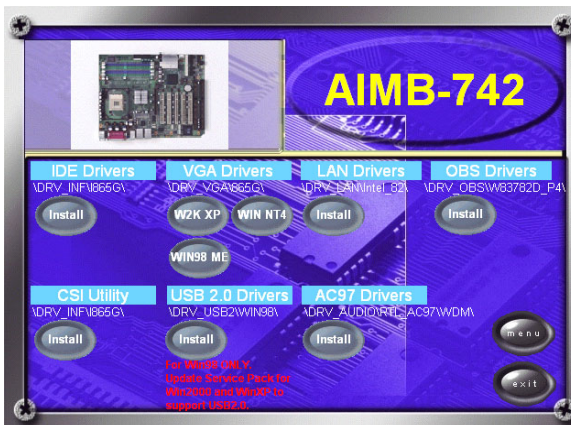

2. Select "I accept the terms in the license agreement" and click "Next" to continue.

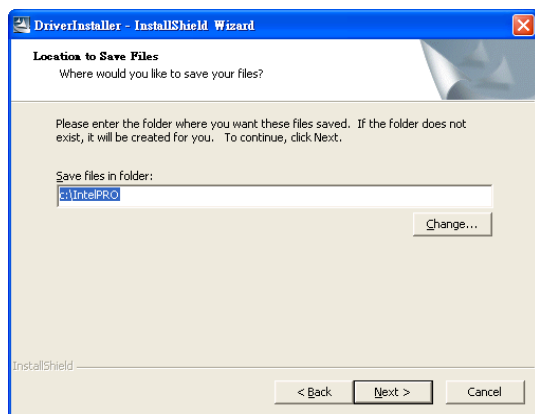

3. Click "Next" to continue.

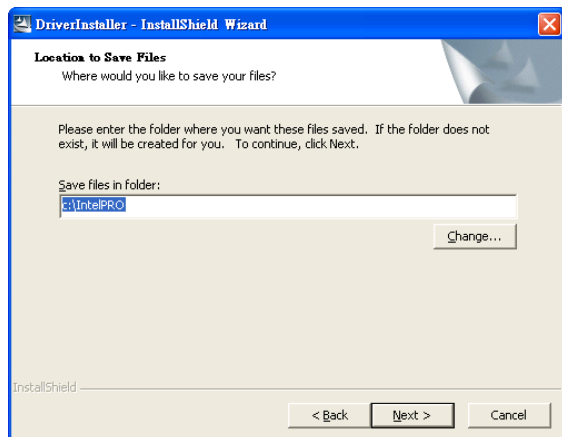

4. Click "Install Software" to start the installation procedure.



5. The driver will be installed automatically and the LAN function will be enabled after the installation.

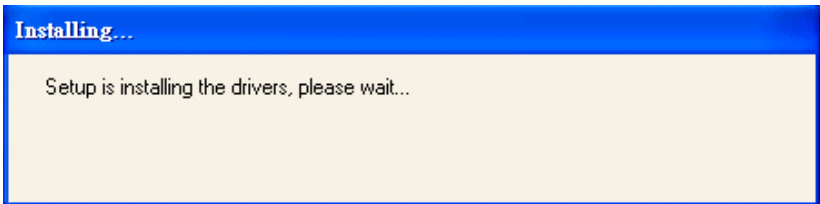

CHAPTER **7**

**Onboard Security
Setup**

Chapter 7 Onboard Security Setup

7.1 Introduction

The AIMB-742's hardware monitor is designed with Winbond W83627HF. Onboard security (OBS) functions monitor key hardware. They help you maintain your system's stability and durability. The AIMB-742 can monitor 5 sets of system positive voltages, 2 sets of system negative voltages, CPU cooling fan speed, and CPU temperature. The positive system voltage sets which can be monitored include:

- CPU core voltage: 1.3 V ~ 3.3 V, according to Intel specifications.
- Transmission voltage from CPU to chipset: typically 1.8 V.
- Chipset voltage: typically 3.3 V.
- Main voltage: +5 V, +12 V.

The negative system voltage sets which can be monitored include:

- Main voltage: -5 V, -12 V.

7.2 Windows XP Driver Setup

1. Insert the driver CD into your system's CD-ROM drive. In a few seconds, the software installation main menu appears, as shown in the following figure. Click on the "Install" button under the "OBS DRIVERS" heading.

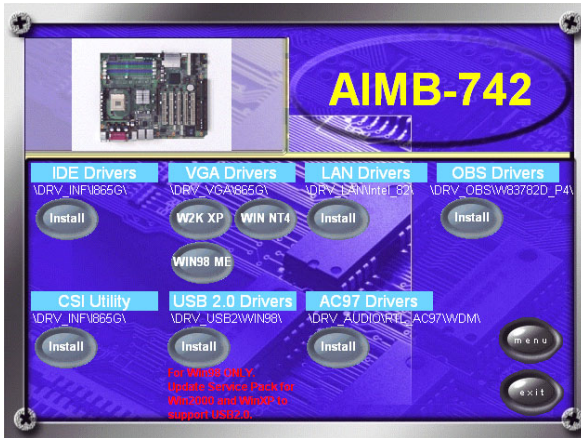

2. Click "Next" when you see the following message.

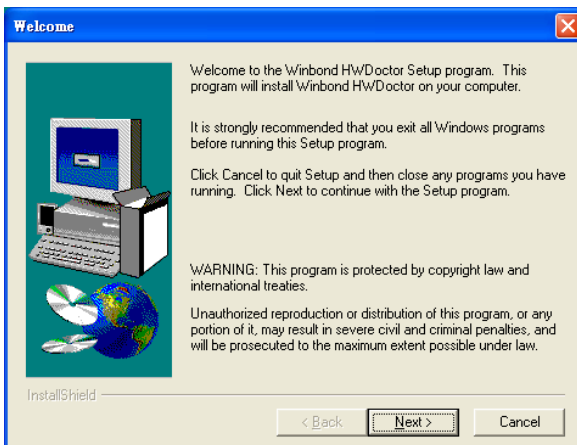

3. Click "Next" when you see the following message.

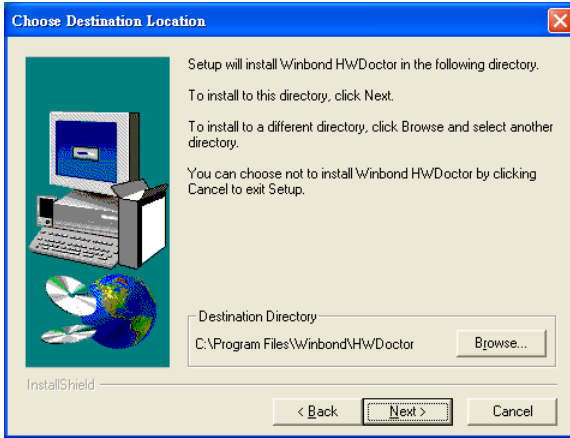

4. Click "Next" when you see the following message.



5. Click "Next" to continue.

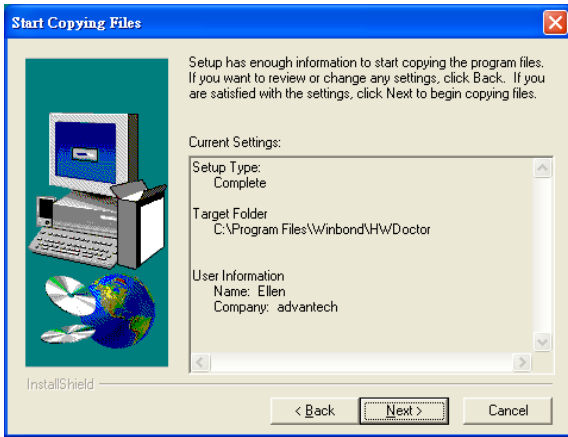

6. Click "Finish" when you see the following message.

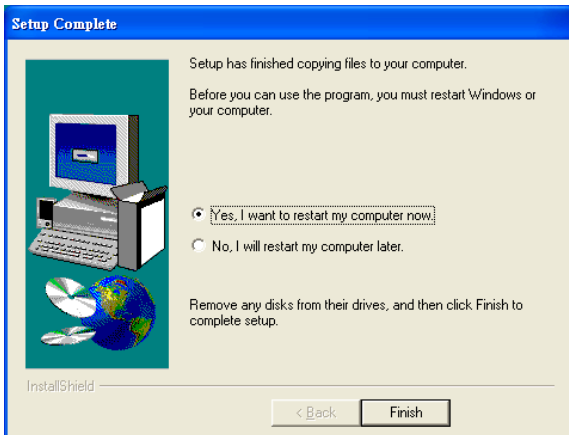

7.3 Using the OBS Hardware Doctor Utility

After completing the setup, all the OBS functions are permanently enabled. When a monitored reading exceeds safe limits, a warning message will be displayed and an error beep tone will activate to attract your attention.

OBS Hardware Doctor will show an icon on the right side of the bottom window bar. This icon is the "Terminate and Stay Resident" (TSR) icon. It will permanently remain in the bottom window bar, and will activate warning signals when triggered by the onboard security system.

You can view or change values for various OBS settings by running this utility:

1. From the desktop of Windows, click on "Start" and select "Programs", select "Winbond HWDdoctor" and click "HWDDOCTOR."
2. It is recommended that you load the default values for all the OBS settings. However, if desired, you can establish new conditions for voltage, fan speed, and temperature.

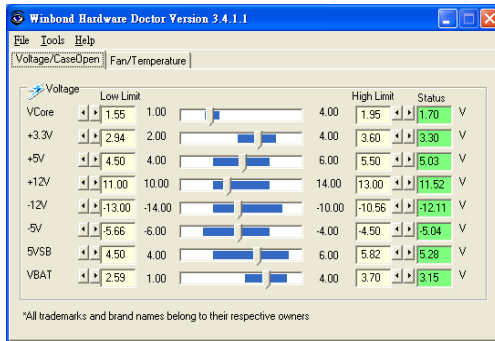

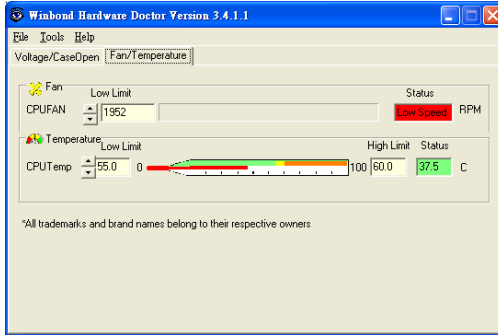

Appendix

A

Programming the Watchdog Timer

Appendix A Programming the watchdog timer

A.1 Programming the Watchdog Timer

The AIMB-742's watchdog timer can be used to monitor system software operation and take corrective action if the software fails to function after the programmed period. This section describes the operation of the watchdog timer and how to program it.

A.1.1 Watchdog timer overview

The watchdog timer is built-in the super I/O controller W83627HF. It provides the following functions for user programming:

- Can be enabled and disabled by user's program.
- Timer can be set from 1 to 255 seconds or 1 to 255 minutes.
- Generates an interrupt or resets signal if the software fails to reset the timer after time-out.

A.1.2 Reset/ Interrupt selection

The J2 jumper is used to select reset or interrupt (IRQ 11) in the event the watchdog timer is tripped. See Chapter 1 for detailed jumper settings.

Note: The interrupt output of the watchdog timer is a low level signal. It will be held low until the watchdog timer is reset.

A.1.3 Programming the Watchdog Timer

The I/O port address of the watchdog timer is 2E(hex) and 2F(hex).

2E (hex) is the address port. 2F(hex) is the data port.

You must first assign the address of register by writing address value into address port 2E(hex), then write/read data to/from the assigned register through data port 2F (hex).

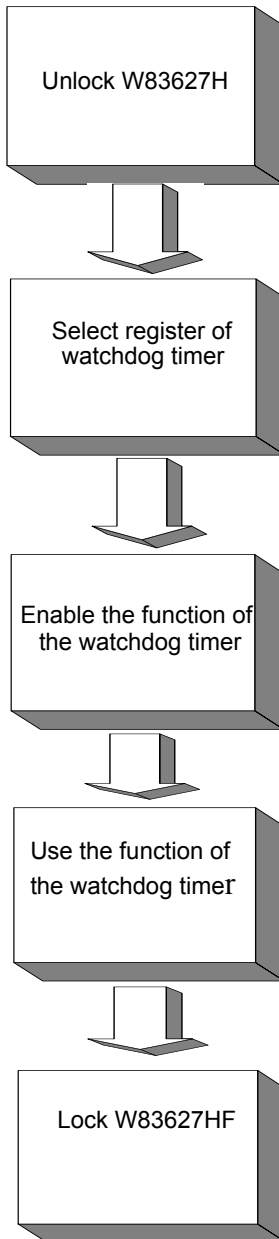

Watchdog Timer Registers		
Address of register (2E)	Attribute	
Read/Write	Value (2F) and description	
87 (hex)	----	Write this address to I/O address port 2E (hex) twice to unlock theW83627HF
07 (hex)	write	Write 08 (hex) to select register of watchdog timer.
30 (hex)	write	Write 01 (hex) to enable the function of the watchdog timer. Disabled is set as default.
F5 (hex)	write	Set seconds or minutes as units for the timer.
Write 0 to bit 3: set second as counting unit. [default]		
Write 1 to bit 3: set minute as counting unit		
F6 (hex)	write	0: stop timer [default] 01~FF (hex): The amount of the count, in seconds or minutes, depends on the value set in register F5 (hex). This number decides how long the watchdog timer waits for strobe before generating an interrupt or reset signal. Writing a new value to this register can reset the timer to count with the new value.

F7 (hex)	read/write	Bit 6: Write 1 to enable keyboard to reset the timer, 0 to disable.[default] Bit 5: Write 1 to generate a timeout signal immediately and automatically return to 0. [default=0] Bit 4: Read status of watchdog timer, 1 means timer is "time out".
AA (hex)	----	Write this address to I/O port 2E (hex) to lock the watchdog timer.2

Table A.1: Watchdog timer registers

A.1.4 Example Program

1. Enable watchdog timer and set 10 sec. as timeout interval

```

;-----
Mov dx,2eh                ; Unlock W83627HF
Mov al,87h
Out dx,al
Out dx,al
;-----
Mov al,07h                ; Select registers of watchdog timer
Out dx,al
Inc dx
Mov al,08h
Out dx,al
;-----
Dec dx                    ; Enable the function of watchdog timer
Mov al,30h
Out dx,al
Inc dx
Mov al,01h
Out dx,al

```

```

;-----
Dec dx          ; Set second as counting unit
Mov al,0f5h
Out dx,al
Inc dx
In al,dx
And al,not 08h
Out dx,al

```

```

;-----
Dec dx          ; Set timeout interval as 10 seconds and start counting
Mov al,0f6h
Out dx,al
Inc dx
Mov al,10
Out dx,al

```

```

;-----
Dec dx          ; lock W83627HF
Mov al,0aah
Out dx,al

```

2. Enable watchdog timer and set 5 minutes as timeout interval

```

;-----
Mov dx,2eh      ; unlock W83627H
Mov al,87h
Out dx,al
Out dx,al

```

```

;-----
Mov al,07h      ; Select registers of watchdog timer
Out dx,al
Inc dx
Mov al,08h
Out dx,al

```

```

;-----
Dec dx          ; Enable the function of watchdog timer
Mov al,30h
Out dx,al
Inc dx
Mov al,01h
Out dx,al

```

```

;-----
Dec dx          ; Set minute as counting unit
Mov al,0f5h
Out dx,al
Inc dx
In al,dx
Or al,08h
Out dx,al

```

```

;-----
Dec dx          ; Set timeout interval as 5 minutes and start counting
Mov al,0f6h
Out dx,al
Inc dx
Mov al,5
Out dx,al

```

```

;-----
Dec dx          ; lock W83627HF
Mov al,0aah
Out dx,al

```

3. Enable watchdog timer to be reset by mouse

```

;-----
Mov dx,2eh      ; unlock W83627H
Mov al,87h
Out dx,al

```

```

Out dx,al
;-----
Mov al,07h      ; Select registers of watchdog timer
Out dx,al
Inc dx
Mov al,08h
Out dx,al
;-----
Dec dx          ; Enable the function of watchdog timer
Mov al,30h
Out dx,al
Inc dx
Mov al,01h
Out dx,al
;-----
Dec dx          ; Enable watchdog timer to be reset by mouse
Mov al,0f7h
Out dx,al
Inc dx
In al,dx
Or al,80h
Out dx,al
;-----
Dec dx          ; lock W83627HF
Mov al,0aah
Out dx,al
4. Enable watchdog timer to be reset by keyboard
;-----
Mov dx,2eh      ; unlock W83627H
Mov al,87h
Out dx,al

```



```

Out dx,al
;-----
Mov al,07h      ; Select registers of watchdog timer
Out dx,al
Inc dx
Mov al,08h
Out dx,al
;-----
Dec dx          ; Enable the function of watchdog timer
Mov al,30h
Out dx,al
Inc dx
Mov al,01h
Out dx,al
;-----
Dec dx          ; Enable watchdog timer to be strobed reset by keyboard
Mov al,0f7h
Out dx,al
Inc dx
In al,dx
Or al,40h
Out dx,al
;-----
Dec dx          ; lock W83627HF
Mov al,0aah
Out dx,al
5.   Generate a time-out signal without timer counting
;-----
Mov dx,2eh     ; unlock W83627H
Mov al,87h
Out dx,al

```

```

Out dx,al
;-----
Mov al,07h      ; Select registers of watchdog timer
Out dx,al
Inc dx
Mov al,08h
Out dx,al
;-----
Dec dx          ; Enable the function of watchdog timer
Mov al,30h
Out dx,al
Inc dx
Mov al,01h
Out dx,al
;-----
Dec dx          ; Generate a time-out signal
Mov al,0f7h
Out dx,al      ; Write 1 to bit 5 of F7 register
Inc dx
In al,dx
Or al,20h
Out dx,al
;-----
Dec dx          ; lock W83627HF
Mov al,0aah
Out dx,al

```

Appendix

B

I/O Pin Assignments

Appendix B Pin Assignments

B.1 IDE Hard Drive Connector (CN1, CN2)

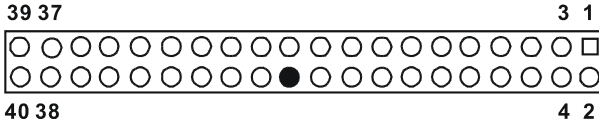

Table B.1: IDE hard drive connector (CN1, CN2)

Pin	Signal	Pin	Signal
1	IDE RESET*	2	GND
3	DATA 7	4	DATA 8
5	DATA 6	6	DATA 9
7	DATA 5	8	DATA 10
9	DATA 4	10	DATA 11
11	DATA 3	12	DATA 12
13	DATA 2	14	DATA 13
15	DATA 1	16	DATA 14
17	DATA 0	18	DATA 15
19	SIGNAL GND	20	N/C
21	DISK DMA REQUEST	22	GND
23	IO WRITE	24	GND
25	IO READ	26	GND
27	IO CHANNEL READY	28	CSEL
29	HDACKO*	30	GND
31	IRQ14	32	IDSC16-
33	ADDR 1	34	PDIAG
35	ADDR 0	36	ADDR 2
37	HARD DISK SELECT 0*	38	HARD DISK SELECT 1*
39	IDE ACTIVE*	40	GND

* low active

B.2 Floppy Drive Connector (CN3)

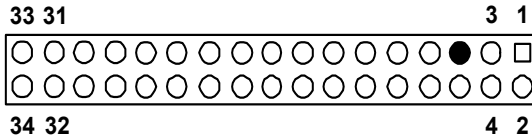

Table B.2: Floppy drive connector (CN3)

Pin	Signal	Pin	Signal
1	GND	2	FDHDIN*
3	GND	4	N/C
5	N/C	6	FDEDIN*
7	GND	8	INDEX*
9	GND	10	MOTOR 0*
11	GND	12	DRIVE SELECT 1*
13	GND	14	DRIVE SELECT 0*
15	GND	16	MOTOR 1*
17	GND	18	DIRECTION*
19	GND	20	STEP*
21	GND	22	WRITE DATA*
23	GND	24	WRITE GATE*
25	GND	26	TRACK 0*
27	GND	28	WRITE PROTECT*
29	GND	30	READ DATA*
31	GND	32	HEAD SELECT*
33	GND	34	DISK CHANGE*

* low active

B.3 Parallel Port Connector (CN4)

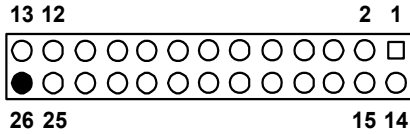

Table B.3: Parallel port connector (CN4)

Pin	Signal	Pin	Signal
1	STROBE*	14	AUTOFD*
2	D0	15	ERR
3	D1	16	INIT*
4	D2	17	SLCTINI*
5	D3	18	GND
6	D4	19	GND
7	D5	20	GND
8	D6	21	GND
9	D7	22	GND
10	ACK*	23	GND
11	BUSY	24	GND
12	PE	25	GND
13	SLCT	26	N/C

* low active

B.4 USB Connector (CN6 and CN63)

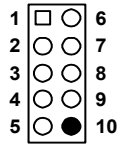

Table B.4: USB1/USB2 connector (CN6 and CN63)

Pin	USB1 Signal	Pin	USB2 Signal
1	+5 V	6	+5 V
2	UV-	7	UV-
3	UV+	8	UV+
4	GND	9	GND
5	Chassis GND	10	N/CA

B.5 VGA Connector (CN7)

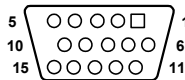

Table B.5: VGA connector (CN7)

Pin	Signal	Pin	Signal
1	RED	9	VCC
2	GREEN	10	GND
3	BLUE	11	N/C
4	N/C	12	SDT
5	GND	13	H-SYNC
6	GND	14	V-SYNC
7	GND	15	SCK

B.6 COM1/COM2 RS-232 Serial Port (CN9, CN10)

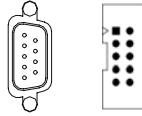

Table B.6: COM1/2 RS-232 serial port (CN9/10)

Pin	Signal
1	DCD
2	RXD
3	TXD
4	DTR
5	GND
6	DSR
7	RTS
8	CTS
9	RI

B.7 Keyboard and Mouse Connector (CN11)



Table B.7: Keyboard and mouse connector (CN11)

Pin	Signal
1	KB DATA
2	N/C
3	GND
4	KB VCC
5	KB CLK
6	N/C

B.8 External Keyboard Connector (CN12)

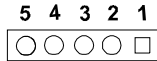
**Table B.8: External keyboard connector (CN12)**

Pin	Signal
1	CLK
2	DATA
3	NC
4	GND
5	VCC

B.9 CPU/System Fan Power Conn (CN14/15/37)



Table B.9: CPU/System Fan Power Conn (CN14/15/37)

Pin	Signal
1	GND
2	+12V
3	Detect

B.10 Power LED (CN16)

You can use an LED to indicate when the motherboard is on. Pin 1 of CN16 supplies the LED's power, and Pin 3 is the ground.

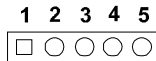

Table B.10: Power LED and keylock conn (CN16)

Pin	Function
1	LED power (+5 V)
2	NC
3	GND
4	NC
5	GND

B.11 External Speaker Connector (CN17)

The motherboard has its own buzzer. You can also connect it to the external speaker on your computer chassis.

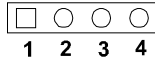

Table B.11: External Speaker Connector (CN17)

Pin	Function
1	Buzzer
2	NC
3	Buzzer
4	Speaker out

B.12 Reset Connector (CN18)



Table B.12: Reset connector (CN18)

Pin	Signal
1	RESET
2	GND

B.13 HDD LED Connector (CN19)



Table B.13: HDD LED connector (CN19)

Pin	Signal
1	VCC (LED+)
2	IDE LED (LED-)

B.14 ATX Soft Power Switch (CN21)



Table B.14: ATX soft power switch (CN21)

Pin	Signal
1	5VSB
2	PWR-BTN

B.15 H/W Monitor Alarm (CN22)

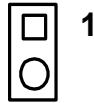

Table B.15: H/W monitor alarm (CN22)

Pin	Signal
1	Enable OBS alarm
2	Disable OBS alarm

B.16 SM Bus Connector (CN29)

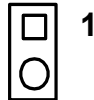

Table B.16: SM Bus Connector (CN 29)

Pin	Signal
1	SMB_DATA
2	SMB_CLK

B.17 USB/LAN ports (CN31 and CN32)

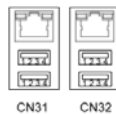

Table B.17: USB port

Pin	Signal	Pin	Signal
1	VCC	3	Data0+
2	Data0-	4	GND

Table B.18: Ethernet 10/100Base-T RJ-45 port

Pin	Signal	Pin	Signal
1	XMT+	5	N/C
2	XMT-	6	RCV-
3	RCV+	7	N/C
4	N/C	8	N/C

B.18 CF socket (CN44)

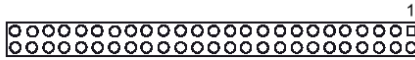

CN44

Table B.19: CF socket (CN44)

Pin	Signal	Pin	Signal
1	GND	26	#CD1
2	D03	27	D11
3	D04	28	D12
4	D05	29	D13
5	D06	30	D14
6	D07	31	D15
7	#CS1	32	#CS1
8	A10	33	#VS1
9	ATA SEL	34	#IORD
10	A09	35	#IOWR
11	A08	36	#WE
12	A07	37	INTRQ
13	VCC	38	VCC
14	A06	39	#CSEL
15	A05	40	#VS2
16	A04	41	#RESET
17	A03	42	IORDY
18	A02	43	#INPACK
19	A01	44	#REG
20	A00	45	#DASP

21	D00	46	#PDIAG
22	D01	47	D08
23	D02	48	D09
24	#IOIS16	49	D10
25	#CD2	50	GND

B.19 Line Out, Mic IN connector (CN55)

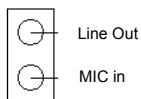

CN55

B.20 Audio input from CD-ROM (CD IN; CN56)

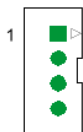

CN56

Table B.20: Audio in from CD-ROM (CD IN; CN56)

Pin	Signal	Pin	Signal
1	CD_L	3	GND
2	GND	4	CD_R

B.21 Aux Line-In connector (AUX IN; CN57)



Table B.21: Aux Line-In connector (AUX IN; CN57)

Pin	Signal	Pin	Signal
1	AUX_L	3	GND
2	GND	4	AUX_R

B.22 Modem-In connector (MDM IN; CN58)



Table B.22: Modem-In connector (MDM IN; CN58)

Pin	Signal	Pin	Signal
1	PHONE_IN	3	GND
2	GND	4	MONOOUT

B.23 Front Panel audio connector (FP AUDIO; CN59)

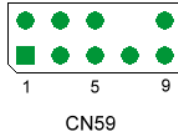

Table B.23: Front audio conn (FP AUDIO; CN59)

Pin	Signal	Pin	Signal
1	MIC	6	LOUT_RR
2	GND	7	NC
3	MIC_BIAS	8	NC
4	VCC	9	LOUT_L
5	LOUT_R	10	LOUT_LL

B.24 Case Open Connector (CN64)



Table B.24: Case Open Connector (CN64)

Pin	Signal
1	CASEOP
2	GND

B.25 8-pin Alarm Board Connector (CN62)



CN62

Table B.25: 8-pin Alarm Board Connector (CN62)

Pin	Signal	Pin	Signal
1	5VSB	5	VCC
2	GND	6	VCC3
3	GND	7	-12V
4	-5V	8	+12V

B.26 System I/O Ports

Table B.26: System I/O ports

Addr. range (Hex)	Device
000-01F	DMA controller
020-021	Interrupt controller 1, master
022-023	Chipset address
040-05F	8254 timer
060-06F	8042 (keyboard controller)
070-07F	Real-time clock, non-maskable interrupt (NMI) mask
080-09F	DMA page register
0A0-0BF	Interrupt controller 2
0C0-0DF	DMA controller
0F0	Clear math co-processor
0F1	Reset math co-processor
0F8-0FF	Math co-processor

1F0-1F8	Fixed disk
200-207	Game I/O
278-27F	Parallel printer port 2 (LPT3)
290-297	On-board hardware monitor
2F8-2FF	Serial port 2
300-31F	Prototype card
360-36F	Reserved
378-37F	Parallel printer port 1 (LPT2)
380-38F	SDLC, bisynchronous 2
3A0-3AF	Bisynchronous 1
3B0-3BF	Monochrome display and printer adapter (LPT1)
3C0-3CF	Reserved
3D0-3DF	Color/graphics monitor adapter
3F0-3F7	Diskette controller
3F8-3FF	Serial port 1

B.27 DMA Channel Assignments

Table B.27: DMA channel assignments

Channel	Function
0	Available
1	Available
2	Floppy disk (8-bit transfer)
3	Available
4	Cascade for DMA controller 1
5	Available
6	Available
7	Available

B.28 Interrupt Assignments

Table B.28: Interrupt assignments

Priority	Interrupt#	Interrupt source
1	NMI	Parity error detected
2	IRQ0	Interval timer
3	IRQ1	Keyboard
-	IRQ2	Interrupt from controller 2 (cascade)
4	IRQ8	Real-time clock
5	IRQ9	Cascaded to INT 0A (IRQ 2)
6	IRQ10	Available
7	IRQ11	Available
8	IRQ12	PS/2 mouse
9	IRQ13	INT from co-processor
10	IRQ14	Primary IDE Channel
11	IRQ15	Secondary IDE Channel
12	IRQ3	Serial communication port 2
13	IRQ4	Serial communication port 1
14	IRQ5	Parallel port 2
15	IRQ6	Diskette controller (FDC)
16	IRQ7	Parallel port 1 (print port)

B.29 1st MB Memory Map

Table B.29: 1st MB memory map

Addr. range (Hex)	Device
E0000h - FFFFFh	BIOS
CC000h - DFFFFh	Unused
C0000h - CBFFFh	VGA BIOS
A0000h - BFFFFh	Video Memory
00000h - 9FFFFh	Base memory

B.30 PCI Bus Map

Table B.30: PCI bus map (for VE, E2 version)

Function Signals:	Device ID	INT# pin	GNT	REQ
Onboard LAN1	--	INT E	--	--
Onboard LAN2	AD26	INT H	GNT F	REQ F
Bridge	AD22		GNT E	REQ E
PCI slot 1	AD31	INT B, C, D, A	GNT A	REQ A
PCI slot 2	AD30	INT C, D, A, B	GNT B	REQ B
PCI slot 3	AD29	INT D, A, B, C	GNT 1	REQ 1
PCI slot 4	AD28	INT A, B, C, D	GNT 2	REQ 2
PCI slot 5	AD27	INT B, C, D, A	GNT 3	REQ 3

Table B.31: PCI bus map (for VG, G2 version)

Function Signals:	Device ID	INT# pin	GNT	REQ
Onboard LAN2	AD26	INT H	GNT F	REQ F
Bridge	AD22		GNT E	REQ E
PCI slot 1	AD31	INT B, C, D, A	GNT A	REQ A
PCI slot 2	AD30	INT C, D, A, B	GNT B	REQ B
PCI slot 3	AD29	INT D, A, B, C	GNT 1	REQ 1
PCI slot 4	AD28	INT A, B, C, D	GNT 2	REQ 2
PCI slot 5	AD27	INT B, C, D, A	GNT 3	REQ 3

