

AI6NFK/KP6
Pentium II Baby AT Motherboard
User's Manual
Version 1.0

0Contents

Chapter 1	Introduction.....
Chapter 2	Specifications.....
Chapter 3	Hardware Description.....
3.1	Processor.....
3.2	L2 Cache.....
3.3	Main Memory.....
3.4	BIOS.....
3.5	I/O Port Address Map.....
3.6	DMA Channels.....
3.7	Interrupt Request (IRQ) Lines.....
3.8	Onboard PCI-IDE.....
3.9	Onboard Multi-I/O.....
Chapter 4	Configuring the Motherboard.....
4.1	CPU Frequency: DSW1, DSW2.....
4.2	Clear CMOS Selection: JP8.....	14
Chapter 5	Installation.....	15
5.1	I/O connectors.....	17
5.2	J2, J8: AT Keyboard and PS/2 Mouse Connector.....	17
5.3	J4: AT Power Supply Connector.....	18
5.4	J5: ATX Power Supply Connector.....	18
5.5	J6: Parallel Port Connector.....	19
5.6	J7: Floppy Drive Connector.....	19
5.7	J9, J10: Serial Ports.....	20
5.8	J11, J12: EIDE Connectors.....	20
5.9	J13, J14: USB Connectors.....	21
5.10	J24: IrDA Connector.....	21
5.11	J25: Front Bezel Connectors.....	22
5.12	J26: CPU Fan Connector.....	24
5.13	JP1: ATX Power On/Off Switch.....	24

Chapter 6 BIOS and System Setup.....	
6.1 Invoking the System Setup Program.....	
6.2 Running the Setup.....	
6.3 Setup Main Menu.....	
6.4 Standard Setup Menu.....	
6.5 Advanced Setup Menu.....	
6.6 Chipset Setup Menu.....	
6.7 Power Management Setup.....	
6.8 PCI/PnP Setup Menu.....	
6.9 Peripheral Setup Menu.....	
6.10 Password.....	
6.11 Anti-Virus.....	
Appendix	50
A. Slot 1 Retention Mechanism and KP6 CPU module	50

Chapter 1 Introduction

This manual is designed to give you information on the AI6NFK/KP6 motherboard. It is divided into the following six sections:

- **Introduction**
- **Specifications**
- **Hardware Description**
- **Configuring the Motherboard**
- **Installation**
- **BIOS and System Setup**

Checklist

Please check that your package is complete and contains the items below. If you discover damaged or missing items, please contact your dealer.

- ◆ The AI6NFK/KP6 Motherboard
- ◆ This User 僣 Manual
- ◆ 1 IDE Ribbon Cable
- ◆ 1 Floppy Ribbon Cable
- ◆ 2 Serial Ribbon Cables*
- ◆ 1 Parallel Ribbon Cable
- ◆ 1 Diskette Containing Intel PCI Driver and Flash Memory Utility

* Use the two serial cables supplied to avoid possible compatibility problems.

Chapter 2 Specifications

The AI6NFK/KP6 is a high-performance Baby AT PCI motherboard with a SLOT1 CPU socket for next-generation processors. It offers flexibility in terms of CPU frequency and main memory type and size. The main features of the motherboard consist of the following:

Processor

KP6 CPU module with Socket 8 for Intel Pentium Pro running 150/166/180/200MHz

Processor Upgrade

Intel Pentium II processor running 233/266/300MHz

CPU Socket

Slot 1

L2 Cache

CPU integrated L2 cache

CPU Voltage

Switching voltage regulator on board supporting multiple voltage ranging 1.8V-3.5V

Main Memory

Six 72-pin SIMMs of 4MB, 8MB, 16MB, 32MB, 64MB to form a memory size between 8MB to 384MB. Supports Fast Page Mode (FPM) and Extended Data Output (EDO) DRAM

Chipset

Intel 82440FX with built-in PCI-IDE

BIOS

AMIBIOS with ISA Plug and Play (PnP) extension, DMI, bootable CD-ROM and power-management features

Power Connector

Standard AT Power Connector and ATX Power Connector

PCI Bus Master IDE Controller

Onboard PCI Bus Master IDE controller with two connectors for up to four IDE devices in two channels, supporting faster data transfer rates, Enhanced IDE devices such as Tape Backup and CD-ROM drives, PIO Mode 3/4 and Bus Master IDE

Super I/O

Onboard super I/O is an SMC 37C669 SIO that provides:

- Two 16550 UART compatible serial ports
- One parallel port (ECP/EPP compatible)
- One floppy controller (2.88MB compatible)
- One IrDA port

Mouse Connector

PS/2 Type

Keyboard Connector

AT type

USB Connector

2 ports, onboard headers

IrDA Connector

Onboard 5-pin header

Win95-shut-off (ATX power supply only)

Allows shut-off control from within Windows 95

Modem-ring-on (ATX power supply only)

Supports Modem-ring-on capability through an external modem connected to COM1 or COM2.

DMI BIOS Support

Desktop Management Interface (DMI) allows users to download system hardware-level information such as CPU type, CPU speed, internal/external frequencies and memory size.

Expansion Slots

- Four PCI slots
- Four ISA slots

Form Factor

Baby AT (13x 8.6)

Chapter 3 Hardware Description

This chapter briefly describes each of the major features of the AI6NFK/KP6 motherboard. The layout of the board in Figure 1 shows the location of the key components. The topics covered in this chapter are as follows:

- 3.1 Processor.....
- 3.2 L2 Cache.....
- 3.3 Main Memory.....
- 3.4 BIOS.....
- 3.5 I/O Port Address Map.....
- 3.6 DMA Channels.....
- 3.7 Interrupt Request (IRQ) Lines.....
- 3.8 Onboard PCI-IDE.....
- 3.9 Onboard Multi-I/O.....
-

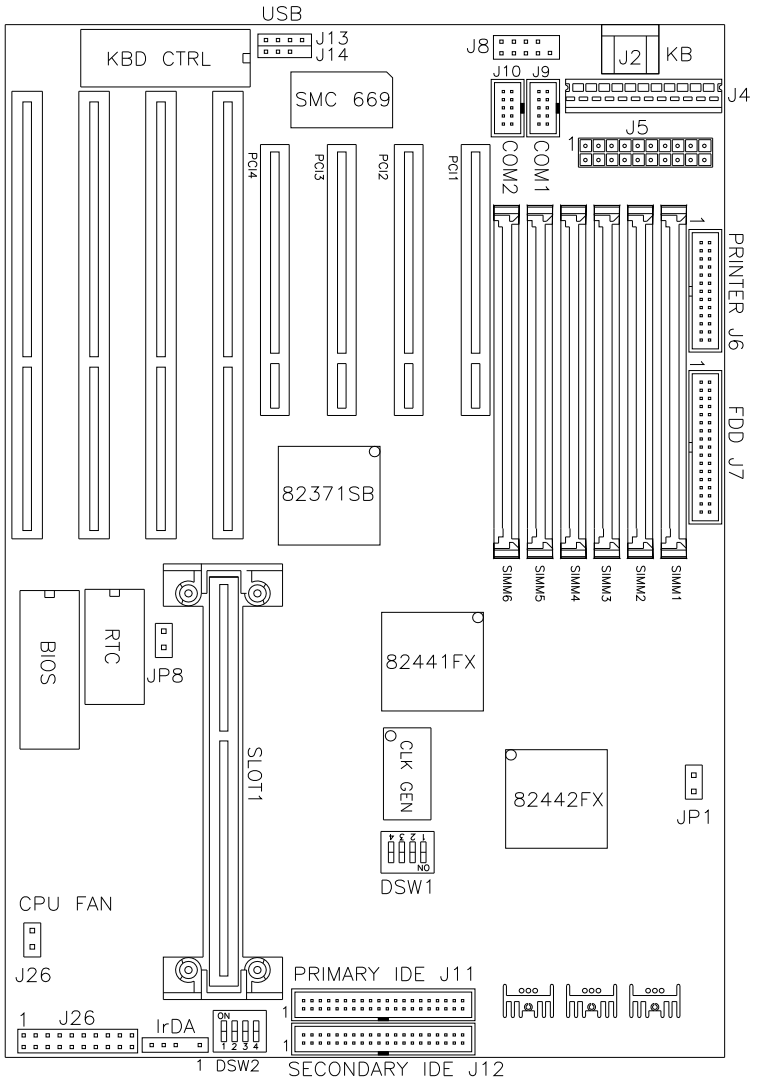

Figure 1: Layout of the AI6NFK/KP6 Motherboard

3.1 Processor

The AI6NFK/KP6 motherboard is designed to take a Pentium Pro running at 180MHz/200MHz on a KP6 CPU module or a Pentium II processor running 233MHz/266MHz. The KP6 module is compatible with the Slot 1 connector of the AI6NFK/KP6 that provides an upgrade path to the Pentium II processor. To upgrade, just replace the KP6 CPU module with the Pentium II processor.

3.2 L2 Cache

The L2 cache, 256KB or 512KB, is integrated into the Pentium Pro / Pentium II CPU. The private L2 cache bus is not connected to package pins, rather its signals are routed between the two cavities using standard package techniques. It can be driven at full CPU core speed. The high-performance bandwidth is used by the CPU to serve all L1 cache misses, the characteristic of a CPU-cache bus, and is utilized 90-95 percent of the time.

3.3 Main Memory

The AI6NFK/KP6 provides three 64-bit memory banks for up to 384MB of main memory. Each bank consists of two SIMMs, **SIMM1/SIMM2**, **SIMM3/SIMM4** and **SIMM5/SIMM6**. Burst Extended Data Output (BEDO), Extended Data Output (EDO) and Fast Page Mode DRAM are supported. The size of the SIMM can be 4MB, 8MB, 16MB, 32MB and 64MB, and can be configured to support ECC (Error Checking and Correction) or parity checking.

The following are to be noted in populating the SIMM sockets:

1. Either SIMM1/SIMM2 or SIMM3/SIMM4 or SIMM5/SIMM6 bank can be populated first.
2. Each bank should consist of the same size of SIMMs.
3. Each bank should consist of the same type of SIMMs, i.e. SIMM1 and SIMM2 should be BEDO, EDO or page mode.
4. SIMMs can be mixed by the bank. For example, SIMM1/SIMM2 are Page Mode and SIMM3/SIMM4 are EDO.
5. SIMMs can be with or without parity. If you need ECC or parity support, you need to use SIMMs with parity bits.

Available memory configurations are shown in the following table:

Bank 0	Bank 1	Bank 2	Total Memory
4MB×2	----	----	8MB
8MB×2	----	----	16MB
16MB×2	----	----	32MB
32MB×2	----	----	64MB
4MB×2	4MB×2	----	16MB
4MB×2	4MB×2	4MB×2	24MB
4MB×2	8MB×2	----	24MB
4MB×2	8MB×2	8MB×2	40MB
4MB×2	16MB×2	----	40MB
4MB×2	16MB×2	16MB×2	72MB
4MB×2	32MB×2	----	72MB
4MB×2	32MB×2	32MB×2	136MB
8MB×2	8MB×2	----	32MB
8MB×2	8MB×2	8MB×2	48MB
8MB×2	16MB×2	----	48MB
8MB×2	16MB×2	16MB×2	80MB
8MB×2	32MB×2	----	80MB
8MB×2	32MB×2	32MB×2	144MB
16MB×2	16MB×2	----	64MB
16MB×2	16MB×2	16MB×2	96MB
16MB×2	32MB×2	----	96MB
16MB×2	32MB×2	32MB×2	160MB
32MB×2	32MB×2	----	128MB
32MB×2	32MB×2	32MB×2	192MB
64MB×2	64MB×2	----	256MB
64MB×2	64MB×2	64MB×2	384MB

Note: Bank 0 designates the memory bank populated first: SIMM1/SIMM2 or SIMM3/SIMM4 or SIMM5/SIMM6.

3.4 BIOS

The BIOS on the AI6NFK/KP6 motherboard provides the standard BIOS functions plus the following additional features:

1. DMI (Desktop Management Interface)

The motherboard supports DMI to enable computer system management in an enterprise.

2. ISA Plug and Play (PnP) Extension

Unlike PCI cards that are Plug and Play, ISA cards require setting jumpers to resolve hardware conflicts. To make a computer system PnP, an ISA PnP standard is established and supported by new operating systems, such as Windows 95. Under Windows 95, the motherboard BIOS must have an ISA PnP extension to support new ISA PnP cards.

3. Power Management

The power management feature provides power savings by slowing down the CPU clock, turning off the monitor screen and stopping the HDD spindle motor. The BIOS fully conforms to APM 1.2 specifications.

3.5 I/O Port Address Map

Each peripheral device in the system is assigned a set of I/O port addresses which also becomes the identity of the device. There is a total of 1K port address space available. The following table lists the I/O port addresses used on the motherboard.

Address	Device Description
000h - 01Fh	DMA Controller #1
020h - 03Fh	Interrupt Controller #1
040h - 05Fh	Timer
060h - 06Fh	Keyboard Controller
070h - 07Fh	Real Time Clock,, NMI
080h - 09Fh	DMA Page Register
0A0h - 0BFh	Interrupt Controller #2
0C0h - 0DFh	DMA Controller #2
0F0h	Clear Math Coprocessor Busy Signal
0F1h	Reset Math Coprocessor
1F0h - 1F7h	IDE Interface
2F8h - 2FFh	Serial Port #2(COM2)

378h - 3Fh	Parallel Port #1(LPT1)
3F0h - 3F7h	Floppy Disk Controller
3F8h - 3Fh	Serial Port #1(COM1)

3.6 DMA Channels

There are seven DMA channels available on the motherboard. Only DRQ2 is used by the floppy controller. In the case that ECP mode on the parallel port is utilized, DRQ1 or DRQ3 will be used.

3.7 Interrupt Request (IRQ) Lines

There is a total of 15 IRQ lines available on the motherboard. Peripheral devices use an interrupt request to notify the CPU for the service required. The following table shows the IRQ lines used by the devices on the motherboard:

<u>Level</u>	<u>Function</u>
IRQ0	System Timer Output
IRQ1	Keyboard
IRQ2	Interrupt Cascade
IRQ8	Real Time Clock
IRQ9	Software Redirected to Int 0Ah
IRQ10	Reserved
IRQ11	Reserved
IRQ12	Reserved
IRQ13	Co-Processor
IRQ14	Primary IDE
IRQ15	Secondary IDE
IRQ3	INTERRUPT
IRQ4	Serial Port #1
IRQ5	INTERRUPT
IRQ6	Floppy Disk Controller
IRQ7	Parallel Port #1

3.8 Onboard PCI-IDE

The PCI-IDE controller is a part of the 82440FX PCIset. It supports PIO mode 3/4 and bus mastering. The peak transfer rate of PIO mode 3/4 can be as high as 17MB/sec. Using HDDs that support bus mastering, the peak transfer rate can reach 22MB/sec. There are two IDE connectors - primary IDE and secondary IDE. With two devices per connector, up to four IDE devices can be supported.

3.9 Onboard Multi-I/O

The onboard multi-I/O chip, SMC37C66X, provides two serial ports, one parallel port and one floppy controller. The serial ports are 16550 UART compatible. The parallel port supports high-speed EPP/ECP mode. The floppy controller supports up to 2.88 MB format.

Chapter 4 Configuring the Motherboard

The following sections describe the necessary procedures and proper jumper settings to configure the AI6NFK/KP6 motherboard. For the locations of the jumpers, refer to Figure 2.

- 4.1.....CPU Frequency: DSW1, DSW2
.....
- 4.2.....Clear CMOS Selection: JP8
.....

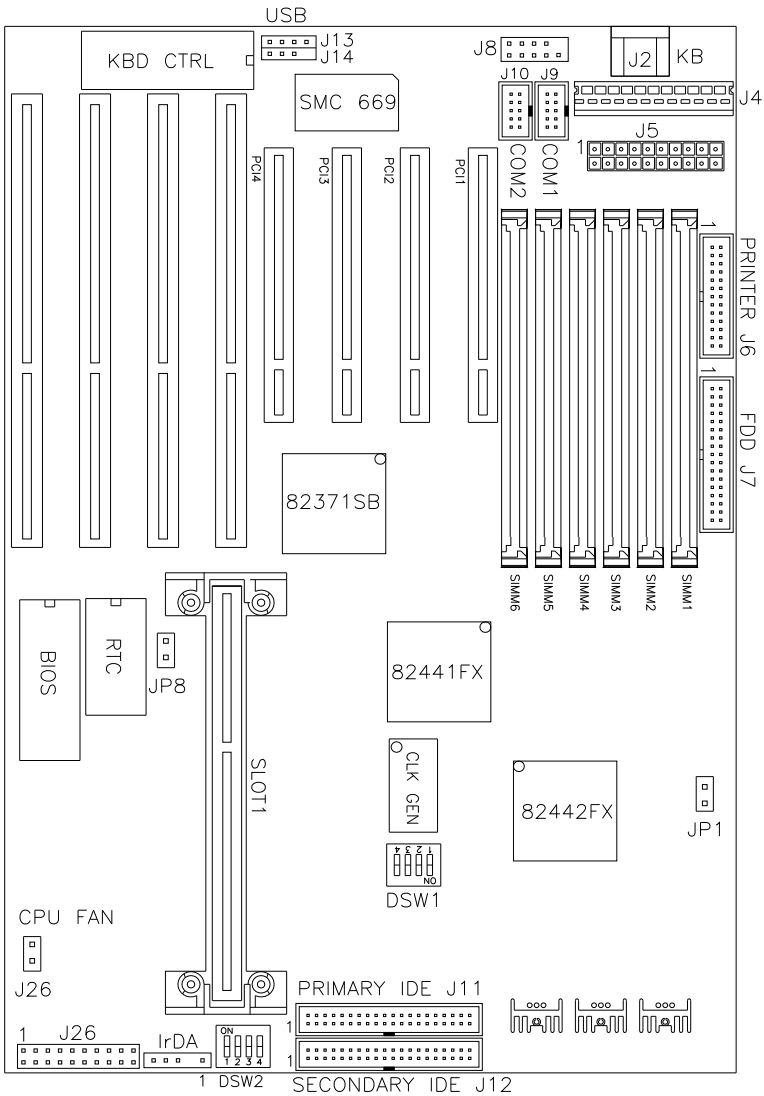



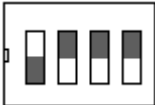





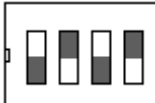





Figure 2: Jumper Location on the AI6NFK/KP6

4.1 CPU Frequency: DSW1, DSW2

DSW1: sets the clock generator frequency to 50, 60 or 66MHz, which is the frequency of the CPU, to the bus clock. **DSW2:** sets the ratio of the bus clock to the CPU internal clock.



Refer to the following table for the correct setting to match the CPU frequency.

Pentium Pro (KP6) CPU FREQ.	DSW1	DSW2
Pentium Pro 150MHz		
Pentium Pro 166MHz		
Pentium Pro 180MHz		
Pentium Pro 200MHz		

Pentium II CPU FREQ.	DSW1	DSW2
Pentium II 233MHz		
Pentium II 266MHz		
Pentium II 300MHz		

4.2 Clear CMOS Selection: JP8

Use JP8, a 2-pin header, to clear the contents of the CMOS RAM. Do not clear the CMOS RAM unless it is absolutely necessary. You will lose your password, etc.

JP8	Function
	Normal
	Clear CMOS

Chapter 5 Installation

This chapter describes the interface that the AI6NFK/KP6 provides for creating a working system. Refer to Figure 3 for the location of the connectors.

The following items are covered in this chapter:

<input type="checkbox"/>	5.1	I/O Connectors.....	17
<input type="checkbox"/>	5.2	J2, J8: AT Keyboard and PS/2 Mouse Connector.....	17
<input type="checkbox"/>	5.3	J4: AT Power Supply Connector.....	18
<input type="checkbox"/>	5.4	J5: ATX Power Supply Connector.....	18
<input type="checkbox"/>	5.5	J6: Parallel Port Connector.....	19
<input type="checkbox"/>	5.6	J7: Floppy Drive Connector.....	19
<input type="checkbox"/>	5.7	J9, J10: Serial Ports.....	20
<input type="checkbox"/>	5.8	J11, J12: EIDE Connectors.....	20
<input type="checkbox"/>	5.9	J13, J14: USB Connectors.....	21
<input type="checkbox"/>	5.10	J24: IrDA Connector.....	21
<input type="checkbox"/>	5.11	J25: Front Bezel Connectors.....	22
<input type="checkbox"/>	5.12	J26: CPU Fan Connector.....	24
<input type="checkbox"/>	5.13	JP1: ATX Power On/Off Switch.....	24
<input type="checkbox"/>			

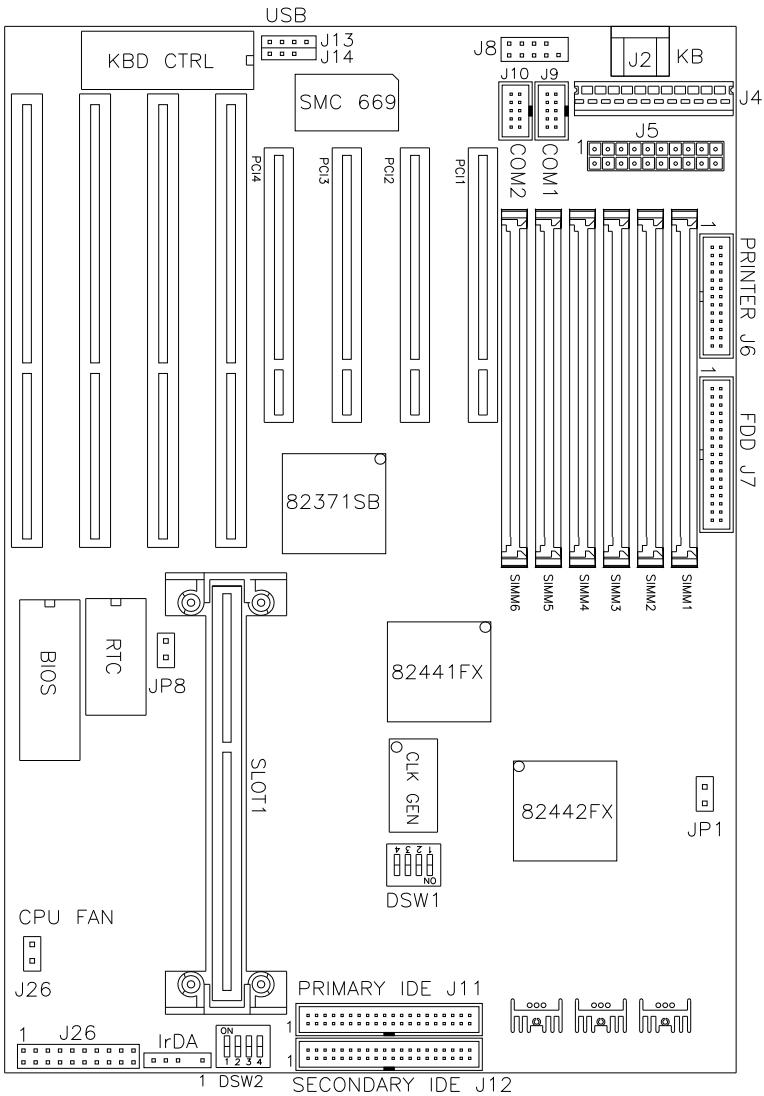

Figure 3: Connector Location on the AI6NFK/KP6

5.1 I/O Connectors

The I/O connectors connect the AI6NFK/KP6 to the most common peripherals. To attach cables to these connectors, carefully align Pin 1 of the cables to that of the connectors. Refer to Figure 4 for the location and orientation of the connectors.

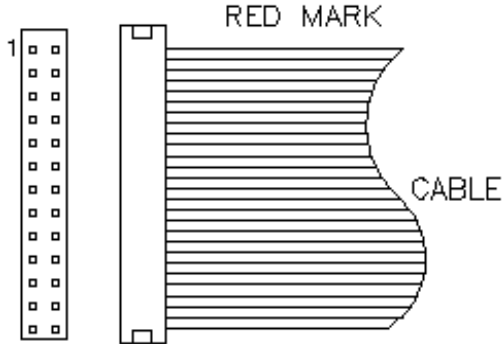
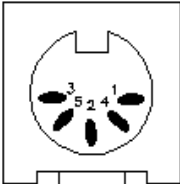

Figure 4: Orientation of the I/O Connector

5.2 J2, J8: AT Keyboard and PS/2 Mouse Connector

J2: AT Keyboard Connector



J2 Pin #	Signal Name
1	Keyboard data
2	N.C.
3	GND
4	5V
5	Keyboard clock
6	N.C.

J8: PS/2 Mouse Connector

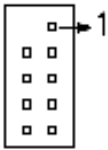

Signal Name	Pin #	Pin #	Signal Name
N.C.	1		
N.C.	3	4	Mouse clock
N.C.	5	6	5V
Mouse data	7	8	N.C.
GND	9	10	N.C.

5.3 J4: AT Power Supply Connector

When using an AT compatible power supply, plug both of the power supply connectors into J4. Make sure the power supply connectors are connected in the right orientation. The power supply connectors are connected in the right orientation if the black wires of each power cable are ADJACENT to each other. That is, black wires of each connector should be aligned in the center of the J4 power supply connector.

J4 Pin #	Description	Wire Color
1	⊖ Power Good	Orange
2	λ +5V	Red
3	λ +12V	Yellow
4	λ -12V	Blue
5	λ Ground	Black
6	λ Ground	Black
7	⊖ Ground	Black
8	λ Ground	Black
9	λ -5V	White
10	λ +5V	Red
11	λ +5V	Red
12	λ +5V	Red

5.4 J5: ATX Power Supply Connector

J5 is a 20-pin ATX power supply connector. Refer to the following table for the pin out assignments.

Signal Name	Pin #	Pin #	Signal Name
-------------	-------	-------	-------------

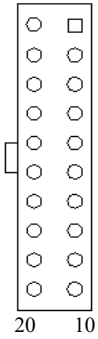

3.3V	11	1	3.3V
-12V	12	2	3.3V
Ground	13	3	Ground
PS-ON	14	4	+5V
Ground	15	5	Ground
Ground	16	6	+5V
Ground	17	7	Ground
-5V	18	8	Power good
+5V	19	9	5VSB
+5V	20	10	+12V

5.5 J6: Parallel Port Connector

The following table describes the pin out assignments of this connector.

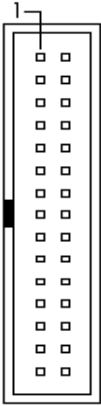

Signal Name	Pin #	Pin #	Signal Name
Line printer strobe	1	14	AutoFeed
PD0, parallel data 0	2	15	Error
PD1, parallel data 1	3	16	Initialize
PD2, parallel data 2	4	17	Select
PD3, parallel data 3	5	18	Ground
PD4, parallel data 4	6	19	Ground
PD5, parallel data 5	7	20	Ground
PD6, parallel data 6	8	21	Ground
PD7, parallel data 7	9	22	Ground
ACK, acknowledge	10	23	Ground
Busy	11	24	Ground
Paper empty	12	25	Ground
Select	13	N/A	N/A

5.6 J7: Floppy Drive Connector

J7 of the AI6NFK/KP6 is a 34-pin header and will support up to 2.88MB floppy drives.

Signal Name	Pin #	Pin #	Signal Name
-------------	-------	-------	-------------

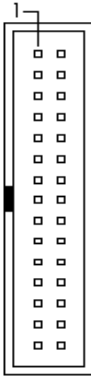

Ground	1	2	RM/LC
Ground	3	4	No connect
Ground	5	6	No connect
Ground	7	8	Index
Ground	9	10	Motor enable 0
Ground	11	12	Drive select 1
Ground	13	14	Drive select 0
Ground	15	16	Motor enable 1
Ground	17	18	Direction
Ground	19	20	Step
Ground	21	22	Write data
Ground	23	24	Write gate
Ground	25	26	Track 00
Ground	27	28	Write protect
Ground	29	30	Read data
Ground	31	32	Side 1 select
Ground	33	34	Diskette change

5.7 J9, J10: Serial Ports

The onboard serial ports of the AI6NFK/KP6 are 10 pin-header connectors. J9 is COM1 and J10 is COM2. The following table shows the pin out of the these connectors.

Pin #	Signal Name
1	DCD, Data carrier detect

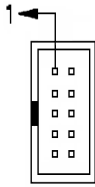

2	RXD, Receive data
3	TXD, Transmit data
4	DTR, Data terminal ready
5	GND, ground
6	DSR, Data set ready
7	RTS, Request to send
8	CTS, Clear to send
9	RI, Ring indicator
10	Not Used

5.8 J11, J12: EIDE Connectors

J11: Primary IDE Connector

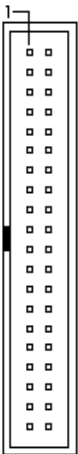

Signal Name	Pin #	Pin #	Signal Name
Reset IDE	1	2	Ground
Host data 7	3	4	Host data 8
Host data 6	5	6	Host data 9
Host data 5	7	8	Host data 10
Host data 4	9	10	Host data 11
Host data 3	11	12	Host data 12
Host data 2	13	14	Host data 13
Host data 1	15	16	Host data 14
Host data 0	17	18	Host data 15

Ground	19	20	Key
DRQ0	21	22	Ground
Host IOW	23	24	Ground
Host IOR	25	26	Ground
IOCHRDY	27	28	Host ALE
DACK0	29	30	Ground
IRQ14	31	32	No connect
Address 1	33	34	No connect
Address 0	35	36	Address 2
Chip select 0	37	38	Chip select 1
Activity	39	40	Ground

J12: Secondary IDE Connector

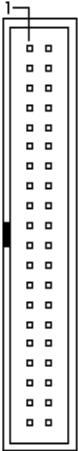

Signal Name	Pin #	Pin #	Signal Name
Reset IDE	1	2	Ground
Host data 7	3	4	Host data 8
Host data 6	5	6	Host data 9
Host data 5	7	8	Host data 10
Host data 4	9	10	Host data 11
Host data 3	11	12	Host data 12
Host data 2	13	14	Host data 13
Host data 1	15	16	Host data 14
Host data 0	17	18	Host data 15
Ground	19	20	Key
DRQ0	21	22	Ground
Host IOW	23	24	Ground
Host IOR	25	26	Ground
IOCHRDY	27	28	Host ALE
DACK1	29	30	Ground
MIRQ0	31	32	No connect
Address 1	33	34	No connect
Address 0	35	36	Address 2
Chip select 0	37	38	Chip select 1
Activity	39	40	Ground

5.9 J13, J14: USB Connectors

J13 (USB1) and J14 (USB2) are the USB connectors. The following table shows the pin outs of these connectors.

J13	J14	J13 Pin #	J14 Pin #	Signal Name
1	1			
2	2			

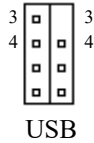

1	1	Vcc
2	2	USB-
3	3	USB+
4	4	Ground

5.10 J24: IrDA Connector

This connector is used for an IrDA connector that supports infrared wireless communication.

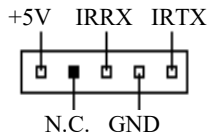

J17 Pin #	Signal Name
1	+5V
2	No connect
3	Ir RX
4	Ground
5	Ir TX

5.11 J25: Front Bezel Connectors

The front bezel of the case has a control panel which provides light indication of the computer activities and switches to change the computer status. J25 is a 20-pin header that provides interfaces for the following functions.

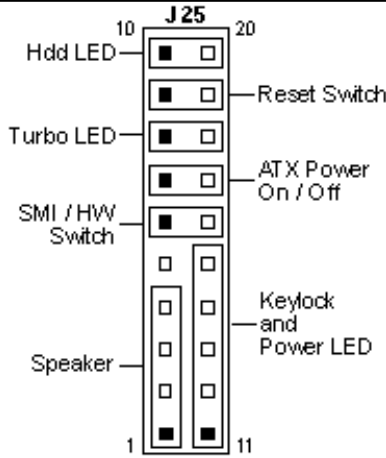

Speaker: Pins 1 - 4

This connector provides an interface to a speaker for audio tone generation. An 8-ohm speaker is recommended.

J25 Pin #	Signal Name
1	Speaker out
2	No connect
3	Ground
4	+5V

Power LED and Keylock: Pins 11 - 15

The power LED indicates the status of the main power switch. The keylock switch, when closed, will disable the keyboard function.

J25 Pin #	Signal Name
11	Power LED
12	No connect
13	Ground
14	Keylock
15	Ground

SMI/Hardware Switch: Pins 6 and 16

This connector supports the "Green Switch" on the control panel, which, when pressed, will force the system board into the power-saving mode immediately.

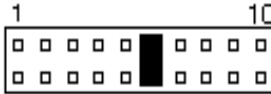

J25 Pin #	Signal Name
6	Sleep
16	Ground

ATX Power ON Switch: Pins 7 and 17

This 2-pin connector is an ATX Power Supply On/Off Switch on the motherboard that connects to the power switch on the case. When pressed, the power switch will force the motherboard to power on. When pressed again, it will force the motherboard to power off.

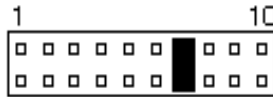

Turbo LED Connector: Pins 8 and 18

There is no turbo/deturbo function on the motherboard. The Turbo LED on the control panel will always be On when attached to this connector.

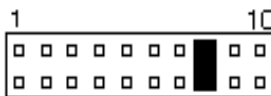

J25 Pin #	Signal Name
8	5V
18	Ground

Reset Switch: Pins 9 and 19

The reset switch allows the user to reset the system without turning the main power switch Off and then On. Orientation is not required when making a connection to this header.

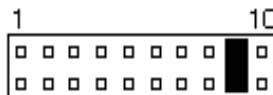

Hard Disk Drive LED Connector: Pins 10 and 20

This connector connects to the hard drive activity LED on control panel. This LED will flash when the HDD is being accessed.

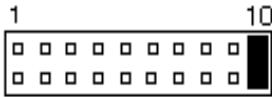

J26 Pin #	Signal Name
10	Ground
20	5V

5.12 J26: CPU Fan Power Connector

J26 is a 2-pin connector for a CPU fan. The fan must be a 12V fan.

J26 Pin #	Signal Name
1	+12V
2	Ground

5.13 JP1: ATX Power On/Off Switch

This 2-pin connector is also an ATX Power Supply On/Off Switch on the motherboard which has a similar function as J25 pin 7 and 17. When pressed, the switch will force the motherboard to power on. When pressed again, it will force the motherboard to power off.

Chapter 6 BIOS and System Setup

This chapter describes the different settings available in the BIOS. The AI6NFK/KP6 motherboard comes with AMIBIOS. The topics covered in this chapter are as follows:

- ❑ 6.1 Invoking the System Setup Program.....28
 - ❑ 6.2.....Running the Setup
.....
 - Point and Click Interface.....
 - Using a Mouse with Setup.....
 - Using the Keyboard with Setup.....
 - ❑ 6.3.....Setup Main Menu
.....
 - Default Values.....
 - Original.....
 - Optimal.....
 - Fail safe.....
 - Save Changes and Exit.....
 - Setup Menu Categories.....
 - ❑ 6.4.....Standard Setup Menu
.....
 - Date/Time.....
 - Floppy Drive A, B.....
 - Configuring IDE Drives.....
 - Configuring an MFM Drive.....
 - User-Defined Drive.....
 - Configuring a CD-ROM Drive.....
 - ❑ 6.5.....Advanced Setup Menu
- Quick Boot.....
 - Pause on Config. Screen (Sec.).....36
 - Boot From SCSI.....
 - BootUp Sequence.....

BootUp NumLock.....

Floppy Drive Seek.....	
Floppy Access Control.....	37
HDD Access Control.....	37
PS/2 Mouse Support.....	
Primary Display.....	
Password Check.....	
Boot to OS/2.....	
Internal Cache.....	38
System BIOS cacheable.....	
C000-D800 16K Shadow.....	38
<input type="checkbox"/> 6.6.....	Chipset Setup Menu 39
Auto Configure DRAM Timing.....	39
DRAM Speed.....	39
DRAM Parity/ECC.....	39
Fixed Memory Hole.....	39
CPU-to-PCI IDE Posting.....	39
USB Function	39
<input type="checkbox"/> 6.7.....	Power Management Setup
Power Management/ APM.....	
Green PC Monitor Power State.....	40
Video Power Down Mode.....	40
Hard Disk Power Down Mode.....	40
Standby Time Out (Minute).....	41
Suspend Time Out (Minute).....	41
Slow Clock Ratio.....	41
Modem Use IRQ.....	41
Display Activity.....	41
IRQ 3/4/5/7/8/9/10/11/12/13/14/15.....	42

- ❑ 6.8.....PCI/PnP Setup Menu
43
 - Plug and Play Aware OS.....43
 - Clear NVRAM on Every Boot.....43
 - PCI Latency Timer (in PCI Clocks).....43
 - PCI VGA Palette Snoop.....44
 - Allocate IRQ to PCI VGA.....44
 - PCI IDE BusMaster.....44
 - Offboard PCI IDE Card.....44
 - Offboard PCI IDE Primary IRQ.....44
 - Offboard PCI IDE Secondary IRQ.....44
 - IRQ 3/4/5/7/9/10/11/12/14/15.....44
 - Reserved Memory Size.....45
 - DMA Channel 0//1/3/5/6/7, IRQ 3/4/5/9/10/11/12/14/15.. 45
- ❑ 6.9.....Peripheral Setup Menu
46
 - Onboard FDC.....46
 - Onboard Serial Port 1.....46
 - Onboard Serial Port 2.....46
 - Serial Port2 Mode.....47
 - Parallel Port Mode.....47
 - Parallel Port DMA.....47
 - Onboard IDE.....47
- ❑ 6.10.....Password
- If You Do Not Want to Use a Password.....
 - Setting a Password.....
- ❑ 6.11 Anti-Virus.....

6.1 Invoking the System Setup Program

Power on the system and the screen will display:

Hit to enter Setup

Hit the key and screen will display the main Setup screen.

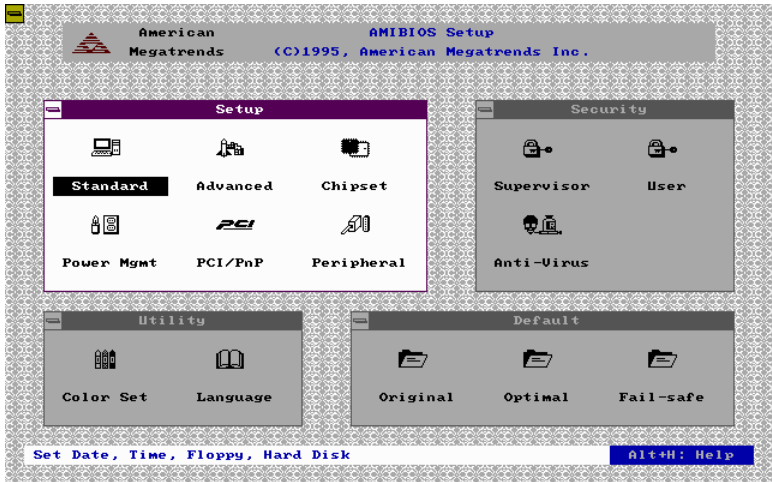

6.2 Running the Setup

Point and Click Interface

The Setup uses the familiar point and click navigation technique. You can point with your mouse anywhere on the screen, click the left mouse button and Setup control is transferred to the new location. The previous window is closed. All parameters that have been changed will automatically be saved, pending the selection on the exit screen.

Using a Mouse with Setup

Setup can be accessed via a keyboard, mouse or pen. The mouse click functions are:

- Single click to change or select both global and current fields, and
- Double-click to perform an operation in the selected field.

Using the Keyboard with Setup

Use the following keys to modify and move around in the Setup:

Keystroke	Function
<Tab>	Move to the next window or field.
→, ←, ↑, ↓	Move to the next field to the right, left, above, or below.
<Enter>	Select in the current field.
+	Increases a value.
-	Decreases a value.
<Esc>	Close the current operation and return to the previous level.
<PgUp>	Returns to the previous page.
<PgDn>	Advances to the next page.
<Home>	Returns to the beginning of the text.
<End>	Advances to the end of the text.
<Alt><H>	Access a help window.
<Alt><Spacebar>	Exit WINBIOS Setup.
Alphabetic Keys	A to Z are used in the virtual keyboard and are not case-sensitive.
Numeric Keys	0 to 9 are used in the virtual keyboard and numeric keypad.

6.3 Setup Main Menu

Default Values

The icons in this section permit you to select a group of settings for all the Setup options. Not only can you use these icons to quickly set system configuration parameters, you can choose a group of settings that have a better chance of working when the system is having configuration-related problems.

Original

Choose the Original icon to return to the system configuration values present in WINBIOS Setup when you first began this WINBIOS Setup session.

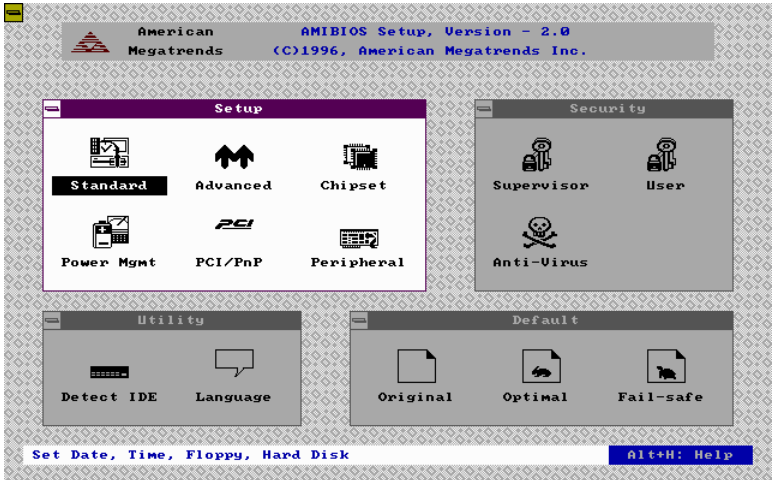

Optimal

You can load the optimal default settings for the BIOS by selecting the Optimal icon. The Optimal default settings are best-case values that should optimize system performance. If CMOS RAM is corrupted, the Optimal settings are loaded automatically.

Note: The optimal values are for regular use.

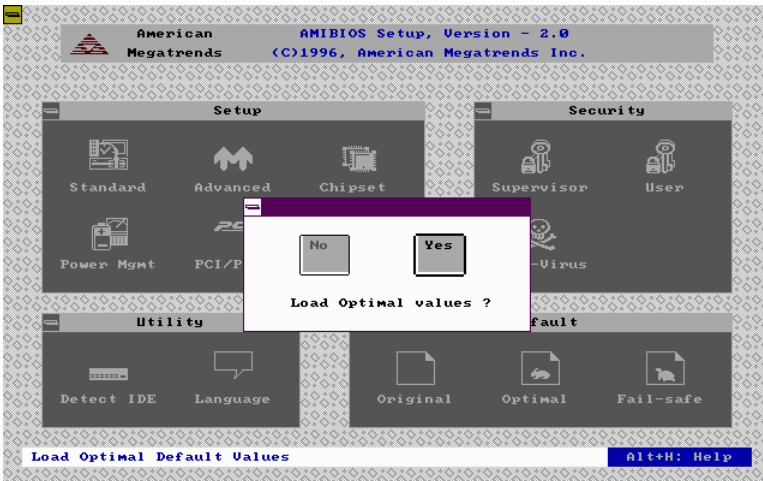
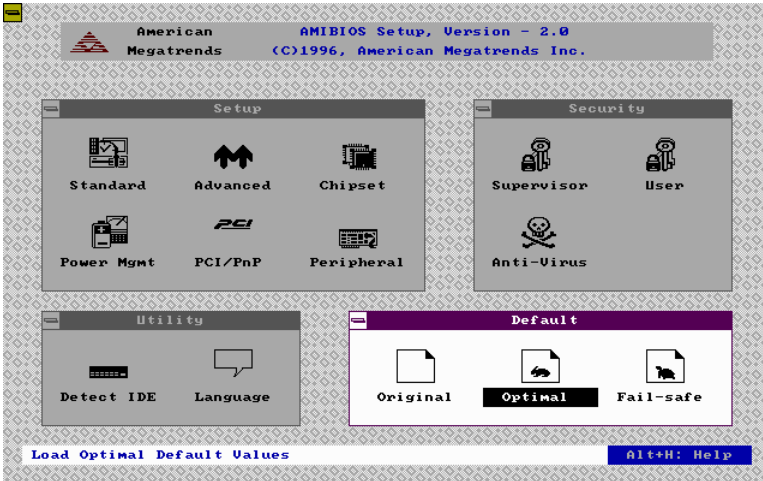

Fail safe

You can load the Fail-Safe BIOS Setup option setting by selecting the Fail-Safe icon from the Default section of the Setup main menu.

The Fail-Safe settings provide far-from-optimal system performance, but are the most stable settings. Use this option as a diagnostic aid if the system is behaving erratically.

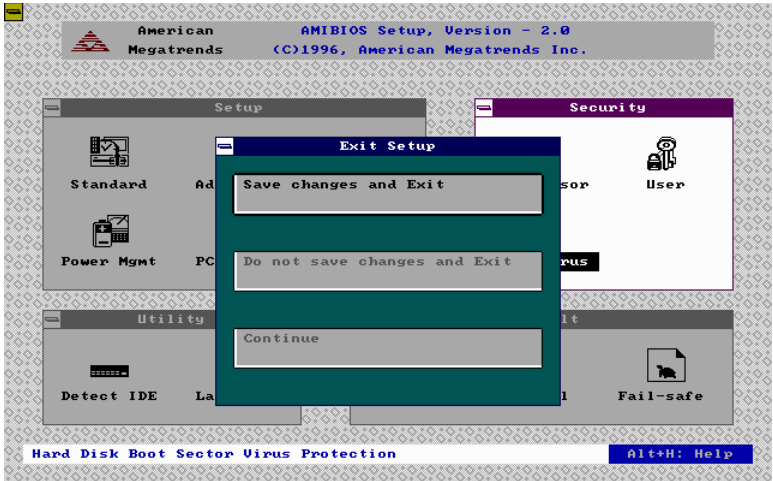

Save Changes and Exit

Select this option to save into the CMOS RAM all the modifications you have specified during the current session.

Note: If you would like to review or modify the configuration in more detail, you could select the **Continue** option to go to the next page before you decide to choose the **Save Changes and Exit** option.

Setup Menu Categories

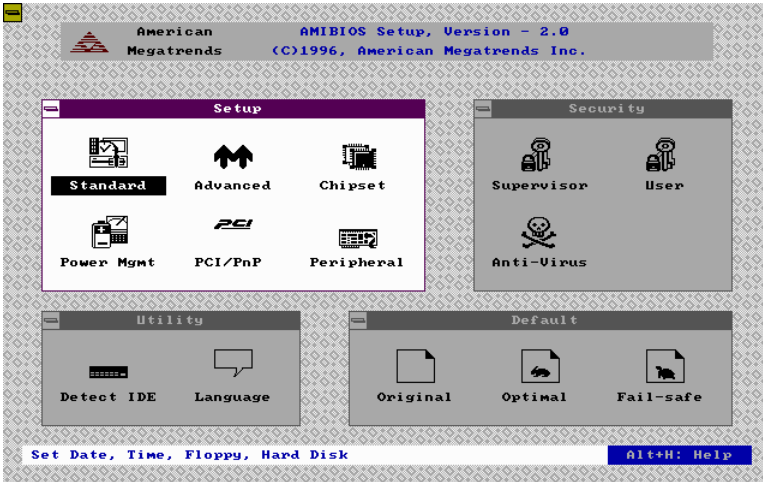

Your Setup program can have up to six separate screens. Different types of system configuration parameters are set on each screen.

Type	Description
Standard Setup	Set the time and date. Configure disk drives.
Advanced Setup	Configure basic system performance parameters.
Chipset Setup	Configure features specific to the chipset used in the computer.
Power Management Setup	Configure power conservation features.
PCI/PnP Setup	Configure PCI and Plug-and-Play features.
Peripheral Setup	Configure I/O support.

6.4 Standard Setup Menu

Standard Setup options are displayed by choosing the Standard icon from the Setup menu. All Standard Setup options are described below.

Date/Time

Select the Date/Time option to change the date or time. The current date and time are displayed. Enter new values through the displayed window.

Floppy Drive A, B

Choose the Floppy Drive A or B icon to specify the floppy drive type. The settings are *360KB 5 1/4"*, *1.2MB 5 1/4 720KB 3 1/2"*, *1.44MB 3 1/2"* and *2.88MB 3 1/2"*

Configuring IDE Drives

If the hard disk drive to be configured is an IDE drive, select the appropriate drive icon (Pri Master, Pri Slave, Sec Master or Sec Slave). Choose the *Type* parameter and select *Auto*. The BIOS automatically detects the IDE drive parameters and displays them. Click on the OK button to accept these parameters.

Configuring an MFM Drive

In configuring an old MFM hard disk drive, you must know the drive parameters (number of heads, number of cylinders, number of sectors, the starting write precompensation cylinder and drive capacity). Choose *Type* and choose the appropriate hard disk drive type (1-46).

User-Defined Drive

If you are configuring a SCSI drive or an MFM, RLL, ARLL or ESDI drive with drive parameters that do not match drive types 1-46, you must select *User* in the *Type* field and enter the drive parameters on the screen that appears. The drive parameters include:

- Cylinder (number of cylinders),
 - Hd (number of heads),
 - WP (starting write precompensation cylinder),
 - Sec (number of sectors), and
 - Size (drive capacity).
-

Configuring a CD-ROM Drive

Select the appropriate drive icon (Pri Master, Pri Slave, Sec Master or Sec Slave). Choose the *Type* parameter and select CDROM. You can boot the computer from a CD-ROM drive.

6.5 Advanced Setup Menu

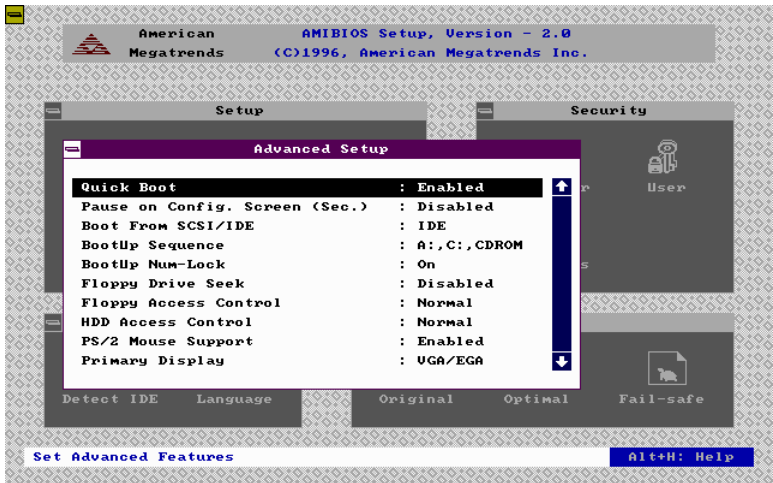

Quick Boot

Set this option to *Enabled* to instruct AMIBIOS to boot quickly when the computer is powered on. This option replaces the old **Above 1 MB Memory Test** Advanced Setup option.

Pause on Config. Screen (Sec.)

This option sets the time of pause made by the configuration screen during boot up which can be two to 15 seconds. The default setting is *Disabled*.

Boot From SCSI / IDE

This option sets the boot driver from SCSI primary, then sequenced by bootup sequence ITEM. The default setting is *IDE*.

BootUp Sequence

This option sets the sequence of boot drives (floppy drive A:, hard disk drive C:, or a CD-ROM drive) that the AMIBIOS attempts to boot from after AMIBIOS POST completes. The settings are *C;*, *A;*, *CDROM;* *CDROM, C;*, *A;* and *A;*, *C;*, *CDROM*. The default setting is *A;*, *C;*, *CDROM*.

BootUp NumLock

Set this option to *Off* to turn the Num Lock key off when the computer is booted so you can use the arrow keys on both the numeric keypad and the keyboard. The settings are *On* and *Off*. The default setting is *On*.

Floppy Drive Seek

Set this option to *Enabled* to specify that floppy drive A: will perform a Seek operation at system boot. The settings are *Disabled* and *Enabled*. The Optimal and Fail-Safe default setting is *Disabled*.

Floppy Access Control

Setting this option to *Normal* enables the floppy drive to perform a read and write operation. The settings are *Normal* or *Read Only*. The default setting is *Normal*.

HDD Access Control

Setting this option to *Normal* enables the hard disk drive to perform a read and write operation. The settings are *Normal* or *Read Only*. The default setting is *Normal*.

PS/2 Mouse Support

When this option is set to *Enabled*, AMIBIOS supports a PS/2-type mouse. The default setting is *Enabled*.

Primary Display

This option specifies the type of display monitor and adapter in the computer. The settings are *Mono*, *CGA40*, *CGA80*, *EGA/VGA* and *Absent*. The Optimal and Fail-Safe default setting is *EGA/VGA*.

Password Check

This option enables password checking every time the computer is powered on or every time BIOS Setup is executed. If *Always* is chosen, a user password prompt appears every time the computer is turned on. If *Setup* is chosen, the password prompt appears if BIOS is executed. The Optimal and Power On defaults are *Setup*.

Boot to OS/2

Set this option to *Yes* to permit AMIBIOS to run with IBM OS/2. The settings are *Yes* and *No*. The default setting is *No*.

Internal Cache

This option specifies the caching algorithm used for L1 internal cache memory. The settings are:

Setting	Description
<i>Disabled</i>	Neither L1 internal cache memory on the CPU or L2 secondary cache memory is enabled.
<i>Write Back (default)</i>	Use the write-back caching algorithm.
<i>Write Thru</i>	Use the write-through caching algorithm.

System BIOS cacheable

When this option is set to *Enabled*, the contents of the F0000h system memory segment can be read from or written to L2 secondary cache memory. The contents of the F0000h memory segment are always copied from the BIOS ROM to the system RAM for faster execution.

The settings are *Enabled* and *Disabled*. The Optimal default setting is *Enabled*. The Fail-Safe default setting is *Disabled*.

C000, 16K Shadow
C400, 16K Shadow
C800, 16K Shadow
CC00, 16K Shadow

D000, 16K Shadow
D400, 16K Shadow
D800, 16K Shadow

These options control the location of the contents of the 16KB of ROM beginning at the specified memory location. If no adapter ROM is using the named ROM area, this area is made available to the local bus. The settings are:

Setting	Description
<i>Shadow</i>	The contents of C0000h - C3FFFh are written to the same address in system memory (RAM) for faster execution.
<i>Cache</i>	The contents of the named ROM area are written to the same address in system memory (RAM) for faster execution, if an adapter ROM will be using the named ROM area. Also, the contents of the RAM area can be read from and written to cache memory.
<i>Disable</i>	The video ROM is not copied to RAM. The contents of the video ROM cannot be read from or written to cache memory.

The C000~C7FF 32K default setting is *Enabled*; for other segments it is *Disabled*.

6.6 Chipset Setup Menu

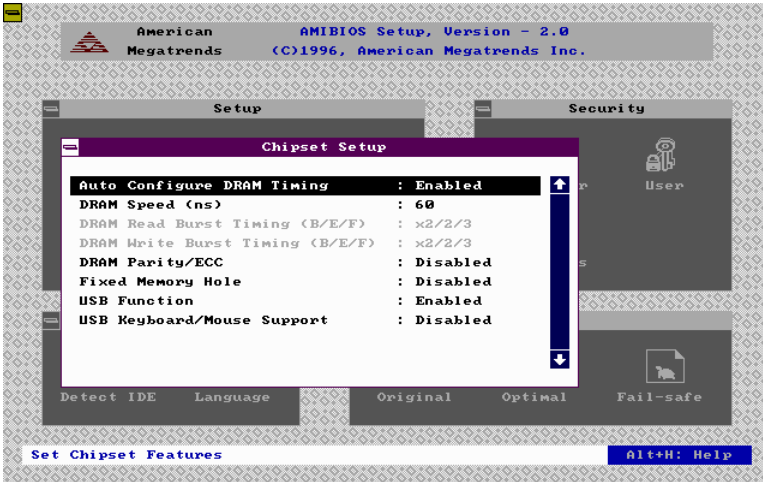

Auto Configure DRAM Timing

Use this option to specify the timing on the memory Bus. The default setting is *Enabled*.

DRAM Speed

This specifies the RAS access speed of the SIMMs installed as system memory. The settings are *50ns*, *60ns* and *70ns*. The default is *60ns*.

DRAM Parity/ECC

Set this option to *Enabled* to check the parity of all system memory and enable error checking and correction. The default setting is *Disabled*.

Fixed Memory Hole

Enabling this feature reserves (15MB to 16MB or 512KB to 640KB) memory address space to ISA expansion cards that specifically require this setting. This makes the memory from (15MB or 512KB) and up unavailable to the system. Expansion cards can only access memory up to 16MB. The default is *Disabled*.

USB Function

Enabling this feature allows support for USB keyboard or mouse. The default is *Disabled*.

6.7 Power Management Setup

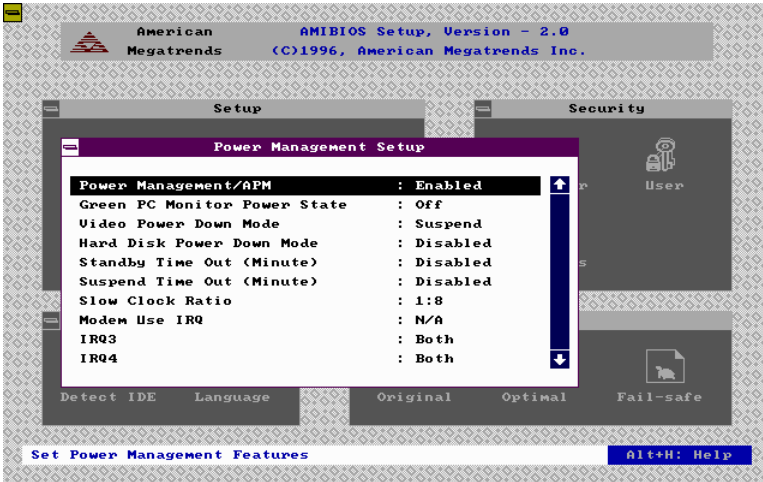

Power Management/ APM

Set this option to *Enabled* to enable the power-management and APM (Advanced Power Management) features. The settings are *Enabled* and *Disabled*. The default setting is *Enabled*.

Green PC Monitor Power State

This option specifies the power-management state that the Green PC-compliant video monitor enters after the specified period of display inactivity has expired. The settings are *Disabled*, *off Standby* and *Suspend*. The default setting is *Suspend*.

Video Power Down Mode

This option specifies the power-management state that the video subsystem enters after the specified period of display inactivity has expired. The settings are *Disabled*, *Standby* and *Suspend*. The default is *Suspend*.

Hard Disk Power Down Mode

This option specifies the power-management state that the hard disk drive enters after the specified period of display inactivity has expired. The settings are *Disabled*, *Standby* and *Suspend*. The default setting is *Disabled*.

Standby Time Out (Minute)

This option specifies the length of the period of system inactivity when the computer is in Full On mode before the computer is placed in Standby mode. In Standby mode, some power use is curtailed. The settings are *Disabled*, *1 Min*, *2 Min* and *all one minute intervals up to and including 15 Min*. The default setting is ***Disabled***.

Suspend Time Out (Minute)

This option specifies the length of the period of system inactivity when the computer is already in Standby mode before the computer is placed in Suspend mode. In Suspend mode, nearly all power use is curtailed. The settings are *Disabled*, *1 Min*, *2 Min* and *all one minute intervals up to and including 15 Min*. The default setting is ***Disabled***.

Slow Clock Ratio

This option specifies the speed at which the system clock runs in power- saving modes. The settings are expressed as a ratio between the normal clock speed and the power down clock speed. The settings are *1:1*, *1:2* (half as fast as normal), *1:4* (the normal clock speed), *1:8*, *1:16*, *1:32*, *1:64* and *1:128*. The default setting is ***1:8***.

Modem Use IRQ

This option specifies the IRQ used by an external modem connected to a serial port. The settings are *3*, *4* and *N/A*. For COM1 the IRQ is 4; for COM2 it is 3. The default setting is *N/A*.

Display Activity

This option specifies if AMIBIOS is to monitor activity on the display monitor for power-conservation purposes. When this option is set to *Monitor* and there is no display activity for the length of time specified in the value in the *Full On to Standby Timeout (Min)* option, the computer enters a power-saving state. The settings are *Monitor*, *Wake up*, *Ignore* and *Both*. The default setting is ***Ignore***.

IRQ3	IRQ4	IRQ5	IRQ7	IRQ8	IRQ9
IRQ10	IRQ11	IRQ12	IRQ13	IRQ14	IRQ15

These options enable event monitoring. When the computer is in a power-saving mode, activity on the named interrupt request line is monitored by AMIBIOS. When any activity occurs, the computer enters the Full On mode. Each of these options can be set to *Monitor*, *Ignore*, *WakeUp* or *Both*.. The default setting for IRQ5, IRQ8, IRQ9, IRQ10, IRQ11 is **Ignore**, **Monitor** for IRQ7, IRQ14 and IRQ15, and **Both** for IRQ3, IRQ4 and IRQ12.

6.8 PCI/PnP Setup Menu

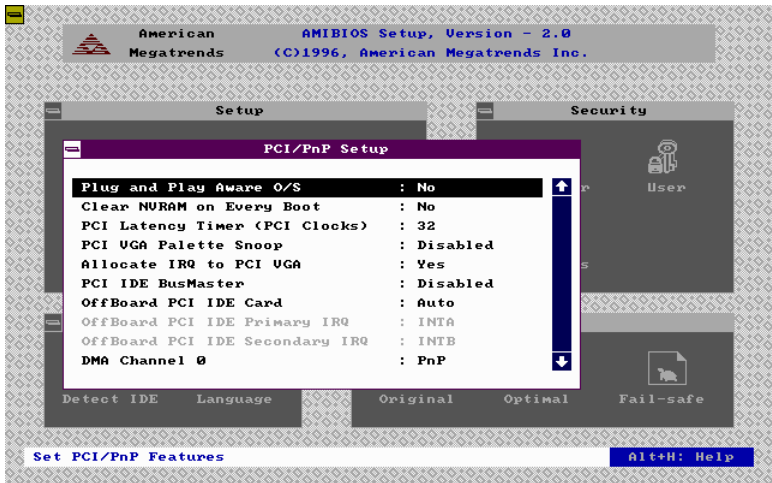

Plug and Play Aware OS

Set this option to *Yes* if the operating system installed in the computer is Plug and Play-aware. AMIBIOS only detects and enables PnP ISA adapter cards that are required for system boot. The Windows 95 operating system detects and enables all other PnP-aware adapter cards. Windows 95 is PnP-aware.

Set this option to *No* if the operating system (such as DOS, OS/2, Windows 3.x) does not use PnP. You must set this option correctly or PnP-aware adapter cards installed in your computer will not be configured properly. The settings are *No* and *Yes*. The Optimal and Fail-Safe default settings are *No*.

Clear NVRAM on Every Boot

Enabling this option erases the NVRAM containing PnP information on every boot. The Optimal and Fail-Safe default settings are *No*.

PCI Latency Timer (in PCI Clocks)

This option sets latency of all PCI devices on the PCI bus. The settings are in units equal to PCI clocks. The settings are *32*, *64*, *96*, *128*, *160*, *192*, *244* and *248*. The Optimal and Fail-Safe default settings are *32*.

PCI VGA Palette Snoop

This option must be set to *Enabled* if any ISA adapter card installed in the computer requires VGA palette snooping. The settings are *Disabled* and *Enabled*. The Optimal and Fail-Safe default settings are ***Disabled***.

Allocate IRQ to PCI VGA

Enabling this option allocates an IRQ to the PCI VGA card in the motherboard. The Optimal and Fail-Safe default settings are ***Yes***.

PCI IDE BusMaster

Set this option to *Enabled* to specify that the IDE controller on the PCI local bus has bus mastering capability. The settings are *Disabled* and *Enabled*. The Optimal and Fail-Safe default setting is ***Disabled***.

Offboard PCI IDE Card

This option specifies if an offboard PCI IDE controller adapter card is used in the computer. You must also specify the PCI expansion slot on the motherboard where the offboard PCI IDE controller card is installed. If an offboard PCI IDE controller is used, the onboard IDE controller on the motherboard is automatically disabled. The settings are *Disabled*, *Auto*, *Slot1*, *Slot2*, *Slot3* and *Slot4*.

If *Auto* is selected, AMIBIOS automatically determines the correct setting for this option. The Optimal and Fail-Safe default setting is ***Auto***.

Offboard PCI IDE Primary IRQ

The Optimal and Fail-Safe default setting is ***INTA***.

Offboard PCI IDE Secondary IRQ

The Optimal and Fail-Safe default setting is ***INTB***.

IRQ3	IRQ4	IRQ5	IRQ7	IRQ9
IRQ10	IRQ11	IRQ12	IRQ14	IRQ15

These options specify the bus that the named interrupt request lines (IRQs) are used on. These options allow you to specify IRQs for use by legacy ISA adapter cards.

These options determine if AMIBIOS should remove an IRQ from the pool of available IRQs passed to BIOS configurable devices. The available IRQs pool is determined by reading the ESCD NVRAM. If more IRQs must be removed from the pool, the end user can use these PCI/PnP Setup options to remove the IRQ by assigning the option to the ISA/EISA setting. Onboard I/O is configurable by AMIBIOS. The IRQs used by onboard I/O are configured *PCI/PnP*.

The settings are *PCI/PnP* and *ISA/EISA*. The Optimal and Fail-Safe default setting is *PCI/PnP*.

Reserved Memory Size

This option specifies the size of the memory area reserved for legacy ISA adapter cards. The settings are *Disabled*, *16K*, *32K* and *64K*. The Optimal and Fail-Safe default setting is *Disabled*.

DMA Channel 0/1/3/5/6/7, IRQ 3/4/5/7/9/10/11/12/14/15

These fields allow you to determine the IRQ/DMA assigned to the ISA bus and is not available to any PCI slot.

6.9 Peripheral Setup Menu

Peripheral Setup options are displayed by choosing the Peripheral Setup icon from the Setup main menu. All Peripheral Setup options are described in this section.

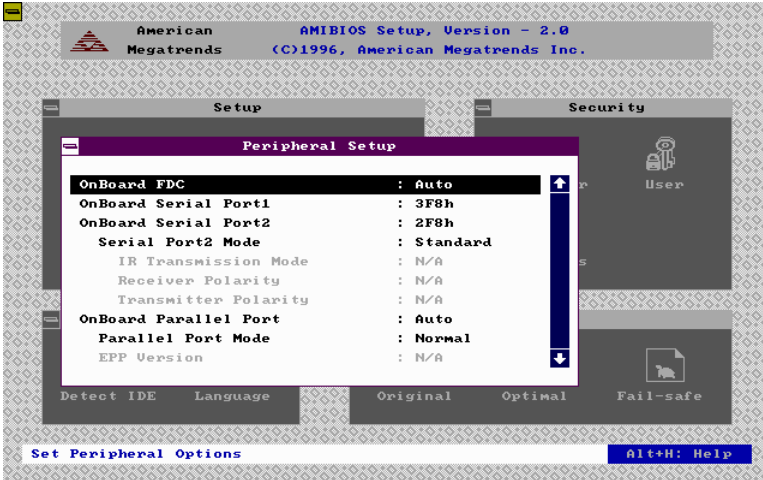

Onboard FDC

This option enables the floppy drive controller on the motherboard. The settings are *Auto*, *Enabled* and *Disabled*. The Optimal default setting is *Auto*. The Fail-Safe default setting is *Disabled*.

Onboard Serial Port 1

This option enables serial port 1 on the motherboard and specifies the base I/O port address for serial port 1.

The settings are *3F8h*, *3E8h*, *Auto* and *Disabled*. The Optimal default setting is *3F8h*. The Fail-Safe default setting is *Disabled*.

Onboard Serial Port 2

This option enables serial port 2 on the motherboard and specifies the base I/O port address for serial port 2.

The settings are *2F8h*, *2E8h*, *Auto* and *Disabled*. The Optimal default setting is *2F8h*. The Fail-Safe default setting is *Disabled*.

Serial Port2 Mode

This option specifies the mode for which the serial port2 on the motherboard is used. The settings are *Standard*, *IrDA* or *ASK IR*. The Optimal and Fail-Safe default setting is **Standard**.

Onboard Parallel Port

This option enables the parallel port on the motherboard and specifies the parallel port base I/O port address. The settings are *378h*, *278h*, *Auto* and *Disabled*. The Optimal default setting is **Auto**. The Fail-Safe default setting is **Disabled**.

Parallel Port Mode

This option specifies the parallel port mode. ECP and EPP are both bi-directional data transfer schemes that adhere to the IEEE P1284 specifications. The settings are:

Setting	Description
<i>Normal</i>	The normal parallel port mode is used. This is the default setting.
<i>Bi-Dir</i>	Use this setting to support bi-directional transfers on the parallel port.
<i>EPP</i>	The parallel port can be used with devices that adhere to the Enhanced Parallel Port (EPP) specification. EPP uses the existing parallel port signals to provide asymmetric bi-directional data transfer driven by the host device.
<i>ECP</i>	The parallel port can be used with devices that adhere to the Extended Capabilities Port (ECP) specification. ECP uses the DMA protocol to achieve transfer rates of approximately 2.5MB/sec. ECP provides symmetric bi-directional communications.

Parallel Port DMA

This option is only available if the setting for the **Parallel Port Mode** option is ECP. The settings are *N/A*, *DMA CH (channel) 0*, *DMA CH 1* and *DMA CH 3*. The default setting is **Auto**.

Onboard IDE

This option specifies the onboard IDE controller channels that will be used. The settings are *Primary*, *Secondary*, *Both* and *Disabled*. The Optimal and Fail-Safe default settings are **Both**.

6.10 Password

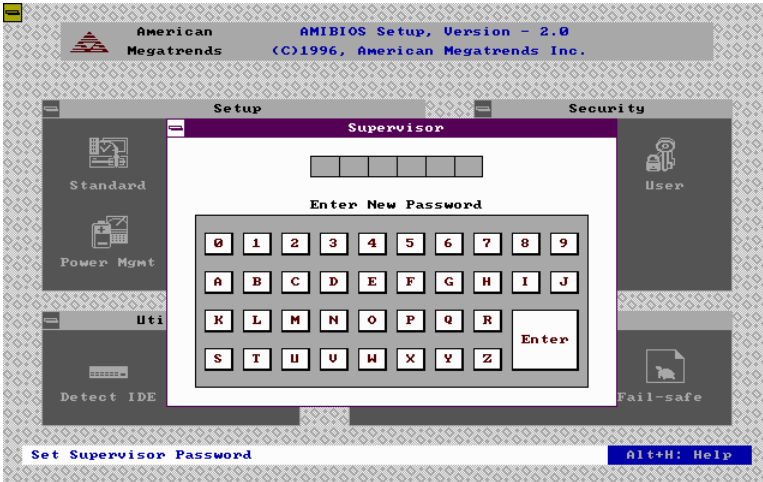

If You Do Not Want to Use a Password

Just press <Enter> when the password prompt appears.

Setting a Password

The password check option is enabled in Advanced Setup by choosing either *Always* (the password prompt appears every time the system is powered on) or *Setup* (the password prompt appears only when BIOS is run). The password is stored in the CMOS RAM.

You can enter a password by:

- typing the password on the keyboard,
- selecting each letter with the mouse, or
- selecting each letter with the pen stylus.

Pen access must be customized for each specific hardware platform.

When you select *Supervisor* or *User*, AMIBIOS prompts for a password. You must set the *Supervisor* password before you can set the *User* password. Enter a 1-6 character password. The password does not appear on the screen when typed. Make sure you write it down. If you forget it, you must drain the CMOS RAM and reconfigure the system.

6.11 Anti-Virus

When this icon is selected from the Security section of the Setup main menu, AMIBIOS issues a warning when any program (or virus) issues a Disk Format command or attempts to write to the boot sector of the hard disk drive. The settings are *Enabled* and *Disabled*. If enabled, the following appears when a write is attempted to the boot sector. You may have to type N several times to prevent the boot sector write.

Boot Sector Write!!!
Possible VIRUS: Continue (Y/N)? _

The following appears after any attempt to format any cylinder, head, or sector of any hard disk drive via the BIOS INT 13 Hard Disk Drive Service:

Format!!!
Possible VIRUS: Continue (Y/N)? _

APPENDIX

A. Slot 1 Retention Mechanism and KP6 CPU module

1. To install the Slot 1 mechanism, fasten it with the four screws from underneath the motherboard. Refer to the drawing below.
2. To release the KP6 CPU module from the retention mechanism, press the two sides of the module. Refer to the drawing below.

