

AD11

MAINBOARD MANUAL

DOC No.: M00604

Rev. : A0

Date : 11, 2000

Part No. :25-11564-20

Handling Precautions

Warning:

1. Static electricity may cause damage to the integrated circuits on the motherboard. Before handling any motherboard outside of its protective packaging, ensure that there is no static electric charge in your body.
2. There is a danger of explosion if the battery is incorrectly replaced. Replace only with the same or an equivalent type recommended by the manufacturer.
3. Discard used batteries according to the manufacturer's instructions.
4. Never run the processor without the heatsink properly and firmly attached. **PERMANENT DAMAGE WILL RESULT!**

Observe the following basic precautions when handling the motherboard or other computer components:

- Wear a static wrist strap which fits around your wrist and is connected to a natural earth ground.
- Touch a grounded or anti-static surface or a metal fixture such as a water pipe.
- Avoid contacting the components on add-on cards, motherboards, and modules with the *golden fingers* connectors plugged into the expansion slot. It is best to handle system components by their mounting brackets.

The above methods prevent static build-up and cause it to be discharged properly.

Trademark

All trademarks mentioned in this manual are registered properly of the respective owners.

Handling Precautions

This manual may not, in whole or in part, be photocopied, reproduced, transcribed, translated, or transmitted in whatever form without the written consent of the manufacturer, except for copies retained by the purchaser for personal archival purposes.

Chapter 1 Overview

Package Checklist 1-2
 The AD11 Mainboard 1-3
Main Features 1-4
ACPI Ready 1-6
FIC Unique Innovation for Users (NOVUS) -
Enhanced Mainboard Features and System Support 1-6

Chapter 2 Installation Procedures

Quick Reference (from Page 2-2 to 2-6) 2-2
Mainboard Layout 2-2
 1). Clear CMOS, Clear Password, FSB Speed Select,
 Auto Detect Freq. Ratio (ADD_EN, ADR),
 Auto Detect CPU Core Voltage (ADV_EN, ADV) 2-3
 2). Front Panel Block Cable Connection 2-6
 3). CPU Fan Installation 2-6
1). Set System Jumpers/Switches 2-7
 Clear CMOS: CLR_CMOS 2-8
 Clear Password: CLR_PSWD 2-8
 FSB Speed Select: 100MHz/133MHz 2-9
 Auto Detect CPU Core Voltage: ADV_EN 2-9
 CPU Core Voltage Setting: ADV 2-10
 Auto Detect CPU Clock: ADR_EN 2-10
 Bus Ratio Setting: ADR 2-11
2). Install Memory Modules 2-12
3). Install the CPU 2-12
4). Install Expansion Cards 2-14
5). Connect Devices 2-15
 Floppy Diskette Drive Connector: FDD 2-15
 IDE HDD Device Connectors: PRIMARY, SECONDARY .. 2-16
 ATX Power Connector: ATX_PWR1 2-16
 CPU Fan Connector: CPU_FAN 2-17
 System Case Fan Connector: CHS_FAN 2-17
 Wake-On-Ring Connector: WOR 2-18
 Wake-On-LAN Connector: WOL 2-18
 System Chassis Open Alarm Connector: CHASSIS 2-19

Blue Tooth Audio Port Connector: BT_AUDIO	2-19
CD Audio-In Connectors: CD_IN1, AUX_IN	2-20
Optional Audio Alert II Module Connector: NOVUS	2-20
Infrared Connector: IR	2-21
Front Panel Block Connector: FPNL	2-22
PS/2 Keyboard and Mouse Connector: PS2_KB, PS2_MS	2-23
Universal Serial Bus Connectors: Rear USBs, Front USBs	2-23
Printer Connector: LPT	2-24
Serial Port Connectors: COM1, COM2	2-24
Audio I/O Jacks: LINE_OUT, LINE_IN, MIC_IN, FNT_AUDIO	2-25
Game/MIDI Connector: GAME	2-25

Chapter 3 BIOS Setup

CMOS Setup Utility	3-1
Standard CMOS Setup	3-2
Advanced BIOS Features	3-4
Advanced Chipset Features	3-8
Integrated Peripherals	3-12
Power Management Setup	3-18
PnP/PCI Configurations	3-22
PC Health Status	3-24
Frequency/Voltage Control	3-25
Load Fail-Safe Defaults	3-26
Load Optimized Defaults	3-26
Supervisor/User Password	3-27
Save and Exit Setup	3-28
Exit without Saving	3-28

Quick Reference (German)	G-1
Quick Reference (French)	F-1
Quick Reference (Spanish)	S-1
Quick Reference (Japanese)	J-1
Quick Reference (Chinese)	C-1
Quick Reference (Simplified Chinese)	SC-1

Other Languages about CPU Heatsink Warning

Overview

The new Socket A 1stMainboard AD11 is an ATX sized motherboard supporting the latest generation of AMD Athlon and Duron processors at industry leading speeds. By utilizing DDR (Double Data Rate) transfer rate the 100/133 MHz AMD Athlon/Duron system bus effectively reaches speeds of 200/266 MHz. The AMD Athlon processor offers high-performance cache technology, including 128KB of on-chip level one (L1) , while the Duron features full-speed, on-chip L2 cache memory, and enhanced 3DNow!™ technology. The 1stMainboard AD11 has 2 memory module sockets for up to 1 GB of DDR SDRAM (PC-200/266) is equipped with ECC memory support.

The 1stMainboard AD11 is based around the high performance that comprised of AMD 761 system controller for the North Bridge, and the VIA 686B (Super South). The chipset support for AGP 4x provides the end-user a photo-realistic 3D experience suitable for the most robust 3D games and software environments. Onboard AC97 sound ensures high quality audio, but with the option of being disabled through the BIOS.

AD11 has 5 PCI (32 bit/33 MHz) slots. User can plug many kinds of PCI add-on cards. The mainboard also has one CNR (Communication Networking Riser) slot. The CNR slot on AD11 allows modem and audio add-on cards.

The 1stMainboard AD11 also comes equipped with the new NOVUS II range of innovative features that assist in the installation and maintenance of your 1stMainboard. The features include *Easy Key*, which provides instant keyboard access to the BIOS for adjustments to Clock and Default settings and *LogoGenie*, which allows you to create your own customized logo to be displayed during system boot up. The *BIOS Guardian* is an Anti Virus utility that prevents viruses from damaging your system BIOS and rendering your system inoperative. Clockometer is a user friendly Graphic User Interface (GUI) that allows you to change clock speed settings directly, without having to enter the BIOS Sub-Menus. Moreover, audio alert II (mfg. optional) , a friendly onboard voice caution, will advice the error during system boot up.

In addition, the 1stMainboard AD11 is equipped with 2 dual channeled enhanced PCI bus master IDE connectors. Standard I/O connections include 2 serial ports, 1 parallel port, 1 PS/2 mouse and keyboard connector, 2 USB connectors, 2 front USB pin-headers, and 1 media connector (Line-In, Line-Out, Mic-In, 1 Midi/game port).

Package Checklist

If you discover any item below was damaged or lost, please contact your vendor.

- The mainboard
- This user manual
- One FDD cable
- One HDD (ATA/33) cable
- One ATA/66 cable
- Audio Alert II module (optional)
- Two software CDs (CD Pro, CD Plus)

IMPORTANT: AMD CPU HEAT SINK INSTALLATION



Be ware finish heat hink install. Before you boot system, please check the heat sink is complete contact with die of CPU.

The poor contact will bring about over heat, it may damage your processor.

It is strongly recommended that at least a 200-watt ATX power puppy be used for this motherboard. Make sure that your ATX power supply can supply at least 20 amperes on teh +5-Volt lead and 10ma on the +5-Volt standby lead (+5VSB). Your system may become unstable / unreliable and may experience difficulty in powering up if your power supply is inadequate.

The AD11 Mainboard

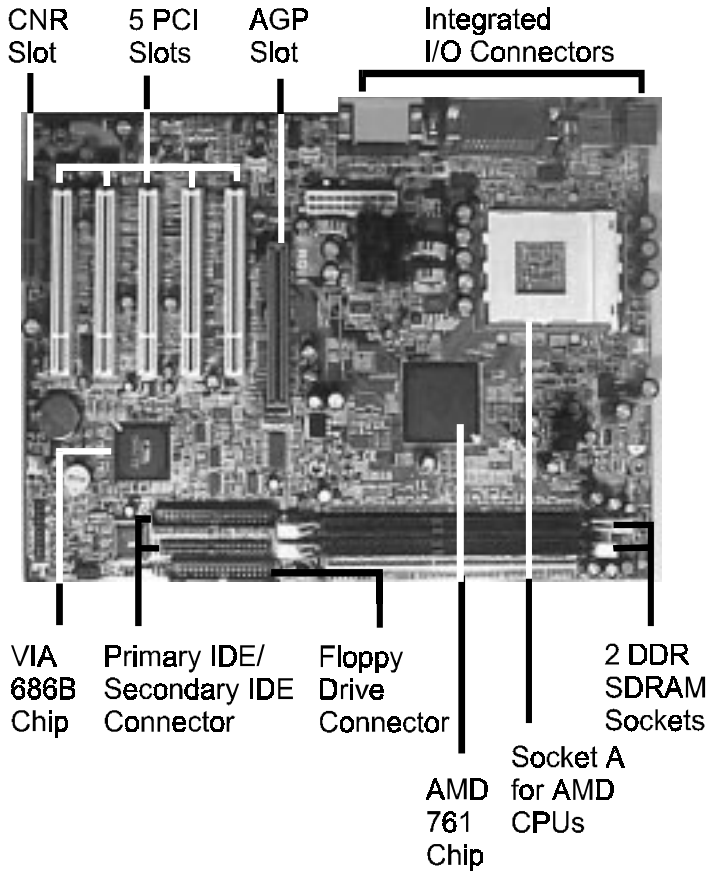

**Chapter 1
Overview**

Main Features

■ Easy Installation

BIOS with support for Plug and Play, auto detection of IDE hard drives, LS-120 drives, IDE ZIP drives, Windows 95, Windows 98, Windows ME, Windows NT, Windows 2000, and OS/2.

■ Leading Edge Chipset

AMD761 is a single-chip North Bridge for Socket A based Athlon/Duron CPUs with 200 MHz Front Side Bus with AGP 4X and PCI plus advanced memory controller that supports DDR SDRAM (PC-200/266).

VIA VT686B is a highly integrated I/O peripheral controller to achieve a PC99-compliant system. The 686B also supports the ATA-100 standards.

■ Versatile Main Memory Support

Accepts up to 1 GB DDR SDRAM using two memory sockets for allowing that from 64, 128, 256, 512MB with support for lightning-fast DDR SDRAM (PC-200/266).

■ AMD® Athlon™ Processors Support

Duron Socket A CPU 600/650/700/750/800/850MHz at 100MHz FSB with AMD bus for double data transfer rate at 100MHz for an effective 200MHz transfer rate.

Athlon Socket A CPU 750/800/850/900/950MHz/1/1.1/1.2GHz at 100/133MHz FSB with AMD Athlon bus for double data rate transfers at 100/133MHz for effective 200/266MHz transfer rate.

■ Enhanced PCI Bus Master IDE Controller with Ultra DMA 33/66/100 Support

Integrated Enhanced PCI Bus Master IDE controller features two dual-channel connectors that up to four Enhanced IDE devices, including CD-ROM and Tape Backup Drives, as well as Hard Disk Drives supporting the new Ultra DMA 100 protocol. Standard PIO Mode 3, PIO Mode 4, DMA Mode 2, DMA Mode 4, UltraDMA-100 Mode 5 devices are also supported.

■ CNR, AGP, and PCI Expansion Slots

One CNR audio/modem slot, one AGP Bus expansion slot, and five PCI Bus expansion slots provided the room to install a full range of add-on cards.

■ Compact Onboard Audio Subsystem

Embedded in VIA 686B, an integrated PCI-mastering dual full-duplex direct-sound AC97-link-compatible audio subsystem. Hardware sound blaster pro and FM blocks are combined for MS Windows DOS box and real mode DOS compatibility. Loopback capability is implemented for guiding audio streams into USB and 1394 speakers for digital sound.

■ Super Multi Input/Output (I/O) Support

Integrated Plug and Play multi-I/O chipset features two high-speed UART 16550 compatible serial ports, one EPP/ECP capable parallel port, one media connector (Mic-in, Line-in, Line-out, Midi/game port), and one FDD connector.

■ Convenient Rear Panel USB Connection Support

Two USB ports integrated in the rear I/O panel with two USB front panel connections allow convenient and high-speed Plug and Play connections to the growing number of USB compliant peripheral devices on the market.

■ Onboard Accelerated Graphics Port (AGP)

The motherboard is installed one 32-bit AGP bus with a dedicated 66MHz/133MHz path from the graphics card to the system memory offering much greater bandwidth than the 32-bit PCI bus does. AGP enabled 3D graphics cards can directly access main memory across this fast path instead of using local memory. To make use of the improved AGP performance, the motherboard should be installed with SDRAM type memory and the VGA card and drivers should also be fully AGP compliant. Using Microsoft's Windows 98 and Windows 2000/ME which implement DirectDraw will allow the system to take full use of AGP's benefits without the need to install additional drivers.

ACPI Ready

This mainboard fully implements the new ACPI (Advanced Configuration and Power Interface) 1.0B Hardware and BIOS requirement. If you install ACPI aware of operating system, such as Windows 98, you fully utilized the power saving under ACPI. (*Windows ME/2000 Professional supports ACPI functions.*)

FIC Unique Innovation for Users (NOVUS) - Enhanced Mainboard Features and System Support

■ LogoGenie

A user friendly GUI supporting Windows 95/98 (not Windows 2000/NT/ME), LogoGenie allows you to customize, create or select a Logo which will be displayed when the system is booting.



NOTE:

1. LogoGenie supports Award BIOS only.
2. If you create a Logo file (.bmp) by LogoGenie, the file size must be 640 x 464 x 256 colors.

To enable this utility, please proceed as follows:

1. Insert CD Pro. Select LogoGenie from the Menu and follow the installation instructions.
2. After LogoGenie has been installed, go to Windows Start Box. In Programs Menu, select LogoGenie, then select LogoGenie.
3. Press F1 to read Help file to understand how to use this software if it is new to you.

■ BIOS Guardian

BIOS Guardian by default is enabled. It must be disabled in order to reflash BIOS, thus effectively acts as a fire-wall against viruses that can attack the BIOS while the system is running.



WARNING: While excute Step3 below, please do not turn off the system power in order to avoid BIOS damage.

BIOS Guardian can be disabled as follows:

1. Go to BIOS Set Up Menu. (Press **Del** key while booting.)
2. Go to Advanced BIOS Features Set Up Submenu.
3. Disable BIOS Guardian.
4. Save the setting, and restart system.



NOTE: However, if it is disabled and while boot the system, the POST screen will be held and shows you the message to let you know the current status of BIOS Guardian. To press **G** key will enable the BIOS Guardian again; or simply to press the **space bar** will continue the booting process.

■ Easy Key

Instead of completing the multi-layered BIOS setup process these 3 Easy Key functions provide direct access to Sub-Menu's when completing BIOS settings adjustments.

Easy-Keys are as follows:

- Ctrl + c:** To enter clock settings menu.
- Ctrl + p:** To load Performance Default settings and restart.
- Ctrl + f:** To load Fail-Safe Default settings and restart.

■ **Overclock Partner**

Should the system not start because clock speed settings have been increased to a speed incompatible with the system, the Overclock Partner allows you to reboot at system default settings, protecting hardware from any damages.

Complete the following steps:

1. Turn the system off.
2. Restart while holding down the **Insert** key. It is important that the **Insert** key is held down until the default clock speed is shown on the POST screen.
3. Enter BIOS settings menu, and re-set clock speed desired or default.

■ **Clockometer**

Clockometer is a Windows 98 compatible, attractive and user friendly Graphic User Interface (GUI). Clockometer enables you to change clock speed settings directly, without having to enter the BIOS Sub-Menus. With the on-screen display panel you can easily monitor your new clock speed settings with gauges that identify your system speed, Front Side Bus settings and CPU Ratios

On screen buttons:

1. "+" and "-" buttons : adjust the Front Side Bus (FSB) and CPU ratio. (the 'hand' cursor means the active button)
2. "OK" button : changes the FSB and CPU ratio (if adjustable) settings right away. If you do not save your new setting, your system will not implement the new setting when rebooting the next time.
3. "SAVE" button : save your new settings for rebooting the computer.
4. "Quit" button will escape the Clockometer program.

■ Audio Alert II (optional)

After complete a system upgrade, should the computer be assembled incorrectly, a friendly onboard voice caution, will advice the error during system boot up.

If you do not hear the Audio Alert, please check that your speakers are connected.

Audio warning are activated as follows:

No CPU: ‘Caution! Processor not detected. Please check your PC’

No Memory: ‘Caution! Memory not detected. Please check your PC’

No Graphics: ‘Caution! VGA not detected. Please check your PC’

■ Usage of Optional Audio Alert II

This mainboard came with an optional Audio Alert II daughter board. Audio Alert II detects and provides an audio warning details for such components as your CPU, VGA card and memory, while also monitoring your system clock status. The complimentary software contained in the CD Pro enables you to personalize these audio messages by recording new messages and saving them to flash memory.

Installation

1. To install the Audio Alert II software, go to the Audio Alert II sub-directory in the CD-Pro disc that came bundled with your PC.
2. Reboot the system.
3. From **Start Icon** click through to **Audio Alert II Icon**.

The Audio Alert II - Windows GUI will appear on your screen

4. Audio Menu. Highlight to select Selection Control Panel
5. Selection Control Panel.



Language Select: Select default language - English/Chinese/Japanese



Previous Message: Play the message previously recorded



Record to Flash-Memory: Press to update your own recordings to flash-memory



Default Recording: Play back default message

6. Recording Control Panel



Play Button: Play message / your recorded message as highlighted



Stop Button: Stop playing message / your recorded message



Record Button: Press to make your own recorded message

Example

1. You would like to replace the default **CPU Detect** message with your own recording.
2. Select **CPU Detect** as per **4.** above.
3. Plug in a microphone to your MIC_IN jack.
4. Double Click the **Record Button** and make your voice recording.
5. Double Click the **Stop Button** when you have completed your recording.
6. Double Click the **Play Button** to listen to your recording.
7. If you are satisfied with the recording you have made, click **Record to Flash-Memory Button**, as per **5.** above, or if you would like to re-record, repeat steps 4. to 6. in this example. (The re-flashing process will take approx. 6 minutes.)

This Page Left Blank for Note

Installation Procedures

The mainboard has several user-adjustable jumpers on the board that allow you to configure your system to suit your requirements. This chapter contains information on the various jumper settings on your mainboard.

To set up your computer, you must complete the following steps:

- Step 1 - Set system jumpers
- Step 2 - Install memory modules
- Step 3 - Install the Central Processing Unit (CPU)
- Step 4 - Install expansion cards
- Step 5 - Connect ribbon cables, cabinet wires, and power supply
- Step 6 - Set up BIOS software
- Step 7 - Install supporting software tools



WARNING: Excessive torque may damage the mainboard. When using an electric screwdriver on the mainboard, make sure that the torque is set to the allowable range of 5.0 ~ 8.0kg/cm.

Mainboard components contain very delicate Integrated Circuit (IC) chips. To prevent static electricity from harming any of the mainboard's sensitive components, you should follow the following precautions whenever working on the computer:

1. Unplug the computer when working on the inside.
2. Hold components by the edges and try not to touch the IC chips, leads, or circuitry.
3. Wear an anti-static wrist strap which fits around the wrist.
4. Place components on a grounded anti-static pad or on the bag that came with the component whenever the components are separated from the system.

Quick Reference (from Page 2-2 to 2-6)

Mainboard Layout

Chapter 2
Installation
Procedures

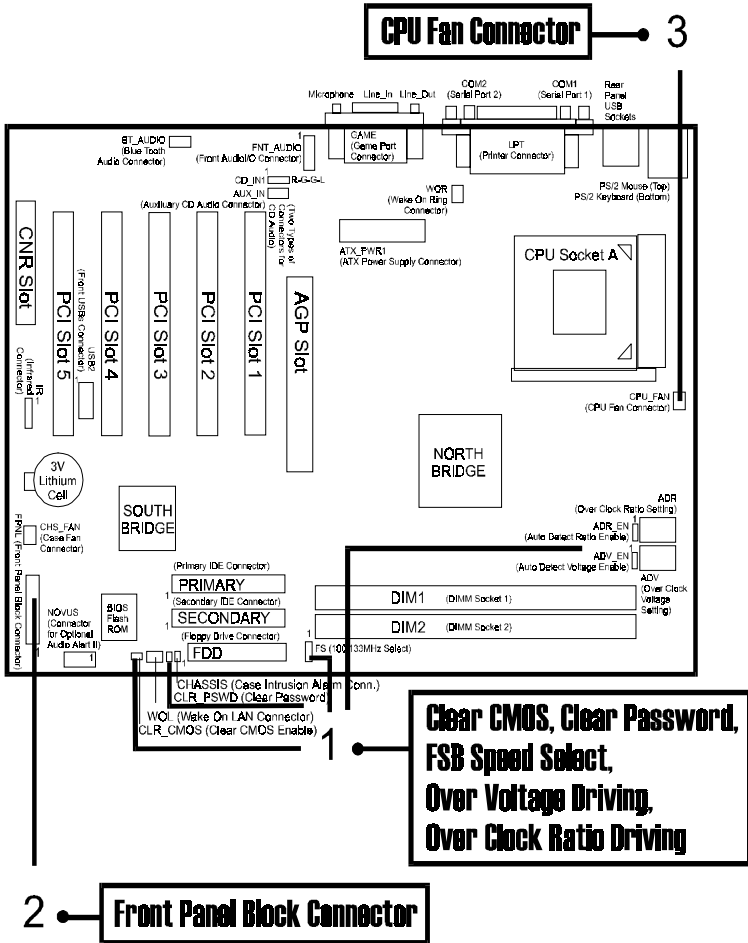

- 1). **Clear CMOS, Clear Password,
FSB Speed Select,
Auto Detect Freq. Ratio (ADR_EN, ADR)
Auto Detect CPU Core Voltage (ADV_EN, ADV)**

**CLR_CMOS
(Clear CMOS)**

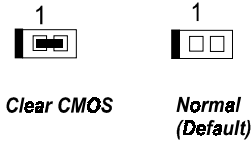

**CLR_PSWD
(Clear Password)**

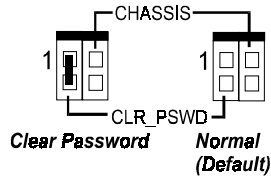

**Chapter 2
Installation
Procedures**

**FS
(Front Side Bus Speed Select:
100MHz/133MHz)**

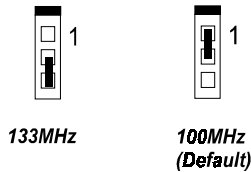

ADV
(CPU Core Voltage Setting)

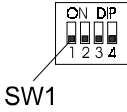

ADV_EN
(Auto Detect CPU Core Voltage)



Enable
(Default)



Disable

CPU Voltage	SW1	SW2	SW3	SW4
1.850 V	ON	ON	ON	ON
1.825 V	OFF	ON	ON	ON
1.800 V	ON	OFF	ON	ON
1.775 V	OFF	OFF	ON	ON
1.750 V	ON	ON	OFF	ON
1.725 V	OFF	ON	OFF	ON
1.700 V	ON	OFF	OFF	ON
* 1.475 V	OFF	OFF	OFF	OFF

(* : Default)



NOTE: Please set the jumper ADV_EN at Disable before you adjust the switch ADV.

ADR
(Freq. Ratio Setting)

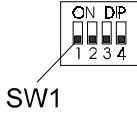

ADR_EN
(Auto Detect CPU Freq.)



Enable
(Default)



Disable

Ratio	SW1	SW2	SW3	SW4
11 X	ON	ON	ON	ON
11.5 X	OFF	ON	ON	ON
12 X	ON	OFF	ON	ON
>= 12.5 X	OFF	OFF	ON	ON
5 X	ON	ON	OFF	ON
5.5 X	OFF	ON	OFF	ON
6 X	ON	OFF	OFF	ON
6.5 X	OFF	OFF	OFF	ON
7 X	ON	ON	ON	OFF
7.5 X	OFF	ON	ON	OFF
8 X	ON	OFF	ON	OFF
8.5 X	OFF	OFF	ON	OFF
9 X	ON	ON	OFF	OFF
9.5 X	OFF	ON	OFF	OFF
10 X	ON	OFF	OFF	OFF
* 10.5 X	OFF	OFF	OFF	OFF

(* : Default)



NOTE: Please set the jumper ADR_EN at Disable before you adjust the switch ADR.

2). Front Panel Block Cable Connection

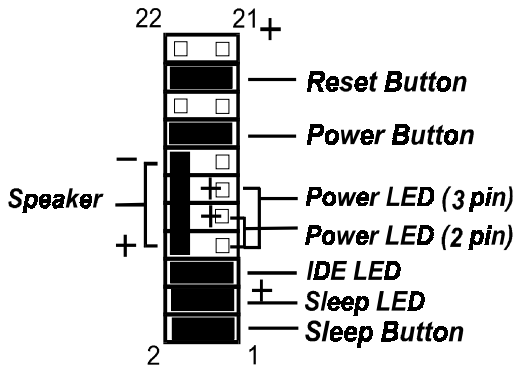

3). CPU Fan Installation

This connector is linked to the CPU fan. When the system is in suspend mode, the CPU fan will turn off; when it reverts back to full on mode, the fan will turn back on. Without sufficient air circulation, the CPU may overheat resulting in damage to both the CPU and the mainboard.

Damage may occur to the mainboard and/or the CPU fan if these pins are used incorrectly. These are not jumpers, do not place jumper caps over these pins.

1). Set System Jumpers/Switches

Jumpers are used to select the operation modes for your system. Some jumpers on the board have three metal pins with each pin representing a different function. A “1” is written besides pin 1 on jumpers with three pins. To **set** a jumper, a black cap containing metal contacts is placed over the jumper pin/s according to the required configuration. A jumper is said to be **shorted** when the black cap has been placed on one or two of its pins. The types of jumpers used in this manual are shown below:

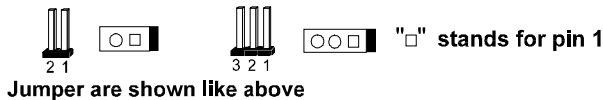
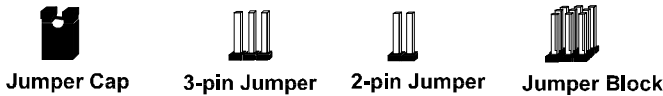

Jumper are shown like above



Jumper cap like above



Jumpers in a Block



NOTE: Users are not encouraged to change the jumper settings not listed in this manual. Changing the jumper settings improperly may adversely affect system performance.

Clear CMOS: CLR_CMOS

The jumper allows you to enable or to disable the password setting. You may need to adjust it if you forget your password. To clear the password setting: (1). Turn off your computer, (2). Enable this feature by setting it at Enable, (3). Turn on your computer to boot screen, (4). Turn off your computer, (5). Disable the Clear Password feature by setting it at Disble, (6). Turn on your computer. Press Delete key to load setup default values.

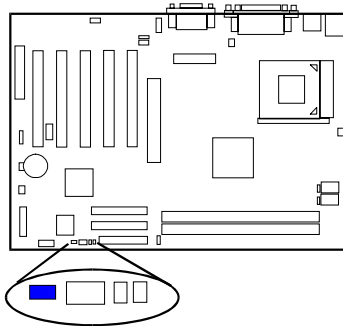
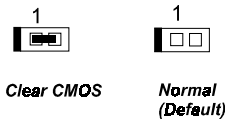

Clear Password: CLR_PSWD

This jumper allows you to enable or to disable the password configuration. You may need to enable this jumper by shorting it with a jumper cap if you forget your password. To clear the password setting: (1). Turn off your computer, (2). Short this jumper by placing a jumper cap on it; (3). Turn on your computer, (4). Hold down the Delete key during boot and enter BIOS Setup to re-enter user preferences, (5). Turn off your computer, (6). Remove the jumper cap, (7). Turn on your computer for the new settings to take effect.

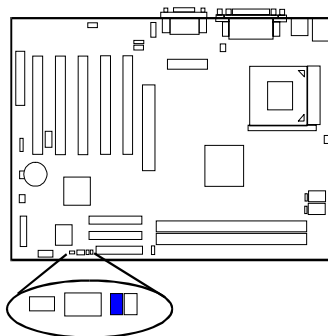
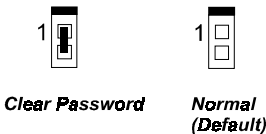

FSB Speed Select: 100MHz/133MHz

The jumper allows users to select the front side bus speed.

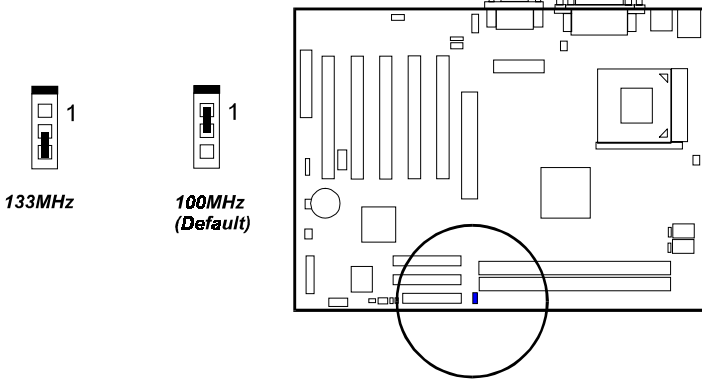

Auto Detect CPU Core Voltage: ADV_EN

The 3-pin jumper allows the system to detect the processor core voltage automatically when it stays at Enable.



WARNING: Voltage and frequency above CPU's original specifications are not guaranteed to be stable.

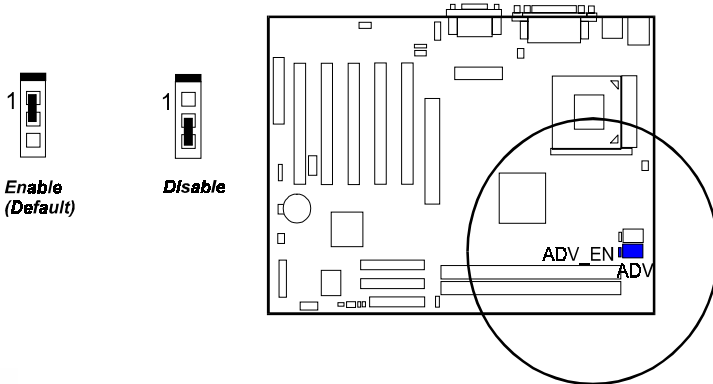

NOTE: Please set the jumper ADV_EN at Disable before you adjust the switch ADV.

CPU Core Voltage Setting: ADV

The switch allows you to set the CPU core voltage to approach the best performance according to the table below after you set the jumper ADV at Disable.

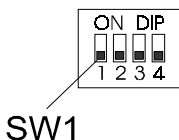

<i>CPU Voltage</i>	<i>SW1</i>	<i>SW2</i>	<i>SW3</i>	<i>SW4</i>
1.850 V	ON	ON	ON	ON
1.825 V	OFF	ON	ON	ON
1.800 V	ON	OFF	ON	ON
1.775 V	OFF	OFF	ON	ON
1.750 V	ON	ON	OFF	ON
1.725 V	OFF	ON	OFF	ON
1.700 V	ON	OFF	OFF	ON
1.475 V*	OFF	OFF	OFF	OFF

(* : Default)

Auto Detect CPU Clock: ADR_EN

The 3-pin jumper allows the system to detect the processor clock automatically when it stays at Enable; and allows users to set the CPU clock ratio when they want to do so.



WARNING: Voltage and frequency above CPU's original specifications are not guaranteed to be stable.



**Enable
(Default)**



Disable

Bus Ratio Setting: ADR

The switch allows you to set the bus ratio to approach the best performance according to the table below after you set the jumper ADR at Disable.

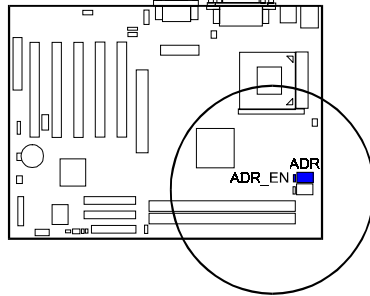
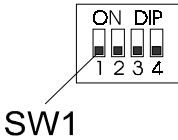

**Chapter 2
Installation
Procedures**

Ratio	SW1	SW2	SW3	SW4
11 X	ON	ON	ON	ON
11.5 X	OFF	ON	ON	ON
12 X	ON	OFF	ON	ON
>= 12.5 X	OFF	OFF	ON	ON
5 X	ON	ON	OFF	ON
5.5 X	OFF	ON	OFF	ON
6 X	ON	OFF	OFF	ON
6.5 X	OFF	OFF	OFF	ON
7 X	ON	ON	ON	OFF
7.5 X	OFF	ON	ON	OFF
8 X	ON	OFF	ON	OFF
8.5 X	OFF	OFF	ON	OFF
9 X	ON	ON	OFF	OFF
9.5 X	OFF	ON	OFF	OFF
10 X	ON	OFF	OFF	OFF
* 10.5 X	OFF	OFF	OFF	OFF

(* : Default)



NOTE: Please set the jumper ADR_EN at Disable before you adjust the switch ADR.

2). Install Memory Modules

1. Locate the memory moduleslots on the mainboard.
2. Install the memory module straight down into the memory module slot using both hands.
3. The clip on both ends of the memory module slot will close up to hold the memory module in place when the memory module reaches the slot's bottom.

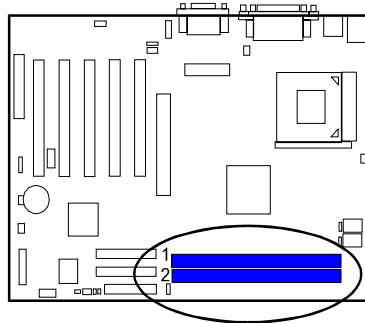

Press the clips with both hands to remove the memory module.

3). Install the CPU

The AMD Athlon/Duron CPU module resides in the Socket A socket on the board. Please follow the steps introduced below to complete the CPU installation.

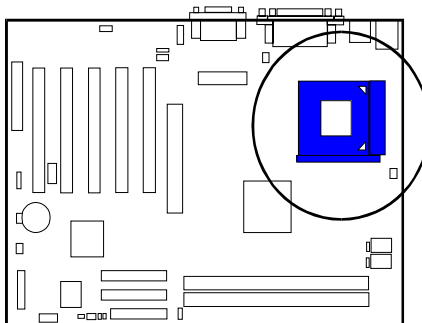



CAUTION:

1. The heat sink and fan you installed must be approved by AMD.
2. The mainboard must be placed on a solid place to avoid shaking while install the heat sink and fan on the board.
3. The heat sink must be contact with the CPU top tightly.
4. Never run the processor without the heat sink properly and firmly attached. PERMANENT DAMAGE WILL RESULT!

To install the CPU, do the following:

1. Lift the lever on the side of the CPU socket.
2. Handle the chip by its edges and try not to touch any of the pins.
3. Place the CPU in the socket. The chip has two notches to correctly locate the chip. Align two notches of the processor with the two triangular marks on the socket. Do not force the chip. The CPU should slide easily into the socket.
4. Swing the lever to the down position to lock the CPU in place.
5. Install the cooling fan with heat sink on top of the installed CPU.
6. Place the mainboard (with the CPU, its cooling fan, and heat sink) into the system chassis and affix it with screws.

4). Install Expansion Cards

This section describes how to connect an expansion card to one of your system's expansion slots. Expansion cards are printed circuit boards that, when connected to the mainboard, increase the capabilities of your system. For example, expansion cards can provide video and sound capabilities. The mainboard features one CNR audio/modem, one AGP, and five PCI bus expansion slots.

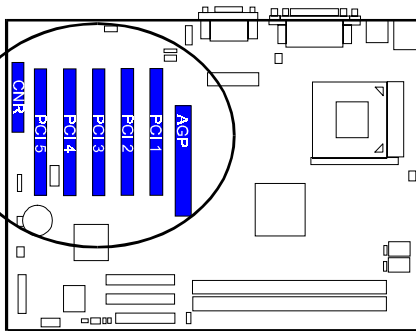

Chapter 2
Installation
Procedures



CAUTION: Make sure to unplug the power supply when adding or removing expansion cards or other system components. Failure to do so may cause severe damage to both the mainboard and expansion cards.

Always observe static electricity precautions.

Please read "Handling Precautions" at the start of this manual.

To install an expansion card, follow the steps below:

1. Remove the computer chassis cover and select an empty expansion slot.
2. Remove the corresponding slot cover from the computer chassis. Unscrew the mounting screw that secures the slot cover and pull the slot cover out from the computer chassis. Keep the slot cover mounting screw nearby.

3. Holding the edge of the peripheral card, carefully align the edge connector with the expansion slot.
4. Push the card firmly into the slot. Push down on one end of the expansion card, then the other. Use this “rocking” motion until the add-on card is firmly seated inside the expansion slot.
5. Secure the board with the mounting screw removed in Step 2. Make sure that the card has been placed evenly and completely into the expansion slot.
6. Replace the computer system’s cover.
7. Setup the BIOS if necessary.
8. Install the necessary software drivers for the expansion card.

5). Connect Devices

Floppy Diskette Drive Connector: FDD

This connector provides the connection with your floppy disk drive. The red stripe of the ribbon cable must be the same side with the Pin 1.

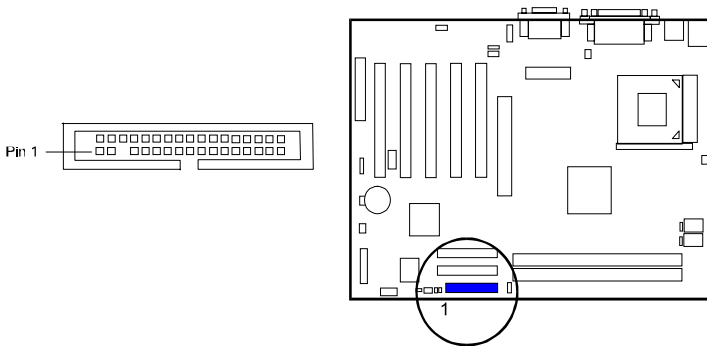

IDE Device Connectors: PRIMARY, SECONDARY

These two connectors are used for your IDE hard disk drives, CD drives, LS-120 drives, or IDE ZIP drives. The red stripe of the ribbon cable must be the same side with the Pin 1.

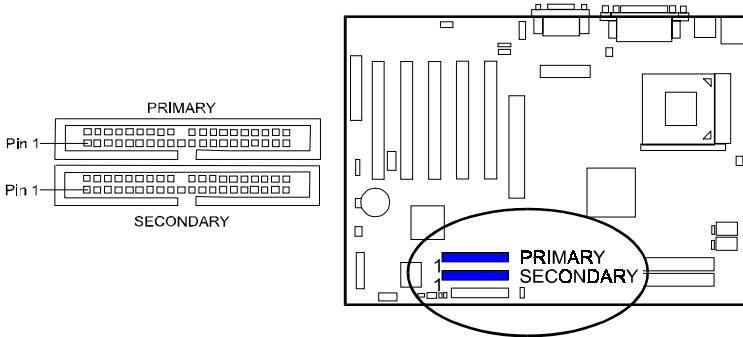

**Chapter 2
Installation
Procedures**

ATX Power Connector: ATX_PWRI

This 20-pin male block connector is connected to the ATX power supply. The plug from the power supply will only insert in one orientation because of the different hole sizes. Find the proper orientation and push down firmly making sure that the pins are aligned.

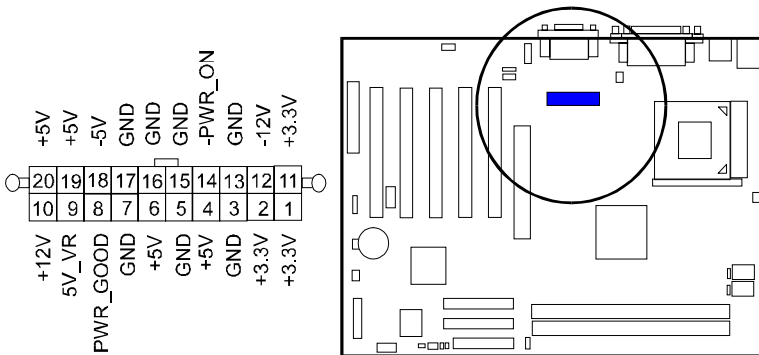

CPU Fan Connector: CPU_FAN

This connector is linked to the CPU fan to lower the CPU temperature. Please refer to the CPU fan installation manual for more information.

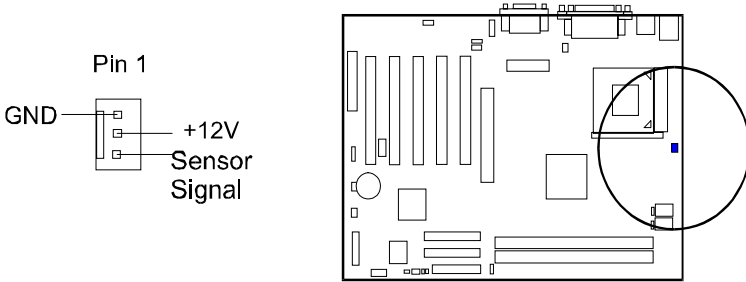

**Chapter 2
Installation
Procedures**

System Case Fan Connector: CHS_FAN

The 3-pin connector allows you to link with the cooling fan on the system case to lower the system temperature.

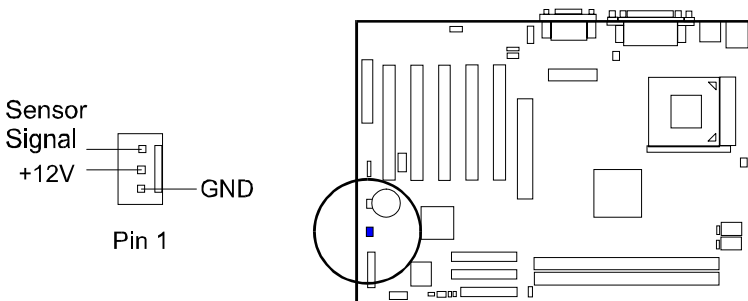

Wake-On-Ring Connector: WOR

The 2-pin connector allows you to link with your modem card which outputs a WOR signal; the system can be turned on from the power-off status by a remote phone call via the modem card.

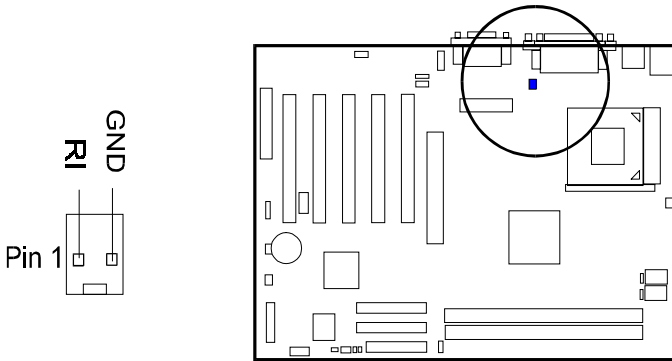

Wake-On-Lan Connector: WOL

This 3-pin connector allows the remote servers to manage the system that installed this mainboard via your network adapter which also supports WOL. When you install such a LAN card, please read its installation guide for more information.

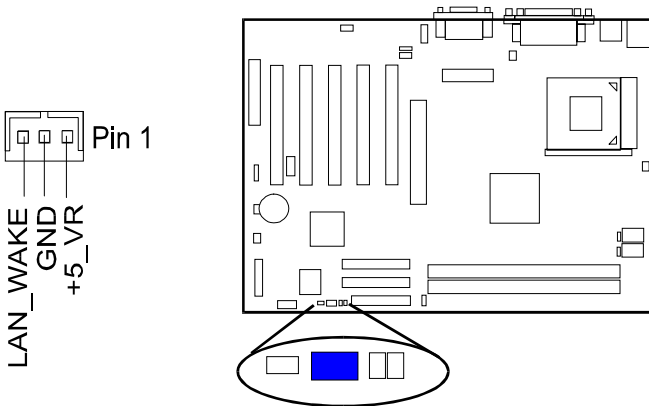

System Chassis Open Alarm Connector: CHASSIS

The 2-pin male connector allows you to enable (or disable) system activation if and when the system's out casing is being removed. A high level signal to the connector will indicate to the system that the chassis has been opened.

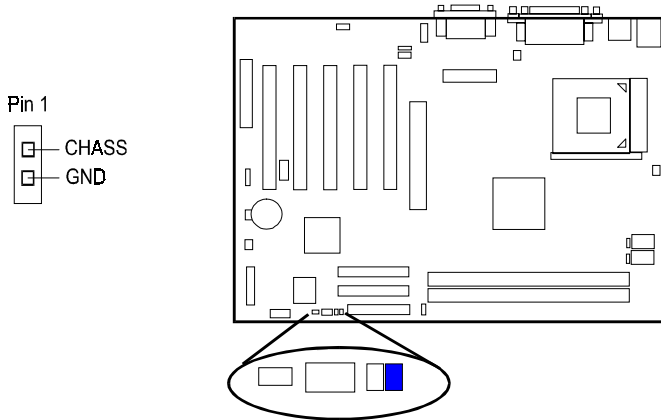

**Chapter 2
Installation
Procedures**

Blue Tooth Audio Port Connector: BT_AUDIO

The 4-pin connector allows you to link to an optional FIC-produced metal brakcet with Blue Tooth audio port.

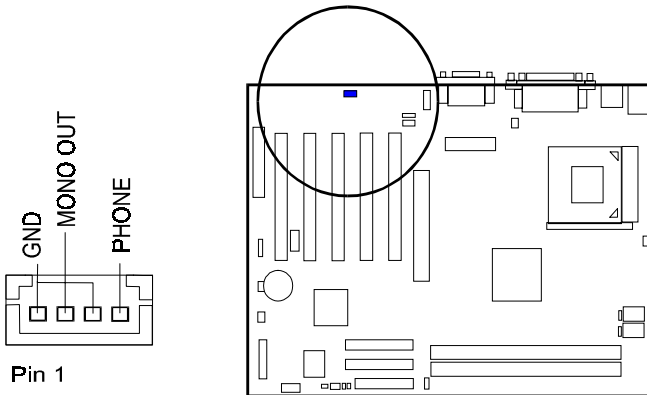

CD Audio-In Connectors: CD_IN1, AUX_IN

The CD_IN1, AUX_IN connectors are used for different types for CD drive audio in port.

**Chapter 2
Installation
Procedures**

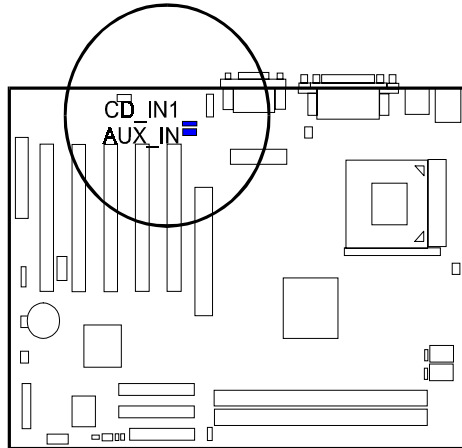
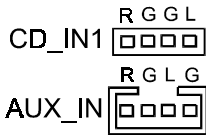

Optional Audio Alert II Module Connector: NOVUS

The connector provides users with the linkages of optional Audio Alert II module.

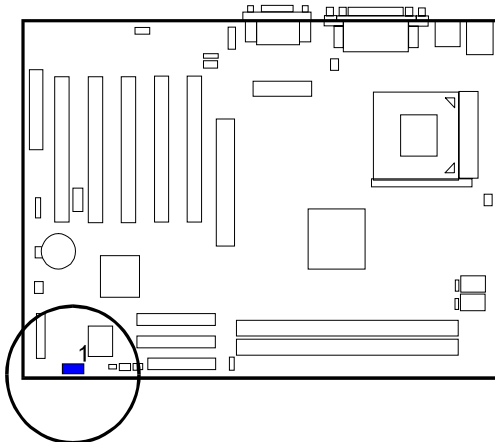

Infrared Connector: IR

This 5-pin connector is used to link with your IR device to allow data transmission to another system that equipped with an IR device.

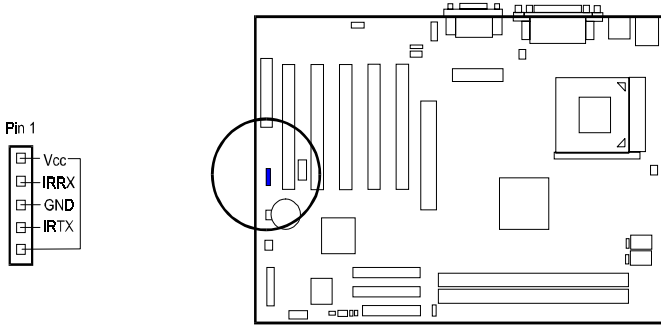

**Chapter 2
Installation
Procedures**

Front Panel Block Connector: FPNL

This block connector includes the connectors for linking with IDE LED, sleep LED, power LED, power button, sleep button, reset button and speaker on the front panel of the system case. Please identify polarities of plug wires for the case speaker and LEDs. Please ask vendor about this information when you buy them and install the system by yourself. The plug wire polarities of these buttons will not affect the function.

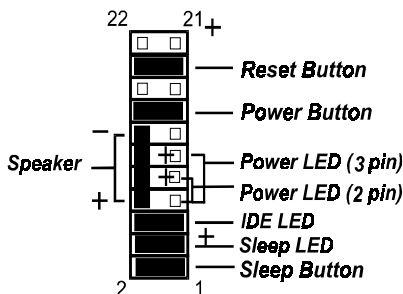

Reset Button is connected to the reset button. Push this switch to reboot the system instead of turning the power button off and on.

Power Button is connected with power button. Push this switch allows the system to be turned on and off rather than using the power supply button.

Power LED is connected with the system power indicator to indicate whether the system is on/off. It will blink when the system enters suspend mode.

Speaker is connected with the case speaker.

IDE LED is connected to the IDE device indicator. This LED will blink when the hard disk drives are activated.

Sleep LED is connected with sleep mode indicator.

Sleep Button is connected to the sleep button. Push this switch to enter the power saving mode while system in full-on mode.

PS/2 Keyboard and Mouse Connector: PS2_KB, PS2_MS

These two 6-pin female (PS/2 keyboard is purple color and PS/2 mouse is green color) connectors are used for your PS/2 keyboard and PS/2 mouse.

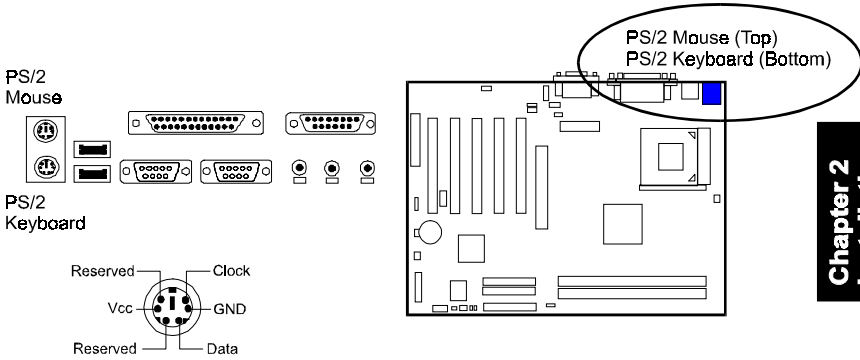

**Chapter 2
Installation
Procedures**

Universal Serial Bus Connectors: Rear USBs, Front USBs

These two black connectors integrated on the edge of the board are used for linking with USB peripheral devices. This board also provides a connector USB2 for linking with the two USB sockets on the front panel of some system cases.

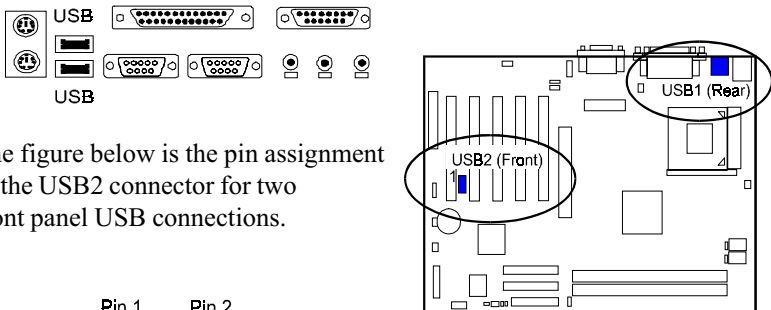

The figure below is the pin assignment of the USB2 connector for two front panel USB connections.

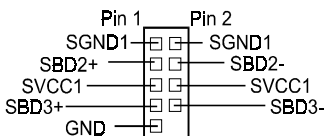

Printer Connector: LPT

This 25-pin D-Sub female burgundy-colored connector is attached to your printer.

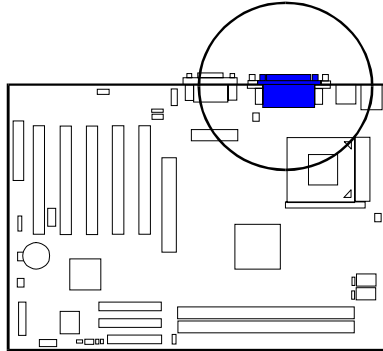
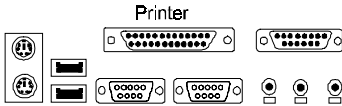

Serial Port Connectors: COM1, COM2

COM1 (9-pin D-sub male connector with teal color) and COM2 (9-pin D-sub teal male connector with teal color) allow you to connect with your devices that use serial ports, such as a serial mouse or an external modem.

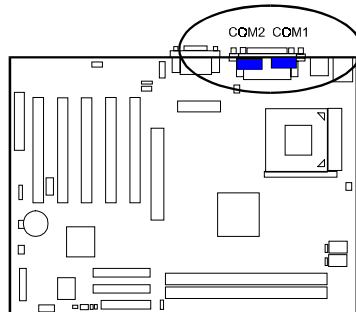
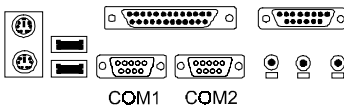

Audio I/O Jacks: LINE_OUT, LINE_IN, MIC_IN, FNT_AUDIO

LINE_OUT (lime) can be connected to headphones or preferably powered speakers. LINE_IN (light blue) allows tape players or other audio sources to be recorded by your computer or played through the LINE_OUT. MIC_IN (pink) allows microphones to be connected for voice input. The mainboard also provides you with a front panel audio port connector, FNT_AUDIO, when needed. Its pin definitions were presented below.

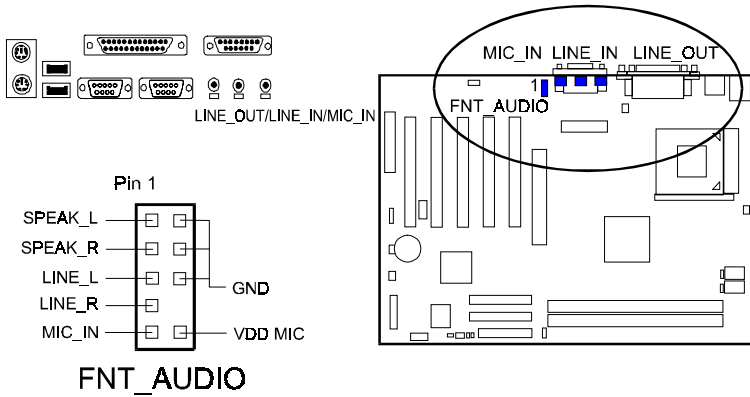

**Chapter 2
Installation
Procedures**

Game/MIDI Connector: GAME

This 15-pin female gold-colored connector allows you to connect game joysticks or game pads. Connect MIDI devices for playing or editing audio.

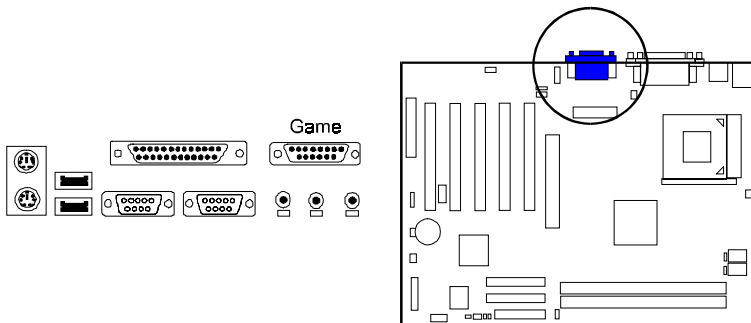

This Page Left Blank for Note

BIOS Setup

The mainboard comes with the chip that Award BIOS that contains the ROM Setup information of your system. (This chip serves as an interface between the processor and the rest of the mainboard's components.) This section explains the information contained in the Setup program and tells you how to modify the settings according to your system configuration.

CMOS Setup Utility

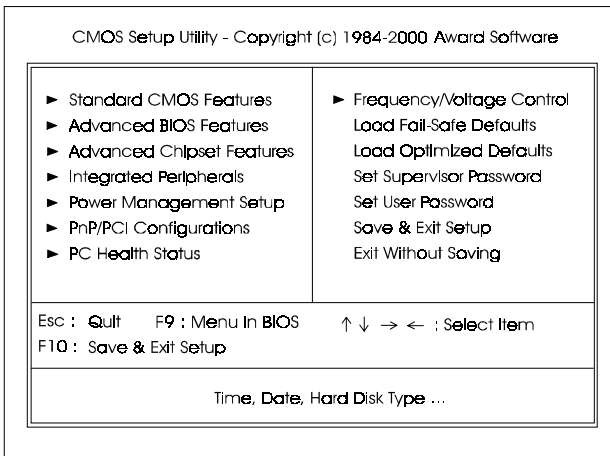

A Setup program, built into the system BIOS, is stored in the BIOS flash ROM. This Setup utility program allows changes to the mainboard configuration settings. It is executed when the user changes system configuration; user changes system backup battery; or the system detects a configuration error and asks the user to run the Setup program. Use the arrow keys to select and press **Enter** to run the selected program.

Standard CMOS Setup

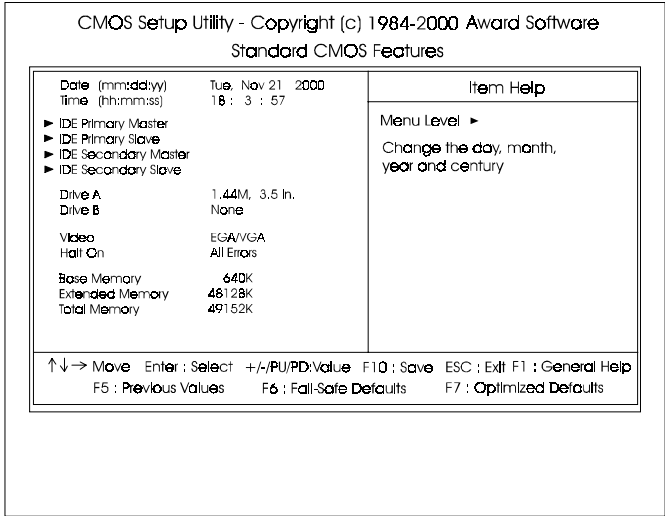

Chapter 3
BIOS Setup

The Standard CMOS Setup screen is displayed above. Each item may have one or more option settings. The system BIOS automatically detects memory size, thus no changes are necessary. Use the arrow keys to highlight the item and then use **PgUp** or **PgDn** keys to select the value you want in each item.

Date

To set the date, highlight the *Date* field and then press **Page Up/Page Down** or +/- keys to set the current date. Follow the month, day and year format.

Time

To set the time, highlight the *Time* field and then press **Page Up/Page Down** or +/- keys to set the current time. Follow the hour, minute, and second format.

Hard Disks

This field records the specifications for all non-SCSI hard drives installed in the system. The onboard PCI IDE connectors provide Primary and Secondary channels for connecting up to four IDE hard disks or other IDE devices. Each channel can support up to two hard disks, the first of which is the *Master* and the second is the *Slave*.

Hard Disk Configurations

Capacity:	The hard disk size. The unit is Bytes.
Cylinder:	The cylinder number of the hard disk.
Head:	The read/write head number of hard disk.
Precomp:	The cylinder number at which the disk drive changes the write current.
Landing Zone:	The cylinder number that the disk drive heads (read/write) are seated when the disk drive is parked.
Sector:	The sector number of each track defined on the hard disk.

Drive A / Drive B

This field records the types of floppy drives installed in the system. To enter the configuration value for a particular drive, highlight its corresponding field and then select the drive type using the **left-** or **right-arrow** key.

Video

Set this field to the type of video display card installed in the system.

Halt On

This field determines which types of errors will cause the system to halt.

Advanced BIOS Features

CMOS Setup Utility - Copyright (c) 1984-2000 Award Software

Advanced BIOS Features

<table style="width: 100%; border-collapse: collapse;"> <tr><td>Anti-Virus Protection</td><td>Disabled</td></tr> <tr><td>CPU Internal Cache</td><td>Enabled</td></tr> <tr><td>External Cache</td><td>Enabled</td></tr> <tr><td>Quick Power On Self Test</td><td>Enabled</td></tr> <tr><td>First Boot Device</td><td>Floppy</td></tr> <tr><td>Second Boot Device</td><td>HDD-0</td></tr> <tr><td>Third Boot Device</td><td>CDROM</td></tr> <tr><td>Boot Other Device</td><td>Enabled</td></tr> <tr><td>Swap Floppy Drive</td><td>Disabled</td></tr> <tr><td>Boot Up Floppy Seek</td><td>Enabled</td></tr> <tr><td>Boot Up NumLock Status</td><td>On</td></tr> <tr><td>Typeomatic Rate Setting</td><td>Disabled</td></tr> <tr><td>x Typeomatic Rate (Chars/Sec)</td><td>6</td></tr> <tr><td>x Typeomatic Delay (Msec)</td><td>250</td></tr> <tr><td>Security Option</td><td>Setup</td></tr> <tr><td>OS Select For DRAM > 64MB</td><td>Non-OS2</td></tr> <tr><td>HDD S.M.A.R.T. Capability</td><td>Disabled</td></tr> <tr><td>Report No FDD For WIN 95</td><td>Yes</td></tr> <tr><td>Video BIOS Shadow</td><td>Enabled</td></tr> </table>	Anti-Virus Protection	Disabled	CPU Internal Cache	Enabled	External Cache	Enabled	Quick Power On Self Test	Enabled	First Boot Device	Floppy	Second Boot Device	HDD-0	Third Boot Device	CDROM	Boot Other Device	Enabled	Swap Floppy Drive	Disabled	Boot Up Floppy Seek	Enabled	Boot Up NumLock Status	On	Typeomatic Rate Setting	Disabled	x Typeomatic Rate (Chars/Sec)	6	x Typeomatic Delay (Msec)	250	Security Option	Setup	OS Select For DRAM > 64MB	Non-OS2	HDD S.M.A.R.T. Capability	Disabled	Report No FDD For WIN 95	Yes	Video BIOS Shadow	Enabled	<p style="text-align: center;">Item Help</p> <p>Menu Level ▶</p> <p>Allows you to choose feature for IDE Hard Disk boot sector protection. If this function is enabled and someone attempt to write data into this area, BIOS will show a warning message on screen and alarm beep</p>
Anti-Virus Protection	Disabled																																						
CPU Internal Cache	Enabled																																						
External Cache	Enabled																																						
Quick Power On Self Test	Enabled																																						
First Boot Device	Floppy																																						
Second Boot Device	HDD-0																																						
Third Boot Device	CDROM																																						
Boot Other Device	Enabled																																						
Swap Floppy Drive	Disabled																																						
Boot Up Floppy Seek	Enabled																																						
Boot Up NumLock Status	On																																						
Typeomatic Rate Setting	Disabled																																						
x Typeomatic Rate (Chars/Sec)	6																																						
x Typeomatic Delay (Msec)	250																																						
Security Option	Setup																																						
OS Select For DRAM > 64MB	Non-OS2																																						
HDD S.M.A.R.T. Capability	Disabled																																						
Report No FDD For WIN 95	Yes																																						
Video BIOS Shadow	Enabled																																						

↑↓→ Move Enter : Select +/-/PU/PD:Value F10 : Save ESC : Exit F1 : General Help
 F5 : Previous Values F6 : Fail-Safe Defaults F7 : Optimized Defaults

CMOS Setup Utility - Copyright (c) 1984-2000 Award Software

Advanced BIOS Features

<table style="width: 100%; border-collapse: collapse;"> <tr><td>First Boot Device</td><td>Floppy</td></tr> <tr><td>Second Boot Device</td><td>HDD-0</td></tr> <tr><td>Third Boot Device</td><td>CDROM</td></tr> <tr><td>Boot Other Device</td><td>Enabled</td></tr> <tr><td>Swap Floppy Drive</td><td>Disabled</td></tr> <tr><td>Boot Up Floppy Seek</td><td>Enabled</td></tr> <tr><td>Boot Up NumLock Status</td><td>On</td></tr> <tr><td>Typeomatic Rate Setting</td><td>Disabled</td></tr> <tr><td>x Typeomatic Rate (Chars/Sec)</td><td>6</td></tr> <tr><td>x Typeomatic Delay (Msec)</td><td>250</td></tr> <tr><td>Security Option</td><td>Setup</td></tr> <tr><td>OS Select For DRAM > 64MB</td><td>Non-OS2</td></tr> <tr><td>HDD S.M.A.R.T. Capability</td><td>Disabled</td></tr> <tr><td>Report No FDD For WIN 95</td><td>Yes</td></tr> <tr><td>Video BIOS Shadow</td><td>Enabled</td></tr> <tr><td>BIOS Guardian</td><td>Enabled</td></tr> <tr><td>Audio Alert II Function</td><td>Enabled</td></tr> <tr><td>Maintenance Month</td><td>0</td></tr> <tr><td>Maintenance Date</td><td>0</td></tr> </table>	First Boot Device	Floppy	Second Boot Device	HDD-0	Third Boot Device	CDROM	Boot Other Device	Enabled	Swap Floppy Drive	Disabled	Boot Up Floppy Seek	Enabled	Boot Up NumLock Status	On	Typeomatic Rate Setting	Disabled	x Typeomatic Rate (Chars/Sec)	6	x Typeomatic Delay (Msec)	250	Security Option	Setup	OS Select For DRAM > 64MB	Non-OS2	HDD S.M.A.R.T. Capability	Disabled	Report No FDD For WIN 95	Yes	Video BIOS Shadow	Enabled	BIOS Guardian	Enabled	Audio Alert II Function	Enabled	Maintenance Month	0	Maintenance Date	0	<p style="text-align: center;">Item Help</p> <p>Menu Level ▶</p> <p>Setting date of maintenance time.</p>
First Boot Device	Floppy																																						
Second Boot Device	HDD-0																																						
Third Boot Device	CDROM																																						
Boot Other Device	Enabled																																						
Swap Floppy Drive	Disabled																																						
Boot Up Floppy Seek	Enabled																																						
Boot Up NumLock Status	On																																						
Typeomatic Rate Setting	Disabled																																						
x Typeomatic Rate (Chars/Sec)	6																																						
x Typeomatic Delay (Msec)	250																																						
Security Option	Setup																																						
OS Select For DRAM > 64MB	Non-OS2																																						
HDD S.M.A.R.T. Capability	Disabled																																						
Report No FDD For WIN 95	Yes																																						
Video BIOS Shadow	Enabled																																						
BIOS Guardian	Enabled																																						
Audio Alert II Function	Enabled																																						
Maintenance Month	0																																						
Maintenance Date	0																																						

↑↓→ Move Enter : Select +/-/PU/PD:Value F10 : Save ESC : Exit F1 : General Help
 F5 : Previous Values F6 : Fail-Safe Defaults F7 : Optimized Defaults

Anti-Virus Protection

This feature starts the virus scan tool to detect if boot virus in boot sector of the first boot device when booting up.

The options are: Enabled, Disabled.

CPU Internal Cache

When enabled, improves the system performance. Disable this item when testing or trouble-shooting. The options are: Enabled, Disabled.

External Cache

When enabled, supports an optional cache SRAM. This feature allows you to disable the cache function when the system performance is unstable to run some software. The options are: Enabled, Disabled.

Quick Power On Self Test

When enabled, allows the BIOS to bypass the extensive memory test.

The options are: Enabled, Disabled.

First Boot Device

This feature allows user to select the boot device priority.

The options are: Floppy, LS120, HDD-0, SCSI, CDROM, HDD-1, HDD-2, HDD-3, ZIP100, USB-FDD, USB-ZIP, USB-CDROM, USB-HDD, LAN, Disabled.

Second Boot Device

This feature allows user to select the boot device priority.

The options are: Floppy, LS120, HDD-0, SCSI, CDROM, HDD-1, HDD-2, HDD-3, ZIP100, USB-FDD, USB-ZIP, USB-CDROM, USB-HDD, LAN, Disabled.

Third Boot Device

This feature allows user to select the boot device priority.

The options are: Floppy, LS120, HDD-0, SCSI, CDROM, HDD-1, HDD-2, HDD-3, ZIP100, USB-FDD, USB-ZIP, USB-CDROM, USB-HDD, LAN, Disabled.

Boot Other Device

This feature allows user to select the boot device priority.

The options are: Enabled, Disabled.

Swap Floppy Drive

Allows you to switch the order of floppy drives.
The options are: Enabled, Disabled.

Boot Up Floppy Seek

When enabled, this feature enable the test of floppy drives to determine whether they have 40 or 80 tracks.
The options are: Enabled, Disabled.

Boot Up Numlock Status

When set to On, allows the BIOS to automatically enable the Num Lock Function when the system boots up. The options are: On, Off.

Typematic Rate Setting

The term typematic means that when a keyboard key is held down, the character is repeatedly entered until the key is released.
The options are: Disabled, Enabled.

Typematic Rate (Chars/Sec)

This feature is available only if the above item, Typematic Rate Setting, is set at Enabled. Sets the rate of a character repeat when the key is held down. The options are: 6, 8, 10, 12, 15, 20, 24, 30.

Typematic Delay (Msec)

This feature is available only if the item, Typematic Rate Setting, is set at Enabled. Sets the delay time before a character is repeated.
The options are: 250, 500, 750, 1000 millisecond.

Security Option

Allows you to set the security level of the system.
The options are: Setup, System.

OS Select For DRAM > 64MB

If your operating system (OS) is OS/2 and main memory size over 64MB, select the option OS2. Otherwise, stay with the default setting Non-OS2.
The options are: Non-OS2, OS2.

HDD S.M.A.R.T. Capability

S.M.A.R.T. stands for Self-Monitoring and Analysis Reporting Technology which allows your hard disk drive to report any read/write errors and issues a warning with hard disk monitor utilities.

The options are: Disabled, Enabled.

Report No FDD For WIN 95

When the field under the Standard CMOS Setup Menu for Drive A and/or Drive B is set at None, users must set this field is set at Yes for it to function properly. Otherwise, set at No, even if field for Drive A and/or Drive B is set at None, system will still detect and recognize of a floppy drive(s).

The options are: Yes, No.

Video BIOS Shadow

Allows the BIOS to copy the video ROM code of the add-on video card to the system memory for faster access.

The options are: Enabled, Disabled.

BIOS Guardian

It allows the system to prevent computer viruses. Users will need to disable it to update BIOS. The options are: Enabled, Disabled.



NOTE: Please disable this BIOS feature about BIOS Guardian before you start to reflash BIOS.

Audio Alert II Function

It allows you to disable the FIC Audio Alert II function. If you have Audio Alert II onboard, its function works normally when set at Enabled.

The options are: Enabled, Disabled.

Maintenance Month

It allows you to set the month of maintenance time.

The options are: 0, January, Febuary, ... , December.

Maintenance Date

It allows you to set the date of maintenance time.

The options are: 0, 1, ..., 31.

Advanced Chipset Features

CMOS Setup Utility - Copyright (c) 1984-2000 Award Software
Advanced Chipset Features

System BIOS Cacheable	Enabled		Item Help
Video BIOS Cacheable	Enabled		Menu Level ▶
Video RAM Cacheable	Disabled		
Memory Hole At 15M-16M	Disabled		
AGP Aperture Size (MB)	64		
AGP ISA Aliasing	Enabled		
AGP Secondary Lat Timer	20h		
AGP Fast Write	Enabled		
AGP Data Transfer Mode	4x		
K7 CLK_CTL Select	Optimal		
SDRAM ECC Setting	Disabled		
Super Bypass Mode	Enabled		
SDRAM Timing setting by	Auto		
x SDRAM PH Limit	8 Cycle		
x SDRAM Idle Limit	8 Cycle		
x SDRAM Trc Timing Value	8 Cycle		
x SDRAM Trp Timing Value	3 Cycle		
x SDRAM Tras Timing Value	7 Cycle		
x SDRAM CAS latency	2 Cycle		

↑↓→ Move Enter : Select +/-/PU/PD:Value F10 : Save ESC : Exit F1 : General Help
 F5 : Previous Values F6 : Fail-Safe Defaults F7 : Optimized Defaults

CMOS Setup Utility - Copyright (c) 1984-2000 Award Software
Advanced Chipset Features

Video BIOS Cacheable	Enabled		Item Help
Video RAM Cacheable	Disabled		Menu Level ▶
Memory Hole At 15M-16M	Disabled		
AGP Aperture Size (MB)	64		
AGP ISA Aliasing	Enabled		
AGP Secondary Lat Timer	20h		
AGP Fast Write	Enabled		
AGP Data Transfer Mode	4x		
K7 CLK_CTL Select	Optimal		
SDRAM ECC Setting	Disabled		
Super Bypass Mode	Enabled		
SDRAM Timing setting by	Auto		
x SDRAM PH Limit	8 Cycle		
x SDRAM Idle Limit	8 Cycle		
x SDRAM Trc Timing Value	8 Cycle		
x SDRAM Trp Timing Value	3 Cycle		
x SDRAM Tras Timing Value	7 Cycle		
x SDRAM CAS latency	2 Cycle		
x SDRAM Trcd Timing value	3 Cycle		

↑↓→ Move Enter : Select +/-/PU/PD:Value F10 : Save ESC : Exit F1 : General Help
 F5 : Previous Values F6 : Fail-Safe Defaults F7 : Optimized Defaults

System BIOS Cacheable

When enabled, allows the ROM area F000H-FFFFH to be cacheable when cache controller is activated. The options are: Enabled, Disabled.

Video BIOS Cacheable

As with caching the system BIOS above, enabling the video BIOS cache will cause access to the video BIOS addressed at C0000H-C7FFFH to be cached, if the cache controller is also enabled.

The options are Enabled, Disabled.

Video RAM Cacheable

When enabled, allows the video RAM area to be cacheable.

The options are: Enabled, Disabled.

Memory Hole At 15M-16M

When you install a Legacy ISA card, this feature allows you to select the memory hole's address range of the ISA cycle when the processor accesses the selected address area. Please read your card manual for detail information. When disabled, the memory hole at the 14MB (or 15MB) address will be treated as a DRAM cycle when the processor accesses the 15~16MB address area. The options are: Enabled, Disabled.

AGP Aperture Size (MB)

It allows you to select the main memory frame size for AGP use.

The options are 32, 64, 128, 256.

AGP ISA Aliasing

It allows you to set the AGP decode capability like ISA slot.

The options are: Enabled, Disabled.

AGP Secondary Lat Timer

It allows you to set the latency delay time of AGP interface.

The options are: 00h, 20h, 40h, 60h, 80h, C0h, FFh.

AGP Fast Write

When set at Enabled, this feature allows user to set AGP fast write made.
The options are: Enabled, Disabled

AGP Data Transfer Mode

This feature allows you to select the AGP slot data transfer mode. If you AGP card is of 1x or 2x, please set at 1x/2x.
The options are: 1x/2x, 4x.

K7 CLK_CTL Select

This item allows users to set K7 CPU clock ramp rate according to the system clock multiplier (CLKMUL) and the system bus speed.
The options are: Default, Optimal.

SDRAM ECC Setting

This feature allows user to select the ECC types if the on slot SDRAM supports it.
The options are: Disabled, Check Only, Correct Errors, Correct+Scrub.

Super Bypass Mode

When enable it, North Bridge core chip will internally bypass certain memory to CPU pipe stages. The options are: Enabled, Disabled.

SDRAM Timing setting by

When set at Manual, the features below will be ready for your setting.
The options are: Auto, Manual.

SDRAM PH Limit

The feature allows user to set the number of consecutive Page Hit (PH) requests to allow before choosing a non PH request.
The options are: 1 Cycle, 4 Cycle, 8 Cycle, 16 Cycle.

SDRAM Idle Limit

The feature allows user to set the number of idle cycle to wait before precharging and idle bank. Idle Cycles - cycles that no valid requests are asserted to the MCT. The options are: 0, 8 Cycle, 12 Cycle, 16 Cycle, 24 Cycle, 32 Cycle, 48 Cycle, Disabled.

SDRAM Trc Timing Value

The feature allows user to set the Trc timing value (Bank Cycle time - minimum time from activate to activation of same bank).

The options are: 3 Cycle, 4 Cycle, ..., 10 Cycle.

SDRAM Trp Timing Value

The feature allows user to set the Trp timing value (Precharge time - time from precharge command to when back can be activated).

The options are: 3 Cycle, 2 Cycle, 1 Cycle, 4 Cycle.

SDRAM Tras Timing Value

The feature allows user to set the Tras timing value (Minimum Bank active time - time from activate to precharge of same bank).

The options are: 2 Cycle, 3 Cycle, ..., 9 Cycle.

SDRAM CAS Latency

If the CAS latency of your installed SDRAM DIMM is 2, The selection 2 will enhance system performance. The options are: 2 Cycle, 2.5 Cycle,

SDRAM Trcd Timing Value

The feature allows user to the Trcd timing value (Ras to Cas latency Delay from activate to read/write command).

The options are: 1 Cycle, 2 Cycle, 3 Cycle, 4 Cycle.

Integrated Peripherals

CMOS Setup Utility - Copyright (c) 1984-2000 Award Software

Integrated Peripherals

OnChip IDE Channel0	Enabled	↑ ↓	Item Help
OnChip IDE Channel1	Enabled		Menu Level ▶
IDE Prefetch Mode	Enabled		
Primary Master	PIO Auto		
Primary Slave	PIO Auto		
Secondary Master	PIO Auto		
Secondary Slave	PIO Auto		
Primary Master	UDMA Auto		
Primary Slave	UDMA Auto		
Secondary Master	UDMA Auto		
Secondary Slave	UDMA Auto		
Init Display First	PCI Slot		
OnChip USB	Enabled		
USB Keyboard Support	Disabled		
USB Mouse Support	Disabled		
AC97 Audio	Enabled		
MC97 Modem	Disabled		
IDE HDD Block Mode	Enabled		
Onboard FDD Controller	Enabled		

↑↓→ Move Enter : Select +/-/PU/PD: Value F10 : Save ESC : Exit F1 : General Help
 F5 : Previous Values F6 : Fail-Safe Defaults F7 : Optimized Defaults

CMOS Setup Utility - Copyright (c) 1984-2000 Award Software

Integrated Peripherals

IDE HDD Block Mode	Enabled	↑ ↓	Item Help
Onboard FDD Controller	Enabled		Menu Level ▶
Onboard Serial Port 1	3F8/IRQ4		
Onboard Serial Port 2	2F8/IRQ3		
UART 2 Mode	Standard		
IR Function Duplex	Half		
TX, RX Inverting enable	No, Yes		
Onboard Parallel Port	378/IRQ7		
Onboard Parallel Mode	Normal		
ECP Mode Use DMA	3		
Parallel Port EPP Type	EPP1.7		
Onboard Legacy Audio	Enabled		
Sound Blaster	Disabled		
SB I/O Base Address	220H		
SB IRQ Select	IRQ 5		
SB DMA Select	DMA 1		
MPU-401	Disabled		
MPU-401 I/O Address	300-303H		
Game Port (200-207H)	Enabled		

↑↓→ Move Enter : Select +/-/PU/PD: Value F10 : Save ESC : Exit F1 : General Help
 F5 : Previous Values F6 : Fail-Safe Defaults F7 : Optimized Defaults

OnChip IDE Channel0

When enabled, allows you to use the onboard primary PCI IDE. If a hard disk controller card is used, set at Disabled.

The options are: Enabled, Disabled.

OnChip IDE Channel1

When enabled, allows you to use the onboard secondary PCI IDE. If a hard disk controller card is used, set at Disabled.

The options are: Enabled, Disabled.

IDE Prefetch Mode

When set at Enabled, it allows data to be posted to and prefetched from the primary IDE data ports. Data prefetching is initiated when a data port read occurs. The read prefetch eliminates latency to the IDE data ports and allows them to be performed back to back for the highest possible PIO data transfer rates. The first data port read of a sector is called the demand read. Subsequent data port reads from the sector are called prefetch reads. The demand read and all prefetch reads must be of the same size (16 or 32 bits).

The options are: Enabled, Disabled.

Primary Master PIO

Allows an automatic or a manual configuration of the PCI primary IDE hard disk (master) mode. The options are: Auto, Mode 0, Mode 1, Mode 2, Mode 3, Mode 4.

Primary Slave PIO

Allows an automatic or a manual configuration of the PCI primary IDE hard disk (slave) mode. The options are: Auto, Mode 0, Mode 1, Mode 2, Mode 3, Mode 4.

Secondary Master PIO

Allows an automatic or a manual configuration of the PCI secondary IDE hard disk (master) mode. The options are: Auto, Mode 0, Mode 1, Mode 2, Mode 3, Mode 4.

Secondary Slave PIO

Allows an automatic or a manual configuration of the PCI secondary IDE hard disk (slave) mode. The options are: Auto, Mode 0, Mode 1, Mode 2, Mode 3, Mode 4.

Primary Master UDMA

Allows you to select the first PCI IDE channel of the first master hard disk mode or to detect it by the BIOS if the hard disk supports UDMA (Ultra DMA, faster than DMA). The options are: Auto, Disable.

Primary Slave UDMA

Allows you to select the first PCI IDE channel of the first slave hard disk mode or to detect it by the BIOS if the hard disk supports UDMA (Ultra DMA, faster than DMA). The options are: Auto, Disable.

Secondary Master UDMA

Allows you to select the second PCI IDE channel of the secondary master hard disk mode or to detect it by the BIOS if the hard disk supports UDMA (Ultra DMA, faster than DMA). The options are: Auto, Disable.

Secondary Slave UDMA

Allows you to select the second PCI IDE channel of the secondary slave hard disk mode or to detect it by the BIOS if the hard disk supports UDMA (Ultra DMA, faster than DMA). The options are: Auto, Disable.

Init Display First

When you install an AGP VGA card and a PCI VGA card on the board, this feature allows you to select the first initiation of the monitor display from which card. The options are: PCI Slot, AGP.

OnChip USB

When enabled, this feature allows you to use the onboard USB/USB2 feature. The options are: Enabled (Default), Disabled.

USB Keyboard Support

This feature will appear only if the above item Onchip USB is set at Enabled. Set this feature to Enabled to use a USB keyboard with your system. The options are: Disabled (Default), Enabled.

USB Mouse Support

This feature will appear only if the above item Onchip USB is set at Enabled. Set this feature to Enabled to use a USB mouse with your system. The options are: Disabled (Default), Enabled.

AC97 Audio

This feature allows user to disable the onboard AC97 audio function when needed to do so, such as another sound card installed . The options are: Disabled, Auto.

MC97 Modem

This feature allows user to disable the onboard MC97 modem function when needed to do so, such as a modem card installed. The options are: Disabled, Auto.

IDE HDD Block Mode

When enabled, the system executes read/write requests to hard disk in block mode. The options are: Enabled, Disabled.

Onboard FDD Controller

When enabled, the floppy diskette drive (FDD) controller is activated. The options are: Enabled, Disabled.

Onboard Serial Port 1

If the serial port 1 uses the onboard I/O controller, you can modify your serial port parameters. If an I/O card needs to be installed, COM3 and COM4 may be needed. The options are: 3F8/IRQ4, 2F8/IRQ3, 3E8/IRQ4, 2E8/IRQ3, Disabled.

Onboard Serial Port 2

If the serial port 2 uses the onboard I/O controller, you can modify your serial port parameters. If an I/O card needs to be installed, COM3 and COM4 may be needed. The options are: 2F8/IRQ3, 3E8/IRQ4, 2E8/IRQ3, 3F8/IRQ4, Disabled.

UART 2 Mode

Select an operating mode for the second serial port. Set at Standard, if you use COM2 as the serial port as the serial port, instead as an IR port. The options are: Standard, HPSIR, ASKIR.

Onboard Parallel Port

Allows you to select from a given set of parameters if the parallel port uses the onboard I/O controller.

The options are: 378/IRQ7, 278/IRQ5, 3BC/IRQ7, Disabled.

Onboard Parallel Port Mode

Allows you to connect with an advanced printer.

The options are: Normal, EPP, ECP, ECP/ECP.

ECP Mode Use DMA

This feature allows you to select Direct Memory Access (DMA) channel if the ECP mode selected. The options are: 3, 1.

Parallel Port EPP Type

This feature allows you to select the EPP type for the parallel port.

The options are: EPP1.9, EPP1.7.

Onboard Legacy Audio

Select an operating mode for the second serial port. Set at Standard, if you use COM2 as the serial port as the serial port, instead as an IR port. The options are: Enabled, Disabled.

Sound Blaster

This feature allows you to set audio to Sound Blaster mode, if the onboard Legacy audio chosen. The options are: Enabled, Disabled.

SB I/O Base Address

This feature allows you to select the SB I/O base address, if the onboard Legacy audio chosen. The options are: 220H, 240H, 260H, 280H.

SB IRQ Select

This feature allows you to select the SB IRQ, if the onboard Legacy audio chosen. The options are: IRQ 5, IRQ 7, IRQ 9, IRQ 10.

SB DMA Select

This feature allows you to select the SB DMA channel, if the onboard Legacy audio chosen.

The options are: DMA0, DMA 1, DMA 2, DMA 3.

MPU-401

This feature allows you to enable MPU-401, if the onboard Legacy audio chosen. The options are: Disabled, Enabled.

MPU-401 I/O Address

This feature allows you to select the MPU-401 I/O address, if the onboard Legacy audio chosen.

The options are: 300-303H, 310-313H, 320-323H, 330-333H.

Game Port (200-207H)

This feature allows you to select the game port (200-207H), if the onboard Legacy audio chosen.

The options are: Enabled, Disabled.

Power Management Setup

CMOS Setup Utility - Copyright (c) 1984-2000 Award Software

Power Management Setup

ACPI function	Enabled	<table border="1"> <tr> <th colspan="2">Item Help</th> </tr> <tr> <td>Menu Level</td> <td>▶</td> </tr> </table>	Item Help		Menu Level	▶
Item Help						
Menu Level	▶					
ACPI Suspend Type	S1 (POS)					
Power Management	User Define					
Video Off Method	DPMS Support					
Standby Mode	Disabled					
HDD Power Down	Disabled					
HDD Down In Suspend	Disabled					
Soft-Off by PBTN	Instant-Off					
PWRON After PWR-Fail	Former-Sts					
Wake-Up by PCI card (PME)	Disabled					
RI Resume	Disabled					
MODEM Use IRQ	3					
RTC Resume	Disabled					
X Date (of Month) Alarm	0					
X Time (hh:mm:ss) Alarm	0 0 0					
▶ IRQ Wakeup Events	Press Enter					
VGA	OFF					
LPT & COM	LPT/COM					

↑↓ → Move Enter : Select +/-/PU/PD:Value F10 : Save ESC : Exit F1 : General Help
F5 : Previous Values F6 : Fall-Safe Defaults F7 : Optimized Defaults

CMOS Setup Utility - Copyright (c) 1984-2000 Award Software

Power Management Setup

Video Off Method	DPMS Support	<table border="1"> <tr> <th colspan="2">Item Help</th> </tr> <tr> <td>Menu Level</td> <td>▶</td> </tr> </table>	Item Help		Menu Level	▶
Item Help						
Menu Level	▶					
Standby Mode	Disabled					
HDD Power Down	Disabled					
HDD Down In Suspend	Disabled					
Soft-Off by PBTN	Instant-Off					
PWRON After PWR-Fail	Former-Sts					
Wake-Up by PCI card (PME)	Disabled					
RI Resume	Disabled					
MODEM Use IRQ	3					
RTC Resume	Disabled					
X Date (of Month) Alarm	0					
X Time (hh:mm:ss) Alarm	0 0 0					
▶ IRQ Wakeup Events	Press Enter					
VGA	OFF					
LPT & COM	LPT/COM					
HDD & FDD	ON					
PCI master	OFF					

↑↓ → Move Enter : Select +/-/PU/PD:Value F10 : Save ESC : Exit F1 : General Help
F5 : Previous Values F6 : Fall-Safe Defaults F7 : Optimized Defaults

ACPI function

This item allows you to disable the ACPI function.
The options are: Enabled, Disabled.

ACPI Suspend Type

This item allows you to select ACPI suspend types.
The options are: S1(POS), S3 (STR).

Power Management

This item allows you to adjust the power management features. Select User Define for configuring your own power management features. Min Saving initiates all predefined timers in their minimum values. Max Saving, on the other hand, initiates maximum values.

The options are: User Define, Min Saving, Max Saving.

Video Off Method

The option *V/H SYNC+Blank* allows the BIOS to blank off screen display by turning off the V-Sync and H-Sync signals sent from add-on VGA card. *DPMS Support* allows the BIOS to blank off screen display by your add-on VGA card which supports DPMS (Display Power Management Signaling function). *Blank Screen* allows the BIOS to blank off screen display by turning off the red-green-blue signals.

The options are: Blank Screen, V/H SYNC+Blank, DPMS Support.

Standby Mode

When disabled, the system will not enter Suspend mode. The specified time option defines the idle time the system takes before it enters Suspend mode. The options are: Disabled, 30 Sec, 1, 4, 10, 20, 30 Min, 1 Hour.

HDD Power Down

The option lets the BIOS turn the HDD motor off when system is in Suspend mode. Selecting 1 Min..15 Min allows you define the HDD idle time before the HDD enters the Power Saving Mode.

The options 1 Min..15 Min will not work concurrently. When HDD is in the Power Saving Mode, any access to the HDD will wake the HDD up.

The options are: Disabled, 1 Min..15 Min.

HDD Down In Suspend

The items allows user to set the HDD power down as the system enters suspend mode. The options are: Enabled, Disabled.

Soft-Off by PBTN

The selection Delay 4 Sec. will allow the system shut down after 4 seconds after the power button is pressed. The selection Instant-Off will allow the system shut down immediately once the power button is pressed.

The settings are: Delay 4 Sec, Instant-Off.

PWRON After PWR-Fail

When the system is shut down owing to the power failure, the system will not be back to power on by itself. This feature allows you to set the system back to which power status of the system when the system power is resumed. The options are Off, On, Former-Sts.

Wake-Up by PCI card (PME)

When set at Enabled, any PCI-PM event awakes the system from a PCI-PM controlled state.

The options are Disabled, Enabled.

CPUFAN Off In Suspend

The CPU fan keeps running when set at Disabled to prevent the CPU from overheat. Setting Enabled will let the CPU Fan stop as the system enters power saving mode. The options are Disabled, Enabled.

RI Resume

An input signal on the serial Ring Indicator (RI) line (in other words, an incoming call on the modem) awakens the system from a soft off state.

The options are: Enabled, Disabled.

MODEM Use IRQ

This feature allows you to select the IRQ# to meet your modem's IRQ#.

The options are: NA, 3, 4, 5, 7, 9, 10, 11.

RTC Resume

Enabled allows you to set the time the system will be turned on from the system power-off status. The options are: Enabled, Disabled.

Date (of Month)

This feature allows you to set the day of the alarm starts when the RTC Alarm Resume From Soft Off is set to be Enabled. The options are: 0, 1..31.

Time (hh:mm:ss)

When RTC Alarm Resume is Enabled, this feature allows you to set the time of the alarm starts when the RTC Alarm Resume From Soft Off is set to be Enabled.

The options are: 7: 0: 0. hh (*hour*) - 0, 1, 2,..., 23; mm (*minute*) - 0, 1, 2,...,59; ss (*second*) - 0, 1, 2,...,59.

IRQ Wakeup Events -

IRQs Activity

If the IRQ activity which is defined as Primary occurs, the system goes back to Full-on Mode directly. If the IRQ activity which is defined as Secondary takes place, the system enters another low power state, Dream Mode, in which the system will act as Full-on Mode except that the screen display remains off until the corresponding IRQ handler finishes, then back to Suspend Mode. The options are: Disabled, Primary, Secondary.

IRQ 3/.../15

After the time period which you set, the system advances from doze mode to suspend mode in which the CPU clock stops and the screen display is off. At this moment, if the IRQ activity occurs, the system goes back to full-on mode directly.

If the IRQ activity which is defined as Non Primary takes place, the system remains off until the corresponding IRQ handler finishes.

The options are: Enabled, Disabled.

VGA

When set at On, any VGA activity will awake the system.
The options are: OFF, ON.

LPT & COM

When LPT/COM is selected, any access of LPT and COM ports will awake the system. Likewise, either LPT or COM is chosen, the system will be awoken by any activity of LPT or COM port.
The options are: NONE, COM, LPT, LPT/COM.

HDD & FDD

When it is set at ON, any access happened at hard drives and floppy drives will awake the system.
The options are: OFF, ON.

PCI Master

To set this feature at ON activates that Power Management feature (PM) wake-up event for the PCI bus master card.
The options are: OFF, ON.

Chapter 3
BIOS Setup

PnP/PCI Configurations

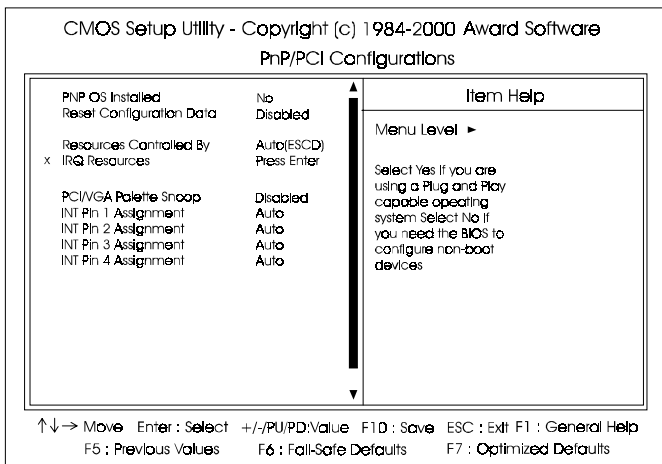

PNP OS Installed

If your operating system is a Plug-and-Play one, such as Windows NT, Windows 95, select Yes. The options are: No, Yes.

Reset Configuration Data

Enabling it to reset the system Extended System Configuration Data (ESCD) when you exit Setup if you have installed a new add-on card and the system reconfiguration has caused such a serious conflict that the operating system can not boot. The options are: Disabled, Enabled.

Resources Controlled By

If set at Auto, the BIOS arranges all system resources. If there exists conflict, select Manual. The options are: Auto (ESCD), Manual.

IRQ-3/4/5/7/9/10/11/12/14/15 assigned to

The feature allows users to reserve specified IRQ(s) for some add-on card(s) use. After that, the BIOS will not assign the reserved IRQ. The options are: PCI Device, Reserved.

PCI/VGA Palette Snoop

Set this feature to be enabled if any ISA adapter card installed in the system requires the VGA palette snoop function. The options are: Disabled, Enabled.

INT Pin 1/2/3/4 Assignment

This feature allows you to assign the PCI IRQ numbers for PCI slots. Selecting the default, Auto, allows the PCI controller to automatically allocate the IRQ numbers.

The options are: Auto, 3, 4, 5, 7, 9, 10, 11, 12, 14, 15.

PC Health Status

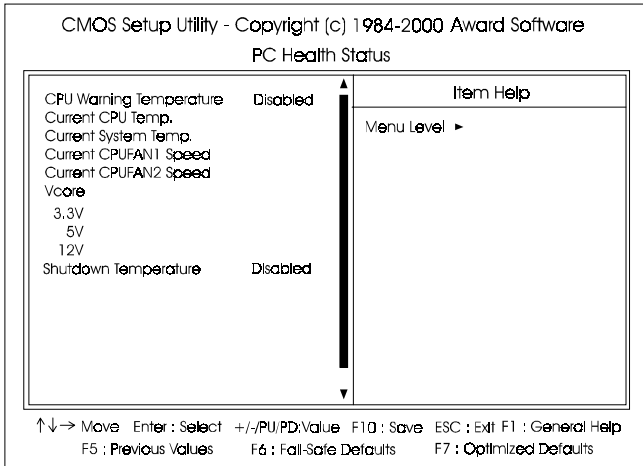

It allows you and technicians to monitor data provided by the BIOS on this mainboard. Some of them are not user-configurable.

CPU Warning Temperature

This feature allows you to set the temperature to slow down the CPU clock frequency.

The options are: Disabled, 50°C/122°F, 53°C/127°F, 56°C/133°F, 60°C/140°F, 63°C/145°F, 66°C/151°F, 70°C/158°F.

Current CPU Temp. / Current System Temp. / Current CPUFAN1 Temperature / Current CPUFAN2 Temperature / Current Case Fan Speed / 3.3V / 5V / 12V:

These items allow end users and technicians to monitor data provided by the BIOS on this mainboard. It is not user-configurable.

Shutdown Temperature

This feature helps to shutdown the system when the system temperature is as high as the selected temperature to prevent from the overheat problem. The options are: Disabled, 60°C/140°F, 65°C/149°F, 70°C/158°F, 75°C/167°F.

Frequency/Voltage Control

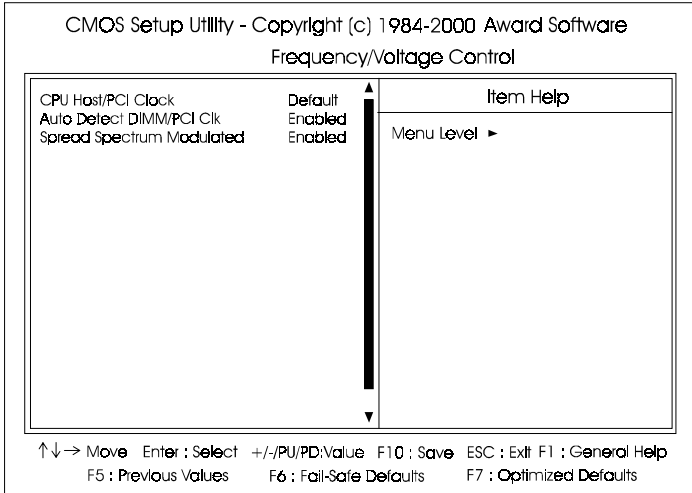

CPU Host/PCI Clock

This feature allows you to set the CPU/PCI clock frequency. The default setting, Default, will detect your CPU/PCI clock frequency automatically. If you set a inappropriate option which leads to a booting problem, keep pressing the Insert key until the display appears will solve it.

The option list offered all combinations that supported by this mainboard.

Auto Detect DIMM/PCI Clk

When enabled, BIOS will detect the PCI slot and DIMM slot. If no any device in, BIOS will auto disable its clock.

The options are: Enabled, Disabled.

Spread Spectrum Modulated

This feature is used to set the spread Spectrum to be center spread type or down spread type. The options are: Disabled, Enabled.

Load Fail-Safe Defaults

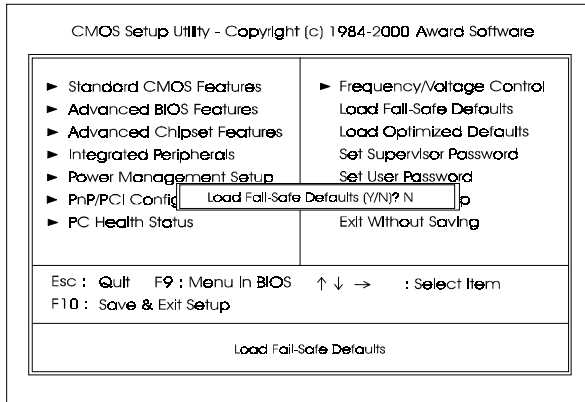

This submenu is selected to diagnose the problem after the computer boots, if the computer will not boot. These settings do not give optimal performance.

Load Optimized Defaults

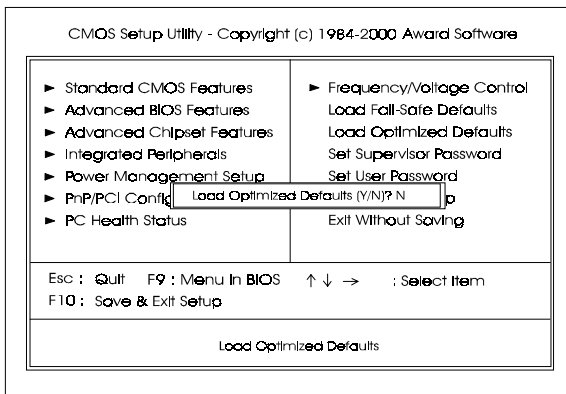

This submenu is selected for default settings which provide the best system performance.

Supervisor/User Password

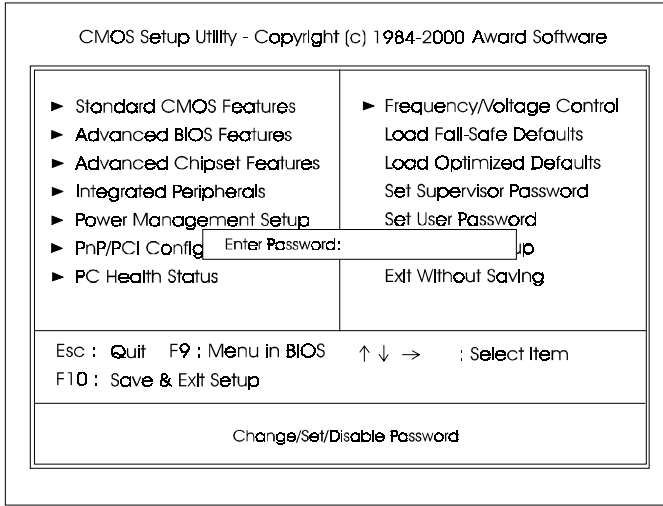

To enable the Supervisor/User passwords, select the item from the Standard CMOS Setup. You will be prompted to create your own password. Type your password up to eight characters and press Enter. You will be asked to confirm the password. Type the password again and press Enter. To disable password, press Enter twice when you are prompted to enter a password. A message appears, confirming the password is disabled.

Under the BIOS Feature Setup, if *Setup* is selected under the Security Option field and the Supervisor/User Password is enabled, you will be prompted password every time you try to enter the CMOS Setup Utility. If *System* is selected and the Supervisor/User Password is enabled, you will be requested to enter the Password every time when you reboot the system or enter the CMOS Setup utility.

Save and Exit Setup

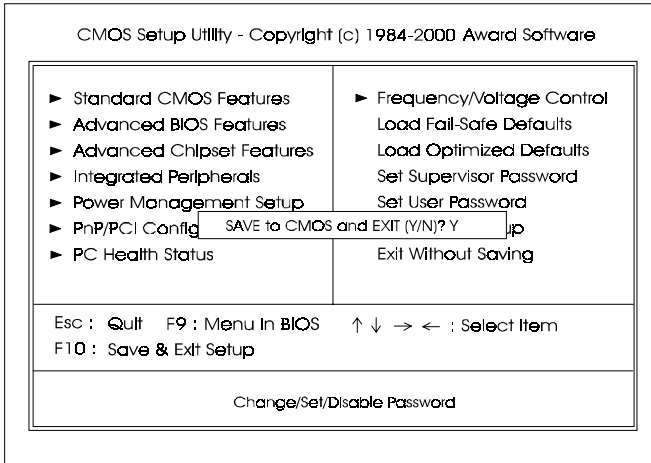

After you have made changes under Setup, press Esc to return to the main menu. Move cursor to Save and Exit Setup or press F10 and then press Y to change the CMOS Setup. If you did not change anything, press Esc again or move cursor to Exit Without Saving and press Y to retain the Setup settings. The following message will appear at the center of the screen to allow you to save data to CMOS and exit the setup utility: **SAVE to CMOS and EXIT (Y/N)?**

Exit without Saving

If you select this feature, the following message will appear at the center of the screen to allow you to exit the setup utility without saving CMOS modifications: **Quit Without Saving (Y/N)?**

Quick Reference

The mainboard has several user-adjustable jumpers and/or switches on the board that allow you to configure your system to suit your requirements. This quick reference contains information on the various hardware settings on your mainboard.

To set up your computer, you must complete the following steps:

- Step 1 - Set system jumpers/switches
- Step 2 - Install system memory modules
- Step 3 - Install the Central Processing Unit (CPU)
- Step 4 - Install expansion cards
- Step 5 - Connect ribbon cables, cabinet wires, and power supply
- Step 6 - Set up BIOS software
- Step 7 - Set up supporting software tools



WARNING: Excessive torque may damage the mainboard. When using an electric screwdriver on the mainboard, make sure that the torque is set to the allowable range of 5.0 ~ 8.0kg/cm.

Mainboard components contain very delicate Integrated Circuit (IC) chips. To prevent static electricity from harming any of the mainboard's sensitive components, you should follow the following precautions whenever working on the computer:

1. Unplug the computer when working on the inside.
2. Hold components by the edges and try not to touch the IC chips, leads, or circuitry.
3. Wear an anti-static wrist strap which fits around the wrist.
4. Place components on a grounded anti-static pad or on the bag that came with the component whenever the components are separated from the system.

Mainboard Layout

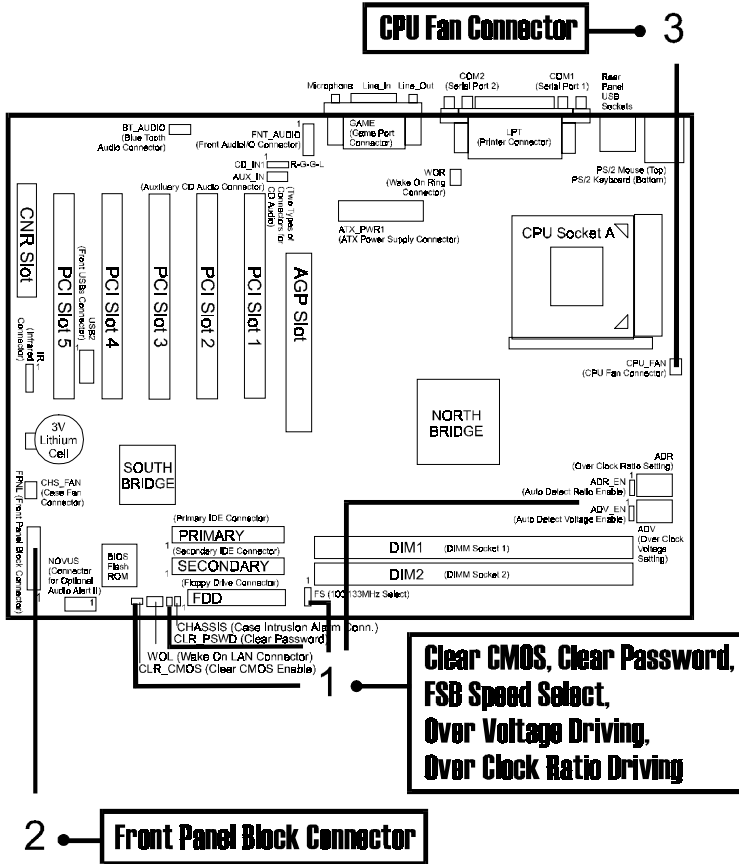

1). **Clear CMOS, Clear Password,
FSB Speed Select,
Auto Detect Freq. Ratio (ADR_EN, ADR)
Auto Detect CPU Core Voltage (ADV_EN, ADV)**

CLR_CMOS
(Clear CMOS)



Clear CMOS



*Normal
(Default)*

CLR_PSWD
(Clear Password)

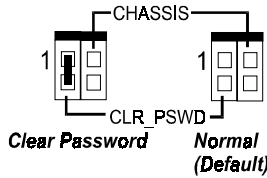

FS
*(Front Side Bus Speed Select:
100MHz/133MHz)*



133MHz



*100MHz
(Default)*

ADV
(CPU Core Voltage Setting)

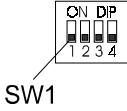

ADV_EN
(Auto Detect CPU Core Voltage)

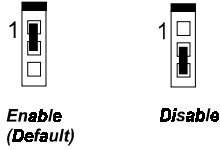

CPU Voltage	SW1	SW2	SW3	SW4
1.850 V	ON	ON	ON	ON
1.825 V	OFF	ON	ON	ON
1.800 V	ON	OFF	ON	ON
1.775 V	OFF	OFF	ON	ON
1.750 V	ON	ON	OFF	ON
1.725 V	OFF	ON	OFF	ON
1.700 V	ON	OFF	OFF	ON
* 1.475 V	OFF	OFF	OFF	OFF

(* : Default)



NOTE: Please set the jumper ADV_EN at Disable before you adjust the switch ADV.

ADR
(Freq. Ratio Setting)

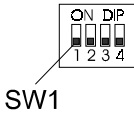

ADR_EN
(Auto Detect Freq. Ratio)



Enable
(Default)



Disable

Ratio	SW1	SW2	SW3	SW4
11 X	ON	ON	ON	ON
11.5 X	OFF	ON	ON	ON
12 X	ON	OFF	ON	ON
>= 12.5 X	OFF	OFF	ON	ON
5 X	ON	ON	OFF	ON
5.5 X	OFF	ON	OFF	ON
6 X	ON	OFF	OFF	ON
6.5 X	OFF	OFF	OFF	ON
7 X	ON	ON	ON	OFF
7.5 X	OFF	ON	ON	OFF
8 X	ON	OFF	ON	OFF
8.5 X	OFF	OFF	ON	OFF
9 X	ON	ON	OFF	OFF
9.5 X	OFF	ON	OFF	OFF
10 X	ON	OFF	OFF	OFF
* 10.5 X	OFF	OFF	OFF	OFF

(* : Default)



NOTE: Please set the jumper ADR_EN at Disable before you adjust the switch ADR.

2). Front Panel Block Cable Connection

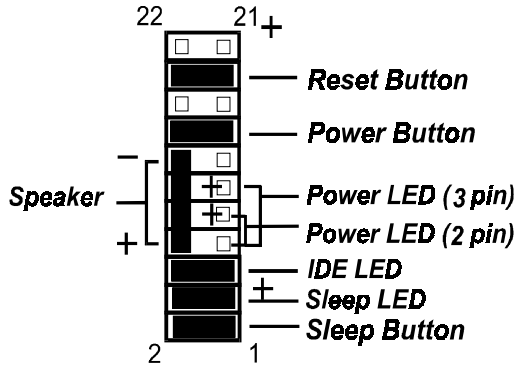

3). CPU Fan Installation

This connector is linked to the CPU fan. When the system is in suspend mode, the CPU fan will turn off; when it reverts back to full on mode, the fan will turn back on. Without sufficient air circulation, the CPU may overheat resulting in damage to both the CPU and the mainboard.

Damage may occur to the mainboard and/or the CPU fan if these pins are used incorrectly. These are not jumpers, do not place jumper caps over these pins.