

FCC Information and Copyright

This equipment has been tested and found to comply with the limits of a Class B digital device, pursuant to Part 15 of the FCC Rules. These limits are designed to provide reasonable protection against harmful interference in a residential installation. This equipment generates, uses, and can radiate radio frequency energy and, if not installed and used in accordance with the instructions, may cause harmful interference to radio communications. There is no guarantee that interference will not occur in a particular installation.

The vendor makes no representations or warranties with respect to the contents here and specially disclaims any implied warranties of merchantability or fitness for any purpose. Further the vendor reserves the right to revise this publication and to make changes to the contents here without obligation to notify any party beforehand.

Duplication of this publication, in part or in whole, is not allowed without first obtaining the vendor's approval in writing.

The content of this user's manual is subject to be changed without notice and we will not be responsible for any mistakes found in this user's manual. All the brand and product names are trademarks of their respective companies.

Table of Contents

Chapter 1: Introduction	1
1.1 Before You Start	1
1.2 Package Checklist	1
1.3 Motherboard Features	2
1.4 Rear Panel Connectors	3
1.5 Motherboard Layout	4
Chapter 2: Hardware Installation	5
2.1 Installing Central Processing Unit (CPU)	5
2.2 FAN Headers	7
2.3 Installing System Memory	8
2.4 Connectors and Slots	10
Chapter 3: Headers & Jumpers Setup	13
3.1 How to Setup Jumpers	13
3.2 Detail Settings	13
Chapter 4: RAID Functions	18
4.1 Operating System	18
4.2 Raid Arrays	18
4.3 How RAID Works	18
Chapter 5: Useful Help	21
5.1 Driver Installation Note	21
5.2 Software	22
5.3 Extra Information	26
5.4 AMI BIOS Beep Code	28
5.5 Troubleshooting	29
Appendix: SPEC In Other Languages	30
German	30
French	32
Italian	34
Spanish	36
Portuguese	38
Polish	40
Russian	42
Arabic	44
Japanese	46

CHAPTER 1: INTRODUCTION

1.1 BEFORE YOU START

Thank you for choosing our product. Before you start installing the motherboard, please make sure you follow the instructions below:

- Prepare a dry and stable working environment with sufficient lighting.
- Always disconnect the computer from power outlet before operation.
- Before you take the motherboard out from anti-static bag, ground yourself properly by touching any safely grounded appliance, or use grounded wrist strap to remove the static charge.
- Avoid touching the components on motherboard or the rear side of the board unless necessary. Hold the board on the edge, do not try to bend or flex the board.
- Do not leave any unfastened small parts inside the case after installation. Loose parts will cause short circuits which may damage the equipment.
- Keep the computer from dangerous area, such as heat source, humid air and water.
- The operating temperatures of the computer should be 0 to 45 degrees Celsius.

1.2 PACKAGE CHECKLIST

- ✚ HDD Cable X 1
- ✚ Serial ATA Cable X 1
- ✚ Rear I/O Panel for ATX Case X 1
- ✚ Installation Guide X 1
- ✚ Fully Setup Driver CD X 1 (full version manual files inside)
- ✚ FDD Cable X 1 (optional)
- ✚ USB 2.0 Cable X1 (optional)
- ✚ Serial ATA Power Cable X 1 (optional)

Note: The package contents may be different due to area or your motherboard version.

1.3 MOTHERBOARD FEATURES

	<i>A780GE/A760GE</i>	<i>A785GE</i>
CPU	Socket AM2+ AMD Sempron / Athlon / Athlon II / Phenom / Phenom II processors AMD 64 Architecture enables 32 and 64 bit computing Supports Hyper Transport 3.0 and Cool'n'Quiet (Maximum Watt: 95W)	Socket AM2+ AMD Sempron / Athlon / Athlon II / Phenom / Phenom II processors AMD 64 Architecture enables 32 and 64 bit computing Supports Hyper Transport 3.0 and Cool'n'Quiet (Maximum Watt: 95W)
FSB	Support HyperTransport 3.0 Supports up to 5.2 GT/s Bandwidth	Support HyperTransport 3.0 Supports up to 4.4 GT/s Bandwidth
Chipset	AMD 780G / 760G AMD SB710	AMD 785G AMD SB710
Super I/O	ITE 8718F Provides the most commonly used legacy Super I/O functionality Low Pin Count Interface Environment Control initiatives H/W Monitor ITE's "Smart Guardian" function	ITE 8718F Provides the most commonly used legacy Super I/O functionality Low Pin Count Interface Environment Control initiatives H/W Monitor ITE's "Smart Guardian" function
Main Memory	DDR2 DIMM Slots x 2 Max Memory Capacity 8GB Each DIMM supports 256MB/512MB/1GB/2GB/4GB DDR2 Dual Channel Mode DDR2 memory module Supports DDR2 533 / 667 / 800 Supports DDR2 1066 (for AM2+/AM3 CPU only) Registered DIMM and ECC DIMM is not supported	DDR2 DIMM Slots x 2 Max Memory Capacity 8GB Each DIMM supports 256MB/512MB/1GB/2GB/4GB DDR2 Dual Channel Mode DDR2 memory module Supports DDR2 533 / 667 / 800 Supports DDR2 1066 (for AM2+/AM3 CPU only) Registered DIMM and ECC DIMM is not supported
Graphics	Integrated in AMD 780G / 760G Chipset Max Shared Video Memory is 512MB DX10/HDCP (780G ONLY) support	Integrated in AMD 785G Chipset Max Shared Video Memory is 512MB HDCP support
IDE	Integrated IDE Controller Ultra DMA 33 / 66 / 100 / 133 Bus Master Mode supports PIO Mode 0~4,	Integrated IDE Controller Ultra DMA 33 / 66 / 100 / 133 Bus Master Mode supports PIO Mode 0~4,
SATA II	Integrated Serial ATA Controller Data transfer rates up to 3 Gb/s SATA Version 2.0 specification compliant	Integrated Serial ATA Controller Data transfer rates up to 3 Gb/s SATA Version 2.0 specification compliant
LAN	Realtek RTL 8111DL 10 / 100 /1000 Mb/s auto negotiation Half / Full duplex capability	Realtek RTL 8111DL 10 / 100 /1000 Mb/s auto negotiation Half / Full duplex capability
Sound	ALC662 5.1 channels audio out High Definition Audio	ALC662 5.1 channels audio out High Definition Audio

A780GE/A760GE/A785GE

	A780GE/A760GE		A785GE	
Slots	PCI Express Gen2 x16 slot	x1	PCI Express Gen2 x16 slot	x1
	PCI slot	x2	PCI slot	x2
On Board Connector	Floppy Connector	x1	Floppy Connector	x1
	IDE Connector	x1	IDE Connector	x1
	SATA Connector	x4	SATA Connector	x4
	Front Panel Connector	x1	Front Panel Connector	x1
	Front Audio Connector	x1	Front Audio Connector	x1
	S/PDIF Out Connector	x1	S/PDIF Out Connector	x1
	CPU Fan Header	x1	CPU Fan Header	x1
	System Fan Header	x1	System Fan Header	x1
	CMOS clear Header	x1	CMOS clear Header	x1
	USB Connector	x2	USB Connector	x2
	Power Connector (24pin)	x1	Power Connector (24pin)	x1
	Power Connector (4pin)	x1	Power Connector (4pin)	x1
	Printer Port Connector	x1	Printer Port Connector	x1
Serial port Connector	x1	Serial port Connector	x1	
Back Panel I/O	PS/2 Keyboard	x1	PS/2 Keyboard	x1
	PS/2 Mouse	x1	PS/2 Mouse	x1
	DVI port	x1	DVI port	x1
	VGA port	x1	VGA port	x1
	LAN port	x1	LAN port	x1
	USB Port	x4	USB Port	x4
Audio Jack	x3	Audio Jack	x3	
Board Size	200 mm(W) x 244 mm(L)		200 mm(W) x 244 mm(L)	
Special Features	RAID 0 / 1 / 1+0 support		RAID 0 / 1 / 1+0 support	
OS Support	Windows XP / Vista 32 / 64 Biostar reserves the right to add or remove support for any OS With or without notice.		Windows XP / Vista 32 / 64 Biostar reserves the right to add or remove support for any OS With or without notice.	

1.4 REAR PANEL CONNECTORS

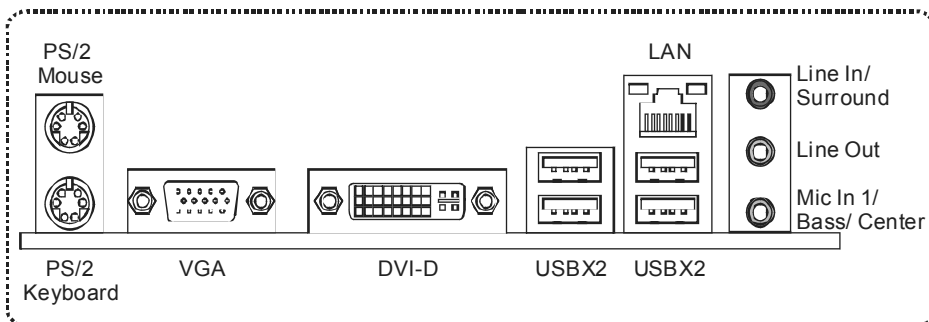

1.5 MOTHERBOARD LAYOUT

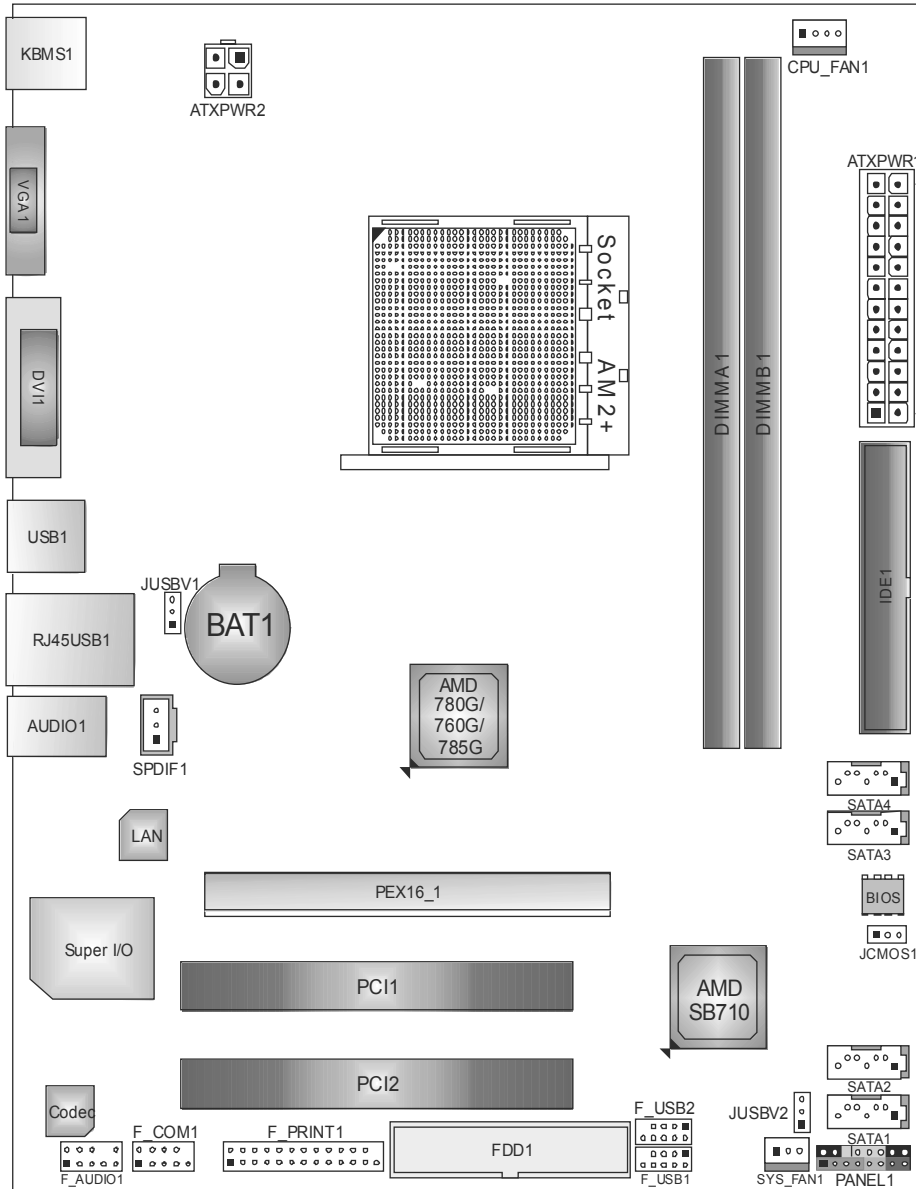

Note: ■ represents the 1st pin.

CHAPTER 2: HARDWARE INSTALLATION

2.1 INSTALLING CENTRAL PROCESSING UNIT (CPU)

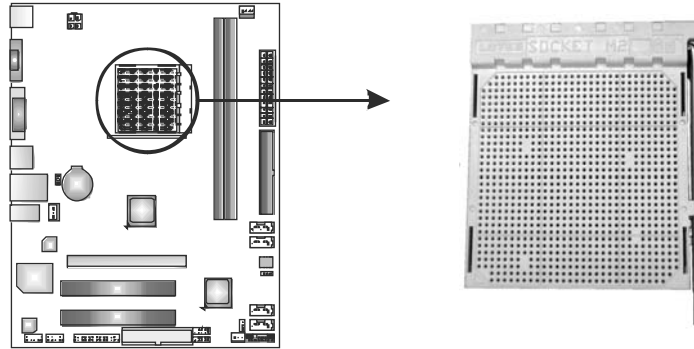

Step 1: Pull the lever toward direction A from the socket and then raise the lever up to a 90-degree angle.

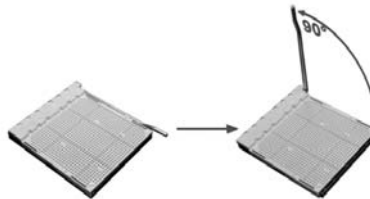

Step 2: Look for the white triangle on socket, and the gold triangle on CPU should point towards this white triangle. The CPU will fit only in the correct orientation.



Motherboard Manual

Step 3: Hold the CPU down firmly, and then close the lever toward direct B to complete the installation.

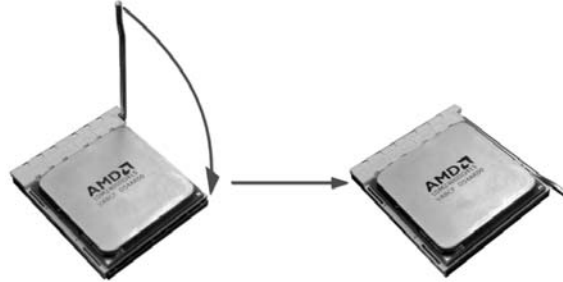

Step 4: Put the CPU Fan on the CPU and buckle it. Connect the CPU FAN power cable to the CPU_FAN1. This completes the installation.

Note: Please update the BIOS to the latest version while using AM2+/AM3 CPUs. Due to the latest CPU transition, you may encounter the situation that the new system failed to boot while using new AM2+/AM3 CPUs. In this case, please install one standard AM2 CPU to boot your system, and update the latest BIOS from our website for AM2+/AM3 CPUs support.

2.2 FAN HEADERS

These fan headers support cooling-fans built in the computer. The fan cable and connector may be different according to the fan manufacturer. Connect the fan cable to the connector while matching the black wire to pin#1.

CPU_FAN1: CPU Fan Header

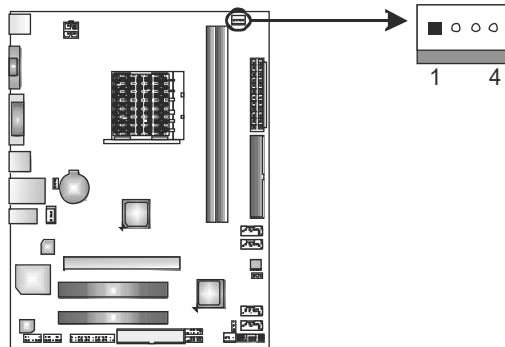

Pin	Assignment
1	Ground
2	+12V
3	FAN RPM rate sense
4	Smart Fan Control (By Fan)

SYS_FAN1: System Fan Header

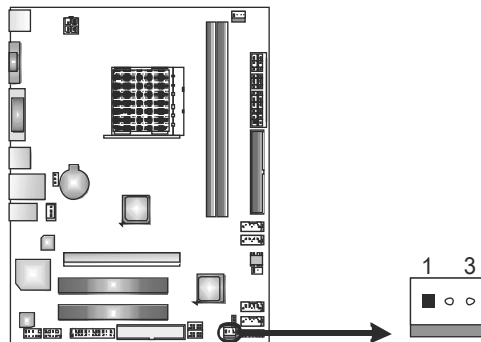

Pin	Assignment
1	Ground
2	+12V
3	FAN RPM rate sense

Note:

The CPU_FAN1 supports 4-pin head connector. The SYS_FAN1 supports 3-pin head connector. When connecting with wires onto connectors, please note that the red wire is the positive and should be connected to pin#2, and the black wire is Ground and should be connected to GND.

2.3 INSTALLING SYSTEM MEMORY

A. Memory Modules

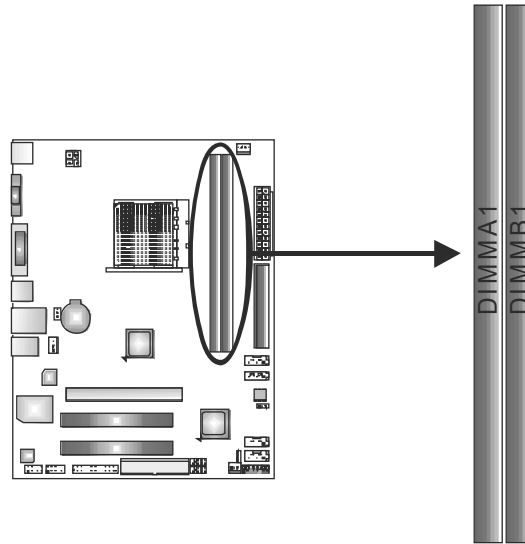

1. Unlock a DIMM slot by pressing the retaining clips outward. Align a DIMM on the slot such that the notch on the DIMM matches the break on the Slot.

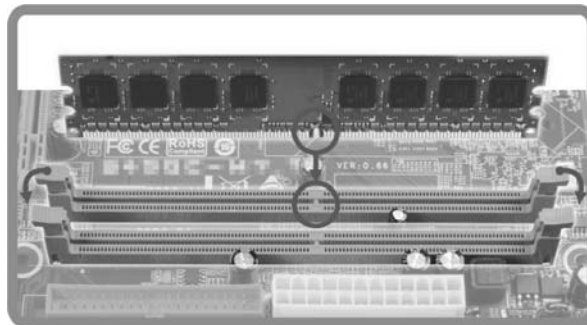

2. Insert the DIMM vertically and firmly into the slot until the retaining chip snap back in place and the DIMM is properly seated.

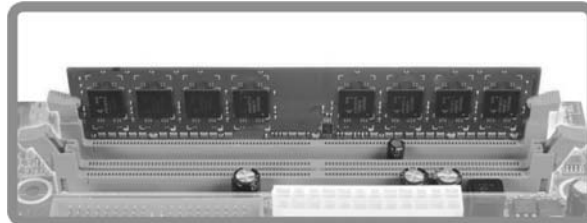

B. Memory Capacity

DIMM Socket Location	DDR2 Module	Total Memory Size
DIMMA1	256MB/512MB/1GB/2GB/4GB	Max is 8GB.
DIMMB1	256MB/512MB/1GB/2GB/4GB	

C. Dual Channel Memory installation

Please refer to the following requirements to activate Dual Channel function:

Install memory module of the same density in pairs, shown in the table

Dual Channel Status	DIMMA1	DIMMB1
Disabled	X	O
Disabled	O	X
Enabled	O	O

(O means memory installed, X means memory not installed.)

The DRAM bus width of the memory module must be the same (x8 or x16)

2.4 CONNECTORS AND SLOTS

FDD1: Floppy Disk Connector

The motherboard provides a standard floppy disk connector that supports 360K, 720K, 1.2M, 1.44M and 2.88M floppy disk types.

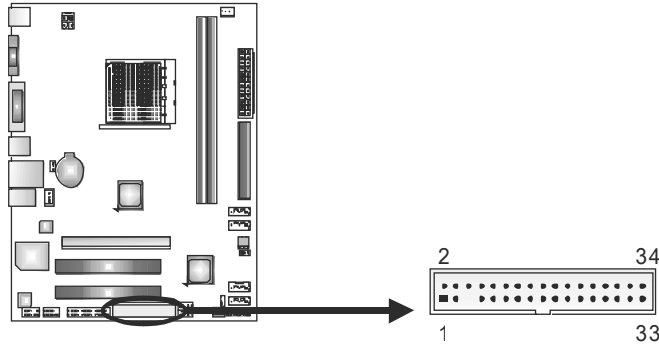

IDE1: Hard Disk Connector

The motherboard has a 32-bit Enhanced PCI IDE Controller that provides PIO Mode 0~4, Bus Master, and Ultra DMA 33/66/100/133 functionality.

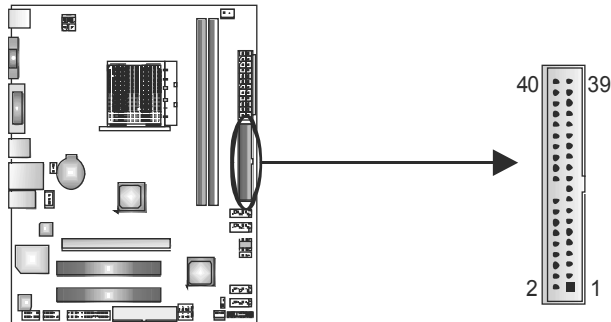

SATA1~SATA6: Serial ATA Connectors

The motherboard has a PCI to SATA Controller with 6 channels SATA interface, it satisfies the SATA 2.0 spec and with transfer rate of 3.0Gb/s.

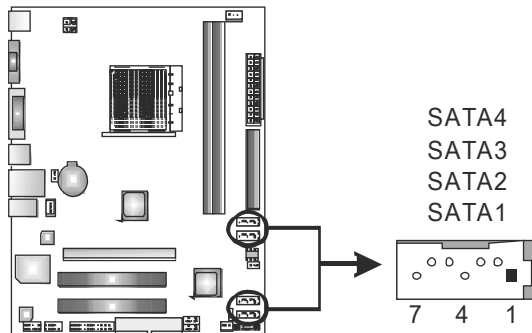

Pin	Assignment
1	Ground
2	TX+
3	TX-
4	Ground
5	RX-
6	RX+
7	Ground

ATXPWR1: ATX Power Source Connector

This connector allows user to connect 24-pin power connector on the ATX power supply.

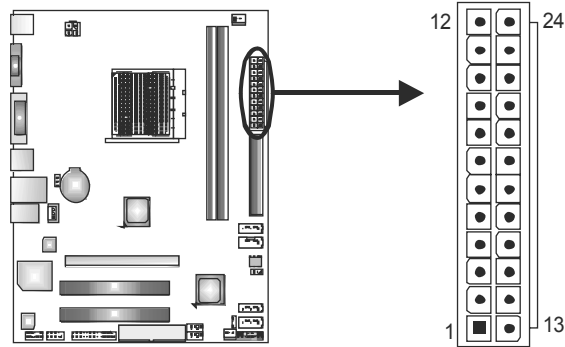

Pin	Assignment	Pin	Assignment
13	+3.3V	1	+3.3V
14	-12V	2	+3.3V
15	Ground	3	Ground
16	PS_ON	4	+5V
17	Ground	5	Ground
18	Ground	6	+5V
19	Ground	7	Ground
20	NC	8	PW_OK
21	+5V	9	Standby Voltage+5V
22	+5V	10	+12V
23	+5V	11	+12V
24	Ground	12	+3.3V

ATXPWR2: ATX Power Source Connector

Connecting this connector will provide +12V to CPU power circuit.

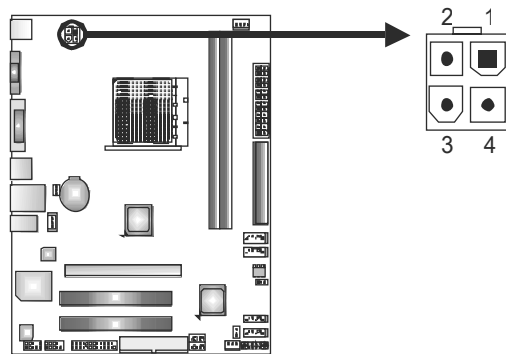

Pin	Assignment
1	+12V
2	+12V
3	Ground
4	Ground

Note:

Before power on the system, please make sure that both JATXPWR1 and JATXPWR2 connectors have been plugged-in.

PEX16_1: PCI-Express Gen2 x16 Slot

- PCI-Express 2.0 compliant.
- Maximum theoretical realized bandwidth of 8GB/s simultaneously per direction, for an aggregate of 16GB/s totally.

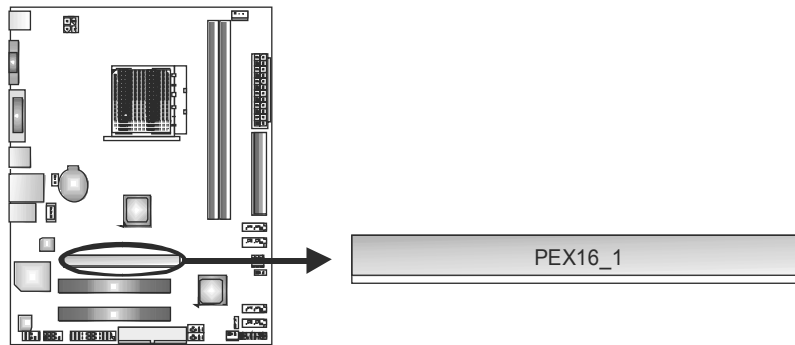

PCI1~PCI2: Peripheral Component Interconnect Slots

This motherboard is equipped with 2 standard PCI slots. PCI stands for Peripheral Component Interconnect, and it is a bus standard for expansion cards. This PCI slot is designated as 32 bits.

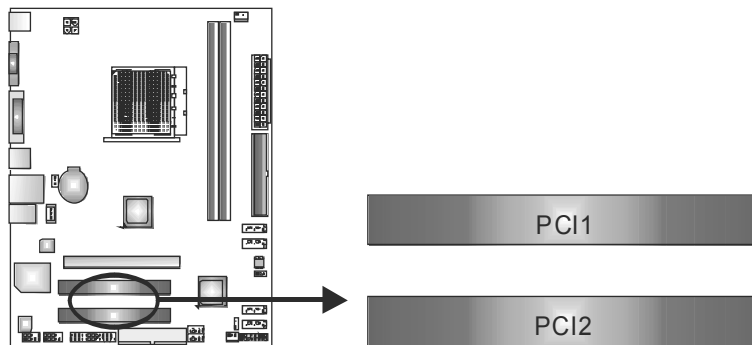

CHAPTER 3: HEADERS & JUMPERS SETUP

3.1 HOW TO SETUP JUMPERS

The illustration shows how to set up jumpers. When the jumper cap is placed on pins, the jumper is “close”, if not, that means the jumper is “open”.

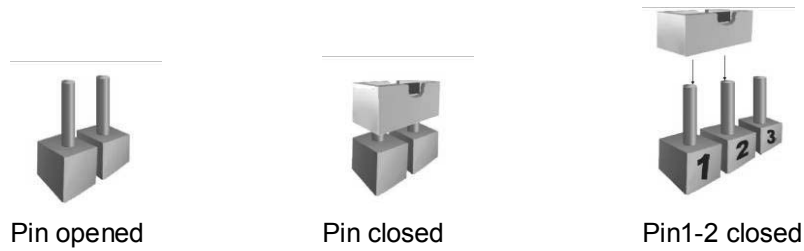

3.2 DETAIL SETTINGS

PANEL1: Front Panel Header

This 16-pin connector includes Power-on, Reset, HDD LED, Power LED, and speaker connection. It allows user to connect the PC case’s front panel switch functions.

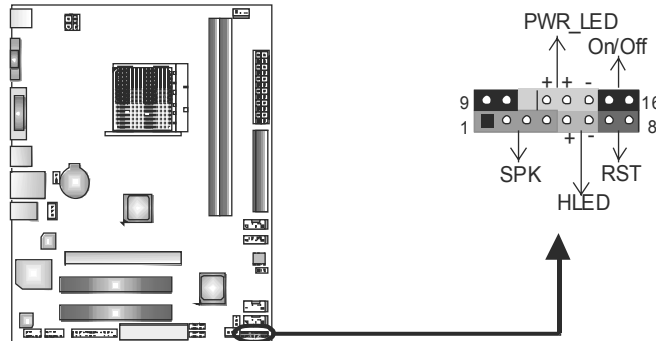

Pin	Assignment	Function	Pin	Assignment	Function
1	+5V	Speaker Connector	9	N/A	N/A
2	N/A		10	N/A	
3	N/A		11	N/A	
4	Speaker	Hard drive LED	12	Power LED (+)	Power LED
5	HDD LED (+)		13	Power LED (+)	
6	HDD LED (-)	Reset button	14	Power LED (-)	Power-on button
7	Ground		15	Power button	
8	Reset control		16	Ground	

F_USB1/F_USB2: Headers for USB 2.0 Ports at Front Panel

This header allows user to connect additional USB cable on the PC front panel, and also can be connected with internal USB devices, like USB card reader.

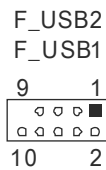
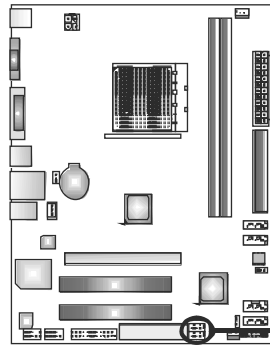

Pin	Assignment
1	+5V (fused)
2	+5V (fused)
3	USB-
4	USB-
5	USB+
6	USB+
7	Ground
8	Ground
9	NC
10	Key

JUSBV1/JUSBV2: Power Source Headers for USB Ports

Pin 1-2 Close:

JUSBV1: +5V for USB ports at USB1/RJ45USB1.

JUSBV2: +5V for USB ports at F_USB1/F_USB2.

Pin 2-3 Close:

JUSBV1: +5V STB for USB ports at USB1/RJ45USB1.

JUSBV2: +5V STB for USB ports at F_USB1/F_USB2.

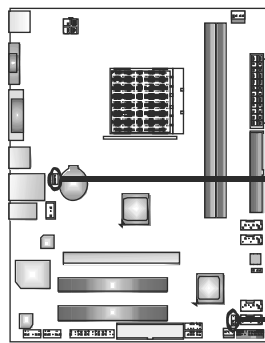

JUSBV1



JUSBV2



Pin 1-2 close



Pin 2-3 close

SPDIF1: Digital Audio-out Connector

This connector allows user to connect the PCI bracket SPDIF output header.

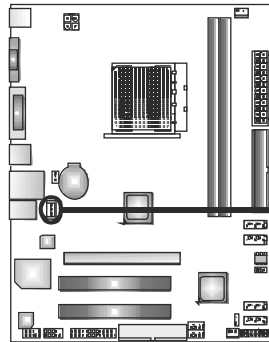

Pin	Assignment
1	+5V
2	SPDIF_OUT
3	Ground

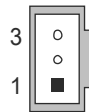

F_AUDIO1: Front Panel Audio Header

This header allows user to connect the front audio output cable with the PC front panel. This header allows only HD audio front panel connector; AC'97 connector is not acceptable.

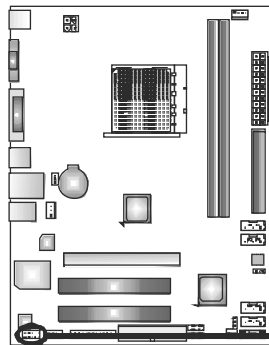

Pin	Assignment
1	Mic Left in
2	Ground
3	Mic Right in
4	GPIO
5	Right line in
6	Jack Sense
7	Front Sense
8	Key
9	Left line in
10	Jack Sense

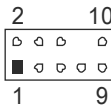

JCMOS1: Clear CMOS Header

Placing the jumper on pin2-3, it allows user to restore the BIOS safe setting and the CMOS data. Please carefully follow the procedures to avoid damaging the motherboard.

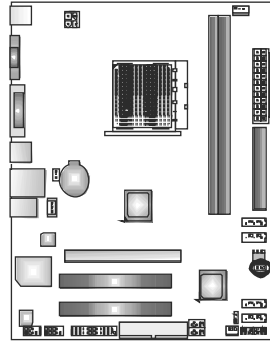

Pin 1-2 Close:
Normal Operation (default).



Pin 2-3 Close:
Clear CMOS data.

※ Clear CMOS Procedures:

1. Remove AC power line.
2. Set the jumper to "Pin 2-3 close".
3. Wait for five seconds.
4. Set the jumper to "Pin 1-2 close".
5. Power on the AC.
6. Reset your desired password or clear the CMOS data.

F_COM1: Serial Port Connector

The motherboard has a Serial Port Connector for connecting RS-232 Port.

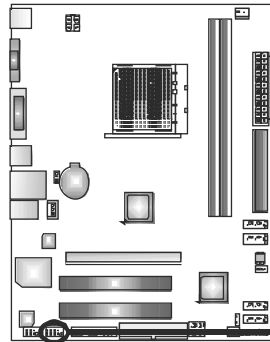

Pin	Assignment
1	Carrier detect
2	Received data
3	Transmitted data
4	Data terminal ready
5	Signal ground
6	Data set ready
7	Request to send
8	Clear to send
9	Ring indicator
10	NC

F_PRINT1: Printer Port Connector

This header allows you to connect printer on the PC.

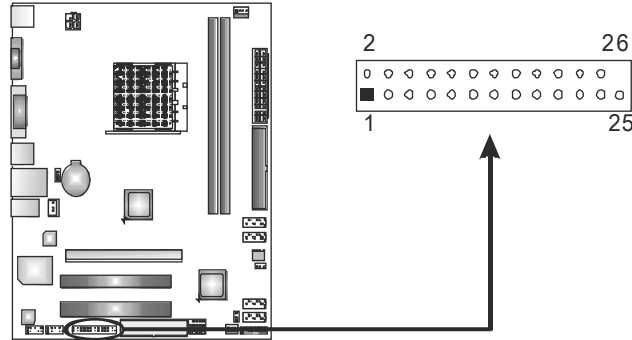

Pin	Assignment	Pin	Assignment
1	-Strobe	14	Ground
2	-ALF	15	Data 6
3	Data 0	16	Ground
4	-Error	17	Data 7
5	Data 1	18	Ground
6	-Init	19	-ACK
7	Data 2	20	Ground
8	-Sctin	21	Busy
9	Data 3	22	Ground
10	Ground	23	PE
11	Data 4	24	Ground
12	Ground	25	SCLT
13	Data 5	26	Key

CHAPTER 4: RAID FUNCTIONS

4.1 OPERATING SYSTEM

Supports Windows XP Home/Professional Edition, and Windows Vista.

4.2 RAID ARRAYS

RAID supports the following types of RAID arrays:

RAID 0: RAID 0 defines a disk striping scheme that improves disk read and write times for many applications.

RAID 1: RAID 1 defines techniques for mirroring data.

RAID 1+0: RAID 1+0 combines the techniques used in RAID 0 and RAID 1.

4.3 How RAID WORKS

RAID 0:

The controller “stripes” data across multiple drives in a RAID 0 array system. It breaks up a large file into smaller blocks and performs disk reads and writes across multiple drives in parallel. The size of each block is determined by the stripe size parameter, which you set during the creation of the RAID set based on the system environment. This technique reduces overall disk access time and offers high bandwidth.

Features and Benefits

- **Drives:** Minimum 2, and maximum is up to 6 or 8. Depending on the platform.
- **Uses:** Intended for non-critical data requiring high data throughput, or any environment that does not require fault tolerance.
- **Benefits:** provides increased data throughput, especially for large files. No capacity loss penalty for parity.
- **Drawbacks:** Does not deliver any fault tolerance. If any drive in the array fails, all data is lost.
- **Fault Tolerance:** No.

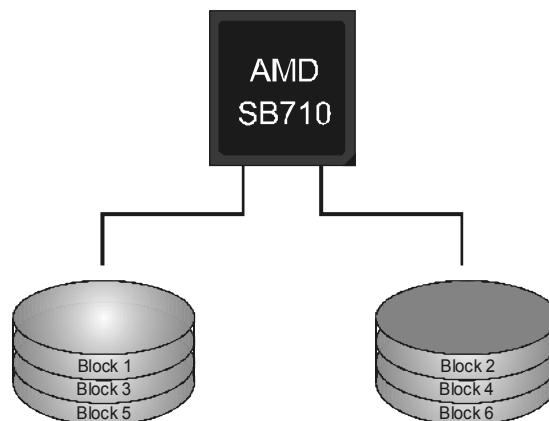

RAID 1:

Every read and write is actually carried out in parallel across 2 disk drives in a RAID 1 array system. The mirrored (backup) copy of the data can reside on the same disk or on a second redundant drive in the array. RAID 1 provides a hot-standby copy of data if the active volume or drive is corrupted or becomes unavailable because of a hardware failure.

RAID techniques can be applied for high-availability solutions, or as a form of automatic backup that eliminates tedious manual backups to more expensive and less reliable media.

Features and Benefits

- **Drives:** Minimum 2, and maximum is 2.
- **Uses:** RAID 1 is ideal for small databases or any other application that requires fault tolerance and minimal capacity.
- **Benefits:** Provides 100% data redundancy. Should one drive fail, the controller switches to the other drive.
- **Drawbacks:** Requires 2 drives for the storage space of one drive. Performance is impaired during drive rebuilds.
- **Fault Tolerance:** Yes.

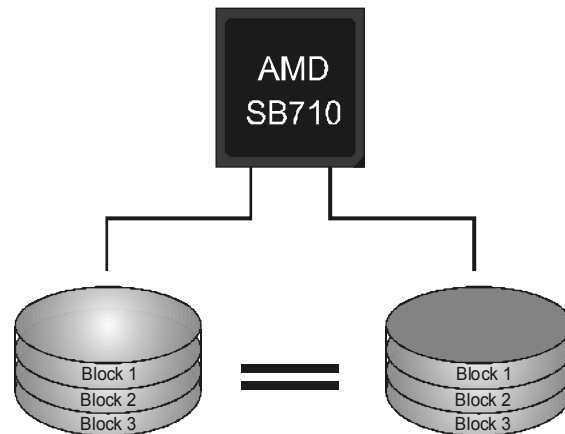

RAID 1+0:

RAID 1 drives can be striped using RAID 0 techniques. Resulting in a RAID 1+0 solution for improved resiliency, performance and rebuild performance.

Features and Benefits

- **Drives:** Minimum 4, and maximum is 6 or 8, depending on the platform.
- **Benefits:** Optimizes for both fault tolerance and performance, allowing for automatic redundancy. May be simultaneously used with other RAID levels in an array, and allows for spare disks.
- **Drawbacks:** Requires twice the available disk space for data redundancy, the same as RAID level 1.
- **Fault Tolerance:** Yes.

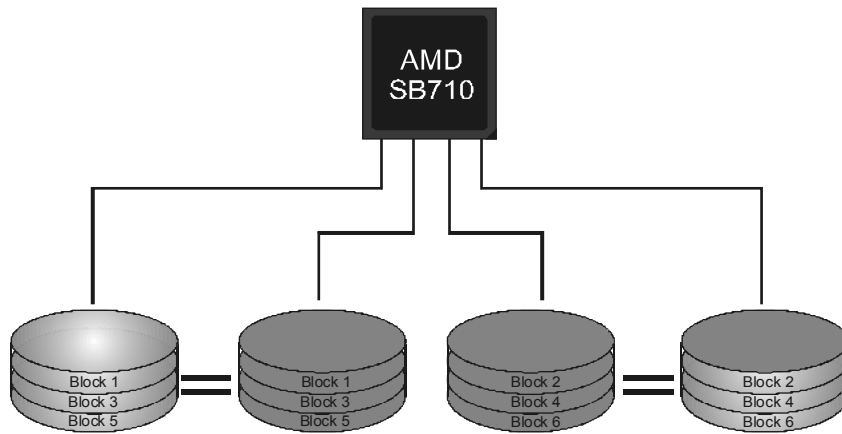

CHAPTER 5: USEFUL HELP

5.1 DRIVER INSTALLATION NOTE

After you installed your operating system, please insert the Fully Setup Driver CD into your optical drive and install the driver for better system performance.

You will see the following window after you insert the CD



The setup guide will auto detect your motherboard and operating system.

Note:

If this window didn't show up after you insert the Driver CD, please use file browser to locate and execute the file **SETUP.EXE** under your optical drive.

A. Driver Installation

To install the driver, please click on the Driver icon. The setup guide will list the compatible driver for your motherboard and operating system. Click on each device driver to launch the installation program.

B. Software Installation

To install the software, please click on the Software icon. The setup guide will list the software available for your system, click on each software title to launch the installation program.

C. Manual

Aside from the paperback manual, we also provide manual in the Driver CD. Click on the Manual icon to browse for available manual.

Note:

You will need Acrobat Reader to open the manual file. Please download the latest version of Acrobat Reader software from

<http://www.adobe.com/products/acrobat/readstep2.html>

5.2 SOFTWARE

Installing Software

1. Insert the Setup CD to the optical drive. The drivers installation program would appear if the Autorun function has been enabled.
2. Select **Software Installation**, and then click on the respective software title.
3. Follow the on-screen instructions to complete the installation.

Launching Software

After the installation process, you will see the software icon “eHOT Line” / “BIOS Update” appears on the desktop. Double-click the icon to launch the utility.

eHot-Line (Optional)

eHot-Line is a convenient utility that helps you to contact with our Tech-Support system. This utility will collect the system information which is useful for analyzing the problem you may have encountered, and then send these information to our tech-support department to help you fix the problem.

 Before you use this utility, please set Outlook Express as your default e-mail client application program.

*represents important information that you must provide. Without this information, you may not be able to send out the mail.

This block will show the information which would be collected in the mail.

*Describe condition of your system.

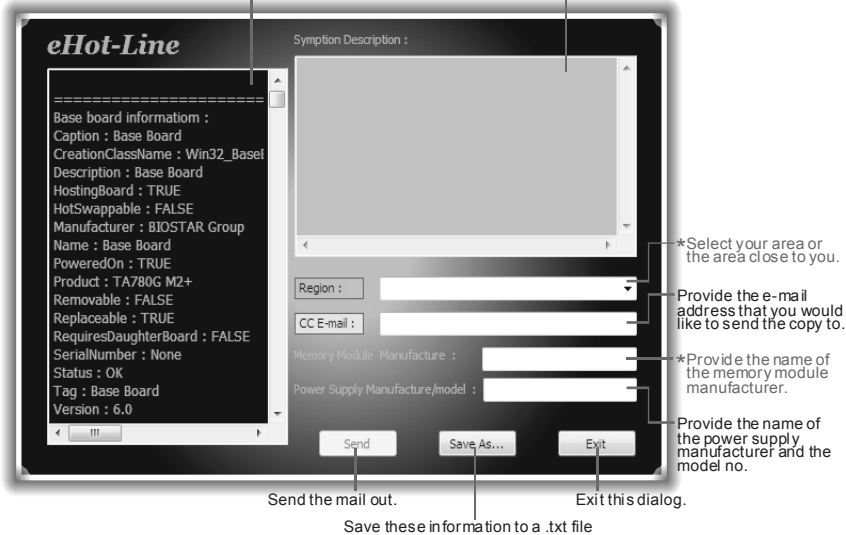

The screenshot shows the eHot-Line utility window. On the left, a text area displays system information: Base board information: Caption: Base Board, CreationClassName: Win32_Base, Description: Base Board, HostingBoard: TRUE, HotSwappable: FALSE, Manufacturer: BIOSTAR Group, Name: Base Board, PoweredOn: TRUE, Product: TA780G M2+, Removable: FALSE, Replaceable: TRUE, RequiresDaughterBoard: FALSE, SerialNumber: None, Status: OK, Tag: Base Board, Version: 6.0. On the right, there is a 'Symptom Description' text area. Below it are input fields for 'Region', 'CC E-mail', 'Memory Module Manufacture', and 'Power Supply Manufacture/model'. At the bottom are 'Send', 'Save As...', and 'Exit' buttons. Annotations with arrows point to various parts of the interface: the system information list, the symptom description area, the Region dropdown, the CC E-mail field, the Memory Module Manufacture field, the Power Supply Manufacture/model field, the Send button, the Save As... button, and the Exit button.

*Select your area or the area close to you.

Provide the e-mail address that you would like to send the copy to.

*Provide the name of the memory module manufacturer.

Provide the name of the power supply manufacturer and the model no.

Send the mail out.

Save these information to a .txt file

Exit this dialog.

After filling up this information, click **“Send”** to send the mail out. A warning dialog would appear asking for your confirmation; click **“Send”** to confirm or **“Do Not Send”** to cancel.



If you want to save this information to a .txt file, click **“Save As...”** and then you will see a saving dialog appears asking you to enter file name.

Enter the file name and then click **“Save”**. Your system information will be saved to a .txt file.

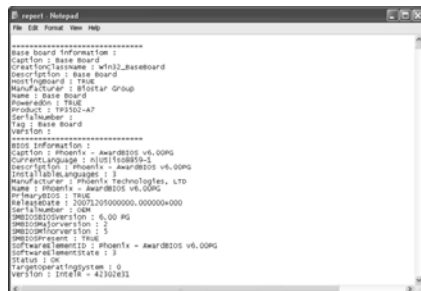
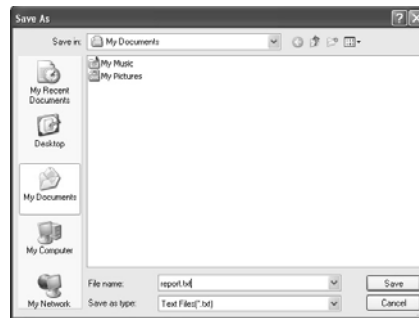

Open the saved .txt file, you will see your system information including motherboard/BIOS/CPU/video/device/OS information. This information is also concluded in the sent mail.



We will not share customer’s data with any other third parties, so please feel free to provide your system information while using eHot-Line service.



If you are not using Outlook Express as your default e-mail client application, you may need to save the system information to a .txt file and send the file to our tech support with other e-mail application. Go to the following web <http://www.biostar.com.tw/app/en-us/about/contact.php> for getting our contact information.

BIOS Update

BIOS Update is a convenient utility which allows you to update your motherboard BIOS under Windows system.

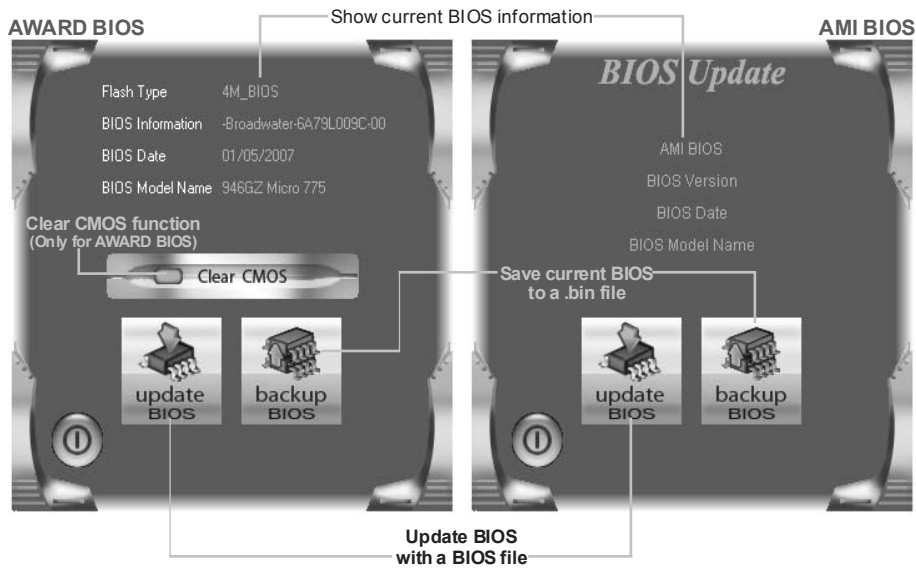

<Backup BIOS>

Once click on this button, the saving dialog will show. Choose the position to save file and enter file name. (We recommend that the file name should be English/number and no longer than 7 characters.) Then click **Save**.

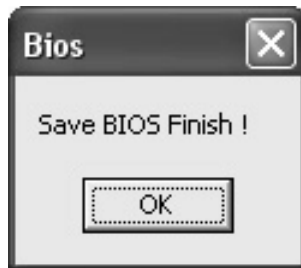
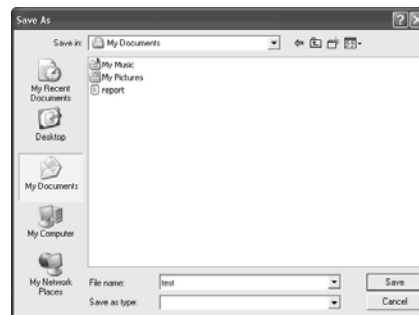

After the saving process, finish dialog will show. Click on **OK** to complete the BIOS Backup procedure.

<Update BIOS>

Before doing this, please download the proper BIOS file from the website.

For AWARD BIOS, update BIOS procedure should be run with Clear CMOS function, so please check on Clear CMOS first.

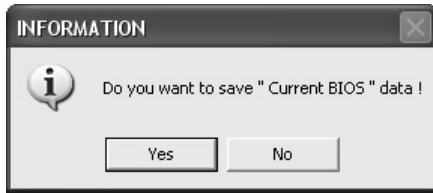
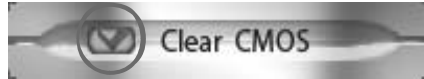

Then click Update BIOS button, a dialog will show for asking you backup current BIOS. Click **Yes** for BIOS backup and refer to the Backup BIOS procedure; or click **No** to skip this procedure.

After the BIOS Backup procedure, the open dialog will show for requesting the BIOS file which is going to be updated. Please choose the proper BIOS file for updating, then click on **Open**.

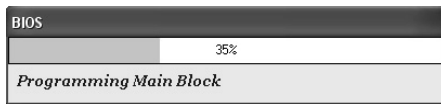
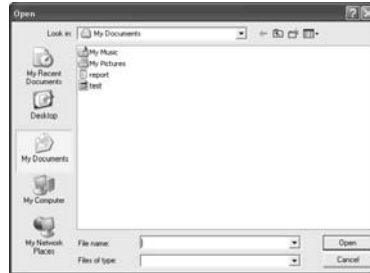

The utility will update BIOS with the proper BIOS file, and this process may take minutes. Please do not open any other applications during this process.

After the BIOS Update process, click on **OK** to restart the system.

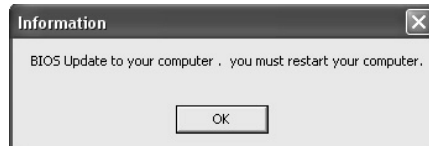

While the system boots up and the full screen logo shows, press  <Delete> key to enter BIOS setup.

In the BIOS setup, use the **Load Optimized Defaults** function and then **Save and Exit Setup** to exit BIOS setup. BIOS Update is completed.



All the information and content above about the software are subject to be changed without notice. For better performance, the software is being continuously updated. The information and pictures described above are for your reference only. The actual information and settings on board may be slightly different from this manual.

5.3 EXTRA INFORMATION

CPU Overheated

If the system shutdown automatically after power on system for seconds, that means the CPU protection function has been activated.

When the CPU is over heated, the motherboard will shutdown automatically to avoid a damage of the CPU, and the system may not power on again.

In this case, please double check:

1. The CPU cooler surface is placed evenly with the CPU surface.
2. CPU fan is rotated normally.
3. CPU fan speed is fulfilling with the CPU speed.

After confirmed, please follow steps below to relief the CPU protection function.

1. Remove the power cord from power supply for seconds.
2. Wait for seconds.
3. Plug in the power cord and boot up the system.

Or you can:

1. Clear the CMOS data.
(See "Close CMOS Header: JCMOS1" section)
2. Wait for seconds.
3. Power on the system again.

BIO-Flasher

BIO-Flasher is a BIOS flashing utility providing you an easy and simple way to update your BIOS via USB pen drive or floppy disk.

The BIO-Flasher is built in the BIOS chip. To enter the utility, **press <F12> during the Power-On Self Tests (POST)** procedure while booting up.

Updating BIOS with BIO-Flasher

1. Go to the website to download the latest BIOS file for the motherboard.
2. Then, save the BIOS file into a USB pen drive or a floppy disk.
3. Insert the USB pen drive or the floppy disk that contains the BIOS file to the USB port or the floppy disk drive.
4. Power on or reset the computer and then press **<F12>** during the **POST** process. A select dialog as the picture on the right appears. Select the device contains the BIOS file and press **<Enter>** to enter the utility.



5. The utility will show the BIOS files and their respective information. Select the proper BIOS file and press **<Enter>** then **<Y>** to perform the BIOS update process.

6. After the update process, the utility will ask you to reboot the system. Press **<Y>** to proceed. BIOS update completes.



- This utility only allows storage device with FAT32/16 format and single partition.
- Shutting down or resetting the system while updating the BIOS will lead to system boot failure.

5.4 AMI BIOS BEEP CODE

Boot Block Beep Codes

Number of Beeps	Description
1	No media present. (Insert diskette in floppy drive A:)
2	"AMIBOOT.ROM" file not found in root directory of diskette in A:
3	Insert next diskette if multiple diskettes are used for recovery
4	Flash Programming successful
5	File read error
7	No Flash EPROM detected
10	Flash Erase error
11	Flash Program error
12	"AMIBOOT.ROM" file size error
13	BIOS ROM image mismatch (file layout does not match image present in flash device)

POST BIOS Beep Codes

Number of Beeps	Description
1	Memory refresh timer error
3	Base memory read/write test error
6	Keyboard controller BAT command failed
7	General exception error (processor exception interrupt error)
8	Display memory error (system video adapter)

Troubleshooting POST BIOS Beep Codes

Number of Beeps	Troubleshooting Action
1, 3	Reseat the memory, or replace with known good modules.
6, 7	<p>Fatal error indicating a serious problem with the system. Consult your system manufacturer. Before declaring the motherboard beyond all hope, eliminate the possibility of interference by a malfunctioning add-in card. Remove all expansion cards except the video adapter.</p> <ul style="list-style-type: none"> ● If beep codes are generated when all other expansion cards are absent, consult your system manufacturer's technical support. ● If beep codes are not generated when all other expansion cards are absent, one of the add-in cards is causing the malfunction. Insert the cards back into the system one at a time until the problem happens again. This will reveal the malfunctioning card.
8	If the system video adapter is an add-in card, replace or reseat the video adapter. If the video adapter is an integrated part of the system board, the board may be faulty.

5.5 TROUBLESHOOTING

Probable	Solution
<ol style="list-style-type: none"> There is no power in the system. Power LED does not shine; the fan of the power supply does not work Indicator light on keyboard does not shine. 	<ol style="list-style-type: none"> Make sure power cable is securely plugged in. Replace cable. Contact technical support.
System is inoperative. Keyboard lights are on, power indicator lights are lit, and hard drives are running.	Using even pressure on both ends of the DIMM, press down firmly until the module snaps into place.
System does not boot from a hard disk drive, but can be booted from optical drive.	<ol style="list-style-type: none"> Check cable running from disk to disk controller board. Make sure both ends are securely plugged in; check the drive type in the standard CMOS setup. Backing up the hard drive is extremely important. All hard disks are capable of breaking down at any time.
System only boots from an optical drive. Hard disks can be read, applications can be used, but system fails to boot from a hard disk.	<ol style="list-style-type: none"> Back up data and applications files. Reformat the hard drive. Re-install applications and data using backup disks.
Screen message shows "Invalid Configuration" or "CMOS Failure."	Review system's equipment. Make sure correct information is in setup.
System cannot boot after user installs a second hard drive.	<ol style="list-style-type: none"> Set master/slave jumpers correctly. Run SETUP program and select correct drive types. Call the drive manufacturers for compatibility with other drives.

APPENDIX: SPEC IN OTHER LANGUAGES

GERMAN

	<i>A780GE/A760GE</i>	<i>A785GE</i>
CPU	<p>Sockel AM2+</p> <p>AMD Sempron / Athlon / Athlon II / Phenom / Phenom II Prozessoren</p> <p>Die AMD 64-Architektur unterstützt eine 32-Bit- und 64-Bit-Datenverarbeitung</p> <p>Unterstützt Hyper Transport 3.0 und Cool'n'Quiet (Maximales Watt: 95W)</p>	<p>Sockel AM2+</p> <p>AMD Sempron / Athlon / Athlon II / Phenom / Phenom II Prozessoren</p> <p>Die AMD 64-Architektur unterstützt eine 32-Bit- und 64-Bit-Datenverarbeitung</p> <p>Unterstützt Hyper Transport 3.0 und Cool'n'Quiet (Maximales Watt: 95W)</p>
FSB	Unterstützt HyperTransport 3.0 mit einer Bandbreite von bis zu 5.2 GT/s	Unterstützt HyperTransport 3.0 mit einer Bandbreite von bis zu 4.4 GT/s
Chipsatz	AMD 780G / 760G AMD SB710	AMD 785G AMD SB710
Super E/A	<p>ITE8718F</p> <p>Bietet die häufig verwendeten alten Super E/A-Funktionen.</p> <p>Low Pin Count-Schnittstelle</p> <p>Umgebungskontrolle,</p> <p>Hardware-Überwachung</p> <p>"Smart Guardian"-Funktion von ITE</p>	<p>ITE8718F</p> <p>Bietet die häufig verwendeten alten Super E/A-Funktionen.</p> <p>Low Pin Count-Schnittstelle</p> <p>Umgebungskontrolle,</p> <p>Hardware-Überwachung</p> <p>"Smart Guardian"-Funktion von ITE</p>
Arbeitsspeicher	<p>DDR2 DIMM-Steckplätze x 2</p> <p>Max. 8GB Arbeitsspeicher</p> <p>Jeder DIMM unterstützt 256MB/512MB/1GB/2GB/4GB DDR2.</p> <p>Dual-Kanal DDR2 Speichermodul</p> <p>Unterstützt DDR2 533 / 667 / 800</p> <p>Unterstützt DDR2 1066 (for AM2+/AM3 CPU only)</p> <p>registrierte DIMMs. ECC DIMMs werden nicht unterstützt.</p>	<p>DDR2 DIMM-Steckplätze x 2</p> <p>Max. 8GB Arbeitsspeicher</p> <p>Jeder DIMM unterstützt 256MB/512MB/1GB/2GB/4GB DDR2.</p> <p>Dual-Kanal DDR2 Speichermodul</p> <p>Unterstützt DDR2 533 / 667 / 800</p> <p>Unterstützt DDR2 1066 (for AM2+/AM3 CPU only)</p> <p>registrierte DIMMs. ECC DIMMs werden nicht unterstützt.</p>
Grafik	<p>Integrierter AMD 780G / 760G-Chipsatz</p> <p>Max. 512MB gemeinsam benutzter Videospeicher</p> <p>Unterstützt DX10/HDCP (780G ONLY)</p>	<p>Integrierter AMD 785G-Chipsatz</p> <p>Max. 512MB gemeinsam benutzter Videospeicher</p> <p>Unterstützt HDCP</p>
IDE	<p>Integrierter IDE-Controller</p> <p>Ultra DMA 33 / 66 / 100 / 133 Bus</p> <p>Master-Modus</p> <p>Unterstützt PIO-Modus 0~4,</p>	<p>Integrierter IDE-Controller</p> <p>Ultra DMA 33 / 66 / 100 / 133 Bus</p> <p>Master-Modus</p> <p>Unterstützt PIO-Modus 0~4,</p>
SATA	<p>Integrierter Serial ATA-Controller</p> <p>Datentransferrate bis zu 3 Gb/s</p> <p>Konform mit der SATA-Spezifikation Version 2.0.</p>	<p>Integrierter Serial ATA-Controller</p> <p>Datentransferrate bis zu 3 Gb/s</p> <p>Konform mit der SATA-Spezifikation Version 2.0.</p>

A780GE/A760GE/A785GE

	A780GE/A760GE	A785GE
LAN	Realtek RTL 8111DL 10 / 100 / 1000 Mb/s Auto-Negotiation Halb-/ Vollduplex-Funktion	Realtek RTL 8111DL 10 / 100 / 1000 Mb/s Auto-Negotiation Halb-/ Vollduplex-Funktion
HD Audio-Unterstützung	ALC662 5.1-Kanal-Audioausgabe Unterstützt High-Definition Audio	ALC662 5.1-Kanal-Audioausgabe Unterstützt High-Definition Audio
Steckplätze	PCI Express Gen2 x16 Steckplatz x1 PCI-Steckplatz x2	PCI Express Gen2 x16 Steckplatz x1 PCI-Steckplatz x2
Onboard-Anschluss	Diskettenlaufwerkanschluss x1 IDE-Anschluss x1 SATA-Anschluss x4 Fronttafelanschluss x1 Front-Audioanschluss x1 S/PDIF- Ausgangsanschluss x1 CPU-Lüfter-Sockel x1 System-Lüfter-Sockel x1 "CMOS löschen"-Sockel x1 USB-Anschluss x2 Stromanschluss (24-polig) x1 Stromanschluss (4-polig) x1 Druckeranschluss Anschluss x1 Serieller Anschluss x1	Diskettenlaufwerkanschluss x1 IDE-Anschluss x1 SATA-Anschluss x4 Fronttafelanschluss x1 Front-Audioanschluss x1 S/PDIF- Ausgangsanschluss x1 CPU-Lüfter-Sockel x1 System-Lüfter-Sockel x1 "CMOS löschen"-Sockel x1 USB-Anschluss x2 Stromanschluss (24-polig) x1 Stromanschluss (4-polig) x1 Druckeranschluss Anschluss x1 Serieller Anschluss x1
Rückseiten-E/A	PS/2-Tastatur x1 PS/2-Maus x1 VGA-Anschluss x1 LAN-Anschluss x1 USB-Anschluss x4 Audioanschluss x3 DVI-Anschluss x1	PS/2-Tastatur x1 PS/2-Maus x1 VGA-Anschluss x1 LAN-Anschluss x1 USB-Anschluss x4 Audioanschluss x3 DVI-Anschluss x1
Platinengröße	200 mm (B) X 244 mm (L)	200 mm (B) X 244 mm (L)
Sonderfunktionen	Unterstützt RAID 0 / 1 / 1+0	Unterstützt RAID 0 / 1 / 1+0
OS-Unterstützung	Windows XP / Vista 32 / 64 Biostar behält sich das Recht vor, ohne Ankündigung die Unterstützung für ein Betriebssystem hinzuzufügen oder zu entfernen.	Windows XP / Vista 32 / 64 Biostar behält sich das Recht vor, ohne Ankündigung die Unterstützung für ein Betriebssystem hinzuzufügen oder zu entfernen.

FRENCH

	A780GE/A760GE	A785GE
UC	Socket AM2+ Processeurs AMD Sempron / Athlon / Athlon II / Phenom / Phenom II L'architecture AMD 64 permet le calcul 32 et 64 bits Prend en charge Hyper Transport 3.0 et Cool'n'Quiet (Watt maximum : 95W)	Socket AM2+ Processeurs AMD Sempron / Athlon / Athlon II / Phenom / Phenom II L'architecture AMD 64 permet le calcul 32 et 64 bits Prend en charge Hyper Transport 3.0 et Cool'n'Quiet (Watt maximum : 95W)
Bus frontal	Prend en charge Hyper Transport 3.0 jusqu'à une bande passante de 5.2 GT/s	Prend en charge Hyper Transport 3.0 jusqu'à une bande passante de 4.4 GT/s
Chipset	AMD 780G / 760G AMD SB710	AMD 785G AMD SB710
Super E/S	ITE 8718F Fournit la fonctionnalité de Super E/S patrimoniales la plus utilisée. Interface à faible compte de broches Initiatives de contrôle environnementales, Moniteur de matériel Fonction "Gardien intelligent" de l'ITE	ITE 8718F Fournit la fonctionnalité de Super E/S patrimoniales la plus utilisée. Interface à faible compte de broches Initiatives de contrôle environnementales, Moniteur de matériel Fonction "Gardien intelligent" de l'ITE
Mémoire principale	Fentes DDR2 DIMM x 2 Capacité mémoire maximale de 8 Go Chaque DIMM prend en charge des DDR2 de 256 Mo/512 Mo et 1Go/2Go/4Go Module de mémoire DDR2 à mode à double voie Prend en charge la DDR2 533 / 667 / 800 Prend en charge la DDR2 1066 (for AM2+/AM3 CPU only) Les DIMM à registres et DIMM avec code correcteurs d'erreurs ne sont pas prises en charge	Fentes DDR2 DIMM x 2 Capacité mémoire maximale de 8 Go Chaque DIMM prend en charge des DDR2 de 256 Mo/512 Mo et 1Go/2Go/4Go Module de mémoire DDR2 à mode à double voie Prend en charge la DDR2 533 / 667 / 800 Prend en charge la DDR2 1066 (for AM2+/AM3 CPU only) Les DIMM à registres et DIMM avec code correcteurs d'erreurs ne sont pas prises en charge
Graphiques	Intégré dans la chipset AMD 780G / 760G Mémoire vidéo partagée maximale de 512 Mo Prise en charge DX10/HDCP (780G ONLY)	Intégré dans la chipset AMD 785G Mémoire vidéo partagée maximale de 512 Mo Prise en charge HDCP
IDE	Contrôleur IDE intégré Mode principale de Bus Ultra DMA 33 / 66 / 100 / 133 Prend en charge le mode PIO 0~4,	Contrôleur IDE intégré Mode principale de Bus Ultra DMA 33 / 66 / 100 / 133 Prend en charge le mode PIO 0~4,
SATA	Contrôleur Serial ATA intégré Taux de transfert jusqu'à 3 Go/s. Conforme à la spécification SATA Version 2.0	Contrôleur Serial ATA intégré Taux de transfert jusqu'à 3 Go/s. Conforme à la spécification SATA Version 2.0

A780GE/A760GE/A785GE

	A780GE/A760GE	A785GE
LAN	Realtek RTL 8111DL 10 / 100 / 1000 Mb/s négociation automatique Half / Full duplex capability	Realtek RTL 8111DL 10 / 100 / 1000 Mb/s négociation automatique Half / Full duplex capability
Prise en charge audio HD	ALC662 Sortie audio à 5.1 voies Prise en charge de l'audio haute définition	ALC662 Sortie audio à 5.1 voies Prise en charge de l'audio haute définition
Fentes	Fente PCI Express Gen2 x16 x1 Fente PCI x2	Fente PCI Express Gen2 x16 x1 Fente PCI x2
Connecteur embarqué	Connecteur de disquette x1 Connecteur IDE x1 Connecteur SATA x4 Connecteur du panneau avant x1 Connecteur Audio du panneau avant x1 Connecteur de sortie S/PDIF x1 Embase de ventilateur UC x1 Embase de ventilateur système x1 Embase d'effacement CMOS x1 Connecteur USB x2 Connecteur d'alimentation x1 (24 broches) Connecteur d'alimentation x1 (4 broches) Connecteur de Port d'imprimante x1 Connecteur de Port série x1	Connecteur de disquette x1 Connecteur IDE x1 Connecteur SATA x4 Connecteur du panneau avant x1 Connecteur Audio du panneau avant x1 Connecteur de sortie S/PDIF x1 Embase de ventilateur UC x1 Embase de ventilateur système x1 Embase d'effacement CMOS x1 Connecteur USB x2 Connecteur d'alimentation x1 (24 broches) Connecteur d'alimentation x1 (4 broches) Connecteur de Port d'imprimante x1 Connecteur de Port série x1
E/S du panneau arrière	Clavier PS/2 x1 Souris PS/2 x1 Port VGA x1 Port LAN x1 Port USB x4 Fiche audio x3 Port DVI x1	Clavier PS/2 x1 Souris PS/2 x1 Port VGA x1 Port LAN x1 Port USB x4 Fiche audio x3 Port DVI x1
Dimensions de la carte	200 mm (l) X 244 mm (H)	200 mm (l) X 244 mm (H)
Fonctionnalités spéciales	Prise en charge RAID 0 / 1 / 1+0	Prise en charge RAID 0 / 1 / 1+0
Support SE	Windows XP / Vista 32 / 64 BioStar se réserve le droit d'ajouter ou de supprimer le support de SE avec ou sans préavis.	Windows XP / Vista 32 / 64 BioStar se réserve le droit d'ajouter ou de supprimer le support de SE avec ou sans préavis.

ITALIAN

	A780GE/A760GE	A785GE
CPU	Socket AM2+ Processori AMD Sempron / Athlon / Athlon II / Phenom / Phenom II L'architettura AMD 64 abilita la computazione 32 e 64 bit Supporto di Hyper Transport 3.0 e Cool'n'Quiet (Watt massimo: 95W)	Socket AM2+ Processori AMD Sempron / Athlon / Athlon II / Phenom / Phenom II L'architettura AMD 64 abilita la computazione 32 e 64 bit Supporto di Hyper Transport 3.0 e Cool'n'Quiet (Watt massimo: 95W)
FSB	Supporto di HyperTransport 3.0 fino a 5.2 GT/s di larghezza di banda	Supporto di HyperTransport 3.0 fino a 4.4 GT/s di larghezza di banda
Chipset	AMD 780G / 760G AMD SB710	AMD 785G AMD SB710
Super I/O	ITE 8718F Fornisce le funzionalità legacy Super I/O usate più comunemente. Interfaccia LPC (Low Pin Count) Funzioni di controllo dell'ambiente: Monitoraggio hardware Funzione "Smart Guardian" di ITE	ITE 8718F Fornisce le funzionalità legacy Super I/O usate più comunemente. Interfaccia LPC (Low Pin Count) Funzioni di controllo dell'ambiente: Monitoraggio hardware Funzione "Smart Guardian" di ITE
Memoria principale	Alloggi DIMM DDR2 x 2 Capacità massima della memoria 8GB Ciascun DIMM supporta DDR2 256MB/512MB e 1GB/2GB/4GB Modulo di memoria DDR2 a canale doppio Supporto di DDR2 533 / 667 / 800 Supporto di DDR2 1066 (for AM2+/AM3 CPU only) DIMM registrati e DIMM ECC non sono supportati	Alloggi DIMM DDR2 x 2 Capacità massima della memoria 8GB Ciascun DIMM supporta DDR2 256MB/512MB e 1GB/2GB/4GB Modulo di memoria DDR2 a canale doppio Supporto di DDR2 533 / 667 / 800 Supporto di DDR2 1066 (for AM2+/AM3 CPU only) DIMM registrati e DIMM ECC non sono supportati
Grafica	Integrata nel Chipset AMD 780G / 760G La memoria video condivisa massima è di 512 MB Supporto DX10/HDCP (780G ONLY)	Integrata nel Chipset AMD 785G La memoria video condivisa massima è di 512 MB Supporto HDCP
IDE	Controller IDE integrato Modalità Bus Master Ultra DMA 33 / 66 / 100 / 133 Supporto modalità PIO Mode 0-4	Controller IDE integrato Modalità Bus Master Ultra DMA 33 / 66 / 100 / 133 Supporto modalità PIO Mode 0-4
SATA	Controller Serial ATA integrato Velocità di trasferimento dei dati fino a 3 Gb/s. Compatibile specifiche SATA Versione 2.0.	Controller Serial ATA integrato Velocità di trasferimento dei dati fino a 3 Gb/s. Compatibile specifiche SATA Versione 2.0.

A780GE/A760GE/A785GE

	A780GE/A760GE	A785GE
LAN	Realtek RTL 8111DL Negoziazione automatica 10 / 100 / 1000 Mb/s Capacità Half / Full Duplex	Realtek RTL 8111DL Negoziazione automatica 10 / 100 / 1000 Mb/s Capacità Half / Full Duplex
Supporto audio HD	ALC662 Uscita audio 5.1 canali Supporto audio High-Definition (HD)	ALC662 Uscita audio 5.1 canali Supporto audio High-Definition (HD)
Alloggi	Alloggio PCI Express Gen2 x16 x1 Alloggio PCI x2	Alloggio PCI Express Gen2 x16 x1 Alloggio PCI x2
Connettori su scheda	Connettore floppy x1 Connettore IDE x1 Connettore SATA x4 Connettore pannello frontale x1 Connettore audio frontale x1 Connettore output SPDIF x1 Collettore ventolina CPU x1 Collettore ventolina sistema x1 Collettore cancellazione CMOS x1 Connettore USB x2 Connettore alimentazione (24 pin) x1 Connettore alimentazione (4 pin) x1 Connettore Porta stampante x1 Connettore Porta seriale x1	Connettore floppy x1 Connettore IDE x1 Connettore SATA x4 Connettore pannello frontale x1 Connettore audio frontale x1 Connettore output SPDIF x1 Collettore ventolina CPU x1 Collettore ventolina sistema x1 Collettore cancellazione CMOS x1 Connettore USB x2 Connettore alimentazione (24 pin) x1 Connettore alimentazione (4 pin) x1 Connettore Porta stampante x1 Connettore Porta seriale x1
I/O pannello posteriore	Tastiera PS/2 x1 Mouse PS/2 x1 Porta VGA x1 Porta LAN x1 Porta USB x4 Connettore audio x3 Porta DVI x1	Tastiera PS/2 x1 Mouse PS/2 x1 Porta VGA x1 Porta LAN x1 Porta USB x4 Connettore audio x3 Porta DVI x1
Dimensioni scheda	200 mm (larghezza) x 244 mm (altezza)	200 mm (larghezza) x 244 mm (altezza)
Caratteristiche speciali	Supporto RAID 0 / 1 / 1+0	Supporto RAID 0 / 1 / 1+0
Sistemi operativi supportati	Windows XP / Vista 32 / 64 Biostar si riserva il diritto di aggiungere o rimuovere il supporto di qualsiasi sistema operativo senza preavviso.	Windows XP / Vista 32 / 64 Biostar si riserva il diritto di aggiungere o rimuovere il supporto di qualsiasi sistema operativo senza preavviso.

SPANISH

	A780GE/A760GE	A785GE
CPU	<p>Conector AM2+</p> <p>Procesadores AMD Sempron / Athlon / Athlon II / Phenom / Phenom II</p> <p>La arquitectura AMD 64 permite el procesado de 32 y 64 bits</p> <p>Soporta las tecnologías Hyper Transport 3.0 y Cool'n'Quiet</p> <p>(Vatio máximo: 95W)</p>	<p>Conector AM2+</p> <p>Procesadores AMD Sempron / Athlon / Athlon II / Phenom / Phenom II</p> <p>La arquitectura AMD 64 permite el procesado de 32 y 64 bits</p> <p>Soporta las tecnologías Hyper Transport 3.0 y Cool'n'Quiet</p> <p>(Vatio máximo: 95W)</p>
FSB	Admite HyperTransport 3.0 con un ancho de banda de hasta 5.2 GT/s	Admite HyperTransport 3.0 con un ancho de banda de hasta 4.4 GT/s
Conjunto de chips	<p>AMD 780G / 760G</p> <p>AMD SB710</p>	<p>AMD 785G</p> <p>AMD SB710</p>
Súper E/S	<p>ITE 8718F</p> <p>Le ofrece las funcionalidades heredadas de uso más común Súper E/S.</p> <p>Interfaz de cuenta Low Pin</p> <p>Iniciativas de control de entorno, Monitor hardware</p> <p>Función "Guardia inteligente" de ITE</p>	<p>ITE 8718F</p> <p>Le ofrece las funcionalidades heredadas de uso más común Súper E/S.</p> <p>Interfaz de cuenta Low Pin</p> <p>Iniciativas de control de entorno, Monitor hardware</p> <p>Función "Guardia inteligente" de ITE</p>
Memoria principal	<p>Ranuras DIMM DDR2 x 2</p> <p>Capacidad máxima de memoria de 8GB</p> <p>Cada DIMM admite DDR de 256MB/512MB y 1GB/2GB/4GB</p> <p>Módulo de memoria DDR2 de canal Doble</p> <p>Admite DDR2 de 533 / 667 / 800</p> <p>Admite DDR2 de 1066 (for AM2+/AM3 CPU only)</p> <p>No admite DIMM registrados o DIMM compatibles con ECC</p>	<p>Ranuras DIMM DDR2 x 2</p> <p>Capacidad máxima de memoria de 8GB</p> <p>Cada DIMM admite DDR de 256MB/512MB y 1GB/2GB/4GB</p> <p>Módulo de memoria DDR2 de canal Doble</p> <p>Admite DDR2 de 533 / 667 / 800</p> <p>Admite DDR2 de 1066 (for AM2+/AM3 CPU only)</p> <p>No admite DIMM registrados o DIMM compatibles con ECC</p>
Gráficos	<p>Integrados en el conjunto de chips AMD 780G / 760G</p> <p>Memoria máxima de vídeo compartida de 512 MB</p> <p>Admite DX10/HDCP (780G ONLY)</p>	<p>Integrados en el conjunto de chips AMD 785G</p> <p>Memoria máxima de vídeo compartida de 512 MB</p> <p>Admite HDCP</p>
IDE	<p>Controlador IDE integrado</p> <p>Modo bus maestro Ultra DMA 33 / 66 / 100 / 133</p> <p>Soporte los Modos PIO 0~4,</p>	<p>Controlador IDE integrado</p> <p>Modo bus maestro Ultra DMA 33 / 66 / 100 / 133</p> <p>Soporte los Modos PIO 0~4,</p>
SATA	<p>Controlador ATA Serie Integrado</p> <p>Tasas de transferencia de hasta 3 Gb/s.</p> <p>Compatible con la versión SATA 2.0.</p>	<p>Controlador ATA Serie Integrado</p> <p>Tasas de transferencia de hasta 3 Gb/s.</p> <p>Compatible con la versión SATA 2.0.</p>

A780GE/A760GE/A785GE

	A780GE/A760GE		A785GE	
Red Local	Realtek RTL 8111DL Negociación de 10 / 100 / 1000 Mb/s Funciones Half / Full dúplex		Realtek RTL 8111DL Negociación de 10 / 100 / 1000 Mb/s Funciones Half / Full dúplex	
Soporte de sonido HD	ALC662 Salida de sonido de 5.1 canales Soporte de sonido Alta Definición		ALC662 Salida de sonido de 5.1 canales Soporte de sonido Alta Definición	
Ranuras	Ranura PCI Express Gen2 x16	X1	Ranura PCI Express Gen2 x16	X1
	Ranura PCI	X2	Ranura PCI	X2
Conectores en placa	Conector disco flexible	X1	Conector disco flexible	X1
	Conector IDE	X1	Conector IDE	X1
	Conector SATA	X4	Conector SATA	X4
	Conector de panel frontal	X1	Conector de panel frontal	X1
	Conector de sonido frontal	X1	Conector de sonido frontal	X1
	Conector de salida S/PDIF	X1	Conector de salida S/PDIF	X1
	Cabecera de ventilador de CPU	X1	Cabecera de ventilador de CPU	X1
	Cabecera de ventilador de sistema	X1	Cabecera de ventilador de sistema	X1
	Cabecera de borrado de CMOS	X1	Cabecera de borrado de CMOS	X1
	Conector USB	X2	Conector USB	X2
	Conector de alimentación	X1	Conector de alimentación	X1
	(24 patillas)		(24 patillas)	
	Conector de alimentación	X1	Conector de alimentación	X1
	(4 patillas)		(4 patillas)	
	Conector Puerto de impresora	X1	Conector Puerto de impresora	X1
	Conector Puerto serie	X1	Conector Puerto serie	X1
Panel trasero de E/S	Teclado PS/2	X1	Teclado PS/2	X1
	Ratón PS/2	X1	Ratón PS/2	X1
	Puerto VGA	X1	Puerto VGA	X1
	Puerto de red local	X1	Puerto de red local	X1
	Puerto USB	X4	Puerto USB	X4
	Conector de sonido	X3	Conector de sonido	X3
	Puerto DVI	X1	Puerto DVI	X1
Tamaño de la placa	200 mm. (A) X 244 Mm. (H)		200 mm. (A) X 244 Mm. (H)	
Funciones especiales	Admite RAID 0 / 1 / 1+0		Admite RAID 0 / 1 / 1+0	
Soporte de sistema operativo	Windows XP / Vista 32 / 64 Bióstar se reserva el derecho de añadir o retirar el soporte de cualquier SO con o sin aviso previo.		Windows XP / Vista 32 / 64 Bióstar se reserva el derecho de añadir o retirar el soporte de cualquier SO con o sin aviso previo.	

PORTUGUESE

	A780GE/A760GE	A785GE
CPU	Socket AM2+ Processadores AMD Sempron / Athlon / Athlon II / Phenom / Phenom II A arquitectura AMD 64 permite uma computação de 32 e 64 bits Suporta as tecnologias Hyper Transport 3.0 e Cool'n'Quiet (Watt máximo: 95W)	Socket AM2+ Processadores AMD Sempron / Athlon / Athlon II / Phenom / Phenom II A arquitectura AMD 64 permite uma computação de 32 e 64 bits Suporta as tecnologias Hyper Transport 3.0 e Cool'n'Quiet (Watt máximo: 95W)
FSB	Suporta a tecnologia HyperTransport 3.0 com uma largura de banda até 5.2 GT/s	Suporta a tecnologia HyperTransport 3.0 com uma largura de banda até 4.4 GT/s
Chipset	AMD 780G / 760G AMD SB710	AMD 785G AMD SB710
Especificação Super I/O	ITE 8718F Proporciona as funcionalidades mais utilizadas em termos da especificação Super I/O. Interface LPC (Low Pin Count). Iniciativas para controlo do ambiente Monitorização do hardware Função "Smart Guardian" da ITE	ITE 8718F Proporciona as funcionalidades mais utilizadas em termos da especificação Super I/O. Interface LPC (Low Pin Count). Iniciativas para controlo do ambiente Monitorização do hardware Função "Smart Guardian" da ITE
Memória principal	Ranuras DIMM DDR2 x 2 Capacidade máxima de memória: 8 GB Cada módulo DIMM suporta uma memória DDR2 de 256 MB/512 MB & 1 GB/2 GB/4 GB Módulo de memória DDR2 de canal duplo Suporta módulos DDR2 533 / 667 / 800 Suporta módulos DDR2 1066 (for AM2+/AM3 CPU only) Os módulos DIMM registados e os DIMM ECC não são suportados	Ranuras DIMM DDR2 x 2 Capacidade máxima de memória: 8 GB Cada módulo DIMM suporta uma memória DDR2 de 256 MB/512 MB & 1 GB/2 GB/4 GB Módulo de memória DDR2 de canal duplo Suporta módulos DDR2 533 / 667 / 800 Suporta módulos DDR2 1066 (for AM2+/AM3 CPU only) Os módulos DIMM registados e os DIMM ECC não são suportados
Placa gráfica	Integrada no chipset AMD 780G / 760G Memória de vídeo máxima partilhada: 512 MB Suporta as funções DX10/HDCP (780G ONLY)	Integrada no chipset AMD 785G Memória de vídeo máxima partilhada: 512 MB Suporta as funções HDCP
IDE	Controlador IDE integrado Modo Bus master Ultra DMA 33 / 66 / 100 / 133 Suporta o modo PIO 0~4,	Controlador IDE integrado Modo Bus master Ultra DMA 33 / 66 / 100 / 133 Suporta o modo PIO 0~4,
SATA	Controlador Serial ATA integrado Velocidades de transmissão de dados até 3 Gb/s. Compatibilidade com a especificação SATA versão 2.0.	Controlador Serial ATA integrado Velocidades de transmissão de dados até 3 Gb/s. Compatibilidade com a especificação SATA versão 2.0.

A780GE/A760GE/A785GE

	A780GE/A760GE	A785GE
LAN	Realtek RTL 8111DL Auto negociação de 10 / 100 / 1000 Mb/s Capacidade semi/full-duplex	Realtek RTL 8111DL Auto negociação de 10 / 100 / 1000 Mb/s Capacidade semi/full-duplex
Suporte para áudio de alta definição	ALC662 Saída de áudio de 5.1 canais Suporta a especificação High-Definition Audio	ALC662 Saída de áudio de 5.1 canais Suporta a especificação High-Definition Audio
Ranhuras	Ranhura PCI Express Gen2 x16 x1 Ranhura PCI x2	Ranhura PCI Express Gen2 x16 x1 Ranhura PCI x2
Conectores na placa	Conector da unidade de disquetes x1 Conector IDE x1 Conector SATA x4 Conector do painel frontal x1 Conector de áudio frontal x1 Conector de saída S/PDIF x1 Conector da ventoinha da CPU x1 Conector da ventoinha do sistema x1 Conector para limpeza do CMOS x1 Conector USB x2 Conector de alimentação x1 (24 pinos) Conector de alimentação x1 (4 pinos) Conector da para impressora x1 Conector da Porta série x1	Conector da unidade de disquetes x1 Conector IDE x1 Conector SATA x4 Conector do painel frontal x1 Conector de áudio frontal x1 Conector de saída S/PDIF x1 Conector da ventoinha da CPU x1 Conector da ventoinha do sistema x1 Conector para limpeza do CMOS x1 Conector USB x2 Conector de alimentação x1 (24 pinos) Conector de alimentação x1 (4 pinos) Conector da para impressora x1 Conector da Porta série x1
Entradas/Saídas no painel traseiro	Teclado PS/2 x1 Rato PS/2 x1 Porta VGA x1 Porta LAN x1 Porta USB x4 Tomada de áudio x3 Porta DVI x1	Teclado PS/2 x1 Rato PS/2 x1 Porta VGA x1 Porta LAN x1 Porta USB x4 Tomada de áudio x3 Porta DVI x1
Tamanho da placa	200 mm (L) X 244 mm (A)	200 mm (L) X 244 mm (A)
Características especiais	Suporta as funções RAID 0 / 1 / 1+0	Suporta as funções RAID 0 / 1 / 1+0
Sistemas operativos suportados	Windows XP / Vista 32 / 64 A Biostar reserva-se o direito de adicionar ou remover suporte para qualquer sistema operativo com ou sem aviso prévio.	Windows XP / Vista 32 / 64 A Biostar reserva-se o direito de adicionar ou remover suporte para qualquer sistema operativo com ou sem aviso prévio.

POLISH

	A780GE/A760GE	A785GE
Procesor	Socket AM2+ AMD Sempron / Athlon / Athlon II / Phenom / Phenom II Procesory Architektura AMD 64 umożliwia przetwarzanie 32 i 64 bitowe Obsługa Hyper Transport 3.0 oraz Cool'n'Quiet (Maksymalny Watt: 95W)	Socket AM2+ AMD Sempron / Athlon / Athlon II / Phenom / Phenom II Procesory Architektura AMD 64 umożliwia przetwarzanie 32 i 64 bitowe Obsługa Hyper Transport 3.0 oraz Cool'n'Quiet (Maksymalny Watt: 95W)
FSB	Obsługa HyperTransport 3.0 o szerokości pasma do 5.2 GT/s	Obsługa HyperTransport 3.0 o szerokości pasma do 4.4 GT/s
Chipset	AMD 780G / 760G AMD SB710	AMD 785G AMD SB710
Pamięć główna	Gniazda DDR2 DIMM x 2 Maks. wielkość pamięci 8GB Każde gniazdo DIMM obsługuje moduły 256MB/512MB oraz 1GB/2GB/4GB DDR2 Moduł pamięci DDR2 z trybem podwójnego kanału Obsługa DDR2 533 / 667 / 800 Obsługa DDR2 1066 (for AM2+/AM3 CPU only) Brak obsługi Registered DIMM oraz ECC DIMM	Gniazda DDR2 DIMM x 2 Maks. wielkość pamięci 8GB Każde gniazdo DIMM obsługuje moduły 256MB/512MB oraz 1GB/2GB/4GB DDR2 Moduł pamięci DDR2 z trybem podwójnego kanału Obsługa DDR2 533 / 667 / 800 Obsługa DDR2 1066 (for AM2+/AM3 CPU only) Brak obsługi Registered DIMM oraz ECC DIMM
Super I/O	ITE 8718F Zapewnia najbardziej powszechne funkcje Super I/O. Interfejs Low Pin Count Funkcje kontroli warunków pracy, Monitor H/W Funkcja ITE "Smart Guardian"	ITE 8718F Zapewnia najbardziej powszechne funkcje Super I/O. Interfejs Low Pin Count Funkcje kontroli warunków pracy, Monitor H/W Funkcja ITE "Smart Guardian"
Grafika	Zintegrowana w chipsecie AMD 780G / 760G Maks. wielkość współdzielonej pamięci video wynosi 512 MB Obsługa DX10/HDCP (780G ONLY)	Zintegrowana w chipsecie AMD 785G Maks. wielkość współdzielonej pamięci video wynosi 512 MB Obsługa HDCP
IDE	Zintegrowany kontroler IDE Ultra DMA 33 / 66 / 100 / 133 Tryb Bus Master obsługa PIO tryb 0~4,	Zintegrowany kontroler IDE Ultra DMA 33 / 66 / 100 / 133 Tryb Bus Master obsługa PIO tryb 0~4,
SATA	Zintegrowany kontroler Serial ATA Transfer danych do 3 Gb/s. Zgodność ze specyfikacją SATA w wersji 2.0.	Zintegrowany kontroler Serial ATA Transfer danych do 3 Gb/s. Zgodność ze specyfikacją SATA w wersji 2.0.
LAN	Realtek RTL 8111DL 110 / 100 / 1000 Mb/s z automatyczną negocjacją szybkości Działanie w trybie połowicznego / pełnego duplexu	Realtek RTL 8111DL 10 / 100 / 1000 Mb/s z automatyczną negocjacją szybkości Działanie w trybie połowicznego / pełnego duplexu

A780GE/A760GE/A785GE

	A780GE/A760GE	A785GE
Obsługa audio HD	ALC662 5.1 kanałowe wyjście audio Obsługa High-Definition Audio	ALC662 5.1 kanałowe wyjście audio Obsługa High-Definition Audio
Gniazda	Gniazdo PCI Express Gen2 x16 x1 Gniazdo PCI x2	Gniazdo PCI Express Gen2 x16 x1 Gniazdo PCI x2
Złącza wbudowane	Złącze napędu dyskietek x1 Złącze IDE x1 Złącze SATA x4 Złącze panela przedniego x1 Przednie złącze audio x1 Złącze wyjścia S/PDIF x1 Złącze głośnikowe wentylatora procesora x1 Złącze głośnikowe wentylatora systemowego x1 Złącze głośnikowe kasowania CMOS x1 Złącze USB x2 Złącze zasilania (24 pinowe) x1 Złącze zasilania (4 pinowe) x1 Złącze Port drukarki x1 Złącze Port szeregowy x1	Złącze napędu dyskietek x1 Złącze IDE x1 Złącze SATA x4 Złącze panela przedniego x1 Przednie złącze audio x1 Złącze wyjścia S/PDIF x1 Złącze głośnikowe wentylatora procesora x1 Złącze głośnikowe wentylatora systemowego x1 Złącze głośnikowe kasowania CMOS x1 Złącze USB x2 Złącze zasilania (24 pinowe) x1 Złącze zasilania (4 pinowe) x1 Złącze Port drukarki x1 Złącze Port szeregowy x1
Back Panel I/O	Klawiatura PS/2 x1 Mysz PS/2 x1 Port VGA x1 Port LAN x1 Port USB x4 Gniazdo audio x3 Port DVI x1	Klawiatura PS/2 x1 Mysz PS/2 x1 Port VGA x1 Port LAN x1 Port USB x4 Gniazdo audio x3 Port DVI x1
Wymiary płyty	200 mm (S) X 244 mm (W)	200 mm (S) X 244 mm (W)
Funkcje specjalne	Obsługa RAID 0 / 1 / 1+0	Obsługa RAID 0 / 1 / 1+0
Obsługa systemu operacyjnego	Windows XP / Vista 32 / 64 Biostar zastrzega sobie prawo dodawania lub odwoływania obsługi dowolnego systemu operacyjnego bez powiadomienia.	Windows XP / Vista 32 / 64 Biostar zastrzega sobie prawo dodawania lub odwoływania obsługi dowolnego systemu operacyjnego bez powiadomienia.

RUSSIAN

	A780GE/A760GE	A785GE
CPU (центральный процессор)	Гнездо AM2+ Процессоры AMD Sempron / Athlon / Athlon II / Phenom / Phenom II Архитектура AMD 64 разрешать обработка данных на 32 и 64 бит Поддержка Hyper Transport 3.0 и Cool'n'Quiet (Максимальный ватт: 95W)	Гнездо AM2+ Процессоры AMD Sempron / Athlon / Athlon II / Phenom / Phenom II Архитектура AMD 64 разрешать обработка данных на 32 и 64 бит Поддержка Hyper Transport 3.0 и Cool'n'Quiet (Максимальный ватт: 95W)
FSB	Поддержка HyperTransport 3.0 с пропускной способностью до 5.2 GT/s	Поддержка HyperTransport 3.0 с пропускной способностью до 4.4 GT/s
Набор микросхем	AMD 780G / 760G AMD SB710	AMD 785G AMD SB710
Основная память	Слоты DDR2 DIMM x 2 Максимальная ёмкость памяти 8 ГБ Каждый модуль DIMM поддерживает 256МБ/512МБ & 1ГБ/2ГБ/4ГБ DDR2 Модуль памяти с двухканальным режимом DDR2 Поддержка DDR2 533 / 667 / 800 Поддержка DDR2 1066 (for AM2+/AM3 CPU only) Не поддерживает зарегистрированные модули DIMM and ECC DIMM	Слоты DDR2 DIMM x 2 Максимальная ёмкость памяти 8 ГБ Каждый модуль DIMM поддерживает 256МБ/512МБ & 1ГБ/2ГБ/4ГБ DDR2 Модуль памяти с двухканальным режимом DDR2 Поддержка DDR2 533 / 667 / 800 Поддержка DDR2 1066 (for AM2+/AM3 CPU only) Не поддерживает зарегистрированные модули DIMM and ECC DIMM
Super I/O	ITE 8718F Обеспечивает наиболее используемые действующие функциональные возможности Super I/O. Интерфейс с низким количеством выводов Инициативы по охране окружающей среды, Аппаратный монитор Функция ITE "Smart Guardian" (Интеллектуальная защита)	ITE 8718F Обеспечивает наиболее используемые действующие функциональные возможности Super I/O. Интерфейс с низким количеством выводов Инициативы по охране окружающей среды, Аппаратный монитор Функция ITE "Smart Guardian" (Интеллектуальная защита)
Графика	Встроенная в набор микросхем AMD 780G / 760G Максимальная совместно используемая видео память составляет 512 МБ Поддержка DX10/HDCP (780G ONLY)	Встроенная в набор микросхем AMD 785G Максимальная совместно используемая видео память составляет 512 МБ Поддержка HDCP
IDE	Встроенное устройство управления встроенными интерфейсами устройств Режим "хозяина" шины Ultra DMA 33 / 66 / 100 / 133 Поддержка режима PIO 0~4,	Встроенное устройство управления встроенными интерфейсами устройств Режим "хозяина" шины Ultra DMA 33 / 66 / 100 / 133 Поддержка режима PIO 0~4,
SATA	Встроенное последовательное устройство управления ATA скорость передачи данных до 3 гигабит/с. Соответствие спецификации SATA версия 2.0.	Встроенное последовательное устройство управления ATA скорость передачи данных до 3 гигабит/с. Соответствие спецификации SATA версия 2.0.

A780GE/A760GE/A785GE

A780GE/A760GE		A785GE	
Локальная сеть	Realtek RTL 8111DL Автоматическое согласование 10 / 100 / 1000 Мб/с Частичная / полная дуплексная способность	Realtek RTL 8111DL Автоматическое согласование 10 / 100 / 1000 Мб/с Частичная / полная дуплексная способность	
Звуковая поддержка жесткого диска	ALC662 Звуковая поддержка High-Definition 5.1канальный звуковой выход	ALC662 Звуковая поддержка High-Definition 5.1канальный звуковой выход	
Слоты	Слот PCI Express Gen2 x16 x1 Слот PCI x2	Слот PCI Express Gen2 x16 x1 Слот PCI x2	
Встроенный разъем	Разъем HГМД x1 Разъем IDE x1 Разъем SATA x4 Разъем на лицевой панели x1 Входной звуковой разъем x1 Разъем вывода для S/PDIF x1 Контактирующее приспособление вентилятора центрального процессора x1 Контактирующее приспособление вентилятора системы x1 Открытое контактирующее приспособление CMOS x1 USB-разъем x2 Разъем питания (24 вывод) x1 Разъем питания (4 вывод) x1 Разъем Порт подключения принтера x1 Разъем Последовательный порт x1	Разъем HГМД x1 Разъем IDE x1 Разъем SATA x4 Разъем на лицевой панели x1 Входной звуковой разъем x1 Разъем вывода для S/PDIF x1 Контактирующее приспособление вентилятора центрального процессора x1 Контактирующее приспособление вентилятора системы x1 Открытое контактирующее приспособление CMOS x1 USB-разъем x2 Разъем питания (24 вывод) x1 Разъем питания (4 вывод) x1 Разъем Порт подключения принтера x1 Разъем Последовательный порт x1	
Задняя панель средств ввода-вывода	Клавиатура PS/2 x1 Мышь PS/2 x1 Порт VGA x1 Порт LAN x1 USB-порт x4 Гнездо для подключения наушников x3 Порт DVI x1	Клавиатура PS/2 x1 Мышь PS/2 x1 Порт VGA x1 Порт LAN x1 USB-порт x4 Гнездо для подключения наушников x3 Порт DVI x1	
Размер панели	200 мм (Ш) X 244 мм (В)	200 мм (Ш) X 244 мм (В)	
Специальные технические характеристики	Поддержка RAID 0 / 1 / 1+0	Поддержка RAID 0 / 1 / 1+0	
Поддержка OS	Windows XP / Vista 32 / 64 Biostar сохраняет за собой право добавлять или удалять средства обеспечения для OS с или без предварительного уведомления.	Windows XP / Vista 32 / 64 Biostar сохраняет за собой право добавлять или удалять средства обеспечения для OS с или без предварительного уведомления.	

ARABIC

A785GE	A780GE/A760GE	
AM2+مقيس AMD Athlon / Athlon II / Sempron / Phenom / Phenom II إجراء العمليات الحاسوبية بسرعة 32 و 64 بت AMD 64 تقنية Cool'n'Quiet و Hyper Transport 3.0 تدعم تقنية (95: قصوى واط)	AM2+مقيس AMD Athlon / Athlon II / Sempron / Phenom / Phenom II إجراء العمليات الحاسوبية بسرعة 32 و 64 بت AMD 64 تقنية Cool'n'Quiet و Hyper Transport 3.0 تدعم تقنية (95: قصوى واط)	وحدة المعالجة المركزية
4.4 GT/s يتردد يصل إلى 3.0 HyperTransport تدعم تقنية	5.2 GT/s يتردد يصل إلى 3.0 HyperTransport تدعم تقنية	النقل الأممي الجانبي
AMD 785G AMD SB710	AMD 780G / 760G AMD SB710	مجموعة الشرائح
ITE 8718F الأكثر استخداماً. Super I/O يوفر وظيفة Low Pin Count Interface تدعم تقنية وسائل التحكم في البيئة: مراقب لمعرفة حالة الأجهزة من ITE "Smart Guardian" ووظيفة	ITE 8718F الأكثر استخداماً. Super I/O يوفر وظيفة Low Pin Count Interface تدعم تقنية وسائل التحكم في البيئة: مراقب لمعرفة حالة الأجهزة من ITE "Smart Guardian" ووظيفة	Super I/O
عدد 2 قحة DDR2 DIMM سعة ذاكرة قصوى 8 جيجا بايت ميجا 256/512 سعة DDR2 تدعم ذاكرة من نوع DIMM كل قحة بايت و 1/2 و 4 جيجا بايت مزوجة للقاعة DDR2 وحدة ذاكرة سعت 800 / 667 / 533 ميجا بايت DDR2 تدعم الذاكرة من نوع سعت 1066 ميجا بايت DDR2 تدعم الذاكرة من نوع (DDR2 1066 is for AM2+/AM3 CPU only) ECC وتلك التي لا تتوافق مع DIMM لا تدعم رقائق الذاكرة	عدد 2 قحة DDR2 DIMM سعة ذاكرة قصوى 8 جيجا بايت ميجا 256/512 سعة DDR2 تدعم ذاكرة من نوع DIMM كل قحة بايت و 1/2 و 4 جيجا بايت مزوجة للقاعة DDR2 وحدة ذاكرة سعت 800 / 667 / 533 ميجا بايت DDR2 تدعم الذاكرة من نوع سعت 1066 ميجا بايت DDR2 تدعم الذاكرة من نوع (DDR2 1066 is for AM2+/AM3 CPU only) ECC وتلك التي لا تتوافق مع DIMM لا تدعم رقائق الذاكرة	الذاكرة الرئيسية
AMD 785G مدمجة في رقائق ميجا بايت 512 أقصى سعة لذاكرة الفيديو المشتركة HDCP تدعم تقنية	AMD 780G / 760G مدمجة في رقائق ميجا بايت 512 أقصى سعة لذاكرة الفيديو المشتركة HDCP (780G only)/DX10 تدعم تقنية	بطاقة الرسومات
متكامل IDE متحكم وضع رئيسي 133 / 100 / 66 / 33 Ultra DMA نقل تقنية PIO Mode 0 ~4 دعم وضع	متكامل IDE متحكم وضع رئيسي 133 / 100 / 66 / 33 Ultra DMA نقل تقنية PIO Mode 0 ~4 دعم وضع	منفذ IDE
متكامل Serial ATA متحكم جيجابت/ثانية، 3 نقل البيانات بسرعة تصل إلى 2.0 الإصدار SATA مطابقة لمواصفات	متكامل Serial ATA متحكم جيجابت/ثانية، 3 نقل البيانات بسرعة تصل إلى 2.0 الإصدار SATA مطابقة لمواصفات	SATA
Realtek RTL 8111DL تفاوض تلقائي 100/10 ميجا بايت / ثانية و 1 جيجا بت/ثانية إمكانية النقل المزدوج الكامل/القصفي	Realtek RTL 8111DL تفاوض تلقائي 100/10 ميجا بايت / ثانية و 1 جيجا بت/ثانية إمكانية النقل المزدوج الكامل/القصفي	شبكة داخلية

A780GE/A760GE/A785GE

A785GE		A780GE/A760GE			
	ALC662 قوات لخرج الصوت 5.1 تدعم تقنية الصوت عالي التعريف من		ALC662 قوات لخرج الصوت 5.1 تدعم تقنية الصوت عالي التعريف من	دعم الصوت عالي التعريف	
عدد 1	قناة PCI Express Gen2 x 16	عدد 1	قناة PCI Express Gen2 x 16	التحات	
عدد 2	قناة PCI	عدد 2	قناة PCI		
عدد 1	منفذ محرك أقراص مرنة	عدد 1	منفذ محرك أقراص مرنة	المنفذ على سطح اللوحة	
عدد 1	منفذ IDE	عدد 1	منفذ IDE		
عدد 4	منفذ SATA	عدد 4	منفذ SATA		
عدد 1	منفذ اللوحة الأملمية	عدد 1	منفذ اللوحة الأملمية		
عدد 1	منفذ الصوت الأملمي	عدد 1	منفذ الصوت الأملمي		
عدد 1	منفذ خرج SPDIF	عدد 1	منفذ خرج SPDIF		
عدد 1	وصلة مروحة وحدة المعالجة المركزية	عدد 1	وصلة مروحة وحدة المعالجة المركزية		
عدد 1	وصلة مروحة النظام	عدد 1	وصلة مروحة النظام		
عدد 1	وصلة مسح CMOS	عدد 1	وصلة مسح CMOS		
عدد 2	منفذ USB	عدد 2	منفذ USB		
عدد 1	منفذ توصيل الطاقة (24بيوس)	عدد 1	منفذ توصيل الطاقة (24بيوس)		
عدد 1	منفذ توصيل الطاقة (4بيوس)	عدد 1	منفذ توصيل الطاقة (4بيوس)		
عدد 1	منفذ طبابعة	عدد 1	منفذ طبابعة		
عدد 1	منفذ تسلسلي	عدد 1	منفذ تسلسلي		
عدد 1	لوحة مفاتيح PS/2	عدد 1	لوحة مفاتيح PS/2		منفذ دخل/خرج اللوحة الخلفية
عدد 1	مؤس PS/2	عدد 1	مؤس PS/2		
عدد 1	منفذ VGA	عدد 1	منفذ VGA		
عدد 1	منفذ شبكة اتصال محلية	عدد 1	منفذ شبكة اتصال محلية		
عدد 4	منافذ USB	عدد 4	منافذ USB		
عدد 3	مقيس صوت	عدد 3	مقيس صوت		
عدد 1	منافذ DVI	عدد 1	منافذ DVI		
200 مم (عرض) X 244 مم (الرتفاع)		200 مم (عرض) X 244 مم (الرتفاع)		حجم اللوحة	
RAID 0 / 1 / 1+0 تدعم تقنية		RAID 0 / 1 / 1+0 تدعم تقنية		مزايا خاصة	
Windows XP / Vista 32 / 64 بحقها في اضافة أو ازالة الدعم لأي نظام تشغيل بإخطار أو Biostar تحتفظ ببون إخطار .		Windows XP / Vista 32 / 64 بحقها في اضافة أو ازالة الدعم لأي نظام تشغيل بإخطار أو Biostar تحتفظ ببون إخطار .		دعم أنظمة التشغيل	

JAPANESE

	A780GE/A760GE	A785GE
CPU	Socket AM2+ AMD Sempron / Athlon / Athlon II / Phenom / Phenom II プロセッサ AMD 64アーキテクチャでは、32ビットと64ビット計算が可能で ハイパートランスポート3.0とクールアンドクワイエットをサポートします (最高のワット: 95W)	Socket AM2+ AMD Sempron / Athlon / Athlon II / Phenom / Phenom II プロセッサ AMD 64アーキテクチャでは、32ビットと64ビット計算が可能で ハイパートランスポート3.0とクールアンドクワイエットをサポートします (最高のワット: 95W)
FSB	5.2 GT/sのバンド幅までハイパートランスポート3.0をサポートします	4.4 GT/sのバンド幅までハイパートランスポート3.0をサポートします
チップセット	AMD 780G / 760G AMD SB710	AMD 785G AMD SB710
メインメモリ	DDR2 DIMMスロット x 2 最大メモリ容量8GB 各DIMMは 256MB/512MB & 1GB/2GB/4GB DDR2をサポート デュアルチャンネルモードDDR2メモリモジュール DDR2 533 / 667 / 800 をサポート DDR2 1066 をサポート (for AM2+/AM3 CPU only) 登録済みDIMMとECC DIMMはサポートされません	DDR2 DIMMスロット x 2 最大メモリ容量8GB 各DIMMは 256MB/512MB & 1GB/2GB/4GB DDR2をサポート デュアルチャンネルモードDDR2メモリモジュール DDR2 533 / 667 / 800 をサポート DDR2 1066 をサポート (for AM2+/AM3 CPU only) 登録済みDIMMとECC DIMMはサポートされません
Super I/O	ITE 8718F もつとも一般に使用されるレガシーSuper I/O機能を採用しています。 低ピンカウントインターフェイス 環境コントロールイニシアチブ、 H/Wモニター ITEの「スマートガーディアン」機能	ITE 8718F もつとも一般に使用されるレガシーSuper I/O機能を採用しています。 低ピンカウントインターフェイス 環境コントロールイニシアチブ、 H/Wモニター ITEの「スマートガーディアン」機能
グラフィックス	AMD 780G / 760Gチップセットに統合 最大の共有ビデオメモリは512MBです DX10/HDCP (780G ONLY) のサポート	AMD 785Gチップセットに統合 最大の共有ビデオメモリは512MBです HDCP のサポート
IDE	統合IDEコントローラ Ultra DMA 33 / 66 / 100 / 133バスマスタモード PIO Mode 0~4のサポート、	統合IDEコントローラ Ultra DMA 33 / 66 / 100 / 133バスマスタモード PIO Mode 0~4のサポート、
SATA	統合シリアルATAコントローラ 最高3Gb/秒のデータ転送速度 SATAバージョン2.0仕様に準拠。	統合シリアルATAコントローラ 最高3Gb/秒のデータ転送速度 SATAバージョン2.0仕様に準拠。
LAN	Realtek RTL 8111DL 10 / 100 / 1000 Mb/秒のオートネゴシエーション 半/全二重機能	Realtek RTL 8111DL 10 / 100 / 1000 Mb/秒のオートネゴシエーション 半/全二重機能

A780GE/A760GE/A785GE

	A780GE/A760GE		A785GE	
HDオーディオのサポート	ALC662 5.1チャンネルオーディオアウト ハイデフィニションオーディオのサポート		ALC662 5.1チャンネルオーディオアウト ハイデフィニションオーディオのサポート	
スロット	PCI Express Gen2 x16スロット	x1	PCI Express Gen2 x16スロット	x1
	PCIスロット	x2	PCIスロット	x2
オンボードコネクタ	フロッピーコネクタ	x1	フロッピーコネクタ	x1
	IDEコネクタ	x1	IDEコネクタ	x1
	SATAコネクタ	x4	SATAコネクタ	x4
	フロントパネルコネクタ	x1	フロントパネルコネクタ	x1
	フロントオーディオコネクタ	x1	フロントオーディオコネクタ	x1
	S/PDIFアウトコネクタ	x1	S/PDIFアウトコネクタ	x1
	CPUファンヘッダ	x1	CPUファンヘッダ	x1
	システムファンヘッダ	x1	システムファンヘッダ	x1
	CMOSクリアヘッダ	x1	CMOSクリアヘッダ	x1
	USBコネクタ	x2	USBコネクタ	x2
	電源コネクタ(24ピン)	x1	電源コネクタ(24ピン)	x1
	電源コネクタ(4ピン)	x1	電源コネクタ(4ピン)	x1
	プリンタポートコネクタ	x1	プリンタポートコネクタ	x1
	シリアルポートコネクタ	x1	シリアルポートコネクタ	x1
背面パネル I/O	PS/2キーボード	x1	PS/2キーボード	x1
	PS/2マウス	x1	PS/2マウス	x1
	VGAポート	x1	VGAポート	x1
	LANポート	x1	LANポート	x1
	USBポート	x4	USBポート	x4
	オーディオジャック	x3	オーディオジャック	x3
	DVIポート	x1	DVIポート	x1
ボードサイズ	200 mm (幅) X 244 mm (高さ)		200 mm (幅) X 244 mm (高さ)	
特殊機能	RAID 0 / 1 / 1+0 のサポート		RAID 0 / 1 / 1+0 のサポート	
OSサポート	Windows XP / Vista 32 / 64 Biostarは事前のサポートなしにOSサポートを追加または削除する権利を留保します。		Windows XP / Vista 32 / 64 Biostarは事前のサポートなしにOSサポートを追加または削除する権利を留保します。	

2009/07/06