

9WMV/V+Series

User Manual V1.1

Copyright 1999 Publishing. All Rights Reserved.

This manual, software and firmware described in it are copyrighted by their respective owners and protected under the laws of the Universal Copyright Convention. You may not reproduce, transmit, transcribe, store in a retrieval system, or translate into any language, in any form or by any means, electronic, mechanical, magnetic, optical, chemical, biological, molecular, manual, or otherwise, any part of this publication without the express written permission of the publisher.

All products and trade names described within are mentioned for identification purpose only. No affiliation with or endorsement of the manufacturer is made or implied. Product names and brands appearing in this manual are registered trademarks of their respective companies.

The information published herein has been checked for accuracy as of publishing time. No representation or warranties regarding the fitness of this document for any use are made or implied by the publisher. We reserve the right to revise this document or make changes in the specifications of the product described therein at any time without notice and without obligation to notify any person of such revision or change.

9WMV Series including 3 models as follows

- 1. 9WMV (810)**
- 2. 9WDMV (810DC100)**
- 3. 9WEMV (810E)**

You can get anyone of the above from the regional distributor according to your needs.

Item Checklist

Before you begin installing your motherboard, please make sure that the following materials have been shipped:

This mainboard comes in a sturdy cardboard shipping carton, which should contain the following items:

- This Mainboard
- This User's Manual
- CD Title Driver
- Cable Set

If you discover damaged or missing items, please contact your retailer.

CONTENTS

1 Introduction	1-1
1.1 Introduction	1-1
1.2 Specifications.....	1-1
1.3 Block Diagram	1-4
1.4 Main Board Layout with Default Setting.....	1-5
1.5 Static Electricity Precautions	1-6
2 Installation Procedures	2-1
2.1 Setting System Jumpers.....	2-1
2.2 System Memory (DIMM)	2-4
2.3 Central Processing Unit (CPU).....	2-5
2.4 Expansion Cards.....	2-6
2.5 External Connectors.....	2-7
2.6 Power Connection Procedures.....	2-16
3 AWARD BIOS Setup	3-1
3.1 introduction	3-1
3.2 Main Menu	3-4
3.3 Standard CMOS Setup	3-6
3.4 Advanced BIOS Features	3-10
3.5 Advanced Chipset Features/Integrated Peripherals	3-13
3.6 Integrated Peripherals	3-16
3.7 Power Management Setup	3-21
3.8 PnP/PCI Configuration Setup	3-25
3.9 PC Health Status	3-27
3.10 Frequency/Voltage Control	3-28
3.11 Defaults Menu	3-29
3.12 Supervisor/User Password Setting	3-30
3.13 Exit Selecting	3-31
4 Software Driver Installation.....	4-1
4.1 UPDATED PRODUCT INFORMATION	4-1
4.2 Installing Graphics Driver	4-4
4.3 Installing Audio Driver	4-7
4.4 Anti-Virus software installation.....	4-10

Chapter 1





Introduction







1-1 Introduction

The motherboard is a high-performance, low-cost motherboard which supports the Intel PII;PIII and Socket 370 microprocessor. System memory bank supports 3 DIMM socket. Memory up to 512MB PC-100 SDRAM.

On-board features include 2X AGP, stereo sound, ATX power, super I/O, 2 Ultra DMA/66 EIDE interfaces, 2 USB ports, 3 PCI expansion slots, and 1 AMR slot.

1-2 Specifications

-  CPU
 - Pentium® II/III® & Celeron™ Processor.
 - Celeron™ Socket 370 PPGA packaged Processor.
 - 2nd level Cache Depend on CPU.
 - Coppermine Socket 370 FCPGA packaged Processor.
-  Chipset
 - Intel® GMCH82810/810DC100/810E, consisting of:
 - 82810DC100/82810E Graphics and memory controller Hub(GMCH).
 - 82801AA(ICH) I/O Controller Hub.
-  Clock Generator
 - Supports 66 / 100 / 133MHz.
-  Memory
 - 3 x 168-pin DIMM Sockets.
 - Supports PC-100 SDRAM 16MB~512MB.
 - Supports only 3.3V SDRAM DIMM.
-  VGA
 - Integrated 2D/3D graphics chip(GMCH).
 - Integrated 24-bit 230MHz RAMDAC.
 - 4MB display cache.(9WMV/V+ Without)
 - Integrated H/W Motion compensation engine.

-  Audio
 - Supports AC97 CODEC (AD1881/ALC100).
 - Supports earphones, two channel speaker mode.
 - MPU-401 game/MIDI port and Sound blaster®16 compatible.
-  I/O Control
 - ITE IT8712F.
-  Expansion Slot
 - Three 32-bit PCI slots support Master mode.
 - One Audio Modem Riser (AMR) slot.
-  I/O Interface
 - PCI Bus master IDE interface on board with two connectors support 4 IDE devices in 2 channel, the PCI IDE Controller supports PIO Mode 0 to Mode 4, Bus master IDE DMA Mode 2 and Ultra DMA 33/66.
 - On board super Multi-I/O chip that support 2 serial port with 16550 Fast UART compatible, 1 parallel port with EPP and ECP capabilities, and a floppy disk drive interface.
 - On board support PS/2 mouse Connector.
 - On board support PS/2 Keyboard Connector.
 - On board 2 USB ports.
 - On board IrDA connector.
 - Floppy port supports 2 FDD with 360K, 720K, 1.2M, 1.44M and 2.88M bytes, Supports LS-120 floppy disk device.
-  Other Function
 - Support modem Ring Power on.
 - Supports Keyboard, PS/2 Mouse power on, and WOL (Wake On LAN).
-  Power Supply
 - On board 3V, 5V and 12V 20-pin ATX power connector.
 - Use switching regulator to support CPU core voltage.
-  Hardware Monitor
 - CPU/Power Supply/Chassis Fan Revolution detecting.
 - CPU Fan Control.
 - System Voltage Detect.
 - Display Actual Current Voltage.



BIOS

- Licensed AWARD BIOS, 4M bit FLASH RAM.
- ACPI ready for PC98/Windows 98.
- System BIOS supports ACPI function and Green feature function, DMI, Plug and Play Flash ROM.



Form factor

- Micro ATX Form Factor.
- Dimension 190mm x 245mm, 4-layer PCB.



TV OUT (9WEMV+/9WDMV+/9WMV+ Serial only)

- On board CHRONTEL CH7007 digital PC to TV encoder.
- Supports NTSC, and PAL TV formats.
- Provides Composite, S-Video outputs.
- Auto-detection of TV presence.



DRIVERS

- Intel® 810 Chipset Graphics Drivers.
- Intel® INF Installation Utility.
- AC97 audio sound drivers.
- DirectX 6.1.

1-3 Block Diagram

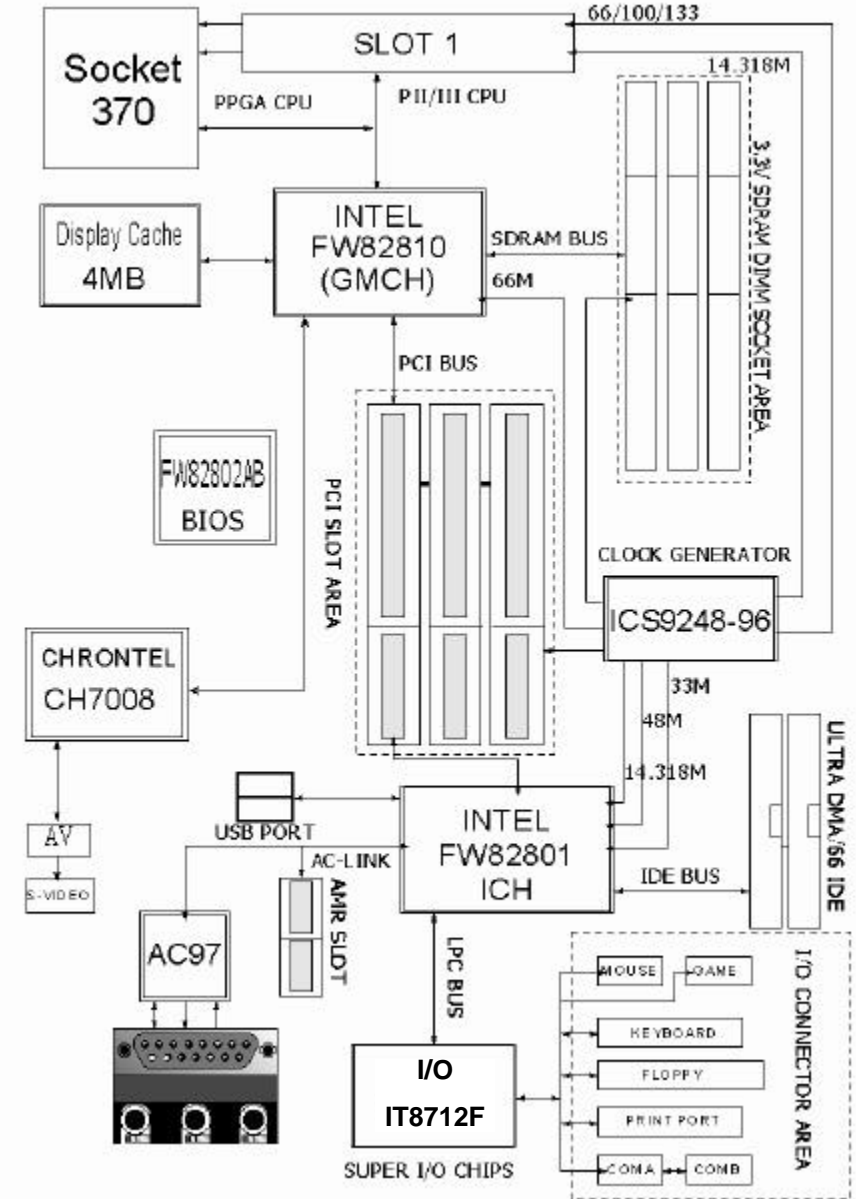



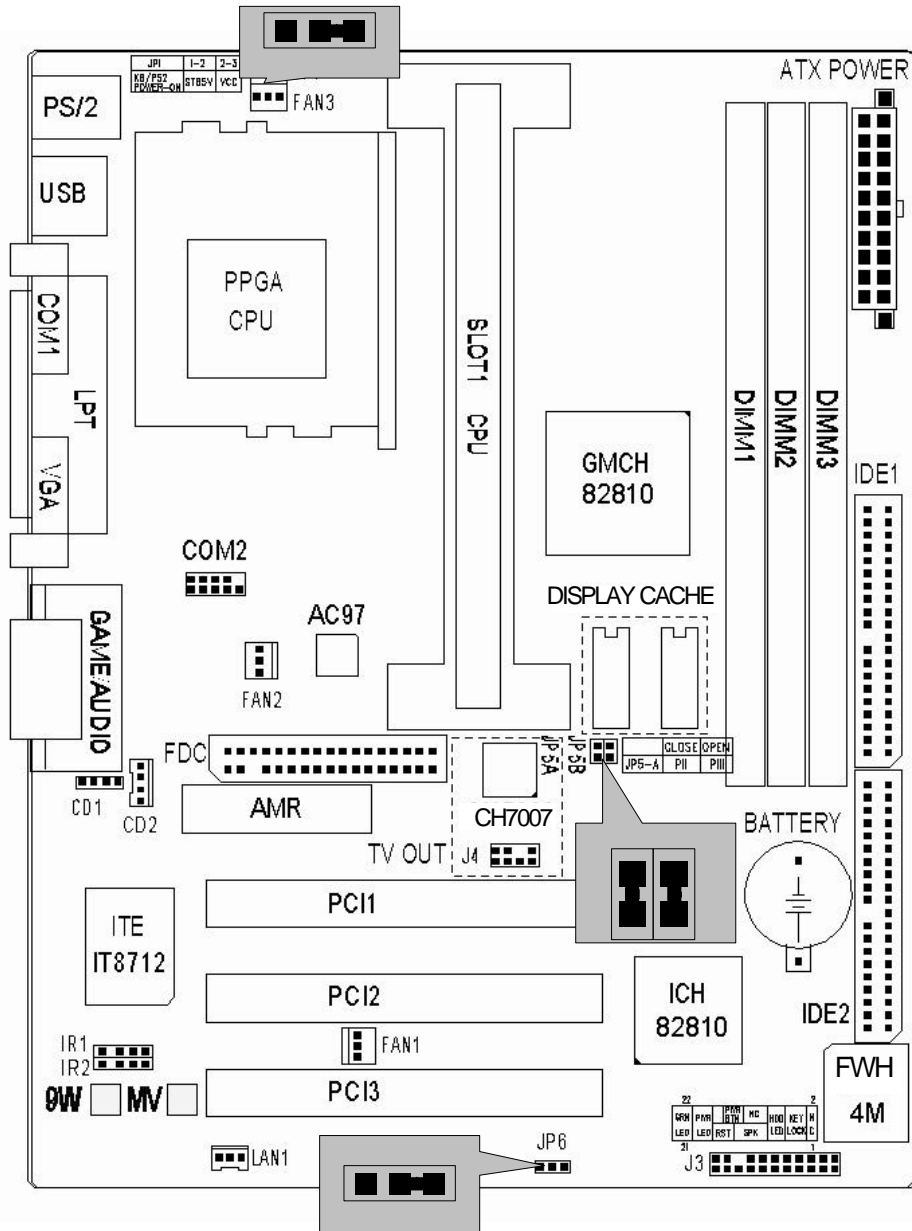

1-4 Main Board Layout with Default Setting



1-5

1-5 Static Electricity Precautions

Static electricity can easily damage your motherboard. Observing a few basic precautions can help you safeguard against damage that could result in expensive repairs. Follow the measures below to protect your equipment from static discharge:

-  Keep the motherboard and other system components in their antistatic packaging until you are ready to install them.
-  Touch a grounded surface before you remove any system component from its protective antistatic packaging. A grounded surface within easy reach is the expansion slot covers at the rear of the system case, or any other unpainted portion of the system chassis.
-  During configuration and installation, touch a ground surface frequently to discharge any static electric charge that may build up in your body. Another option is to wear a grounding wrist strap.
-  When handling a motherboard or an adapter card, avoid touching its components. Handle the motherboard and adapter cards either by the edges or by the mounting bracket that attaches to the slot opening in the case.

1-6

Chapter 2

Installation Procedures

The mainboard has some user-adjustable jumpers on the board that allow you to configure your system to suit your requirements. This chapter contains information on the various jumper settings on your mainboard.

To set up your computer, you must complete the following steps:

1. Setting system jumpers.
2. Install RAM modules.
3. Install CPU & FAN.
4. Connect ribbon cables, cabinet wires, and power supply.
5. Set up BIOS.
6. Set up system drivers and utility.

2-1 Setting System Jumpers

You may configure your motherboard to match the needs of your applications by setting jumpers. A jumper is the simplest kind of electrical switch. It consists of two metal pins and a small metal clip (often protected by a plastic cover) that slides over the pins to connect them. To "close" a jumper, you connect the pins with the clip. To "open" a jumper, you remove the clip. Sometimes a jumper will have three pins, labeled 1, 2, 3. In this case you would connect either pin 1 and 2 or 2 and 3.

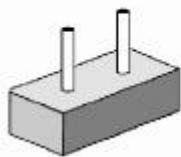

OPEN

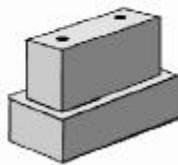

CLOSED

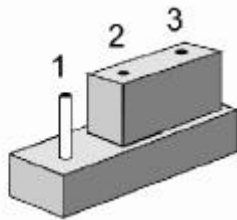

CLOSED 2-3

2-1

The jumper settings are schematically depicted in this manual as follows:



A pair of needle-nose pliers may be helpful when working with jumpers.

Note: When you open the jumper, attach the plastic jumper cap to one of the pins so you won't lose it.

Warning: Always completely disconnect the power cord from your board whenever you are working on it. Do not make connections while the power is on because sensitive electronic components can be damaged by the sudden rush of power.

Always ground yourself to remove any static charge before touching the board. Modem electronic devices are very sensitive to static electric charges. Use a grounding wrist strap at all times. Place all electronic components on a static-dissipative surface or in a static-shielded bag when they are not in the chassis.

CPU External Frequency Settings:(JP5A,JP5B)

The Motherboard supports Intel Socket 370 CPUs with 66MHz or 100MHz or 133MHz(9WEMV/V+ series only) external frequency. Setting the jumper according to the external frequency of the CPU you are going to install on the motherboard.



	states	JP5A	JP5B
1	BIOS auto-detect CPU Frequency(66/100MHZ)		
2	BIOS auto-detect CPU Frequency(100/133MHZ)		

*9WMV/V+ & 9WDMV/V+ [JP5A] always close [default].
 *JP5B for Pentium® III only.

2-2



Clear CMOS:(JP6)

To clear the data stored in the CMOS, always turn off the computer first, then remove this jumper to 2-3 pin to clear the CMOS. The jumper should be set to 1-2 pin (3V battery back up) before turn on the computer.

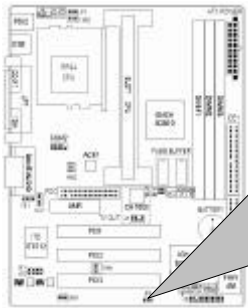

states		JP6
1	Clear CMOS	
2	Normal [Default]	

* Clear CMOS must be turn off the AC power first.



Keyboard Power On Selection

The keyboard power on selection function. If your ATX power supply can supports 700mA 5V standby current (with keyboard require).you can use this function.

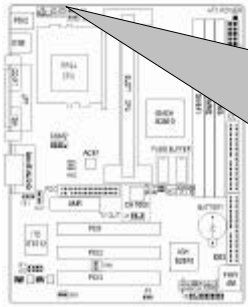

states		JP1
1	Enable this function	
2	Disable [Default]	

*If your ATX power supply not support 100~300mA 5V standby current. Don' t enable this function.

2-2 System Memory (DIMM)

The motherboard supports up to 512MB PC-100 SDRAM. No hardware or BIOS setup is required after adding or removing the system memory. The Intel 810 chipset does not support ECC, However, ECC memory modules may still be used, but the ECC function will not be available.

Note:

- 1.The motherboard uses only Dual Inline Memory Modules (DIMMs). Sockets are available for 3.3Volt (power level) Synchronous Dynamic Random Access Memory (SDRAM).
- 2.This motherboard does not support 66MHz SDRAM !. The PC-100 compliant SDRAM must be used because of the strict timing issues involved under this speed.



Installing system Memory

Insert the DIMM module(s) as shown. Because the number of pins are different on each side of the breaks, the module will be fitted only in the orientation shown. The DIMM must be 3.3V for this motherboard.

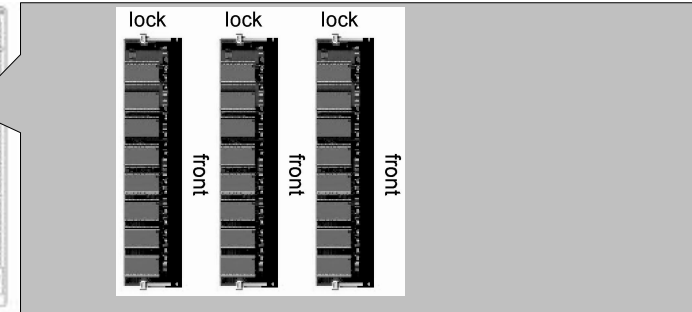
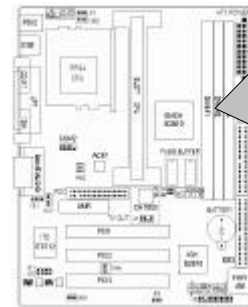

System memory blank table

Item	Support	Support
DIMM 1	Single side	Double side
DIMM 2	Single side	Double side
DIMM 3	Single side	

* DIMM 3 support Single side SDRAM module only.
Ex.

ITEM	DIMM 1	DIMM 2	DIMM 3	TOTAL SIZE
1	32MB-Single	32MB-Single	32MB-Single	96MB
2	32MB-Double	32MB-Single	32MB-Single	96MB
3	32MB-Double	32MB-Double	Don't use	96MB
4	64MB-Single	64MB-Single	64MB-Single	192MB
5	64MB-Double	64MB-Single	64MB-Single	192MB
6	64MB-Double	64MB-Double	Don't use	128MB
7	128MB-Single	128MB-Single	128MB-Single	384MB
8	128MB-Double	128MB-Single	128MB-Single	384MB
9	128MB-Double	128MB-Double	Don't use	256MB
10	256MB-Single	256MB-Single	Don't use	512MB
11	256MB-Double	256MB-Single	Don't use	512MB
12	256MB-Double	256MB-Double	Don't use	512MB

2-3 Central Processing Unit (CPU)

The Motherboard provides a ZIF Socket 370 and a SLOT 1. The CPU that came with the motherboard should have a fan attached to it to prevent overheating. If this is not the case, then purchase a fan before you turn on your system. Be sure that there is sufficient air circulation across the processor heat sink, or the processor could overheat and damage both the processor and the motherboard.

To install a CPU, first turn off your system and remove its cover. Locate the ZIF socket and open it by first pulling the lever sideways away from the socket then upwards to a 90-degree angle. Insert the CPU with the correct orientation as shown. The notched corner should point towards the end of the lever. Because the CPU has a corner pin for two of the four corners, the CPU will only be fitted in the orientation as shown. The picture is for reference only: you should have a CPU fan that covers the top side of the CPU. With the added weight of the CPU fan, no force is required to insert the CPU. Once completely inserted, close the socket lever while holding down the CPU.

2-4 Expansion Cards

Always unplug the power supply when adding or removing expansion cards or other system components. Failure to do so may cause severe damage to both your motherboard and expansion cards.

Expansion Card Installation Procedure The Motherboard has 3 PCI and 1 AMR expansion slots. You may install up to 3 PCI cards and 1 AMR card on this motherboard. To install the PCI cards or AMR card, please follow the following procedure:

1. Read the documentation for your expansion card and make any necessary hardware or software settings for your expansion card, such as jumpers or switches.
2. Remove your computer system cover and the bracket plate with screw on the slot you intend to use. Keep the bracket for possible future use.
3. Carefully align the card connectors and press firmly.
4. Secure the card on the slot with the screw you removed above.
5. Replace the computer system cover.
6. Setup the BIOS if necessary.
7. Install the necessary software drivers for your expansion card.

Note: To install the AMR Card. You should set the "AC97 Modem" as "auto" in the "INTEGRATED PERIPHERALS" of the BIOS Setup.

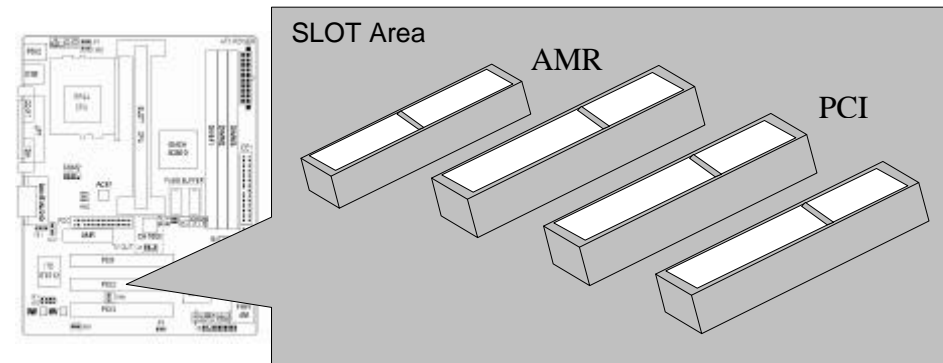

2-5 External Connectors

1. PS/2 Mouse Connector:

The motherboard provides a mini-DIN mouse connector, which supports a PS/2 style mouse.

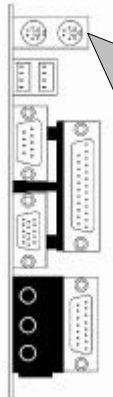

PS/2 Mouse Connector
PC99 Color : Green

PIN	FUNCTION
1	DATA
2,6	N.C
3	GND
4	+5V
5	CLOCK

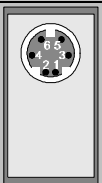

2. PS/2 Keyboard Connector:

This connector is for a standard keyboard using a PS/2 plug (mini DIN). This connector will not allow standard AT (large DIN) keyboard plugs. You may use a DIN to mini DIN adapter on standard AT keyboards. In some applications, the keyboard is not present, the standard BIOS will report an error or failure during the Power-On Self Test (POST) after resetting the PC. You may select "All, But Keyboard" under the "Halt On" in "Standard CMOS SETUP" of BIOS SETUP. This allows the system non-keyboard operation without the system halting during the POST.

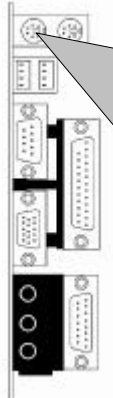

PS/2 Keyboard Connector
PC99 Color : Purple

PIN	FUNCTION
1	DATA
2,6	N.C
3	GND
4	+5V
5	CLOCK

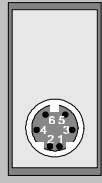

3. Universal Serial BUS (USB) Ports 1 & 2:

There are two USB ports on this motherboard for connecting USB devices.

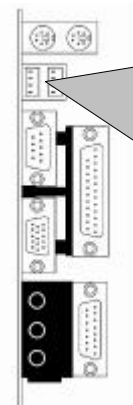

Universal Serial BUS (USB) Ports 1 & 2
PC99 Color : Black

PIN	FUNCTION
1,5	+5V
2,6	USB+
3,7	USB-
4,8	GND

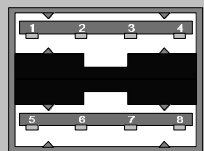

4. Parallel Port Connector:

Normally, the parallel port is used to connect the system to a printer.

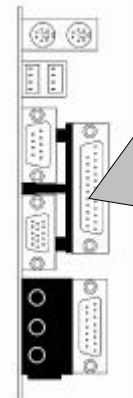

Parallel Port Connector
PC99 Color : Burgundy

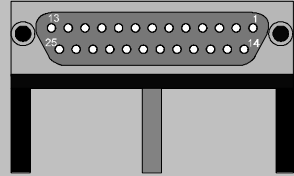

5. Serial Port COM1 connector:

The COM1 port is ready for a mouse or other serial devices. A second serial port is available using a serial port bracket connected from the motherboard to an expansion slot opening.

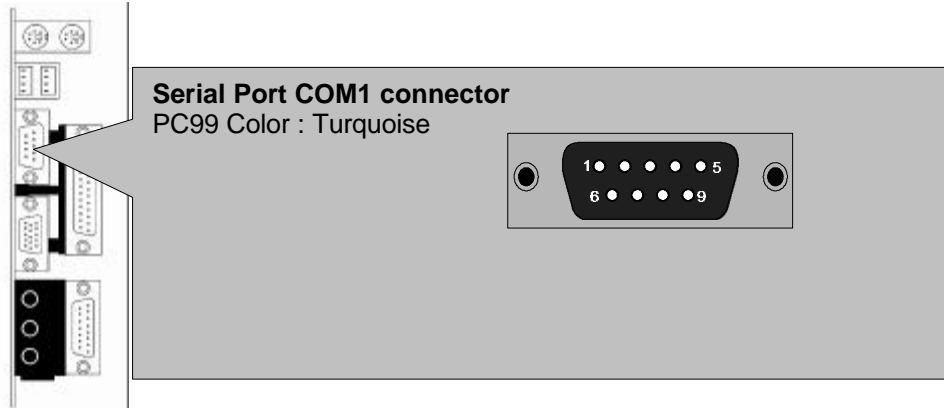

6. Display connector:

This connector is for output to a VGA-compatible device, commonly used for conventional CRT displays.

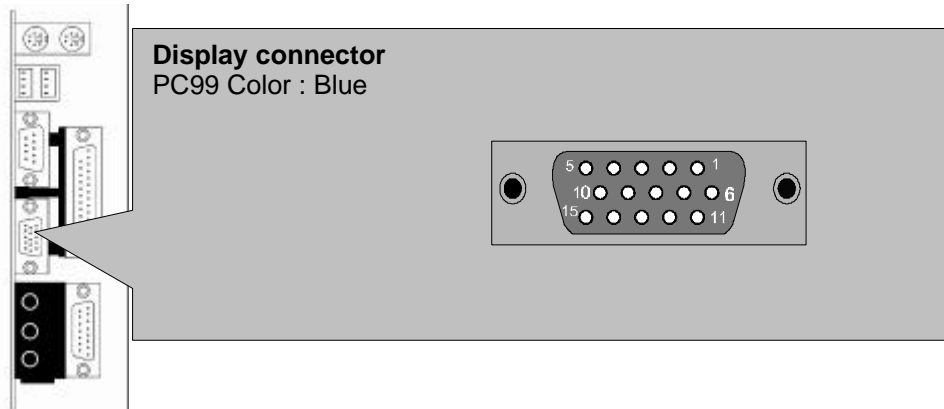

7. Joystick/MIDI connector:

You may connect game joysticks or game pads to this connector for playing games. Connect MIDI devices for playing or editing audio.

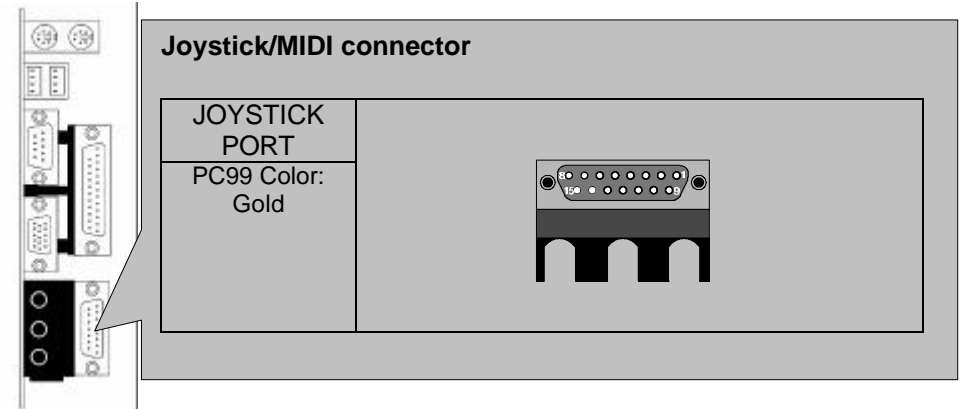

8. Audio Port connectors:

The Audio Port Connectors on the motherboard are standard 1/8" GAME-AUDIO connectors. Line Out (lime) can be connected to headphones or POWERED speakers. Line In (light blue) allows tape players or other audio sources to be recorded by your computer or played through the Line Out (lime). Mic (pink) allows microphones to be connected for inputting voice.

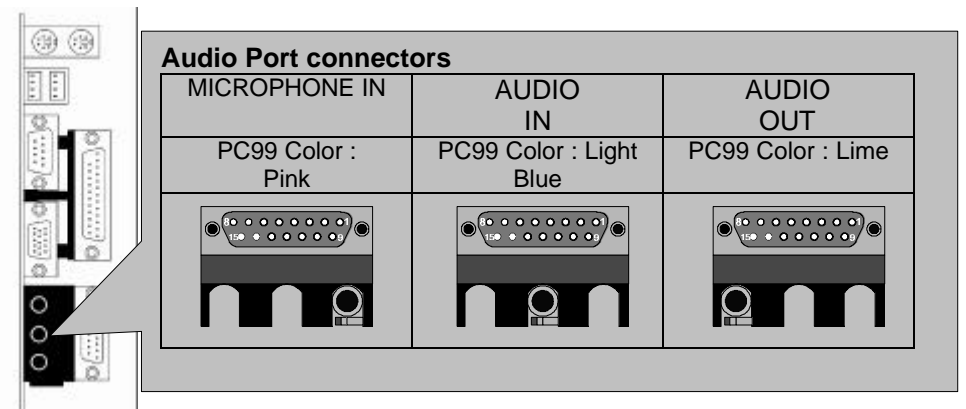

9.Primary/Secondary IDE Connectors

The motherboard supports up to four IDE devices, including CD-ROM drives, tape backup drives, Hard Disk Drives, and other IDE devices. After connecting the single end to the board, connect the two plugs at the other end to your hard disk(s). If you install two hard disks, you must configure the second drive to Slave mode by setting its jumper accordingly. Please refer to your hard disk documentation for the jumper settings. (Pin 20 is removed to prevent the users inserting the IDE devices in the wrong orientation when using ribbon cables with pin 20 plugged).

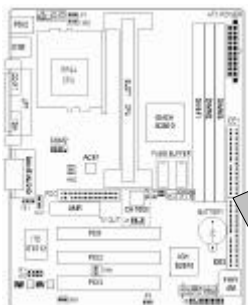

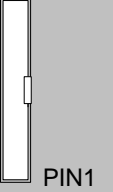
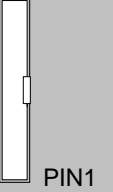

Primary/Secondary IDE Connectors	
Primary IDE Connectors Color : Blue	Secondary IDE Connectors Color : White
 PIN1	 PIN1
NOTE: Orient the red markings on the floppy ribbon cable to pin 1	

Note: Ultra DMA/66 IDE devices must use an 80-wire IDE cable or else devices will automatically be limited to Ultra DMA/33 mode.

10.Floppy Disk Drive Connector:

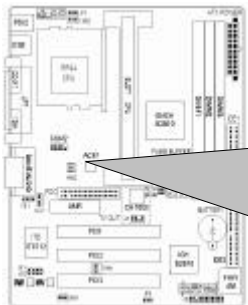
You can attach up to two floppy drives to the motherboard. After connecting the single end to the board, connect the two plugs on the other end to the floppy drives. The drive A: should be connected on the end and the drive B: in the middle.



Floppy Disk Drive Connector	
Floppy Disk Drive Connector Color : White	
 PIN1	
NOTE: Orient the red markings on the floppy ribbon cable to pin 1	

Note: Pin 5 is removed to prevent the users inserting the Floppy Disk Drive in the wrong orientation when using ribbon cables with pin 5 plugged.

11.Wake-On-LAN(WOL)/Wake-On-Modem(WOM) connectors

The Wake-On-LAN and Wake-On-Modem connectors connect to a LAN card and Modem card respectively with a Wake-On-LAN/Wake-On-Modem output. The connectors power up the system when a wakeup packet or signal is received through the LAN card/Modem card.

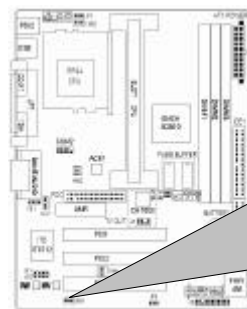

Wake-On-LAN(WOL) connectors	
PIN	FUNCTION
1	+5V_SB
2	GND
3	SIGNAL

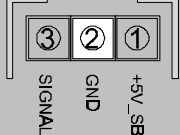

SIGNAL GND +5V_SB

NOTE : The ATX power supply supports larger than 720mA 5V Standby current.

12.Serial Port COM2 Pin Header:

The provided serial port bracket can be used to add an additional serial port for additional serial devices.

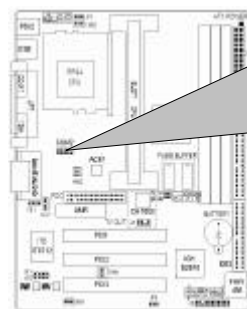

Serial Port COM2 Pin Header B TYPE			
PIN	FUNCTION	PIN	FUNCTION
1	DCD	6	DSR
2	RXD	7	RTS
3	TXD	8	CTS
4	DTR	9	RI
5	GND	10	N.C

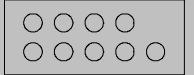

Note: Pin 10 is removed to prevent the users inserting in the wrong orientation when using ribbon cables with pin 10 plugged.

13.CPU/Chassis Fan Connectors:

This motherboard provides CPU, Power, and Chassis fan connectors. Orientate the fan so that the heat sink fins allow airflow to go across the onboard heat sink(s) instead of the expansion slots. Depending on the fan manufacturer, the wiring and plug may be different. The red wire should be positive, while the black should be ground. Connect the fan plug to the board taking into consideration the polarity of the connector.

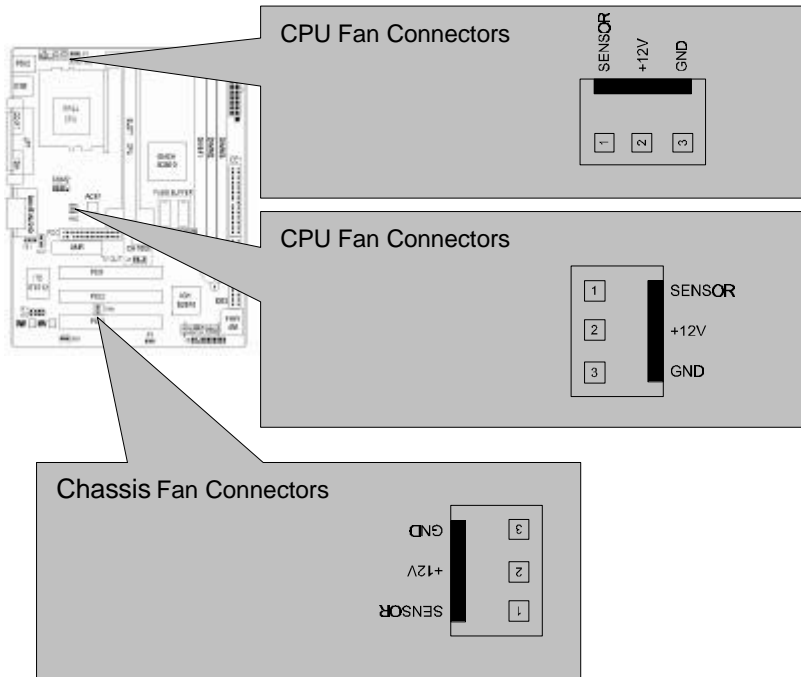

Note: The CPU and motherboard will overheat if there is no airflow across the CPU and onboard heatsink. Damage may occur to the motherboard and the CPU fan if these pins are incorrectly used. These are not jumpers, do not place jumper caps over these pins.

System Panel Connectors

Refer to the following figure for item 14 to 18.

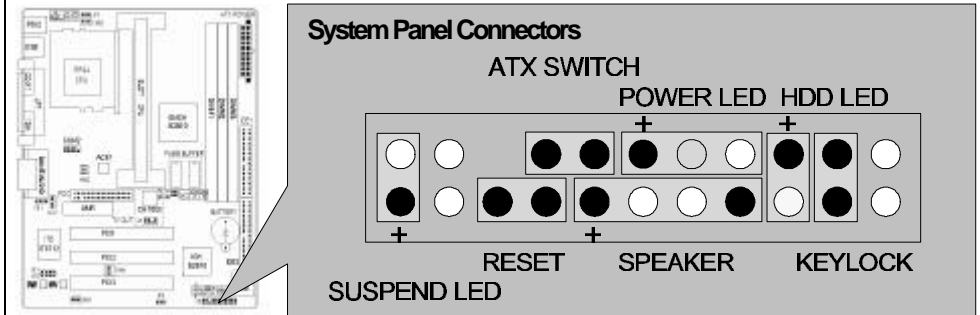

14.Power LED Lead

This indicates the status of the system power is turned "ON" or "OFF" The LED will light when the system power is turned on and will go off when the system power is turned off.

15.System Warning Speaker Connector

This 4-pin connector connects to the case-mounted speaker.

16.ATX Power Switch Lead

The system power is controlled by a momentary switch connected to this lead. Pressing the button once will switch the system between ON and SOFT OFF. Pushing the switch while in the ON mode for more than 4 seconds will turn the system off. The Power LED shows the status of the system power.

17.HDD LED Lead

This connector supplies power to the cabinet IDE activity LED. Read and write activity by devices connected to the Primary or Secondary IDE connectors will cause the LED to Light up.

18.Reset Switch Lead

This 2-pin connector connects to the case-mounted reset switch for rebooting your computer without having to turn off your power switch. This is a preferred method of rebooting to extend the life of the system power supply.

19. Internal Audio Connectors:

These connectors allow you to receive stereo audio input from the sound sources such as CD-ROM, TV tuner, and MPEG card.

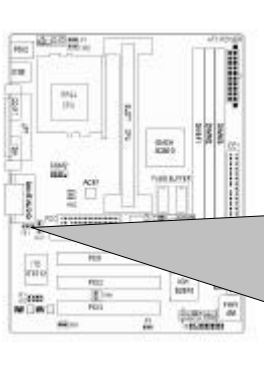

Internal Audio Connectors

CD1		CD2	
PIN	FUNCTION	PIN	FUNCTION
1	RIGHT	1	RIGHT
2,4	GND	2,3	GND
3	LEFT	4	LEFT

RIGHT GND GND LEFT



RIGHT GND LEFT GND

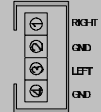

20. ATX Power Connector:

This connector connects to an ATX power supply. The plug from the power supply will only insert in one orientation because of the different hole sizes. Find the proper orientation and push down firmly making sure that the pins are aligned.

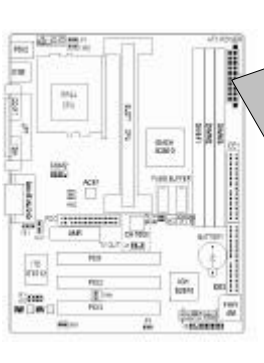

ATX Power Connector

+12.0V	10	+5.0V	20
STB%V		+5.0V	
PWRGD		-5.0V	
GND		GND	
+5.0V		GND	
GND		GND	
+5.0V		PS-ON	
GND		GND	
+3.3V		-12.0V	
+3.3V	1	+3.3V	11

21. NTSC/PAL TV-Output Pin Header: (Option: 9WMV+ Serial only)

This connector connects to an TV-OUT cable. This function Supports NTSC, and PAL TV formats. Provides Composite, S-Video outputs. Auto-detection of TV presence.

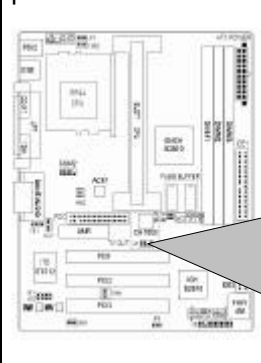

NTSC/PAL TV-Output Pin Header

PIN	FUNCTION	PIN	FUNCTION
1	GND	2	GND
3	COUT	4	YOUT
5	GND	6	N.C
7	TVGND	8	COMPOUT

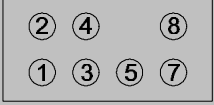

21. IR&CIR Pin Header:

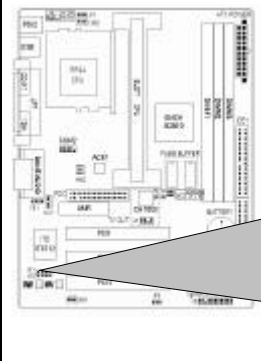





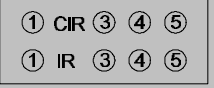



IR&CIR Pin Header

PIN	IR	PIN	CIR
1	+5 VCC	1	+5 VCC
3	IRRX	3	CIRRX
4	GND	4	GND
5	IRTX	5	CIRRTX



2-6 Power Connection Procedures

-  After all connections are made, close the system case cover.
-  Be sure that all switches are OFF.
-  Connect the power supply cord to the power supply located on the back of your system case according to your system user manual.

-  Connect the power cord to a power outlet that is equipped with a surge protector.
-  You may then turn ON your devices in the following order:
 - (1) Your monitor
 - (2) External SCSI devices (starting with the last device on the chain)
 - (3) Your system power For ATX power supplies, you need to switch ON the power supply if a switch is provided as well as press the ATX power switch on the front of the case.
-  The power LED on the front panel of the system case will light. For ATX power supplies, the power LED will light when the ATX power switch is pressed. The system will then run power-On tests. While the tests are running, additional messages will appear on the screen. If you do not see anything within 30 seconds from the time you turn on the power, the system may have failed a power-on test. Check your jumper settings and connections again or call your retailer for assistance.
-  During power-ON, hold down <Delete> to enter BIOS setup. Follow the instructions in chapter 3 BIOS Setup
-  To power off you computer, you must first exit or shut down your operating system before switching OFF the power switch. For ATX power supplies, you can press the ATX power switch after exiting or shutting down your operating system. If you use Windows 95/98, click the start button, click shut down, and then click Shut down the computer. The power supply should turn OFF after Windows shuts down. For ATX power supplies, the message " You can now safely turn OFF your computer" will not appear when shutting down the computer.



AWARD BIOS Setup

3-1 Introduction

This manual discusses Award™ Setup program built into the ROM BIOS. The Setup program allows users to modify the basic system configuration. This special information is then stored in battery-backed RAM so that it retains the Setup information when the power is turned off.

The AwardBIOS™ installed in your computer system's ROM (Read Only Memory) is a custom version of an industry standard BIOS. This means that it supports Intel/Cyrix/AMD processors in a standard IBM-AT compatible input/output system. The BIOS provides critical low-level support for standard devices such as disk drives and serial and parallel ports.

The AwardBIOS™ has been customized by adding important, but non-standard, features such as virus and password protection as well as special support for detailed fine-tuning of the chipset controlling the entire system.

The rest of this manual is intended to guide you through the process of configuring your system using Setup.

Starting Setup

The AwardBIOS™ is immediately activated when you first power on the computer. The BIOS reads the system information contained in the CMOS and begins the process of checking out the system and configuring it. When it finishes, the BIOS will seek an operating system on one of the disks and then launch and turn control over to the operating system.

While the BIOS is in control, the Setup program can be activated in one of two ways:

1. By pressing immediately after switching the system on, or
2. By pressing the key when the following message appears briefly at the bottom of the screen during the POST (Power On Self-Test).
Press DEL to enter SETUP.

If the message disappears before you respond and you still wish to enter Setup, restart the system to try again by turning it OFF then ON or pressing the "RESET" button on the system case. You may also restart by simultaneously pressing <Ctrl>, <Alt>, and <Delete> keys. If you do not press the keys at the correct time and the system does not boot, an error message will be displayed and you will again be asked to...

PRESS F1 TO CONTINUE, DEL TO ENTER SETUP

Using Setup

In general, you use the arrow keys to highlight items, press <Enter> to select, use the **PageUp** and **PageDown** keys to change entries, press <F1> for help and press <Esc> to quit. The following table provides more detail about how to navigate in the Setup program using the keyboard.

Key	Function
Up Arrow	Move to the previous item
Down Arrow	Move to the next item
Left Arrow	Move to the item on the left (menu bar)
Right Arrow	Move to the item on the right (menu bar)
Esc	Main Menu: Quit without saving changes Submenus: Exit Current page to the next higher level menu
Move Enter	Move to the item you desired
PgUp key	Increase the numeric value or make changes
PgDn key	Decrease the numeric value or make changes
+ key	Increase the numeric value or make changes
- key	Decrease the numeric value or make changes
Esc key	Main Menu -- Quit and not save changes into CMOS Status Page Setup Menu and Option Page Setup Menu -- Exit current page and return to Main Menu
F1 key	General help on Setup navigation keys
F5 key	Load previous values from CMOS
F6 key	Load the fail-safe defaults from BIOS default table
F7 key	Load the optimized defaults
F10 key	Save all the CMOS changes and exit

Navigating through the menu bar

Use the left and right arrow keys to choose the menu you want to be in.

To display a sub menu, use the arrow keys to move the cursor to the sub menu you want. Then press <Enter>. A "➤" pointer marks all sub menus.

Getting Help

Press F1 to pop up a small help window that describes the appropriate keys to

use and the possible selections for the highlighted item. To exit the Help Window press <Esc> or the F1 key again.

In Case of Problems

If, after making and saving system changes with Setup, you discover that your computer no longer is able to boot, the AwardBIOS™ supports an override to the CMOS settings which resets your system to its defaults.

The best advice is to only alter settings which you thoroughly understand. To this end, we strongly recommend that you avoid making any changes to the chipset defaults. These defaults have been carefully chosen by both Award and your systems manufacturer to provide the absolute maximum performance and reliability. Even a seemingly small change to the chipset setup has the potential for causing you to use the override.

A Final Note About Setup

Not all systems have the same Setup. While the basic look and function of the Setup program remains the same for all systems, individual motherboard and chipset combinations require custom configurations. For example, you may find that your Setup main menu has a different number of entries from the main menu displayed in this manual. These are simply features not supported (or not user configurable) on your system.

The final appearance of the Setup program also depends on the Original Equipment Manufacturer (OEM) who built your system. If your OEM has decided that certain items should only be available to their technicians, those items may very well be removed from the Setup program.

3-2 Main Menu

Once you enter the AwardBIOS™ CMOS Setup Utility, the Main Menu will appear on the screen. The Main Menu allows you to select from several setup functions and two exit choices. Use the arrow keys to select among the items and press <Enter> to accept and enter the sub-menu.



Note that a brief description of each highlighted selection appears at the bottom of the screen.

Setup Items

The main menu includes the following main setup categories. Recall that some systems may not include all entries.

Standard CMOS Features

Use this menu for basic system configuration.

Advanced BIOS Features

Use this menu to set the Advanced Features available on your system.

Advanced Chipset Features

Use this menu to change the values in the chipset registers and optimize your system's performance.

Integrated Peripherals

Use this menu to specify your settings for integrated peripherals.

Power Management Setup

Use this menu to specify your settings for power management.

PnP / PCI Configuration

This entry appears if your system supports PnP / PCI.

Frequency/Control

Use this menu to specify your settings for frequency/control.

Load Fail-Safe Defaults

Use this menu to load the BIOS default values for the minimal/stable performance for your system to operate.

Load Optimized Defaults

Use this menu to load the BIOS default values that are factory settings for optimal performance system operations. While Award has designed the custom BIOS to maximize performance, the factory has the right to change these defaults to meet their needs.

Set Password

Use this menu to set Passwords.

Save & Exit Setup

Save CMOS value changes to CMOS and exit setup.

Exit Without Save

Abandon all CMOS value changes and exit setup.

3-3 Standard CMOS Setup

The items in Standard CMOS Setup Menu are divided into 10 categories. Each category includes no, one or more than one setup items. Use the arrow keys to highlight the item and then use the <PgUp> or <PgDn> keys to select the value you want in each item.

**Main Menu Selections**

This table shows the selections that you can make on the Main Menu

Item	Options	Description
Date	Month DD YYYY	Set the system date. Note that the 'Day' automatically changes when you set the date
Time	HH : MM : SS	Set the system time
IDE Primary Master	Options are in its sub menu (described in Table 3)	Press <Enter> to enter the sub menu of detailed options
IDE Primary Slave	Options are in its sub	Press <Enter> to enter the

	menu (described in Table 3)	sub menu of detailed options
IDE Secondary	Options are in its sub menu (described in Table 3)	Press <Enter> to enter the sub menu of detailed options
IDE Secondary	Options are in its sub menu (described in Table 3)	Press <Enter> to enter the sub menu of detailed options
Drive A Drive B	None 360K, 5.25 in 1.2M, 5.25 in 720K, 3.5 in 1.44M, 3.5 in 2.88M, 3.5 in	Select the type of floppy disk drive installed in your system
Video	EGA/VGA CGA 40 CGA 80 MONO	Select the default video device
Halt On	All Errors No Errors All, but Keyboard All, but Diskette All, but Disk/Key	Select the situation in which you want the BIOS to stop the POST process and notify you
Base Memory	N/A	Displays the amount of conventional memory detected during boot up
Extended Memory	N/A	Displays the amount of extended memory detected during boot up
Total Memory	N/A	Displays the total memory available in the system

IDE Adapters

The IDE adapters control the hard disk drive. Use a separate sub menu to configure each hard disk drive.

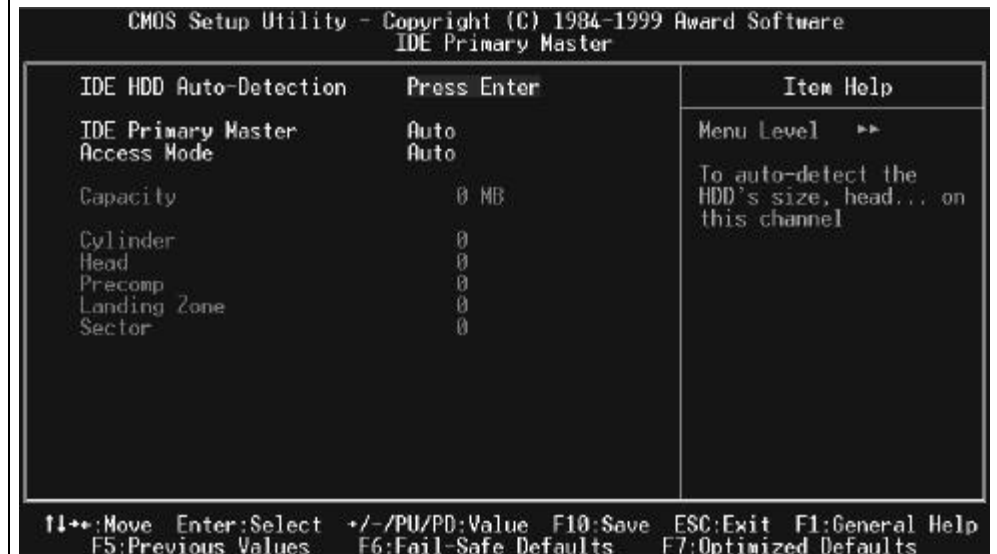

IDE Primary Master sub menu

Use the legend keys to navigate through this menu and exit to the main menu.

Item	Options	Description
IDE HDD Auto-detection	Press Enter	Press Enter to auto-detect the HDD on this channel. If detection is successful, it fills the remaining fields on this menu.
IDE Primary Master	None Auto Manual	Selecting ' manual' lets you set the remaining fields on this screen. Selects the type of fixed disk. "User Type" will let you select the number of cylinders, heads, etc. Note: PRECOMP=65535 means NONE !
Capacity	Auto Display your disk drive size	Disk drive capacity (Approximated). Note that this size is usually

		slightly greater than the size of a formatted disk given by a disk checking program.
Access Mode	Normal LBA Large Auto	Choose the access mode for this hard disk
The following options are selectable only if the ' IDE Primary Master' item is set to ' Manual'		
Cylinder	Min = 0 Max = 65535	Set the number of cylinders for this hard disk.
Head	Min = 0 Max = 255	Set the number of read/write heads
Precomp	Min = 0 Max = 65535	**** Warning: Setting a value of 65535 means no hard disk
Landing zone	Min = 0 Max = 65535	****
Sector	Min = 0 Max = 255	Number of sectors per track

3-4 Advanced BIOS Features

This section allows you to configure your system for basic operation. You have the opportunity to select the system's default speed, boot-up sequence, keyboard operation, shadowing and security.



Virus Warning

Allows you to choose the VIRUS Warning feature for IDE Hard Disk boot sector protection. If this function is enabled and someone attempt to write data into this area, BIOS will show a warning message on screen and alarm beep.

Enabled	Activates automatically when the system boots up causing a warning message to appear when anything attempts to access the boot sector or hard disk partition table.
Disabled	No warning message will appear when anything attempts to access the boot sector or hard disk partition table.

CPU Internal Cache/External Cache

These two categories speed up memory access. However, it depends on CPU/chipset design.

Enabled	Enable cache
Disabled	Disable cache

CPU L2 Cache ECC Checking

This item allows you to enable/disable CPU L2 Cache ECC checking.
The choice: Enabled, Disabled.

Processor Number Feature

The item is used to Enabled/Disabled the Processor Number Feature.
The choice: Enabled, Disabled.

Quick Power On Self Test

This category speeds up Power On Self Test (POST) after you power up the computer. If it is set to Enable, BIOS will shorten or skip some check items during POST.

Enabled	Enable quick POST
Disabled	Normal POST

First/Second/Third/Other Boot Device

The BIOS attempts to load the operating system from the devices in the sequence selected in these items.

The Choice: Floppy, LS/ZIP, HDD, SCSI, CDROM, Disabled.

Swap Floppy Drive

If the system has two floppy drives, you can swap the logical drive name assignments.

The choice: Enabled/Disabled.

Boot Up Floppy Seek

Seeks disk drives during boot up. Disabling speeds boot up.

The choice: Enabled/Disabled.

Boot Up NumLock Status

Select power on state for NumLock.

The choice: Enabled/Disabled.

Typematic Rate Setting

Key strokes repeat at a rate determined by the keyboard controller. When enabled, the typematic rate and typematic delay can be selected.

The choice: Enabled/Disabled.

Typematic Rate (Chars/Sec)

Sets the number of times a second to repeat a key stroke when you hold the key down.

The choice: 6, 8, 10, 12, 15, 20, 24, 30.

Typematic Delay (Msec)

Sets the delay time after the key is held down before it begins to repeat the keystroke.

The choice: 250, 500, 750, 1000.

Security Option

Select whether the password is required every time the system boots or only when you enter setup.

System	The system will not boot and access to Setup will be denied if the correct password is not entered at the prompt.
Setup	The system will boot, but access to Setup will be denied if the correct password is not entered at the prompt.

Note: To disable security, select PASSWORD SETTING at Main Menu and then you will be asked to enter password. Do not type anything and just press <Enter>, it will disable security. Once the security is disabled, the system will boot and you can enter Setup freely.

OS Select For DRAM > 64MB

Select the operating system that is running with greater than 64MB of RAM on the system.

The choice: Non-OS2, OS2.

Report No FDD For Win 95

Whether report no FDD for Win 95 or not.

The choice: Yes, No.

3-5 Advanced Chipset Features/Integrated Peripherals

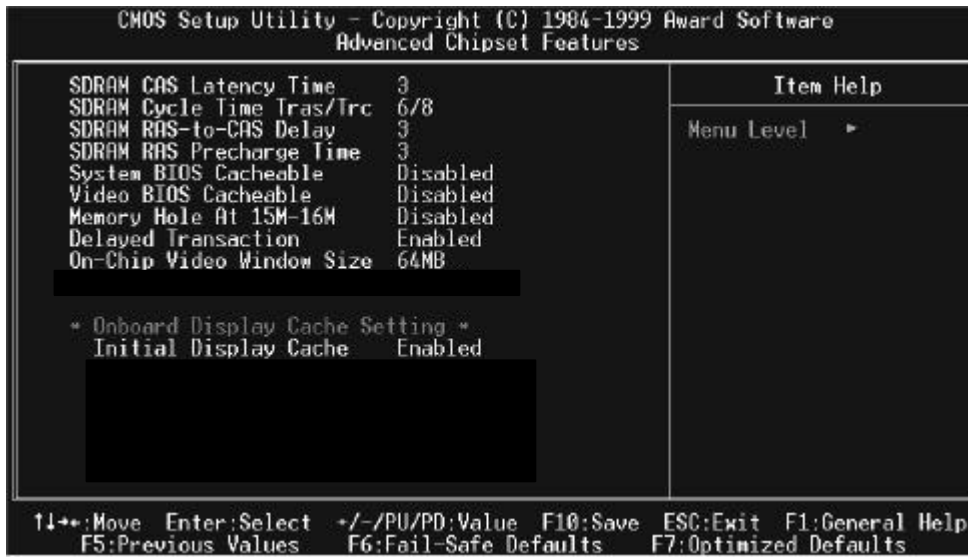

This section allows you to configure the system based on the specific features of the installed chipset. This chipset manages bus speeds and access to system memory resources, such as DRAM and the external cache. It also coordinates communications between the conventional ISA bus and the PCI bus. It must be stated that these items should never need to be altered. The default settings have been chosen because they provide the best operating conditions for your system. The only time you might consider making any changes would be if you discovered that data was being lost while using your system.

The first chipset settings deal with CPU access to dynamic random access memory (DRAM). The default timings have been carefully chosen and should only be altered if data is being lost. Such a scenario might well occur if your system had mixed speed DRAM chips installed so that greater delays may be required to preserve the integrity of the data held in the slower memory chips.

SDRAM CAS Latency Time

When synchronous DRAM is installed, the number of clock cycles of CAS latency depends on the DRAM timing.

The Choice: 2, 3

SDRAM Cycle Time Tras/Trc

Select the number of SCLKs for an access cycle.

The Choice: 5/7, 6/8.

SDRAM Address Setup Time

This item controls the Address Setup to the SDRAM timing.

The Choice: 1, 2.

SDRAM RAS-to-CAS Delay

SDRAM RAS-to-CAS Delay is an important parameter that affects SDRAM performance. If the system fails to bootup, please set this item to 3.

The Choice: 2, 3.

SDRAM RAS Precharge Time

The RAS Precharge means the timing to inactive RAS and the timing for DRAM to do precharge before next RAS can be issued. RAS is the address latch control signal of DRAM row address. The default setting is 3 clocks.

The Choice: 2, 3.

System BIOS Cacheable

Selecting *Enabled* allows caching of the system BIOS ROM at F0000h-FFFFFh, resulting in better system performance. However, if any program writes to this memory area, a system error may result.

The choice: Enabled, Disabled.

Video BIOS Cacheable

Select Enabled allows caching of the video BIOS, resulting in better system performance. However, if any program writes to this memory area, a system error may result.

The Choice: Enabled, Disabled.

Memory Hole At 15M-16M

You can reserve this area of system memory for ISA adapter ROM. When this area is reserved, it cannot be cached. The user information of peripherals that need to use this area of system memory usually discusses their memory requirements.

The Choice: Enabled, Disabled.

Delay Transaction

The chipset has an embedded 32-bit posted write buffer to support delay transactions cycles. Select *Enabled* to support compliance with PCI specification version 2.1.

The Choice: Enabled, Disabled.

On-Chip Video Window Size

Select the on-chip video window size for VGA drive use.

The Choice: 32MB, 64MB, Disabled.

Initial Display Cache

The item is used to Enabled/Disabled Initial Display Cache.

The Choice: Enabled, Disabled.

3-6 Integrated Peripherals**OnChip Primary/Secondary PCI IDE**

The integrated peripheral controller contains an IDE interface with support for two IDE channels. Select *Enabled* to activate each channel separately.

The choice: Enabled, Disabled.

IDE Primary/Secondary Master/Slave PIO

The four IDE PIO (Programmed Input/Output) fields let you set a PIO mode (0-4) for each of the four IDE devices that the onboard IDE interface supports. Modes 0 through 4 provide successively increased performance. In Auto mode, the system automatically determines the best mode for each device.

The choice: Auto, Mode 0, Mode 1, Mode 2, Mode 3, Mode 4.

IDE Primary/Secondary Master/Slave UDMA

Ultra DMA/33 implementation is possible only if your IDE hard drive supports it and the operating environment includes a DMA driver (Windows 95 OSR2 or a third-party IDE bus master driver). If your hard drive and your system software

both support Ultra DMA/33, select Auto to enable BIOS support.
The Choice: Auto, Disabled.

USB Controller

Select *Enabled* if your system contains a Universal Serial Bus (USB) controller and you have USB peripherals.
The choice: Enabled, Disabled.

USB Keyboard Support

Select *Enabled* if your system contains a Universal Serial Bus (USB) controller and you have a USB keyboard.
The choice: Enabled, Disabled.

Init Display First

This item allows you to decide to active whether PCI Slot or on-chip VGA first
The choice: PCI Slot, Onboard .

AC97 Audio/Modem

This item allows you to decide to enable/disable the 810 chipset family to support AC97 Audio/Modem.
The choice: Auto, Disabled.

IDE HDD Block Mode

Block mode is also called block transfer, multiple commands, or multiple sector read/write. If your IDE hard drive supports block mode (most new drives do), select Enabled for automatic detection of the optimal number of block read/writes per sector the drive can support.
The choice: Enabled, Disabled

POWER ON Function

This item is used to select Wake on Keyboard/Mouse mode.
Any Key: This function allows you wake up the system by clicking any key.
Button Only: Disable Wake on KB/MS function. You can boot up your system by power button only.

Keyboard 98: If selecting this option, you can boot up the system by power button and the wake? Key on Keyboard 98 .

Password: Disable the function of power button and let the system can only be powered on through the preset keys (like a password).

Hot Key: If selecting this option, you also need to specify the hot key from Keyboard Power On item.

Mouse Left: This function allows you wake up the system by clicking left mouse button twice successively.

Mouse Right: This function allows you wake up the system by clicking right mouse button twice successively.

The Choice: Keyboard 98,Password,Hot KEY, Mouse Move, Mouse Click, Any KEY, BUTTON ONLY.

KB Power ON Password

You can specify 1-5 keys as a password.
The choice: Enter

Hot Key Power ON

If you select Hot Key option in power On Function Item, you need to specify a hot key here.
The Choice:Ctrl-F1–Ctrl-F12

Onboard FDC Controller

Select Enabled if your system has a floppy disk controller (FDC) installed on the system board and you wish to use it. If you install and-in FDC or the system has no floppy drive, select Disabled in this field.
The choice: Enabled, Disabled.

Onboard Serial Port 1/Port 2

Select an address and corresponding interrupt for the first and second serial ports.
The choice: 3F8/IRQ4, 2E8/IRQ3, 3E8/IRQ4, 2F8/IRQ3, Disabled, Auto.

UART Mode Select

This item is configurable only if the "Onboard UART 2" is enabled. This allows you to specify the mode of serial port 2.

ASKIR - Select this setting if you installed an Infrared module via IrDA connector (refer to section 2.3 "Connectors"). This ASKIR setting allows infrared serial communication at a maximum baud rate of 56K baud.

HPSIR - Select this setting if you installed an Infrared module in your system via IrDA connector (refer to section 2.3 "Connectors"). The HPSIR setting

allows infrared serial communication at a maximum baud rate of 115K baud.

FIR - Select this setting if you installed an Infrared module via IrDA connector (refer to section 2.3 "Connectors"). This FIR (Fast IR) setting allows infrared serial communication at a maximum baud rate of 4M baud.

Normal - Sets serial port 2 to operate in normal mode. This is the default setting.

The choice: Normal,SCR,IrDA,ASKIR.

UR2 Duplex Mode

This item is used to select UR2 Duplex Mode.

The Choice: Half, Full

Onboard Parallel Port

This item controls the onboard parallel port address and interrupt.

The choice: 378/IRQ7, 278/IRQ5,3BC/IRQ7, Disable.

Parallel Port Mode

This item lets you set the parallel port mode. The mode options are SPP (Standard and Bidirection Parallel Port), EPP (Enhanced Parallel Port) and ECP (Extended Parallel Port). SPP is the IBM AT and PS/2 compatible mode. EPP enhances the parallel port throughput by directly writing/reading data to/from parallel port without latch. ECP supports DMA and RLE (Run Length Encoded) compression and decompression.

The choice: SPP, EPP, ECP,ECP+EPP.

ECP Mode Use DMA

This item lets you set the DMA channel of ECP mode.

The Choice:1,3.

PWRON After PWR Fail

A traditional ATX system should remain at power off stage when AC power resumes from power failure. This design is inconvenient for a network server or workstation, without an UPS, that needs to keep power-on. This item is used to solve this problem. Selecting On lets the system can automatically power-on after AC power resumes; in the other hand, the system will power-off if you select Off. If Former-Sts option is selected, the system will power-on or power-off based on the original state.

The Choice: off, on, Former-sts.

Game Port Address

This item is used to assign an address for the Game port.

The Choice: Disable, 201, 209.

Midi Port Address

This item is used to assign an address for the MIDI port.

The Choice: 330, 300, Disable.

Midi Port IRQ

This item is used to assign an IRQ for the MIDI port.

The Choice:10, 5.

3-7 Power Management Setup.

The Power Management Setup allows you to configure your system to most effectively save energy while operating in a manner consistent with your own style of computer use.



ACPI Function

This item allows you to enable/disable the Advanced Configuration and Power Management (ACPI).

The choice: Enabled, Disabled.

Power Management

This category allows you to select the type (or degree) of power saving and is directly related to the following modes:

1. HDD Power Down
2. Doze Mode
3. Suspend Mode

There are four selections for Power Management, three of which have fixed mode settings.

Disable (default)	No power management. Disables all four modes
Min. Power Saving	Minimum power management. Doze Mode = 1 hr. Standby Mode = 1 hr., Suspend Mode = 1 hr., and HDD Power Down = 15 min.
Max. Power Saving	Maximum power management -- ONLY AVAILABLE FOR SL CPU's . Doze Mode = 1 min., Standby Mode = 1 min., Suspend Mode = 1 min., and HDD Power Down = 1 min.
User Defined	Allows you to set each mode individually. When not disabled, each of the ranges are from 1 min. to 1 hr. except for HDD Power Down which ranges from 1 min. to 15 min. and disable.

Video Off Method

This determines the manner in which the monitor is blanked.

V/H SYNC+Blank	This selection will cause the system to turn off the vertical and horizontal synchronization ports and write blanks to the video buffer.
Blank Screen	This option only writes blanks to the video buffer.
DPMS	Initial display power management signaling.

Video Off In Suspend

This determines the manner in which the monitor is blanked.

The choice: Yes, No.

Suspend Type

Select the Suspend Type.

The choice: PWRON Suspend, Stop Grant.

MODEM Use IRQ

This determines the IRQ in which the MODEM can use.

The choice: 3, 4, 5, 7, 9, 10, 11, NA.

Suspend Mode

When enabled and after the set time of system inactivity, all devices except the CPU will be shut off.

The choice: Enabled, Disabled.

HDD Power Down

When enabled and after the set time of system inactivity, the hard disk drive will be powered down while all other devices remain active.

The choice: Enabled, Disabled.

Soft-Off by PWR-BTTN

Pressing the power button for more than 4 seconds forces the system to enter the Soft-Off state when the system has "hung."

The choice: Delay 4 Sec, Instant-Off.

Wake-Up by PCI Card

This option lets you specify enable or disable PCI Card Wake-up function.

The choice: Enabled, Disabled.

Power On by Ring

This option lets you specify enable or disable Power On by Ring function.

The choice: Enabled, Disabled.

Wake Up On LAN

This option lets you specify enable or disable LAN Wake Up function.

The choice: Enabled, Disabled.

Resume by Alarm

This option lets you enable or disable the RTC Wake Up function.

The choice: Enabled, Disabled.

Date(of Month)Alarm

This item is displayed when you enable the Wake On RTC Timer option. Here you can specify what date you want to wake up the system. For Example, setting to 15 will wake up the system on the 15th day of every month.

The choice:0-31

Time(hh: mm: ss)Alarm

This item is displayed when you enable the Wake ON RTC Timer option. Here you can specify what time you want to wake up the system.

The choice:hh:0-23,mm:0-59,ss:0-59.

PM Events

PM events are I/O events whose occurrence can prevent the system from entering a power saving mode or can awaken the system from such a mode. In effect, the system remains alert for anything which occurs to a device which is configured as *Enabled*, even when the system is in a power down mode.

Primary IDE 0

Primary IDE 1

Secondary IDE 0

Secondary IDE 1

FDD, COM, LPT Port

PCI PIRQ[A-D] #

3-8 PnP/PCI Configuration Setup

This section describes configuring the PCI bus system. PCI, or Personal Computer Interconnect, is a system which allows I/O devices to operate at speeds nearing the speed the CPU itself uses when communicating with its own special components. This section covers some very technical items and it is strongly recommended that only experienced users should make any changes to the default settings.

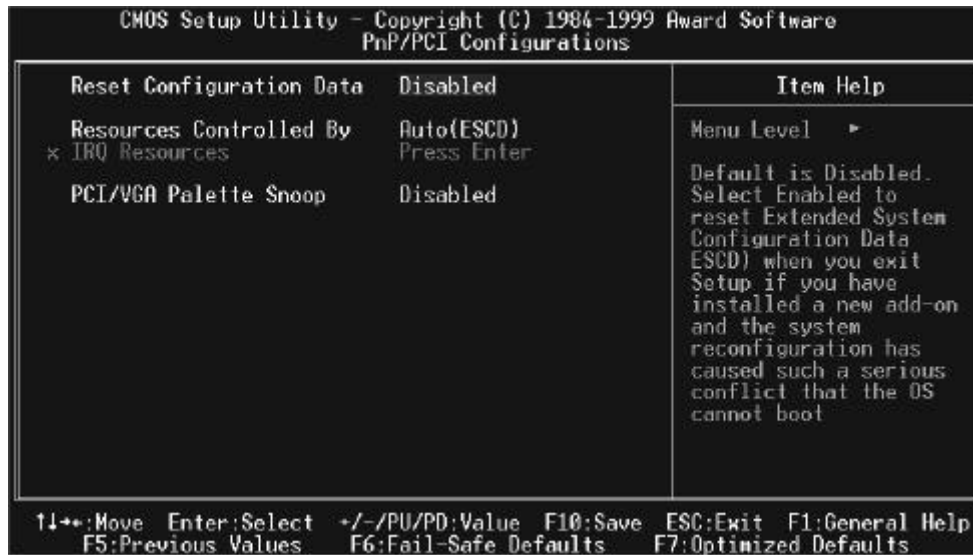

Reset Configuration Data

Normally, you leave this field Disabled. Select Enabled to reset Extended System Configuration Data (ESCD) when you exit Setup if you have installed a new add-on and the system reconfiguration has caused such a serious conflict that the operating system can not boot.

The choice: Enabled, Disabled .

Resource controlled by

The Award Plug and Play BIOS has the capacity to automatically configure all of the boot and Plug and Play compatible devices. However, this capability means

absolutely nothing unless you are using a Plug and Play operating system such as Windows®95/98. If you set this field to "manual" choose specific resources by going into each of the sub menu that follows this field (a sub menu is preceded by a "▸").

The choice: Auto(ESCD), Manual.

IRQ Resources

When resources are controlled manually, assign each system interrupt a type, depending on the type of device using the interrupt.

IRQ3/4/5/7/9/10/11/12/14/15 assigned to

This item allows you to determine the IRQ assigned to the ISA bus and is not available to any PCI slot. Legacy ISA for devices compliant with the original PC AT bus specification, PCI/ISA PnP for devices compliant with the Plug and Play standard whether designed for PCI or ISA bus architecture.

The Choice: PCI Device,Reserved.

PCI/VGA Palette Snoop

Leave this field at *Disabled*.

Choices are Enabled, Disabled.

3-9 PC Health Status

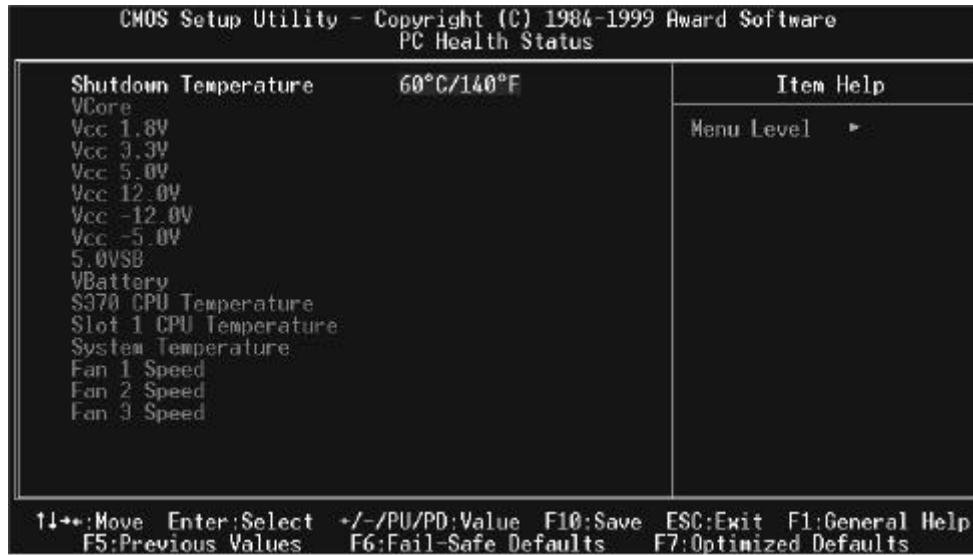

The PC Health Status provides fan rotations, Voltages, and temperature of the system. Choose "PC Health Status" from the Main Menu and a screen with a list of items appears.

3-10 Frequency Control

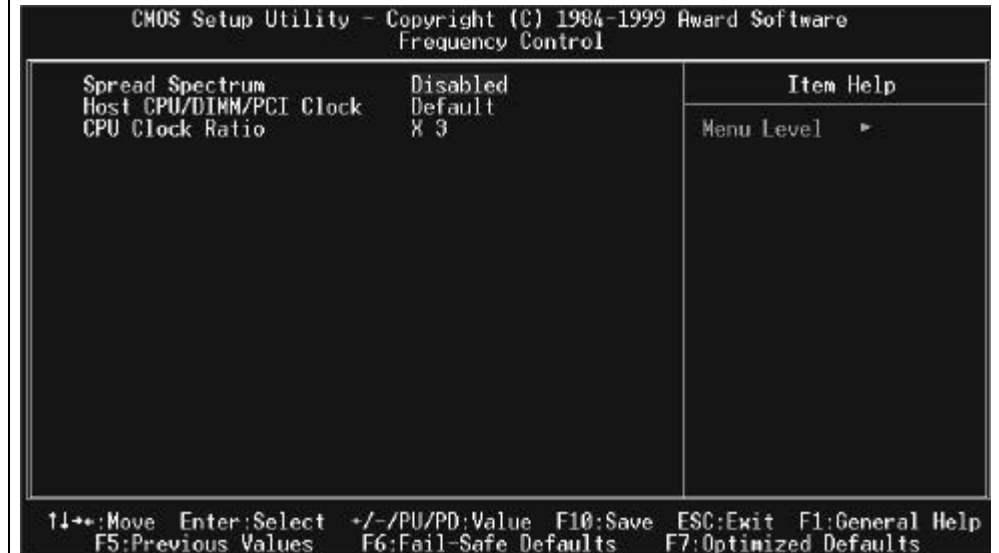
**Spread Spectrum Modulated**

This item allows you to enable/disable the spread spectrum modulate. The choice: Enabled, Disabled.

Host CPU/DIMM/PCI Clock

This item allows you to select the CPU, DIMM and PCI Frequency. The choice: Default, 66/100/33, 68/102/34, 75/112/137, 100/100/33, 103/103/34, 124/124/41, 133/133/44, 140/140/46, 150/150/50, 133/100/33, 140/105/35, 150/112/37MHz

CPU Clock Ratio

This item allows you to select The CPU ratio. The choice: 3, 3.5, 4, 4.5, 5, 5.5, 6, 6.5, 7, 7.5, 8.

3-11 Defaults Menu

Selecting "Defaults" from the main menu shows you two options which are described below

Load Fail-Safe Defaults

When you press <Enter> on this item you get a confirmation dialog box with a message similar to:

Load Fail-Safe Defaults (Y/N) ? N

Pressing ' Y ' loads the BIOS default values for the most stable, minimal-performance system operations.

Load Optimized Defaults

When you press <Enter> on this item you get a confirmation dialog box with a message similar to:

Load Optimized Defaults (Y/N) ? N

Pressing ' Y ' loads the default values that are factory settings for optimal performance system operations.

3-12 Password Setting

You can set the password described below,

ENTER PASSWORD:

Type the password, up to eight characters in length, and press <Enter>. The password typed now will clear any previously entered password from CMOS memory. You will be asked to confirm the password. Type the password again and press <Enter>. You may also press <Esc> to abort the selection and not enter a password.

To disable a password, just press <Enter> when you are prompted to enter the password. A message will confirm the password will be disabled. Once the password is disabled, the system will boot and you can enter Setup freely.

PASSWORD DISABLED.

When a password has been enabled, you will be prompted to enter it every time you try to enter Setup. This prevents an unauthorized person from changing any part of your system configuration.

Additionally, when a password is enabled, you can also require the BIOS to request a password every time your system is rebooted. This would prevent unauthorized use of your computer.

You determine when the password is required within the BIOS Features Setup Menu and its Security option (see Section 3). If the Security option is set to "System", the password will be required both at boot and at entry to Setup. If set to "Setup", prompting only occurs when trying to enter Setup.

3-13 Exit Selecting

Save & Exit Setup

Pressing <Enter> on this item asks for confirmation:

Save to CMOS and EXIT (Y/N)? **Y**

Pressing “Y” stores the selections made in the menus in CMOS – a special section of memory that stays on after you turn your system off. The next time you boot your computer, the BIOS configures your system according to the Setup selections stored in CMOS. After saving the values the system is restarted again.

Exit Without Saving

Pressing <Enter> on this item asks for confirmation:

Quit without saving (Y/N)? **Y**

This allows you to exit Setup without storing in CMOS any change. The previous selections remain in effect. This exits the Setup utility and restarts your computer.

Chapter 4

Software Driver Install

4-1 UPDATED PRODUCT INFORMATION

1. Enter the INF subdirectory and double-click SETUP.EXE.

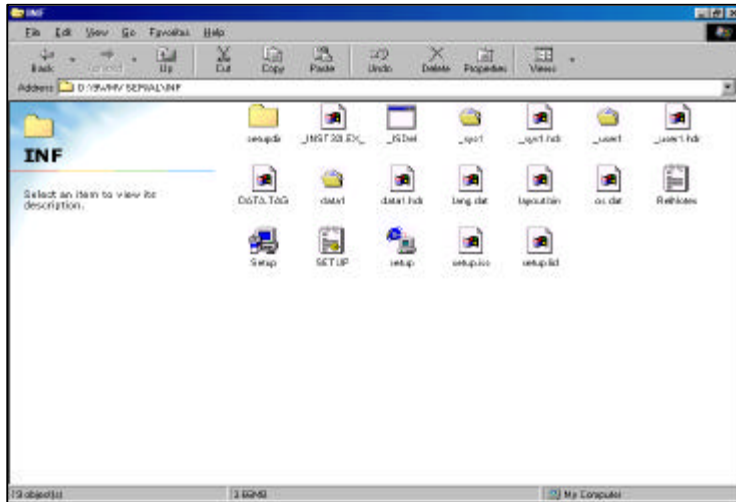

2. Click "Next" at the Welcome screen.

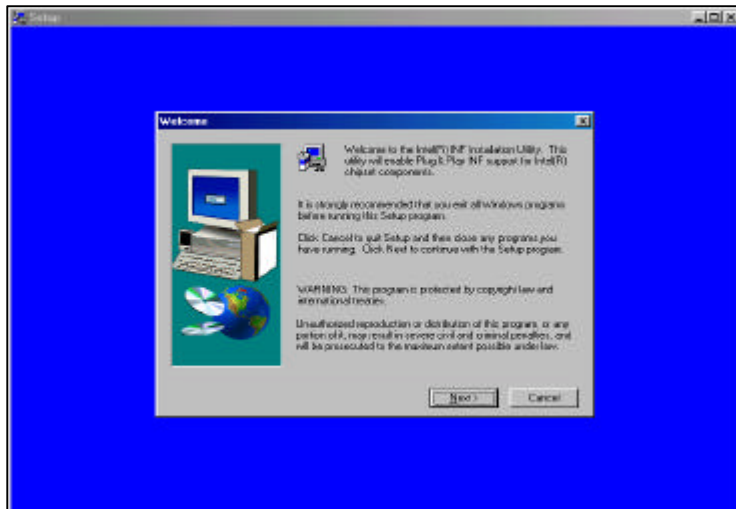

4-1

3. Read the license agreement and click "Yes" to continue.

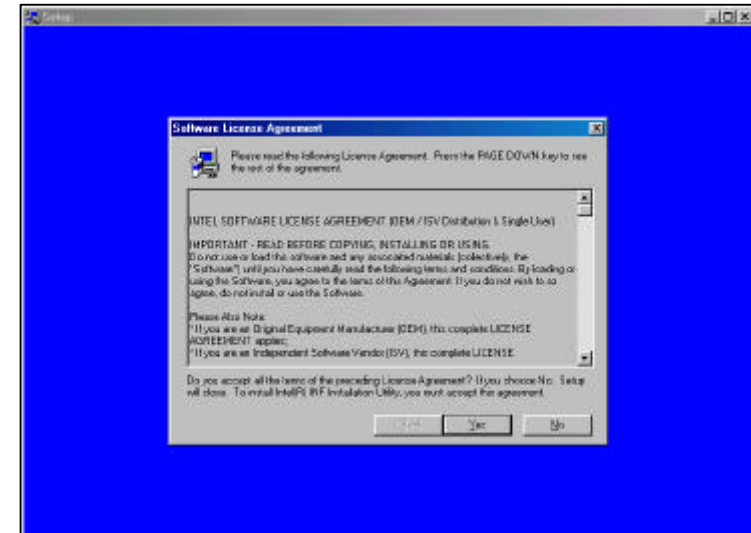

4. Read readme.txt information and click "NEXT" to continue.

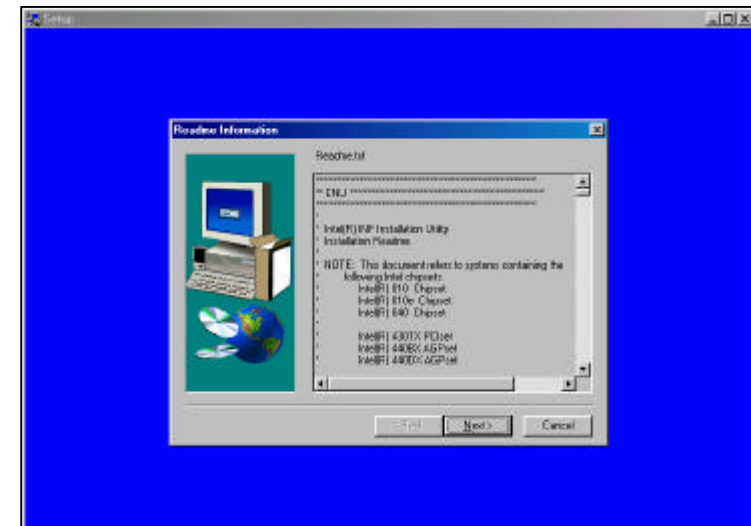

4-2

5. The driver files will now be installed. When finished installing, choose the "Yes" to reboot option and click "Finish" to restart your computer. The driver should now be loaded.

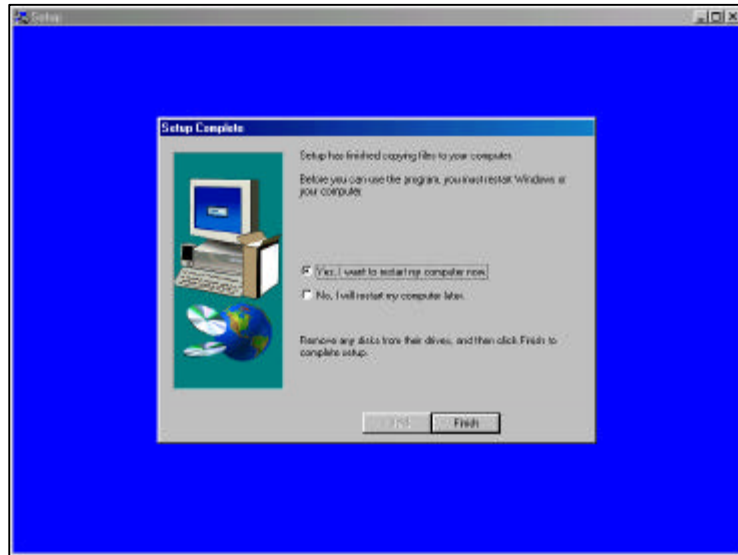

4-2 Install Graphics Driver

1. Enter the graphics subdirectory and double-click SETUP.EXE.

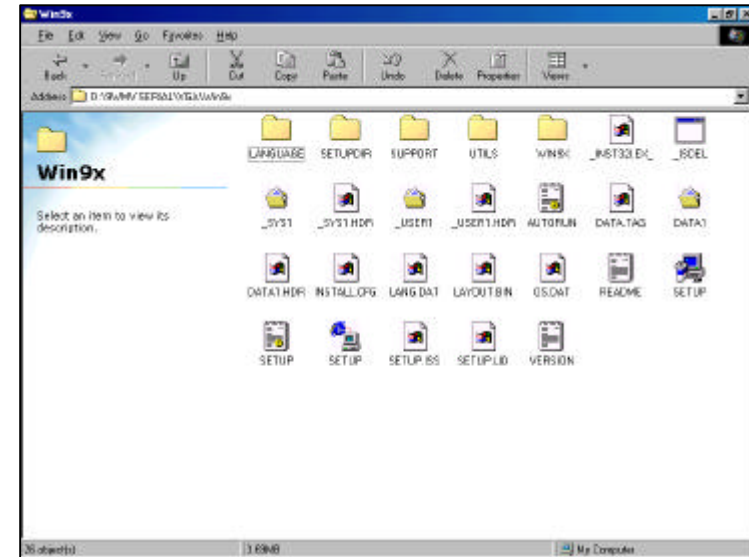

2. Click "Next" at the Welcome screen.

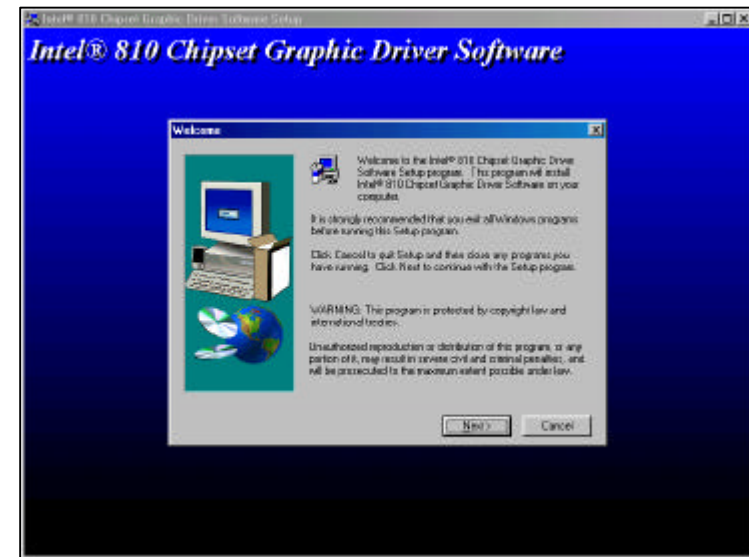

3. Read the license agreement and click "Yes" to continue.

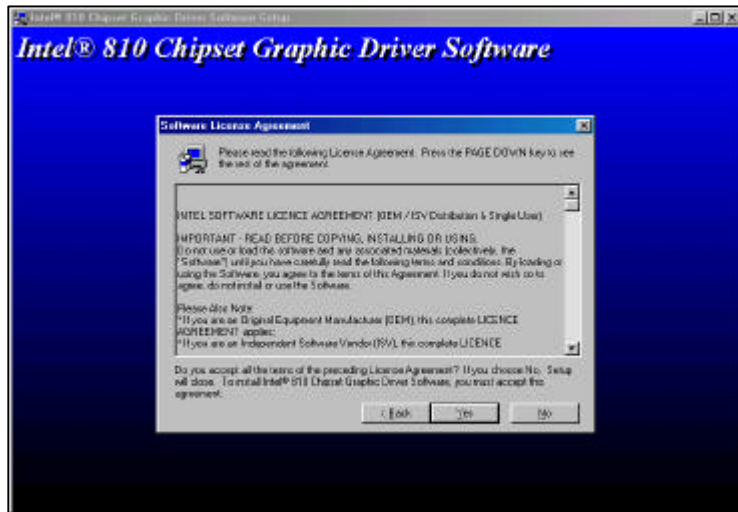

4. This screen indicates the directory where the End User Diagnostic Utility files will be stored. NOTE: the graphics driver is not installed here (it is installed in the appropriate Windows system directories), just the EUD utility files. If you wish to change the directory where the EUD will be stored, click "Browse" and change the directory. Click "Next" to continue.



5. The driver files will now be installed. When finished installing, choose the "Yes" to reboot option and click "Finish" to restart your computer. The driver should now be loaded. To determine if the driver has been loaded correctly, refer to the "Verifying Installation" section, below.

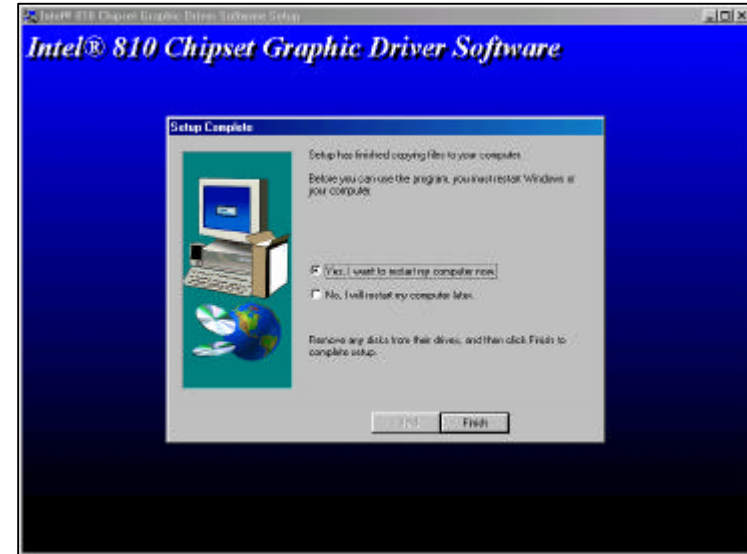

4-3 Install Audio Driver

1.To remove an existing driver/application and install with the latest Driver/application, please run SETUP.EXE file (included in the " Win98WDM subdirectory") ,double-click SETUP.EXE.

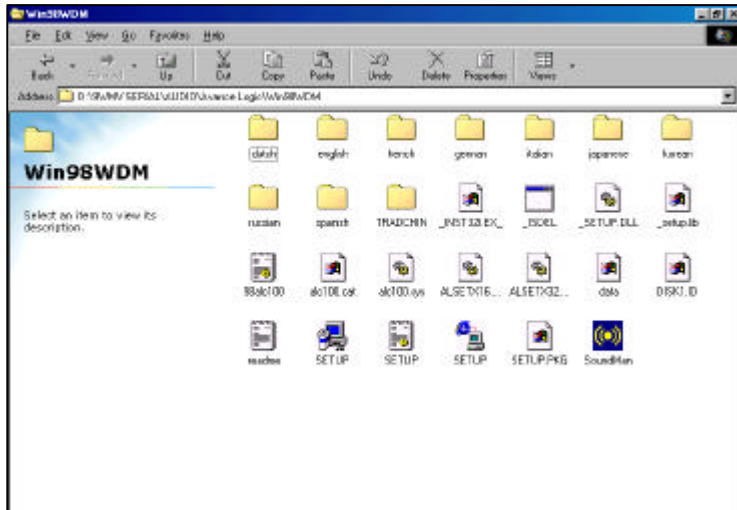

2.Choose Language and Click "Next" to continue.

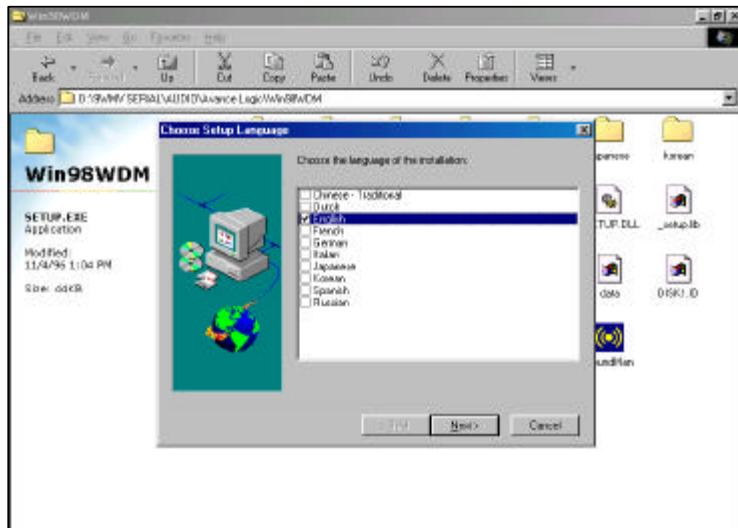

4-7

3.Click "Next" at the Welcome screen.



4.In selecting a setup type, please choose "Remove and Install Software.." and click on" Next ". When asked with " Do you want to install the bundled application?" Select "Yes, I do." to install ALSRACK Player or "No, I don't." if not. Click on "Next" and the program will install both the driver and application automatically.



4-8

5. Click "Next" to continue.



6. The driver files will now be installed. Click "Finish" to end the setup program.

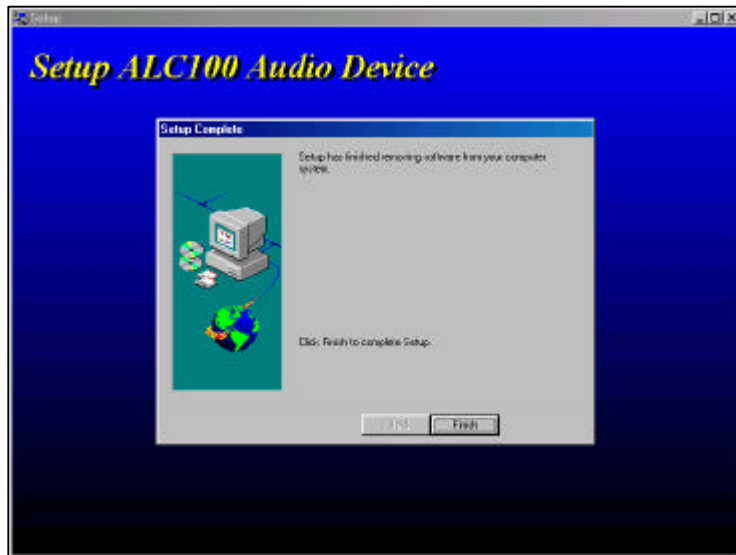

4-4 Anti-Virus software installation

Put CD title driver into CD ROM, then choose "Anti-Virus software" on the main menu, follow each instruction on the screen as the followings.

