

FCC Information and Copyright

This equipment has been tested and found to comply with the limits of a Class B digital device, pursuant to Part 15 of the FCC Rules. These limits are designed to provide reasonable protection against harmful interference in a residential installation. This equipment generates, uses and can radiate radio frequency energy and, if not installed and used in accordance with the instructions, may cause harmful interference to radio communications. There is no guarantee that interference will not occur in a particular installation.

The vendor makes no representations or warranties with respect to the contents here and specially disclaims any implied warranties of merchantability or fitness for any purpose. Further the vendor reserves the right to revise this publication and to make changes to the contents here without obligation to notify any party beforehand.

Duplication of this publication, in part or in whole, is not allowed without first obtaining the vendor's approval in writing.

The content of this user's manual is subject to be changed without notice and we will not be responsible for any mistakes found in this user's manual. All the brand and product names are trademarks of their respective companies.

Table of Contents

Chapter 1: Introduction	1
1.1 Before You Start.....	1
1.2 Package Checklist.....	1
1.3 Motherboard Features.....	2
1.4 Rear Panel Connectors (Ver 6.x).....	4
1.5 Rear Panel Connectors (Ver 5.x).....	4
1.6 Motherboard Layout (for Ver 6.x).....	5
1.7 Motherboard Layout (for Ver 5.x).....	6
Chapter 2: Hardware Installation	7
2.1 Installing Central Processing Unit (CPU).....	7
2.2 FAN Headers.....	9
2.3 Installing System Memory.....	10
2.4 Connectors and Slots.....	12
Chapter 3: Headers & Jumpers Setup	14
3.1 How to Setup Jumpers.....	14
3.2 Detail Settings.....	14
Chapter 4: Useful Help	19
4.1 Driver Installation Note	19
4.2 Award BIOS Beep Code.....	20
4.3 Extra Information.....	20
4.4 Troubleshooting.....	22
Chapter 5: WarpSpeeder™	23
5.1 Introduction.....	23
5.2 System Requirement.....	23
5.3 Installation	24
5.4 WarpSpeeder™.....	25
Appendices: SPEC In Other Language	32
German.....	32
France.....	34
Italian.....	36
Spanish.....	38
Portuguese.....	40
Polish.....	42
RUSSIAN.....	44
ARABIC.....	46
JAPANESE.....	48

CHAPTER 1: INTRODUCTION

1.1 BEFORE YOU START

Thank you for choosing our product. Before you start installing the motherboard, please make sure you follow the instructions below:

- Prepare a dry and stable working environment with sufficient lighting.
- Always disconnect the computer from power outlet before operation.
- Before you take the motherboard out from anti-static bag, ground yourself properly by touching any safely grounded appliance, or use grounded wrist strap to remove the static charge.
- Avoid touching the components on motherboard or the rear side of the board unless necessary. Hold the board on the edge, do not try to bend or flex the board.
- Do not leave any unfastened small parts inside the case after installation. Loose parts will cause short circuits which may damage the equipment.
- Keep the computer from dangerous area, such as heat source, humid air and water.

1.2 PACKAGE CHECKLIST

- FDD Cable X 1
- HDD Cable X 1
- User's Manual X 1
- Serial ATA Cable X 1
- Fully Setup Driver CD X 1
- Rear I/O Panel for ATX Case X 1
- USB 2.0 Cable X1 (optional)
- S/PDIF Cable X 1 (optional)
- Serial ATA Power Switch Cable X 1 (optional)

1.3 MOTHERBOARD FEATURES

	945P-A7B	945PL-A7B
CPU	LGA 775 Intel Core2Duo / Pentium 4 / Pentium D / Celeron D processor up to 3.8 GHz Supports Hyper-Threading Execute Disable Bit Enhanced Intel SpeedStep Extended Memory 64 Technology	LGA 775 Intel Core2Duo / Pentium 4 / Pentium D / Celeron D processor up to 3.8 GHz Supports Hyper-Threading Execute Disable Bit Enhanced Intel SpeedStep Extended Memory 64 Technology
FSB	533 / 800 / 1066 MHz	533 / 800 / 1066 MHz
Chipset	Intel 945P Intel ICH7	Intel 945PL Intel ICH7
Super I/O	ITE IT8712F H/W Monitor Fan Speed Controller ITE's "Smart Guardian" function	ITE IT8712F H/W Monitor Fan Speed Controller ITE's "Smart Guardian" function
Main Memory	DIMM Slots x 4 Each DIMM supports 256/512MB & 1GB DDR2 Max Memory Capacity 4GB Dual Channel Mode DDR2 memory module Supports DDR2 533 / 667	DIMM Slots x 2 Each DIMM supports 256/512MB & 1GB DDR2 Max Memory Capacity 2GB Dual Channel Mode DDR2 memory module Supports DDR2 400 / 533
IDE	Integrated IDE Controller Ultra DMA 33~100 Bus Master Mode supports PIO Mode 0~4,	Integrated IDE Controller Ultra DMA 33~100 Bus Master Mode supports PIO Mode 0~4,
SATA	Integrated Serial ATA Controller Data transfer rates up to 3.0 Gb/s. SATA Version 2.0 specification compliant.	Integrated Serial ATA Controller Data transfer rates up to 3.0 Gb/s. SATA Version 2.0 specification compliant.
10/100 LAN	Realtek RTL 8100C 10 / 100 Mb/s auto negotiation Half / Full duplex capability	Realtek RTL 8100C 10 / 100 Mb/s auto negotiation Half / Full duplex capability
Sound Codec	ALC861VD(Ver 6.x) / ALC888(Ver 5.x) 5.1 channels audio out (Ver 6.x) 7.1 channels audio out (Ver 5.x) Intel High-Definition Audio support	ALC861VD(Ver 6.x) / ALC888(Ver 5.x) 5.1 channels audio out (Ver 6.x) 7.1 channels audio out (Ver 5.x) Intel High-Definition Audio support

945P-A7B/945PL-A7B

	945P-A7B		945PL-A7B	
Slots	PCI Express x 16 slot	x1	PCI Express x 16 slot	x1
	PCI Express x 1 slot	x2	PCI Express x 1 slot	x2
	PCI slot	x3	PCI slot	x3
On Board Connector	Floppy connector	x1	Floppy connector	x1
	IDE Connector	x1	IDE Connector	x1
	SATA Connector	x4	SATA Connector	x4
	Front Panel Connector	x1	Front Panel Connector	x1
	Front Audio Connector	x1	Front Audio Connector	x1
	CD-in Connector	x1	CD-in Connector	x1
	S/PDIF out connector	x1	S/PDIF out connector	x1
	CPU Fan header	x1	CPU Fan header	x1
	System Fan header	x1	System Fan header	x1
	Chassis open header (optional)	x1	Chassis open header (optional)	x1
	Clear CMOS header	x1	Clear CMOS header	x1
	USB connector	x2	USB connector	x2
Power Connector (24pin)	x1	Power Connector (24pin)	x1	
Power Connector (4pin)	x1	Power Connector (4pin)	x1	
Back Panel I/O	PS/2 Keyboard	x1	PS/2 Keyboard	x1
	PS/2 Mouse	x1	PS/2 Mouse	x1
	Serial Port	x1	Serial Port	x1
	Printer Port	x1	Printer Port	x1
	LAN port	x1	LAN port	x1
	USB Port	x4	USB Port	x4
	Audio Jack (Ver 6.x)	x3	Audio Jack (Ver 6.x)	x3
Audio Jack (Ver 5.x)	x6	Audio Jack (Ver 5.x)	x6	
Board Size	205 (W) x 305 (L) mm		205 (W) x 305 (L) mm	
OS Support	Windows 2000 / XP / VISTA Biostar Reserves the right to add or remove support for any OS with or without notice.		Windows 2000 / XP / VISTA Biostar Reserves the right to add or remove support for any OS with or without notice.	

1.4 REAR PANEL CONNECTORS (VER 6.X)

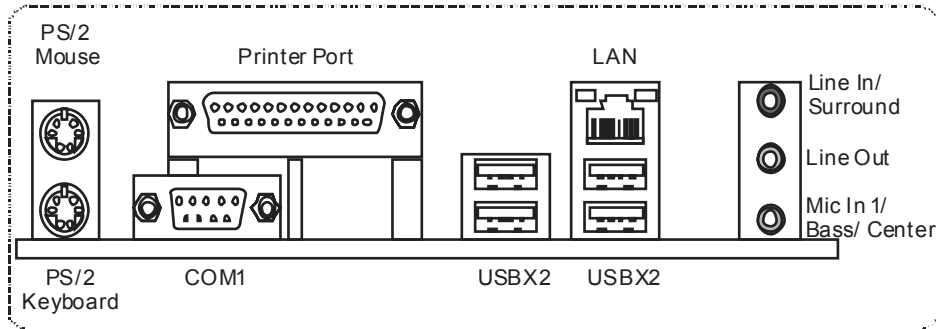

1.5 REAR PANEL CONNECTORS (VER 5.X)

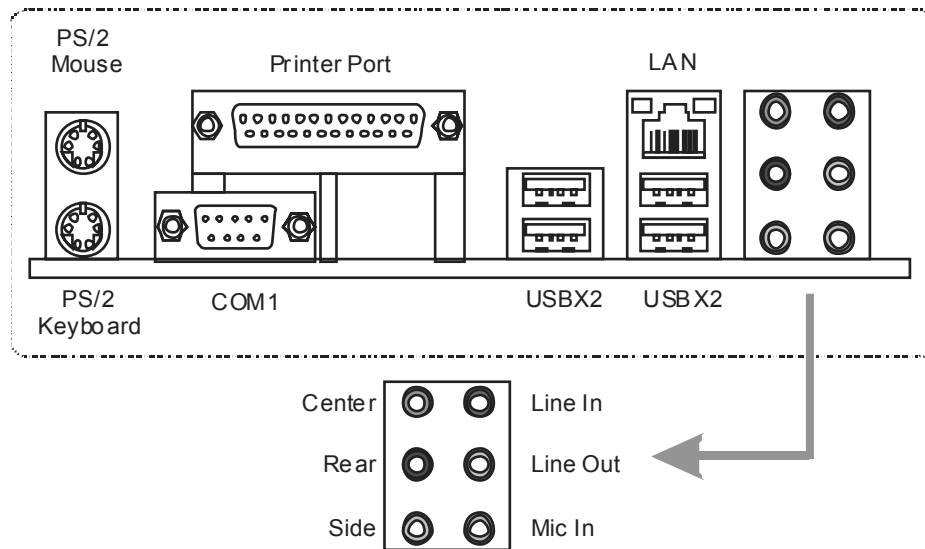

Since the audio chip supports Intel High Definition Audio Specification, the function of each audio jack can be defined by software. The input / output function of each audio jack listed above represents the default setting. However, when connecting external microphone to the audio port, please use the Line In (blue) and Mic In (Pink) audio jack.

1.6 MOTHERBOARD LAYOUT (FOR VER 6.X)

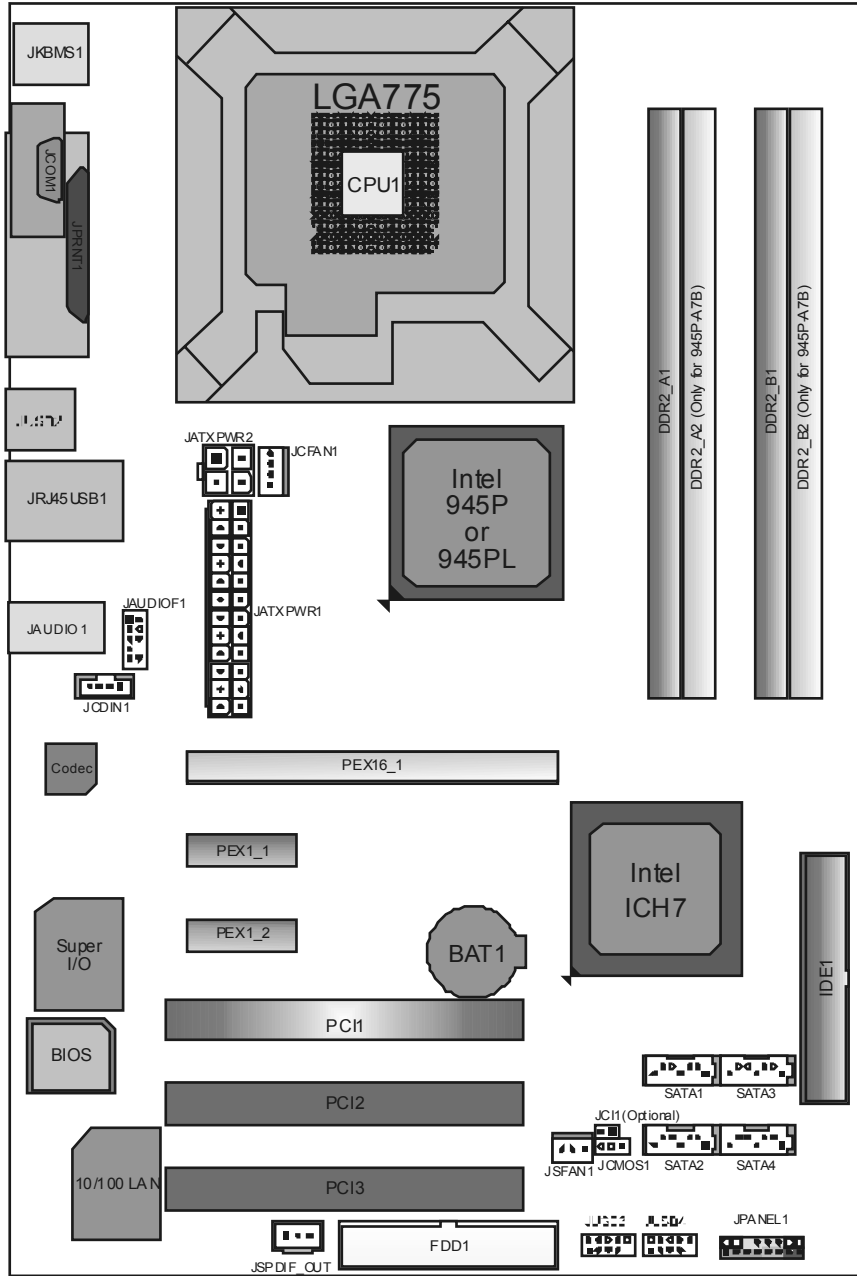

Note: ■ represents the 1st pin.

1.7 MOTHERBOARD LAYOUT (FOR VER 5.x)

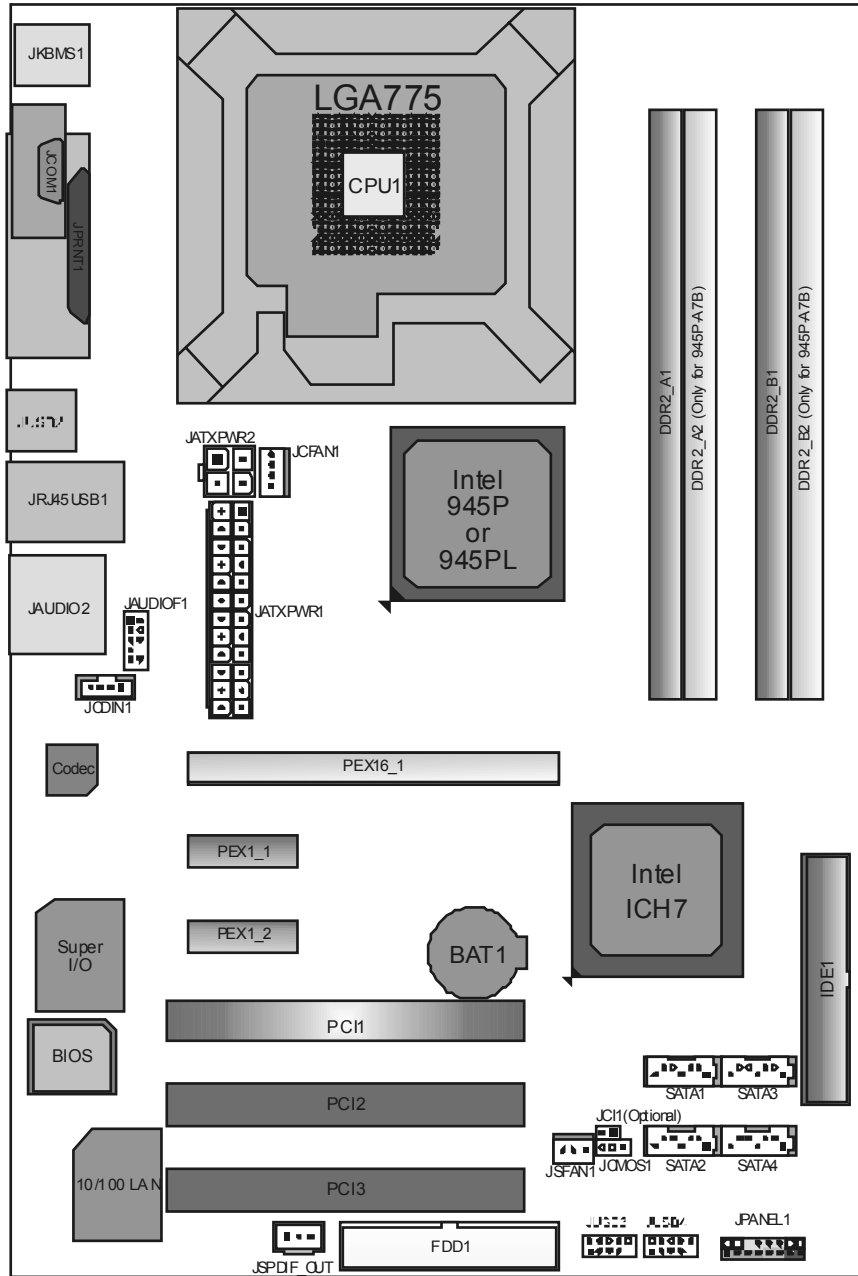

Note: ■ represents the 1st pin.

CHAPTER 2: HARDWARE INSTALLATION

2.1 INSTALLING CENTRAL PROCESSING UNIT (CPU)

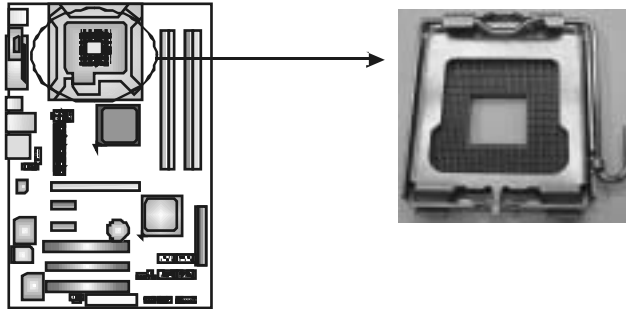

Special Notice

Remove Pin Cap before installation, and make good preservation for future use. When the CPU is removed, cover the Pin Cap on the empty socket to ensure pin legs won't be damaged.

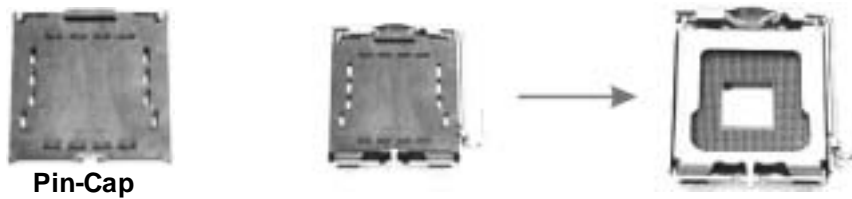

Step 1: Pull the socket locking lever out from the socket and then raise the lever up to a 90-degree angle.

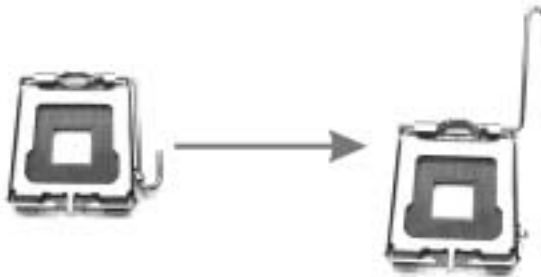

Step 2: Look for the triangular cut edge on socket, and the golden dot on CPU should point forwards this triangular cut edge. The CPU will fit only in the correct orientation.

Step 2-1:



Step 2-2:



Step 3: Hold the CPU down firmly, and then lower the lever to locked position to complete the installation.



Step 4: Put the CPU Fan and heatsink assembly on the CPU and buckle it on the retention frame. Connect the CPU FAN power cable into the JCFAN1. This completes the installation.

2.2 FAN HEADERS

These fan headers support cooling-fans built in the computer. The fan cable and connector may be different according to the fan manufacturer. Connect the fan cable to the connector while matching the black wire to pin#1.

JCFAN1: CPU Fan Header

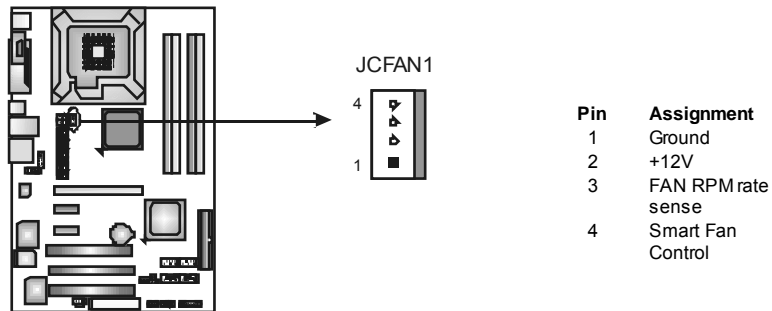

JSFAN1: System Fan Header

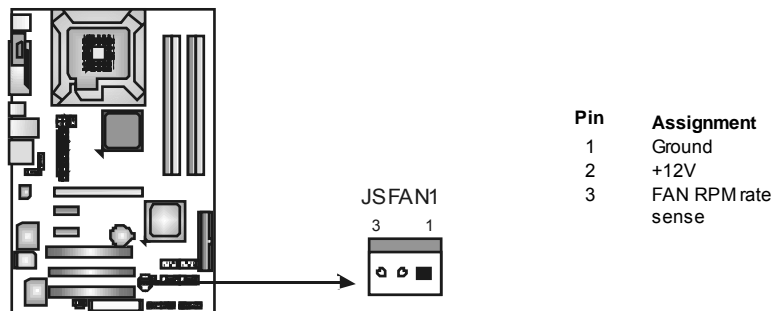

Note:

The JCFAN1 and JSFAN1 support 4-pin and 3-pin head connector. When connecting with wires onto connectors, please note that the red wire is the positive and should be connected to pin#2, and the black wire is Ground and should be connected to GND.

2.3 INSTALLING SYSTEM MEMORY

A. Memory Modules

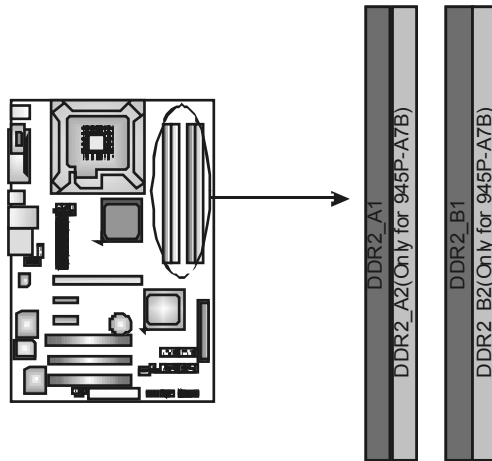

1. Unlock a DIMM slot by pressing the retaining clips outward. Align a DIMM on the slot such that the notch on the DIMM matches the break on the Slot.

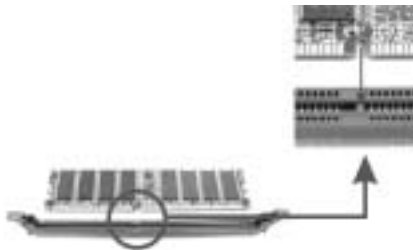

2. Insert the DIMM vertically and firmly into the slot until the retaining chip snap back in place and the DIMM is properly seated.



B. Memory Capacity

For 945P-A7B

DIMM Socket Location	DDR Module	Total Memory Size
DDR2_A1	256MB/512MB/1GB *1	Max memory 4GB.
DDR2_A2	256MB/512MB/1GB *1	
DDR2_B1	256MB/512MB/1GB *1	
DDR2_B2	256MB/512MB/1GB *1	

For 945PL-A7B

DIMM Socket Location	DDR Module	Total Memory Size
DDR2_A1	256MB/512MB/1GB *1	Max memory 2GB.
DDR2_B1	256MB/512MB/1GB *1	

C. Dual Channel Memory installation

To trigger the Dual Channel function of the motherboard, the memory module must meet the following requirements:

Install memory module of the same density in pairs, shown in the following table.

For 945P-A7B

Dual Channel Status	DDR2_A1	DDR2_A2	DDR2_B1	DDR2_B2
Enabled	O	X	O	X
Enabled	X	O	X	O
Enabled	O	O	O	O

For 945PL-A7B

Dual Channel Status	DDR2_A1	DDR2_B1
Disabled	O	X
Disabled	X	O
Enabled	O	O

(O means memory installed, X means memory not installed.)

The DRAM bus width of the memory module must be the same (x8 or x16)

2.4 CONNECTORS AND SLOTS

FDD1: Floppy Disk Connector

The motherboard provides a standard floppy disk connector that supports 360K, 720K, 1.2M, 1.44M and 2.88M floppy disk types. This connector supports the provided floppy drive ribbon cables.

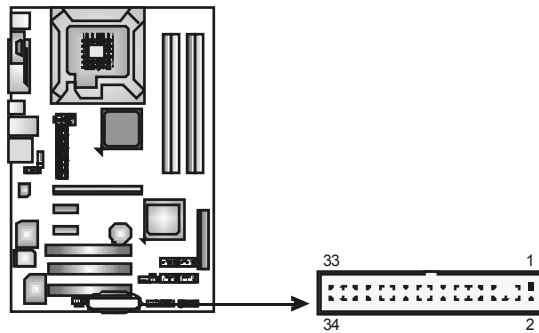

IDE1: Hard Disk Connectors

The motherboard has a 32-bit Enhanced PCI IDE Controller that provides PIO Mode 0~4, Bus Master, and Ultra DMA 33/66/100 functionality.

The IDE connectors can connect a master and a slave drive, so you can connect up to four hard disk drives. The first hard drive should always be connected to IDE1.

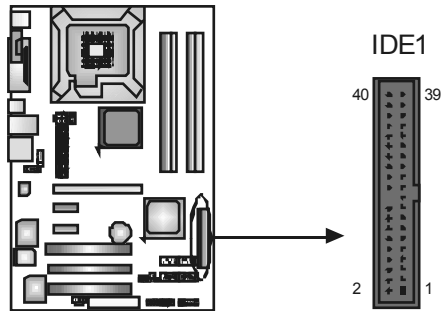

PEX16_1: PCI-Express x16 Slot

- PCI-Express 1.0a compliant.
- Maximum theoretical realized bandwidth of 4GB/s simultaneously per direction, for an aggregate of 8GB/s totally.

PEX1_1/PEX1_2: PCI-Express x1 Slots

- PCI-Express 1.0a compliant.
- Data transfer bandwidth up to 250MB/s per direction; 500MB/s in total.
- PCI-Express supports a raw bit-rate of 2.5Gb/s on the data pins.
- 2X bandwidth over the traditional PCI architecture.

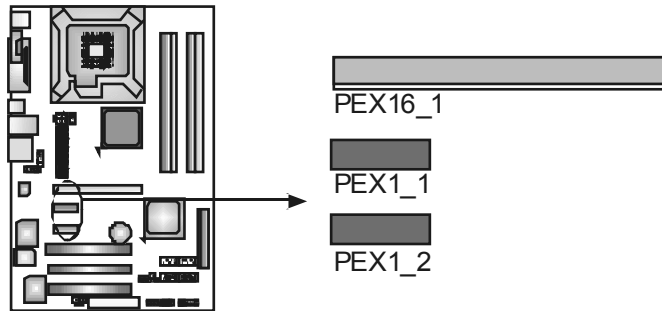

PCI1~PCI3: Peripheral Component Interconnect Slots

This motherboard is equipped with 3 standard PCI slots. PCI stands for Peripheral Component Interconnect, and it is a bus standard for expansion cards. This PCI slot is designated as 32 bits.

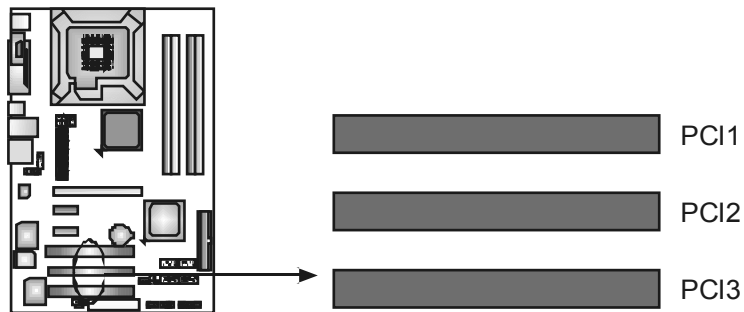

CHAPTER 3: HEADERS & JUMPERS SETUP

3.1 HOW TO SETUP JUMPERS

The illustration shows how to set up jumpers. When the jumper cap is placed on pins, the jumper is “close”, if not, that means the jumper is “open”.



Pin opened



Pin closed



Pin 1-2 closed

3.2 DETAIL SETTINGS

JPANEL1: Front Panel Header

This 16-pin connector includes Power-on, Reset, HDD LED, Power LED, Sleep button, and speaker connection. It allows user to connect the PC case's front panel switch functions.

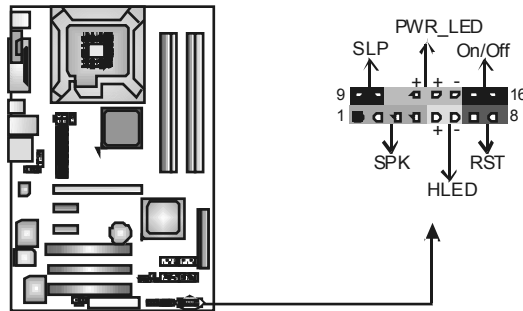

Pin	Assignment	Function	Pin	Assignment	Function
1	+5V	Speaker connector	9	Sleep control	Sleep button
2	N/A		10	Ground	
3	N/A		11	N/A	N/A
4	Speaker	Hard drive LED	12	Power LED (+)	Power LED
5	HDD LED (+)		13	Power LED (+)	
6	HDD LED (-)	Reset button	14	Power LED (-)	Power-on button
7	Ground		15	Power button	
8	Reset control		16	Ground	

JATXPWR1: ATX Power Source Connector

This connector allows user to connect 24-pin power connector on the ATX power supply.

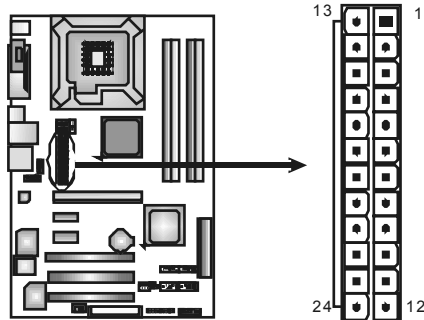

Pin	Assignment
1	+3.3V
2	+3.3V
3	Ground
4	+5V
5	Ground
6	+5V
7	Ground
8	PW_OK
9	StandbyVoltage +5V
10	+12V
11	+12V
12	2 x 12 Detect
13	+3.3V
14	-12V
15	Ground
16	PS_ON
17	Ground
18	Ground
19	Ground
20	-5V
21	+5V
22	+5V
23	+5V
24	Ground

JATXPWR2: ATX Power Source Connector

By connecting this connector, it will provide +12V to CPU power circuit.

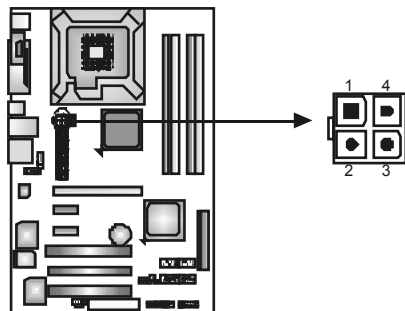

Pin	Assignment
1	+12V
2	+12V
3	Ground
4	Ground

JUSB3/JUSB4: Headers for USB 2.0 Ports at Front Panel

This motherboard provides 2 USB 2.0 headers, which allows user to connect additional USB cable on the PC front panel, and also can be connected with internal USB devices, like USB card reader.

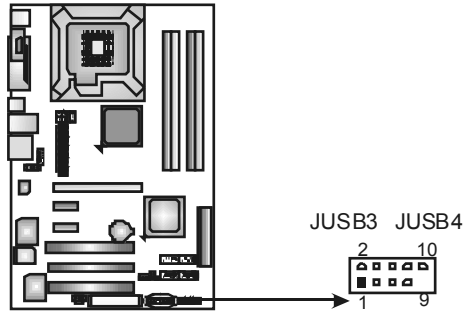

Pin	Assignment
1	+5V (fused)
2	+5V (fused)
3	USB-
4	USB-
5	USB+
6	USB+
7	Ground
8	Ground
9	Key
10	NC

JAUDIOF1: Front Panel Audio Header

This header allows user to connect the front audio output cable with the PC front panel. It will disable the output on back panel audio connectors.

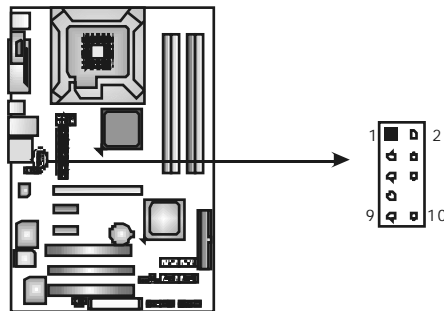

Pin	Assignment
1	Mic Left in
2	Ground
3	Mic Right in
4	GPIO
5	Right line in
6	Jack Sense
7	Front Sense
8	Key
9	Left line in
10	Jack Sense

JCDIN1: CD-ROM Audio-in Connector

This connector allows user to connect the audio source from the variety devices, like CD-ROM, DVD-ROM, PCI sound card, PCI TV turner card etc..

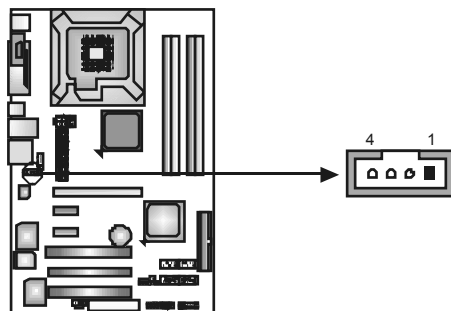

Pin	Assignment
1	Left Channel Input
2	Ground
3	Ground
4	Right Channel Input

JCMOS1: Clear CMOS Header

By placing the jumper on pin2-3, it allows user to restore the BIOS safe setting and the CMOS data, please carefully follow the procedures to avoid damaging the motherboard.

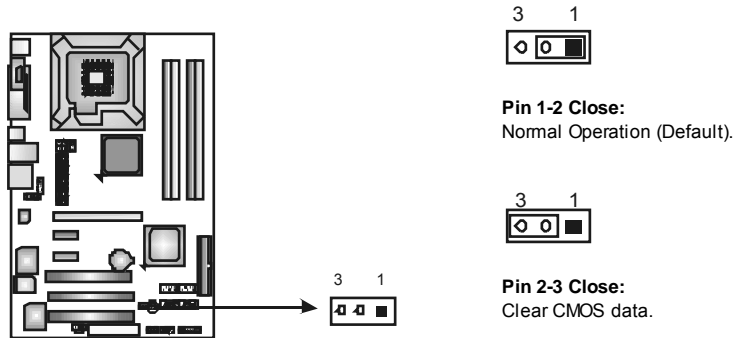

※ Clear CMOS Procedures:

1. Remove AC power line.
2. Set the jumper to "Pin 2-3 close".
3. Wait for five seconds.
4. Set the jumper to "Pin 1-2 close".
5. Power on the AC.
6. Reset your desired password or clear the CMOS data.

JCI1: Chassis Open Header (Optional)

This connector allows system to monitor PC case open status. If the signal has been triggered, it will record to the CMOS and show the message on next boot-up.

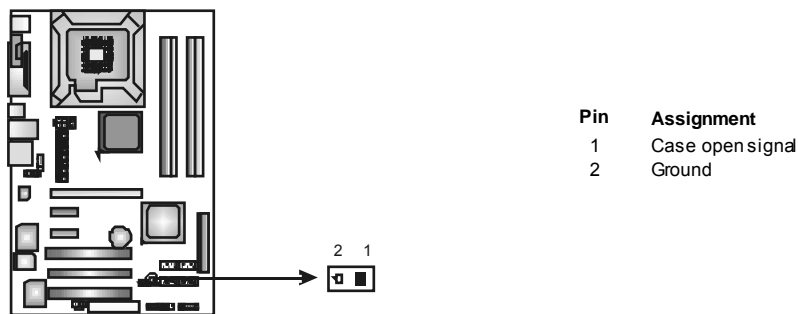

SATA1~SATA4: Serial ATA Connectors

The motherboard has a PCI to SATA Controller with 4channels SATA interface, it satisfies the SATA 2.0 spec and with transfer rate of 3Gb/s.

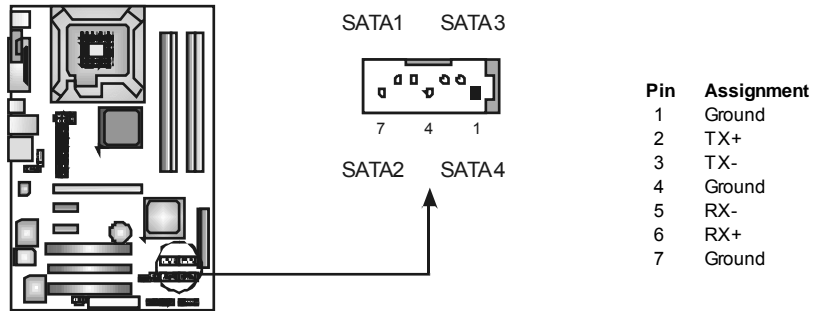

JSPDIF_OUT: Digital Audio out Connectors

This connector allows user to connect the PCI bracket SPDIF output header.

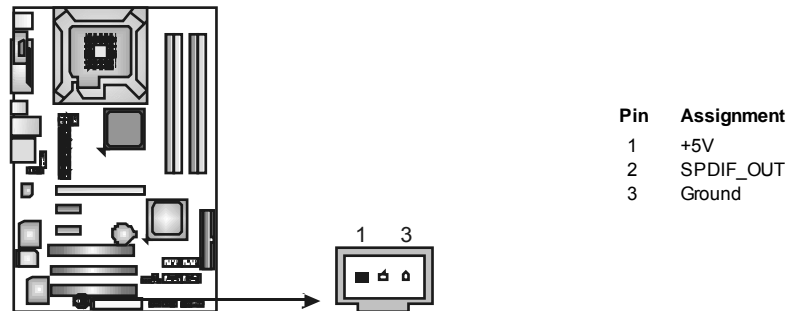

CHAPTER 4: USEFUL HELP

4.1 DRIVER INSTALLATION NOTE

After you installed your operating system, please insert the Fully Setup Driver CD into your optical drive and install the driver for better system performance.

You will see the following window after you insert the CD

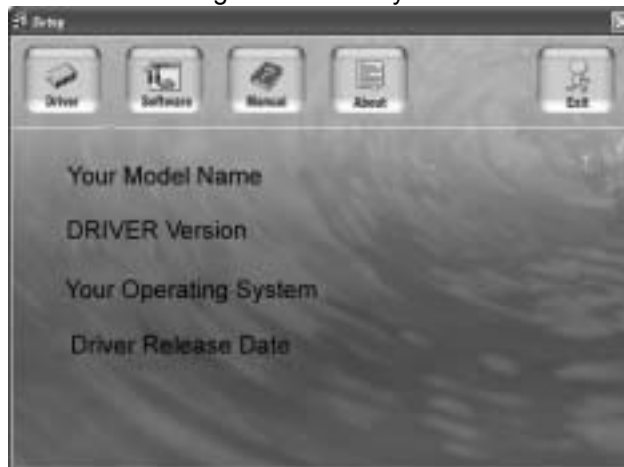

The setup guide will auto detect your motherboard and operating system.

Note:

If this window didn't show up after you insert the Driver CD, please use file browser to locate and execute the file **SETUP.EXE** under your optical drive.

A. Driver Installation

To install the driver, please click on the Driver icon. The setup guide will list the compatible driver for your motherboard and operating system. Click on each device driver to launch the installation program.

B. Software Installation

To install the software, please click on the Software icon. The setup guide will list the software available for your system, click on each software title to launch the installation program.

C. Manual

Aside from the paperback manual, we also provide manual in the Driver CD. Click on the Manual icon to browse for available manual.

Note:

You will need Acrobat Reader to open the manual file. Please download the latest version of Acrobat Reader software from <http://www.adobe.com/products/acrobat/readstep2.html>

4.2 AWARD BIOS BEEP CODE

Beep Sound	Meaning
One long beep followed by two short beeps	Video card not found or video card memory bad
High-low siren sound	CPU overheated System will shut down automatically
One Short beep when system boot-up	No error found during POST
Long beeps every other second	No DRAM detected or install

4.3 EXTRA INFORMATION

A. BIOS Update

After you fail to update BIOS or BIOS is invaded by virus, the Boot-Block function will help to restore BIOS. If the following message is shown after boot-up the system, it means the BIOS contents are corrupted.



In this Case, please follow the procedure below to restore the BIOS:

1. Make a bootable floppy disk.
2. Download the Flash Utility "AWDFLASH.exe" from the Biostar website: www.biostar.com.tw
3. Confirm motherboard model and download the respectively BIOS from Biostar website.
4. Copy "AWDFLASH.exe" and respectively BIOS into floppy disk.
5. Insert the bootable disk into floppy drive and press Enter.
6. System will boot-up to DOS prompt.
7. Type "Awdflash xxxx.bf/sn/py/r" in DOS prompt.
(xxxx means BIOS name.)
8. System will update BIOS automatically and restart.
9. The BIOS has been recovered and will work properly.

B. CPU Overheated

If the system shutdown automatically after power on system for seconds, that means the CPU protection function has been activated.

When the CPU is over heated, the motherboard will shutdown automatically to avoid a damage of the CPU, and the system may not power on again.

In this case, please double check:

1. The CPU cooler surface is placed evenly with the CPU surface.
2. CPU fan is rotated normally.
3. CPU fan speed is fulfilling with the CPU speed.

After confirmed, please follow steps below to relief the CPU protection function.

1. Remove the power cord from power supply for seconds.
2. Wait for seconds.
3. Plug in the power cord and boot up the system.

Or you can:

1. Clear the CMOS data.
(See "Close CMOS Header: JCMOS1" section)
2. Wait for seconds.
3. Power on the system again.

4.4 TROUBLESHOOTING

Probable	Solution
<ol style="list-style-type: none"> No power to the system at all. Power light don't illuminate, fan inside power supply does not turn on. Indicator light on key board does not turn on. 	<ol style="list-style-type: none"> Make sure power cable is securely plugged in. Replace cable. Contact technical support.
System inoperative. Keyboard lights are on, power indicator lights are lit, and hard drive is spinning.	Using even pressure on both ends of the DIMM, press down firmly until the module snaps into place.
System does not boot from hard disk drive, can be booted from optical drive.	<ol style="list-style-type: none"> Check cable running from disk to disk controller board. Make sure both ends are securely plugged in; check the drive type in the standard CMOS setup. Backing up the hard drive is extremely important. All hard disks are capable of breaking down at any time.
System only boots from optical drive. Hard disk can be read and applications can be used but booting from hard disk is impossible.	<ol style="list-style-type: none"> Back up data and applications files. Reformat the hard drive. Re-install applications and data using backup disks.
Screen message says "Invalid Configuration" or "CMOS Failure."	Review system's equipment. Make sure correct information is in setup.
Cannot boot system after installing second hard drive.	<ol style="list-style-type: none"> Set master/slave jumpers correctly. Run SETUP program and select correct drive types. Call the drive manufacturers for compatibility with other drives.

CHAPTER 5: WARPSPEEDER™



5.1 INTRODUCTION

[WarpSpeeder™], a new powerful control utility, features three user-friendly functions including Overclock Manager, Overvoltage Manager, and Hardware Monitor.

With the Overclock Manager, users can easily adjust the frequency they prefer or they can get the best CPU performance with just one click. The Overvoltage Manager, on the other hand, helps to power up CPU core voltage and Memory voltage. The cool Hardware Monitor smartly indicates the temperatures, voltage and CPU fan speed as well as the chipset information. Also, in the About panel, you can get detail descriptions about BIOS model and chipsets. In addition, the frequency status of CPU, memory, AGP and PCI along with the CPU speed are synchronically shown on our main panel.

Moreover, to protect users' computer systems if the setting is not appropriate when testing and results in system fail or hang, [WarpSpeeder™] technology assures the system stability by automatically rebooting the computer and then restart to a speed that is either the original system speed or a suitable one.

5.2 SYSTEM REQUIREMENT

OS Support: Windows 98 SE, Windows Me, Windows 2000, Windows XP
DirectX: DirectX 8.1 or above. (The Windows XP operating system includes DirectX 8.1. If you use Windows XP, you do not need to install DirectX 8.1.)

5.3 INSTALLATION

1. Execute the setup execution file, and then the following dialog will pop up. Please click “Next” button and follow the default procedure to install.



2. When you see the following dialog in setup procedure, it means setup is completed. If the “Launch the WarpSpeeder Tray Utility” checkbox is checked, the Tray Icon utility and [WarpSpeeder™] utility will be automatically and immediately launched after you click “Finish” button.



Usage:

The following figures are just only for reference, the screen printed in this user manual will change according to your motherboard on hand.

5.4 WARPSPEEDER™

1. Tray Icon:

Whenever the Tray Icon utility is launched, it will display a little tray icon on the right side of Windows Taskbar.

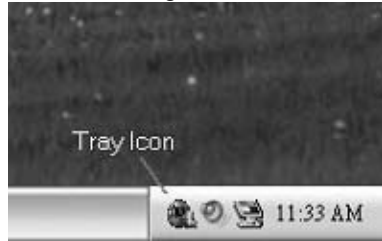

This utility is responsible for conveniently invoking [WarpSpeeder™] Utility. You can use the mouse by clicking the left button in order to invoke [WarpSpeeder™] directly from the little tray icon or you can right-click the little tray icon to pop up a popup menu as following figure. The "Launch Utility" item in the popup menu has the same function as mouse left-click on tray icon and "Exit" item will close Tray Icon utility if selected.



2. Main Panel

If you click the tray icon, [WarpSpeeder™] utility will be invoked.
Please refer to the following figure; the utility's first window you will see is Main Panel.

Main Panel contains features as follows:

- Display the CPU Speed, CPU external dock, Memory dock, AGP dock, and PCI dock information.
- Contains About, Voltage, Overclock, and Hardware Monitor Buttons for invoking respective panels.
- With a user-friendly Status Animation, it can represent 3 overclock percentage stages:

Man walking → overclock percentage from 100% ~ 110 %

Panther running → overclock percentage from 110% ~ 120%

Car racing → overclock percentage from 120% ~ above

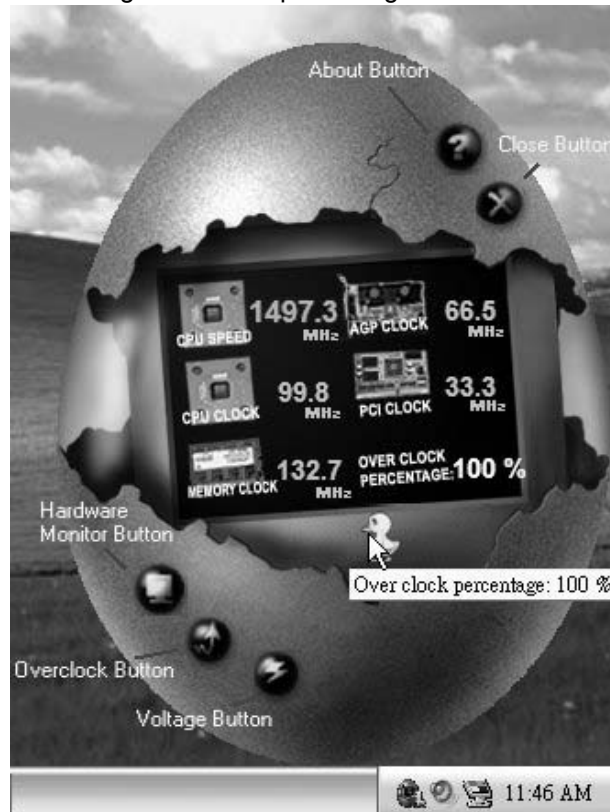

3. Voltage Panel

Click the Voltage button in Main Panel, the button will be highlighted and the Voltage Panel will slide out to up as the following figure. In this panel, you can decide to increase CPU core voltage and Memory voltage or not. The default setting is "No". If you want to get the best performance of overlocking, we recommend you dick the option "Yes".



4. Overclock Panel

Click the Overclock button in Main Panel, the button will be highlighted and the Overdock Panel will slide out to left as the following figure.



Overclock Panel contains the these features:

- a. “-3MHz button”, “-1MHz button”, “+1MHz button”, and “+3MHz button”:
provide user the ability to do real-time overclock adjustment.

Warning:

Manually overclock is potentially dangerous, especially when the overlocking percentage is over 110 %. We strongly recommend you verify every speed you overclock by click the Verify button. Or, you can just click Auto overlock button and let [WarpSpeeder™] automatically gets the best result for you.

- b. “Recovery Dialog button”: Pop up the following dialog. Let user select a restoring way if system need to do a fail-safe reboot.



- c. “Auto-overclock button”: User can click this button and [WarpSpeeder™] will set the best and stable performance and frequency automatically. [WarpSpeeder™] utility will execute a series of testing until system fail. Then system will do fail-safe reboot by using Watchdog function. After reboot, the [WarpSpeeder™] utility will restore to the hardware default setting or load the verified best and stable frequency according to the Recovery Dialog’s setting.
- d. “Verify button”: User can click this button and [WarpSpeeder™] will proceed a testing for current frequency. If the testing is ok, then the current frequency will be saved into system registry. If the testing fail, system will do a fail-safe rebooting. After reboot, the [WarpSpeeder™] utility will restore to the hardware default setting or load the verified best and stable frequency according to the Recovery Dialog’s setting.

Note:

Because the testing programs, invoked in Auto-overclock and Verify, include DirectDraw, Direct3D and DirectShow tests, the DirectX 8.1 or newer runtime library is required. And please make sure your display card’s color depth is High color (16 bit) or True color (24/32 bit) that is required for Direct3D rendering.

5. Hardware Monitor Panel

Click the Hardware Monitor button in Main Panel, the button will be highlighted and the Hardware Monitor panel will slide out to left as the following figure.

In this panel, you can get the real-time status information of your system. The information will be refreshed every 1 second.



6. About Panel

Click the “about” button in Main Panel, the button will be highlighted and the About Panel will slide out to up as the following figure. In this panel, you can get model name and detail information in hints of all the chipset that are related to overclocking. You can also get the mainboard’s BIOS model and the Version number of [WarpSpeeder™] utility.

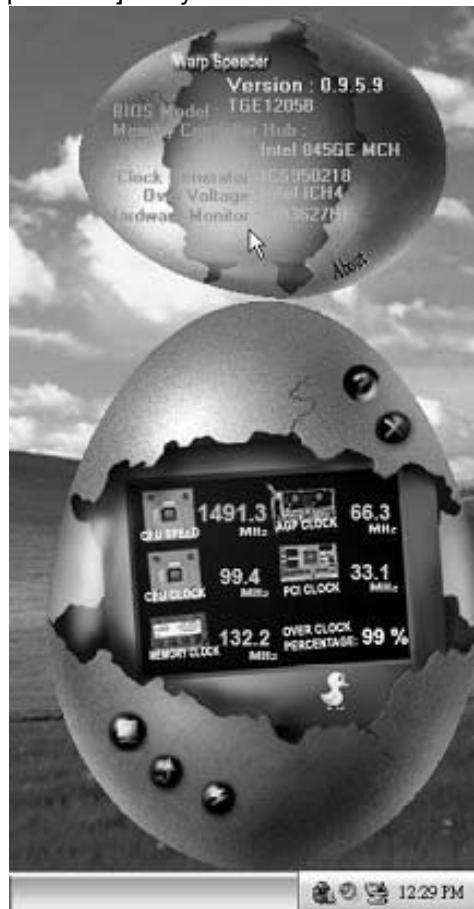

Note:

Because the overlock, overvoltage, and hardware monitor features are controlled by several separate chipset, [WarpSpeeder™] divide these features to separate panels. If one chipset is not on board, the correlative button in Main panel will be disabled, but will not interfere other panels’ functions. This property can make [WarpSpeeder™] utility more robust.

This page is intentionally left blank.

APPENDENCIES: SPEC IN OTHER LANGUAGE**GERMAN**

	<i>945P-A7B</i>	<i>945PL-A7B</i>
CPU	LGA 775 Intel Core2Duo / Pentium 4 / Pentium D / Celeron D Prozessoren mit bis zu 3,8 GHz Unterstützt Hyper-Threading Execute Disable Bit Enhanced Intel SpeedStep® Extended Memory 64 Technology	LGA 775 Intel Core2Duo / Pentium 4 / Pentium D / Celeron D Prozessoren mit bis zu 3,8 GHz Unterstützt Hyper-Threading Execute Disable Bit Enhanced Intel SpeedStep® Extended Memory 64 Technology
FSB	533 / 800 / 1066 MHz	533 / 800 / 1066 MHz
Chipsatz	Intel 945P Intel ICH7	Intel 945PL Intel ICH7
Super E/A	ITE 8712F Hardware-Überwachung Lüfterdrehzahl-Controller "Smart Guardian"-Funktion von ITE	ITE 8712F Hardware-Überwachung Lüfterdrehzahl-Controller "Smart Guardian"-Funktion von ITE
Arbeitsspeicher	DDR2 DIMM-Steckplätze x 4 Jeder DIMM unterstützt 128/256/512MB & 1GB DDR2 Max. 4GB Arbeitsspeicher Dual-Kanal DDR Speichermodul Unterstützt DDR2 533 / 667	DDR2 DIMM-Steckplätze x 2 Jeder DIMM unterstützt 256/512MB & 1GB DDR2 Max. 2GB Arbeitsspeicher Dual-Kanal DDR Speichermodul Unterstützt DDR2 400 / 533
IDE	Integrierter IDE-Controller Ultra DMA 33 / 66 / 100 Bus Master-Modus Unterstützt PIO-Modus 0~4	Integrierter IDE-Controller Ultra DMA 33 / 66 / 100 Bus Master-Modus Unterstützt PIO-Modus 0~4
SATA	Integrierter Serial ATA-Controller Datentransferrate bis zu 3.0Gb/s Konform mit der SATA-Spezifikation Version 2.0	Integrierter Serial ATA-Controller Datentransferrate bis zu 3.0Gb/s Konform mit der SATA-Spezifikation Version 2.0
LAN	Realtek 8100C 10 / 100 Mb/s Auto-Negotiation Halb-/ Voll duplex- Funktion	Realtek 8100C 10 / 100 Mb/s Auto-Negotiation Halb-/ Voll duplex- Funktion
Audio-Codec	ALC861VD(VER 6.X) / ALC888(VER 5.X) 5.1-Kanal-Audioausgabe (VER 6.X) 7.1-Kanal-Audioausgabe (VER 5.X) Unterstützt Intel High-Definition Audio	ALC861VD(VER 6.X) / ALC888(VER 5.X) 5.1-Kanal-Audioausgabe (VER 6.X) 7.1-Kanal-Audioausgabe (VER 5.X) Unterstützt Intel High-Definition Audio

945P-A7B/945PL-A7B

	945P-A7B		945PL-A7B	
Steckplätze	PCI Express x16 Steckplatz	x1	PCI Express x16 Steckplatz	x1
	PCI Express x1 Steckplatz	x2	PCI Express x1 Steckplatz	x2
	PCI-Steckplatz	x3	PCI-Steckplatz	x3
Onboard-Anschluss	Diskettenlaufwerkanschluss	x1	Diskettenlaufwerkanschluss	x1
	IDE-Anschluss	x1	IDE-Anschluss	x1
	SATA-Anschluss	x4	SATA-Anschluss	x4
	Fronttafelanschluss	x1	Fronttafelanschluss	x1
	Front-Audioanschluss	x1	Front-Audioanschluss	x1
	CD-IN-Anschluss	x1	CD-IN-Anschluss	x1
	S/PDIF Eingangsanschluss	x1	S/PDIF Eingangsanschluss	x1
	CPU-Lüfter-Sockel	x1	CPU-Lüfter-Sockel	x1
	System-Lüfter-Sockel	x1	System-Lüfter-Sockel	x1
	"Gehäuse offen"-Sockel (optional)	x1	"Gehäuse offen"-Sockel (optional)	x1
	"CMOS löschen"-Sockel	x1	"CMOS löschen"-Sockel	x1
	USB-Anschluss	x2	USB-Anschluss	x2
	Stromanschluss (24-polig)	x1	Stromanschluss (24-polig)	x1
Stromanschluss (4-polig)	x1	Stromanschluss (4-polig)	x1	
Rückseiten-E/A	PS/2-Tastatur	x1	PS/2-Tastatur	x1
	PS/2-Maus	x1	PS/2-Maus	x1
	Serieller Anschluss	x1	Serieller Anschluss	x1
	Druckeranschluss	x1	Druckeranschluss	x1
	LAN-Anschluss	x1	LAN-Anschluss	x1
	USB-Anschluss	x4	USB-Anschluss	x4
	Audioanschluss (Ver 6.x)	x3	Audioanschluss (Ver 6.x)	x3
	Audioanschluss (Ver 5.x)	x6	Audioanschluss (Ver 5.x)	x6
Platinengröße.	205 mm (B) X 305 mm (L)		205 mm (B) X 305 mm (L)	
OS-Unterstützung	Windows 2000 / XP / VISTA Biostar behält sich das Recht vor, ohne Ankündigung die Unterstützung für ein Betriebssystem hinzuzufügen oder zu entfernen.		Windows 2000 / XP / VISTA Biostar behält sich das Recht vor, ohne Ankündigung die Unterstützung für ein Betriebssystem hinzuzufügen oder zu entfernen.	

FRANCE

	<i>945P-A7B</i>	<i>945PL-A7B</i>
UC	LGA 775 Processeurs Intel Core2Duo / Pentium 4 / Pentium D / Celeron D jusqu'à 3,8 GHz Prend en charge les technologies Hyper-Threading d'exécution de bit de désactivation Intel SpeedStep® optimisée de mémoire étendue 64	LGA 775 Processeurs Intel Core2Duo / Pentium 4 / Pentium D / Celeron D jusqu'à 3,8 GHz Prend en charge les technologies Hyper-Threading d'exécution de bit de désactivation Intel SpeedStep® optimisée de mémoire étendue 64
Bus frontal	533 / 800 / 1066 MHz	533 / 800 / 1066 MHz
Chipset	Intel 945P Intel ICH7	Intel 945PL Intel ICH7
Super E/S	ITE 8712F Moniteur de matériel Contrôleur de vitesse de ventilateur Fonction "Gardien intelligent" de l'ITE	ITE 8712F Moniteur de matériel Contrôleur de vitesse de ventilateur Fonction "Gardien intelligent" de l'ITE
Mémoire principale	Fentes DDR2 DIMM x 4 Chaque DIMM prend en charge des DDR de 256/512 Mo et 1Go Capacité mémoire maximale de 4 Go Module de mémoire DDR à mode à double voie Prend en charge la DDR2 533 / 667	Fentes DDR2 DIMM x 2 Chaque DIMM prend en charge des DDR2 de 256/512 Mo et 1Go Capacité mémoire maximale de 2 Go Module de mémoire DDR à mode à double voie Prend en charge la DDR2 400 / 533
IDE	Contrôleur IDE intégré Mode principale de Bus Ultra DMA 33/ 66 / 100 Prend en charge le mode PIO 0~4,	Contrôleur IDE intégré Mode principale de Bus Ultra DMA 33/ 66 / 100 Prend en charge le mode PIO 0~4,
SATA	Contrôleur Serial ATA intégré : Taux de transfert jusqu'à 3.0 Go/s. Conforme à la spécification SATA Version 2.0	Contrôleur Serial ATA intégré : Taux de transfert jusqu'à 3.0 Go/s. Conforme à la spécification SATA Version 2.0
LAN	Realtek 8100C 10 / 100 Mb/s négociation automatique Half / Full duplex capability	Realtek 8100C 10 / 100 Mb/s négociation automatique Half / Full duplex capability
Codec audio	ALC861VD(VER 6.X) / ALC888(VER 5.X) Sortie audio à 5.1 voies (VER 6.X) Sortie audio à 7.1 voies (VER 5.X) Prise en charge de l'audio haute définition Intel	ALC861VD(VER 6.X) / ALC888(VER 5.X) Sortie audio à 5.1 voies (VER 6.X) Sortie audio à 7.1 voies (VER 5.X) Prise en charge de l'audio haute définition Intel

945P-A7B/945PL-A7B

	945P-A7B	945PL-A7B		
Fentes	Fente PCI Express x16	x1	Fente PCI Express x16	x1
	Fente PCI Express x1	x2	Fente PCI Express x1	x2
	Fente PCI	x3	Fente PCI	x3
Connecteur embarqué	Connecteur de disquette	x1	Connecteur de disquette	x1
	Connecteur IDE	x1	Connecteur IDE	x1
	Connecteur SATA	x4	Connecteur SATA	x4
	Connecteur du panneau avant	x1	Connecteur du panneau avant	x1
	Connecteur Audio du panneau avant	x1	Connecteur Audio du panneau avant	x1
	Connecteur d'entrée CD	x1	Connecteur d'entrée CD	x1
	Connecteur de sortie S/PDIF	x1	Connecteur de sortie S/PDIF	x1
	Embase de ventilateur UC	x1	Embase de ventilateur UC	x1
	Embase de ventilateur système	x1	Embase de ventilateur système	x1
	Embase d'ouverture de châssis (optional)		Embase d'ouverture de châssis (optional)	
	Embase d'effacement CMOS	x1	Embase d'effacement CMOS	x1
Connecteur USB	x2	Connecteur USB	x2	
Connecteur d'alimentation (24 broches)	x1	Connecteur d'alimentation (24 broches)	x1	
Connecteur d'alimentation (4 broches)	x1	Connecteur d'alimentation (4 broches)	x1	
E/S du panneau arrière	Clavier PS/2	x1	Clavier PS/2	x1
	Souris PS/2	x1	Souris PS/2	x1
	Port série	x1	Port série	x1
	Port d'imprimante	x1	Port d'imprimante	x1
	Port LAN	x1	Port LAN	x1
	Port USB	x4	Port USB	x4
	Fiche audio (Ver 6.x)	x3	Fiche audio (Ver 6.x)	x3
Fiche audio (Ver 5.x)	x6	Fiche audio (Ver 5.x)	x6	
Dimensions de la carte	205mm (L) X 305 mm (H)	205mm (L) X 305 mm (H)		
Support SE	Windows 2000 / XP / VISTA Biostar se réserve le droit d'ajouter ou de supprimer le support de SE avec ou sans préavis.	Windows 2000 / XP / VISTA Biostar se réserve le droit d'ajouter ou de supprimer le support de SE avec ou sans préavis.		

	<i>945P-A7B</i>	<i>945PL-A7B</i>
CPU	LGA 775 Processore Intel Core2Duo / Pentium 4 / Pentium D / Celeron D fino a 3.8 GHz Supporto di Hyper-Threading Execute Disable Bit Enhanced Intel SpeedStep® Tecnologia Extended Memory 64	LGA 775 Processore Intel Core2Duo / Pentium 4 / Pentium D / Celeron D fino a 3.8 GHz Supporto di Hyper-Threading Execute Disable Bit Enhanced Intel SpeedStep® Tecnologia Extended Memory 64
FSB	533 / 800 / 1066 MHz	533 / 800 / 1066 MHz
Chipset	Intel 945P Intel ICH7	Intel 945PL Intel ICH7
Super I/O	ITE 8712F Monitoraggio hardware Controller velocità ventolina Funzione "Smart Guardian" di ITE	ITE 8712F Monitoraggio hardware Controller velocità ventolina Funzione "Smart Guardian" di ITE
Memoria principale	Alloggi DIMM DDR 2 x 4 Ciascun DIMM supporta DDR2 256/512MB e 1GB Capacità massima della memoria 4GB Modulo di memoria DDR a canale doppio Supporto di DDR2 533 / 667	Alloggi DIMM DDR 2 x 2 Ciascun DIMM supporta DDR2 256/512MB e 1GB Capacità massima della memoria 2GB Modulo di memoria DDR a canale doppio Supporto di DDR2 400 / 533
IDE	Controller IDE integrato Modalità Bus Master Ultra DMA 33 / 66 / 100 Supporto modalità PIO Mode 0-4	Controller IDE integrato Modalità Bus Master Ultra DMA 33 / 66 / 100 Supporto modalità PIO Mode 0-4
SATA	Controller Serial ATA integrato Velocità di trasferimento dei dati fino a 3.0 Gb/s. Compatibile specifiche SATA Versione 2.0.	Controller Serial ATA integrato Velocità di trasferimento dei dati fino a 3.0 Gb/s. Compatibile specifiche SATA Versione 2.0.
LAN	Realtek 8100C Negoziazione automatica 10 / 100 Mb/s Capacità Half / Full Duplex	Realtek 8100C Negoziazione automatica 10 / 100 Mb/s Capacità Half / Full Duplex
Codec audio	ALC861VD(VER 6.X) / ALC888(VER 5.X) Uscita audio 5.1 canali (VER 6.X) Uscita audio 7.1 canali (VER 5.X) Supporto audio High-Definition (HD) Intel	ALC861VD(VER 6.X) / ALC888(VER 5.X) Uscita audio 5.1 canali (VER 6.X) Uscita audio 7.1 canali (VER 5.X) Supporto audio High-Definition (HD) Intel

945P-A7B/945PL-A7B

	945P-A7B		945PL-A7B	
Alloggi	Alloggio PCI Express x16	x1	Alloggio PCI Express x16	x1
	Alloggio PCI Express x1	x2	Alloggio PCI Express x1	x2
	Alloggio PCI	x3	Alloggio PCI	x3
Connettori su scheda	Connettore floppy	x1	Connettore floppy	x1
	Connettore IDE	x1	Connettore IDE	x1
	Connettore SATA	x4	Connettore SATA	x4
	Connettore pannello frontale	x1	Connettore pannello frontale	x1
	Connettore audio frontale	x1	Connettore audio frontale	x1
	Connettore CD-in	x1	Connettore CD-in	x1
	Connettore output SPDIF	x1	Connettore output SPDIF	x1
	Collettore ventolina CPU	x1	Collettore ventolina CPU	x1
	Collettore ventolina sistema	x1	Collettore ventolina sistema	x1
	Collettore apertura telaio (optional)	x1	Collettore apertura telaio (optional)	x1
	Collettore cancellazione CMOS	x1	Collettore cancellazione CMOS	x1
	Connettore USB	x2	Connettore USB	x2
	Connettore alimentazione (24 pin)	x1	Connettore alimentazione (24 pin)	x1
Connettore alimentazione (4 pin)	x1	Connettore alimentazione (4 pin)	x1	
I/O pannello posteriore	Tastiera PS/2	x1	Tastiera PS/2	x1
	Mouse PS/2	x1	Mouse PS/2	x1
	Porta seriale	x1	Porta seriale	x1
	Porta stampante	x1	Porta stampante	x1
	Porta LAN	x1	Porta LAN	x1
	Porta USB	x4	Porta USB	x4
	Connettore audio (Ver 6.x)	x3	Connettore audio (Ver 6.x)	x3
Connettore audio (Ver 5.x)	x6	Connettore audio (Ver 5.x)	x6	
Dimensioni scheda	205 mm (larghezza) x 305 mm (altezza)		205 mm (larghezza) x 305 mm (altezza)	
Sistemi operativi supportati	Windows 2000 / XP / VISTA Biostar si riserva il diritto di aggiungere o rimuovere il supporto di qualsiasi sistema operativo senza preavviso.		Windows 2000 / XP / VISTA Biostar si riserva il diritto di aggiungere o rimuovere il supporto di qualsiasi sistema operativo senza preavviso.	

SPANISH

	<i>945P-A7B</i>	<i>945PL-A7B</i>
CPU	LGA 775 Procesador Intel Core2Duo / Pentium 4 / Pentium D / Celeron D hasta 3,8 GHz Admite Hyper-Threading Bit de deshabilitación de ejecución Intel SpeedStep® Mejorado Tecnología Extended Memory 64	LGA 775 Procesador Intel Core2Duo / Pentium 4 / Pentium D / Celeron D hasta 3,8 GHz Admite Hyper-Threading Bit de deshabilitación de ejecución Intel SpeedStep® Mejorado Tecnología Extended Memory 64
FSB	533 / 800 / 1066 MHz	533 / 800 / 1066 MHz
Conjunto de chips	Intel 945P Intel ICH7	Intel 945PL Intel ICH7
Súper E/S	ITE 8712F Monitor hardware Controlador de velocidad de ventilador Función "Guardia inteligente" de ITE	ITE 8712F Monitor hardware Controlador de velocidad de ventilador Función "Guardia inteligente" de ITE
Memoria principal	Ranuras DIMM DDR 2 x 4 Cada DIMM admite DDR 2 de 256/512MB y 1GB Capacidad máxima de memoria de 4GB Módulo de memoria DDR de canal Doble Admite DDR2 533 / 667	Ranuras DIMM DDR 2 x 2 Cada DIMM admite DDR 2 de 256/512MB y 1GB Capacidad máxima de memoria de 2GB Módulo de memoria DDR de canal Doble Admite DDR2 de 400 / 533
IDE	Controlador IDE integrado Modo bus maestro Ultra DMA 33 / 66 / 100 Soporte los Modos PIO 0~4.	Controlador IDE integrado Modo bus maestro Ultra DMA 33 / 66 / 100 Soporte los Modos PIO 0~4.
SATA	Controlador ATA Serie Integrado Tasas de transferencia de hasta 3.0 Gb/s. Compatible con la versión SATA 2.0.	Controlador ATA Serie Integrado Tasas de transferencia de hasta 3.0 Gb/s. Compatible con la versión SATA 2.0.
Red Local	Realtek 8100C Negociación de 10 / 100 Mb/s Funciones Half / Full dúplex	Realtek 8100C Negociación de 10 / 100 Mb/s Funciones Half / Full dúplex
Códecs de sonido	ALC861VD(VER 6.X) / ALC888(VER 5.X) Salida de sonido de 5.1 canales (VER 6.X) Salida de sonido de 7.1 canales (VER 5.X) Soporte de sonido Intel de Alta Definición	ALC861VD(VER 6.X) / ALC888(VER 5.X) Salida de sonido de 5.1 canales (VER 6.X) Salida de sonido de 7.1 canales (VER 5.X) Soporte de sonido Intel de Alta Definición

945P-A7B/945PL-A7B

	945P-A7B		945PL-A7B	
Ranuras	Ranura PCI Express x16	x1	Ranura PCI Express x16	x1
	Ranura PCI Express x1	x2	Ranura PCI Express x1	x2
	Ranura PCI	X3	Ranura PCI	X3
Conectores en placa	Conector disco flexible	X1	Conector disco flexible	X1
	Conector IDE	X1	Conector IDE	X1
	Conector SATA	X4	Conector SATA	X4
	Conector de panel frontal	X1	Conector de panel frontal	X1
	Conector de sonido frontal	X1	Conector de sonido frontal	X1
	Conector de entrada de CD	X1	Conector de entrada de CD	X1
	Conector de salida S/PDIF	X1	Conector de salida S/PDIF	X1
	Cabecera de ventilador de CPU	X1	Cabecera de ventilador de CPU	X1
	Cabecera de ventilador de sistema	X1	Cabecera de ventilador de sistema	X1
	Cabecera de chasis abierto(opcional)	X1	Cabecera de chasis abierto(opcional)	X1
	Cabecera de borrado de CMOS	X1	Cabecera de borrado de CMOS	X1
	Conector USB	X2	Conector USB	X2
	Conector de alimentación (24 patillas)	X1	Conector de alimentación (24 patillas)	X1
Conector de alimentación (4 patillas)	X1	Conector de alimentación (4 patillas)	X1	
Panel trasero de E/S	Teclado PS/2	X1	Teclado PS/2	X1
	Ratón PS/2	X1	Ratón PS/2	X1
	Puerto serie	X1	Puerto serie	X1
	Puerto de impresora	X1	Puerto de impresora	X1
	Puerto de red local	X1	Puerto de red local	X1
	Puerto USB	X4	Puerto USB	X4
	Conector de sonido (Ver 6.x)	X3	Conector de sonido (Ver 6.x)	X3
Conector de sonido (Ver 5.x)	X6	Conector de sonido (Ver 5.x)	X6	
Tamaño de la placa	205 mm. (A) X 305 mm. (H)		205 mm. (A) X 305 mm. (H)	
Soporte de sistema operativo	Windows 2000 / XP / VISTA Biostar se reserva el derecho de añadir o retirar el soporte de cualquier SO con o sin aviso previo.		Windows 2000 / XP / VISTA Biostar se reserva el derecho de añadir o retirar el soporte de cualquier SO con o sin aviso previo.	

PORTUGUESE

	<i>945P-A7B</i>	<i>945PL-A7B</i>
CPU	LGA 775 Processador Intel Core2Duo / Pentium 4 / Pentium D / Celeron D até 3,8 GHz Suporta as tecnologias Hyper-Threading Execute Disable Bit Enhanced Intel SpeedStep® Extended Memory 64	LGA 775 Processador Intel Core2Duo / Pentium 4 / Pentium D / Celeron D até 3,8 GHz Suporta as tecnologias Hyper-Threading Execute Disable Bit Enhanced Intel SpeedStep® Extended Memory 64
FSB	533 / 800 / 1066 MHz	533 / 800 / 1066 MHz
Chipset	Intel 945P Intel ICH7	Intel 945PL Intel ICH7
Especificação Super I/O	ITE 8712F Monitorização do hardware Controlador da velocidade da ventoinha Função "Smart Guardian" da ITE	ITE 8712F Monitorização do hardware Controlador da velocidade da ventoinha Função "Smart Guardian" da ITE
Memória principal	Ranuras DIMM DDR2 x4 Cada módulo DIMM suporta uma memória DDR2 de 256/512 MB & 1 GB Capacidade máxima de memória: 4 GB Módulo de memória DDR de canal duplo Suporta módulos DDR2 533 /667	Ranuras DIMM DDR2 x2 Cada módulo DIMM suporta uma memória DDR2 de 256/512 MB & 1 GB Capacidade máxima de memória: 2 GB Módulo de memória DDR de canal duplo Suporta módulos DDR2 400 / 533
IDE	Controlador IDE integrado Modo Bus master Ultra DMA 33 / 66 / 100 Suporta o modo PIO 0~4.	Controlador IDE integrado Modo Bus master Ultra DMA 33 / 66 / 100 Suporta o modo PIO 0~4.
SATA	Controlador Serial ATA integrado Velocidades de transmissão de dados até 3.0 Gb/s. Compatibilidade com a especificação SATA versão 2.0.	Controlador Serial ATA integrado Velocidades de transmissão de dados até 3.0 Gb/s. Compatibilidade com a especificação SATA versão 2.0.
LAN	Realtek 8100C Auto negociação de 10 / 100 Mb/s Capacidade semi/full-duplex	Realtek 8100C Auto negociação de 10 / 100 Mb/s Capacidade semi/full-duplex
Codec de som	ALC861VD(VER 6.X) / ALC888(VER 5.X) Saída de áudio de 5.1 canais (VER 6.X) Saída de áudio de 7.1 canais (VER 5.X) Suporta a especificação Intel High-Definition Audio	ALC861VD(VER 6.X) / ALC888(VER 5.X) Saída de áudio de 5.1 canais (VER 6.X) Saída de áudio de 7.1 canais (VER 5.X) Suporta a especificação Intel High-Definition Audio

	945P-A7B		945PL-A7B	
Ranhuras	Ranhura PCI Express x 16	x1	Ranhura PCI Express x 16	x1
	Ranhura PCI Express x 1	x2	Ranhura PCI Express x 1	x2
	Ranhura PCI	x3	Ranhura PCI	x3
Conectores na placa	Conector da unidade de disquetes	x1	Conector da unidade de disquetes	x1
	Conector IDE	x1	Conector IDE	x1
	Conector SATA	x4	Conector SATA	x4
	Conector do painel frontal	x1	Conector do painel frontal	x1
	Conector de áudio frontal	x1	Conector de áudio frontal	x1
	Conector para entrada de CDs	x1	Conector para entrada de CDs	x1
	Conector de saída S/PDIF	x1	Conector de saída S/PDIF	x1
	Conector da ventoinha da CPU	x1	Conector da ventoinha da CPU	x1
	Conector da ventoinha do sistema	x1	Conector da ventoinha do sistema	x1
	Conector para detecção da abertura do chassis (opcional)	x1	Conector para detecção da abertura do chassis (opcional)	x1
	Conector para limpeza do CMOS	x1	Conector para limpeza do CMOS	x1
	Conector USB	x2	Conector USB	x2
	Conector de alimentação (24 pinos)	x1	Conector de alimentação (24 pinos)	x1
	Conector de alimentação (4 pinos)	x1	Conector de alimentação (4 pinos)	x1
Entradas/ Saídas no painel traseiro	Teclado PS/2	x1	Teclado PS/2	x1
	Rato PS/2	x1	Rato PS/2	x1
	Porta série	x1	Porta série	x1
	Porta para impressora	x1	Porta para impressora	x1
	Porta LAN	x1	Porta LAN	x1
	Porta USB	x4	Porta USB	x4
	Tomada de áudio (Ver 6.x)	x3	Tomada de áudio (Ver 6.x)	x3
Tomada de áudio (Ver 5.x)	x6	Tomada de áudio (Ver 5.x)	x6	
Tamanho da placa	205 mm (L) X 305 mm (A)		205 mm (L) X 305 mm (A)	
Sistemas operativos suportados	Windows 2000 / XP / VISTA A Biostar reserva-se o direito de adicionar ou remover suporte para qualquer sistema operativo com ou sem aviso prévio.		Windows 2000 / XP / VISTA A Biostar reserva-se o direito de adicionar ou remover suporte para qualquer sistema operativo com ou sem aviso prévio.	

POLISH

	<i>945P-A7B</i>	<i>945PL-A7B</i>
Procesor	LGA 775 Procesor Intel Core2Duo / Pentium 4 / Pentium D / Celeron D do 3,8 GHz Obsługa Hyper-Threading Execute Disable Bit Enhanced Intel SpeedStep® Extended Memory 64 Technology	LGA 775 Procesor Intel Core2Duo / Pentium 4 / Pentium D / Celeron D do 3,8 GHz Obsługa Hyper-Threading Execute Disable Bit Enhanced Intel SpeedStep® Extended Memory 64 Technology
FSB	533 / 800 / 1066 MHz	533 / 800 / 1066 MHz
Chipset	Intel 945P Intel ICH7	Intel 945PL Intel ICH7
Pamięć główna	Gniazda DDR 2 DIMM x 4 Każde gniazdo DIMM obsługuje moduły 256/512MB oraz 1GB DDR 2 Maks. wielkość pamięci 4GB Moduł pamięci DDR z trybem podwójnego kanału Obsługa DDR2 533 / 667	Gniazda DDR 2 DIMM x 2 Każde gniazdo DIMM obsługuje moduły 256/512MB oraz 1GB DDR 2 Maks. wielkość pamięci 2GB Moduł pamięci DDR z trybem podwójnego kanału Obsługa DDR2 400 / 533
Super I/O	ITE 8712F Monitor H/W Kontroler prędkości wentylatora Funkcja ITE "Smart Guardian"	ITE 8712F Monitor H/W Kontroler prędkości wentylatora Funkcja ITE "Smart Guardian"
IDE	Zintegrowany kontroler IDE Ultra DMA 33 / 66 / 100 Tryb Bus Master obsługa PIO tryb 0~4	Zintegrowany kontroler IDE Ultra DMA 33 / 66 / 100 Tryb Bus Master obsługa PIO tryb 0~4
SATA	Zintegrowany kontroler Serial ATA Transfer danych do 3.0 Gb/s. Zgodność ze specyfikacją SATA w wersji 2.0.	Zintegrowany kontroler Serial ATA Transfer danych do 3.0 Gb/s. Zgodność ze specyfikacją SATA w wersji 2.0.
LAN	Realtek 8100C 10 / 100 Mb/s z automatyczną negocjacją szybkości Działanie w trybie połowicznego / pełnego dupleksu	Realtek 8100C 10 / 100 Mb/s z automatyczną negocjacją szybkości Działanie w trybie połowicznego / pełnego dupleksu
Kodek dźwiękowy	ALC861VD(VER 6.X) / ALC888(VER 5.X) 5.1 kanałowe wyjście audio (VER 6.X) 7.1 kanałowe wyjście audio (VER 5.X) Obsługa Intel High-Definition Audio	ALC861VD(VER 6.X) / ALC888(VER 5.X) 5.1 kanałowe wyjście audio (VER 6.X) 7.1 kanałowe wyjście audio (VER 5.X) Obsługa Intel High-Definition Audio

	945P-A7B		945PL-A7B	
Gniazda	Gniazdo PCI Express x16	x1	Gniazdo PCI Express x16	x1
	Gniazdo PCI Express x1	x2	Gniazdo PCI Express x1	x2
	Gniazdo PCI	x3	Gniazdo PCI	x3
Złącza wbudowane	Złącze napędu dyskietek	x1	Złącze napędu dyskietek	x1
	Złącze IDE	x1	Złącze IDE	x1
	Złącze SATA	x4	Złącze SATA	x4
	Złącze panela przedniego	x1	Złącze panela przedniego	x1
	Przednie złącze audio	x1	Przednie złącze audio	x1
	Złącze wejścia CD	x1	Złącze wejścia CD	x1
	Złącze wyjścia S/PDIF	x1	Złącze wyjścia S/PDIF	x1
	Złącze główkowe wentylatora procesora	x1	Złącze główkowe wentylatora procesora	x1
	Złącze główkowe wentylatora systemowego	x1	Złącze główkowe wentylatora systemowego	x1
	Złącze główkowe otwarcia obudowy (opcja)	x1	Złącze główkowe otwarcia obudowy (opcja)	x1
	Złącze główkowe kasowania CMOS	x1	Złącze główkowe kasowania CMOS	x1
Złącze USB	x2	Złącze USB	x2	
Złącze zasilania (24 pinowe)	x1	Złącze zasilania (24 pinowe)	x1	
Złącze zasilania (4 pinowe)	x1	Złącze zasilania (4 pinowe)	x1	
Back Panel I/O	Klawiatura PS/2	x1	Klawiatura PS/2	x1
	Mysz PS/2	x1	Mysz PS/2	x1
	Port szeregowy	x1	Port szeregowy	x1
	Port drukarki	x1	Port drukarki	x1
	Port LAN	x1	Port LAN	x1
	Port USB	x4	Port USB	x4
	Gniazdo audio (Ver 6.x)	x3	Gniazdo audio (Ver 6.x)	x3
Gniazdo audio (Ver 5.x)	x6	Gniazdo audio (Ver 5.x)	x6	
Wymiary płyty	205 mm (S) X 305 mm (W)		205 mm (S) X 305 mm (W)	
Obsługa systemu operacyjnego	Windows 2000 / XP / VISTA Biostar zastrzega sobie prawo do dawania lub odwoływania obsługi dowolnego systemu operacyjnego bez powiadomienia.		Windows 2000 / XP / VISTA Biostar zastrzega sobie prawo do dawania lub odwoływania obsługi dowolnego systemu operacyjnego bez powiadomienia.	

RUSSIAN

	945P-A7B	945PL-A7B
CPU (центральный процессор)	LGA 775 Процессор Intel Core2Duo / Pentium 4 / Pentium D / Celeron D до 3.8 ГГц Поддержка технологий Hyper-Threading Execute Disable Bit Enhanced Intel SpeedStep® Extended Memory 64 Technology	LGA 775 Процессор Intel Core2Duo / Pentium 4 / Pentium D / Celeron D до 3.8 ГГц Поддержка технологий Hyper-Threading Execute Disable Bit Enhanced Intel SpeedStep® Extended Memory 64 Technology
FSB	533 / 800 / 1066 МГц	533 / 800 / 1066 МГц
Набор микросхем	Intel 945P Intel ICH7	Intel 945PL Intel ICH7
Основная память	Слоты DDR2 DIMM x 4 Каждый модуль DIMM поддерживает 128/256/512МБ & 1ГБ DDR2 Максимальная ёмкость памяти 4 ГБ Модуль памяти с двухканальным режимом DDR Поддержка DDR2 533 / 667	Слоты DDR2 DIMM x 2 Каждый модуль DIMM поддерживает 128/256/512МБ & 1ГБ DDR2 Максимальная ёмкость памяти 2 ГБ Модуль памяти с двухканальным режимом DDR Поддержка DDR2 400 / 533
Super I/O	ITE 8712F Аппаратный монитор Регулятор скорости Функция ITE "Smart Guardian" (Интеллектуальная защита)	ITE 8712F Аппаратный монитор Регулятор скорости Функция ITE "Smart Guardian" (Интеллектуальная защита)
IDE	Встроенное устройство управления встроенными интерфейсами устройств Режим "хозяина" шины Ultra DMA 33 / 66 / 100 Поддержка режима PIO 0~4,	Встроенное устройство управления встроенными интерфейсами устройств Режим "хозяина" шины Ultra DMA 33 / 66 / 100 Поддержка режима PIO 0~4,
SATA	Встроенное последовательное устройство управления ATA скорость передачи данных до 3.0 гигабит/с. Соответствие спецификации SATA версия 2.0.	Встроенное последовательное устройство управления ATA скорость передачи данных до 3.0 гигабит/с. Соответствие спецификации SATA версия 2.0.
Локальная сеть	Realtek 8100C Автоматическое согласование 10 / 100 Мб/с Частичная / полная дуплексная способность	Realtek 8100C Автоматическое согласование 10 / 100 Мб/с Частичная / полная дуплексная способность
Звуковой кодек	ALC861VD(VER 6.X) / ALC888(VER 5.X) 5.1канальный звуковой выход (VER 6.X) 7.1канальный звуковой выход (VER 5.X) Звуковая поддержка Intel High-Definition	ALC861VD(VER 6.X) / ALC888(VER 5.X) 5.1канальный звуковой выход (VER 6.X) 7.1канальный звуковой выход (VER 5.X) Звуковая поддержка Intel High-Definition

	945P-A7B		945PL-A7B	
Слоты	Слот PCI Express x16	x1	Слот PCI Express x16	x1
	Слот PCI Express x1	x2	Слот PCI Express x1	x2
	Слот PCI	x3	Слот PCI	x3
Встроенный разъем	Разъем НГМД	x1	Разъем НГМД	x1
	Разъем IDE	x1	Разъем IDE	x1
	Разъем SATA	x4	Разъем SATA	x4
	Разъем на лицевой панели	x1	Разъем на лицевой панели	x1
	Входной звуковой разъем	x1	Входной звуковой разъем	x1
	Разъем ввода для CD	x1	Разъем ввода для CD	x1
	Разъем вывода для S/PDIF	x1	Разъем вывода для S/PDIF	x1
	Контактирующее приспособление вентилятора центрального процессора	x1	Контактирующее приспособление вентилятора центрального процессора	x1
	Контактирующее приспособление вентилятора системы	x1	Контактирующее приспособление вентилятора системы	x1
	Шасси открытого контактирующего приспособления (дополнительно)	x1	Шасси открытого контактирующего приспособления (дополнительно)	x1
	Открытое контактирующее приспособление CMOS	x1	Открытое контактирующее приспособление CMOS	x1
	USB-разъем	x2	USB-разъем	x2
Разъем питания (24 вывод)	x1	Разъем питания (24 вывод)	x1	
Разъем питания (4 вывод)	x1	Разъем питания (4 вывод)	x1	
Задняя панель средств ввода-вывода	Клавиатура PS/2	x1	Клавиатура PS/2	x1
	Мышь PS/2	x1	Мышь PS/2	x1
	Последовательный порт	x1	Последовательный порт	x1
	Порт подключения принтера	x1	Порт подключения принтера	x1
	Порт LAN	x1	Порт LAN	x1
	USB-порт	x4	USB-порт	x4
	Гнездо для подключения наушников (Ver 6.x)	x3	Гнездо для подключения наушников (Ver 6.x)	x3
Гнездо для подключения наушников (Ver 5.x)	x6	Гнездо для подключения наушников (Ver 5.x)	x6	
Размер панели	205 мм (Ш) X 305 мм (В)		205 мм (Ш) X 305 мм (В)	
Поддержка OS	Windows 2000 / XP / VISTA Biostar сохраняет за собой право добавлять или удалять средства обеспечения для OS с или без предварительного уведомления.		Windows 2000 / XP / VISTA Biostar сохраняет за собой право добавлять или удалять средства обеспечения для OS с или без предварительного уведомления.	

ARABIC

945PL-A7B	945P-A7B	
LGA 775 Intel Core2Duo / Pentium 4 / Pentium D / Celeron D جيجا 3.8 بتردد يصل إلى 3.8 جيجا هرتز Hyper-Threading تدعم تقنيات Execute Disable Bit Enhanced Intel SpeedStep® Extended Memory 64 Technology	LGA 775 Intel Core2Duo / Pentium 4 / Pentium D / Celeron D جيجا 3.8 بتردد يصل إلى 3.8 جيجا هرتز Hyper-Threading تدعم تقنيات Execute Disable Bit Enhanced Intel SpeedStep® Extended Memory 64 Technology	وحدة المعالجة المركزية
ميغا هرتز 533 / 800 / 1066 تردد	ميغا هرتز 533 / 800 / 1066 تردد	الناقل الأمامي الجانبية
Intel 945PL Intel ICH7	Intel 945P Intel ICH7	مجموعة الشرائح
فتحة DDR2 DIMM عدد 2 سعة DDR2 تدعم ذاكرة من نوع DIMM تدعم كل فتحة ميغا بايت 1 و 256/512 جيجا بايت سعة ذاكرة قصوى 2 جيجا بايت أحادية/مزدوجة لفتحة DDR وحدة ذاكرة ميغا بايت 400 / 533 / 667 سعات DDR تدعم الذاكرة من نوع	فتحة DDR2 DIMM عدد 4 سعة DDR2 تدعم ذاكرة من نوع DIMM تدعم كل فتحة ميغا بايت 1 و 256/512 جيجا بايت سعة ذاكرة قصوى 4 جيجا بايت أحادية/مزدوجة لفتحة DDR وحدة ذاكرة ميغا بايت 533 / 667 سعات DDR تدعم الذاكرة من نوع	الذاكرة الرئيسية
ITE 8712F مراقب لمعرفة حالة الأجهزة مراقب في سرعة المروحة ITE من "Smart Guardian" وظيفة	ITE 8712F مراقب لمعرفة حالة الأجهزة مراقب في سرعة المروحة ITE من "Smart Guardian" وظيفة	Super I/O
متكامل IDE متحكم Ultra DMA 33 / 66 / 100 ناقل ب تقنية وضع رئيسي PIO Mode 0~4 دعم وضع	متكامل IDE متحكم Ultra DMA 33 / 66 / 100 ناقل ب تقنية وضع رئيسي PIO Mode 0~4 دعم وضع	منفذ IDE
متكامل Serial ATA متحكم نقل البيانات بسرعات تصل إلى 3.0 جيجا بايت/ثانية. 2.0 الإصدار SATA مطابقة لمواصفات	متكامل Serial ATA متحكم نقل البيانات بسرعات تصل إلى 3.0 جيجا بايت/ثانية. 2.0 الإصدار SATA مطابقة لمواصفات	SATA
Realtek 8100C تفاوض تلقائي 100/10 ميغا بايت / ثانية إمكانية النقل المزدوج الكامل/النصفي	Realtek 8100C تفاوض تلقائي 100/10 ميغا بايت / ثانية إمكانية النقل المزدوج الكامل/النصفي	شبكة داخلية 100/10

945P-A7B/945PL-A7B

945PL-A7B		945P-A7B			
ALC861VD(VER 6.X) / ALC888(VER 5.X) 5.1 قنوات لخرج الصوت (VER 6.X) 7.1 قنوات لخرج الصوت (VER 5.X) Intel دعم تقنية الصوت علي التعريف من		ALC861VD(VER 6.X) / ALC888(VER 5.X) 5.1 قنوات لخرج الصوت (VER 6.X) 7.1 قنوات لخرج الصوت (VER 5.X) Intel دعم تقنية الصوت علي التعريف من		كوديك الصوت	
عدد 1	فتحة PCI Expressx16	عدد 1	فتحة PCI Expressx16	الفتحات	
عدد 2	فتحة PCI Expressx1	عدد 2	فتحة PCI Expressx1		
عدد 3	فتحة PCI	عدد 3	فتحة PCI		
عدد 1	مقذ محرك أقراص مرنة	عدد 1	مقذ محرك أقراص مرنة	المنافذ على سطح اللوحة	
عدد 1	مقذ IDE	عدد 1	مقذ IDE		
عدد 4	مقذ SATA	عدد 4	مقذ SATA		
عدد 1	مقذ اللوحة الأممية	عدد 1	مقذ اللوحة الأممية		
عدد 1	مقذ الصوت الأممي	عدد 1	مقذ الصوت الأممي		
عدد 1	مقذ CD-IN	عدد 1	مقذ CD-IN		
عدد 1	مقذ خرج S/PDIF	عدد 1	مقذ خرج S/PDIF		
عدد 1	وصلة مروحة وحدة المعالجة المركزية	عدد 1	وصلة مروحة وحدة المعالجة المركزية		
عدد 1	وصلة مروحة للظلم	عدد 1	وصلة مروحة للظلم		
عدد 1	وصلة فتح الهيكل (اختياري)	عدد 1	وصلة فتح الهيكل (اختياري)		
عدد 1	وصلة مسح CMOS	عدد 1	وصلة مسح CMOS		
عدد 2	مقذ USB	عدد 2	مقذ USB		
عدد 1	مقذ توصيل الطاقة (24دوس)	عدد 1	مقذ توصيل الطاقة (24دوس)		
عدد 1	مقذ توصيل الطاقة (4دبليس)	عدد 1	مقذ توصيل الطاقة (4دبليس)		
عدد 1	لوحة مفتاح PS2	عدد 1	لوحة مفتاح PS2		منافذ دخل/خرج اللوحة لالخلفية
عدد 1	مؤس PS/2	عدد 1	مؤس PS/2		
عدد 1	مقذ تسلسلي	عدد 1	مقذ تسلسلي		
عدد 1	مقذ طابعة	عدد 1	مقذ طابعة		
عدد 1	مقذ شبكة لتصل محلية	عدد 1	مقذ شبكة لتصل محلية		
عدد 4	منافذ USB	عدد 4	منافذ USB		
عدد 3	مقيس صوت (Ver 6.x)	عدد 3	مقيس صوت (Ver 6.x)		
عدد 6	مقيس صوت (Ver 5.x)	عدد 6	مقيس صوت (Ver 5.x)		
205مم (عرض) X 305مم (ارتفاع)		205مم (عرض) X 305مم (ارتفاع)		حجم اللوحة	
Windows 2000 / XP / VISTA بحقها في إضافة أو إزالة الدعم لأي نظام تشغيل Biostar تحتفظ بإخطار أو بدون إخطار.		Windows 2000 / XP / VISTA بحقها في إضافة أو إزالة الدعم لأي نظام تشغيل Biostar تحتفظ بإخطار أو بدون إخطار.		دعم أنظمة التشغيل	

	945P-A7B	945PL-A7B
CPU	LGA 775 Intel Core2Duo / Pentium 4 / Pentium D / Celeron D processor up to 3.8 GHz Hyper-Threading Execute Disable Bit Enhanced Intel SpeedStep® Extended Memory 64 Technology	LGA 775 Intel Core2Duo / Pentium 4 / Pentium D / Celeron D processor up to 3.8 GHz Hyper-Threading Execute Disable Bit Enhanced Intel SpeedStep® Extended Memory 64 Technology
FSB	533 / 800 / 1066 MHz	533 / 800 / 1066 MHz
チップセット	Intel 945P Intel ICH7	Intel 945PL Intel ICH7
メインメモリ	DDR2 DIMMスロット x 4 各DIMMは 256/512MB & 1GB DDRをサポート 最大メモリ容量4GB デュアル チャンネルモードDDRメモリモジュール DDR2 533 / 667 をサポート	DDR2 DIMMスロット x 2 各DIMMは 256/512MB & 1GB DDRをサポート 最大メモリ容量2GB デュアル チャンネルモードDDRメモリモジュール DDR2 400 / 533 をサポート
Super I/O	ITE 8712F H/Wモニター ファン速度コントローラ/ モニター ITEの「スマートガーディアン」機能	ITE 8712F H/Wモニター ファン速度コントローラ/ モニター ITEの「スマートガーディアン」機能
IDE	統合IDEコントローラ Ultra DMA 33 / 66 / 100バスマスタモード PIO Mode 0~4のサポート	統合IDEコントローラ Ultra DMA 33 / 66 / 100バスマスタモード PIO Mode 0~4のサポート
SATA	統合シリアルATAコントローラ 最高3.0 Gb/秒のデータ転送速度 SATAバージョン2.0仕様に準拠。	統合シリアルATAコントローラ 最高3.0 Gb/秒のデータ転送速度 SATAバージョン2.0仕様に準拠。
10/100 LAN	Realtek 8100C 10 / 100 Mb/sオートネゴシエーション 半/全二重機能	Realtek 8100C 10 / 100 Mb/sオートネゴシエーション 半/全二重機能
サウンド Codec	ALC861VD(VER 6.X) / ALC888(VER 5.X) 5.1チャンネルオーディオアウト(VER 6.X) 7.1チャンネルオーディオアウト(VER 5.X) Intelハイデフィニションオーディオのサポート	ALC861VD(VER 6.X) / ALC888(VER 5.X) 5.1チャンネルオーディオアウト(VER 6.X) 7.1チャンネルオーディオアウト(VER 5.X) Intelハイデフィニションオーディオのサポート

945P-A7B/945PL-A7B

	945P-A7B	945PL-A7B		
スロット	PCI Express x16スロット	x1	PCI Express x16スロット	x1
	PCI Express x16スロット	x2	PCI Express x16スロット	x2
	PCIスロット	x3	PCIスロット	x3
オンボード コネクタ	フロッピーコネクタ	x1	フロッピーコネクタ	x1
	IDEコネクタ	x1	IDEコネクタ	x1
	SATAコネクタ	x4	SATAコネクタ	x4
	フロントパネルコネクタ	x1	フロントパネルコネクタ	x1
	フロントオーディオコネクタ	x1	フロントオーディオコネクタ	x1
	CDインコネクタ	x1	CDインコネクタ	x1
	S/PDIFアウトコネクタ	x1	S/PDIFアウトコネクタ	x1
	CPUファンヘッダ	x1	CPUファンヘッダ	x1
	システムファンヘッダ	x1	システムファンヘッダ	x1
	シャーシオープンヘッダ(オプション)	x1	シャーシオープンヘッダ(オプション)	x1
	CMOSクリアヘッダ	x1	CMOSクリアヘッダ	x1
USBコネクタ	x2	USBコネクタ	x2	
電源コネクタ(24ピン)	x1	電源コネクタ(24ピン)	x1	
電源コネクタ(4ピン)	x1	電源コネクタ(4ピン)	x1	
背面パネル I/O	PS/2キーボード	x1	PS/2キーボード	x1
	PS/2マウス	x1	PS/2マウス	x1
	シリアルポート	x1	シリアルポート	x1
	プリンタポート	x1	プリンタポート	x1
	LANポート	x1	LANポート	x1
	USBポート	x4	USBポート	x4
	オーディオジャック (Ver 6.x)	x3	オーディオジャック (Ver 6.x)	x3
オーディオジャック (Ver 5.x)	x6	オーディオジャック (Ver 5.x)	x6	
ボードサイズ	205 mm (幅) X 305 mm (高さ)	205 mm (幅) X 305 mm (高さ)		
OSサポ ート	Windows 2000 / XP / VISTA Biostarは事前のサポートなしにOSサポートを 追加または削除する権利を留保します。	Windows 2000 / XP / VISTA Biostarは事前のサポートなしにOSサポートを 追加または削除する権利を留保します。		

2006/11/16

945P-A7B/945PL-A7B BIOS Manual

BIOS Setup	1
1 Main Menu	3
2 Standard CMOS Features	6
3 Advanced BIOS Features	8
4 Advanced Chipset Features	15
5 Integrated Peripherals	18
6 Power Management Setup	25
7 PnP/PCI Configurations	31
8 PC Health Status	33
9 Frequency Control	35

945P-A7B/945PL-A7B BIOS Manual

BIOS Setup

Introduction

This manual discussed Award™ Setup program built into the ROM BIOS. The Setup program allows users to modify the basic system configuration. This special information is then stored in battery-backed RAM so that it retains the Setup information when the power is turned off.

The Award BIOS™ installed in your computer system's ROM (Read Only Memory) is a custom version of an industry standard BIOS. This means that it supports Intel Pentium® 4 processor input/output system. The BIOS provides critical low-level support for standard devices such as disk drives and serial and parallel ports.

Adding important has customized the Award BIOS™, but nonstandard, features such as virus and password protection as well as special support for detailed fine-tuning of the chipset controlling the entire system.

The rest of this manual is intended to guide you through the process of configuring your system using Setup.

Plug and Play Support

These AWARD BIOS supports the Plug and Play Version 1.0A specification. ESCD (Extended System Configuration Data) write is supported.

EPA Green PC Support

This AWARD BIOS supports Version 1.03 of the EPA Green PC specification.

APM Support

These AWARD BIOS supports Version 1.1&1.2 of the Advanced Power Management (APM) specification. Power management features are implemented via the System Management Interrupt (SMI). Sleep and Suspend power management modes are supported. Power to the hard disk drives and video monitors can be managed by this AWARD BIOS.

ACPI Support

Award ACPI BIOS support Version 1.0 of Advanced Configuration and Power interface specification (ACPI). It provides ASL code for power management and device configuration capabilities as defined in the ACPI specification, developed by Microsoft, Intel and Toshiba.

945P-A7B/945PL-A7B BIOS Manual

PCI Bus Support

This AWARD BIOS also supports Version 2.1 of the Intel PCI (Peripheral Component Interconnect) local bus specification.

DRAM Support

DDR SDRAM (Double Data Rate Synchronous DRAM) are supported.

Supported CPUs

This AWARD BIOS supports the Intel CPU.

Using Setup

In general, you use the arrow keys to highlight items, press <Enter> to select, use the <PgUp> and <PgDn> keys to change entries, press <F1> for help and press <Esc> to quit. The following table provides more detail about how to navigate in the Setup program by using the keyboard.

Keystroke	Function
Up arrow	Move to previous item
Down arrow	Move to next item
Left arrow	Move to the item on the left (menu bar)
Right arrow	Move to the item on the right (menu bar)
Move Enter	Move to the item you desired
PgUp key	Increase the numeric value or make changes
PgDn key	Decrease the numeric value or make changes
+ Key	Increase the numeric value or make changes
- Key	Decrease the numeric value or make changes
Esc key	Main Menu – Quit and not save changes into CMOS Status Page Setup Menu and Option Page Setup Menu – Exit Current page and return to Main Menu
F1 key	General help on Setup navigation keys
F5 key	Load previous values from CMOS
F7 key	Load the optimized defaults
F10 key	Save all the CMOS changes and exit

945P-A7B/945PL-A7B BIOS Manual

1 Main Menu

Once you enter Award BIOS™ CMOS Setup Utility, the Main Menu will appear on the screen. The Main Menu allows you to select from several setup functions. Use the arrow keys to select among the items and press <Enter> to accept and enter the sub-menu.

!! WARNING !!

For better system performance, the BIOS firmware is being continuously updated. The BIOS information described in this manual (Figure 1, 2, 3, 4, 5, 6, 7, 8, 9) is for your reference only. The actual BIOS information and settings on board may be slightly different from this manual.

■ Figure 1. Main Menu

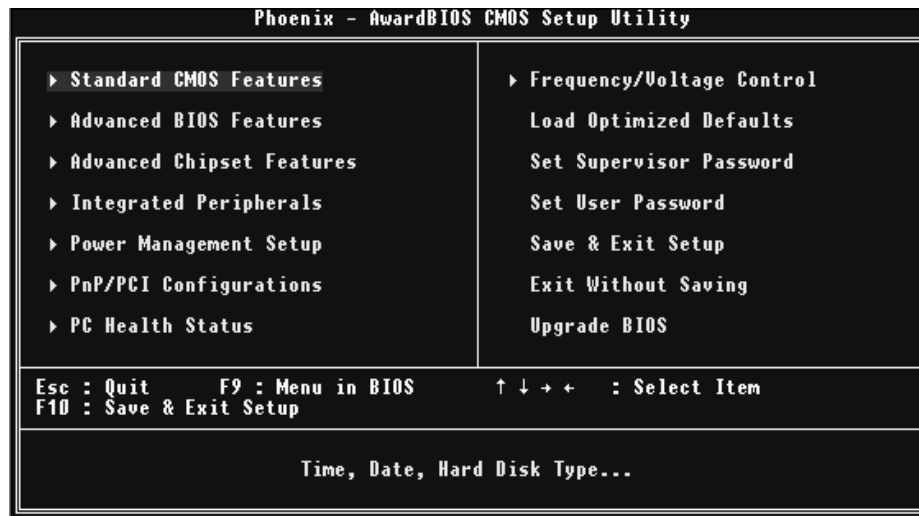

Standard CMOS Features

This submenu contains industry standard configurable options.

Advanced BIOS Features

This submenu allows you to configure enhanced features of the BIOS.

945P-A7B/945PL-A7B BIOS Manual

Advanced Chipset Features

This submenu allows you to configure special chipset features.

Integrated Peripherals

This submenu allows you to configure certain IDE hard drive options and Programmed Input/ Output features.

Power Management Setup

This submenu allows you to configure the power management features.

PnP/PCI Configurations

This submenu allows you to configure certain “Plug and Play” and PCI options.

PC Health Status

This submenu allows you to monitor the hardware of your system.

Frequency/ Voltage Control

This submenu allows you to change CPU Vcore Voltage and CPU/PCI clock. **(However, this function is strongly recommended not to use. Not properly change the voltage and clock may cause the CPU or M/B damage!)**

Load Optimized Defaults

This selection allows you to reload the BIOS when the system is having problems particularly with the boot sequence. These configurations are factory settings optimized for this system. A confirmation message will be displayed before defaults are set.

```
Load Optimized Defaults <Y/N>? N
```

Set Supervisor Password

Setting the supervisor password will prohibit everyone except the supervisor from making changes using the CMOS Setup Utility. You will be prompted with to enter a password.

```
Enter Password:
```

945P-A7B/945PL-A7B BIOS Manual

Set User Password

If the Supervisor Password is not set, then the User Password will function in the same way as the Supervisor Password. If the Supervisor Password is set and the User Password is set, the "User" will only be able to view configurations but will not be able to change them.

```
Enter Password:
```

Save & Exit Setup

Save all configuration changes to CMOS(memory) and exit setup. Confirmation message will be displayed before proceeding.

```
SAVE to CMOS and EXIT <Y/N>? N
```

Exit Without Saving

Abandon all changes made during the current session and exit setup. confirmation message will be displayed before proceeding.

```
Quit Without Saving <Y/N>? N
```

Upgrade BIOS

This submenu allows you to upgrade bios.

```
BIOS UPDATE UTILITY <Y/N>? N
```

945P-A7B/945PL-A7B BIOS Manual

2 Standard CMOS Features

The items in Standard CMOS Setup Menu are divided into 10 categories. Each category includes no, one or more than one setup items. Use the arrow keys to highlight the item and then use the <PgUp> or <PgDn> keys to select the value you want in each item.

■ Figure 2. Standard CMOS Setup

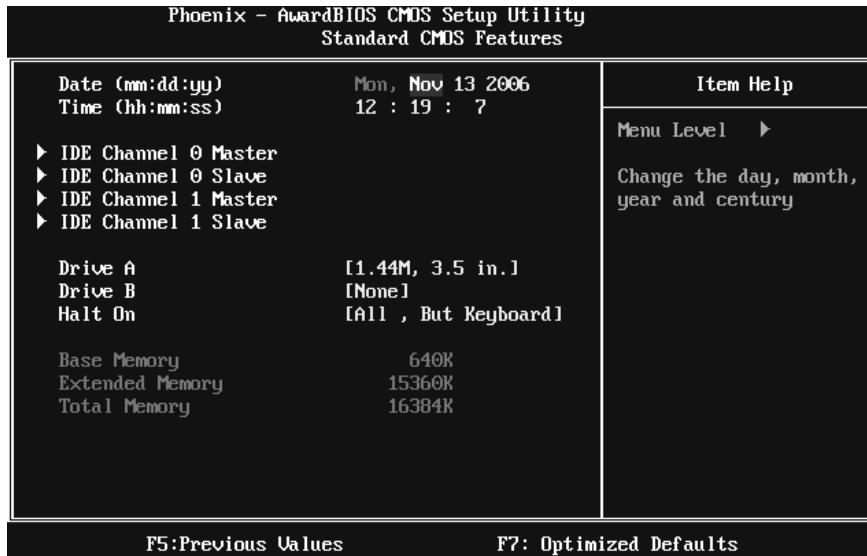

Main Menu Selections

This table shows the selections that you can make on the Main Menu.

Item	Options	Description
Date	mm : dd : yy	Set the system date. Note that the 'Day' automatically changes when you set the date.
Time	hh : mm : ss	Set the system internal clock.
IDE Channel 0 Master	Options are in its sub menu.	Press <Enter> to enter the sub menu of detailed options

945P-A7B/945PL-A7B BIOS Manual

Item	Options	Description
IDE Channel 0 Slave	Options are in its sub menu.	Press <Enter> to enter the sub menu of detailed options.
IDE Channel 1 Master	Options are in its sub menu.	Press <Enter> to enter the sub menu of detailed options.
IDE Channel 1 Slave	Options are in its sub menu.	Press <Enter> to enter the sub menu of detailed options.
Drive A Drive B	360K, 5.25 in 1.2M, 5.25 in 720K, 3.5 in 1.44M, 3.5 in 2.88M, 3.5 in None	Select the type of floppy disk drive installed in your system.
Halt On	All Errors No Errors All, but Key board All, but Diskette All, but Disk/ Key	Select the situation in which you want the BIOS to stop the POST process and notify you.
Base Memory	N/A	Displays the amount of conventional memory detected during boot up.
Extended Memory	N/A	Displays the amount of extended memory detected during boot up.
Total Memory	N/A	Displays the total memory available in the system.

945P-A7B/945PL-A7B BIOS Manual

3 Advanced BIOS Features

■ Figure 3. Advanced BIOS Setup

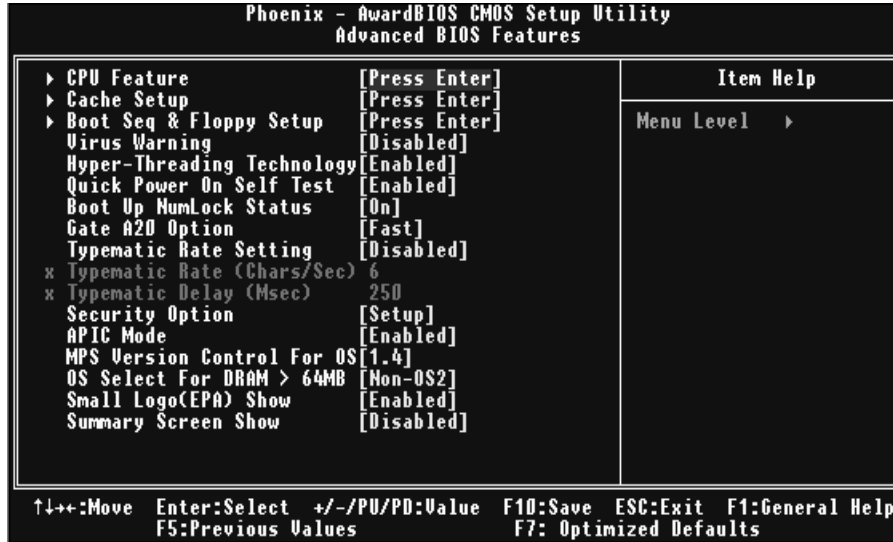

945P-A7B/945PL-A7B BIOS Manual

CPU FEATURE

Phoenix - AwardBIOS CMOS Setup Utility		Item Help
CPU Feature		Menu Level >>
Delay Prior to Thermal	[16 Min]	
Thermal Management	[Thermal Monitor 1]	
TM2 Bus Ratio	[0 %]	
TM2 Bus VID	[0.8375V]	
Limit CPUID MaxVal	[Disabled]	
C1E Function	[Auto]	
Execute Disable Bit	[Enabled]	
Virtualization Technology	[Enabled]	

↑↓←→:Move Enter:Select +/-/PU/PD:Value F10:Save ESC:Exit F1:General Help
F5:Previous Values F7: Optimized Defaults

Delay Prior to Thermal

Set this item to enable the CPU Thermal function to engage after the specified time.
The Choices: 4Min, 8Min, **16Min** (default), 32Min.

Thermal Management

Allow you to choose the thermal management method of your monitor.
The Choices: **Thermal Monitor 1** (default), Thermal Monitor2.
Notes: The choices will be different according to your CPU features.

TM2 Bus Ratio

Represents the frequency. Bus ratio of the throttled performance state that will be initiated when the on-die sensor goes from not hot to hot.
Min= 0, Max= 255, Key in a DEC number.
The Choices: **0X** (default).

TM2 Bus VID

Represents the voltage of the throttled performance state that will be initiated when the on-die sensor goes from not hot to hot.
The Choices: **0.8375V** (default), Min=0.8375V, Max=1.6000.

Limit CPU ID Max Val

Set limit CPU ID maximum value to 3, it should be disabled for Win XP.
The Choices: **Disabled** (default), Enabled.

945P-A7B/945PL-A7B BIOS Manual

C1E Function

CPU C1E Function select.

The Choices: Auto (default), Disabled

Execute Disable Bit

When disabled, forces the XD feature flag to always return 0.

The Choices: Enabled (default), Disabled.

Virtualization Technology

When enabled, a VMM can utilize the additional hardware

Capabilities provided by vanderpool Technology.

The Choices: Enabled (default), Disabled

CACHE SETUP

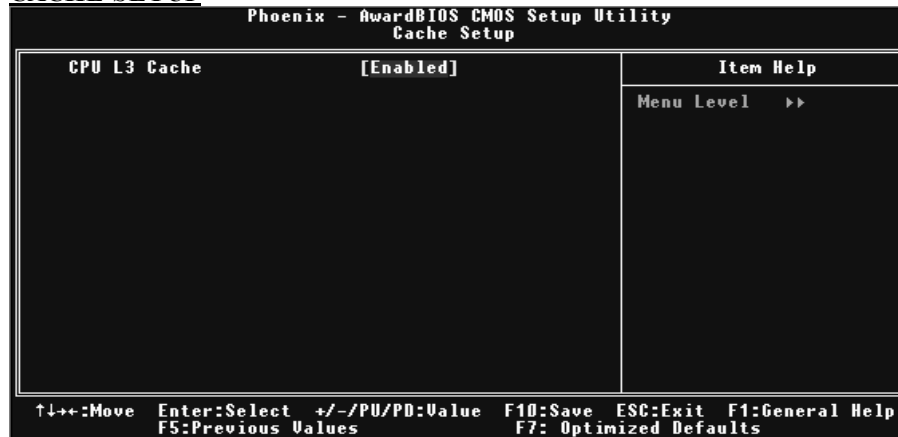

CPU L3 Cache

Depending on the CPU/chipset in use, you may be able to increase memory access time with this option.

Enabled (default)

Enable cache.

Disabled

Disable cache.

945P-A7B/945PL-A7B BIOS Manual

BOOT SEQ & FLOPPY SETUP

```
Phoenix - AwardBIOS CMOS Setup Utility
Boot Seq & Floppy Setup
```

▶ Hard Disk Boot Priority	[Press Enter]	Item Help
First Boot Device	[Floppy]	Menu Level >>
Second Boot Device	[Hard Disk]	Select Hard Disk Boot Device Priority
Third Boot Device	[CDROM]	
Boot Other Device	[Enabled]	
Swap Floppy Drive	[Disabled]	
Boot Up Floppy Seek	[Enabled]	
Report No FDD For WIN 95	[No]	

↑↓↔:Move Enter:Select +/-/PU/PD:Value F10:Save ESC:Exit F1:General Help
F5:Previous Values F7: Optimized Defaults

Hard Disk Boot Priority

```
Phoenix - AwardBIOS CMOS Setup Utility
Hard Disk Boot Priority
```

1. Pri.Master:		Item Help
2. Pri.Slave :		Menu Level >>>>
3. Sec.Master:		Use <↑> or <↓> to select a device , then press <+> to move it up , or <-> to move it down the list. Press <ESC> to exit this menu.
4. Sec.Slave :		
5. USBHDD0 :		
6. USBHDD1 :		
7. USBHDD2 :		
8. Bootable Add-in Cards		

↑↓:Move PU/PD/+/-:Change Priority F10:Save ESC:Exit
F5:Previous Values F6:Fail-Safe Defaults F7:Optimized Defaults

These BIOS attempt to load the operating system from the device in the sequence selected in these items.

The Choices: Pri. Master, Pri.Slave, Sec.Master, Sec. Slave, USBHDD0, USBHDD1, USBHDD2 and Bootable Add-in Card.

945P-A7B/945PL-A7B BIOS Manual

First/Second/Third Boot Device

These BIOS attempt to load the operating system from the device in the sequence selected in these items.

The Choices: Floppy, LSI20, Hard Disk, CDROM, ZIP100, USB-FDD, USB-ZIP, USB-CDROM, LAN, Disabled.

Boot Other Device

When enabled, BIOS will try to load the operating system from other device when it failed to load from the three devices above.

The Choices: Enabled (default), Disabled

Swap Floppy Drive

For systems with two floppy drives, this option allows you to swap logical drive assignments.

The Choices: Disabled (default), Enabled.

Boot Up Floppy Seek

Enabling this option will test the floppy drives to determine if they have 40 or 80 tracks. Disabling this option reduces the time it takes to boot-up.

The Choices: Disabled, Enabled (default).

Report NO FDD for Win95

This item allows you to select YES/NO to Report NO FDD for Win95.

The Choices: NO (default), YES.

VIRUS WARNING

This option allows you to choose the Virus Warning feature that is used to protect the IDE Hard Disk boot sector. If this function is enabled and an attempt is made to write to the boot sector, BIOS will display a warning message on the screen and sound an alarm beep.

Disabled (default)	Virus protection is disabled.
Enabled	Virus protection is activated.

HYPER-THREADING TECHNOLOGY

This option allows you to enable or disabled CPU Hyper-Threading. Enabled for Windows XP and Linux 2.4.x (OS optimized for Hyper Threading Technology). Disabled for other OS (OS not optimized for Hyper Threading Technology).

The Choices: Enabled (default), Disabled.

QUICK POWER ON SELF TEST

Enabling this option will cause an abridged version of the Power On Self-Test (POST) to execute after you power up the computer.

Disabled	Normal POST.
Enabled (default)	Enable quick POST.

945P-A7B/945PL-A7B BIOS Manual

BOOT UP NUMLOCK STATUS

Selects the NumLock. State after power on.

On (default) Numpad is number keys.
Off Numpad is arrow keys.

GATE A20 OPTION

Select if chipset or keyboard controller should control Gate A20.

Normal A pin in the keyboard controller controls Gate A20.
Fast (default) Lets chipset control Gate A20.

TYPOMATIC RATE SETTING

When a key is held down, the keystroke will repeat at a rate determined by the keyboard controller. When enabled, the typematic rate and typematic delay can be configured.

The Choices: **Disabled** (default), Enabled.

TYPOMATIC RATE (CHARS/SEC)

Sets the rate at which a keystroke is repeated when you hold the key down.

The Choices: **6** (default), 8, 10, 12, 15, 20, 24, 30

TYPOMATIC DELAY (MSEC)

Sets the delay time after the key is held down before it begins to repeat the keystroke.

The Choices: **250** (default), 500, 750, and 1000.

SECURITY OPTION

This option will enable only individuals with passwords to bring the system online and/or to use the CMOS Setup Utility.

System A password is required for the system to boot and is also required to access the Setup Utility.

Setup (default) A password is required to access the Setup Utility only.

This will only apply if passwords are set from the Setup main menu.

APIC MODE

Selecting Enabled enables APIC device mode reporting from the BIOS to the operating system.

The Choices: **Enabled** (default), Disabled.

MPS VERSION CONTROL FOR OS

The BIOS supports version 1.1 and 1.4 of the Intel multiprocessor specification.

Select version supported by the operation system running on this computer.

The Choices: **1.4** (default), 1.1.

OS SELECT FOR DRAM > 64MB

A choice other than Non-OS2 is only used for OS2 systems with memory exceeding 64MB.

The Choices: **Non-OS2** (default), OS2.

945P-A7B/945PL-A7B BIOS Manual

SMALL LOGO (EPA) SHOW

This item allows you to select whether the “Small Logo” shows.

Enabled (default) “Small Logo” shows when system boot up.

Disabled No “Small Logo” shows when system boots up.

SUMMARY SCREEN SHOW

This item allows you to enable/disable the summary screen. Summary screen means system configuration and PCI device listing.

The choices: Enabled, **Disabled** (default).

945P-A7B/945PL-A7B BIOS Manual

4 Advanced Chipset Features

This submenu allows you to configure the specific features of the chipset installed on your system. This chipset manage bus speeds and access to system memory resources, such as DRAM. It also coordinates communications with the PCI bus. The default settings that came with your system have been optimized and therefore should not be changed unless you are suspicious that the settings have been changed incorrectly.

■ Figure 4. Advanced Chipset Setup

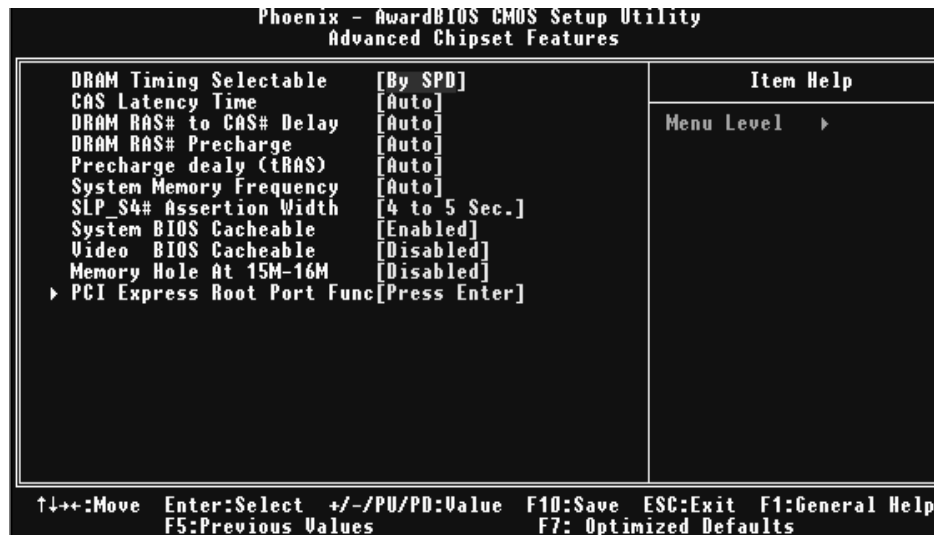

DRAM TIMING SELECTABLE

When synchronous DRAM is installed, the number of clock cycles of CAS latency depends on the DRAM timing.

The Choices: By SPD (default), Manual.

CAS LATENCY TIME

When synchronous DRAM is installed, the number of clock cycles of CAS latency depends on the DRAM timing.

The Choices: Auto (default) 3, 4, 5, 6.

DRAM RAS# TO CAS# DELAY

This field let you insert a timing delay between the CAS and RAS strobe signals, used when DRAM is written to, read from, or refreshed. Fast gives faster performance; and slow gives more stable performance. This field applies only when synchronous DRAM is installed in the system.

The Choices: Auto (default) 2, 3, 4, 5, 6.

945P-A7B/945PL-A7B BIOS Manual

DRAM RAS# PRECHARGE

If an insufficient number of cycles is allowed for RAS to accumulate its charge before DRAM refresh, the refresh may be incomplete, and the DRAM may fail to retain data.

Fast gives faster performance; and Slow gives more stable performance. This field applies only when synchronous DRAM is installed in the system.

The Choices: **Auto** (default), 2,3,4,5,6.

PRECHARGE DELAY (TRAS)

This item controls the number of DRAM clocks to activate the precharge delay.

The Choices: **Auto** (default), 4/5/6/7/8/9/10/11/12/13/14/15.

SYSTEM MEMORY FREQUENCY

This item allows you to select the Memory Frequency.

The Choices: **Auto** (default), 400Mhz, 533Mhz, 667Mhz.

SLP S4# ASSERTION WIDTH

This item sets the minimum assertion width of the SLP-S4# signal to guarantee the DRAM has been safely power-cycled.

The Choices: **4 to 5 Sec** (default), 3 to 4 Sec, 2 to 3 Sec, 1 to 2Sec.

SYSTEM BIOS CACHEABLE

Selecting Enabled allows you caching of the system BIOS ROM at F0000h~FFFFh, resulting a better system performance. However, if any program writes to this memory area, a system error may result.

The Choices: **Enabled** (default), Disabled.

VIDEO BIOS CACHEABLE

Select Enabled allows caching of the video BIOS, resulting a better system performance. However, if any program writes to this memory area, a system error may result.

The Choices: **Disabled** (default), Enabled.

MEMORY HOLE AT 15M-16M

You can reserve this area of system memory for ISA adapter ROM. When this area is reserved it cannot be cached. The user information of peripherals that need to use this area of system memory usually discussed their memory requirements.

The Choices: **Disabled** (default), Enabled.

945P-A7B/945PL-A7B BIOS Manual

PCI EXPRESS ROOT PORT FUNC

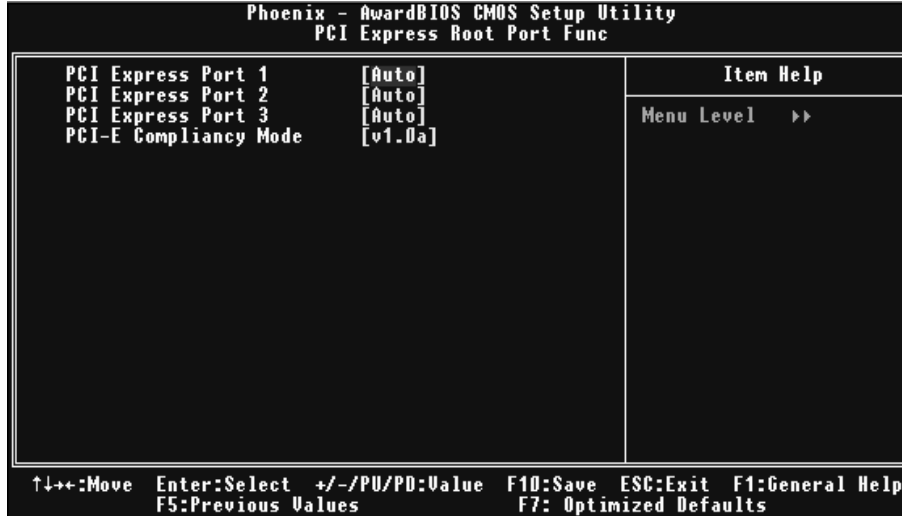

PCI Express Port 1/2/3

This item allows you to select the PCI Express Port.

The Choices: Auto (default), Enabled, Disabled.

PCI-E Compliancy Mode

This item allows you to select the PCI-E Compliancy Mode.

The Choices: v1.0a (default), v1.0.

945P-A7B/945PL-A7B BIOS Manual

5 Integrated Peripherals

■ Figure 5. Integrated Peripherals

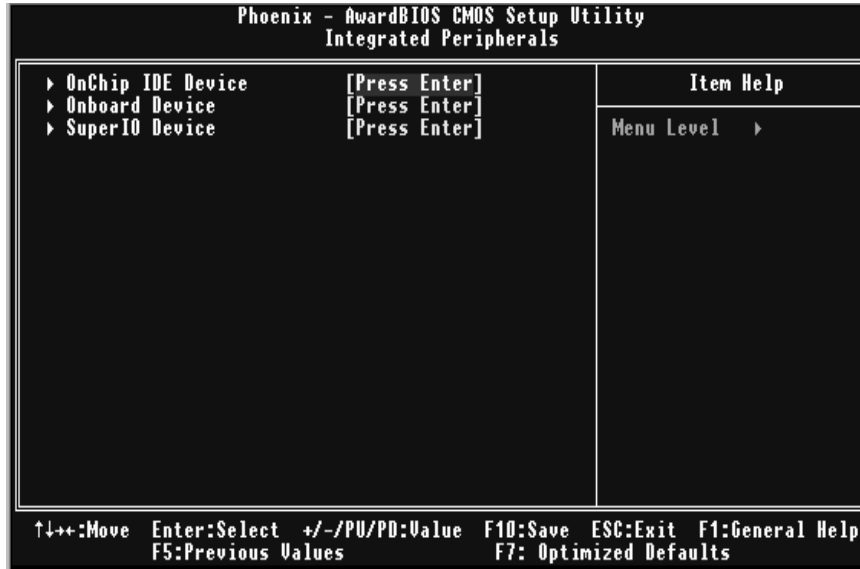

945P-A7B/945PL-A7B BIOS Manual

ONCHIP IDE DEVICE

```

Phoenix - AwardBIOS CMOS Setup Utility
OnChip IDE Device

IDE HDD Block Mode      [Enabled]
IDE DMA transfer access [Enabled]
On-Chip Primary PCI IDE [Enabled]
IDE Primary Master PIO  [Auto]
IDE Primary Slave PIO   [Auto]
IDE Primary Master UDMA [Auto]
IDE Primary Slave UDMA  [Auto]
On-Chip Secondary PCI IDE [Enabled]
IDE Secondary Master PIO [Auto]
IDE Secondary Slave PIO  [Auto]
IDE Secondary Master UDMA [Auto]
IDE Secondary Slave UDMA [Auto]

*** On-Chip Serial ATA Setting ***
SATA Mode                [IDE]
On-Chip Serial ATA      [Enhanced Mode]
SATA PORT Speed Settings [Disabled]
PATA IDE Mode            [Primary]
SATA Port                P1,P3 is Secondary

Item Help
Menu Level  >>
If your IDE hard drive
supports block mode
select Enabled for
automatic detection of
the optimal number of
block read/writes per
sector the drive can
support

↑↓←→:Move  Enter:Select  +/-/PU/PD:Value  F10:Save  ESC:Exit  F1:General Help
F5:Previous Values  F7: Optimized Defaults
  
```

IDE HDD Block Mode

Block mode is also called block transfer, multiple commands, or multiple sector read / write. If your IDE hard drive supports block mode (most new drives do), select Enabled for automatic detection of the optimal number of block mode (most new drives do), select Enabled for automatic detection of the optimal number of block read / write per sector where the drive can support.

The Choices: Enabled (default), Disabled.

IDE DMA Transfer Access

This item allows you to enable or disable the IDE transfer access.

The Choices: Enabled (default), Disabled.

On-chip Primary PCI IDE

This item allows you to enable or disable the primary/ secondary IDE Channel.

The Choices: Enabled (default), Disabled.

IDE Primary/Secondary Master/Slave PIO

The IDE PIO (Programmed Input / Output) fields let you set a PIO mode (0-4) for each of the IDE devices that the onboard IDE interface supports. Modes 0 to 4 will increase performance progressively. In Auto mode, the system automatically determines the best mode for each device.

The Choices: Auto (default), Mode0, Mode1, Mode2, Mode3, and Mode4.

945P-A7B/945PL-A7B BIOS Manual

On-chip Secondary PCI IDE

This item allows you to enable or disable the primary/secondary IDE Channel.

The Choices: Enabled (default), Disabled.

IDE Primary/Secondary Master/Slave UDMA

Ultra DMA/100 functionality can be implemented if it is supported by the IDE hard drives in your system. As well, your operating environment requires a DMA driver (Windows 95 OSR2 or a third party IDE bus master driver). If your hard drive and your system software both support Ultra DMA/100, select Auto to enable BIOS support.

The Choices: Auto (default), Disabled.

SATA Mode

This item allows you to choose SATA Mode.

The Choices: IDE (default), RAID, AHCI.

On-Chip Serial ATA

This item allows you to set the onboard SATA controller.

The Choices: Enhanced Mode (default), Auto, Combined Mode, Disabled, SATA only.

SATA PORT Speed Settings

This item allows you to set SATA PORT Speed.

The Choices: Disabled (default), Force GEN I, Force GEN II.

PATA IDE Mode

This item allows you to choose PATA IDE Mode.

The Choices: Primary (default), Secondary.

945P-A7B/945PL-A7B BIOS Manual

ON BOARD DEVICE

Phoenix - AwardBIOS CMOS Setup Utility	
Onboard Device	
USB Controller	[Enabled]
USB 2.0 Controller	[Enabled]
USB Keyboard Support	[Disabled]
USB Mouse Support	[Disabled]
Onboard AC97 Audio	[Auto]
Onboard RAID (ITE8211)	[Enabled]
Onboard RAID BIOS	[Enabled]
Onboard 1394	[Enabled]
Onboard LAN	[Enabled]
Onboard Lan Boot ROM	[Disabled]

Item Help
Menu Level >>

↑↓→+:Move Enter:Select +/-/PU/PD:Value F10:Save ESC:Exit F1:General Help
F5:Previous Values F7: Optimized Defaults

USB Controller

Select Enabled if your system contains a Universal Serial Bus (USB) controller and you have USB peripherals.

The Choices: Enabled (default), Disabled

USB 2.0 Controller

This entry is to enable/disable EHCI controller only. This BIOS itself may/may not have high speed USB support. If the BIOS has high speed USB support built in, the support will automatically turn on, when high speed device were attached.

The Choices: Enabled (default), Disabled.

USB Keyboard Support

This item allows you to enable or disable the USB Keyboard Legacy Support.

Enabled Enable USB Keyboard Support.

Disabled (default) Disable USB Keyboard Support.

USB Mouse Support

This item allows you to enable or disable the USB Mouse Legacy Support.

Enabled Enable USB Mouse Support.

Disabled (default) Disable USB Mouse Support.

Onboard AC97 Audio

This item allows you to enable or disable to support Onboard AC97 Audio.

The Choices: Auto (default), Disabled.

945P-A7B/945PL-A7B BIOS Manual

Onboard RAID <ITE8211>

This item allows you to enable or disable to support Onboard RAID (ITE8211).

The Choices: Enabled (default), Disabled.

Onboard RAID BIOS

This item allows you to enable or disable to Onboard RAID BIOS.

The Choices: Enabled (default), Disabled.

Onboard 1394

This item allows you to enable or disable to support Onboard 1394 controller.

The Choices: Enabled (default), Disabled.

Onboard LAN

This item allows you to enable or disable the Onboard LAN.

The Choices: Enabled (default), Disabled.

Onboard LAN BootROM

Decide whether to invoke the boot ROM of the onboard LAN chip.

The Choices: Disabled (default), Enabled.

945P-A7B/945PL-A7B BIOS Manual

SUPER IO DEVICE

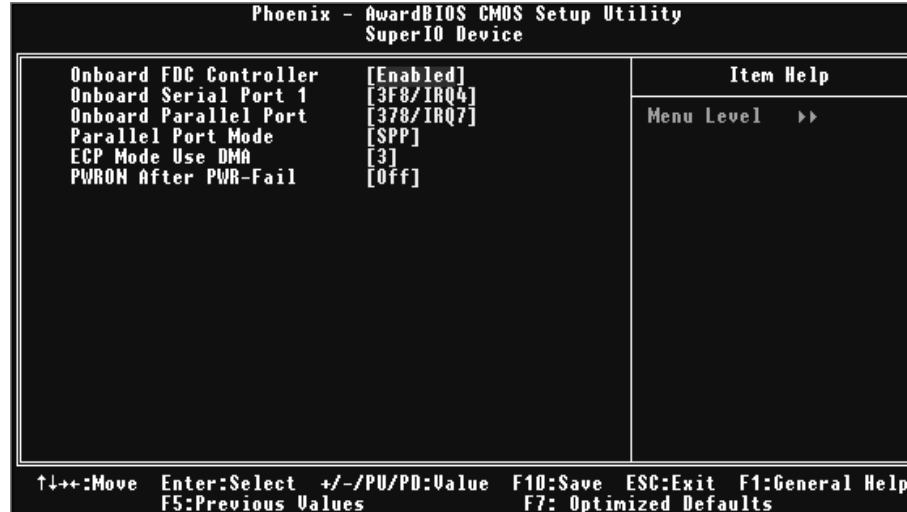

If you highlight the literal "Press Enter" next to the "Super IO Device" label and then press the enter key, it will take you a submenu with the following options:

Onboard FDC Controller

Select Enabled if your system has a floppy disk controller (FDC) installed on the systemboard and you wish to use it. If install and FDC or the system has no floppy drive, select Disabled in this field.

The Choices: Enabled (default), Disabled.

Onboard Serial Port 1

Select an address and corresponding interrupt for the first and second serial ports.

The Choices: Disabled, 3F8/IRQ4 (default), 2F8/IRQ3, 3E8/IRQ4, 2E8/IRQ3, Auto.

Onboard Parallel Port

This item allows you to determine access onboard parallel port controller with which I/O Address.

The Choices: 378/IRQ7 (default), 278/IRQ5, 3BC/IRQ7, Disabled.

Parallel Port Mode

The default value is SPP.

The Choices:

- SPP (default) Using Parallel port as Standard Printer Port.
- EPP Using Parallel Port as Enhanced Parallel Port.
- ECP+EPP Using Parallel port as ECP & EPP mode.
- ECP Using Parallel port as Extended Capabilities Port.

945P-A7B/945PL-A7B BIOS Manual

ECP Mode Use DMA

Select a DMA Channel for the port.

The Choices: 3 (default), 1.

POWER After PWR-Fail

This setting specifies whether your system will reboot after a power fail or interrupts occurs.

Off Leaves the computer in the power off state.

On Reboots the computer.

Former-Sts Restores the system to the status before power failure or interrupt occurs.

The Choices: Off (default), On, Former-Sts.

945P-A7B/945PL-A7B BIOS Manual

6 Power Management Setup

The Power Management Setup Menu allows you to configure your system to utilize energy conservation and power up/power down features.

■ **Figure 6. Power Management Setup**

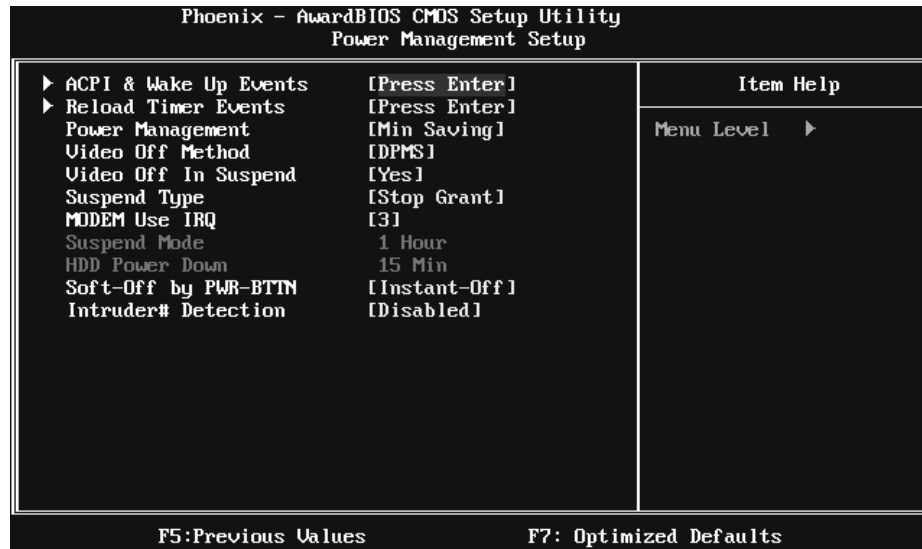

945P-A7B/945PL-A7B BIOS Manual

ACPI & WAKE UP EVENTS

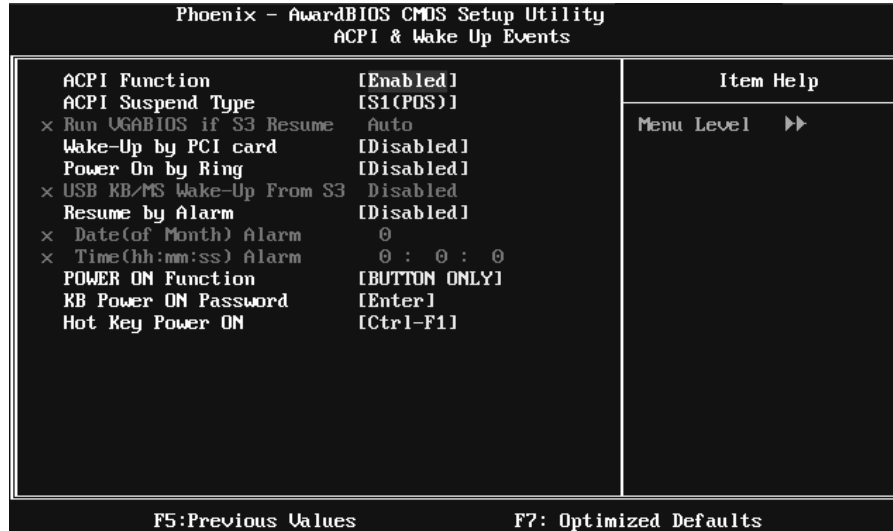

ACPI Function

This item displays the status of the Advanced Configuration and Power Management (ACPI).

The Choices: Enabled (default), Disabled.

ACPI Suspend Type

The item allows you to select the suspend type under the ACPI operating system.

The Choices: S1 (POS) (default) Power on Suspend
S3 (STR) Suspend to RAM
S1 & S3 POS+STR

Run VGABIOS if S3 Resume

Choosing Enabled will make BIOS run VGA BIOS to initialize the VGA card when system wakes up from S3 state. The system time is shortened if you disable the function, but system will need AGP driver to initialize the card. So, if the AGP driver of the VGA card does not support the initialization feature, the display may work abnormally or not function after S3.

The Choices: Auto (default), Yes, No.

945P-A7B/945PL-A7B BIOS Manual

Wake-Up by PCI card

When you select “Enable”, a PME signal from PCI card returns the system to Full On state.

The Choices: Enabled, **Disabled** (default).

Power On by Ring

An input signal on the serial Ring Indicator (RI) line (in other words, an incoming call on the modem) awakens the system from a soft offstate.

The Choices: Enabled, **Disabled** (default).

USB KB/MS Wake-Up From S3

This item allows you to enable or disabled USB keyboard wake up from S3.

The Choices: **Disabled** (default), Enabled.

Resume by Alarm

This function is for setting date and time for your computer to boot up.

During Disabled, you cannot use this function. During Enabled,

Choose the Date and Time.

The Choices: Enabled, **Disabled** (default).

Date (of Month) Alarm

You can choose which month the system will boot up.

Time (hh:mm:ss) Alarm

You can choose what hour, minute and second the system will boot up.

Note: If you have change the setting, you must let the system boot up until it goes to the operating system, before this function will work.

POWER ON Function

This item allows you to choose the power on function.

The Choices: **Button Only** (default), Password, Hot Key, Mouse Move/Click, Mouse Double Click, Any Key, Keyboard 98.

KB POWER ON Password

Input password and press Enter to set the Keyboard power on password.

Hot Key Power ON

Input password and press Enter to set the Keyboard power on password.

The Choices: **Ctrl-F1** (default), Ctrl-F2, Ctrl-F3, Ctrl-F4, Ctrl-F5, Ctrl-F6, Ctrl-F7, Ctrl-F8, Ctrl-F9, Ctrl-F10, Ctrl-F11, and Ctrl-F12.

945P-A7B/945PL-A7B BIOS Manual

RELOAD TIMER EVENTS

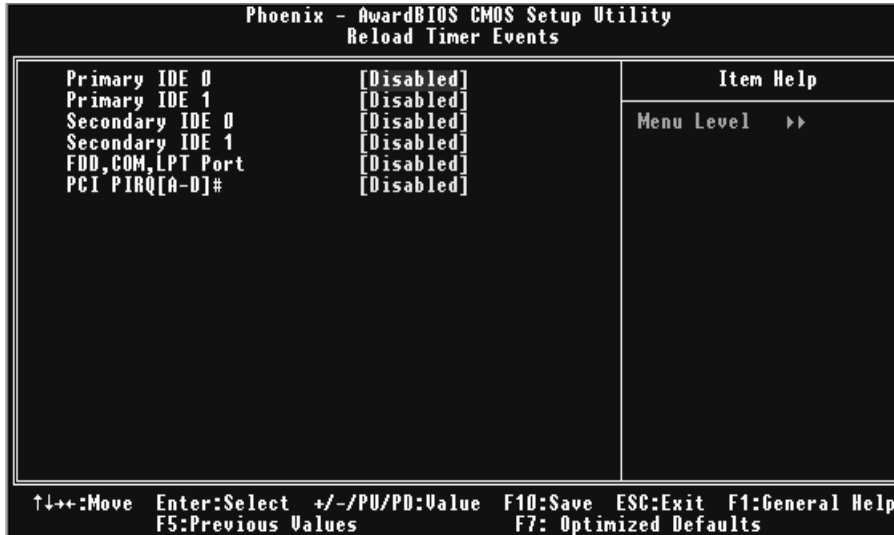

Primary/Secondary IDE 0/1

You can select to enable or disable Primary or Secondary RAID 0 or RAID 1 function under this item.

The Choices: Disabled (default), Enabled.

FDD, COM, LPT Port

You can select to enable or disable FDD, COM, and LPT port under this item.

The Choices: Disabled (default), Enabled.

PCI PIRQ [A-D]#

You can select to enable or disable PCI PIRQ [A-D]# under this item.

The Choices: Disabled (default), Enabled.

945P-A7B/945PL-A7B BIOS Manual

POWER MANAGEMENT

This category allows you to select the type (or degree) of power saving and is directly related to the following modes:

1. HDD Power Down.
2. Suspend Mode.

There are four options of Power Management, three of which have fixed mode settings

Min Saving (default)

Minimum power management.

Suspend Mode = 1 hr.

HDD Power Down = 15 min

Max Saving

Maximum power management only available for SL CPU's.

Suspend Mode = 1 min.

HDD Power Down = 1 min.

User Define

Allow you to set each mode individually.

When not disabled, each of the ranges is from 1 min. to 1 hr. except for HDD Power Down which ranges from 1 min. to 15 min. and disable.

VIDEO OFF METHOD

This option determines the manner in which the monitor is goes blank.

V/H SYNC+Blank

This selection will cause the system to turn off the vertical and horizontal synchronization ports and write blanks to the video buffer.

Blank Screen

This option only writes blanks to the video buffer.

DPMS(default)

Initial display power management signaling.

VIDEO OFF IN SUSPEND

This determines the manner in which the monitor is blanked.

The Choices: Yes (default), No.

SUSPEND TYPE

Select the Suspend Type.

The Choices: Stop Grant (default), PwrOn Suspend.

945P-A7B/945PL-A7B BIOS Manual

MODEM USE IRQ

This determines the IRQ, which can be applied in MODEM use.

The Choices: 3 (default), 4 / 5 / 7 / 9 / 10 / 11 / NA.

SUSPEND MODE

The item allows you to select the suspend type under ACPI operating system.

The Choices: Disabled, 1 Min, 2 Min, 4 Min, 6 Min, 8 Min, 10 Min, 20 Min, 30 Min, 40 Min, **1 Hour** (default).

HDD POWER DOWN

When enabled, the hard disk drive will power down and after a set time of system inactivity. All other devices remain active.

The Choices: Disabled, 1 Min, 2 Min, 3 Min, 4 Min, 5 Min, 6 Min, 7 Min, 8 Min, 9 Min, 10 Min, 11 Min, 12 Min, 13 Min, 14 Min, **15Min** (default).

SOFT-OFF BY PWR-BTN

Pressing the power button for more than 4 seconds forces the system to enter the Soft-Off state when the system has "hung."

The Choices: Delay 4 Sec, **Instant-Off** (default).

INTRUDER# DETECTION

This item allows you to enable or disable intruder# detection.

The Choices: **Disabled** (default), Enabled.

945P-A7B/945PL-A7B BIOS Manual

7 PnP/PCI Configurations

This section describes configuring the PCI bus system. PCI, or Personal Computer Interconnect, is a system which allows I/O devices to operate at speeds nearing the speed of the CPU itself when communicating with its own special components. This section covers some very technical items and it is strongly recommended that only experienced users should make any changes to the default settings.

■ Figure 7. PnP/PCI Configurations

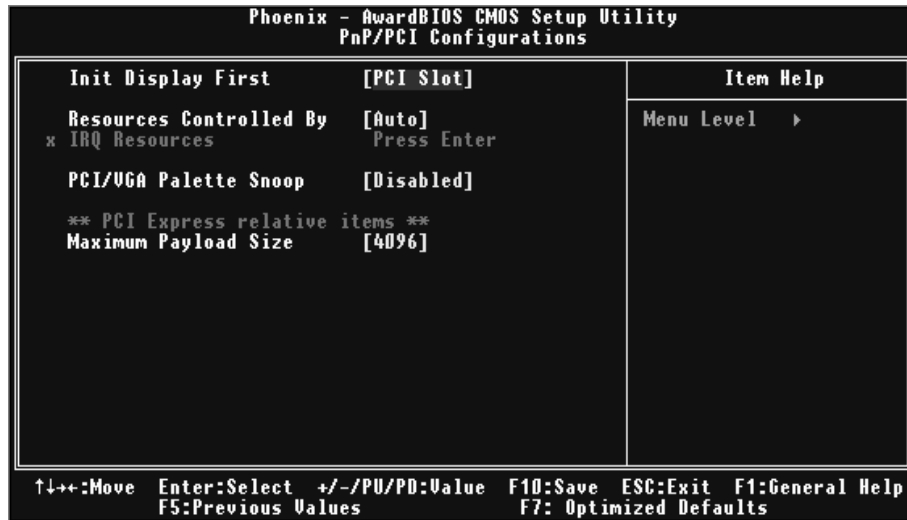

INIT DISPLAY FIRST

This item allows you to decide to activate whether PCI Slot or on-chip VGA first.
The Choices: PCI Slot (default), PCIEx.

RESOURCES CONTROLLED BY

By Choosing "Auto (ESCD)" (default), the system BIOS will detect the system resources and automatically assign the relative IRQ and DMA channel for each peripheral. By Choosing "Manual", the user will need to assign IRQ & DMA for add-on cards. Be sure that there are no IRQ/DMA and I/O port conflicts.

The Choices: Auto (default), Manual.

945P-A7B/945PL-A7B BIOS Manual

IRQ RESOURCES

This submenu will allow you to assign each system interrupt a type, depending on the type of device using the interrupt. When you press the “Press Enter” tag, you will be directed to a submenu that will allow you to configure the system interrupts. This is only configurable when “Resources Controlled By” is set to “Manual”.

IRQ-3	assigned to	PCI Device
IRQ-4	assigned to	PCI Device
IRQ-5	assigned to	PCI Device
IRQ-7	assigned to	PCI Device
IRQ-9	assigned to	PCI Device
IRQ-10	assigned to	PCI Device
IRQ-11	assigned to	PCI Device
IRQ-12	assigned to	PCI Device
IRQ-14	assigned to	PCI Device
IRQ-15	assigned to	PCI Device

PCI / VGA PALETTE SNOOP

Choose Disabled or Enabled. Some graphic controllers that are not VGA compatible take the output from a VGA controller and map it to their display as a way to provide boot information and VGA compatibility. However, the color information coming from the VGA controller is drawn from the palette table inside the VGA controller to generate the proper colors, and the graphic controller needs to know what is in the palette of the VGA controller. To do this, the non-VGA graphic controller watch for the Write access to the VGA palette and registers the snoop data. In PCI based systems, where the VGA controller is on the PCI bus and a non-VGA graphic controller is on an ISA bus, the Write Access to the palette will not show up on the ISA bus if the PCI VGA controller responds to the Write.

In this case, the PCI VGA controller should not respond to the Write, it should only snoop the data and permit the access to be forwarded to the ISA bus. The non-VGA ISA graphic controller can then snoop the data on the ISA bus. Unless you have the above situation, you should disable this option.

Disabled (default) disable the function.
Enabled enable the function.

MAXIMUM PAYLOAD SIZE

Set the maximum TLP payload size for the PCI Express device. The unit is byte.

The Choice: 4096 (default), 128, 256, 512, 1024, 2048.

945P-A7B/945PL-A7B BIOS Manual

8 PC Health Status

■ Figure 8. PC Health Status

Phoenix - AwardBIOS CMOS Setup Utility		Item Help
PC Health Status		Menu Level ▶
CPU Fan Control	[Smart]	
CPU Fan Off($^{\circ}\text{C}$)	[16]	
CPU Fan Start($^{\circ}\text{C}$)	[24]	
CPU Fan Full speed($^{\circ}\text{C}$)	[55]	
Start PWM Value	[64]	
Slope PWM	[1 PWM value/$^{\circ}\text{C}$]	
Shutdown Temperature	[Disabled]	
Show H/W Monitor in POST	[Enabled]	
CPU Ucore		
NB/SB Voltage		
+ 3.3 V		
+ 5.0 V		
DDR Voltage		
5V(SB)		
Voltage Battery		
Current CPU Temp		
Current CPU FAN Speed		
Current SYS FAN Speed		

F5: Previous Values F7: Optimized Defaults

CPU FAN Control

The Choice “smart” can make your CPU FAN to reduce noise.

The Choices: Smart (default), Always On.

CPU Fan Off$^{\circ}\text{C}$

If the CPU Temperature is lower than the set value, FAN will turn off.

The Choices: Min=0, Max=127, Key in a DEC number.

CPU Fan Start$^{\circ}\text{C}$

CPU fan starts to work under smart fan function when arrive this set value.

The Choices: Min=0, Max=127, Key in a DEC number.

CPU Fan Full speed $^{\circ}\text{C}$

When CPU temperature is reach the set value, the CPU fan will work under Full Speed.

The Choices: Min=0, Max=127, Key in a DEC number.

Start PWM Value

When CPU temperature arrives to the set value, the CPU fan will work under Smart Fan Function mode. The range is from 0~127, with an interval of 1.

The Choices: Min=0, Max=127, Key in a DEC number.

945P-A7B/945PL-A7B BIOS Manual

Slope PWM

Increasing the value of slope PWM will raise the speed of CPU fan.

The Choices: 1 PWM Value/°C (default), 2 PWM Value/°C, 4 PWM Value/°C, 8 PWM Value/°C, 16 PWM Value/°C.

SHUTDOWN TEMPERATURE

This item allows you to set up the CPU shutdown Temperature. This item only effective under Windows 98 ACPI mode

The Choices: 65°C/140°F, 70°C/149°F, 75°C/158°F, **Disabled** (default).

SHOW H/W MONITOR IN POST

If your computer contains a monitoring system, it will show PC health status during POST stage. The item offers several delay times to select you want.

The Choices: **Enabled** (default), Disabled.

CPU VCORE, NB/SB VOLTAGE, +3.3V, +5.0V, DDR VOLTAGE, 5V(SB), VOLTAGE BATTERY

Detect the system's voltage status automatically.

CURRENT CPU TEMP

This field displays the current temperature of CPU.

CURRENT CPU FANSPEED

This field displays the current speed of CPU fan.

CURRENT SYS FANSPEED

This field displays the current speed SYSTEM fan.

945P-A7B/945PL-A7B BIOS Manual

9 Frequency Control

■ Figure 9. Frequency Control

Phoenix - AwardBIOS CMOS Setup Utility		Item Help
Frequency/Voltage Control		Menu Level ▶
CPU Voltage	[StartUp]	
Memory Voltage	[1.90V]	
NB/SB Voltage	[1.5 V]	
FSB Termination Voltage	[1.2 V]	
CPU Clock Ratio	[8 X]	
CPU Clock	[100MHz]	
PCIE Clock select	[Upto CPU]	
× PCIE clock	100	
PCI clock	[33.33Mhz]	

F5: Previous Values F7: Optimized Defaults

CPU Voltage

This item allows you to select CPU Voltage Control.
The Choices: StartUp (default), +0.012V~+0.787V.

Memory Voltage

The Choices: 1.90V (default), 2.00V, 2.10V, 2.20V, 2.30V, 2.40V, 2.50V, 2.60V..

NB/SB Voltage

The Choices: 1.5V (default), 1.6V, 1.7V, 1.8V.

FSB Termination Voltage

The Choices: 1.2V (default), 1.3V, 1.4V, 1.5V.

CPU CLOCK RATIO

This item allows you to select the CPU Ratio.
Min= 8, Max= 50, Key in a DEC number.
The Choices: 8X (default).

945P-A7B/945PL-A7B BIOS Manual

CPU CLOCK

This item allows you to select CPU Clock, and CPU over clocking.

Min= 100, Max= 265, Key in a DEC number.

The Choices: 100MHZ(default).

Special Notice:

If unfortunately, the system's frequency that you are selected is not functioning, there are two methods of booting-up the system.

Method 1:

Clear the COMS data by setting the JCOMS1 ((2-3) closed)) as "ON" status. All the CMOS data will be loaded as default setting.

Method 2:

Press the <Insert> key and Power button simultaneously, after that keep-on pressing the <Insert> key until the power-on screen showed. This action will boot-up the system according to FSB of the processor.

PCIE Clock select

The Choices: Upto CPU(default), Fixed 100, Manual

PCIE Clock

This item will activated only when "PCIE Clock Select" is set to "Manual"

The Choices: Min= 100, Max= 200, Key in a DEC number.

PCI Clock

The Choices: 33.33Mhz(default), 33.80Mhz, 34.29Mhz, 34.78Mhz, 35.29Mhz, 35.82Mhz, 36.36Mhz, 36.92Mhz, 37.50Mhz.

It's strongly recommended to set CPU Vcore and dock in default setting. If the CPU Vcore and clock are not in default setting, it may cause CPU or M/B damage.