

**917PBAG/917PBA
917GBAG/917GBA**

USER'S MANUAL

M/B For LGA 775 Pentium 4 Processor

NO. G03-917GBA

Rev:2.0

Release date: November 2004

Trademark:

* Specifications and Information contained in this documentation are furnished for information use only, and are subject to change at any time without notice, and should not be construed as a commitment by manufacturer.

TABLE OF CONTENT

USER'S NOTICE.....	ii
MANUAL REVISION INFORMATION	ii
COOLING SOLUTIONS.....	ii
CHAPTER 1 INTRODUCTION OF 917PBAG/917PBA/917GBAG/917GBA MOTHERBOARD	
1-1 FEATURE OF MOTHERBOARD	1
1-2 SPECIFICATION.....	2
1-3 PERFORMANCE LIST.....	3
1-4 LAYOUT DIAGRAM & JUMPER SETTING	4
CHAPTER 2 HARDWARE INSTALLATION	
2-1 HARDWARE INSTALLATION STEPS.....	6
2-2 CHECKING MOTHERBOARD'S JUMPER SETTING.....	6
2-3 INSTALL CPU.....	7
2-3-1 GLOSSARY.....	7
2-3-2 ABOUT INTEL PENTIUM 4 LGA 775 CPU.....	8
2-3-3 LGA 775 CPU INSTALLATION GUIDE.....	9
2-4 INSTALL MEMORY	18
2-5 EXPANSION CARD.....	19
2-5-1 PROCEDURE FOR EXPANSION CARD INSTALLATION	19
2-5-2 ASSIGNING IRQ FOR EXPANSION CARD.....	20
2-5-3 INTERRUPT REQUEST TABLE FOR THIS MOTHERBOARD.....	20
2-5-4 PCI EXPRESS SLOT	21
2-6 CONNECTORS, HEADERS	21
2-6-1 CONNECTORS.....	21
2-6-2 HEADERS	24
2-7 STARTING UP YOUR COMPUTER.....	27
CHAPTER 3 INTRODUCING BIOS	
3-1 ENTERING SETUP.....	28
3-2 GETTING HELP	28
3-3 THE MAIN MENU.....	29
3-4 STANDARD CMOS FEATURES	30
3-5 ADVANCED BIOS FEATURES	31
3-6 ADVANCED CHIPSET FEATURES	33
3-6-1 PCIEXPRESS ROOT PORT FUNCTION.....	34
3-7 INTEGRATED PERIPHERALS.....	35
3-7-1 ONBOARD IDE FUNCTION.....	35
3-7-2 ONBOARD DEVICE FUNCTION.....	36
3-7-3 ONBOARD SUPER IO FUNCTION	37
3-8 POWER MANAGEMENT SETUP.....	38
3-8-1 PM TIMER RELOAD EVENTS	39
3-8-2 PCI EXPRESS PM FUNCTION.....	39
3-9 PNP/PCI CONFIGURATION SETUP	40
3-9-1 IRQ RESOURCES.....	41
3-10 PC HEALTH STATUS	41
3-11 MISCELLANEOUS CONTROL	42
3-12 LOAD STANDARD/OPTIMIZED DEFAULTS	43
3-13 SET SUPERVISOR/USER PASSWORD.....	43
CHAPTER 4 DRIVER & FREE PROGRAM INSTALLATION	
MAGIC INSTALL SUPPORTS WINDOWS 2000/XP.....	44
4-1 INF INSTALL INTEL 915 CHIPSET SYSTEM DRIVER.....	45
4-2 VGA INSTALL INTEL 915G VGA DRIVER.....	46
4-3 SOUND INSTALL ALC880 AC97 CODEC AUDIO DRIVER	46
4-4 LAN INSTALL REALTEK 8110S GIGA ETHERNET DRIVER.....	47
4-5 RAID INSTALL SIS 180 RAID DRIVER AND UTILITY.....	48
4-6 PC-HEALTH INSTALL INTEL HARDWARE DOCTOR UTILITY	49
4-7 PC-CILLIN INSTALL PC-CILLIN2004 ANTI-VIRUS PROGRAM	50
4-8 HOW TO UPDATE BIOS.....	51

USER'S NOTICE

COPYRIGHT OF THIS MANUAL BELONGS TO THE MANUFACTURER. NO PART OF THIS MANUAL, INCLUDING THE PRODUCTS AND SOFTWARE DESCRIBED IN IT MAY BE REPRODUCED, TRANSMITTED OR TRANSLATED INTO ANY LANGUAGE IN ANY FORM OR BY ANY MEANS WITHOUT WRITTEN PERMISSION OF THE MANUFACTURER.

THIS MANUAL CONTAINS ALL INFORMATION REQUIRED TO USE 917PBAG/917PBA/917GBAG/917GBA MOTHER-BOARD AND WE DO ASSURE THIS MANUAL MEETS USER'S REQUIREMENT BUT WILL CHANGE, CORRECT ANY TIME WITHOUT NOTICE. MANUFACTURER PROVIDES THIS MANUAL "AS IS" WITHOUT WARRANTY OF ANY KIND, AND WILL NOT BE LIABLE FOR ANY INDIRECT, SPECIAL, INCIDENTAL OR CONSEQUENTIAL DAMAGES (INCLUDING DAMAGES FOR LOSS OF PROFIT, LOSS OF BUSINESS, LOSS OF USE OF DATA, INTERRUPTION OF BUSINESS AND THE LIKE).

PRODUCTS AND CORPORATE NAMES APPEARING IN THIS MANUAL MAY OR MAY NOT BE REGISTERED TRADEMARKS OR COPYRIGHTS OF THEIR RESPECTIVE COMPANIES, AND THEY ARE USED ONLY FOR IDENTIFICATION OR EXPLANATION AND TO THE OWNER'S BENEFIT, WITHOUT INTENT TO INFRINGE.

Manual Revision Information

Reversion	Revision History	Date
2.0	Second Edition	November 2004

Item Checklist

- 917PBAG/917PBA/917GBAG/917GBA Motherboard
- Cable for IDE/Floppy
- CD for motherboard utilities
- Cable for USB Port 3/4 (Option)
- SPDIF-IN/SPDIF-OUT Adaptor
- Cable for Serial ATA IDE Port
- 917PBAG/917PBA/917GBAG/917GBA User's Manual

Intel Pentium 4 Processor Family Cooling Solutions

As processor technology pushes to faster speeds and higher performance, thermal management becomes increasingly crucial when building computer systems. Maintaining the proper thermal environment is key to reliable, long-term system operation. The overall goal in providing the proper thermal environment is keeping the processor below its specified maximum case temperature. Heatsinks induce improved processor heat dissipation through increased surface area and concentrated airflow from attached fans. In addition, interface materials allow effective transfers of heat from the processor to the heatsink. For optimum heat transfer, Intel recommends the use of thermal grease and mounting clips to attach the heatsink to the processor.

When selecting a thermal solution for your system, please refer to the website below for collection of heatsinks evaluated and recommended by Intel for use with Intel processors. Note, those heatsinks are recommended for maintaining the specified Maximum T case requirement. In addition, this collection is not intended to be a comprehensive listing of all heatsinks that support Intel processors.

For vendor list of heatsink and fan, please visit :

<http://developer.intel.com/design/Pentium4/components/index>

Chapter 1

Introduction of 917PBAG/917PBA/917GBAG/917GBA Motherboard

1-1 Feature of motherboard

The 917PBAG/917PBA/917GBAG/917GBA motherboard is design for use Intel Pentium 4 Processor in LGA775(Land Grid Array) Prescott Processor with the Intel 915P/915G Chipset delivers a high performance and professional desktop platform solution. Which utilize the design and the memory size expandable to 2.0GB.

These motherboards use the newest Intel 915P/915G Chipset Supports 533MHz/800MHz Processor System Bus (FSB) in data transfer rate, the 917PBAG/917PBA/917GBAG/ 917GBA provided 200/166MHz SDRAM clock frequency support DDR400/DDR333 SDRAM, also provided DDR2 clock frequency support DDR2 533/400. These motherboard also provided Dual Channel function to increase memory performance. The motherboard embedded ICH6 chipset offers one parallel ULTRA ATA **100** interface and four serial ATA interface to provide speedier HDD throughout that boosts overall system performance.

917PBAG/917PBA/917GBAG/917GBA provided one 16-lane PCI Express port intended for Graphics Attach, fully compliant to the *PCI Express Base Specification revision 1.0a*, and two 1-lan PCI Express port support.

This X16 PCI Express Slot provided multiplexed Digital display channels, Support with ADD2 Card (Advanced Digital Display).

The 917PBAG/917GBAG motherboard including Fast Ethernet PCI LAN chip support 10Mb/s, 100Mb/s, 1Gb/s Base transfer rate.

These motherboards also has an integrated 8-channel High Definition Audio Codec on board support 8-channel 3D surround positioning Audio which is fully compatible with Sound Blaster Pro® that gives you the best sound quality and compatibility. The motherboard provided SPDIF-In/ SPDIF-Out optical function support SPDIF device.

These motherboards integrated SiS 180 Serial-ATA IDE controller provided two Serial-ATA port and one Parallel Ultra ATA133 port (two devices), supports Ultra ATA/Serial ATA, Ultra/Serial ATA RAID 0 or 1, Ultra/Serial ATA Raid 0+1 meet future IDE demand increase the data transfer rate.

With USB control as well as capability of expanding to 8 USB2.0 function ports, these motherboards meet future USB demand also these motherboard have built-in hardware monitor function. This will monitor and protect your computer. These motherboards special design in hardware to protect BIOS from virus crash BIOS data.

These motherboards provide special function in BIOS Setup to setting CPU Host clock step by step increasing let users to approach over clocking.

These motherboards provided high performance & meet future specification demand. It is really wise choice for your computer.

1-2 Specification

Spec	Description
Design	* ATX form factor 4 layers PCB size: 30.5x24.5cm
Chipset	* Intel 915P Memory Controller Hub (MCH) Chipset for 917PBAG/917PBA * Intel 915G Graphics Memory Controller Hub (GMCH) Chipset for 917GBAG/917GBA * Intel 82801FB I/O Controller Hub (ICH6) Chipset
CPU Socket (LGA 755 Socket)	* Support Intel Pentium 4 755-Land LGA Package utilizes Flip-Chip Land Grid Array (FCLGA4) package processor * Support CPU Frequency 533MHz/800MHz * Support 2.8G~3.8G LGA 755 Pentium 4 processor * Reserves support for future Intel Pentium 4 processors
Memory Socket	* 184-pin DDR RAM module socket x2 * 240-pin DDR2 RAM module socket x2 * Support either Dual channel DDR333/DDR400 or DDR2 533/DDR2 400 RAM Module * Expandable to 2.0GB
Integrate VGA (only for 917GBAG/917GBA)	* 400MHz Integrated 24-bit RAMDAC up to 2048x1536@75 Hz * Multiplexed Digital Display Channels (Support with ADD2 Card (Advanced Digital Display)
Expansion Slot & Headers	* One PCI Express x16, two PCI Express x1 Slots * 32-bit PCI slot x 3
Integrate IDE	* One IDE controllers support PCI Bus Mastering, ATA PIO/DMA and the ULTRA DMA 33/66/100 functions that deliver the data transfer rate up to 100 MB/s * Four Serial ATA Host controllers, that deliver the data transfer rate up to 150 MB/s
Serial-ATA IDE	* SiS 180 RAID Controller provide two Serial ATA ports support 150Mb/s data transfer rate and one Parallel ATA133 port support 133Mb/s data transfer rate * Support Ultra Mode Function * Support RAID 0 or 1, RAID 0+1 function
LAN On Board (only for 917PBAG/917GBAG)	* Realtek 8110S PCI Interface Gigabit Ethernet (GbE) controller * Supports 10/100/1000 Mb/sec data transfer rate
Audio	* Realtek ALC880 8-channel High Definition Audio Codec integrated * Support 8-channel 3D surround & Positioning Audio * SPDIF-In/ SPDIF-Out Optical support (Cable optional) * Audio driver and utility included
BIOS	* Award 4MB Flash ROM
Multi I/O	* PS/2 keyboard and PS/2 mouse connectors * Floppy disk drive connector x1 * Parallel port x1, Serial port x2 * USB 2.0 connector x4, headers x4 (connecting cable option) * High Definition Audio connector (Line-in, MIC, 4x Line-Out)

1-3 Performance List

The following performance data list is the testing result of some popular benchmark testing programs. These data are just referred by users, and there is no responsibility for different testing data values gotten by users (the different Hardware & Software configuration will result in different benchmark testing results.)

Performance Test Report

CPU: Intel Pentium 4 Prescott 3.6G
DRAM: PMI SAMSUNG 512M DDR2-533 X 2 1Gbyte Memory
 TwinMOS Hynix Hy5du56822CT 512M DDR400 X 2 (1Gbyte) Memory
On Board VGA: On Board VGA share 32M (1024X768X32BIT Color)
Hard Disk Driver: Seagate Barracude 7200.7 SATA150
BIOS: Award Optimal default
OS: Win XP Professional (Service Pack 1)

917GBAG	Onboard VGA + DDR400	Onboard VGA + DDR2-533
3D Mark 2001SE	5142	5448
3D Mark 2003	1301	1373
3D Mark 2005	249	271
AQUAMRK3 (GFX / CPU)	8277 (870 / 8235)	8828 (930 / 8552)
PCMark2004		
System / CPU / Memory	3332 / 3609 / 4316	3499 / 3657 / 4323
Graph / HDD	995 / 4181	1036 / 4180
Content Creation Winstone 2004	27	27.9
Business Winstone 2004	20.8	22.4
Winbench 99 V2.0:		
Business/Hi-end Disk Winmark99	7260 / 30600	7420 / 27300
Business/Hi-end Graphic Winmark	378 / 1010	381 / 1010
SISMark 2004: SISMark Rating(Internet Content Creation / Office Productivity)		
SISMark 2004	164 (164 / 164)	160 (158 / 161)
3D Creation / 2D Creation	174 / 176	163 / 181
/ Web publication	143	133
Communication / Document Creation	149 / 168	145 / 164
/ Data Analysis	177	174
SISOFT Sandra 2004 : 1.CPU Arithmetic Benchmark 2.Memory bandwidth Benchmark 3.CPU Multi-Media Benchmark		
1.Dhrystone ALU MIPS	8106	7939
Whetstone FPU iSSE2 FLOPS	4242 / 5790	4248 / 5742
2.Int/Float Buffered iSSE2 MB/S	4442 / 4442	4650 / 4683
3.Integer/Floating-Point SSE2 IT/S	25052 / 29049	24823 / 28404
UT2003 Benchmark (flyby/botmatch)	75.52 / 27.83	78.82 / 30.65
Quake3 DEMO1 / DEMO2 FPS	129.9 / 123.4	134.2 / 130.1
Return to Castle Wolfenstein FPS	78.8	79.1
Super Pi (1M) Second	37s	36s
CPUZ System / CPU Clock	200.0 / 3600.0	200.0 / 3600.0

1-4 Layout Diagram & Jumper Setting

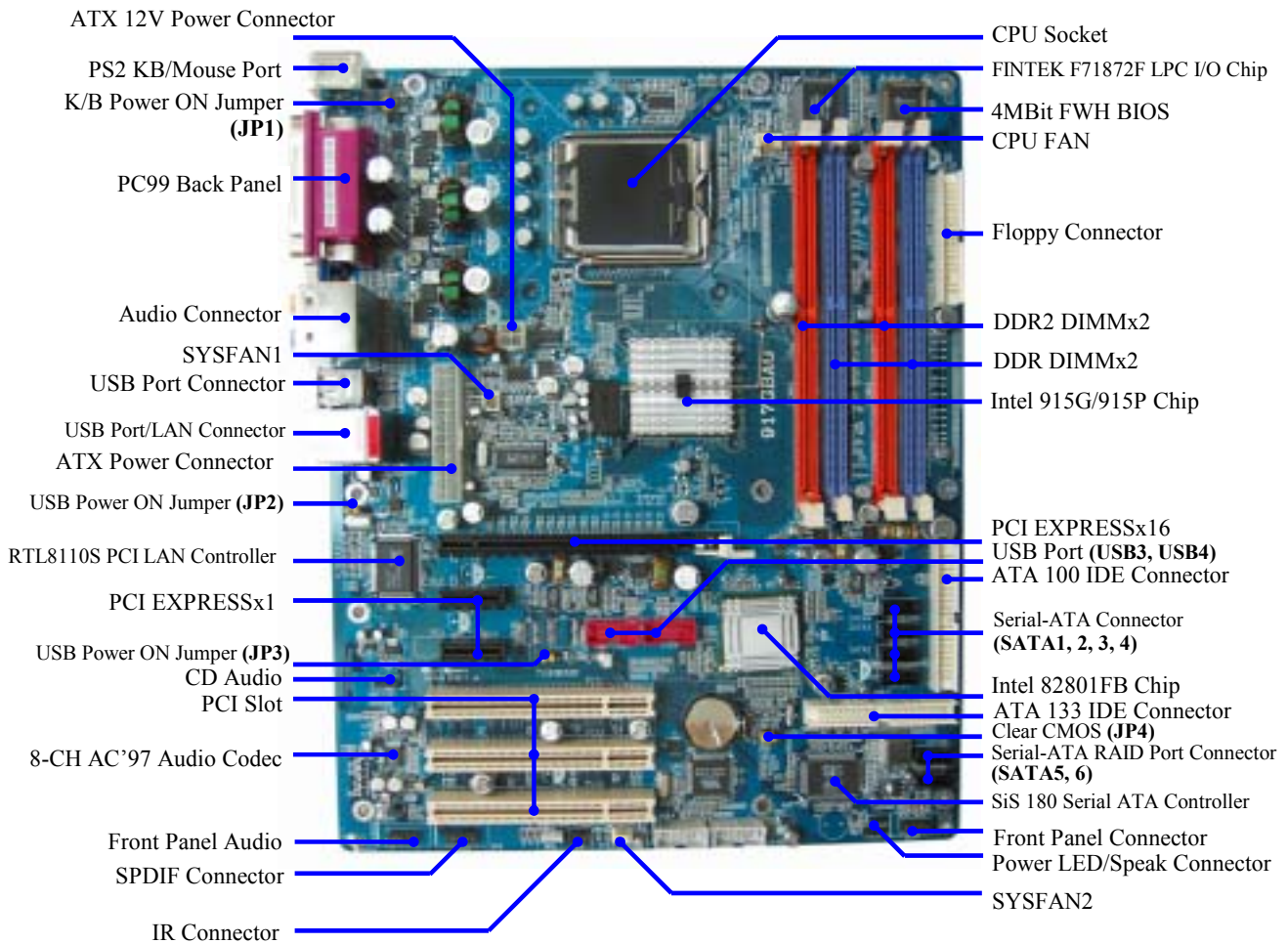
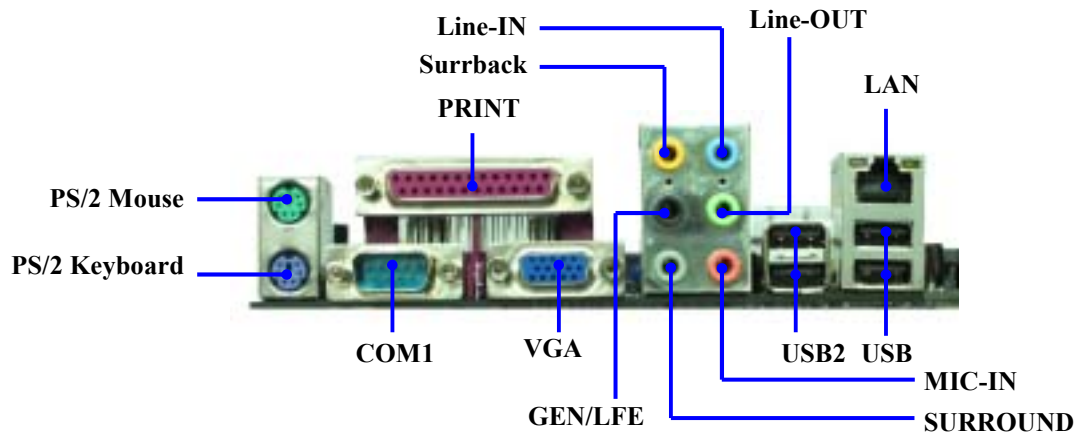

Jumpers

Jumper	Name	Description	Page
JP4	CMOS RAM Clear	3-pin Block	P.6
JP1	Keyboard Power On Enable/Disabled	3-pin Block	P.7
JP2/JP3	USB Power On Enable/Disabled	3-pin Block	P.7

Connectors

Connector	Name	Description	Page
ATXPWR	ATX Power Connector	24-pin Block	P.22
ATX12V	ATX 12V Power Connector	4-pin Block	P.22
USB1/USB2	USB Port Connector	4-pin Connector	P.22
LAN (for 917PBAG/917GBAG)	LAN Connectors	RJ-45 Connector	P.22
PS2 KB/MOUSE	PS/2 Mouse & PS/2 Keyboard Connector	6-pin Female	P.22
PARALLEL	Parallel Port Connector	25-pin Female	P.22
J1	Audio Line In/Out MIC Connector	6 phone jack Connector	P.22
VGA (for 917GBAG/917GBA)	VGA Display Connector	15-pin Female Connector	P.22
COM2 (for 917PBAG/917PBA)	Serial Port COM2 Connector	9-pin Connector	P.22
COM1	Serial Port COM1 Connector	9-pin Connector	P.22
FDD	Floppy Driver Connector	34-pin Block	P.23
IDE1/IDE2	Primary/Secondary Connector	40-pin Block	P.23
SATA1~4	Serial-ATA Port Connector	7-pin Block	P.24
SATA5, SATA6	Serial-ATA Port Connector (Support RAID Function)	7-pin Block	P.24

Headers

Header	Name	Description	Page
AUDIO	Line-Out, MIC Headers	9-pin Block	P.24
USB3/USB4	USB Port Headers	9-pin Block	P.24
SPEAK	Speaker connector	4-pin Block	P.25
FP (Power LED/Reset/ IDE LED/ Power Button)	Front Panel Header (including Power LED/ IDE activity LED/ Reset switch / Power On Button lead)	9-pin Block	P.25
CPUFAN	CPUFAN Power Header	4-pin Block	P.25
SYSFAN1, SYSFAN2	FAN Power Headers	3-pin Block	P.25
IR	IR infrared module Headers	5-pin Block	P.26
CDIN	CD Audio-In Headers	4-pin Block	P.26
JP6 (SPDIF)	SPDIF In/Out Header	10-pin Block	P.26

Expansion Sockets

Socket/Slot	Name	Description	Page
LGA 775 Socket	CPU Socket	LGA 775 CPU Socket	P.8
DIMM1, DIMM3	DDR2 Module Socket	240-pin DDR2 RAM Module Expansion Socket	P.18
DIMM2, DIMM4	DDR Module Socket	184-pin DDR RAM Module Expansion Socket	P.18
PCI1 ~ PCI3	PCI Slot	32-bit PCI Local Bus Expansion slots	P.19
PE1	x16 PCI Express Slot	x16 PCI Express Expansion Slot	P.21
PE2/PE3	x1 PCI Express Slot	x1 PCI Express Expansion Slot	P.21

Chapter 2

Hardware installation

2-1 Hardware installation Steps

Before using your computer, you had better complete the following steps:

1. Check motherboard jumper setting
2. Install CPU and Fan
3. Install System Memory (DIMM)
4. Install Expansion cards
5. Connect IDE and Floppy cables, Front Panel /Back Panel cable
6. Connect ATX Power cable
7. Power-On and Load Standard Default
8. Reboot
9. Install Operating System
10. Install Driver and Utility

2-2 Checking Motherboard's Jumper Setting

(1) CMOS RAM Clear (3-pin) : JP4

A battery must be used to retain the motherboard configuration in CMOS RAM short 1-2 pins of JP4 to store the CMOS data.

To clear the CMOS, follow the procedure below:

1. Turn off the system and unplug the AC power
2. Remove ATX power cable from ATX power connector
3. Locate JP4 and short pins 2-3 for a few seconds
4. Return JP4 to its normal setting by shorting pins 1-2
5. Connect ATX power cable back to ATX power connector

Note: When should clear CMOS

1. *Troubleshooting*
2. *Forget password*
3. *After over clocking system boot fail*

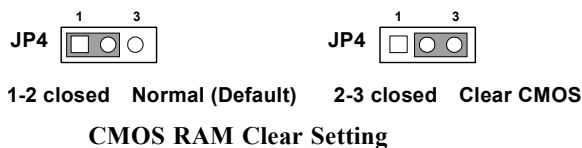

(2) Keyboard/USB Power On function Enabled/Disabled: JP1/JP2, JP3

When setting Enabled you can use keyboard by key in password/USB device to power on system.

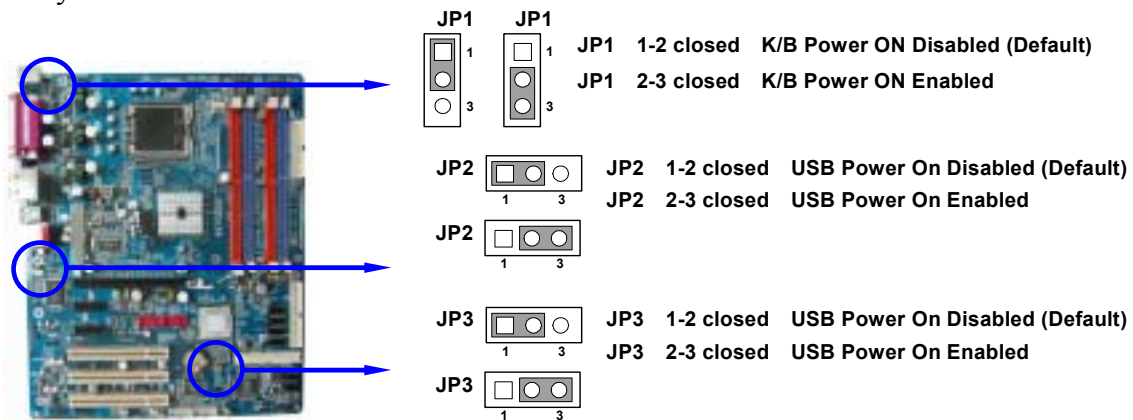

2-3 Install CPU

2-3-1 Glossary

Chipset (or core logic) - two or more integrated circuits which control the interfaces between the system processor, RAM, I/O devices, and adapter cards.

Processor slot/socket/LGA - the slot or socket used to mount the system processor on the motherboard.

Slot (PCI-E, PCI, RAM) - the slots used to mount adapter cards and system RAM.

PCI - Peripheral Component Interconnect - a high speed interface for video cards, sound cards, network interface cards, and modems; runs at 33MHz.

PCI Express- Peripheral Component Interconnect Express- a high speed interface for video cards, sound cards, network interface cards, and modems

Serial Port - a low speed interface typically used for mouse and external modems.

Parallel Port - a low speed interface typically used for printers.

PS/2 - a low speed interface used for mouse and keyboards.

USB - Universal Serial Bus - a medium speed interface typically used for mouse, keyboards, scanners, and some digital cameras.

Sound (interface) - the interface between the sound card or integrated sound connectors and speakers, MIC, game controllers, and MIDI sound devices.

LAN (interface) - Local Area Network - the interface to your local area network.

BIOS (Basic Input/Output System) - the program logic used to boot up a computer and establish the relationship between the various components.

Driver - software, which defines the characteristics of a device for use by another device or other software.

Processor - the "central processing unit" (CPU); the principal integrated circuit used for doing the "computing" in "personal computer"

Front Side Bus Frequency - the working frequency of the motherboard, which is generated by the clock generator for CPU, DRAM and PCI BUS.

CPU L2 Cache - the flash memory inside the CPU, normally Athlon CPU has 256K or above, while Duron will have 64K.

2-3-2 About Intel Pentium 4 LGA775 CPU

This motherboard provides a 775-pin surface mount, LGA775 Land Grid Array socket, referred to as the LGA775 socket supports Intel Pentium 4 processor in the 775 Pin package utilizes Flip-Chip Land Grid Array (FC-LGA4) package technology.

The CPU that comes with the motherboard should have a cooling FAN attached to prevent overheating. If this is not the case, then purchase a correct cooling FAN before you turn on your system.

WARNING! Be sure that there is sufficient air circulation across the processor's heatsink and CPU cooling FAN is working correctly, otherwise it may cause the processor and motherboard overheat and damage, you may install an auxiliary cooling FAN, if necessary.

To install a CPU, first turn off your system and remove its cover. Locate the LGA775 socket and open it by first pulling the level sideways away from the socket then upward to a 90-degree angle. Insert the CPU with the correct orientation as shown below. The notched corner should point toward the end of the level. Because the CPU has a corner pin for two of the four corners, the CPU will only fit in the orientation as shown.

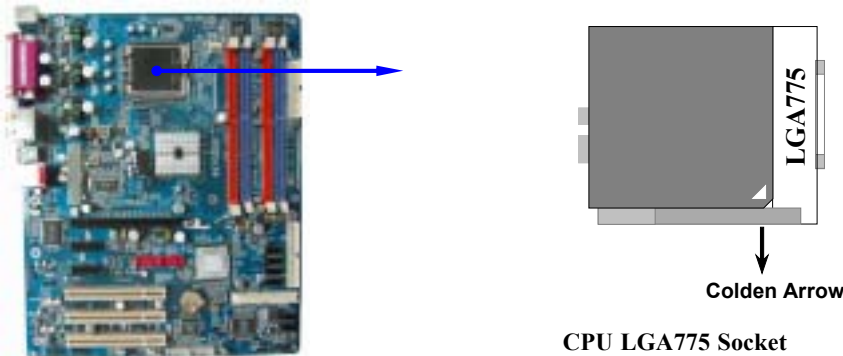

When you put the CPU into the LGA775 socket. No force require to insert of the CPU, then press the level to Locate position slightly without any extra force.

2-3-3 LGA 775 CPU Installation Guide

Socket Preparation

1. Opening the socket:

Note: Apply pressure to the corner with right hand thumb while opening/closing the load lever, otherwise lever can bounce back like a “mouse trap” and WILL cause bent contacts (when loaded)

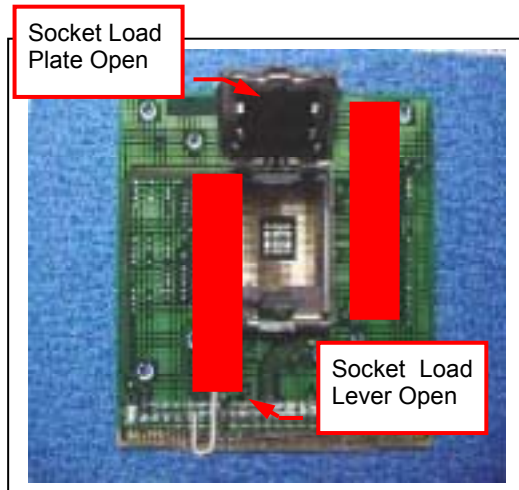

- i. Disengage Load Lever by **depressing down** and **out** on the hook to clear retention tab
- ii. Rotate Load Lever to fully open position at approximately 135degrees
- iii. Rotate Load Plate to fully open position at approximately 100degrees

2. Remove PnP Cap (Pick & Place Cap)

- i. With left hand index finger and thumb to support the load plate edge, engage PnP cap with right hand thumb and peel the cap from LGA775 Socket while pressing on center of PnP cap to assist in removal.
- ii. Set PnP cap aside. Always put PnP cap back on if the processor is removed from the socket.
- iii. Visually inspect PnP cap for damage. If damage observed, replace the PnP cap.



Note: After PnP cap removal, make sure socket load plate and contacts are free of foreign material; Refer to Overview Module for FM cleaning.

Note: Optionally, remove PnP cap after CPU insertion. This will compromise the ability to visually inspect socket.

3. Visually inspect for bent contacts (Recommend at least 1stpass visual inspection)

NOTE: Refer to the Handling and Inspection Module for 1stand 2ndpass inspection details.

NOTE: Glove images are for illustrative purposes only. Please consult local safety guidelines for specific requirements

NOTE: Recommend not to hold the load plate as a lever, instead hold at tab with left hand, removing the PnP cap with right hand

775-land LGA Package Insertion

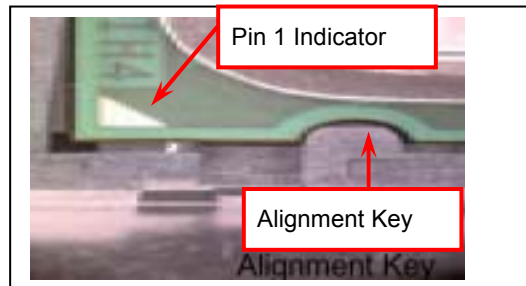

1. Lift processor package from shipping media by grasping the substrate edges ONLY.
Note: Orient processor package such that the Pin 1 triangle mark is on bottom left and both key notches are on left side
2. Land Side Cover Handling: Remove land side cover with the opposite hand by depressing larger retention tab and peeling the cover away
3. Set and reserve the land side cover aside.
Note: Always keep the land side cover on the processor when not in the socket.
4. Visually inspect the package gold pads: Scan the processor package gold pad array for presence of foreign material. Refer to Overview Module for FM cleaning recommendations
5. Orient the package with IHS up. Locate Pin 1 and the two orientation key notches
6. Carefully place the package into the socket body using a purely vertical motion

CAUTION: Using Vacuum Pen for installation is *not* recommended

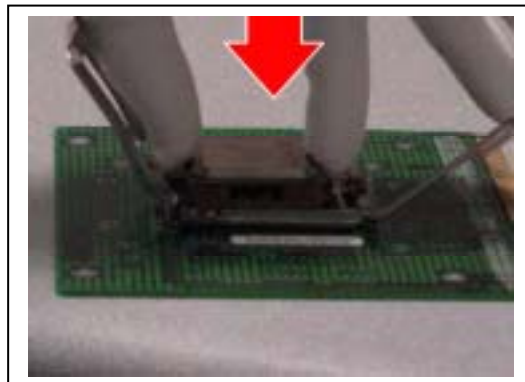

7. Verify that package is within the socket body and properly mated to the orient keys
8. Close the socket by
 - i. Rotating the Load Plate onto the package HIS
 - ii. While pressing down lightly on Load Plate, engage the Load Lever.
 - iii. Securing Load Lever with Load Plate tab under retention tab of Load Lever

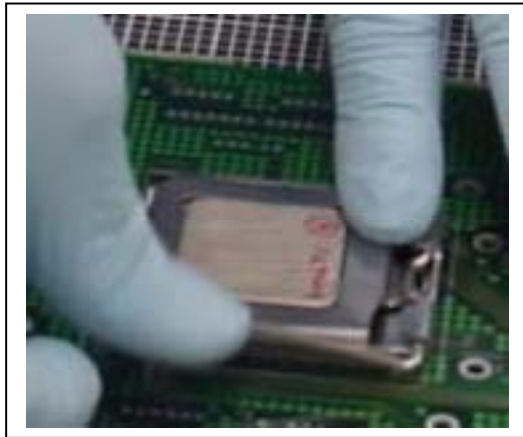

775-Land Package Removal

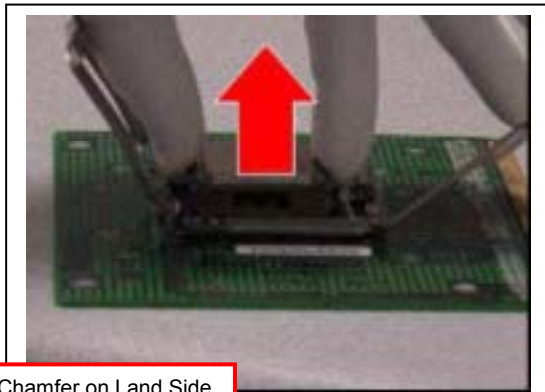

Chamfer on Land Side Cover (align this with pin 1 mark on 775-land LGA package)



Large Retention Tabs (pointing towards user)

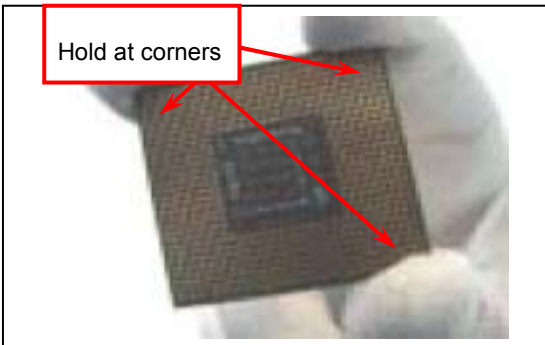

Hold at corners

1. Open the Load Plate/Lever with both hands: With left hand index finger and thumb to support the load plate edge, engage PnP cap with right hand thumb and peel the cap from LGA775 Socket while pressing on center of PnP cap to assist in removal.
2. Pick up 775-land LGA package:
 - By Vacuum Pen: Place a minimum 9-mm cup at approximately the center of IHS.
 - Recommend not to place Vacuum Pen on IHS edge. Risk of dropping and causing bent contact.
 - Recommend not to use Vacuum Pen for inserting CPU By Hand: Index finger to hold load plate hinge side and thumb to hold load lever side
3. Lift the package straight up and away.
4. Assemble processors land side cover immediately to prevent contamination.
 - i. While holding the processor by the 3 corners, the other hand lift land side cover from work surface by grasping at the large retention tabs. Ensure retention tabs and package are pointing each other.
 - ii. Orientate so that land side cover chamfer is matching with package Pin 1 location.
 - iii. Hook the first large retention tab on the package substrate. Then press the opposite tab onto the substrate.
 - iv. Place processor with land side cover installed onto proper shipping media or other ESD approved work surface

5. Visually inspect socket contact array

1. First Pass Inspection

- i. Scan socket contact array at varying angles noting the presence of any foreign material
- ii. If foreign material can't be blown off by compressed air, or mechanical damage (Mode1 or 4) observed, reject the motherboard for further evaluation or socket replacement.

2. Second Pass Inspection

- i. Repeat 2 more times to sight down the rows and columns from each of the 4 sides of the socket to ensure all contacts within the array are inspected
- ii. Inspect for Mode2, Mode3, and Mode5 failures

Note: Refer to the Test Module for detail visual inspections

6. Assemble LGA775 socket PnP cap

- i. Secure/Hook the back side of PnP cap.
- ii. Snap down the front side to fully secure

7. Close the Socket

Intel Reference Thermal Solution Assembly

NOTE: Depending on the configuration, Thermal Solution Integration procedure could perform with M/B alone or with M/B in the Chassis.



0.150-inch backside clearance for fastener installation

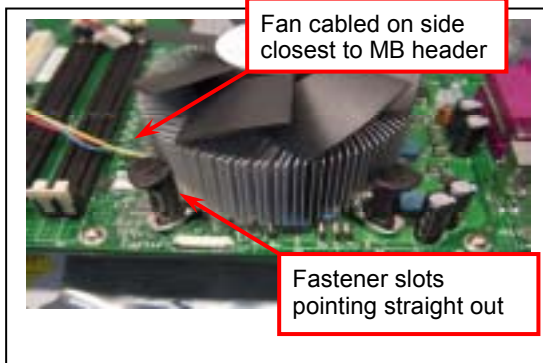
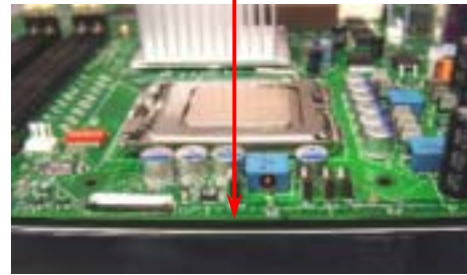

1. Place motherboard on support structure providing minimum 0.150-inch backside clearance
2. Apply 300 mg of Thermal Interface Material (Shin-Etsu G751) onto center of IHS

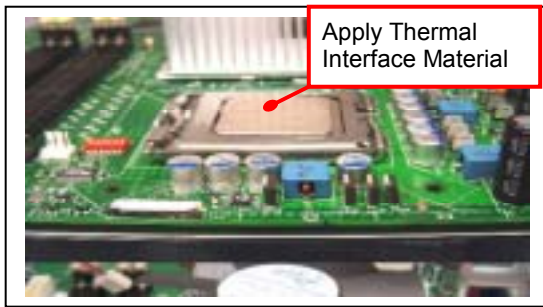

NOTE: Thermal Solutions that come with Intel® boxed processor use pre-applied thermal interface material and not grease.

3. Remove Heat Sink (HS) from packaging media
4. Place HS onto the LGA775 Socket
 - Ensure fan cables are oriented on side closest to fan header
 - Align Fasteners with MB through-holes

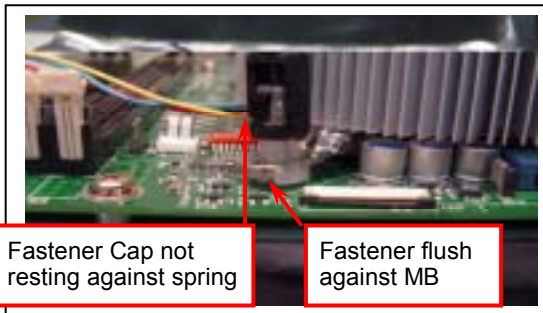

5. Inspection
 - Ensure cables are not trapped or interfere fastener operation
 - Ensure fastener slots are pointing straight out from heatsink

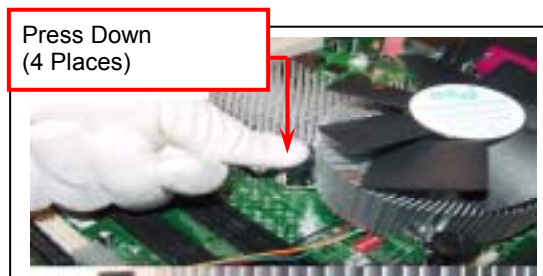

6. Actuate fasteners
 - While holding HS to prevent tilting, press down on fastener caps with thumb to install and lock
- Repeat with remaining fasteners

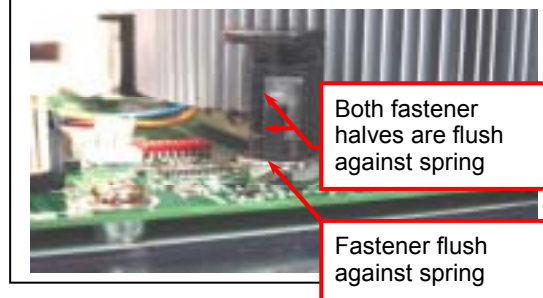

7. Inspection
 - Verify the fasteners are properly seated
 - Ensure both fastener cap and base are flush with spring and motherboard
8. Connect fan header with Board header

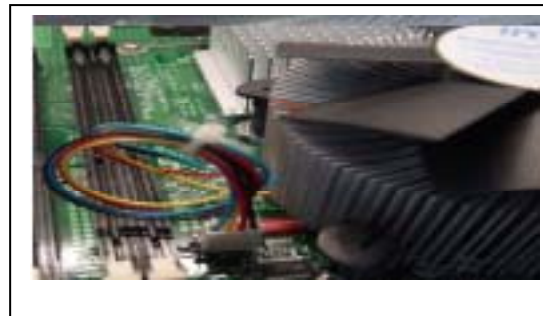

9. Secure excess cable with tie-wrap to ensure cable does not interfere with fan operation or contact other components.

Intel Reference Thermal Solution Disassembly

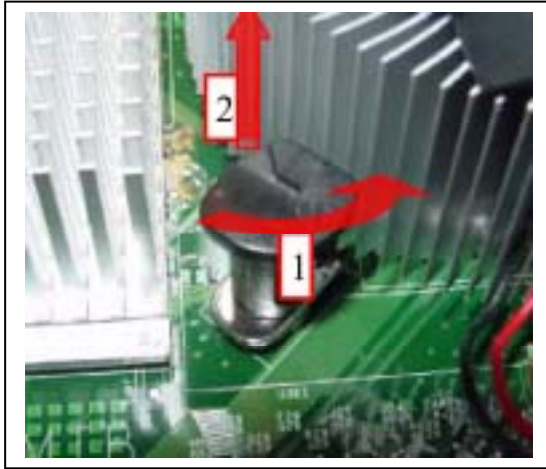

1. Rotate fastener cap. turn to un-lock
 2. Pull up fastener cap to un-seat
1. Disconnect fan cable from motherboard header
 2. Turn fastener caps (4) counter-clock wise 90degrees to the un-locked position
 - A flat-bladed screwdriver may be used if required
 3. Pull up on fastener caps to unseat
 4. Manually remove HS with gentle twist motion.
 5. To re-assemble the HS, reset the fastener caps to their original position with the slot perpendicular to the HS. Then, follow the assembly instructions.

Note: Thermal grease should be reapplied

TIM and Grease Removal from CPU

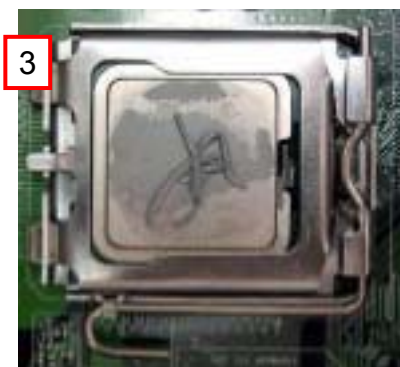
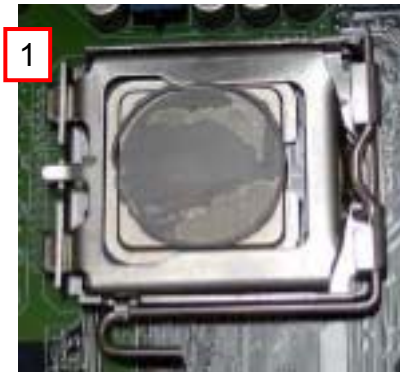

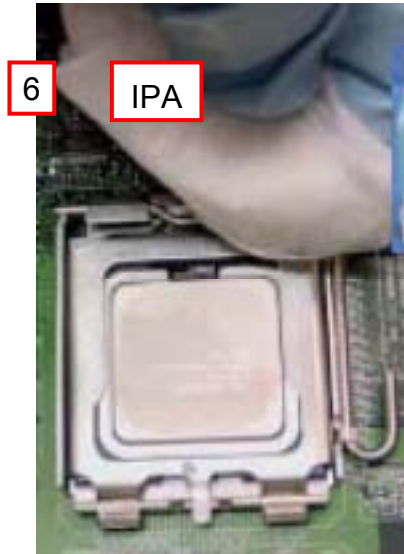
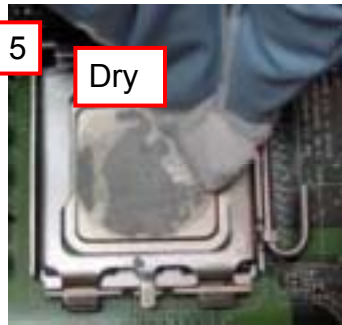

1. Remove the heatsink from the socket
2. Gently push loose thermal interface material (TIM) to center of processor (pictures 2 and 3)
3. Remove pieces with dry cloth (picture 4)
4. Wipe with dry, lint-free cloth to remove most of the material (picture 5)
5. Wet another lint-free cloth with isopropyl alcohol (IPA) and wipe to clean remaining material (picture 6)
6. Be careful to remove material from gaps between processor and load plate
7. For thermal grease removal use Step 4-6

TIM and Grease Removal from Heat-sink

Note: Remove and replace the TIM from the heatsink if you are re-using the heatsink on a new processor

1. Use dry, lint-free cloth and wipe package to remove most of the material
2. Wet another lint-free cloth with isopropyl alcohol (IPA) and wipe heatsink to clean remaining material

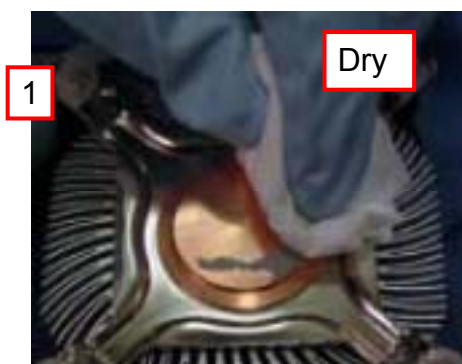

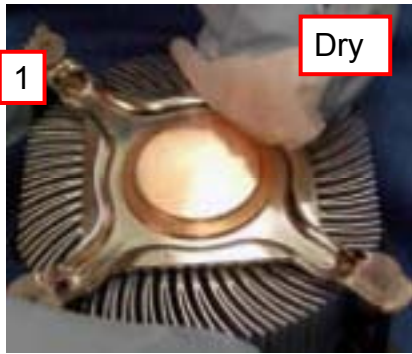

Replacing Damaged Fasteners

- To prevent damage, avoid setting the thermal solution with the prongs down
 - Set on heatsink side or with fan down
- The plastic fasteners on the heatsink can be replaced.
 - Use Shop Intel to order spare fasteners
 - <http://www.shop-intel.com>
- To remove a damaged fastener

Note: Protective gloves are not required for this procedure

- Rotate the black pin counterclockwise until it “snaps”. There will be some resistance
- Remove the black pin from the white prong
- Tilt the white prong to remove it from the heatsink leg

Avoid damage, avoid placing prongs on hard surface

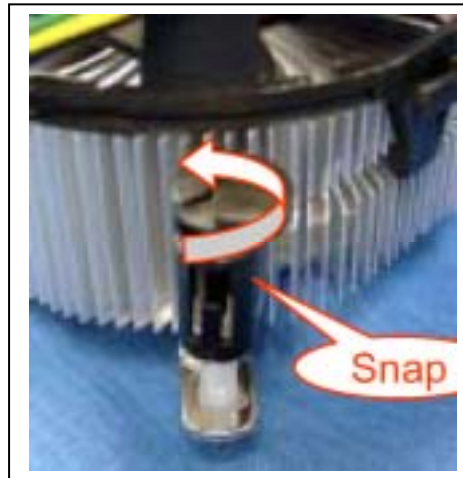

Damaged. Attempts to straighten not recommended

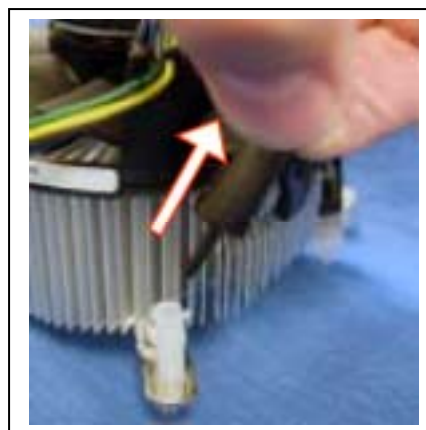
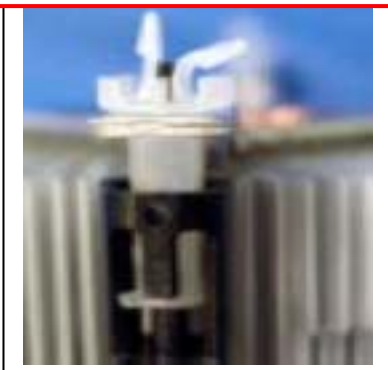

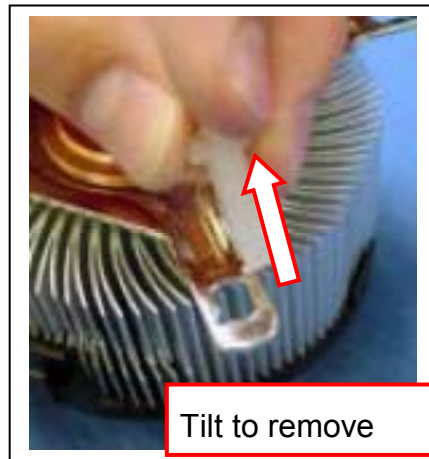

Replacing Fasteners

- To **replace** the fastener
 - Start with the white prong
 - Note the “keying” notch feature
 - Tilt the prong to insert into the heatsink leg.
 - Holding the white prong without bending it, push the black pin on from the bottom until you hear a single “click”

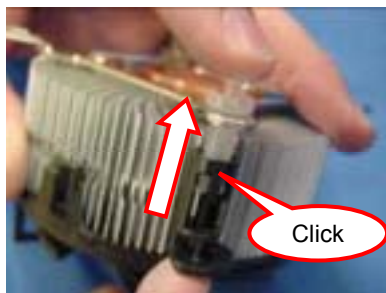
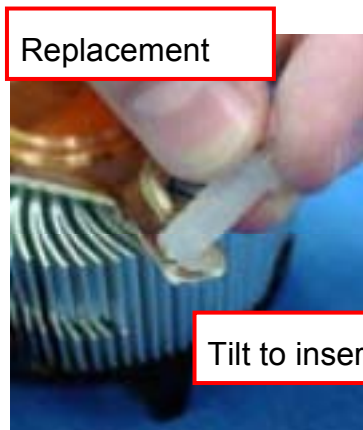

Note: The black pin and white prong will only “snap” on in one orientation

- Check to ensure the black pin is rotated properly for installation with the slot perpendicular to the heatsink

2-4 Install Memory

This motherboard provides **two** 184-pin DDR DUAL INLINE MEMORY MODULES (DIMM) and **two** 240-pin DDR2 DUAL INLINE MEMORY MODULES (DIMM) sites for memory expansion available from minimum memory size of 128MB to maximum memory size of 2.0GB DDR SDRAM.

Valid Memory Configurations

DIMM1	DIMM2	DIMM3	DIMM4	Total Memory
DDR2 533/ DDR2 400 SRAM Module	X	X	X	128M~1G
DDR2 533/ DDR2 400 SRAM Module	X	DDR2 533/ DDR2 400 SRAM Module	X	128M~2G
X	DDR333/DDR400 SDRAM Module	X	X	128M~1G
X	DDR333/DDR400 SDRAM Module	X	DDR333/DDR400 SDRAM Module	128M~2G

Only these combinations can accept others are not accept.

WARNING :

Users only can install either 184-pin DDR RAM Module or 240-pin DDR2 RAM Module at same time ,DDR RAM Module and DDR2 RAM Module can not work together

For Dual channel Limited!

1. Dual channel function only supports when 2 DIMM Modules plug in either both DIMM1 & DIMM3 or DIMM2 & DIMM4, or four DIMM Modules plug in DIMM1~DIMM4.
2. DIMM1 & DIMM3, or DIMM2 & DIMM4 must be the same type, same size, same frequency for dual channel function.

Generally installing DDR RAM Modules or DDR2 RAM Modules to your motherboard is very easy, you can refer to figure 2-4 to see what a 184-Pin DDR333/DDR400 DDR SDRAM module looks like.

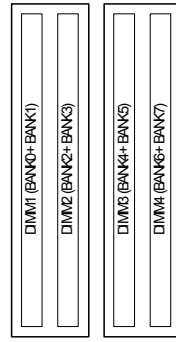

DIMM1 & DIMM3: Dual Channel 1 for DDR2

DIMM2 & DIMM4: Dual Channel 2 for DDR

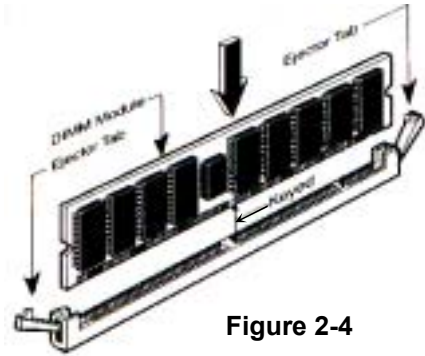

Figure 2-4

NOTE! When you install DIMM module fully into the DIMM socket the eject tab should be locked into the DIMM module very firmly and fit into its indentation on both sides.

2-5 Expansion Cards

WARNING! Turn off your power when adding or removing expansion cards or other system components. Failure to do so may cause severe damage to both your motherboard and expansion cards.

2-5-1 Procedure For Expansion Card Installation

1. Read the documentation for your expansion card and make any necessary hardware or software setting for your expansion card such as jumpers.
2. Remove your computer's cover and the bracket plate on the slot you intend to use.
3. Align the card's connectors and press firmly.
4. Secure the card on the slot with the screen you remove above.
5. Replace the computer system's cover.
6. Set up the BIOS if necessary.
7. Install the necessary software driver for your expansion card.

2-5-2 Assigning IRQs For Expansion Card

Some expansion cards need an IRQ to operate. Generally, an IRQ must exclusively assign to one use. In a standard design, there are 16 IRQs available but most of them are already in use.

Standard Interrupt Assignments

IRQ	Priority	Standard function
0	N/A	System Timer
1	N/A	Keyboard Controller
2	N/A	Programmable Interrupt
3 *	8	Communications Port (COM2)
4 *	9	Communications Port (COM1)
5 *	6	Sound Card (sometimes LPT2)
6 *	11	Floppy Disk Controller
7 *	7	Printer Port (LPT1)
8	N/A	System CMOS/Real Time Clock
9 *	10	ACPI Mode when enabled
10 *	3	IRQ Holder for PCI Steering
11 *	2	IRQ Holder for PCI Steering
12 *	4	PS/2 Compatible Mouse Port
13	N/A	Numeric Data Processor
14 *	5	Primary IDE Channel
15 *	1	Secondary IDE Channel

* These IRQs are usually available for ISA or PCI devices.

2-5-3 Interrupt Request Table For This Motherboard

Interrupt request are shared as shown the table below:

	INT A	INT B	INT C	INT D	INT E	INT F	INT G	INT H
Slot 1		√						
Slot 2			√					
Slot 3				√				
Slot 4						√		
Onboard VGA	√							
Onboard LAN					√			
Onboard USB 1								√
Onboard USB 2				√				
Onboard USB 3			√					
Sound		√						

IMPORTANT! If using PCI cards on shared slots, make sure that the drivers support “Shared IRQ” or that the cards don’t need IRQ assignments. Conflicts will arise between the two PCI groups that will make the system unstable or cards inoperable.

2-5-4 PCI Express Slot

This motherboard provides one 16-lane PCI Express slot intended for Graphics Attach, and two x1 PCI Express Slot. Fully compliant to the *PCI Express Base Specification revision 1.0a*, support PCI Express VGA card, and other PCI Express device.

The x16 PCI Express Slot also supports Advanced Digital Display II Card (ADD2) for digital display and TV-out.



2-6 Connectors, Headers

2-6-1 Connectors

(1) Power Connector (24-pin block) : ATXPWR

ATX Power Supply connector. This is a new defined 24-pins connector that usually comes with ATX case. The ATX Power Supply allows to use soft power on momentary switch that connect from the front panel switch to 2-pins Power On jumper pole on the motherboard. When the power switch on the back of the ATX power supply turned on, the full power will not come into the system board until the front panel switch is momentarily pressed. Press this switch again will turn off the power to the system board.

- ** We recommend that you use an ATX 12V Specification 2.0-compliant power supply unit (PSU) with a minimum of 350W power rating. This type has 24-pin and 4-pin power plugs.
- ** If you intend to use a PSU with 20-pin and 4-pin power plugs, make sure that the 20-pin power plug can provide at least 15A on +12V and the power supply unit has a minimum power rating of 350W. The system may become unstable or may not boot up if the power is inadequate.

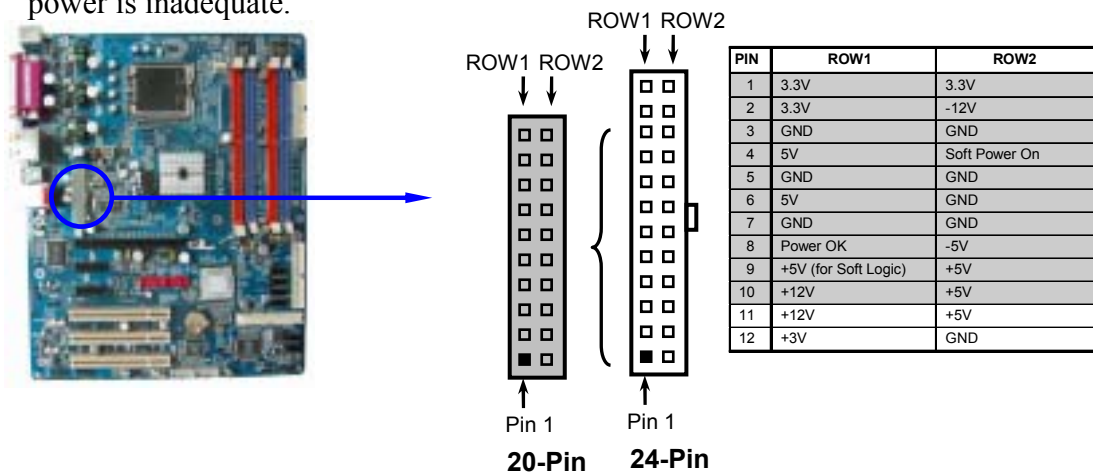

(2) **ATX 12V Power Connector (4-pin block) : ATX12V**

This is a new defined 4-pins connector that usually comes with ATX Power Supply. The ATX Power Supply which fully support Pentium 4 processor must including this connector for support extra 12V voltage to maintain system power consumption. Without this connector might cause system unstable because the power supply can not provide sufficient current for system.

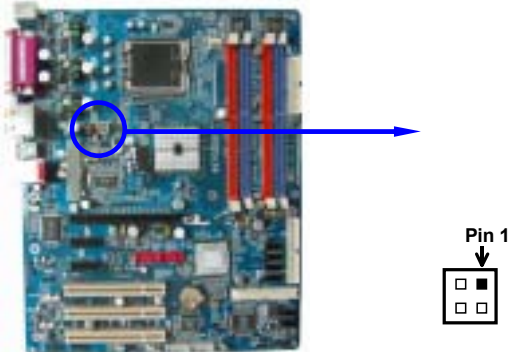

(3) **USB Port connector: USB1**

(4) **USB Port connector: UL1 (USB)**

The connectors are 4-pin connector that connect USB devices to the system board.

(5) **LAN Port connector: LAN(only for 917PBAG/917GBAG)**

This connector is standard RJ45 connector for Network connector.

(6) **PS/2 Mouse & PS/2 Keyboard Connector: KB (PS2 KB/MOUSE)**

The connectors for PS/2 keyboard and PS/2 Mouse.

(7) **Parallel Port Connector (25-pin female): PARALLEL**

Parallel Port connector is a 25-pin D-Subminiature Receptacle connector. The On-board Parallel Port can be disabled through the BIOS SETUP. Please refer to Chapter 3 “INTEGRATED PERIPHERALS SETUP” section for more detail information.

(8) **VGA Connector (15-pin D-Sub) Connector: VGA (for 917GBAG/917GBA only)**

VGA is the 15-pin D-Subminiature female connector for display monitor

(9) **Audio Line-In, Lin-Out, MIC, Surrback, Surround, GEN/LEF Connector : J1**

This Connector are 6 phone Jack for LINE-OUT, LINE-IN, MIC, Surrback, Surround, GEN/LEF

Line-out : (GREEN) Audio output to speaker

Line-in : (BLUE) Audio input to sound chip

MIC : (PINK) Microphone Connector

Surrback : (ORANGE) Audio output to speaker-Rear speaker out

Surround : (BLACKNESS) Audio output to speaker-Center/Subwoofer speaker out

GEN/LEF: (GRAY) Audio output to speaker-Side speaker out

(10) **Serial Port COM1/COM2(COM2 only for 917PBAG/917PBA):**

COM1/COM2 is the 9-pin D-Subminiature mail connector. The On-board serial port can be disabled through BIOS SETUP. Please refer to Chapter 3 “INTEGRATED PERIPHERALS SETUP” section for more detail information.

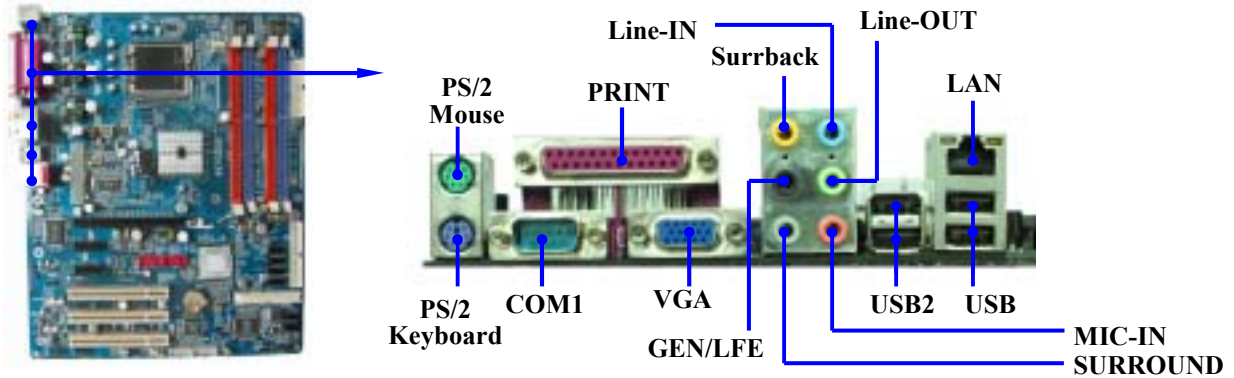

(11) Floppy drive Connector (34-pin block): FDD

This connector supports the provided floppy drive ribbon cable. After connecting the single plug end to motherboard, connect the two plugs at other end to the floppy drives.

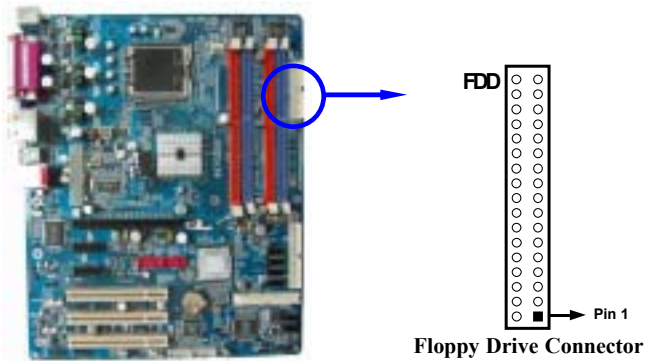

(12) Primary IDE Connector (40-pin block): IDE1 (Support ATA 100)

This connector supports the provided IDE hard disk ribbon cable. After connecting the single plug end to motherboard, connect the two plugs at other end to your hard disk(s). If you install two hard disks, you must configure the second drive to Slave mode by setting its jumpers accordingly. Please refer to the documentation of your hard disk for the jumper settings.

(13) Secondary IDE Connector (40-pin block): IDE2 (Support ATA 133)

This connector connects to the next set of Master and Slave hard disks. Follow the same procedure described for the primary IDE connector. You may also configure two hard disks to be both Masters using one ribbon cable on the primary IDE connector and another ribbon cable on the secondary IDE connector.

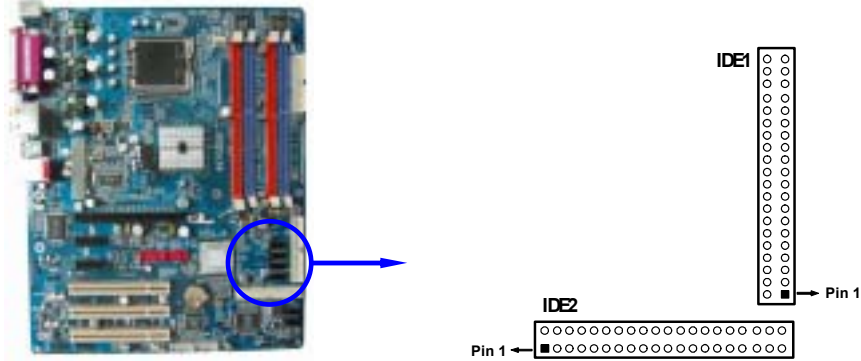

- Two hard disks can be connected to each connector. The first HDD is referred to as the “Master” and the second HDD is referred to as the “Slave”.
- For performance issues, we strongly suggest you don’t install a CD-ROM or DVD-ROM drive on the same IDE channel as a hard disk. Otherwise, the system performance on this channel may drop.

(14) Serial-ATA Port connector: SATA1/SATA2/SATA3/SATA4

This connector support the provided Serial ATA IDE hard disk cable to connecting the motherboard and serial ATA hard disk.

Serial-ATA RAID Port connector: SATA5/SATA6

This port support RAID0, RAID1, RAID0+1 functions.

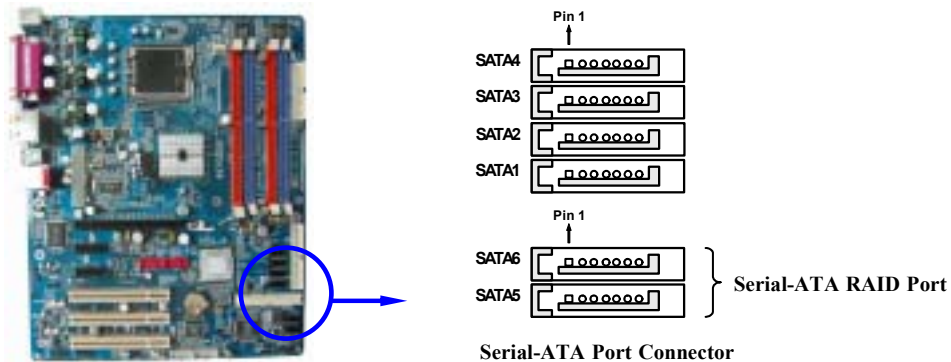

2-6-2 Headers

(1) Line-Out, MIC Header (9-pin): AUDIO

This header connect to Front Panel Line-out, MIC connector with cable.

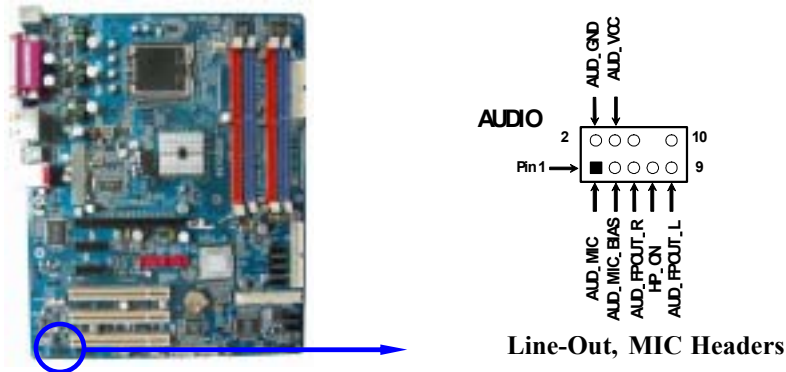

(2) USB Port Headers (9-pin) : USB3, USB4

The header is used for connecting the additional USB port plug. By attaching an option USB cable, your can be provided with two additional USB plugs affixed to the back panel.

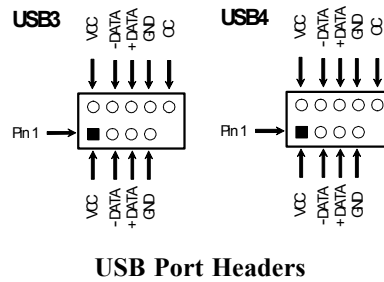

(3) IDE Activity LED: IDE LED

This connector connects to the hard disk activity indicator light on the case.

(4) Reset switch lead: RESET

This 2-pin connector connects to the case-mounted reset switch for rebooting your computer without having to turn off your power switch. This is a preferred method of rebooting in order to prolong the life of the system's power supply. See the figure below.

(5) Power LED: PWR-LED

The Power LED is light on while the system power is on. Connect the Power LED from the system case to this pin.

(6) Speaker connector: SPEAK

This 4-pin connector connects to the case-mounted speaker. See the figure below.

(7) Power switch: PWR BTN

This 2-pin connector connects to the case-mounted power switch to power ON/OFF the system.

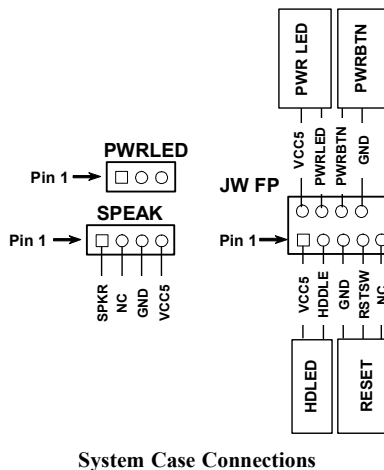

(8) FAN Power Headers: SYSFAN1, SYSFAN2 (3-pin), CPUFAN (4-pin)

These connectors support cooling fans of 350mA (4.2 Watts) or less, depending on the fan manufacturer, the wire and plug may be different. The red wire should be positive, while the black should be ground. Connect the fan's plug to the board taking into consideration the polarity of connector.

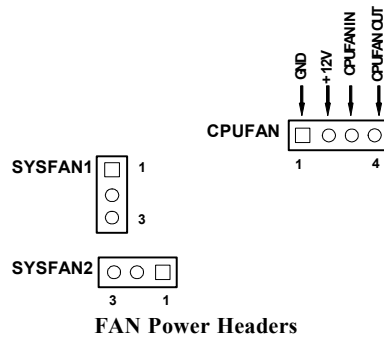
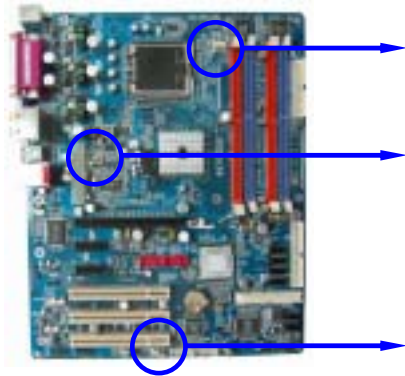

(9) IR infrared module Headers (5-pin) : IR

This connector supports the optional wireless transmitting and receiving infrared module. You must configure the setting through the BIOS setup to use the IR function.

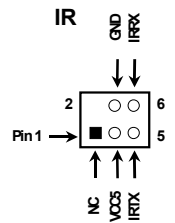

(10) CD Audio-In Headers (4-pin) : CDIN

CDIN are the connectors for CD-Audio Input signal. Please connect it to CD-ROM CD-Audio output connector.

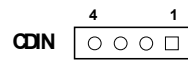

(11) SPDIF In/Out Header: JP6

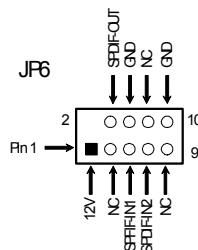

2-7 Starting Up Your Computer

1. After all connection are made, close your computer case cover.
2. Be sure all the switch are off, and check that the power supply input voltage is set to proper position, usually in-put voltage is 220V~240V or 110V~120V depending on your country's voltage used.
3. Connect the power supply cord into the power supply located on the back of your system case according to your system user's manual.
4. Turn on your peripheral as following order:
 - a. Your monitor.
 - b. Other external peripheral (Printer, Scanner, External Modem etc...)
 - c. Your system power. For ATX power supplies, you need to turn on the power supply and press the ATX power switch on the front side of the case.
5. The power LED on the front panel of the system case will light. The LED on the monitor may light up or switch between orange and green after the system is on. If it complies with green standards or if it is has a power standby feature. The system will then run power-on test. While the test are running, the BIOS will alarm beeps or additional message will appear on the screen.

If you do not see any thing within 30 seconds from the time you turn on the power. The system may have failed on power-on test. Recheck your jumper settings and connections or call your retailer for assistance.

Beep	Meaning
One short beep when displaying logo	No error during POST
Long beeps in an endless loop	No DRAM install or detected
One long beep followed by three short beeps	Video card not found or video card memory bad
High frequency beeps when system is working	CPU overheated System running at a lower frequency

6. During power-on, press <Delete> key to enter BIOS setup. Follow the instructions in BIOS SETUP.
7. **Power off your computer:** You must first exit or shut down your operating system before switch off the power switch. For ATX power supply, you can press ATX power switching after exiting or shutting down your operating system. If you use Windows 9X, click "Start" button, click "Shut down" and then click "Shut down the computer?" The power supply should turn off after windows shut down.

Chapter 3

Introducing BIOS

The BIOS is a program located on a Flash Memory on the motherboard. This program is a bridge between motherboard and operating system. When you start the computer, the BIOS program gain control. The BIOS first operates an auto-diagnostic test called POST (power on self test) for all the necessary hardware, it detects the entire hardware device and configures the parameters of the hardware synchronization. Only when these tasks are completed done it gives up control of the computer to operating system (OS). Since the BIOS is the only channel for hardware and software to communicate, it is the key factor for system stability, and in ensuring that your system performance as its best.

In the BIOS Setup main menu of Figure 3-1, you can see several options. We will explain these options step by step in the following pages of this chapter, but let us first see a short description of the function keys you may use here:

- Press <Esc> to quit the BIOS Setup.
- Press ↑↓←→ (up, down, left, right) to choose, in the main menu, the option you want to confirm or to modify.
- Press <F10> when you have completed the setup of BIOS parameters to save these parameters and to exit the BIOS Setup menu.
- Press Page Up/Page Down or +/- keys when you want to modify the BIOS parameters for the active option.

3-1 Entering Setup

Power on the computer and by pressing immediately allows you to enter Setup.

If the message disappears before your respond and you still wish to enter Setup, restart the system to try again by turning it OFF then ON or pressing the “RESET” button on the system case. You may also restart by simultaneously pressing <Ctrl>, <Alt> and <Delete> keys. If you do not press the keys at the correct time and the system does not boot, an error message will be displayed and you will again be asked to

Press <F1> to continue, <Ctrl-Alt-Esc> or to enter Setup

3-2 Getting Help

Main Menu

The on-line description of the highlighted setup function is displayed at the bottom of the screen.

Status Page Setup Menu/Option Page Setup Menu

Press F1 to pop up a small help window that describes the appropriate keys to use and the possible selections for the highlighted item. To exit the Help Window, press <Esc>.

3-3 The Main Menu

Once you enter Award® BIOS CMOS Setup Utility, the Main Menu (Figure 3-1) will appear on the screen. The Main Menu allows you to select from fourteen setup functions and two exit choices. Use arrow keys to select among the items and press <Enter> to accept or enter the sub-menu.

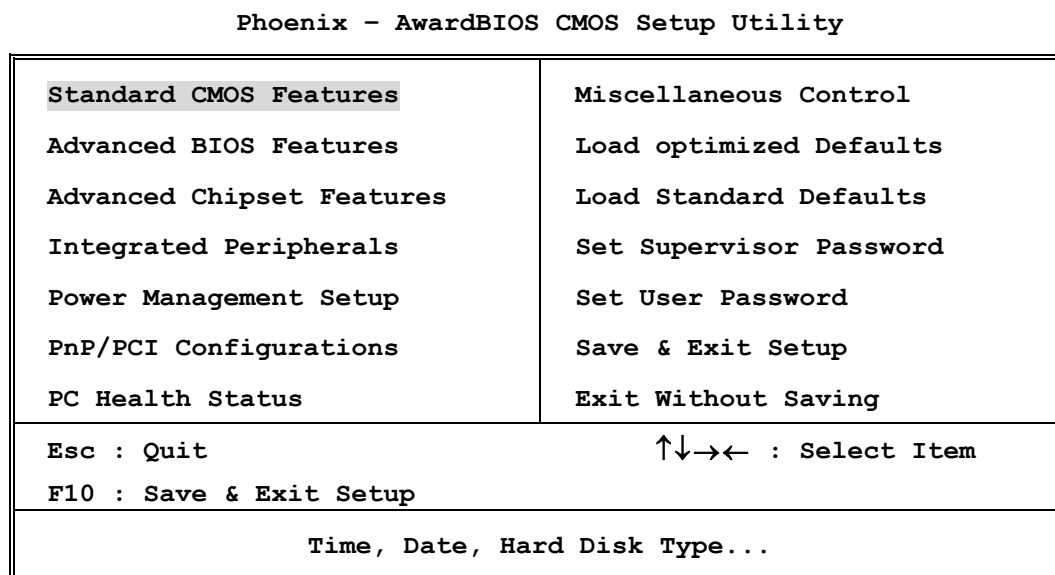

Figure 3-1

Standard CMOS Features

Use this Menu for basic system configurations.

Advanced BIOS Features

Use this menu to set the Advanced Features available on your system.

Advanced Chipset Features

Use this menu to change the values in the chipset registers and optimize your system's performance.

Integrated Peripherals

Use this menu to specify your settings for integrated peripherals.

Power Management Setup

Use this menu to specify your settings for power management.

PnP/PCI configurations

This entry appears if your system supports PnP/PCI.

PC Health Status

This entry shows your PC health status.

Miscellaneous Control

Use this menu to specify your settings for Miscellaneous control.

Load Optimized Defaults

Use this menu to load the BIOS default values that are settings for optimal performances system operations.

Load Standard Defaults

Use this menu to load the BIOS default values that are factory settings for the stable performance system operation.

Set Supervisor/User Password

Use this menu to set User and Supervisor Passwords.

Save & Exit Setup

Save CMOS value changes to CMOS and exit setup.

Exit Without Saving

Abandon all CMOS value changes and exit setup.

3-4 Standard CMOS Features

The items in Standard CMOS Setup Menu are divided into several categories. Each category includes no, one or more than one setup items. Use the arrow keys to highlight the item and then use the <PgUp> or <PgDn> keys to select the value you want in each item.

Phoenix - AwardBIOS CMOS Setup Utility
Standard CMOS Features

Date (mm:dd:yy)	Thr, June, 15 2004	Item Help
Time (hh:mm:ss)	11 : 02 : 35	
> IDE Primary Master	Press Enter None	Menu Level >
> IDE Primary Slave	Press Enter None	
> IDE Secondary Master	Press Enter None	Change the day, month, year and century
> IDE Secondary Slave	Press Enter None	
Drive A	1.44M, 3.5 in.	
Drive B	None	
Video	EGA/VGA	
Halt On	All,But Keyboard	
Base Memory	640K	
Extended Memory	56320K	
Total Memory	57344K	
↑↓→← Move Enter:Select +/-/PU/PD:Value F10:Save ESC:Exit F1:General Help F5:Previous Values F6:Optimized Defaults F7:Standard Defaults		

Date

The date format is <day><month><date><year>.

Day Day of the week, from Sun to Sat, determined by BIOS. Read-only.

Month The month from Jan. through Dec.

Date The date from 1 to 31 can be keyed by numeric function keys.

Year The year depends on the year of the BIOS.

Time

The time format is <hour><minute><second>.

Primary Master/Primary Slave

Secondary Master/Secondary Slave

Press PgUp/<+> or PgDn/<-> to select Manual, None, Auto type. Note that the specifications of your drive must match with the drive table. The hard disk will not work properly if you enter improper information for this category. If your hard disk drive type is not matched or listed, you can use Manual to define your own drive type manually.

If you select Manual, related information is asked to be entered to the following items. Enter the information directly from the keyboard. This information should be provided in the documentation from your hard disk vendor or the system manufacturer.

If the controller of HDD interface is SCSI, the selection shall be "None".

If the controller of HDD interface is CD-ROM, the selection shall be "None"

Access Mode The settings are Auto Normal, Large, and LBA.

Cylinder number of cylinders

Head number of heads

Precomp write precomp

Landing Zone landing zone

Sector number of sectors

3-5 Advanced BIOS Features

Phoenix - AwardBIOS CMOS Setup Utility

Advanced BIOS Features

Anti-Virus Protection	Disabled	Item Help
CPU L1 & L2 Cache	Enabled	
CPU L3 Cache	Enabled	Menu Level >
Limit CPUID MaxVal	Disabled	
NX BIOS Control	Enabled	
Hard Disk Boot Priority	Press Enter	
Hyper Threading Technology	Enabled	
Quick Power On Self Test	Enabled	
First Boot Device	Floppy	
Second Boot Device	HDD 0	
Third Boot Device	CDROM	
Boot other Device	Enabled	
Swap Floppy Drive	Disabled	
Boot Up Floppy Seek	Enabled	
Boot Up NumLock Status	On	
Gate A20 Option	Fast	
Typematic Rate Setting	Disabled	
Typematic Rate (Chars/Sec)	6	
Typematic Delay (Msec)	250	
Security Option	Setup	
APIC Mode	Enabled	
MPS Version Control For OS	1.4	
OS Select For DRAM > 64MB	Non-OS2	
Report No FDD For Windows	Yes	
↑↓→← Move Enter:Select +/-/PU/PD:Value F10:Save ESC:Exit F1:General Help F5:Previous Values F6:Optimized Defaults F7:Standard Defaults		

Anti-Virus Protection

Allows you to choose the VIRUS Warning feature for IDE Hard Disk boot sector protection. If this function is enabled and someone attempt to write data into this area, BIOS will show a warning message on screen and alarm beep.

Disabled (default) No warning message to appear when anything attempts to access the boot sector or hard disk partition table.

Enabled Activates automatically when the system boots up causing a warning message to appear when anything attempts to access the boot sector of hard disk partition table.

CPU Internal Cache

The default value is Enabled.

Enabled (default) Enable cache

Disabled Disable cache

Note: The internal cache is built in the processor.

External Cache

Choose Enabled or Disabled. This option enables the Level 2 cache memory.

CPU L2 Cache ECC Checking

Choose Enabled or Disabled. This option enables the Level 2 cache memory ECC (error check correction).

Quick Power On Self Test

This category speeds up Power On Self Test (POST) after you power on the computer. If this is set to Enabled. BIOS will shorten or skip some check items during POST.

Enabled (default) Enable quick POST

Disabled Normal POST

First/Second/Third/Fourth Boot Device

The BIOS attempts to load the operating system from the devices in the sequence selected in these items. The settings are Floppy, LS/ZIP, HDD-0/HDD-1/HDD-3, SCSI, CDROM, LAD and Disabled.

Swap Floppy Drive

Switches the floppy disk drives between being designated as A and B. Default is Disabled.

Boot Up Floppy Seek

During POST, BIOS will determine if the floppy disk drive installed is 40 or 80 tracks. 360K type is 40 tracks while 760K, 1.2M and 1.44M are all 80 tracks.

Boot Up NumLock Status

The default value is On.

On (default) Keypad is numeric keys.

Off Keypad is arrow keys.

Gate A20 Option

Normal The A20 signal is controlled by keyboard controller or chipset hardware.

Fast (default) The A20 signal is controlled by port 92 or chipset specific method.

Typematic Rate Setting

Keystrokes repeat at a rate determined by the keyboard controller. When enabled, the typematic rate and typematic delay can be selected. The settings are: Enabled/Disabled.

Typematic Rate (Chars/Sec)

Sets the number of times a second to repeat a keystroke when you hold the key down. The settings are: 6, 8, 10, 12, 15, 20, 24, and 30.

Typematic Delay (Msec)

Sets the delay time after the key is held down before it begins to repeat the keystroke. The settings are 250, 500, 750, and 1000.

Security Option

This category allows you to limit access to the system and Setup, or just to Setup.

System The system will not boot and access to Setup will be denied if the correct password is not entered at the prompt.

Setup (default) The system will boot, but access to Setup will be denied if the correct password is not entered prompt.

OS Select For DRAM > 64MB

Allows OS2® to be used with >64MB or DRAM. Settings are Non-OS/2 (default) and OS2. Set to OS/2 if using more than 64MB and running OS/2.

3-6 Advanced Chipset Features

The Advanced Chipset Features Setup option is used to change the values of the chipset registers. These registers control most of the system options in the computer.

Phoenix - AwardBIOS CMOS Setup Utility
Advanced Chipset Features

DRAM Timing Settings	By SPD	Item Help
SDRAM CAS Latency Time	Auto	
SDRAM Cycle Time	Auto	
SDRAM RAS-to CAS Delay	Auto	
SDRAM RAS Precharge Time	Auto	
System BIOS Cacheable	Enabled	
Video BIOS Cacheable	Enabled	
Memory Hole at 15M-16M	Disabled	
> PCIExpress Root Port Function	Press Enter	Menu Level >
** VGA Setting **		
PEG/Onchip VGA Control	Auto	
PEG Force X1	Disabled	
On-Chip Frame Buffer Size	32MB	
FIXED Memory Size	64MB	
DVMT Memory Size	64MB	
↑↓→← Move Enter:Select +/-/PU/PD:Value F10:Save ESC:Exit F1:General Help F5:Previous Values F6:Optimized Defaults F7:Standard Defaults		

PCIExpress Root Port Function

Please refer to section 3-6-1

System BIOS Cacheable

Selecting Enabled allows caching of the system BIOS ROM at F0000h-FFFFFh, resulting in better system performance. However, if any program writes to this memory area, a system error may result. The settings are: Enabled and Disabled.

Video RAM Cacheable

Select Enabled allows caching of the video BIOS, resulting in better system performance. However, if any program writes to this memory area, a system error may result. The settings are: Enabled and Disabled.

Memory Hole At 15M-16M

You can reserve this area of system memory for ISA adapter ROM. When this area is reserved, it cannot be cached. The user information of peripherals that need to use this area of system memory usually discusses their memory requirements. The settings are: Enabled and Disabled.

Delay Transaction

The chipset has an embedded 32-bit posted write buffer to support delay transactions cycles. Select Enabled to support compliance with PCI specification version 2.1. The settings are: Enabled and Disabled.

AGP Transfer Mode

In this item you can select AGP transfer mode Auto/4X/1X the Default setting is Auto.

3-6-1 PCIExpress Root Port Function

Phoenix - AwardBIOS CMOS Setup Utility

PCIExpress Root Port Function

PCIExpress Port 1	Auto	Item Help
PCIExpress Compliancy Mode	v1.0a	Menu Level >>
↑↓→← Move Enter:Select +/-/PU/PD:Value F10:Save ESC:Exit F1:General Help F5:Previous Values F6:Optimized Defaults F7:Standard Defaults		

3-7 Integrated Peripherals

CMOS Setup Utility - Copyright(C) 1984-2004 Award Software

Integrated Peripherals

> Onboard IDE Function Press Enter > Onboard Device Function Press Enter > Onboard Super IO Function Press Enter Init Display First PCI Slot Pwr Status After Pwr Failure Always Off	Item Help
	Menu Level >
↑↓→← Move Enter:Select +/-/PU/PD:Value F10:Save ESC:Exit F1:General Help F5:Previous Values F6:Optimized Defaults F7:Standard Defaults	

Onboard IDE Function

Please refer to section 3-7-1

Onboard Device Function

Please refer to section 3-7-2

Onboard Super IO Function

Please refer to section 3-7-3

Init Display First

This item allows you to decide to activate whether PCI Slot or AGP VGA first. The settings are: PCI Slot, AGP Slot.

3-7-1 Onboard IDE Function

Phoenix - AwardBIOS CMOS Setup Utility

Onboard IDE Function

On-Chip Primary PCI IDE Enabled On-Chip Secondary PCI IDE Enabled Primary Master PIO Auto Primary Slave PIO Auto Secondary Master PIO Auto Secondary Slave PIO Auto Primary Master UDMA Auto Primary Slave UDMA Auto Secondary Master UDMA Auto Secondary Slave UDMA Auto IDE DMA Transfer Access Disabled IDE HDD Block Mode Enabled *** On-Chip Serial ATA Setting **** On-Chip Serial ATA Auto PATA IDE Mode Primary SATA Port P2, P4 is Secondary	Item Help
	Menu Level >>
↑↓→← Move Enter:Select +/-/PU/PD:Value F10:Save ESC:Exit F1:General Help F5:Previous Values F6:Optimized Defaults F7:Standard Defaults	

OnChip IDE Primary/Secondary

The integrated peripheral controller contains an IDE interface with support for two IDE channels. Select *Enabled* to activate each channel separately. The settings are: Enabled and Disabled.

Primary/Secondary Master/Slave PIO

The four IDE PIO (Programmed Input/Output) fields let you set a PIO mode (0-4) for each of the four IDE devices that the onboard IDE interface supports. Modes 0 through 4 provide successively increased performance. In Auto mode, the system automatically determines the best mode for each device. The settings are: Auto, Mode 0, Mode 1, Mode 2, Mode 3, Mode 4.

Primary/Secondary Master/Slave UDMA

Ultra DMA/33 implementation is possible only if your IDE hard drive supports it and the operating environment includes a DMA driver (Windows 95 OSR2 or a third-party IDE bus master driver). If your hard drive and your system software both support Ultra DMA/33 and Ultra DMA/66, select Auto to enable BIOS support. The settings are: Auto, Disabled.

IDE HDD Block Mode

Block mode is also called block transfer, multiple commands, or multiple sector read/write. If your IDE hard drive supports block mode (most new drives do), select Enabled for automatic detection of the optimal number of block read/writes per sector the drive can support. The settings are: Enabled, Disabled.

3-7-2 Onboard Device Function

Phoenix - AwardBIOS CMOS Setup Utility

Onboard Device Function

RealTek LAN BootROM	Disabled	Item Help
USB Host Controller	Enabled	Menu Level >>
USB 2.0 Function	Enabled	
USB Keyboard Legacy Support	Disabled	
High Definition Audio	Enabled	
↑↓→← Move Enter:Select +/-/PU/PD:Value F10:Save ESC:Exit F1:General Help F5:Previous Values F6:Optimized Defaults F7:Standard Defaults		

USB Host Controller

Select *Enabled* if your system contains a Universal Serial Bus (USB) controller and you have a USB peripherals. The settings are: Enabled, Disabled.

USB Keyboard Legacy Support

Select *Enabled* if your system contains a Universal Serial Bus (USB) controller and you have a USB keyboard. The settings are: Enabled, Disabled.

High Definition Audio

This will determine which on Board Sound Chip Function will use. The settings are: Enabled, Disabled.

3-7-3 Onboard Super IO Function

Phoenix - AwardBIOS CMOS Setup Utility

Onboard Super IO Function

Onboard FDD Controller	Enabled	Item Help
Onboard Serial Port 1	3F8/IRQ4	
Onboard Serial Port 2	2F8/IRQ3	Menu Level >>
UART2 Mode Select	Normal	
IR Duplex Mode	Half	
IR Pins	IRRX/IRTX	
Onboard Parallel Port	378/IRQ7	
Parallel Mode	SPP	
ECP Mode Use DMA	3	
↑↓→← Move Enter:Select +/-/PU/PD:Value F10:Save ESC:Exit F1:General Help F5:Previous Values F6:Optimized Defaults F7:Standard Defaults		

Onboard FDD Controller

Select Enabled if your system has a floppy disk controller (FDD) installed on the system board and you wish to use it. If you install add-on FDC or the system has no floppy drive, select Disabled in this field. The settings are: Enabled and Disabled.

Onboard Serial Port 1/Port 2

Select an address and corresponding interrupt for the first and the second serial ports. The settings are: 3F8/IRQ4, 2E8/IRQ3, 3E8/IRQ4, 2F8/IRQ3, Disabled, Auto.

UART2 Mode Select

This item allows you to determine which InfraRed(IR) function of the onboard I/O chip, this functions uses.

Onboard Parallel Port

There is a built-in parallel port on the on-board Super I/O chipset that Provides Standard, ECP, and EPP features. It has the following option:

Disabled

(3BCH/IRQ7)/ Line Printer port 0

(278H/IRQ5)/ Line Printer port 2

(378H/IRQ7) Line Printer port 1

Parallel Port Mode

SPP : Standard Parallel Port

EPP : Enhanced Parallel Port

ECP : Extended Capability Port

SPP/EPP/ECP/ECP+EPP

To operate the onboard parallel port as Standard Parallel Port only, choose "SPP." To operate the onboard parallel port in the EPP modes simultaneously, choose "EPP." By choosing "ECP", the onboard parallel port will operate in ECP mode only. Choosing "ECP+EPP" will allow the onboard parallel port to support both the ECP and EPP modes simultaneously. The ECP mode has to use the DMA channel, so choose the onboard parallel port with the ECP feature. After selecting it, the following message will appear: "ECP Mode Use DMA" at this time, the user can choose between DMA channels 3 to 1. The onboard parallel port is EPP Spec. compliant, so after the user chooses the onboard parallel port with the EPP function, the following message will be displayed on the screen: "EPP Mode Select." At this time either EPP 1.7 spec. or EPP 1.9 spec. can be chosen.

3-8 Power Management Setup

The Power Management Setup allows you to configure your system to most effectively save energy saving while operating in a manner consistent with your own style of computer use.

Phoenix - AwardBIOS CMOS Setup Utility

Power Management Setup

ACPI Function	<u>Enabled</u>	Item Help	
ACPI Suspend Type	S1 (POS)		
Power Management	User Define	Menu Level >	
Video off Method	V/H SYNC+Blank		
Video Off In Suspend	Yes		
Suspend Type	Stop Grant		
MODEM Use IRQ	3		
Suspend Mode	Disabled		
HDD Power Down	Disabled		
Soft-off by PWR-BTTN	Instant-off		
Wake-Up by PCI card	Disabled		
Power On by Ring	Disabled		
Resume by Alarm	Disabled		
X Date (of Month)	0		
X Time (hh:mm:ss)	0 : 0 : 0		
> PM Timer Reload Events	Press Enter		
> PCI Express PM Function	Press Enter		
↑↓→← Move Enter:Select +/-/PU/PD:Value F10:Save ESC:Exit F1:General Help F5:Previous Values F6:Optimized Defaults F7:Standard Defaults			

ACPI Function

This item allows you to Enabled/Disabled the Advanced Configuration and Power Management (ACPI). The settings are Enabled and Disabled.

ACPI Suspend Type

This item allows you to select ACPI Suspend Type.
The setting are: S1(POS), S3(STR)

Video Off in Suspend

This determines the manner in which the monitor is blanked. The choice are Yes → Video will off, and No→ Video always On.

Video Off Method

This determines the manner in which the monitor is blanked.

- DPMS (default)** Initial display power management signaling.
- Blank Screen** This option only writes blanks to the video buffer.
- V/H SYNC+Blank** This selection will cause the system to turn off the vertical and horizontal synchronization ports and write blanks to the video buffer.

Modem Use IRQ

This determines the IRQ in which the MODEM can use.
The settings are: 3, 4, 5, 7, 9, 10, 11, NA.

Power Button Function

Pressing the power button for more than 4 seconds forces the system to enter the Soft-Off state.
The settings are: Delay 4 Sec, Instant-Off.

Wake-Up by PCI card /Power On by Ring

During Disabled, the system will ignore any incoming call from the PCI card/modem. During Enabled, the system will boot up if there's an incoming call from the PCI card /modem.

Wake-Up on RTC Alarm

This function is for setting date and time for your computer to boot up. During Disabled, you cannot use this function. During Enabled, choose the Date and Time Alarm:

Date(of month) Alarm

You can choose which month the system will boot up. Set to 0, to boot every day.

Time(hh:mm:ss) Alarm

You can choose what hour, minute and second the system will boot up.

Note: If you have change the setting, you must let the system boot up until it goes to the operating system, before this function will work

PM Timer Reload Events

Please refer to section 3-8-1

PCI Express PM Function

Please refer to section 3-8-2

3-8-1 PM Timer Reload Events

Phoenix - AwardBIOS CMOS Setup Utility

PM Timer Reload Events

Primary IDE 0	Disabled	Item Help
Primary IDE 1	Disabled	
Secondary IDE 0	Disabled	Menu Level >>
Secondary IDE 1	Disabled	
FDD, COM, LPT Port	Disabled	
PCI PIRQ [A-D] #	Disabled	
↑↓→← Move Enter:Select +/-/PU/PD:Value F10:Save ESC:Exit F1:General Help F5:Previous Values F6:Optimized Defaults F7:Standard Defaults		

3-8-2 PCI Express PM Function

Phoenix - AwardBIOS CMOS Setup Utility

PCI Express PM Function

PCI Express PME	Enabled	Item Help
		Menu Level >>
↑↓→← Move Enter:Select +/-/PU/PD:Value F10:Save ESC:Exit F1:General Help F5:Previous Values F6:Optimized Defaults F7:Standard Defaults		

3-9 PnP/PCI Configuration Setup

This section describes configuring the PCI bus system. PCI, or Personal Computer Interconnect, is a system which allows I/O devices to operate at speeds nearing the speed the CPU itself uses when communicating with its own special components. This section covers some very technical items and it is strongly recommended that only experienced users should make any changes to the default settings.

Phoenix - AwardBIOS CMOS Setup Utility
PnP/PCI Configurations

Reset Configuration Data	Disabled	Item Help
Resources Controlled By	Manual	
x IRQ Resources	Press Enter	Menu Level >
PCI/VGA Palette Snoop	Disabled	
** PCI Express relative items**		
Maximum Payload Size	4069	
↑↓→← Move Enter:Select +/-/PU/PD:Value F10:Save ESC:Exit F1:General Help F5:Previous Values F6:Optimized Defaults F7:Standard Defaults		

Reset Configuration Data

Normally, you leave this field Disabled. Select Enabled to reset Extended System Configuration Data (ESCD) when you exit Setup if you have installed a new add-on and the system reconfiguration has caused such a serious conflict that the operating system can not boot. The settings are: Enabled and Disabled.

Resource Controlled By

The Award Plug and Play BIOS has the capacity to automatically configure all of the boot and Plug and Play compatible devices. However, this capability means absolutely nothing unless you are using a Plug and Play operating system such as Windows®95/98. If you set this field to “manual” choose specific resources by going into each of the sub menu that follows this field (a sub menu is preceded by a “>”).

The settings are: Auto(ESCD), Manual.

IRQ Resources

When resources are controlled manually, assign each system interrupt a type, depending on the type of device using the interrupt.

Please refer to section 3-9-1

PCI/VGA Palette Snoop

Leave this field at *Disabled*. The settings are Enabled, Disabled.

3-9-1 IRQ Resources

Phoenix - AwardBIOS CMOS Setup Utility

IRQ Resources

IRQ-3	assigned to	PCI Device	Item Help
IRQ-4	assigned to	PCI Device	
IRQ-5	assigned to	PCI Device	Menu Level >>
IRQ-7	assigned to	PCI Device	
IRQ-9	assigned to	PCI Device	
IRQ-10	assigned to	PCI Device	
IRQ-11	assigned to	PCI Device	
IRQ-12	assigned to	PCI Device	
IRQ-14	assigned to	PCI Device	
IRQ-15	assigned to	PCI Device	
↑↓→← Move Enter:Select +/-/PU/PD:Value F10:Save ESC:Exit F1:General Help F5:Previous Values F6:Optimized Defaults F7:Standard Defaults			

3-10 PC Health Status

This section shows the Status of you CPU, Fan, Warning for overall system status. This is only available if there is Hardware Monitor onboard.

Phoenix - AwardBIOS CMOS Setup Utility

PC Health Status

Shutdown Temperature	Disabled	Item Help
Show PCHealth in Post	Enabled	
CPUFAN Smart Mode	Enabled	Menu Level >
CPUFAN Temp1 Value	30	
CPUFAN Speed above Temp1	60%	
CPUFAN Temp2 Value	40	
CPUFAN Speed above Temp2	80%	
CPUFAN Temp3 Value	50	
CPUFAN Speed above Temp3	100%	
Vcore	1.36V	
Vcc1.5V	1.58V	
+5V	5.12V	
+12V	11.79V	
5VSB	5.00V	
VDIMM	2.67V	
3VSB	3.40V	
Vbat	3.29V	
CPU Temperature	59°C/138°F	
System Temperature	40°C/104°F	
↑↓→← Move Enter:Select +/-/PU/PD:Value F10:Save ESC:Exit F1:General Help F5:Previous Values F6:Optimized Defaults F7:Standard Defaults		

Show PCHealth in Post

During Enabled, it displays information list below. The choice is either Enabled or Disabled.

Current CPU Temperature/Current System Temp/Current FAN1, FAN2 Speed/Vcore/Vdd/ 3.3V/+5V/+12V/-12V/VBAT(V)/5VSB(V)

This will show the CPU/FAN/System voltage chart and FAN Speed.

Shutdown Temperature

This item can let users setting the Shutdown temperature, when CPU temperature over this setting the system will auto shutdown to protect CPU.

3-11 Miscellaneous Control

This section is for setting CPU Frequency/Voltage Control.

Phoenix - AwardBIOS CMOS Setup Utility

Miscellaneous Control

CPU Clock Ratio	8	Item Help
Auto Detect PCI Clk	Enabled	
Spread Spectrum	Disabled	
** Current Host/PCI Clock is 133/133Mhz **		Menu Level >
Host/PCI Clock at Next Boot	100	
** Current DRAM Clock is 166Mhz **		
DRAM Clock at Next Boot	By SPD (DDR)	
CPU Vcore Select	Default	
VDD1.5V Setting	1.55V	
VRAM Settings	1.80V	
VRAM Under Voltage Protect	Disabled	
VDD1.5V Under Voltage Protect	Disabled	
Flash Part Write Protect	Enabled	
↑↓→← Move Enter:Select +/-/PU/PD=Value F10:Save ESC:Exit F1:General Help F5:Previous Values F6:Optimized Defaults F7:Standard Defaults		

Auto Detect PCI Clk

This item allows you to enable/disable auto detect PCI Clock.

The settings are: Enabled, Disabled.

Spread Spectrum

This item allows you to set the CPU Host/PCI clock and Spread Spectrum.

The settings are: Enabled, Disabled.

Host Clock at Next Boot

This item allows you to select CPU frequency step by step increasing.

The choice are: 533MHz CPU---133MHz~350MHz, 800MHz CPU---200MHz~350MHz

DRAM Clock at Next Boot

This item allows you select the DRAM Clock for DDR266/DDR333/DDR400. The setting are: DDR333 for P4/533MHz CPU, DDR333 /DDR400 for P4/800MHz CPU

CPU Vcore Select

This item allows you select CPU Vcore Voltage by increase 0.0125V step by step from 0.8375V to 1.6V or the Default setting is Default (CPU manufacturer Default setting).

VDD1.5V Settings

This item allows you to select 1.5V of the AGP VGA card. The choice are: Default, 1.5V, 1.6V, 1.7V, 1.8V.

VRAM Settings

This item allows you to select DRAM Voltage. The choice are: 2.55V/2.6V/2.7V/2.8V.

Flash Part Write Protect

This item allows you protect your BIOS chip from Virus destroy data. When Flash BIOS you have Disabled this item.

3-12 Load Standard/Optimized Defaults

Load Standard Defaults

When you press <Enter> on this item, you get confirmation dialog box with a message similar to:

Load Standard Defaults (Y/N)? N

Pressing <Y> loads the BIOS default values for the most stable, minimal-performance system operations.

Load Optimized Defaults

When you press <Enter> on this item, you get a confirmation dialog box with a message similar to:

Load Optimized Defaults (Y/N)? N

Pressing <Y> loads the default values that are factory settings for optimal performance system operations.

3-13 Set Supervisor/User Password

You can set either supervisor or user password, or both of them. The differences are:

Supervisor password: Can enter and change the options of the setup menus.

User password: Can only enter but do not have the right to change the options of the setup menus. When you select this function, the following message will appear at the center of the screen to assist you in creating a password.

ENTER PASSWORD:

Type the password, up to eight characters in length, and press <Enter>. The password typed now will clear any previously entered password from CMOS memory. You will be asked to confirm the password. Type the password again and press <Enter>. You may also press <Esc> to abort the selection and not enter a password.

To disable a password, just press <Enter> when you are prompted to enter the password. A message will confirm that the password will be disabled. Once the password is disabled, the system will boot and you can enter Setup freely.

PASSWORD DISABLED.

When a password has been enabled, you will be prompted to enter it every time you try to enter Setup. This prevents an unauthorized person from changing any part of your system configuration.

Additionally, when a password is enabled, you can also require the BIOS to request a password every time your system is rebooted. This would prevent unauthorized use of your computer.

You determine when the password is required within the BIOS Features Setup Menu and its Security option. If the Security option is set to “System”, the password will be required both at boot and at entry to Setup. If set to “Setup”, prompting only occurs when trying to enter Setup.

Chapter 4

DRIVER & FREE PROGRAM INSTALLATION

Check your package and there is A MAGIC INSTALL CD included. This CD consists of all DRIVERS you need and some free application programs and utility programs. In addition, this CD also include an auto detect software which can tell you which hardware is installed, and which DRIVERS needed so that your system can function properly. We call this auto detect software MAGIC INSTALL.

MAGIC INSTALL Supports WINDOWS 2000/XP

Insert CD into your CD-ROM drive and the MAGIC INSTALL Menu should appear as below. If the menu does not appear, double-click MY COMPUTER / double-click CD-ROM drive or click START / click RUN / type X:\SETUP.EXE (assuming X is your CD-ROM drive).

The intel915 serial chipset driver only support Windows 2000 and Windows XP OS



From MAGIC INSTALL MENU you may make 11 selections:

1. INF install Intel 915 chipset system driver
2. VGA install Intel 915G VGA driver (**Only for 917GBAG/917GBA**)
3. SOUND install ALC880 AC97 Codec Audio Driver
4. LAN install Intel LAN Controller driver (**Only for 917PBAG/917GBAG**)
5. USB2.0 install USB 2.0 driver
6. RAID install SIS 180 RAID Driver and Utility
7. DIRECTX9 install Microsoft DirectX 9 driver
8. PC-CILLIN install PC-CILLIN2004 anti-virus program
9. PC-HEALTH install Intel Hardware Doctor Utility
10. BROWSE CD to browse the contents of the CD
11. EXIT to exit from MAGIC INSTALL menu

4-1 INF install Intel 915 chipset system driver



1. Click INF in the MAGIC INSTALL MENU



2. Click NEXT when Chipset Software Install Utility appears



3. This license agreement appear, click Yes, the readme information appear, click Next



4. Select if you want computer re-started click Finish

4-2 VGA install Intel 915G VGA Driver

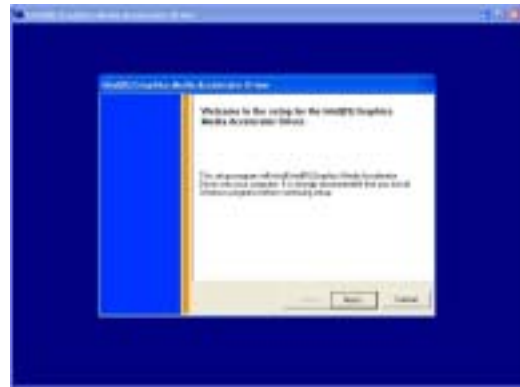

1. Click VGA when MAGIC INSTALL MENU appears
2. Click NEXT When Intel (R) Graphics Media Accelerator Driver Software Setup appear

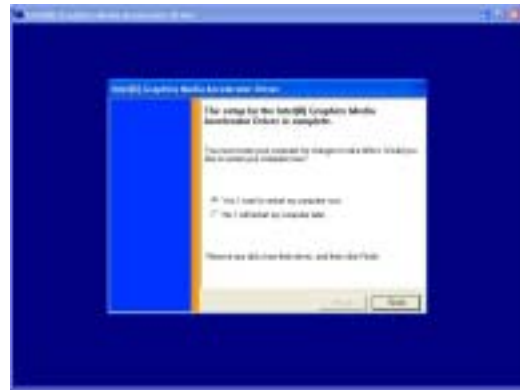
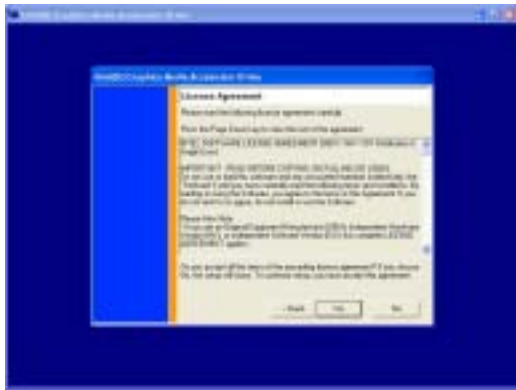

3. Click YES, This is Announce CopyRight
4. If You Want Re-start Computer , Click FINISH

4-3 SOUND install ALC880 AC97 Codec Audio Driver



1. Click SOUND when MAGIC INSTALL MENU appears
2. Click NEXT When Realtek High Definition Audio driver windows appear



3. Click FINISH and restart your computer



4. Manual Sound Effect Setting



5. Speaker configuration setting



6. SPDIF out setting

4-4 LAN install Realtek RTL8110S Gigabit Ethernet NIC Driver



1. Click LAN when Magic Install Menu appear



2. Click finish, and select restart computer

4-5 RAID install SIS 180 RAID Driver and Utility



1. Click RAID in MAGIC INSTALL MENU appear



2. When "RAID application windows appear, please click NEXT

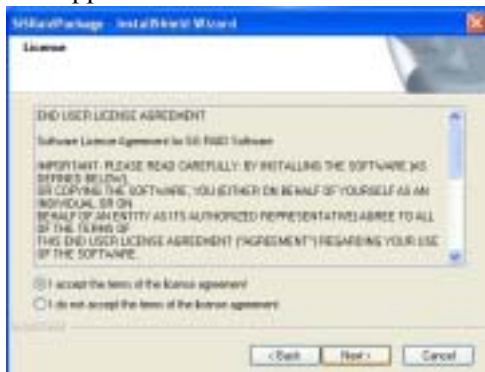

3. When the license agreement windows appear, please choose "I accept the terms of the license agreement" and click NEXT, then click INSTALL, start install SIS180 RAID Controller Driver



4. Please click FINISH and restart your computer

Making SATA HDD driver diskette before Install WindowsXP/2000

If you only have Serial ATA HDDs on your system, before you install the Windows XP or Windows 2000, you will need to make a SATA HDD driver diskette before you start to install the Operating System.

How to make a SATA HDD driver diskette?

STEP 1: Insert the diskette which been formatted in floppy drive on a system which can start OS.

STEP 2: After booting OS insert the bundle CD in your CD-ROM

STEP 3: Copy all the files from \SiS\SiS180\Disk to floppy diskette

Once you have the SATA driver diskette ready, you may start to install Windows XP or Windows 2000 on your System.

Installation of Windows XP/ Windows 2000

For installation of Windows XP or Windows 2000, please insert Windows XP or Windows 2000 CD into the CD-ROM drive. Then remove the floppy diskette, and boot the system. At the very beginning, you will see the message at the bottom of screen, "Press F6 if you need to install a third party SCSI or RAID driver...."

At this moment, please press <F6> key and follow the instructions of Windows XP or Windows 2000 for the proper installation.

4-6 PC-HEALTH install Intel Hardware Doctor Utility



1. Click PC-HEALTH when MAGIC INSTALL MENU appears



2. Click Next when Install shield wizard Window appears, Choose destination location and click Next, when the start copy file windows appear, click next



3. Select Finish after setup complete



4. Execute MY GUARD utility, On-time Monitoring your system health

NOTE:

MAGIC INSTALL will auto detect file path X:\INTEL915\MYGUARD\SETUP.EXE

This driver supports WINDOWS 2000/XP

4-7 PC-CILLIN Install PC-CILLIN 2004 Anti-virus program



1. Click PC-CILLIN when MAGIC INSTALL MENU appear



2. Click NEXT when the "Trend Micro internet security" installshield wizard windows appear



3. This is license agreement, select "I Accept the terms" and Click NEXT

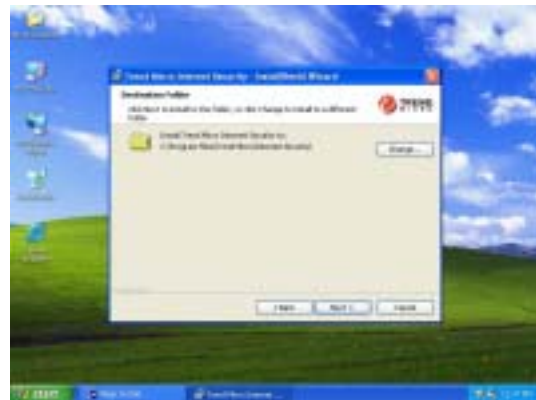

4. Click NEXT and Enter your Customer Information, Click NEXT or choose Change to change the path for the file to be stored

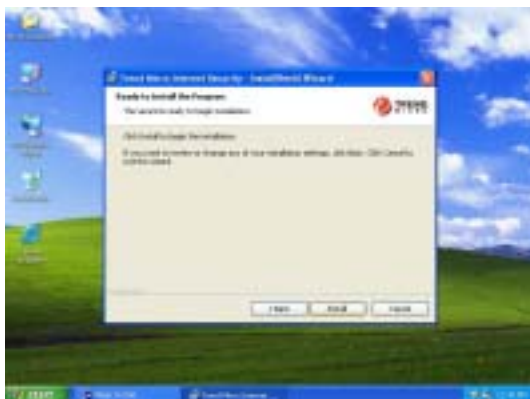

5. Click INSTALL, Start to install the software

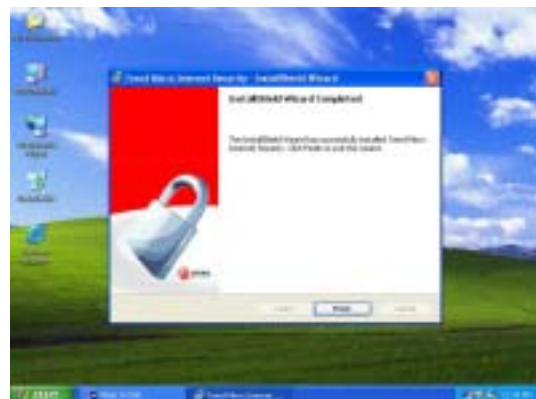

6. Setup Complete and click FINISH



7. After PC-CILLIN 2004 complete, Please register your information and we recommend select update item to download newest engine code and virus code

Note : Please install **ACROBAT READER**, Before you read **PC-CILLIN 2004 User Manual**, the path at **X:\acrobat\adberdr6_enu_full.exe**

4-8 HOW TO UPDATE BIOS

Before update BIOS users have to “Disable”, “Flash Part Write Protect” item which in “Miscellaneous Control” of BIOS SETUP. Otherwise the system the will not allow you to upgrade BIOS by Award Flash Utility.

- STEP 1.** Prepare a boot disc. (you may make one by click START click RUN type SYS A: click OK)
- STEP 2.** Copy utility program to your boot disc. You may copy from DRIVER CD X:\FLASH\AWDFLASH.EXE or download from our web site.
- STEP 3.** Copy latest BIOS for 917PBAG from our web site to your boot disc.
- STEP 4.** Insert your boot disc into A:,
start the computer, type “Awdflash A:\917PBAGAxXX.BIN /SN/PY/CC/R”
917PBAGxxx.BIN is the file name of latest BIOS it can be 917PBAGA03.BIN or 917PBAG02.BIN
SN means don't save existing BIOS data
PY means renew existing BIOS data
CC means clear existing CMOS data
R means restart computer
- STEP 5.** Push ENTER and the BIOS will be updated, computer will be restarted automatically.