



## Electronic Emission Notices

### Federal Communications Commission (FCC) Statement

This equipment has been tested and found to comply with the limits for a Class B digital device, pursuant to Part 15 of FCC Rules. These limits are designed to provide reasonable protection against harmful interference in a residential installation. This equipment generates, uses and can radiate radio frequency energy and, if not installed and used in accordance with instructions contained in this manual, may cause harmful interference to radio and television communications. However, there is no guarantee that interference will not occur in a particular installation.

If this equipment does cause harmful interference to radio or television reception, which can be determined by turning the equipment off and on, the user is encouraged to try to correct the interference by one or more of the following measures:

- REORIENT OR RELOCATE THE RECEIVING ANTENNA
- INCREASE THE SEPARATION BETWEEN THE EQUIPMENT AND THE RECEIVER
- CONNECT THE EQUIPMENT INTO AN OUTLET ON A CIRCUIT DIFFERENT FROM THAT OF THE RECEIVER
- CONSULT THE DEALER OR AN EXPERIENCED AUDIO/TELEVISION TECHNICIAN

**NOTE:** Connecting this device to peripheral devices that do not comply with Class B requirements, or using an unshielded peripheral data cable, could also result in harmful interference to radio or television reception.

The user is cautioned that any changes or modifications not expressly approved by the party responsible for compliance could void the user's authority to operate this equipment.

To ensure that the use of this product does not contribute to interference, it is necessary to use shielded I/O cables.

### Copyright

This manual is copyrighted with all rights reserved. No portion of this manual may be copied or reproduced by any means.

While every precaution has been taken in the preparation of this manual, no responsibility for errors or omissions is assumed. Neither is any liability assumed for damages resulting from the use of the information contained herein.

### Trademarks

All brand names, logos and registered trademarks mentioned are property of their respective owners.

---

## Table of Contents

<b>HARDWARE CONFIGURATION</b> .....	3
Key Features .....	3
Motherboard Layout (Model Code No. - 35894500XX) .....	5
Jumper Settings .....	6
CPU Speed Selection .....	6
JP1, JP2 - System Bus Frequency .....	6
JP3 - CMOS Clear .....	6
JP7 - Ratio of Processor Core to System Bus Frequency .....	7
JP8 - BIOS Voltage Selection .....	7
JP45 - On Board AC97 Codec Selection .....	7
CN41- PC Speaker Beep to Outer Speaker Setting .....	7
Pin List of Special Connectors .....	8
Memory Configuration .....	9
Installing the Retention Mechanism for Intel® Pentium® II & Intel® Pentium® III or Intel® Celeron® Processor .....	9
Installing the Processor .....	9
To install DIMMs .....	10
Setting the Processor Speed .....	10
 <b>BIOS SETUP</b> .....	 11
Starting Setup .....	11
Main Menu .....	11
Standard CMOS Features .....	13
Advanced BIOS Features .....	14
Advanced Chipset Features .....	15
Integrated Peripherals .....	15
Power Management Setup .....	15
PNP/PCI Configurations .....	15
Set Supervisor/User Password .....	15
Flash Update Procedure .....	16

---

# HARDWARE CONFIGURATION

The motherboard is based on the VIA® Apollo Pro 133 Chipset. The chipset is a highly integrated solution enabling a high performance motherboard and desktop design for the Pentium® II/III processor. The main board supports standard DIMM module, 66/100/133MHz DIMM module or Registered DIMM module. The features on board include Super-I/O, Ultra DMA33/66 for PCI bus master IDE, AGP 2.0 compliance, PCI 2.1 compliance, USB, VRM 8.4 compliance, ECC, on-board sound system (optional).

This motherboard is ready for PC99 requirements.

## Key Features

### Motherboard PCB

4 Layer ATX size PCB with surface mounted devices(SMD) for all components except a small amount discrete components. PCB board size is 305 x 173mm.

### Processor

- Full support for Intel® Pentium® II & Pentium® III and Deschutes® processors using Slot 1 connector.
- Support bus speed of 66/100/133MHz, this includes all Pentium® II & Pentium® III processors from 233MHz to 600MHz and future processors.

### CPU Speed Setting

- Jumper setting or no jumper is needed to set for various speed of CPU (Factory optional).

### VRM 8.4 (Voltage Regulator Modules) on Board

- Flexible motherboard design with on-board VRM 8.4, easy to upgrade with Intel's® Future Overdrive® processors.

### Cache

- Pentium® II and Pentium® III Processor built-in L2 cache (The TAGRAM and two or four BSRAMS for 256KB or 512KB).

### System Memory

- A total of three 168-pin DIMM sockets.
- Supports Synchronous DRAM at 66/100/133MHZ.
- Supports Symmetrical and Asymmetrical DRAM addressing.
- Memory size up to 768Mbytes.
- Supports single density DIMMs of 1M, 2M, 4M, 8M and 16M depth(x64 or x72).
- Supports double density DIMMs of 2M, 4M, 8M, 16M and 32M depth (x64 or 72).
- Supports single & double sided DIMMs.
- Supports Error Checking and Correction(ECC) using parity DRAM modules.

## On-Board I/O

- Two PCI IDE ports supporting up to 4 ATA, ATA2 and Ultra DMA33/66 IDE HDDs, CD-ROMs, ZIP drives and LS-120 drives as boot devices.
- Transfer rate up to 33MB/sec or 66MB/sec to cover PIO mode 4, Multi-word DMA mode 2 drives and UltraDMA33/66 interface.
- One ECP/EPP parallel port.
- Two 16550 Compatible UART serial ports.
- One floppy port, supports two FDD of 360KB, 720KB, 1.2MB , 1.44MB and 2.88MB capacity.
- Two USB ports.
- PS/2 Keyboard port.
- One PS/2 mouse port.
- Infrared (IrDA) is supported via a header.
- One line/speaker out, one Mic in, one line in and MIDI/Gameport (optional)

## System BIOS

- 2M Flash BIOS supporting PnP, APM, ATAPI , ACPI and DMI.
- Jumper selection for 5V or 12V Flash memory voltage.
- Auto detects and supports LBA hard disks with capacities over 8.4GB.
- Easy to upgrade BIOS by end-user.

## Plug-and-Play

- Supports plug-and-play specification 1.1.
- Plug-and-play for DOS, Windows® 3.X, as well as Windows® 95/98.
- Fully steerable PCI interrupts.

## Power Management

- Supports SMM, APM and ACPI.
- Break switch for instant suspend/resume on system operations.
- Energy star “Green PC” compliant .
- Hardware monitoring circuitry is supported, provides voltage, temperature, fan speed, etc. monitoring (optional).
- Supports WAKE-ON-LAN (WOL).
- Supports Wake on Ring for External Modem.

## AC97 sound controller (optional)

- Integrated AC97 controller with standard AC97 CODEC.
- PnP and APM 1.2 support.
- Direct sound and sound Blaster Compatible.
- Direct one MIDI/Game port interface.
- Complete software driver support for Windows® 95/98 and Windows® NT.

## Expansion Slots

- 1 AGP slot - ver. 2.0 compliant, 1x / 2x mode supported.
- 4 PCI bus master slots - ver 2.1 compliant(1PCI slot shares with 1ISA slot)
- 2 ISA slots (1ISA slot shares with 1 PCI slot ).
- 1 Audio Modem Riser (AMR).

## Motherboard Layout (Model Code No. - 35894500XX)

The following diagrams show the relative positions of the jumpers, connectors, major components and memory banks on the motherboard.

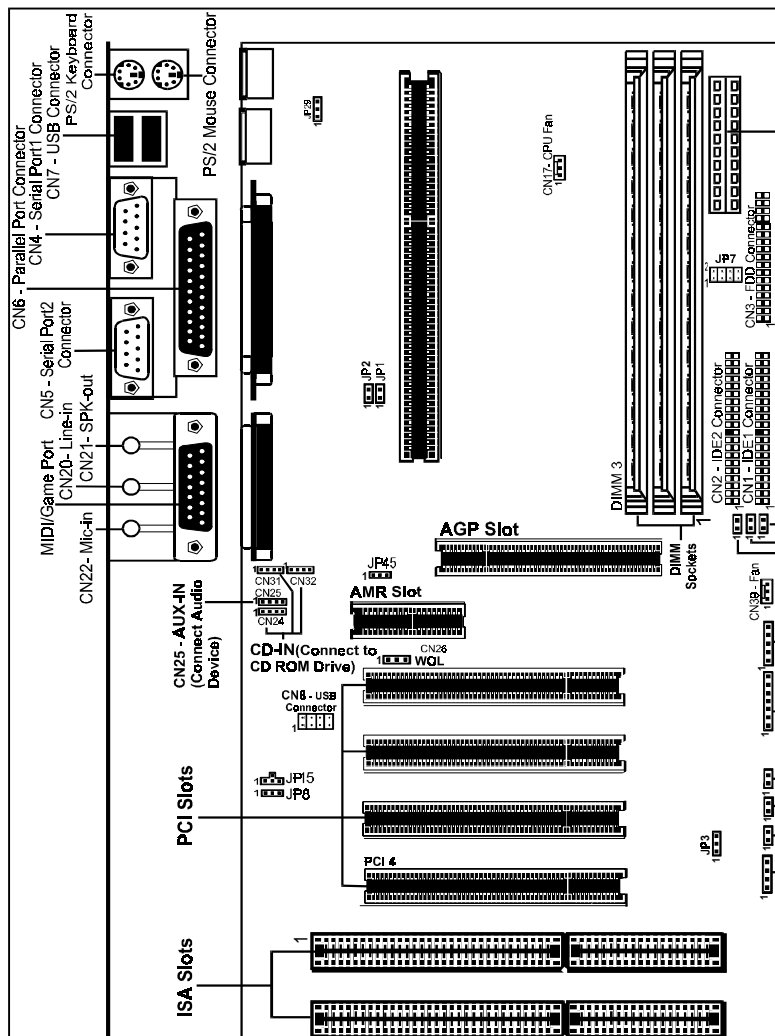

### Warning:

All connectors on board are labeled Pin "1" at one corner. Ribbon cables should always be connected with the red stripe on the Pin "1" side of the connector.

## Jumper Settings

This chapter explains how to configure the motherboard's hardware. Before using your computer, make sure all jumpers and DRAM modules are set correctly. Refer to this chapter whenever in doubt.

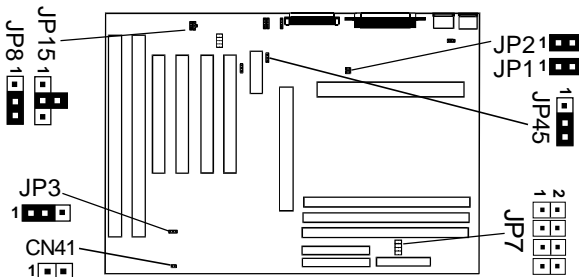

### CPU Speed Selection

When JP7 is installed on this motherboard, jumper is required to be set for different type of CPU installed. The CPU speed is set by JP1, JP2, and JP7, please see JP7- Ratio of Processor Core to System Bus Frequency table.

When JP7 is not installed on this motherboard, jumperless feature is implemented such that no jumper is required to be set for different type of CPU installed.

The CPU speed is set in "CPU Speed Setting" of CMOS Setup.

#### Notice:

1. Be sure to save the CMOS setting when exit the CMOS.
2. When System Bus Frequency is 100MHz, DIMM RAM must be PC100 standard.
3. When the system is turned on the first time or the CPU is changed, a Pentium II-133 or -200 (depends on the CPU bus speed) will be recognized and a warning message of "CPU has been changed" will appear. Please enter the CMOS setup menu to configure the CPU speed.

### JP1, JP2 - System Bus Frequency

JP1	JP2	System Bus Frequency
1 □ □ (Open)	1 □ □ (Open)	133MHz
1 □ □ (Open)	1 ■ ■ (Close)	100MHz
1 ■ ■ (Close)*	1 ■ ■ (Close)*	Auto*















### JP3 - CMOS Clear

JP3	Selection
1 ■ ■ □ (1-2)*	Normal operation*
1 □ ■ ■ (2-3)	CMOS Clear



\* = Default setting.

■ ■ Close □ □ Open

## JP7 - Ratio of Processor Core to System Bus Frequency



Ratio of System	JP7	Ratio of System	JP7
1.5		5	
2 *	 *	5.5	
2.5		6	
3		6.5	
3.5		7	
4		7.5	
4.5		8	

## JP8 - BIOS Voltage Selection



JP8	Voltage	Selection
 (2-3)*	+5V *	ATMEL/SST/Winbond (2MB)
 (1-2)	+12V	MX(2MB)

***JP8 is pre-installed in the factory. It should NOT be altered by the users.***

## JP45 - On Board AC97 Codec Selection

JP3	Selection
 (1-2)	Disable
 (2-3)*	Enable*

## CN41 - PC Speaker Beep to Outer Speaker Setting

CN41	PC Speaker Beep to Outer Speaker Setting
 (Close)	Enable PC speaker beep to outer speaker setting
 (Open)*	Disable PC speaker beep to outer speaker setting*

### Warning:

Before handling the motherboard from its original package, please ensure that there is no static electricity on your body. Otherwise it may cause damage to the integrated circuits on the motherboard.

\* =Default setting

 Close  Open

## Pin List of Special Connectors:

1. CN14: Speaker



1	Singal
2	NC
3	GND
4	VCC

2. CN16: INFRARED Connector



1	IRRX
2	GND
3	IRTX
4	VCC

3. CN24: CD-IN (MOLEX)



1	CD-L
2	GND
3	GND
4	CD-R

4. CN25: AUX-IN (MOLEX)



1	AUX-L
2	GND
3	GND
4	AUX-R

5. CN31: CD-IN (JST)



1	CD-R
2	GND
3	CD-L
4	GND

6. CN32: CD-IN (JST)



1	GND
2	CD-L
3	GND
4	CD-R



## Memory Configuration

You can install DIMM memory in the motherboard DIMM sockets. The board has DIMM sockets arranged as banks 1, and 2. You can install DIMMs in any of the two banks, and use different size DIMMs in different banks. The BIOS detects the size and type of installed memory.

### Installing the Retention Mechanism for Intel® Pentium® II & Intel® Pentium® III or Intel® Celeron® Processor

To install the retention mechanism, follow these steps:

1. Locate Slot 1 and the four attachment holes on the motherboard.
2. To position the mechanism, orient it as shown in figure. The tab on the connector fits into a notch in the base of the mechanism. Press down on the studs until it is firmly seated in attachment holes. When properly seated, the base of the mechanism is flush with the motherboard.

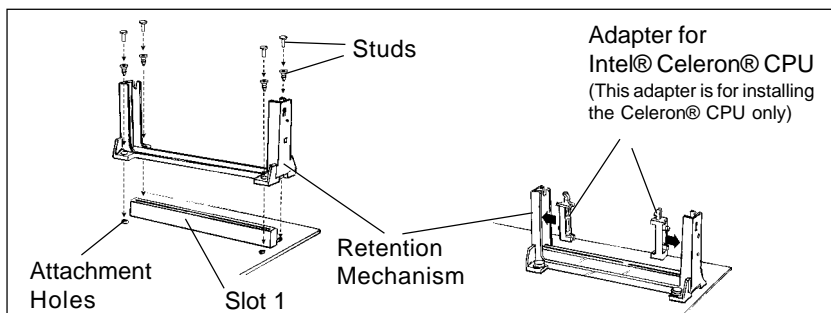

### Installing the Processor

To install the processor, follow these steps:

1. Insert the processor in the retention mechanism.
2. Press down on the processor until it is firmly seated in the Slot 1 connector.

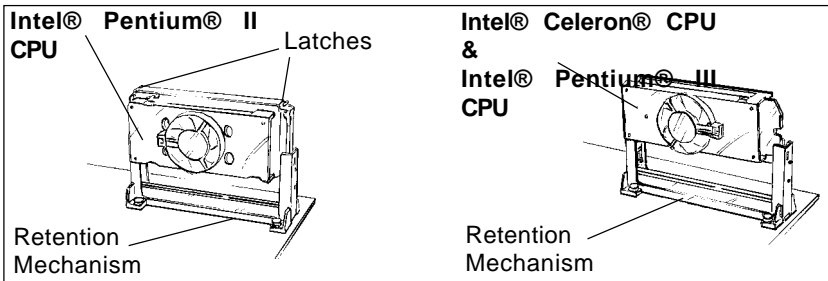

### Warning:

There is a fan attached the CPU to prevent the overheating, please ensure that the fan can operate. Otherwise the CPU can overheat and cause damage to both CPU and motherboard.

## To install DIMMs

1. Turn off all peripheral devices connected to the computer. Turn off the computer.
2. Remove the computer cover and locate the DIMM sockets.
3. Holding the DIMM by the edges, remove it from its antistatic package.
4. Make sure the clips at either end of the socket are pushed away from the socket.

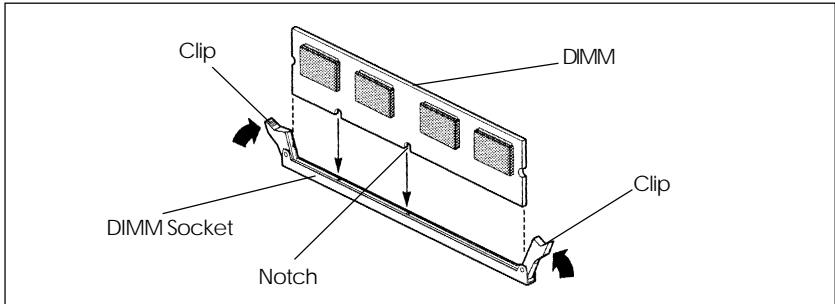

5. Position the DIMM above the socket. Align the two small notches in the bottom edge of the DIMM with the keys in the socket.
6. Insert the bottom edge of the DIMM into the socket.
7. When the DIMM is seated, push down on the top edge of the DIMM until the retaining clips at the ends of the socket snap into place. Make sure the clips are firmly in place.
8. Replace the computer cover.

### **Warning:**

Turn system power off before installing and removing any device, otherwise you'll cause the system damage.

## Setting the Processor Speed

After you install the processor into the motherboard, set the processor speed by CMOS setup.

---

## BIOS SETUP

This chapter discusses Award's Setup Program built into the ROM BIOS. The Setup Program allows users to modify the basic system configuration. This special information is then stored in battery-backed RAM, which retains the setup information when the power is turned off.

### Starting Setup

The Award BIOS is immediately activated when you turn on the computer. The BIOS reads the system information contained in the CMOS and begins the process of checking out the system and configuring it. When it finishes, the BIOS will seek an operating system on one of the disks and then launch and turn control over to the operating system .

While the BIOS is in control, the Setup Program can be activated:

1. By pressing <Del> immediately after switching the system on, or
2. By pressing the <Del> key when the following message appears briefly at the bottom of the screen during the POST (Power On Self Test )

*Press DEL to enter SETUP*

If the message disappears before you can respond and you still wish to enter Setup, restart the system to try again by turning it OFF then ON or pressing the "RESET" button on the system case. You may also restart by simultaneously pressing the <Ctrl>, <Alt>, and <Delete> keys. If you do not press the keys at the correct time and the system does not reset, an error message will be displayed and you will again be asked to ...

*PRESS F1 TO CONTINUE, DEL TO ENTER SETUP*

### Getting Help

Press F1 to pop up a small help window that describes the appropriate keys to use and the possible selections for the highlighted item. To exit the Help Window press <Esc> or the F1 key again.

### In Case of Problems

If, after making and saving system changes with the Setup Program, you discover that your computer does not reset, use the Award BIOS defaults to override the CMOS settings.

### Main Menu

Once you enter the Award BIOS CMOS Setup Utility, the Main Menu will appear on the screen. The Main Menu allows you to select from various setup functions and two exit choices. Use the arrow keys to select among the items and press <Enter> to accept and enter the sub-menu.

ROM PCI/ISA BIOS  
CMOS SETUP UTILITY  
AWARD SOFTWARE. INC.

STANDARD CMOS SETUP BIOS FEATURES SETUP CHIPSET FEATURES SETUP POWER MANAGEMENT SETUP PNP/PCI CONFIGURATION SETUP LOAD BIOS DEFAULTS LOAD SETUP DEFAULTS	CPU SPEED SETTING INTEGRATED PERIPHERALS SUPERVISOR PASSWORD USER PASSWORD IDE HDD AUTO DETECTION SAVE & EXIT SETUP EXIT WITHOUT SAVING
Esc : Quit F10 : Save & Exit Setup	↑↓→← : Select Item (Shift) F2 : Change Color
Time. Date. Hard Disk Type	

**(Note : The figures of BIOS Setup Menu included here only show a typical case, and may not be exactly the same as the one on your unit.)**

Note that a brief description of each highlighted item will appear at the bottom of the screen.

**Standard CMOS Setup** This setup page includes all the items of Award™ special standard features.

**BIOS Features Setup** This setup page includes all the items of Award™ special enhanced features.

**Chipset Features Setup** This setup page includes all the items of chipset special features.

**Power Management Setup** This entry only appears if your system supports Power Management “Green PC” standards.

**PNP / PCI Configuration Setup** This entry appears if your system supports PNP/PCI.

**Load BIOS Defaults** The BIOS defaults have been set by the manufacturer and represent settings which provide the minimum requirements for your system to operate.

**Load Setup Defaults** The chipset defaults are settings which provide for maximum system performance. While Award has designed the custom BIOS to maximize performance, the manufacturer has the right to change these defaults to meet its needs.

**CPU Speed Setting** You should refer to your CPU marking and correct setting CPU speed.

- Integrated Peripherals** This section page includes all the items of IDE hard drive and Programmed Input / Output features.
- Supervisor / User Password Setting** Changes, sets, or disables password. It allows you to limit access to the system and the Setup Program.
- IDE HDD Auto Detection** Automatically detects and configures the hard disk parameters. The Award BIOS includes this ability in the event you are uncertain of your hard disk's parameters.
- Save & Exit Setup** Saves value changes to CMOS and exits setup.
- Exit Without Save** Abandons all CMOS value changes and exits setup.

## Standard CMOS Setup

The items in Standard CMOS Setup Menu are divided into 10 categories. Each category includes one or more setup items. Use the arrow keys to highlight the item and then use the <PgUp> or <PgDn> key to select the desired value in each item.

ROM PCI/ISA BIOS  
STANDARD CMOS SETUP  
AWARD SOFTWARE. INC.

Date (mm:dd:yy) : Thu, Jan 23 1997		Time (hh:mm:ss) : 00:00:00						
HARDDISKS	TYPE	SIZE	CYLS.	HEADS	PRECOMP	LANDZ	SECTORS	Mode
Primary Master	: None	0	0	0	0	0	0	---
Primary Slave	: None	0	0	0	0	0	0	---
Secondary Master	: None	0	0	0	0	0	0	---
Secondary Slave	: None	0	0	0	0	0	0	---
Drive A :	1.44M, 3.5 in				Base Memory	: 640K		
Drive B :	None				Extended Memory	: 15360K		
Video :	EGA/VGA				Other Memory	: 384K		
Halt on :	All Errors				Total Memory	: 16384K		
Esc : Quit	↑↓→←			: Select Item		PU/PD/+/- : Modify		
F1 : Help	(Shift) F2			: Change Color				

**(Note : The figures of BIOS Setup Menu included here only show a typical case, and may not be exactly the same as the one on your unit.)**

- Date** The date format is <day-of-the-week> <day> <month> <year>. Press <F3> to display the calendar.
- Time** The time format is <hour> <Minute> <second> displayed in 24-hour military-time clock. For example, 1 p. m. is displayed as 13:00:00.

**Primary** These categories identify the types of the two channels that  
**Master/Primary** have been installed in the computer. There are 45 predefined  
**Slave/Secondary** types and one user definable types in BIOS. Type 1 to Type  
**Master/Secondary** 45 are predefined. Type "user" is user-definable.  
**Slave**

Press PgUp or PgDn to select a numbered hard disk type or type the number and press <Enter>. Note that the specifications of your drive must match with those of the drive table. The hard disk will not work properly if you enter improper information for this category. If your hard disk drive type is not matched or listed, you can select Type "User" to define your own drive type manually.

If you select Type "User", you will need to know the information listed below. Enter the information directly from the keyboard and press <Enter>. This information should be included in the documentation from your hard disk vendor or the system manufacturer.

If the controller of the HDD interface is ESDI, the selection shall be "Type1".

If the controller of the HDD interface is SCSI, the selection shall be "None" .

If you select Type "Auto", the BIOS will auto-detect the HDD and CD-ROM drive at the POST stage and show the IDE for the HDD and CD-ROM drive.

<b>TYPE</b>	-Drive type
<b>CYLS</b>	-Number of cylinders
<b>HEADS</b>	-Number of heads
<b>PRECOMP</b>	-Write precom
<b>LANDZONE</b>	-Landing zone
<b>SECTORS</b>	-Number of sectors
<b>MODE</b>	-Mode type

If a hard disk has not been installed, select NONE and press <Enter> .

**Drive A Type /** This category identifies the types of floppy disk drive A or  
**Drive B Type** drive B that has been installed in the computer.

**Video** This category selects the type of video adapter used for the primary system monitor. Although secondary monitors are supported, you do not have to select them in Setup.

## Advanced BIOS Features

This section allows you to configure your system for basic operation. You have the opportunity to select the system's default speed, boot-up sequence, keyboard operation, shadowing and security.

---

## Advanced Chipset Features

The Chipset Features Setup option is used to change the values of the chipset registers. These registers control most of the system options in the computer.

This section allows you to configure the system based on the specific features of the installed chipset. This chipset manages bus speeds and access to system memory resources, such as DRAM and the external cache. It must be stated that these items should not be altered. The default settings have been chosen because they provide the best operating conditions for your system.

## Integrated Peripherals

The Integrated Peripherals Setup allows the user to configure the onboard IDE controller, floppy disk controller, the printer port and the serial ports.

## Power Management Setup

The Power Management Setup Menu allows you to configure your system to most save energy while operating in a manner consistent with your own style of computer use .

## PNP/PCI Configurations

This section describes how to configure the PCI bus system. This section covers some very technical items and it is recommended that only experienced users should make any changes to the default settings.

## Set Supervisor/User Password

You can set either supervisor or user password, or both of them. The difference between them are:

- |                              |   |
|------------------------------|---|
| <b>Supervisor Password :</b> | You can enter the Setup Program and change the options of the setup menus.        |
| <b>User Password :</b>       | You can enter the Setup Program but cannot change the options of the setup menus. |

When you select this function, the following message will appear at the center of the screen to assist you in creating a password.

### ***ENTER PASSWORD:***

Type the password, up to eight characters in length, and press<Enter>. The new password will clear the previously entered password from the CMOS memory. You will be asked to confirm the password. Type the password again and press <Enter>. You may also press <Esc> to abort the selection and operate without a password.

To disable a password, just press <Enter> when you are prompted to enter the password. A message will be displayed to confirm that the password is disabled.

## PASSWORD DISABLED.

Once the password is disabled, the system will reset and you can enter the Setup Program freely.

When a password is enabled, you will be prompted to enter it every time you try to enter setup. This prevents an unauthorized person from changing any setting of your system configuration.

In addition, when a password is enabled, you can require the BIOS to request a password every time your system is rebooted. This would further prevent unauthorized use of your computer.

The password requirement is defined by the Security Option of the BIOS Features Setup Menu. If the Security Option is set to "System", the password will be required both at resetting and at entering setup. If the option is set to "Setup", the prompt only appears when you try to enter setup.

## Flash Update Procedure

A program AWDFLASH.EXE is included in the utility diskette or CD. The user is recommended to follow the procedure below to update the flash BIOS.

1. Create a DOS-bootable floppy diskette. Copy the new BIOS file (just obtained or downloaded) and the utility program AWDFLASH.EXE to the diskette.
2. Allow the PC system to boot from the DOS diskette.
3. At the DOS prompt, key in

**AWDFLASH**  
and hit <ENTER>

4. Enter the file name of the new BIOS.
5. The question: "Do you want to save file?" is displayed.  
*Key in "N" if there is no need to save the existing BIOS content.*  
*Key in "Y" if a backup copy of the existing BIOS is needed.*  
*(A file name has to be assigned to the existing BIOS binary file.)*
6. The question : "Are you sure to program?" is displayed.  
*Key in "Y"*
7. Wait until the flash-update is completed.
8. Power down the PC system.
9. Restart the PC.

### Warning:

1. If the flash memory writer utility was not able to successfully update a complete BIOS file, the system may not boot up.
2. Make sure that the BIOS file is available for this motherboard.
3. If you encounter problem while updating the new BIOS, DO NOT turn off your PC since this might prevent the system from booting up. Repeat the process, if the problem still persist, use the original BIOS file you saved to disk above to update. If it failed, you need service.