

# **865GDMC/865GDMCP 865PEDMC/865PEDMCP**

## ***USER'S MANUAL***

***M/B For Socket 478 Pentium 4 Processor***

***NO. G03-865GDMC***

***Rev:1.0***

**Release date: November 2003**

**Trademark:**

\* Specifications and Information contained in this documentation are furnished for information use only, and are subject to change at any time without notice, and should not be construed as a commitment by manufacturer.

# TABLE OF CONTENT

USER'S NOTICE .....	ii
MANUAL REVISION INFORMATION .....	ii
COOLING SOLUTIONS .....	ii
CHAPTER 1 INTRODUCTION OF 865GDMC/865GDMCP/865PEDMC/865PEDMCP MOTHERBOARD	
1-1 FEATURE OF MOTHERBOARD .....	1
1-2 SPECIFICATION .....	2
1-3 PERFORMANCE LIST .....	3
1-4 LAYOUT DIAGRAM & JUMPER SETTING .....	4
CHAPTER 2 HARDWARE INSTALLATION	
2-1 HARDWARE INSTALLATION STEPS .....	6
2-2 CHECKING MOTHERBOARD'S JUMPER SETTING .....	6
2-3 INSTALL CPU .....	7
2-3-1 GLOSSARY .....	7
2-3-2 ABOUT INTEL PENTIUM 4 478-PIN CPU .....	8
2-4 INSTALL MEMORY .....	8
2-5 EXPANSION CARD .....	9
2-5-1 PROCEDURE FOR EXPANSION CARD INSTALLATION .....	9
2-5-2 ASSIGNING IRQ FOR EXPANSION CARD .....	10
2-5-3 INTERRUPT REQUEST TABLE FOR THIS MOTHERBOARD .....	10
2-5-4 AGP SLOT .....	11
2-6 CONNECTORS, HEADERS .....	11
2-6-1 CONNECTORS .....	11
2-6-2 HEADERS .....	14
2-7 STARTING UP YOUR COMPUTER .....	17
CHAPTER 3 INTRODUCING BIOS	
3-1 ENTERING SETUP .....	18
3-2 GETTING HELP .....	18
3-3 THE MAIN MENU .....	19
3-4 STANDARD CMOS FEATURES .....	20
3-5 ADVANCED BIOS FEATURES .....	21
3-6 ADVANCED CHIPSET FEATURES .....	23
3-6-1 DRAM TIMING SETTINGS .....	24
3-7 INTEGRATED PERIPHERALS .....	25
3-7-1 ONBOARD IDE FUNCTION .....	25
3-7-2 ONBOARD DEVICE FUNCTION .....	26
3-7-3 ONBOARD SUPER IO FUNCTION .....	27
3-8 POWER MANAGEMENT SETUP .....	28
3-8-1 PM TIMER RELOAD EVENTS .....	29
3-9 PNP/PCI CONFIGURATION SETUP .....	30
3-9-1 IRQ RESOURCES .....	31
3-10 PC HEALTH STATUS .....	31
3-11 MISCELLANEOUS CONTROL .....	32
3-12 LOAD STANDARD/OPTIMIZED DEFAULTS .....	33
3-13 SET SUPERVISOR/USER PASSWORD .....	33
CHAPTER 4 DRIVER & FREE PROGRAM INSTALLATION	
MAGIC INSTALL SUPPORTS WINDOWS 98SE/ME/NT4.0/2000/XP .....	34
4-1 INF           INSTALL INTEL 865 CHIPSET SYSTEM DRIVER .....	35
4-2 VGA           INSTALL INTEL 865G VGA DRIVER .....	35
4-3 SOUND        INSTALL ALC AC97 CODEC AUDIO DRIVER .....	36
4-4 LAN           INSTALL VIA 6105 LAN CONTROLLER DRIVER .....	37
4-5 USB2.0       INSTALL INTEL USB2.0 DRIVER .....	38
4-6 PC-HEALTH .....	IN
STALL SMART GUARDIAN SOFTWARE FOR HARDWARE MONITORING DEVICE .....	38
4-6-1 HOW TO UTILIZE PC-HEALTH .....	39
4-7 MBIOS&DX8    INSTALL BIOS LIVE UPDATE UTILITY AND DIRECTX8.1 .....	40
4-8 PC-CILLIN    INSTALL PC-CILLIN2002 ANTI-VIRUS PROGRAM .....	41
4-9 HOW TO UPDATE BIOS .....	43

---

---

## USER'S NOTICE

COPYRIGHT OF THIS MANUAL BELONGS TO THE MANUFACTURER. NO PART OF THIS MANUAL, INCLUDING THE PRODUCTS AND SOFTWARE DESCRIBED IN IT MAY BE REPRODUCED, TRANSMITTED OR TRANSLATED INTO ANY LANGUAGE IN ANY FORM OR BY ANY MEANS WITHOUT WRITTEN PERMISSION OF THE MANUFACTURER.

THIS MANUAL CONTAINS ALL INFORMATION REQUIRED TO USE 865GDMC/865GDMCP/865PEDMC/865PEDMCP MOTHER-BOARD AND WE DO ASSURE THIS MANUAL MEETS USER'S REQUIREMENT BUT WILL CHANGE, CORRECT ANY TIME WITHOUT NOTICE. MANUFACTURER PROVIDES THIS MANUAL "AS IS" WITHOUT WARRANTY OF ANY KIND, AND WILL NOT BE LIABLE FOR ANY INDIRECT, SPECIAL, INCIDENTAL OR CONSEQUENTIAL DAMAGES (INCLUDING DAMAGES FOR LOSS OF PROFIT, LOSS OF BUSINESS, LOSS OF USE OF DATA, INTERRUPTION OF BUSINESS AND THE LIKE).

PRODUCTS AND CORPORATE NAMES APPEARING IN THIS MANUAL MAY OR MAY NOT BE REGISTERED TRADEMARKS OR COPYRIGHTS OF THEIR RESPECTIVE COMPANIES, AND THEY ARE USED ONLY FOR IDENTIFICATION OR EXPLANATION AND TO THE OWNER'S BENEFIT, WITHOUT INTENT TO INFRINGE.

## Manual Revision Information

Reversion	Revision History	Date
1.0	First Release	November 2003

## Item Checklist

- 865GDMC/865GDMCP/865PEDMC/865PEDMCP Motherboard
- Cable for IDE/Floppy
- CD for motherboard utilities
- Cable for USB Port 3/4 (Option)
- 865GDMC/865GDMCP/865PEDMC/865PEDMCP User's Manual

## Intel Pentium 4 Processor Family Cooling Solutions

As processor technology pushes to faster speeds and higher performance, thermal management becomes increasingly crucial when building computer systems. Maintaining the proper thermal environment is key to reliable, long-term system operation. The overall goal in providing the proper thermal environment is keeping the processor below its specified maximum case temperature. Heatsinks induce improved processor heat dissipation through increased surface area and concentrated airflow from attached fans. In addition, interface materials allow effective transfers of heat from the processor to the heatsink. For optimum heat transfer, Intel recommends the use of thermal grease and mounting clips to attach the heatsink to the processor.

When selecting a thermal solution for your system, please refer to the website below for collection of heatsinks evaluated and recommended by Intel for use with Intel processors. Note, those heatsinks are recommended for maintaining the specified Maximum T case requirement. In addition, this collection is not intended to be a comprehensive listing of all heatsinks that support Intel processors.

For vendor list of heatsink and fan, please visit :

<http://developer.intel.com/design/Pentium4/components/index>

---

---

# Chapter 1

## Introduction of 865GDMC/865GDMCP/ 865PEDMC/865PEDMCP Motherboard

### 1-1 Feature of motherboard

The 865GDMC/ 865GDMCP/ 865PEDMC /865PEDMCP motherboard is design for use Intel Pentium 4 Processor in 478 Pin Package/Northwood/Hyper Threading Processor with the Intel 865G/865PE Chipset delivers a high performance and professional desktop platform solution. Which utilize the Socket 478 design and the memory size expandable to 2.0GB.

These motherboards use the newest Intel 865G/865PE Chipset Supports 800/533/400MHz System Bus in data transfer rate, the motherboards provided 200/166/133MHz SDRAM clock frequency support DDR400/DDR333/DDR266 SDRAM. These motherboards also provided Dual Channel function to increase memory performance. The motherboard embedded ICH4 chipset offers two parallel ULTRA ATA **100** interface to provide speedier HDD throughout that boosts overall system performance.

865GDMC/865GDMCP with integrated 2D/3D Graphics Accelerator which supports 256 bit graphics core, and supports hardware motion compensation assist for software MPEG/DVD decode, makes this board lower cost alternative to a video card. For those wanting even greater graphic performance, an AGP 4X slot is included on the board (**For 1.5V AGP card only. No for 3.3V or Universal AGP card**). This AGP slot will support either a 4X/8X VGA card.

The 865GDMCP/ 865PEDMCP motherboard including Fast Ethernet PCI controller chip support 10Mb/s, 100Mb/s Base transfer rate.

These motherboards also has an integrated 6-channel AC97' CODEC chip on board support 6-channel 3D surround positioning Audio which is fully compatible with Sound Blaster Pro® that gives you the best sound quality and compatibility.

With USB control as well as capability of expanding to 6 USB2.0 function ports, these motherboards meet future USB demand also these motherboard have built-in hardware monitor function. This will monitor and protect your computer. These motherboards special design in hardware to protect BIOS from virus crash BIOS data.

These motherboards provide special function in BIOS Setup to setting CPU Host clock step by step increasing let users to approach over clocking.

These motherboards provided high performance & meet future specification demand. It is really wise choice for your computer.

## 1-2 Specification

Spec	Description
<b>Design</b>	* Micro ATX form factor 4 layers PCB size: 24.4x22.0cm
<b>Chipset</b>	* Intel 865G Graphics Memory Controller Hub (GMCH) Chipset for 865GDMC/865GDMCP * Intel 865PE Memory Controller Hub (MCH) Chipset for 865PEDMC/865PEDMCP * Intel 82801DB I/O Controller Hub (ICH4) Chipset
<b>CPU Socket</b> (mPGA478B Socket)	* Support Intel Pentium 4 478 Pin package utilizes Flip-Chip Pin Grid Array (FC-PGA2) package processor * Support CPU Frequency 400MHz/533MHz/800MHz * Support 1.6G~3.06G 478 Pin Pentium 4 processor * Reserves support for future Intel Pentium 4 processors
<b>Memory Socket</b>	* 184-pin DDR SDRAM module socket x2 * Support Dual channel DDR266/DDR333/DDR400 DDR SDRAM * Expandable to 2.0GB
<b>Expansion Slot &amp; Headers</b>	* AGP slot x1 for AGP 0.8V/1.5V standard only, support AGP 2.0/3.0 & 4X/8X mode * 32-bit PCI slot x 3
<b>Integrate VGA</b> ( for 865GDMC/ 865GDMCP )	* Integrated High Performance & High Quality 3D Accelerator * Support Ultra-AGP II with 2GB/s bandwidth * Built-in programmable 24-bit true-color RAMDAC up to 333MHz pixel clock.
<b>Integrate IDE</b>	* Two IDE controllers support PCI Bus Mastering, ATA PIO/DMA and the ULTRA DMA 33/66/100 functions that deliver the data transfer rate up to 100 MB/s
<b>LAN On Board</b> ( for 865GDMCP/ 865PEDMCP )	* VIA VT6105 LOM PCI LAN controller chip * Supports 10/100 Mb/sec data transfer rate
<b>Audio</b>	* Realtek ALC 6-channel AC97' Codec integrated * Support 6-channel 3D surround & Positioning Audio * Audio driver and utility included
<b>BIOS</b>	* Award 4Mb Flash ROM
<b>Multi I/O</b>	* PS/2 keyboard and PS/2 mouse connectors * Floppy disk drive connector x1 * Parallel port x1, Serial port x2 * USB 2.0 connector x4, headers x2 (connecting cable option) * Audio connector Line-in, Line-out, MIC & Game Port

## 1-3 Performance List

The following performance data list is the testing result of some popular benchmark testing programs. These data are just referred by users, and there is no responsibility for different testing data values gotten by users (the different Hardware & Software configuration will result in different benchmark testing results.)

### Performance Test Report

**CPU:** Intel Pentium 4 2.53GHz (533MHz FSB)/3GHZ (800MHz FSB) mPGAB package

**DRAM:** 512MB DDR400 SDRAM x2 (KINGSTON D328DW)

**On Board VGA:** 1024x768x32bit Color

**Hard Disk Driver:** IBM IC35L040AVVN07-0 (ATA-100 7200RPM)

**BIOS:** Award Optimal default

**OS:** Win XP Professional (Service Pack 1)

	2.53GHz 133/133	3GHz 200/200	3GHz 200/200 Dual Channel	3GHz 200/200 Dual Channel Hyper-Threading
3D Mark 2001SE	2192	2506	2967	2929
3D Mark 2003	59	70	94	92
3D Winbench 2000 (32/32BIT)	73.2	78.3	83.3	83.1
PC Mark 2002				
CPU/Memory/HDD	6146/5410/879	7336/6480/879	7364/7620/879	7380/7632/877
Content Creation Winstone 2002	41	48.9	51.7	46.4
Content Creation Winstone 2003	41.9	49.6	51.7	50.1
Business Winstone 2002	29.4	33.3	33.7	33.1
Winbench 99 V1.2:				
Business Disk Winmark99	8600	8840	9190	9180
Hi-end Disk Winmark99	32200	31700	31800	32900
Business Graphic Winmark	164	205	226	277
Hi-end Graphic Winmark	591	852	874	898
SYS Mark 2001/2002 : SISMark 2001/2002 Rating (Internet Content Creation / Office Productivity)				
SISMark 2001	236 (263/212)	278 (314/247)	286 (325/251)	271 (317/231)
SISMark 2002 in Windows XP	245 (346/173)	283 (411/195)	300 (429/210)	316 (436/229)
SISOFT Sandra 2003 :				
Dhrystone ALU MIPS	6778	7712	7743	9183
Whetstone FPU iSSE2 MFLOPS	1407/3114	1711/3944	1708/3942	2601/5416
RAM Int Buffered iSSE2 MB/S	2204	2688	4226	4266
RAM Float Buffered iSSE2 MB/S	2204	2689	4227	4263
Integer SSE2 IT/S	10033	11923	11925	11749
Floating-Point SSE2 IT/S	12768	15177	15178	21590
QUAKE3 DEMO1 FPS	110.9	125.6	134.1	134.5
DEMO2 FPS	110.5	127.3	136.3	135.9
Return to Castle Wolfenstein FPS	74.4	84.5	88.6	88.9
WCPUID System / CPU Clock	132.98/2526.62	199.66/2995.70	199.71/2995.70	199.71/2995.70

## 1-4 Layout Diagram & Jumper Setting

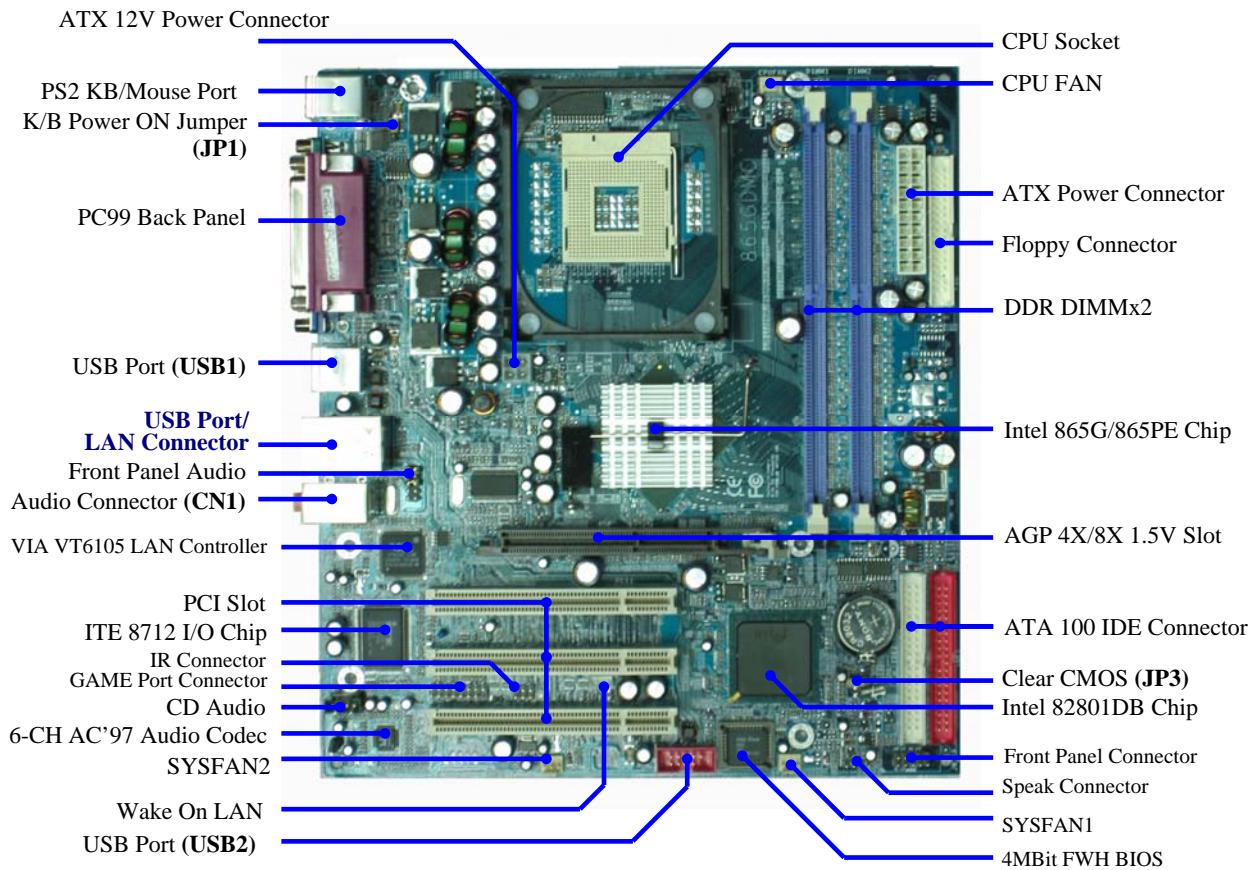
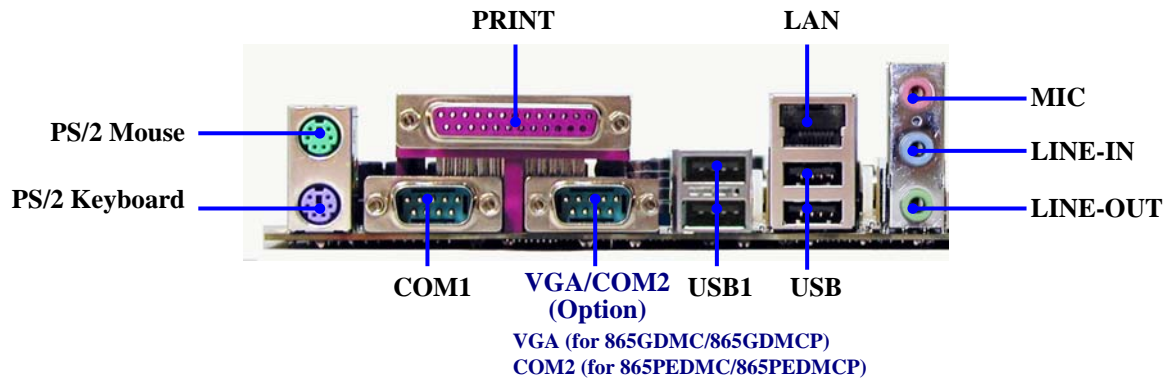

## Jumpers

Jumper	Name	Description	Page
JP3	CMOS RAM Clear	3-pin Block	P.6
JP1	Keyboard Power On Enable/Disabled	3-pin Block	P.7

## Connectors

Connector	Name	Description	Page
ATXPWR	ATX Power Connector	20-pin Block	P.11
ATX12V1	ATX 12V Power Connector	4-pin Block	P.12
USB1, UL_B	USB Port Connector	4-pin Connector	P.12
LAN (for 865GDMCP/865PEDMCP)	LAN Connectors	RJ-45 Connector	P.12
KB (PS2 KB/MOUSE)	PS/2 Mouse & PS/2 Keyboard Connector	6-pin Female	P.12
PARALLEL	Parallel Port Connector	25-pin Female	P.12
CNI	Audio Line In/Out MIC Connector	3 phone jack Connector	P.12
VGA (for 865GDMC/865GDMCP)	VGA Display Connector	15-pin Female Connector	P.12
COM1	Serial Port COM1 Connector	9-pin Connector	P.12
COM2 (for 865PEDMC/865PEDMCP)	Serial Port COM2 Connector	9-pin Connector	P.12
FDD	Floppy Driver Connector	34-pin Block	P.13
IDE1/IDE2	Primary/Secondary	40-pin Block	P.13

 Only for 865GDMC/865GDMCP

## Headers

Header	Name	Description	Page
AUDIO	Line-Out, MIC Headers	9-pin Block	P.14
USB2	USB Port Headers	9-pin Block	P.14
SPEAK	Speaker connector	4-pin Block	P.14
JW_FP (Power LED/Reset/ IDE LED/ Power Button)	Front Panel Header (including Power LED/ IDE activity LED/ Reset switch / Power On Button lead)	9-pin Block	P.14
WOL	Wake On-LAN Headers	3-pin Block	P.15
SYSFAN1, SYSFAN2, CPUFAN	FAN Speed Headers	3-pin Block	P.15
IR	IR infrared module Headers	5-pin Block	P.16
CDIN	CD Audio-In Headers	4-pin Block	P.16
GAME	Game Port Header	15-pin Block	P.16

## Expansion Sockets

Socket/Slot	Name	Description	Page
ZIF Socket 478	CPU Socket	478-pin mPGAB CPU Socket	P.8
DIMM1 /DIMM2	DDR Module Socket	184-pin DDR SDRAM Module Expansion Socket	P.8
PCI1 ~ PCI3	PCI Slot	32-bit PCI Local Bus Expansion slots	P.9
AGP	AGP 4X/8X Mode Slot	AGP Expansion Slot	P.11



---

---

## Chapter 2

### Hardware installation

#### 2-1 Hardware installation Steps

Before using your computer, you had better complete the following steps:

1. Check motherboard jumper setting
2. Install CPU and Fan
3. Install System Memory (DIMM)
4. Install Expansion cards
5. Connect IDE and Floppy cables, Front Panel /Back Panel cable
6. Connect ATX Power cable
7. Power-On and Load Standard Default
8. Reboot
9. Install Operating System
10. Install Driver and Utility

#### 2-2 Checking Motherboard's Jumper Setting

##### (1) CMOS RAM Clear (3-pin) : JP3

A battery must be used to retain the motherboard configuration in CMOS RAM short 1-2 pins of JP3 to store the CMOS data.

To clear the CMOS, follow the procedure below:

1. Turn off the system and unplug the AC power
2. Remove ATX power cable from ATX power connector
3. Locate JP3 and short pins 2-3 for a few seconds
4. Return JP3 to its normal setting by shorting pins 1-2
5. Connect ATX power cable back to ATX power connector

**Note: When should clear CMOS**

1. *Troubleshooting*
2. *Forget password*
3. *After over clocking system boot fail*

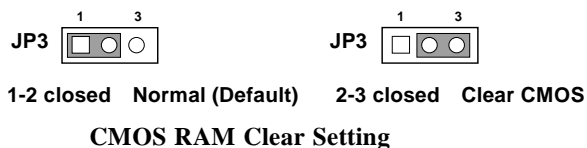
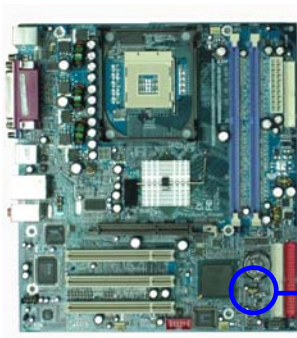

---

---

## (2) Keyboard Power On function Enabled/Disabled: JP1

When setting Enabled you can use keyboard by key in password/USB device to power on system.

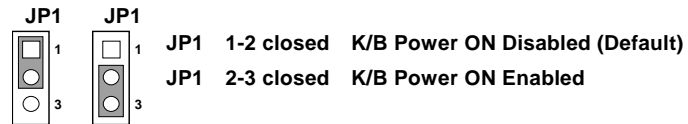
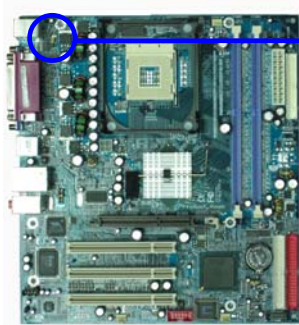

## 2-3 Install CPU

### 2-3-1 Glossary

**Chipset (or core logic)** - two or more integrated circuits which control the interfaces between the system processor, RAM, I/O devices, and adapter cards.

**Processor slot/socket** - the slot or socket used to mount the system processor on the motherboard.

**Slot** (AGP, PCI, ISA, RAM) - the slots used to mount adapter cards and system RAM.

**AGP - Accelerated Graphics Port** - a high speed interface for video cards; runs at 1X (66MHz), 2X (133MHz), or 4X (266MHz).

**PCI - Peripheral Component Interconnect** - a high speed interface for video cards, sound cards, network interface cards, and modems; runs at 33MHz.

**ISA - Industry Standard Architecture** - a relatively low speed interface primarily used for sound cards and modems; runs at approx. 8MHz.

**Serial Port** - a low speed interface typically used for mouse and external modems.

**Parallel Port** - a low speed interface typically used for printers.

**PS/2** - a low speed interface used for mouse and keyboards.

**USB - Universal Serial Bus** - a medium speed interface typically used for mouse, keyboards, scanners, and some digital cameras.

**Sound** (interface) - the interface between the sound card or integrated sound connectors and speakers, MIC, game controllers, and MIDI sound devices.

**LAN** (interface) - **Local Area Network** - the interface to your local area network.

**BIOS (Basic Input/Output System)** - the program logic used to boot up a computer and establish the relationship between the various components.

**Driver** - software, which defines the characteristics of a device for use by another device or other software.

**Processor** - the "central processing unit" (CPU); the principal integrated circuit used for doing the "computing" in "personal computer"

**Front Side Bus Frequency** - the working frequency of the motherboard, which is generated by the clock generator for CPU, DRAM and PCI BUS.

**CPU L2 Cache** - the flash memory inside the CPU, normally Athlon CPU has 256K or above, while Duron will have 64K.

---

---

## 2-3-2 About Intel Pentium 4 478-pin CPU

This motherboard provides a 478-pin surface mount, Zero Insertion Force (ZIF) socket, referred to as the mPGA478B socket supports Intel Pentium 4 processor in the 478 Pin package utilizes Flip-Chip Pin Grid Array (FC-PGA2) package technology.

The CPU that comes with the motherboard should have a cooling FAN attached to prevent overheating. If this is not the case, then purchase a correct cooling FAN before you turn on your system.

**WARNING!** Be sure that there is sufficient air circulation across the processor's heatsink and CPU cooling FAN is working correctly, otherwise it may cause the processor and motherboard overheat and damage, you may install an auxiliary cooling FAN, if necessary.

To install a CPU, first turn off your system and remove its cover. Locate the ZIF socket and open it by first pulling the level sideways away from the socket then upward to a 90-degree angle. Insert the CPU with the correct orientation as shown below. The notched corner should point toward the end of the level. Because the CPU has a corner pin for two of the four corners, the CPU will only fit in the orientation as shown.

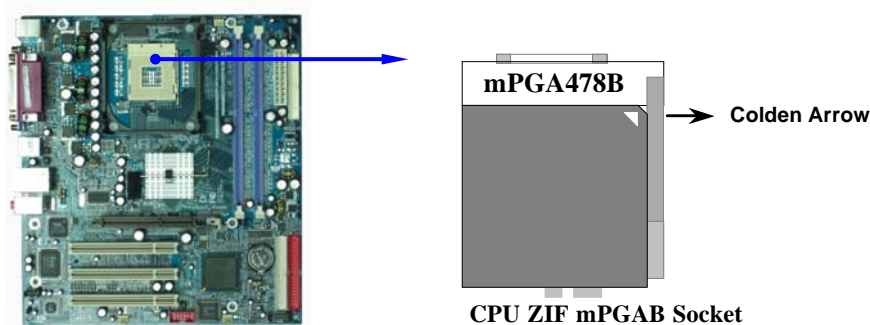

When you put the CPU into the ZIF socket. No force require to insert of the CPU, then press the level to Locate position slightly without any extra force.

## 2-4 Install Memory

This motherboard provides **two** 184-pin DUAL INLINE MEMORY MODULES (DIMM) sites for memory expansion available from minimum memory size of 64MB to maximum memory size of 2.0GB DDR SDRAM.

### Valid Memory Configurations

Bank	184-Pin DIMM	PCS	Total Memory
Bank 0, 1 (DIMM1)	DDRDDR266/DDR333/DDR400 DDR SDRAM Module	X1	64MB~1.0GB
Bank 2, 3 (DIMM2)	DDRDDR266/DDR333/DDR400 DDR SDRAM Module	X1	64MB~1.0GB
Total	System Memory (Max. 2.0GB)	4	64MB~2.0GB

---

---

***For Dual channel Limited!***

1. Dual channel function only supports when 2 DIMM Modules plug both DIMM1 & DIMM2
2. DIMM1 & DIMM2 must be the same type, same size, same frequency for dual channel function.

Generally, installing DDR SDRAM modules to your motherboard is very easy, you can refer to figure 2-4 to see what a 184-Pin DDR266/DDR333/DDR400 DDR SDRAM module looks like.

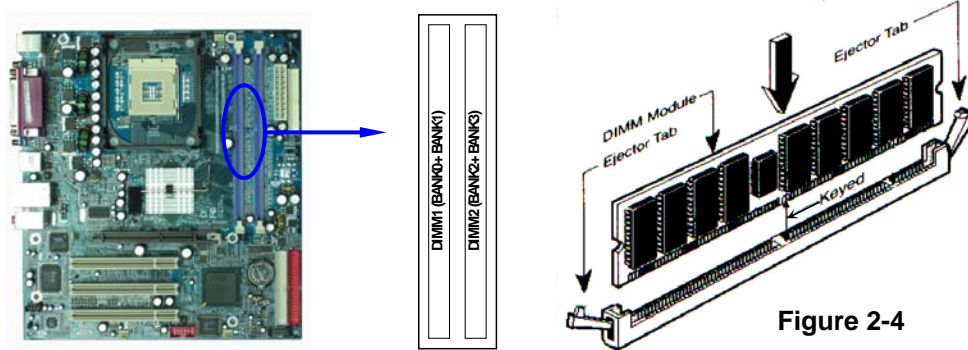

**NOTE!** When you install DIMM module fully into the DIMM socket the eject tab should be locked into the DIMM module very firmly and fit into its indentation on both sides.

**WARNING!** For the DDR SDRAM CLOCK is set at 200MHz, use only DDR400-compliant DDR Modules. When this motherboard operate at 200Mhz, most system will not even boot if non-compliant modules are used because of the strict timing issues, if your SDR Modules are not DDR266-compliant, set the DDR SDRAM clock to 133MHz to ensure system stability.

## 2-5 Expansion Cards

**WARNING!** Turn off your power when adding or removing expansion cards or other system components. Failure to do so may cause severe damage to both your motherboard and expansion cards.

### 2-5-1 Procedure For Expansion Card Installation

1. Read the documentation for your expansion card and make any necessary hardware or software setting for your expansion card such as jumpers.
2. Remove your computer's cover and the bracket plate on the slot you intend to use.
3. Align the card's connectors and press firmly.
4. Secure the card on the slot with the screen you remove above.
5. Replace the computer system's cover.
6. Set up the BIOS if necessary.
7. Install the necessary software driver for your expansion card.

### 2-5-2 Assigning IRQs For Expansion Card

Some expansion cards need an IRQ to operate. Generally, an IRQ must exclusively assign to one use. In a standard design, there are 16 IRQs available but most of them are already in use.

## Standard Interrupt Assignments

IRQ	Priority	Standard function
0	N/A	System Timer
1	N/A	Keyboard Controller
2	N/A	Programmable Interrupt
3 *	8	Communications Port (COM2)
4 *	9	Communications Port (COM1)
5 *	6	Sound Card (sometimes LPT2)
6 *	11	Floppy Disk Controller
7 *	7	Printer Port (LPT1)
8	N/A	System CMOS/Real Time Clock
9 *	10	ACPI Mode when enabled
10 *	3	IRQ Holder for PCI Steering
11 *	2	IRQ Holder for PCI Steering
12 *	4	PS/2 Compatible Mouse Port
13	N/A	Numeric Data Processor
14 *	5	Primary IDE Channel
15 *	1	Secondary IDE Channel

\* These IRQs are usually available for ISA or PCI devices.

## 2-5-3 Interrupt Request Table For This Motherboard

Interrupt request are shared as shown the table below:

	INT A	INT B	INT C	INT D	INT E	INT F	INT G	INT H
Slot 1		√						
Slot 2			√					
Slot 3				√				
Onboard VGA	√							
Onboard LAN					√			
Onboard USB 1								√
Onboard USB 2				√				
Onboard USB 3			√					
Sound		√						

**IMPORTANT!** If using PCI cards on shared slots, make sure that the drivers support “Shared IRQ” or that the cards don’t need IRQ assignments. Conflicts will arise between the two PCI groups that will make the system unstable or cards inoperable.

## 2-5-4 AGP Slot

This motherboard provides an AGP Slot, only support the 1.5V 4X/0.8V 8X AGP VGA card. Do not use AGP 2X card (3.3V) in this motherboard. It will burn and damage the motherboard due to Intel® 865 chipset can not support AGP 2X (3.3V).

**IMPORTANT!**

Before you plug-in AGP card, please make sure the following notice is fully understood and practiced. If your AGP card has “AGP 4X notch (show below) please make sure your AGP card is AGP 4X/8X (1.5V/0.8V) not AGP 2X (3.3V)

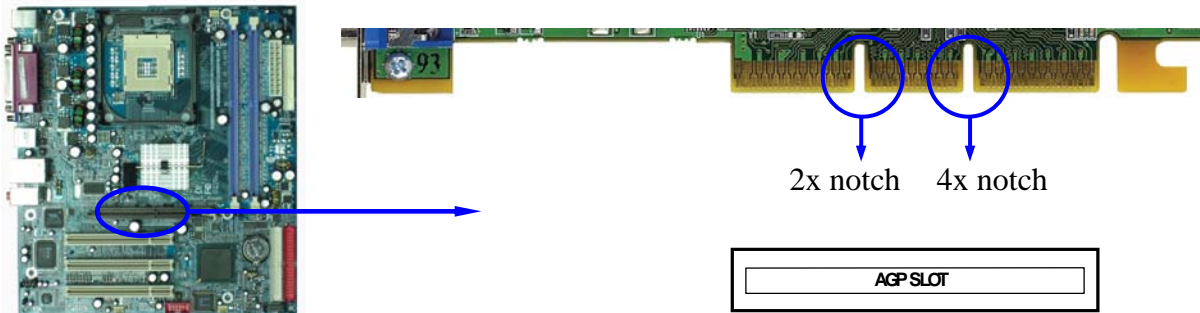

**Example 1:** SiS 305 & ATi Rage 128 Pro AGP card those golden finger is compatible with 2X/4X mode AGP slot, but only can support 2X (3.3V) only. If you install these cards in Intel® 865 based motherboard it will burn and damage the motherboard.

**Example 2:** We also find Diamond Vipper V770 golden finger is design for 2X/4X mode AGP Slot. It can be adjusted the jumper for AGP 2X (3.3V) or AGP 4X (1.5V). But the factory default setting is 2X (3.3V). If you install this AGP card in motherboard without change the jumper setting to 4X (1.5V), it will burn the motherboard.

## 2-6 Connectors, Headers

### 2-6-1 Connectors

(1) **Power Connector (20-pin block) : ATXPWR**

ATX Power Supply connector. This is a new defined 20-pins connector that usually comes with ATX case. The ATX Power Supply allows to use soft power on momentary switch that connect from the front panel switch to 2-pins Power On jumper pole on the motherboard. When the power switch on the back of the ATX power supply turned on, the full power will not come into the system board until the front panel switch is momentarily pressed. Press this switch again will turn off the power to the system board.

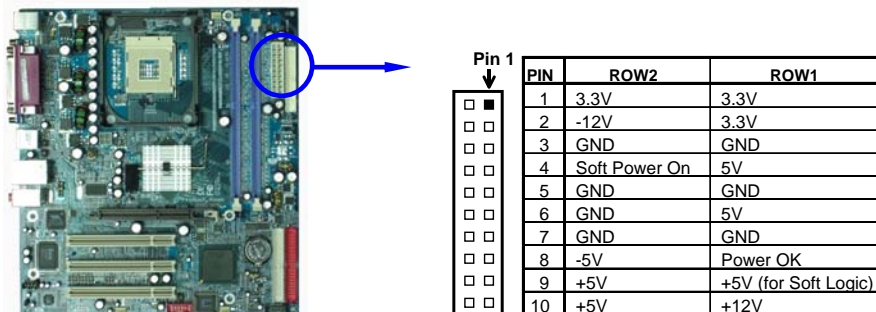

(2) **ATX 12V Power Connector (4-pin block) : ATX12V1**

This is a new defined 4-pins connector that usually comes with ATX Power Supply. The ATX Power Supply which fully support Pentium 4 processor must including this connector for support extra 12V voltage to maintain system power consumption. Without this connector might cause system unstable because the power supply can not provide sufficient current for system.

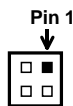
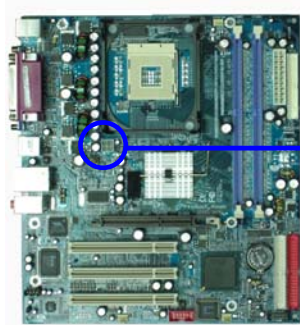

- (3) **USB Port connector: USB1, UL\_B (USB)**  
The connectors are 4-pin connector that connect USB devices to the system board.
- (4) **LAN Port connector: LAN (for 865GDMCP/865PEDMCP)**  
This connector is standard RJ45 connector for Network connector.
- (5) **PS/2 Mouse & PS/2 Keyboard Connector: KB (PS2 KB/MOUSE)**  
The connectors for PS/2 keyboard and PS/2 Mouse.
- (6) **Parallel Port Connector (25-pin female): PARALLEL**  
Parallel Port connector is a 25-pin D-Subminiature Receptacle connector. The On-board Parallel Port can be disabled through the BIOS SETUP. Please refer to Chapter 3 “INTEGRATED PERIPHERALS SETUP” section for more detail information.
- (7) **Audio Line-In, Lin-Out, MIC Connector : CN1**  
This Connector are 3 phone Jack for LINE-OUT, LINE-IN, MIC  
**Line-out :** Audio output to speaker  
**Line-in :** Audio input to sound chip  
**MIC :** Microphone Connector
- (8) **VGA Connector (15-pin D-Sub) Connector: VGA (for 865GDMC/865GDMCP only)**  
VGA is the 15-pin D-Subminiature female connector for display monitor.
- (9) **Serial Port COM1/COM2: COM1/COM2 (COM2 only for 865PEDMC/865PEDMCP)**  
COM1/COM2A is the 9-pin D-Subminiature mail connector. The On-board serial port can be disabled through BIOS SETUP. Please refer to Chapter 3 “INTEGRATED PERIPHERALS SETUP” section for more detail information.

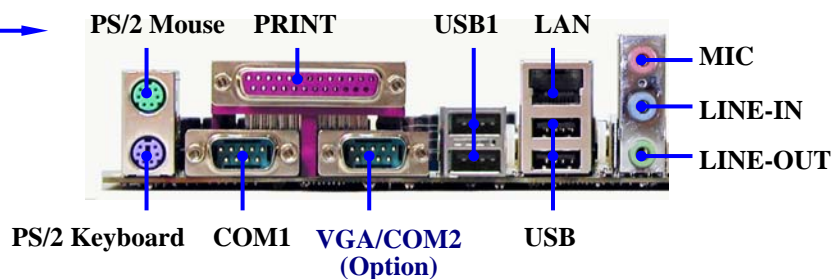
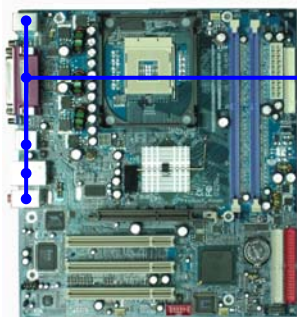

- (10) **Floppy drive Connector (34-pin block): FDD**  
This connector supports the provided floppy drive ribbon cable. After connecting the single plug end to motherboard, connect the two plugs at other end to the floppy drives.

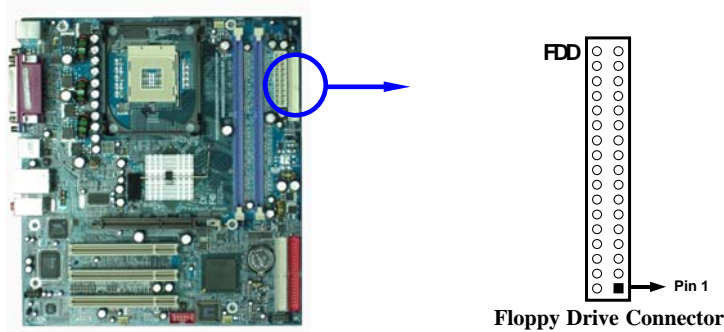

**(11) Primary IDE Connector (40-pin block): IDE1**

This connector supports the provided IDE hard disk ribbon cable. After connecting the single plug end to motherboard, connect the two plugs at other end to your hard disk(s). If you install two hard disks, you must configure the second drive to Slave mode by setting its jumpers accordingly. Please refer to the documentation of your hard disk for the jumper settings.

**(12) Secondary IDE Connector (40-pin block): IDE2**

This connector connects to the next set of Master and Slave hard disks. Follow the same procedure described for the primary IDE connector. You may also configure two hard disks to be both Masters using one ribbon cable on the primary IDE connector and another ribbon cable on the secondary IDE connector.

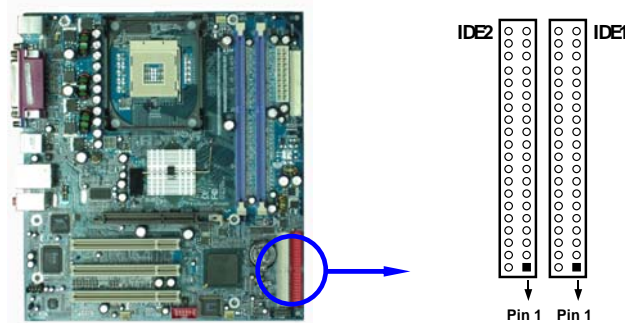

- Two hard disks can be connected to each connector. The first HDD is referred to as the “Master” and the second HDD is referred to as the “Slave”.
- For performance issues, we strongly suggest you don’t install a CD-ROM or DVD-ROM drive on the same IDE channel as a hard disk. Otherwise, the system performance on this channel may drop.



---

---

## 2-6-2 Headers

### (1) Line-Out, MIC Header (9-pin): AUDIO

This header connect to Front Panel Line-out, MIC connector with cable.

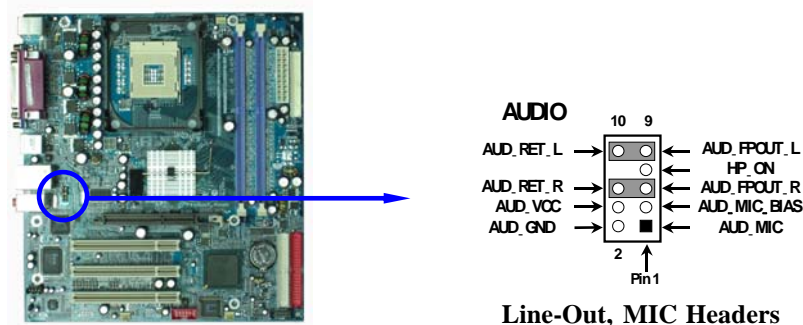

### (2) USB Port Headers (9-pin) : USB2

The header is used for connecting the additional USB port plug. By attaching an option USB cable, your can be provided with two additional USB plugs affixed to the back panel.

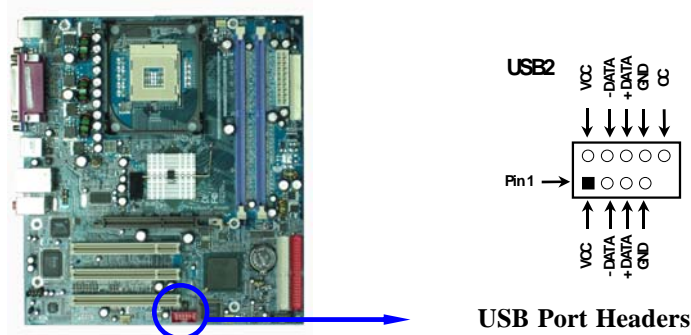

### (3) IDE Activity LED: IDE LED

This connector connects to the hard disk activity indicator light on the case.

### (4) Reset switch lead: RESET

This 2-pin connector connects to the case-mounted reset switch for rebooting your computer without having to turn off your power switch. This is a preferred method of rebooting in order to prolong the life of the system's power supply. See the figure below.

### (5) Speaker connector: SPEAK

This 4-pin connector connects to the case-mounted speaker. See the figure below.

### (6) Power LED: PWR-LED

The Power LED is light on while the system power is on. Connect the Power LED from the system case to this pin.

### (7) Power switch: PWR BTN

This 2-pin connector connects to the case-mounted power switch to power ON/OFF the system.

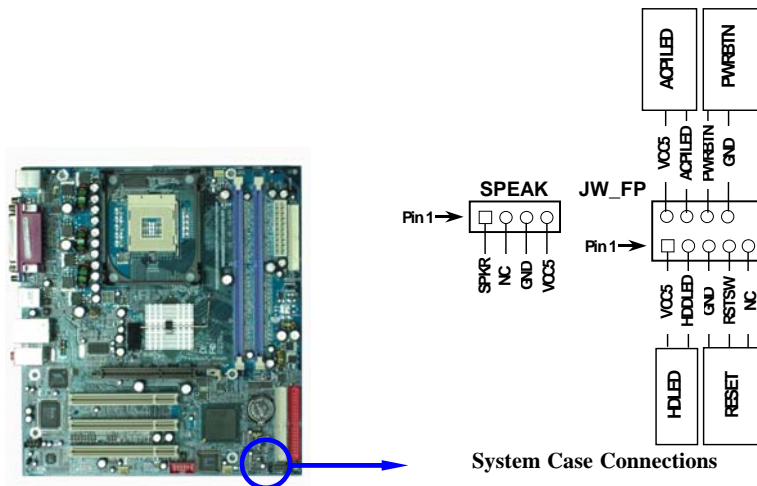

**(8) Wake On-LAN Headers (3-pin) : WOL**

This connector connects to a LAN card with a WAKE ON-LAN output. This connector power up the system when a wake up signal is received through the LAN card.

**NOTE:** This feature requires that Wake On LAN or Ring In Wake up is enabled.

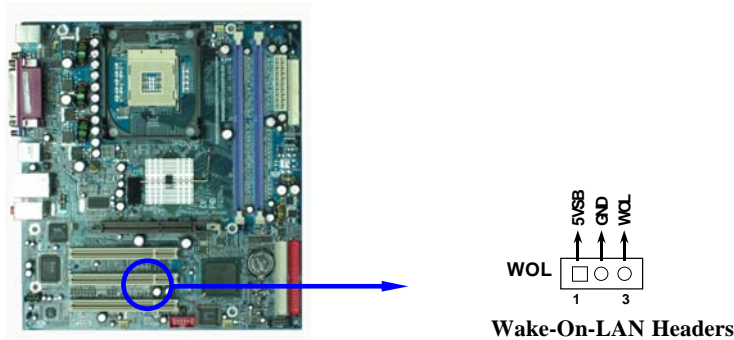

**(9) FAN Speed Headers (3-pin) : SYSFAN1, SYSFAN2, CPUFAN**

These connectors support cooling fans of 350mA (4.2 Watts) or less, depending on the fan manufacturer, the wire and plug may be different. The red wire should be positive, while the black should be ground. Connect the fan's plug to the board taking into consideration the polarity of connector.

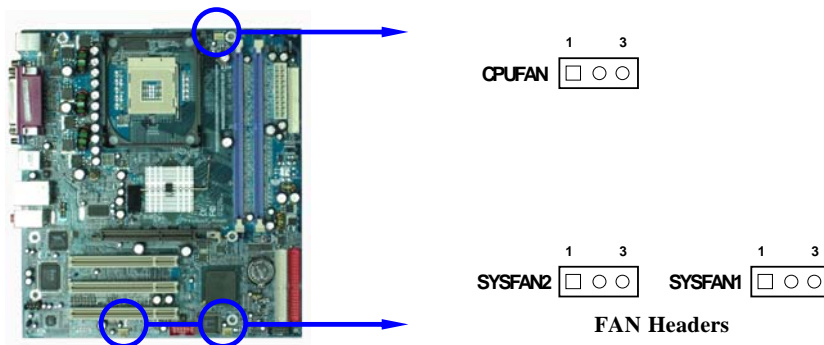

---

---

**(10) IR infrared module Headers (5-pin) : IR**

This connector supports the optional wireless transmitting and receiving infrared module. You must configure the setting through the BIOS setup to use the IR function.

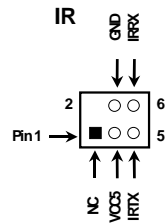
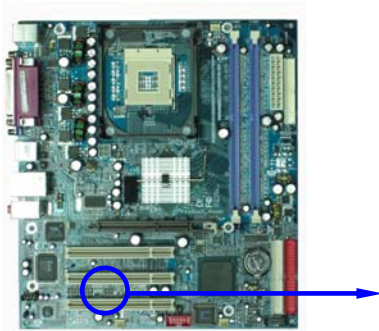

**IR infrared module Headers**

**(11) CD Audio-In Headers (4-pin) : CDIN**

CDIN are the connectors for CD-Audio Input signal. Please connect it to CD-ROM CD-Audio output connector.

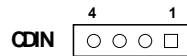
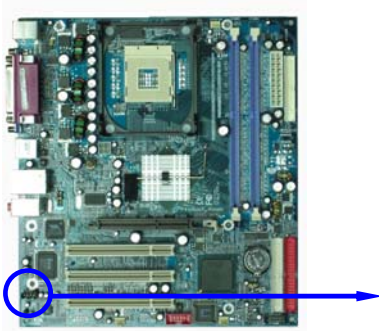

**CD Audio-In Headers**

**(12) Game Port Header: GAME**

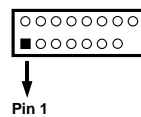
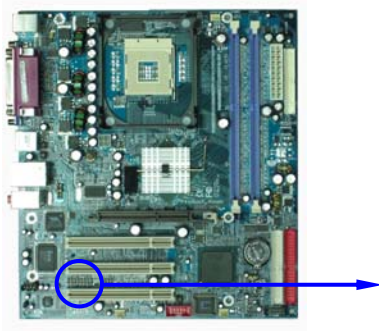

**GAME Port Headers**

---

---

## 2-7 Starting Up Your Computer

1. After all connection are made, close your computer case cover.
2. Be sure all the switch are off, and check that the power supply input voltage is set to proper position, usually in-put voltage is 220V~240V or 110V~120V depending on your country's voltage used.
3. Connect the power supply cord into the power supply located on the back of your system case according to your system user's manual.
4. Turn on your peripheral as following order:
  - a. Your monitor.
  - b. Other external peripheral (Printer, Scanner, External Modem etc...)
  - c. Your system power. For ATX power supplies, you need to turn on the power supply and press the ATX power switch on the front side of the case.
5. The power LED on the front panel of the system case will light. The LED on the monitor may light up or switch between orange and green after the system is on. If it complies with green standards or if it is has a power standby feature. The system will then run power-on test. While the test are running, the BIOS will alarm beeps or additional message will appear on the screen.

If you do not see any thing within 30 seconds from the time you turn on the power. The system may have failed on power-on test. Recheck your jumper settings and connections or call your retailer for assistance.

Beep	Meaning
One short beep when displaying logo	No error during POST
Long beeps in an endless loop	No DRAM install or detected
One long beep followed by three short beeps	Video card not found or video card memory bad
High frequency beeps when system is working	CPU overheated System running at a lower frequency

6. During power-on, press <Delete> key to enter BIOS setup. Follow the instructions in BIOS SETUP.
7. **Power off your computer:** You must first exit or shut down your operating system before switch off the power switch. For ATX power supply, you can press ATX power switching after exiting or shutting down your operating system. If you use Windows 9X, click "Start" button, click "Shut down" and then click "Shut down the computer?" The power supply should turn off after windows shut down.

---

---

## Chapter 3

### Introducing BIOS

The BIOS is a program located on a Flash Memory on the motherboard. This program is a bridge between motherboard and operating system. When you start the computer, the BIOS program gain control. The BIOS first operates an auto-diagnostic test called POST (power on self test) for all the necessary hardware, it detects the entire hardware device and configures the parameters of the hardware synchronization. Only when these tasks are completed done it gives up control of the computer to operating system (OS). Since the BIOS is the only channel for hardware and software to communicate, it is the key factor for system stability, and in ensuring that your system performance as its best.

In the BIOS Setup main menu of Figure 3-1, you can see several options. We will explain these options step by step in the following pages of this chapter, but let us first see a short description of the function keys you may use here:

- Press <Esc> to quit the BIOS Setup.
- Press ↑↓←→ (up, down, left, right) to choose, in the main menu, the option you want to confirm or to modify.
- Press <F10> when you have completed the setup of BIOS parameters to save these parameters and to exit the BIOS Setup menu.
- Press Page Up/Page Down or +/- keys when you want to modify the BIOS parameters for the active option.

### 3-1 Entering Setup

Power on the computer and by pressing <Del> immediately allows you to enter Setup.

If the message disappears before your respond and you still wish to enter Setup, restart the system to try again by turning it OFF then ON or pressing the “RESET” button on the system case. You may also restart by simultaneously pressing <Ctrl>, <Alt> and <Delete> keys. If you do not press the keys at the correct time and the system does not boot, an error message will be displayed and you will again be asked to

**Press <F1> to continue, <Ctrl-Alt-Esc> or <Del> to enter Setup**

### 3-2 Getting Help

#### Main Menu

The on-line description of the highlighted setup function is displayed at the bottom of the screen.

#### Status Page Setup Menu/Option Page Setup Menu

Press F1 to pop up a small help window that describes the appropriate keys to use and the possible selections for the highlighted item. To exit the Help Window, press <Esc>.

---

---

### 3-3 The Main Menu

Once you enter Award® BIOS CMOS Setup Utility, the Main Menu (Figure 3-1) will appear on the screen. The Main Menu allows you to select from fourteen setup functions and two exit choices. Use arrow keys to select among the items and press <Enter> to accept or enter the sub-menu.

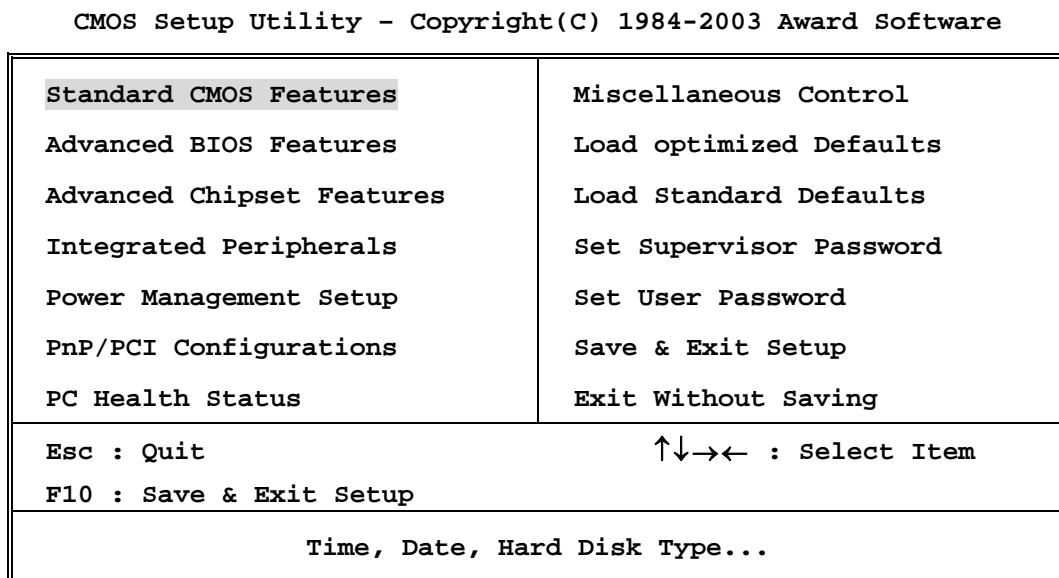

Figure 3-1

#### Standard CMOS Features

Use this Menu for basic system configurations.

#### Advanced BIOS Features

Use this menu to set the Advanced Features available on your system.

#### Advanced Chipset Features

Use this menu to change the values in the chipset registers and optimize your system's performance.

#### Integrated Peripherals

Use this menu to specify your settings for integrated peripherals.

#### Power Management Setup

Use this menu to specify your settings for power management.

#### PnP/PCI configurations

This entry appears if your system supports PnP/PCI.

#### PC Health Status

This entry shows your PC health status.

#### Miscellaneous Control

Use this menu to specify your settings for Miscellaneous control.

---

---

### Load Optimized Defaults

Use this menu to load the BIOS default values that are settings for optimal performances system operations.

### Load Standard Defaults

Use this menu to load the BIOS default values that are factory settings for the stable performance system operation.

### Set Supervisor/User Password

Use this menu to set User and Supervisor Passwords.

### Save & Exit Setup

Save CMOS value changes to CMOS and exit setup.

### Exit Without Saving

Abandon all CMOS value changes and exit setup.

## 3-4 Standard CMOS Features

The items in Standard CMOS Setup Menu are divided into several categories. Each category includes no, one or more than one setup items. Use the arrow keys to highlight the item and then use the <PgUp> or <PgDn> keys to select the value you want in each item.

CMOS Setup Utility - Copyright(C) 1984-2003 Award Software

### Standard CMOS Features

Date (mm:dd:yy)	Tue, Nov, 18 2003	Item Help
Time (hh:mm:ss)	11 : 02 : 35	
> IDE Primary Master	Press Enter None	Menu Level >
> IDE Primary Slave	Press Enter None	
> IDE Secondary Master	Press Enter None	Change the day, month, year and century
> IDE Secondary Slave	Press Enter None	
Drive A	1.44M, 3.5 in.	
Drive B	None	
Video	EGA/VGA	
Halt On	All,But Keyboard	
Base Memory	640K	
Extended Memory	56320K	
Total Memory	57344K	
↑↓→← Move Enter:Select +/-/PU/PD:Value F10:Save ESC:Exit F1:General Help F5:Previous Values F6:Optimized Defaults F7:Standard Defaults		

### Date

The date format is <day><month><date><year>.

**Day** Day of the week, from Sun to Sat, determined by BIOS. Read-only.

**Month** The month from Jan. through Dec.

**Date** The date from 1 to 31 can be keyed by numeric function keys.

**Year** The year depends on the year of the BIOS.

### Time

The time format is <hour><minute><second>.

**Primary Master/Primary Slave**  
**Secondary Master/Secondary Slave**

Press PgUp/<+> or PgDn/<-> to select Manual, None, Auto type. Note that the specifications of your drive must match with the drive table. The hard disk will not work properly if you enter improper information for this category. If your hard disk drive type is not matched or listed, you can use Manual to define your own drive type manually.

If you select Manual, related information is asked to be entered to the following items. Enter the information directly from the keyboard. This information should be provided in the documentation from your hard disk vendor or the system manufacturer.

If the controller of HDD interface is SCSI, the selection shall be "None".

If the controller of HDD interface is CD-ROM, the selection shall be "None"

- Access Mode**      The settings are Auto Normal, Large, and LBA.
- Cylinder**        number of cylinders
- Head**             number of heads
- Precomp**         write precomp
- Landing Zone**    landing zone
- Sector**          number of sectors

### 3-5 Advanced BIOS Features

CMOS Setup Utility - Copyright(C) 1984-2003 Award Software  
 Advanced BIOS Features

Anti-Virus Protection <b>Disabled</b> Cooling Sprite              Disabled CPU L1 & L2 Cache          Enabled Hyper Threading Technology   Disabled Quick Power On Self Test    Enabled HDD Boot Sprite             Disabled Hard Disk Boot Priority      Press Enter First Boot Device            Floppy Second Boot Device         HDD 0 Third Boot Device            CDROM Boot other Device            Enabled Swap Floppy Drive          Disabled Boot Up Floppy Seek         Enabled Boot Up NumLock Status     On Gate A20 Option             Fast Typematic Rate Setting      Disabled Typematic Rate (Chars/Sec)   6 Typematic Delay (Msec)     250 Security Option              Setup APIC Mode                    Disabled MPS Version Control For OS   1.4 OS Select For DRAM > 64MB   Non-OS2 Report NO FDD For Windows   Yes Intel OSB Logo Show         Disabled	Item Help  Menu Level >
↑↓→← Move Enter:Select +/-/PU/PD:Value F10:Save ESC:Exit F1:General Help F5:Previous Values F6:Optimized Defaults F7:Standard Defaults	

#### Anti-Virus Protection



---

---

Allows you to choose the VIRUS Warning feature for IDE Hard Disk boot sector protection. If this function is enabled and someone attempt to write data into this area, BIOS will show a warning message on screen and alarm beep.

**Disabled** (default) No warning message to appear when anything attempts to access the boot sector or hard disk partition table.

**Enabled** Activates automatically when the system boots up causing a warning message to appear when anything attempts to access the boot sector of hard disk partition table.

### **CPU Internal Cache**

The default value is Enabled.

**Enabled** (default) Enable cache

**Disabled** Disable cache

*Note: The internal cache is built in the processor.*

### **External Cache**

Choose Enabled or Disabled. This option enables the Level 2 cache memory.

### **CPU L2 Cache ECC Checking**

Choose Enabled or Disabled. This option enables the Level 2 cache memory ECC (error check correction).

### **Quick Power On Self Test**

This category speeds up Power On Self Test (POST) after you power on the computer. If this is set to Enabled. BIOS will shorten or skip some check items during POST.

**Enabled** (default) Enable quick POST

**Disabled** Normal POST

### **First/Second/Third/Fourth Boot Device**

The BIOS attempts to load the operating system from the devices in the sequence selected in these items. The settings are Floppy, LS/ZIP, HDD-0/HDD-1/HDD-3, SCSI, CDROM, LAD and Disabled.

### **Swap Floppy Drive**

Switches the floppy disk drives between being designated as A and B. Default is Disabled.

### **Boot Up Floppy Seek**

During POST, BIOS will determine if the floppy disk drive installed is 40 or 80 tracks. 360K type is 40 tracks while 760K, 1.2M and 1.44M are all 80 tracks.

### **Boot Up NumLock Status**

The default value is On.

**On** (default) Keypad is numeric keys.

**Off** Keypad is arrow keys.

### **Gate A20 Option**

**Normal** The A20 signal is controlled by keyboard controller or chipset hardware.

**Fast** (default) The A20 signal is controlled by port 92 or chipset specific method.

### **Typematic Rate Setting**

Keystrokes repeat at a rate determined by the keyboard controller. When enabled, the typematic rate and typematic delay can be selected. The settings are: Enabled/Disabled.

### Typematic Rate (Chars/Sec)

Sets the number of times a second to repeat a keystroke when you hold the key down. The settings are: 6, 8, 10, 12, 15, 20, 24, and 30.

### Typematic Delay (Msec)

Sets the delay time after the key is held down before it begins to repeat the keystroke. The settings are 250, 500, 750, and 1000.

### Security Option

This category allows you to limit access to the system and Setup, or just to Setup.

- System**            The system will not boot and access to Setup will be denied if the correct password is not entered at the prompt.
- Setup (default)** The system will boot, but access to Setup will be denied if the correct password is not entered prompt.

### OS Select For DRAM > 64MB

Allows OS2® to be used with >64MB or DRAM. Settings are Non-OS/2 (default) and OS2. Set to OS/2 if using more than 64MB and running OS/2.

## 3-6 Advanced Chipset Features

The Advanced Chipset Features Setup option is used to change the values of the chipset registers. These registers control most of the system options in the computer.

CMOS Setup Utility - Copyright(C) 1984-2003 Award Software  
Advanced Chipset Features

<pre>&gt; DRAM Timing Settings      Press Enter   System BIOS Cacheable     Enabled   Video BIOS Cacheable      Enabled   Memory Hole At 15M-16M    Disabled   Delay Transaction          Enabled   AGP Transfer Mode         Auto   AGP Aperture Size         128MB   On-Chip VGA               Enabled   On-Chip Frame Buffer Size  16MB</pre>	Item Help  Menu Level >
<pre>↑↓→← Move Enter:Select +/-/PU/PD:Value F10:Save ESC:Exit F1:General Help F5:Previous Values F6:Optimized Defaults F7:Standard Defaults</pre>	

### DRAM Timing Settings

Please refer to section 3-6-1

### System BIOS Cacheable

Selecting Enabled allows caching of the system BIOS ROM at F0000h-FFFFFh, resulting in better system performance. However, if any program writes to this memory area, a system error may result. The settings are: Enabled and Disabled.

### Video RAM Cacheable

Select Enabled allows caching of the video BIOS, resulting in better system performance. However, if any program writes to this memory area, a system error may result. The settings are: Enabled and Disabled.

### Memory Hole At 15M-16M

You can reserve this area of system memory for ISA adapter ROM. When this area is reserved, it cannot be cached. The user information of peripherals that need to use this area of system memory usually discusses their memory requirements. The settings are: Enabled and Disabled.

### Delay Transaction

The chipset has an embedded 32-bit posted write buffer to support delay transactions cycles. Select Enabled to support compliance with PCI specification version 2.1. The settings are: Enabled and Disabled.

### AGP Transfer Mode

In this item you can select AGP transfer mode Auto/4X/1X the Default setting is Auto.

## 3-6-1 DRAM Timing Settings

CMOS Setup Utility - Copyright(C) 1984-2003 Award Software

### DRAM Timing Settings

Auto Configuration	Standard	Item Help
SDRAM CAS Latency Time	2.5	Menu Level >>
SDRAM Cycle Time	7	
SDRAM RAS# to CAS# Delay	3	
SDRAM RAS# Precharge Time	3	
↑↓→← Move Enter:Select +/-/PU/PD:Value F10:Save ESC:Exit F1:General Help F5:Previous Values F6:Optimized Defaults F7:Standard Defaults		

### SDRAM CAS Latency Time

When synchronous DRAM is installed, the number of clock cycles of CAS latency depends on the DRAM timing. The settings are: 2T and 2.5T.

*Note: Change these settings only if you are familiar with the chipset.*

### SDRAM RAS# to CAS# Delay

This field let's you insert a timing delay between the CAS and RAS strobe signals, used when DRAM is written to, read from, or refreshed. *Fast* gives faster performance; and *Slow* gives more stable performance. This field applies only when synchronous DRAM is installed in the system. The settings are: 2T, 3T and 4T.

### SDRAM RAS# Precharge Time

If an insufficient number of cycles is allowed for the RAS to accumulate its charge before DRAM refresh, the refresh may be incomplete and the DRAM may fail to retain date. *Fast* gives faster performance; and *Slow* gives more stable performance. This field applies only when synchronous DRAM is installed in the system. The settings are: 2T, 3T and 4T.

## 3-7 Integrated Peripherals

Integrated Peripherals

> Onboard IDE Function	Press Enter	Item Help
> Onboard Device Function	Press Enter	
> Onboard Super IO Function	Press Enter	Menu Level >
Init Display First	PCI Slot	
Power On Function	Button Only	
KB Power On Password	Enter	
Hot Key Power On	Ctrl-F1	
Power Loss Function	Always Off	
↑↓→← Move Enter:Select +/-/PU/PD:Value F10:Save ESC:Exit F1:General Help F5:Previous Values F6:Optimized Defaults F7:Standard Defaults		

### Onboard IDE Function

Please refer to section 3-7-1

### Onboard Device Function

Please refer to section 3-7-2

### Onboard Super IO Function

Please refer to section 3-7-3

### Init Display First

This item allows you to decide to activate whether PCI Slot or AGP VGA first. The settings are: PCI Slot, AGP Slot.

## 3-7-1 Onboard IDE Function

Onboard IDE Function

OnChip Primary PCI IDE	Enabled	Item Help	
OnChip Secondary PCI IDE	Enabled		
Primary Master PIO	Auto	Menu Level >>	
Primary Slave PIO	Auto		
Secondary Master PIO	Auto		
Secondary Slave PIO	Auto		
Primary Master UDMA	Auto		
Primary Slave UDMA	Auto		
Secondary Master UDMA	Auto		
Secondary Slave UDMA	Auto		
IDE 32-bit Transfer Mode	Enabled		
IDE HDD Block Mode	Enabled		
Delay For HDD (Secs)	0		
↑↓→← Move Enter:Select +/-/PU/PD:Value F10:Save ESC:Exit F1:General Help F5:Previous Values F6:Optimized Defaults F7:Standard Defaults			

### OnChip IDE Primary/Secondary

The integrated peripheral controller contains an IDE interface with support for two IDE channels. Select *Enabled* to activate each channel separately. The settings are: Enabled and Disabled.

#### Primary/Secondary Master/Slave PIO

The four IDE PIO (Programmed Input/Output) fields let you set a PIO mode (0-4) for each of the four IDE devices that the onboard IDE interface supports. Modes 0 through 4 provide successively increased performance. In Auto mode, the system automatically determines the best mode for each device. The settings are: Auto, Mode 0, Mode 1, Mode 2, Mode 3, Mode 4.

#### Primary/Secondary Master/Slave UDMA

Ultra DMA/33 implementation is possible only if your IDE hard drive supports it and the operating environment includes a DMA driver (Windows 95 OSR2 or a third-party IDE bus master driver). If your hard drive and your system software both support Ultra DMA/33 and Ultra DMA/66, select Auto to enable BIOS support. The settings are: Auto, Disabled.

#### IDE HDD Block Mode

Block mode is also called block transfer, multiple commands, or multiple sector read/write. If your IDE hard drive supports block mode (most new drives do), select Enabled for automatic detection of the optimal number of block read/writes per sector the drive can support. The settings are: Enabled, Disabled.

### 3-7-2 Onboard Device Function

CMOS Setup Utility - Copyright(C) 1984-2003 Award Software

#### Onboard Device Function

AC97 Audio	Auto	Item Help
AC97 Modem	Auto	
Game Port Address	201	Menu Level >>
Midi Port Address		
Midi Port IRQ	10	
USB Controller	Enabled	
USB Keyboard Legacy Support	Disabled	
↑↓→← Move Enter:Select +/-/PU/PD:Value F10:Save ESC:Exit F1:General Help F5:Previous Values F6:Optimized Defaults F7:Standard Defaults		

#### AC97 Audio/AC97 Modem

This item is setting on board AC97 Audio/AC97 Modem enabled/disabled. The settings are: Enabled, Disabled, Auto.

#### Game Port Address/Midi Port Address

This will determine which Address the Game Port/Midi Port will use.

#### USB Controller

Select *Enabled* if your system contains a Universal Serial Bus (USB) controller and you have a USB peripherals. The settings are: Enabled, Disabled.

#### USB Keyboard Legacy Support

Select *Enabled* if your system contains a Universal Serial Bus (USB) controller and you have a USB keyboard. The settings are: Enabled, Disabled.

### 3-7-3 Onboard Super IO Function

Onboard Super IO Function

Onboard FDD Controller	<b>Enabled</b>	Item Help
Onboard Serial Port 1	3F8/IRQ4	
Onboard Serial Port 2	Disabled	Menu Level >>
UART Mode Select	Normal	
IR2 Duplex Mode	Half	
Onboard Parallel Port	378/IRQ7	
Parallel Mode	SPP	
ECP Mode Use DMA	3	
↑↓→← Move Enter:Select +/-/PU/PD:Value F10:Save ESC:Exit F1:General Help F5:Previous Values F6:Optimized Defaults F7:Standard Defaults		

### Onboard FDD Controller

Select Enabled if your system has a floppy disk controller (FDD) installed on the system board and you wish to use it. If you install add-on FDC or the system has no floppy drive, select Disabled in this field. The settings are: Enabled and Disabled.

### Onboard Serial Port 1/Port 2

Select an address and corresponding interrupt for the first and the second serial ports. The settings are: 3F8/IRQ4, 2E8/IRQ3, 3E8/IRQ4, 2F8/IRQ3, Disabled, Auto.

### UART Mode Select

This item allows you to determine which InfraRed(IR) function of the onboard I/O chip, this functions uses.

### Onboard Parallel Port

There is a built-in parallel port on the on-board Super I/O chipset that Provides Standard, ECP, and EPP features. It has the following option:

#### Disabled

- (3BCH/IRQ7)/ Line Printer port 0
- (278H/IRQ5)/ Line Printer port 2
- (378H/IRQ7) Line Printer port 1

### Parallel Port Mode

- SPP : Standard Parallel Port
- EPP : Enhanced Parallel Port
- ECP : Extended Capability Port

#### SPP/EPP/ECP/ECP+EPP

To operate the onboard parallel port as Standard Parallel Port only, choose "SPP." To operate the onboard parallel port in the EPP modes simultaneously, choose "EPP." By choosing "ECP", the onboard parallel port will operate in ECP mode only. Choosing "ECP+EPP" will allow the onboard parallel port to support both the ECP and EPP modes simultaneously. The ECP mode has to use the DMA channel, so choose the onboard parallel port with the ECP feature. After selecting it, the following message will appear: "ECP Mode Use DMA" at this time, the user can choose between DMA channels 3 to 1. The onboard parallel port is EPP Spec. compliant, so after the user chooses the onboard parallel port with the EPP function, the following message will be displayed on the screen: "EPP Mode Select."

At this time either EPP 1.7 spec. or EPP 1.9 spec. can be chosen.

## 3-8 Power Management Setup

The Power Management Setup allows you to configure your system to most effectively save energy saving while operating in a manner consistent with your own style of computer use.

CMOS Setup Utility - Copyright(C) 1984-2003 Award Software

Power Management Setup

ACPI Function	Enabled	Item Help
Power Management	User Define	
Video off Method	V/H SYNC+Blank	Menu Level >
Video Off In Suspend	Yes	
Suspend Type	Stop Grant	
MODEM Use IRQ	3	
Suspend Mode	Disabled	
HDD Power Down	Disabled	
Soft-off by PWR-BTNN	Instant-off	
Wake-Up by PCI card	Disabled	
Power On by Ring	Disabled	
Resume by Alarm	Disabled	
X Date (of Month)	0	
X Time (hh:mm:ss)	0 : 0 :0	
CPU Thermal Management Timer	32 Min	
> PM Timer Reload Events	Press Enter	
↑↓→← Move Enter:Select +/-/PU/PD:Value F10:Save ESC:Exit F1:General Help F5:Previous Values F6:Optimized Defaults F7:Standard Defaults		

**ACPI Function**

This item allows you to Enabled/Disabled the Advanced Configuration and Power Management (ACPI). The settings are Enabled and Disabled.

**Video Off in Suspend**

This determines the manner in which the monitor is blanked. The choice are Yes → Video will off , and No→ Video always On.

**Video Off Method**

This determines the manner in which the monitor is blanked.

- DPMS (default) Initial display power management signaling.
- Blank Screen This option only writes blanks to the video buffer.
- V/H SYNC+Blank This selection will cause the system to turn off the vertical and horizontal synchronization ports and write blanks to the video buffer.

**Modem Use IRQ**

This determines the IRQ in which the MODEM can use.  
The settings are: 3, 4, 5, 7, 9, 10, 11, NA.

**Power Button Function**

Pressing the power button for more than 4 seconds forces the system to enter the Soft-Off state. The settings are: Delay 4 Sec, Instant-Off.

**Wake-Up by PCI card /Power On by Ring**

During Disabled, the system will ignore any incoming call from the PCI card/modem. During Enabled, the system will boot up if there's an incoming call from the PCI card /modem.

**Wake-Up on RTC Alarm**

This function is for setting date and time for your computer to boot up. During Disabled, you cannot use this function. During Enabled, choose the Date and Time Alarm:

---

---

### Date(of month) Alarm

You can choose which month the system will boot up. Set to 0, to boot every day.

### Time(hh:mm:ss) Alarm

You can choose what hour, minute and second the system will boot up.

**Note:** If you have change the setting, you must let the system boot up until it goes to the operating system, before this function will work

### PM Timer Reload Events

Please refer to section 3-8-1

## 3-8-1 PM Timer Reload Events

CMOS Setup Utility - Copyright(C) 1984-2003 Award Software

### PM Timer Reload Events

Primary IDE 0	Disabled	Item Help
Primary IDE 1	Disabled	
Secondary IDE 0	Disabled	
Secondary IDE 1	Disabled	Menu Level >>
FDD, COM, LPT Port	Disabled	
PCI PIRQ [A-D] #	Disabled	

↑↓→← Move Enter:Select +/-/PU/PD:Value F10:Save ESC:Exit F1:General Help  
F5:Previous Values F6:Optimized Defaults F7:Standard Defaults



---

---

## 3-9 PnP/PCI Configuration Setup

This section describes configuring the PCI bus system. PCI, or Personal Computer Interconnect, is a system which allows I/O devices to operate at speeds nearing the speed the CPU itself uses when communicating with its own special components. This section covers some very technical items and it is strongly recommended that only experienced users should make any changes to the default settings.

CMOS Setup Utility - Copyright(C) 1984-2003 Award Software  
PnP/PCI Configurations

Reset Configuration Data	Disabled	Item Help
Resources Controlled By	Manual	Menu Level >
x IRQ Resources	Press Enter	
PCI/VGA Palette Snoop	Disabled	
Assign IRQ For VGA	Enabled	
↑↓→← Move Enter:Select +/-/PU/PD:Value F10:Save ESC:Exit F1:General Help F5:Previous Values F6:Optimized Defaults F7:Standard Defaults		

### Reset Configuration Data

Normally, you leave this field Disabled. Select Enabled to reset Extended System Configuration Data (ESCD) when you exit Setup if you have installed a new add-on and the system reconfiguration has caused such a serious conflict that the operating system can not boot. The settings are: Enabled and Disabled.

### Resource Controlled By

The Award Plug and Play BIOS has the capacity to automatically configure all of the boot and Plug and Play compatible devices. However, this capability means absolutely nothing unless you are using a Plug and Play operating system such as Windows®95/98. If you set this field to “manual” choose specific resources by going into each of the sub menu that follows this field (a sub menu is preceded by a “>”).

The settings are: Auto(ESCD), Manual.

### IRQ Resources

When resources are controlled manually, assign each system interrupt a type, depending on the type of device using the interrupt.

Please refer to section 3-9-1

### PCI/VGA Palette Snoop

Leave this field at *Disabled*. The settings are Enabled, Disabled.

## 3-9-1 IRQ Resources

CMOS Setup Utility - Copyright(C) 1984-2003 Award Software

### IRQ Resources

IRQ-3	assigned to	PCI Device	Item Help
IRQ-4	assigned to	PCI Device	
IRQ-5	assigned to	PCI Device	Menu Level >>
IRQ-7	assigned to	PCI Device	
IRQ-9	assigned to	PCI Device	
IRQ-10	assigned to	PCI Device	
IRQ-11	assigned to	PCI Device	
IRQ-12	assigned to	PCI Device	
IRQ-14	assigned to	PCI Device	
IRQ-15	assigned to	PCI Device	
↑↓→← Move Enter:Select +/-/PU/PD:Value F10:Save ESC:Exit F1:General Help F5:Previous Values F6:Optimized Defaults F7:Standard Defaults			

## 3-10 PC Health Status

This section shows the Status of you CPU, Fan, Warning for overall system status. This is only available if there is Hardware Monitor onboard.

CMOS Setup Utility - Copyright(C) 1984-2003 Award Software

### PC Health Status

Shutdown Temperature	Disabled	Item Help
CPU Warning Temperature	Disabled	
Show PC Health in Post	Enabled	Menu Level >
Current System Temperature	25°C	
Current CPU Temperature	38°C	
Current CPUFAN Speed	5000 rpm	
Current SYSFAN Speed	5000 rpm	
Current SYSFAN2 Speed	5000 rpm	
Vcore	1.71V	
Vcc1.5	1.51V	
Vcc3.3	3.31V	
+ 5V	4.98V	
+12V	12.22V	
-12V	-12.36V	
- 5V	-4.99V	
VBAT(V)	3.21V	
5VSB(V)	5.02V	
↑↓→← Move Enter:Select +/-/PU/PD:Value F10:Save ESC:Exit F1:General Help F5:Previous Values F6:Optimized Defaults F7:Standard Defaults		

### Show PC Health in Post

During Enabled, it displays information list below. The choice is either Enabled or Disabled.

**Current CPU Temperature/Current System Temp/Current FAN1, FAN2 Speed/Vcore/Vdd/3.3V/+5V/+12V/-12V/VBAT(V)/5VSB(V)**

This will show the CPU/FAN/System voltage chart and FAN Speed.

### Shutdown Temperature

This item can let users setting the Shutdown temperature, when CPU temperature over this setting the system will auto shutdown to protect CPU.

---

---

## 3-11 Miscellaneous Control

This section is for setting CPU Frequency/Voltage Control.

CMOS Setup Utility - Copyright(C) 1984-2003 Award Software  
Miscellaneous Control

CPU Clock Ratio	8 X	Item Help
Auto Detect PCI Clk	Enabled	
Spread Spectrum	Disabled	
** Current Host Clock is 100/33MHz **		Menu Level >
HOST/PCI Clock at Next Boot is	100/33MHz	
** Current DRAM Clock is 133MHz **		
DRAM Clock at Next Boot is	DDR266	
Flash Part Write Protect	Enabled	
↑↓→← Move Enter:Select +/-/PU/PD:Value F10:Save ESC:Exit F1:General Help F5:Previous Values F6:Optimized Defaults F7:Standard Defaults		

### Auto Detect PCI Clk

This item allows you to enable/disable auto detect PCI Clock.

The settings are: Enabled, Disabled.

### Spread Spectrum

This item allows you to set the CPU Host/PCI clock and Spread Spectrum.

The settings are: Enabled, Disabled.

### Host/PCI Clock at Next Boot

This item allows you to select CPU frequency step by step increasing.

The choice are: 400MHz CPU----100MHz~350MHz, 533MHz CPU---133MHz~350MHz

800MHz CPU---200MHz~350MHz

### DRAM Clock at Next Boot is

This item allows you select the DRAM Clock for DDR266/DDR333/DDR400. The setting are:

DDR266 for P4/400MHz CPU, DDR266/DDR333 for P4/533MHz CPU, DDR266/DDR333 /DDR400 for P4/800MHz CPU

### Flash Part Write Protect

This item allows you protect your BIOS chip from Virus destroy data. When Flash BIOS you have Disabled this item.

---

---

## 3-12 Load Standard/Optimized Defaults

### Load Standard Defaults

When you press <Enter> on this item, you get confirmation dialog box with a message similar to:

Load Standard Defaults (Y/N)? N

Pressing <Y> loads the BIOS default values for the most stable, minimal-performance system operations.

### Load Optimized Defaults

When you press <Enter> on this item, you get a confirmation dialog box with a message similar to:

Load Optimized Defaults (Y/N)? N

Pressing <Y> loads the default values that are factory settings for optimal performance system operations.

## 3-13 Set Supervisor/User Password

You can set either supervisor or user password, or both of them. The differences are:

**Supervisor password:** Can enter and change the options of the setup menus.

**User password:** Can only enter but do not have the right to change the options of the setup menus. When you select this function, the following message will appear at the center of the screen to assist you in creating a password.

### ENTER PASSWORD:

Type the password, up to eight characters in length, and press <Enter>. The password typed now will clear any previously entered password from CMOS memory. You will be asked to confirm the password. Type the password again and press <Enter>. You may also press <Esc> to abort the selection and not enter a password.

To disable a password, just press <Enter> when you are prompted to enter the password. A message will confirm that the password will be disabled. Once the password is disabled, the system will boot and you can enter Setup freely.

### PASSWORD DISABLED.

When a password has been enabled, you will be prompted to enter it every time you try to enter Setup. This prevents an unauthorized person from changing any part of your system configuration.

Additionally, when a password is enabled, you can also require the BIOS to request a password every time your system is rebooted. This would prevent unauthorized use of your computer.

You determine when the password is required within the BIOS Features Setup Menu and its Security option. If the Security option is set to “System”, the password will be required both at boot and at entry to Setup. If set to “Setup”, prompting only occurs when trying to enter Setup.

---

---

## Chapter 4

### DRIVER & FREE PROGRAM INSTALLATION

Check your package and there is A MAGIC INSTALL CD included. This CD consists of all DRIVERS you need and some free application programs and utility programs. In addition, this CD also include an auto detect software which can tell you which hardware is installed, and which DRIVERS needed so that your system can function properly. We call this auto detect software MAGIC INSTALL.

#### MAGIC INSTALL Supports WINDOWS 98SE/ME/NT4.0/2000/XP

Insert CD into your CD-ROM drive and the MAGIC INSTALL Menu should appear as below. If the menu does not appear, double-click MY COMPUTER / double-click CD-ROM drive or click START / click RUN / type X:\SETUP.EXE (assuming X is your CD-ROM drive).

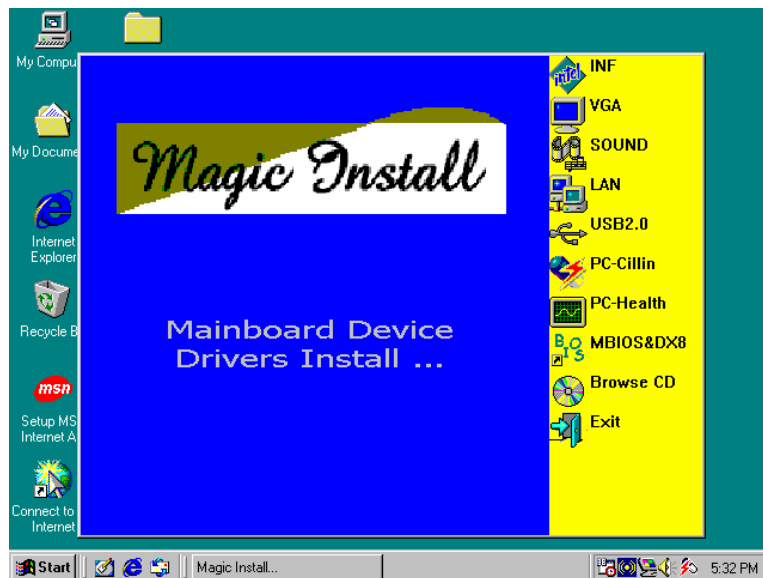

**From MAGIC INSTALL MENU you may make 10 selections:**

1. INF                   install Intel 865 chipset system driver
2. VGA                   install Intel 865G VGA driver (**Only for 865GDMC/865GDMCP**)
3. SOUND                install ALC AC97' Codec Audio driver
4. LAN                   install VIA LAN Controller driver (**for 865GDMCP/865PEDMCP**)
5. USB2.0               install USB 2.0 driver
6. PC-CILLIN           install PC-CILLIN2002 anti-virus program
7. PC-HEALTH           install ITE Smart GUARDIAN driver
8. MBIOS&DX8          install BIOS Live Update Utility and Microsoft DirectX 8.1 driver
9. BROWSE CD           to browse the contents of the CD
10. EXIT                 to exit from MAGIC INSTALL menu

## 4-1 INF install Intel 865 chipset system driver

After you have completed the installation of your operation system (WINDOWS 98SE). You will find an UNKNOWN DEVICE in the device manager (START/SETTING/CONTROL PANEL/SYSTEM/DEVICE MANAGER). You have to install INF driver as shown below:

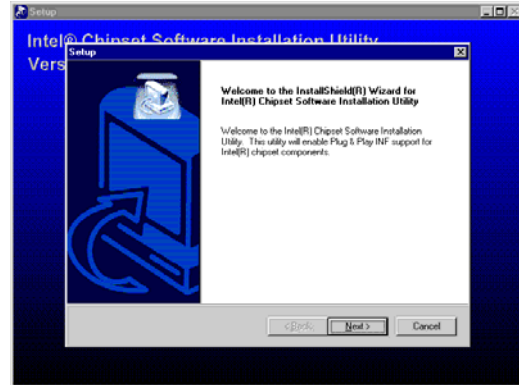

1. Click INF in the MAGIC INSTALL MENU
2. Click NEXT when Chipset Software Install Utility appears

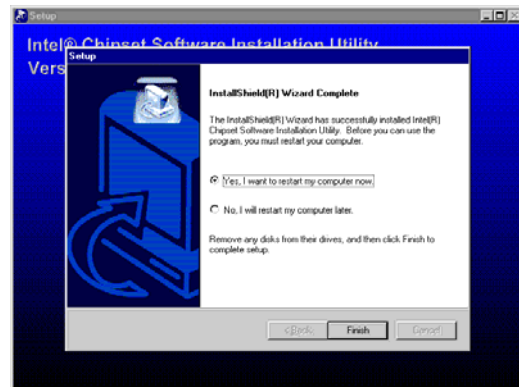
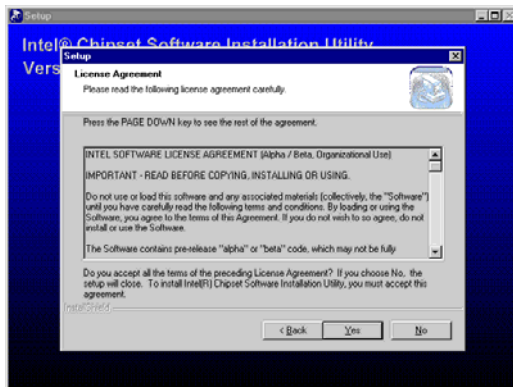

3. This license agreement appear , click Yes , the readme information appear , click Next
4. Select if you want computer re-started click Finish

**NOTE: MAGIC INSTALL will auto detect file path X:\INTEL845\INF\SETUP.EXE**  
**This driver supports WINDOWS 98SE/ME/2000/XP**  
**(NT4.0 do not require)**

## 4-2 VGA install Intel 865G VGA Driver (865GDMC/865GDMCP)

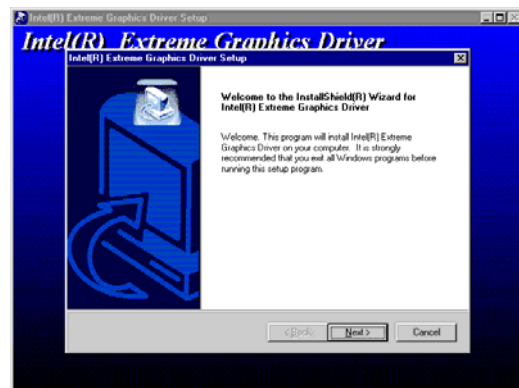

1. Click VGA when MAGIC INSTALL
2. Click NEXT When Intel (R) Extreme

MENU appears

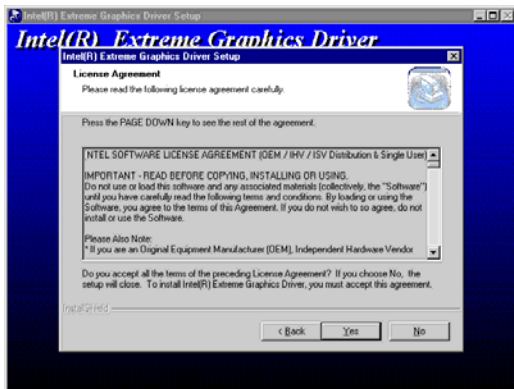

Graphics Driver Software Setup appear

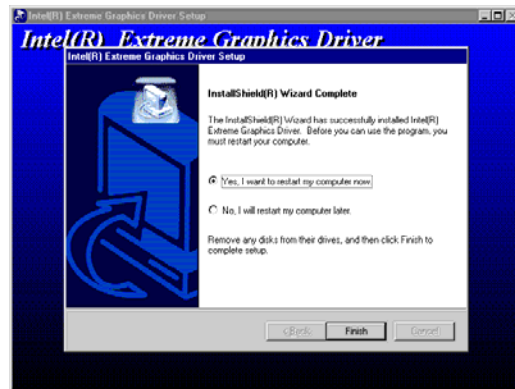

3. Click YES, This is Announce CopyRight

4. If You Want Re-start Computer , Click FINISH

### 4-3 SOUND install ALC AC97 Codec Audio Driver

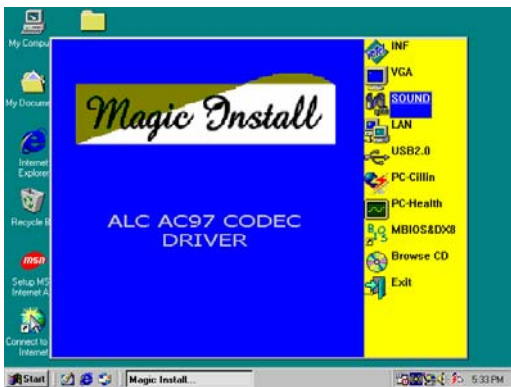

1. Click SOUND when MAGIC INSTALL MENU appears

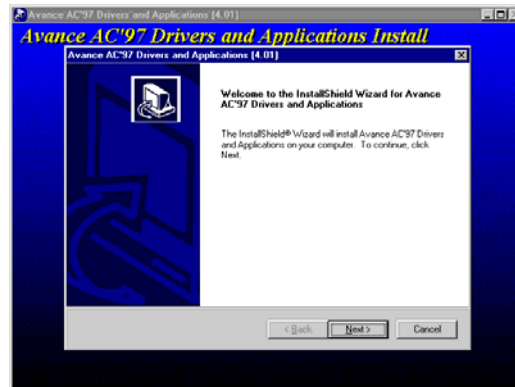

2. Then auto detect operation system language edition, click OK, start to install DRIVER

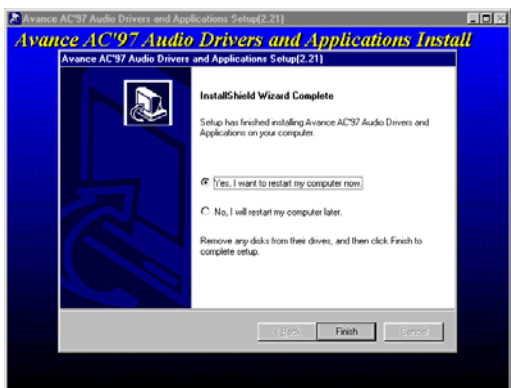

3. Click Finish and Restart Windows

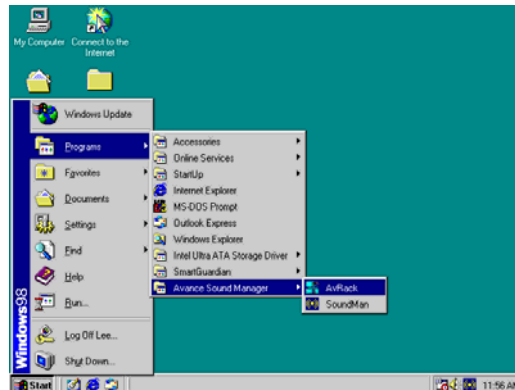

4. Click Start→Program→Avance Sound Manager→AvRack. Then AVRACK Windows appears

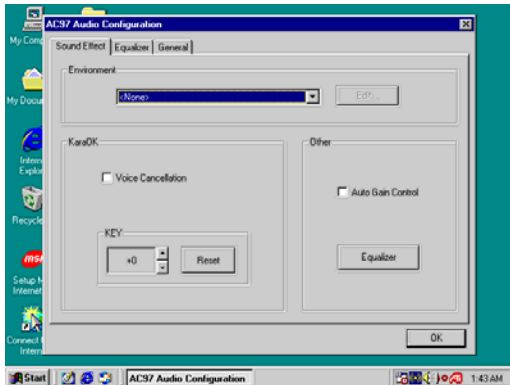

5. Sound Effect select and KaraOK Mode Function

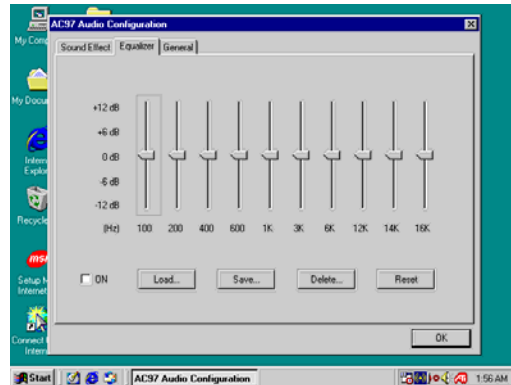

6. Manual Sound Effect Setting

**Note:** The path of the file

For WIN98/NT4.0/WIN2K/XP is X:\CODEC\ALC\SETUP.EXE

**Note:** In Win2K/WinME users have to click Control Panel\System\Device Manager\DVD\CD-ROM drives to Enabled digital CD Audio for the CD-ROM Device when use the SPDIF-Out digital signal.

## 4-4 LAN install VIA 6105 LAN Controller Driver

### WINDOWS 98SE/98ME/2000/XP Setup



1. Click LAN when Magic Install Menu appear

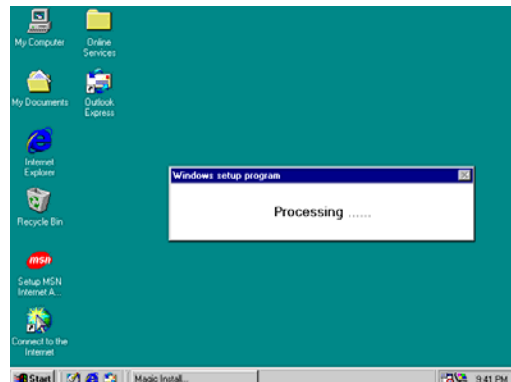

2. Install VIA VT6105 PCI 10/100M Fast Ethernet Driver

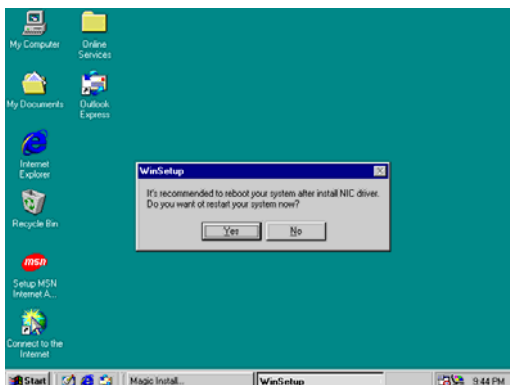

3. Select YES and Restart your computer X:\RTLLAN\WIN98 (If OS is win9X)



---

---

## 4-5 USB2.0 install Intel USB2.0 Driver

### Windows 98SE/ME USB 2.0 Driver installation



1. Click USB2.0 when Magic Install Menu appear

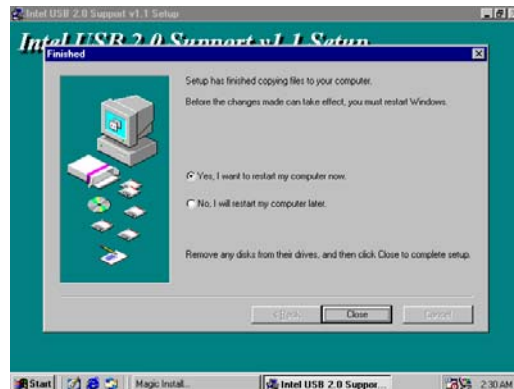

2. This license agreement appear, click Yes, then finish install driver , click Close and restart your computer

## Windows 2000/XP USB 2.0 Driver installation

### Windows 2000

**Mothed1** Start Windows 2000 OS and Internet Connect, Select "Windows Update", Select Driver Update, Install Windows2000 USB2.0 Driver

**Mothed2** Install Windows 2000 Service Pack 4 or later

### Windows XP

Install Windows XP Service Pack 1 or later

## 4-6 PC-HEALTH install SMART GUARDIAN Software for Hardware Monitoring Device



1. Click PC-HEALTH when MAGIC INSTALL MENU appears



2. Click OK when SMART GUARDIAN INSTALL appears



3. This to assign the path of the file, click NEXT 4. Click FINISH after the software is installed

**NOTE: MAGIC INSTALL will auto detect file path X:\INTEL865\HEALTH\SETUP.EXE**

**This driver supports WINDOWS 95/98/98SE/NT4.0/2000**

### 4-6-1 HOW TO UTILIZE PC-HEALTH

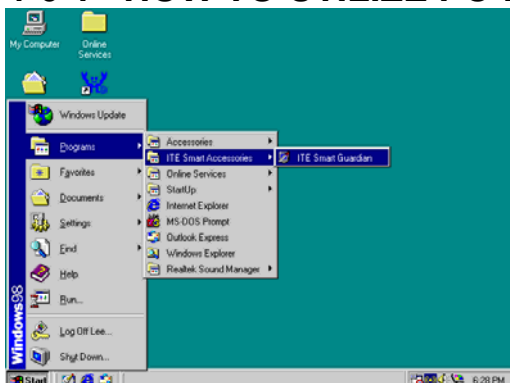

1. Click START/PROGRAMS/ITE SMART ACCESSORIES / ITE SMART GUARDIAN

2. You will see a real time report about FAN SPEED, VOLTAGE and TEMPERATURE System will make a warning if any value is beyond Initial setting value

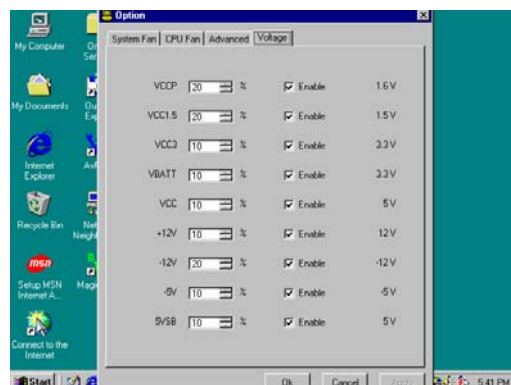
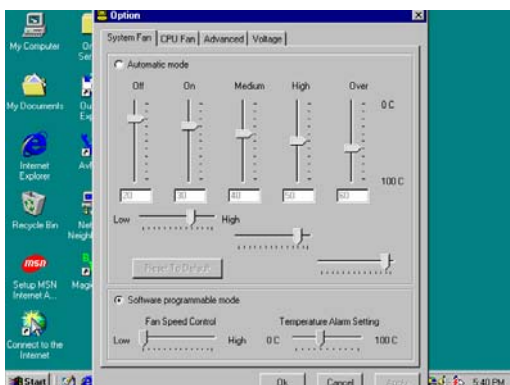

3. You may re-set temperature and voltage by click OPTION

## 4-7 MBIOS&DX8 Install BIOS Live Update Utility and DIRECTX8.1

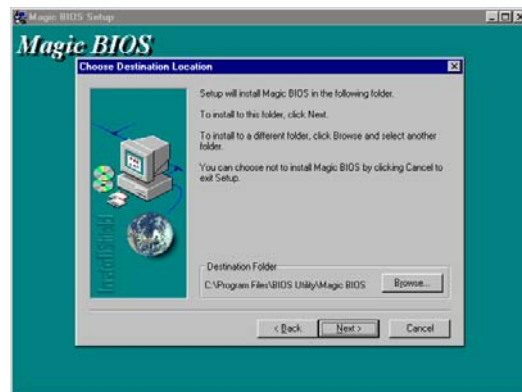

1. Click Magic BIOS when Magic Install MENU appears
2. Click Next to install the Magic BIOS in Destination Folder

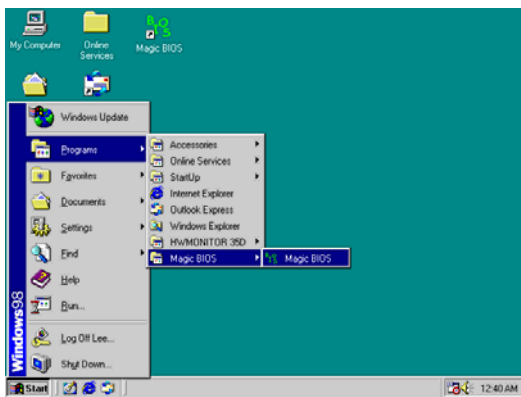

3. After finish Setup you will have a Magic BIOS icon in your screen
4. Double click the Magic BIOS icon you will have this picture, choose from internet you can upgrade BIOS On-line

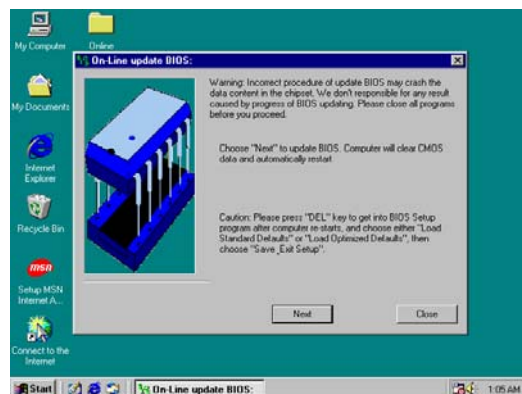
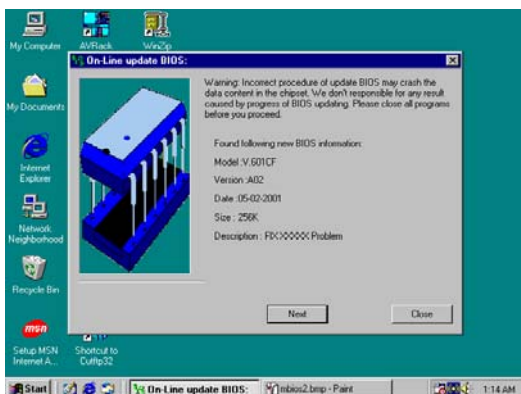

5. When On-line update BIOS the program will auto-check your BIOS version
6. Click Next if you need update BIOS, after upgrade BIOS, the system will clear CMOS and automatically restart

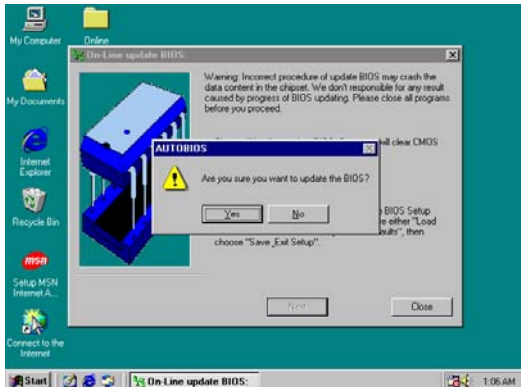

7. Click Yes if you want to update the BIOS otherwise choose No to exit

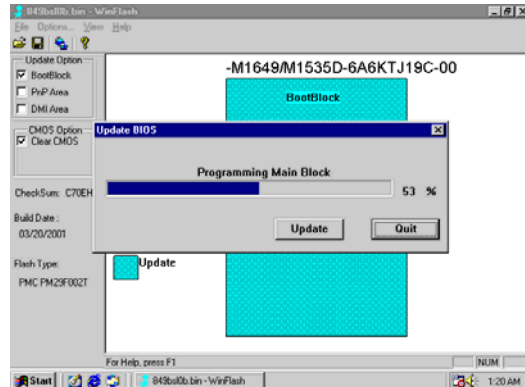

8. When System programming BIOS don't turn off power, after finish update BIOS, the system will clear CMOS and automatically Restart

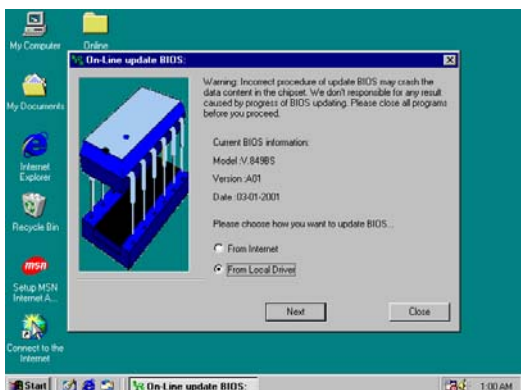

9. When choose From Local Driver to update BIOS, you must have the correct BIOS file in your Local Driver



10. Choose the correct BIOS file to update BIOS

## 4-8 PC-CILLIN Install PC-CILLIN 2002 Anti-virus program



1. Click PC-CILLIN when MAGIC INSTALL MENU appear

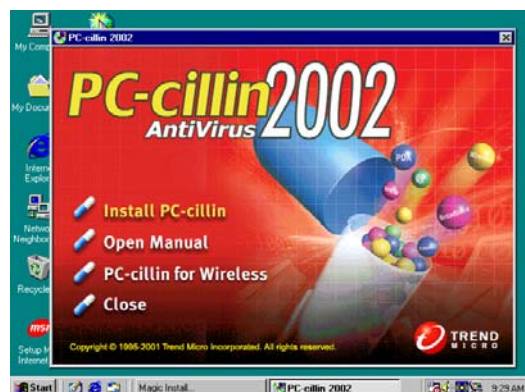

2. (1) Click "Install PC-CILLIN" when PC-CILLIN 2002 main menu appears, and Click NEXT when "Install Shield Wizard For PC-CILLIN 2002"  
 (2) Click Open Manual. you can learn PC-CILLIN 2002 how to use

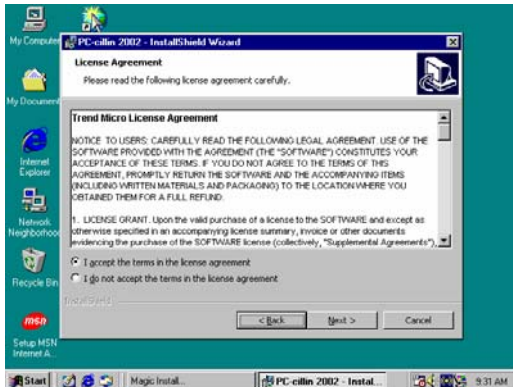

3. This is license agreement, select "I Accept the terms" and Click NEXT

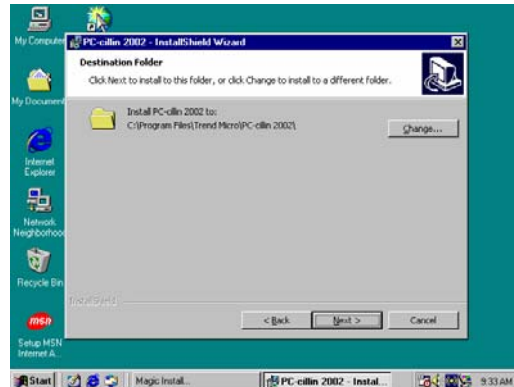

4. Click NEXT and Enter your Customer Information, Click NEXT or choose Change to change the path for the file to be stored

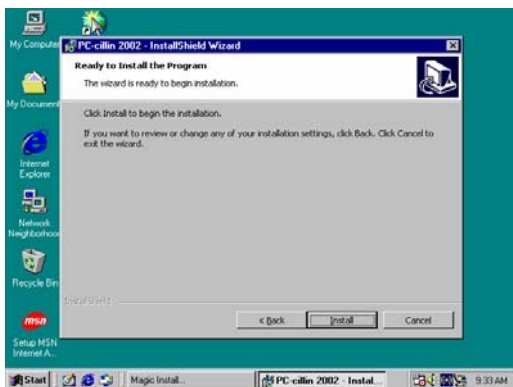

5. Click INSTALL, Start to install the software

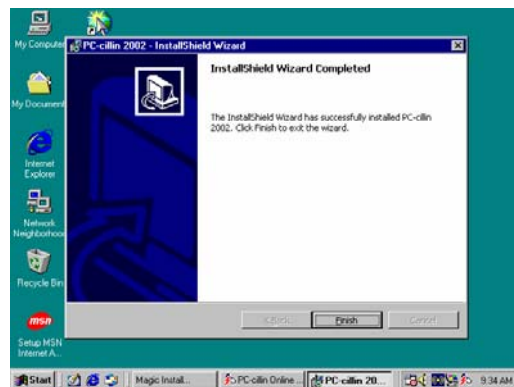

6. Setup Complete and click FINISH



7. After PC-CILLIN 2002 complete, Please register your information and get LICENSE KEY from TREND MICRO web site, enter your license key and click FINISH

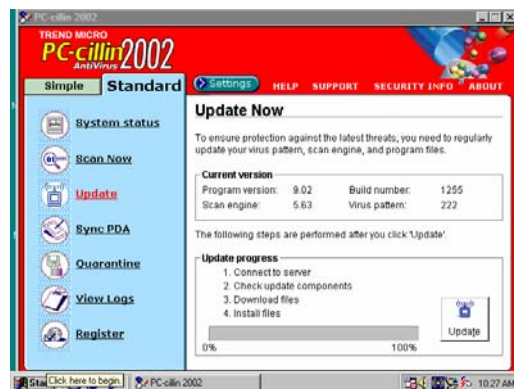

8. finish register process, we recommend select update item to download newest engine code and virus code

**Note :** Please install ACROBAT READER, Before you read PC-CILLIN 2002 User Manual, the path at X:\acrobat\ar500eng.exe

---

---

## 4-9 HOW TO UPDATE BIOS

Before update BIOS users have to “Disable”, “Flash Part Write Protect” item which in “Miscellaneous Control” of BIOS SETUP. Otherwise the system the will not allow you to upgrade BIOS by Award Flash Utility.

**Method 1.** Use “Magic BIOS” update BIOS in Windows 98 (refer [page 40](#))

**Method 2.** In DOS Mode

**STEP 1.** Prepare a boot disc. (you may make one by click START click RUN type SYS A: click OK)

**STEP 2.** Copy utility program to your boot disc. You may copy from DRIVER CD X:\FLASH\AWDFLASH.EXE or download from our web site.

**STEP 3.** Copy latest BIOS for 865GDMC/865PEDMC/865PEDMC/865PEDMCP from our web site to your boot disc.

**STEP 4.** Insert your boot disc into A:,  
start the computer, type “Awdflash A:\865GDMCAxxx.BIN /SN/PY/CC/R”  
865GDMCAxxx.BIN is the file name of latest BIOS it can be 865GDMCA03.BIN or 865GDMCB02.BIN  
SN means don’t save existing BIOS data  
PY means renew existing BIOS data  
CC means clear existing CMOS data  
R means restart computer

**STEP 5.** Push ENTER and the BIOS will be updated, computer will be restarted automatically.